PeopleSoft HCM 9.2: PeopleSoft Absence Management

September 2024

This software and related documentation are provided under a license agreement containing restrictions on use and disclosure and are protected by intellectual property laws. Except as expressly permitted in your license agreement or allowed by law, you may not use, copy, reproduce, translate, broadcast, modify, license, transmit, distribute, exhibit, perform, publish, or display any part, in any form, or by any means. Reverse engineering, disassembly, or decompilation of this software, unless required by law for interoperability, is prohibited.

The information contained herein is subject to change without notice and is not warranted to be error-free. If you find any errors, please report them to us in writing.

If this is software, software documentation, data (as defined in the Federal Acquisition Regulation), or related documentation that is delivered to the U.S. Government or anyone licensing it on behalf of the U.S. Government, then the following notice is applicable:

U.S. GOVERNMENT END USERS: Oracle programs (including any operating system, integrated software, any programs embedded, installed, or activated on delivered hardware, and modifications of such programs) and Oracle computer documentation or other Oracle data delivered to or accessed by U.S. Government end users are "commercial computer software," "commercial computer software documentation," or "limited rights data" pursuant to the applicable Federal Acquisition Regulation and agency-specific supplemental regulations. As such, the use, reproduction, duplication, release, display, disclosure, modification, preparation of derivative works, and/or adaptation of i) Oracle programs (including any operating system, integrated software, any programs embedded, installed, or activated on delivered hardware, and modifications of such programs), ii) Oracle computer documentation and/or iii) other Oracle data, is subject to the rights and limitations specified in the license contained in the applicable contract. The terms governing the U.S. Government's use of Oracle cloud services are defined by the applicable contract for such services. No other rights are granted to the U.S. Government.

This software or hardware is developed for general use in a variety of information management applications. It is not developed or intended for use in any inherently dangerous applications, including applications that may create a risk of personal injury. If you use this software or hardware in dangerous applications, then you shall be responsible to take all appropriate fail-safe, backup, redundancy, and other measures to ensure its safe use. Oracle Corporation and its affiliates disclaim any liability for any damages caused by use of this software or hardware in dangerous applications.

Oracle®, Java, MySQL, and NetSuite are registered trademarks of Oracle and/or its affiliates. Other names may be trademarks of their respective owners.

Intel and Intel Inside are trademarks or registered trademarks of Intel Corporation. All SPARC trademarks are used under license and are trademarks or registered trademarks of SPARC International, Inc. AMD, Epyc, and the AMD logo are trademarks or registered trademarks of Advanced Micro Devices. UNIX is a registered trademark of The Open Group.

This software or hardware and documentation may provide access to or information about content, products, and services from third parties. Oracle Corporation and its affiliates are not responsible for and expressly disclaim all warranties of any kind with respect to third-party content, products, and services unless otherwise set forth in an applicable agreement between you and Oracle. Oracle Corporation and its affiliates will not be responsible for any loss, costs, or damages incurred due to your access to or use of third-party content, products, or services, except as set forth in an applicable agreement between you and Oracle.

Documentation Accessibility

For information about Oracle's commitment to accessibility, visit the Oracle Accessibility Program website at <https://docs.oracle.com/pls/topic/lookup?ctx=acc&id=docacc>.

Access to Oracle Support

Oracle customers that have purchased support have access to electronic support through My Oracle Support. For information, visit <https://docs.oracle.com/pls/topic/lookup?ctx=acc&id=info> or visit <https://docs.oracle.com/pls/topic/lookup?ctx=acc&id=trs> if you are hearing impaired.

Contents

- Preface: Preface.....xxvii**
 - Understanding the PeopleSoft Online Help and PeopleBooks..... xxvii
 - Hosted PeopleSoft Online Help..... xxvii
 - Locally Installed PeopleSoft Online Help..... xxvii
 - Downloadable PeopleBook PDF Files.....xxvii
 - Common Help Documentation..... xxvii
 - Field and Control Definitions..... xxviii
 - Typographical Conventions..... xxviii
 - ISO Country and Currency Codes..... xxix
 - Region and Industry Identifiers..... xxix
 - Translations and Embedded Help..... xxx
 - Using and Managing the PeopleSoft Online Help..... xxx
 - PeopleSoft HCM Related Links..... xxx
 - Contact Us..... xxx
 - Follow Us..... xxxi
- Chapter 1: Getting Started with Absence Management.....33**
 - Absence Management Overview..... 33
 - Absence Management Business Processes..... 33
 - Absence Management Integrations..... 33
 - Absence Management and Global Payroll..... 34
 - Absence Management Implementation..... 34
- Chapter 2: Understanding Absence Management..... 35**
 - Common Elements, Absence Features, and Integration..... 35
 - Common Elements Used in This Documentation..... 35
 - Absence Management Features..... 36
 - Schedules..... 36
 - Absence Entitlements..... 36
 - Absence Takes..... 37
 - Absence Types and Reasons..... 37
 - Absence Entry, Approval, and Self Service Features..... 37
 - Integration..... 38
- Chapter 3: Introducing the Core Application Architecture..... 41**
 - Understanding the Core Application Architecture..... 41
 - Understanding Elements..... 41
 - What Is an Element?..... 41
 - Combining Elements Into Rules..... 42
 - Why the Core Application Uses Element Name Number (PIN) Processing..... 42
 - Understanding the Processing Framework..... 43
 - The Processing Sequence..... 44
 - The Organizational Structure..... 45
 - The Processing Structure..... 47
 - Calendars..... 48
 - Understanding the Batch Architecture Process Flow..... 48
 - Absence Management Modes..... 49
 - Payee Selection..... 49
 - Calculation (Technical)..... 50

| | |
|---|-----------|
| Arrays Used in Batch Processing (Technical)..... | 52 |
| Batch Processing Output Tables..... | 53 |
| Defining Installation Settings..... | 54 |
| Pages Used to Define Installation Settings..... | 54 |
| Products Page..... | 55 |
| Country Specific Page..... | 55 |
| Installation Settings Page..... | 55 |
| Schedule Settings Page..... | 60 |
| Configuration Settings Page..... | 62 |
| Countries Page..... | 64 |
| Chapter 4: Working with Payee Data..... | 69 |
| Understanding Payee Data..... | 69 |
| Understanding Data Retrieval from HR..... | 69 |
| Database System Elements..... | 70 |
| Arrays..... | 70 |
| Rate Codes..... | 70 |
| Frequency..... | 70 |
| Triggers..... | 71 |
| Assigning an Absence System and Pay Group to a Payee..... | 72 |
| Page Used to Assign an Absence System and Pay Group to a Payee..... | 72 |
| Understanding Absence System Assignment in HR..... | 72 |
| Payroll Page..... | 73 |
| Assigning Pay Groups and Overriding Pay Group Defaults..... | 74 |
| Viewing Payee Data..... | 75 |
| Page Used to View Job Information..... | 75 |
| Understanding Payee Data Pages in Absence Management..... | 75 |
| Review Job Information Page..... | 75 |
| Updating Payee Data..... | 76 |
| Sharing Schedule Data..... | 76 |
| Sharing the Holiday Schedule with HR..... | 76 |
| Sharing Schedule Assignments with Time and Labor..... | 77 |
| Chapter 5: Defining General Element Information..... | 79 |
| Understanding Elements..... | 79 |
| Understanding Categorization of Elements..... | 79 |
| Understanding Data Retrieval Elements..... | 81 |
| System Elements..... | 81 |
| Arrays..... | 81 |
| Writable Arrays..... | 82 |
| Brackets..... | 82 |
| Rate Codes..... | 82 |
| Historical Rules..... | 83 |
| Understanding Calculation Elements..... | 83 |
| Variables..... | 83 |
| Dates..... | 84 |
| Duration..... | 84 |
| Formulas..... | 84 |
| Rounding Rules..... | 85 |
| Counts..... | 85 |
| Proration Rules..... | 85 |
| Absence Entitlements..... | 86 |
| Absence Takes..... | 86 |

| | |
|---|------------|
| Accumulators..... | 86 |
| Generation Control..... | 87 |
| Understanding Organizational Elements..... | 87 |
| Element and Eligibility Groups..... | 87 |
| Sections..... | 88 |
| Process Lists..... | 88 |
| Defining Element Types..... | 88 |
| Page Used to Define Element Types..... | 88 |
| Understanding Element Types and Codes..... | 88 |
| Element Types Page..... | 90 |
| Defining Entry Types..... | 91 |
| Page Used to Define Entry Types..... | 91 |
| Understanding Entry Types..... | 92 |
| Entry Types Page..... | 92 |
| Selecting Entry Types and Displaying Record.Field Combinations..... | 93 |
| Pages Used to Select Entry Types and Display Record.Field Combinations..... | 93 |
| Understanding Prompt Views..... | 94 |
| Entry Type Prompts Page..... | 94 |
| Defining Industries and Categories..... | 97 |
| Pages Used to Define Industries and Categories..... | 97 |
| Understanding Industries and Categories..... | 98 |
| Defining Element Names..... | 98 |
| Pages Used to Define Element Names..... | 98 |
| Understanding Element Names..... | 98 |
| Understanding PIN Codes and Element Name Numbers..... | 99 |
| Understanding the Process of Selecting Definition As Of Dates..... | 99 |
| Earnings Name Page..... | 101 |
| Element Name - Custom Fields Page..... | 109 |
| Comments for Element <Name> Page..... | 109 |
| Forecasting for Element <Name> Page..... | 109 |
| Updating Component Element Information..... | 110 |
| Page Used to Update Component Element Information..... | 110 |
| Components Page..... | 111 |
| Defining Suffixes..... | 112 |
| Page Used to Define Suffixes..... | 112 |
| Understanding Suffixes..... | 112 |
| Absence Entitlements Page..... | 112 |
| Copying Elements..... | 113 |
| Pages Used to Copy Elements..... | 113 |
| Understanding Copying Elements..... | 113 |
| Element Copy Configuration Page..... | 114 |
| Component Interface Collection Items Sequence Override Page..... | 116 |
| Element Copy Page..... | 118 |
| Chapter 6: Defining Data Retrieval Elements..... | 125 |
| Understanding Data Retrieval Elements..... | 125 |
| Working with System Elements..... | 125 |
| Pages Used to Modify and View System Elements..... | 125 |
| Understanding System Elements..... | 126 |
| Understanding Batch Processing of System Elements..... | 126 |
| System Element Name Page..... | 128 |
| Source And Use Page..... | 128 |

| | |
|---|------------|
| Comments for Element <Name> Page..... | 129 |
| Defining Array Elements..... | 130 |
| Pages Used to Define Array Elements..... | 130 |
| Understanding Array Elements..... | 131 |
| Understanding Batch Processing of Arrays..... | 131 |
| Array Name Page..... | 132 |
| Field Map and Keys Page..... | 133 |
| Processing Formulas Page..... | 139 |
| Defining Writable Array Elements..... | 140 |
| Pages Used to Define Writable Array Elements..... | 140 |
| Understanding Writable Array Elements..... | 140 |
| Understanding Storage Considerations for Writable Array Elements..... | 141 |
| Understanding Batch Processing of Writable Array Elements..... | 142 |
| Writable Array Name Page..... | 142 |
| Definition and Fields Page..... | 142 |
| Defining Bracket Elements..... | 144 |
| Pages Used to Define Bracket Elements..... | 144 |
| Understanding Bracket Elements..... | 145 |
| Understanding Interpolation Methods..... | 145 |
| Understanding Batch Processing of Bracket Elements..... | 146 |
| Bracket Name Page..... | 149 |
| Lookup Rules Page..... | 150 |
| Search Keys/Return Columns Page..... | 151 |
| Brackets - Data Page..... | 152 |
| Bracket Data Page..... | 153 |
| Defining Rate Code Elements..... | 154 |
| Pages Used to Create Rate Code Elements..... | 154 |
| Understanding Rate Code Mapping..... | 154 |
| Understanding the Use of Rate Code Elements..... | 156 |
| Understanding Batch Processing of Rate Code Elements..... | 156 |
| Common Elements Used in This Section..... | 159 |
| Rate Code Name Page..... | 159 |
| Definition Page..... | 160 |
| Defining Historical Rule Elements..... | 161 |
| Pages Used to Define Historical Rule Elements..... | 161 |
| Understanding Historical Rule Elements..... | 161 |
| Understanding Batch Processing of Historical Rule Elements..... | 162 |
| Historical Calculation Name Page..... | 163 |
| Processing Period Page..... | 163 |
| Parameters and Mapping Page..... | 165 |
| Chapter 7: Defining Calculation Elements..... | 169 |
| Understanding Calculation Elements..... | 169 |
| Calculation Element Names..... | 169 |
| Element Pointers..... | 169 |
| Defining Duration Elements..... | 170 |
| Pages Used to Define Duration Elements..... | 170 |
| Understanding Duration Elements..... | 170 |
| Understanding Batch Processing of Duration Elements..... | 175 |
| Duration Name Page..... | 176 |
| Definition Page..... | 176 |
| Set Daily HR Status Criteria Page..... | 180 |

Defining Variable Elements..... 182

 Pages Used to Define Variable Elements..... 182

 Understanding Variable Elements..... 182

 Understanding Field Formats..... 183

 Understanding Batch Processing of Variables..... 183

 Variable Name Page..... 183

 Variables - Definition Page..... 184

Defining Date Elements..... 184

 Pages Used to Define Date Elements..... 185

 Date Name Page..... 185

 Dates - Definition Page..... 185

 Extract Page..... 188

Defining Formula Elements..... 188

 Pages Used to Define Formula Elements..... 189

 Understanding Element Pointers in Formulas..... 189

 Formula Name Page..... 191

 Field-by-Field Definition Page..... 191

 Element Attributes Page..... 195

 Text Definition Page..... 196

Defining Message Elements..... 197

Defining Rounding Rule Elements..... 200

 Pages Used to Define Rounding Rule Elements..... 200

 Understanding Rounding Rule Elements..... 200

 Rounding Name Page..... 204

 Definition Page..... 204

Defining Count Elements..... 206

 Pages Used to Define Count Elements..... 206

 Understanding Count Elements..... 206

 Count Name Page..... 207

 Counts - Definition Page..... 207

Defining Proration Rules..... 208

 Pages Used to Define Proration Rules..... 208

 Understanding Proration Rules..... 208

 Proration Name Page..... 209

 Proration Rules - Definition Page..... 209

Defining Generation Control Elements..... 211

 Pages Used to Define Generation Control Elements..... 211

 Understanding Generation Control Elements..... 211

 Understanding Batch Processing of Generation Control Elements..... 215

 Generation Control Name Page..... 215

 Generation Control - Conditions Page..... 215

 HR Status for Element <Name> page..... 216

 HR Action/Reason for Element <Name> Page..... 217

 Generation Control - Frequency for Element <Name> Page..... 218

 Generation Control - Segment Status for Element <Name> Page..... 218

 Generation Control - Formula for Element <Name> Page..... 219

 Generation Control - Run Type for Element <Name> Page..... 220

Defining Generation Control Frequency..... 220

 Page Used to Define Generation Control Frequency..... 221

 Understanding Generation Control Frequency..... 221

 Generation Control Frequencies Page..... 221

| | |
|--|------------|
| Chapter 8: Defining Earning and Deduction Elements..... | 223 |
| Understanding Earning and Deduction Elements..... | 223 |
| Earnings and Deductions..... | 223 |
| Calculation Rules..... | 223 |
| Components..... | 224 |
| Automatically Generated Accumulators..... | 225 |
| Defining Earning Elements..... | 225 |
| Pages Used to Define Earning Elements..... | 225 |
| Understanding Setup Steps for Earning Elements..... | 226 |
| Earnings Name Page..... | 226 |
| Calculation Page..... | 227 |
| Earnings - Generated Elements for Element <Name> Page..... | 229 |
| Defining Deduction Elements..... | 229 |
| Pages Used to Define Deduction Elements..... | 230 |
| Understanding Setup Steps for Deduction Elements..... | 230 |
| Deduction Name Page..... | 230 |
| Calculation Page..... | 230 |
| Generated Elements for Element <Name> Page..... | 231 |
| Chapter 9: Setting Up Accumulators..... | 233 |
| Understanding Accumulators..... | 233 |
| Accumulator Elements..... | 233 |
| Balance Accumulators in Batch Processing..... | 233 |
| Retroactive Processing and Accumulators..... | 234 |
| Defining Accumulators..... | 234 |
| Pages Used to Define Accumulators..... | 234 |
| Accumulator Name Page..... | 235 |
| Accumulators - Definition Page..... | 235 |
| Accumulators - Level Page..... | 241 |
| Accumulators - Members Page..... | 242 |
| Adjusting Accumulator Balances..... | 244 |
| Page Used to Adjust Accumulators..... | 244 |
| Understanding Accumulator Adjustments..... | 244 |
| Adjust Balances - Accumulators Page..... | 245 |
| Accumulators Comments Modal..... | 247 |
| Chapter 10: Defining Processing Elements..... | 249 |
| Understanding Processing Elements..... | 249 |
| Common Elements Used for Element Processing..... | 249 |
| Understanding Sections..... | 250 |
| Section Types..... | 250 |
| Standard Sections..... | 250 |
| Payee Sections..... | 251 |
| Absence Take Sections..... | 251 |
| Understanding Process Lists..... | 252 |
| Functions of Process Lists..... | 252 |
| Batch Processing and the Process List Manager..... | 252 |
| Ordering Elements and Sections in a Process List..... | 253 |
| Retroactive Processing Considerations for Process Lists..... | 254 |
| Setting Up Sections..... | 254 |
| Pages Used to Set Up Sections..... | 254 |
| Understanding Section Set Up..... | 255 |
| Section Name Page..... | 255 |

| | |
|--|------------|
| Sections - Definition Page..... | 256 |
| Payee Sections Page..... | 257 |
| Setting Up Process Lists..... | 258 |
| Pages Used to Set Up Process Lists..... | 258 |
| Understanding Process List Setup..... | 258 |
| Process List Name Page..... | 259 |
| Process Lists - Definition Page..... | 260 |
| Chapter 11: Defining Absence Elements..... | 263 |
| Understanding Absence Element Setup..... | 263 |
| Prerequisites..... | 263 |
| Setup Guidelines and Dependencies..... | 263 |
| Absence Formulas..... | 264 |
| Defining Absence Types and Reasons..... | 266 |
| Page Used to Define Absence Types..... | 266 |
| Understanding Absence Types and Reasons..... | 266 |
| Absence Take Types Page..... | 266 |
| Defining Absence Entitlement Elements..... | 268 |
| Pages Used to Define Entitlement Elements..... | 268 |
| Understanding Auto Generated Accumulators..... | 268 |
| Absence Entitlement Name Page..... | 269 |
| Absence Entitlements - Calculation Page..... | 270 |
| Absence Entitlements - Rounding/Proration Page..... | 274 |
| Absence Entitlements - Auto Generated Accumulators Page..... | 275 |
| Absence Entitlements - Accumulator Periods for Element <Name> Page..... | 277 |
| Absence Entitlements - Generated Elements for Element <Name> Page..... | 280 |
| Absence Entitlements - Supporting Element Overrides Page..... | 281 |
| Defining Absence Take Elements..... | 281 |
| Pages Used to Define Absence Take Elements..... | 282 |
| Understanding Absence Take Elements..... | 283 |
| Absence Take Name Page..... | 286 |
| Absence Takes - Calculation Page..... | 287 |
| Absence Takes - Day Formula Page..... | 290 |
| Absence Takes - Period Page..... | 297 |
| Absence Takes - Negative Balances Page..... | 301 |
| Absence Takes - Priority Page..... | 304 |
| Absence Takes - Forecasting Page..... | 305 |
| Absence Takes - Balance Inquiry Page..... | 306 |
| Absence Takes - User Defined Result Fields Page..... | 307 |
| Absence Takes - Supporting Element Override Page..... | 308 |
| Preparing Absence Elements for Use..... | 308 |
| Setting Up Absence Entitlement Balance Forecasting and Inquiry..... | 309 |
| Pages Used to Create a Transaction Definition and Filter Self Service Absence..... | 309 |
| Understanding How to Enable Absence Entitlement Balance Forecasting and Inquiry..... | 309 |
| Transaction Definition Page..... | 311 |
| Forecasting Filter Page..... | 312 |
| Chapter 12: Using Schedules..... | 315 |
| Understanding Work Schedules..... | 315 |
| Creating and Viewing Schedules..... | 319 |
| Pages Used to Define and View Schedules..... | 319 |
| Understanding Schedule Creation..... | 320 |
| Schedule Group Page..... | 321 |

| | |
|--|------------|
| Shift Page..... | 321 |
| Workday Page..... | 327 |
| Schedules - Definition Page..... | 328 |
| Schedule Shifts Page..... | 331 |
| Schedule Calendar Page..... | 334 |
| Validating Work Schedules..... | 335 |
| Page Used to Validate Schedules..... | 335 |
| Schedules to be Validated Page..... | 335 |
| Defining Holiday Schedules..... | 335 |
| Page Used to Define Holiday Schedules..... | 336 |
| Assigning Work Schedules..... | 336 |
| Pages Used to Assign Work Schedules..... | 336 |
| Understanding Work Schedule Assignment..... | 336 |
| Assign Work Schedule Page..... | 337 |
| Personal Schedule Definition - Definition Page..... | 339 |
| Schedule Calendar Page..... | 339 |
| Using Self-Service Scheduling Features for Managers..... | 340 |
| Pages Used to Manage Schedules..... | 340 |
| Weekly Schedules Page..... | 341 |
| Schedule Detail for <Date> Page..... | 344 |
| Manage Schedule Options Page..... | 345 |
| Find Replacements Page..... | 347 |
| Copy Schedules Page..... | 347 |
| Swap Schedules Page..... | 347 |
| Assign Work Schedule Page..... | 348 |
| Using Self-Service Scheduling Features for Employees..... | 348 |
| Pages Used to Enter Scheduling Preferences and View Schedules..... | 348 |
| Schedule Preferences Page..... | 349 |
| Chapter 13: Defining the Organizational Structure..... | 351 |
| Understanding the Organizational Structure..... | 351 |
| Defining Element Groups..... | 352 |
| Pages Used to Define Element Groups..... | 352 |
| Understanding Element Groups..... | 352 |
| Element Group Name Page..... | 352 |
| Element Group Members Page..... | 352 |
| Defining Eligibility Groups..... | 356 |
| Page Used to Define Eligibility Groups..... | 356 |
| Understanding Eligibility Groups..... | 356 |
| Eligibility Groups Page..... | 356 |
| Defining Pay Entities..... | 357 |
| Pages Used to Define Pay Entities..... | 357 |
| Understanding Pay Entities..... | 357 |
| Pay Entity Address Page..... | 358 |
| Processing Details Page..... | 359 |
| Defining Pay Groups..... | 361 |
| Pages Used to Define Pay Groups..... | 362 |
| Understanding Pay Groups..... | 362 |
| Understanding Overrides of Pay Group Defaults..... | 362 |
| Pay Group Name Page..... | 362 |
| Defaults Page..... | 365 |
| Chapter 14: Using Calendars..... | 369 |

| | |
|---|------------|
| Understanding Calendars..... | 369 |
| Common Elements Used for Calendars..... | 369 |
| Calendar Process Flow..... | 370 |
| Creating Calendars..... | 371 |
| Defining Run Types..... | 372 |
| Page Used to Define Run Types..... | 372 |
| Run Types Page..... | 372 |
| Creating Periods..... | 374 |
| Pages Used to Create Periods..... | 375 |
| Periods Page..... | 375 |
| Periods - Automated Creation Page..... | 377 |
| Creating Single Calendars..... | 380 |
| Pages Used to Create Single Calendars..... | 380 |
| Prerequisites..... | 380 |
| Calendars - Definition Page..... | 381 |
| Calendars - Generation Control Page..... | 383 |
| Calendars - Supporting Element Overrides Page..... | 384 |
| Calendars - Excluded Elements Page..... | 385 |
| Creating a Set of Calendars..... | 386 |
| Page Used to Create a Set of Calendars..... | 386 |
| Prerequisites..... | 386 |
| Calendars - Automated Creation Page..... | 387 |
| Defining Calendar Groups..... | 389 |
| Page Used to Create Calendar Groups..... | 389 |
| Understanding Calendar Groups..... | 389 |
| Calendar Groups Page..... | 390 |
| Entering Calendar Override Instructions for a Payee..... | 393 |
| Pages Used for Entering Calendar Override Instructions for a Payee..... | 393 |
| Understanding Calendar Overrides..... | 393 |
| Payee Calendar Groups Page..... | 393 |
| Segment Details Page..... | 395 |
| Chapter 15: Configuring and Managing the Calendar Framework..... | 397 |
| Setup for Absence Calendar..... | 397 |
| Common Elements Used for Calendars..... | 397 |
| Configure Calendar Page..... | 397 |
| Calendar Configuration Page..... | 400 |
| Calendar Preferences page..... | 402 |
| Direct Reports Configuration Page..... | 403 |
| Using Fluid Manager Calendar View..... | 404 |
| Page Used to View Manager Calendar..... | 405 |
| Team Calendar Tile..... | 405 |
| Team Calendar Views..... | 406 |
| Using Fluid Administrator Calendar View..... | 424 |
| Pages Used to View Administrator Calendar..... | 424 |
| Administrator Calendar Tile..... | 424 |
| Select Team page..... | 425 |
| Team Calendar Views..... | 425 |
| Using Fluid Matrix Calendar View..... | 430 |
| Pages Used to View Manager Calendar..... | 430 |
| Matrix Calendar Tile..... | 430 |
| Team Calendar Views..... | 431 |

| | |
|---|------------|
| Using Fluid Employee Calendar View..... | 435 |
| Page Used to for Employee Calendar View..... | 435 |
| Employee Calendar Tile..... | 436 |
| Employee Calendar Views..... | 436 |
| Chapter 16: Entering and Approving Absences..... | 449 |
| Understanding Absence Entry..... | 449 |
| Entering Maintaining and Approving Absence Events..... | 450 |
| Pages Used to Enter, Maintain, and Approve Absence Events..... | 450 |
| Create and Maintain Absence Requests Page..... | 450 |
| Maintain Attachments Page..... | 462 |
| Absence Details Page..... | 464 |
| Approve Absence Requests Page..... | 470 |
| Absence Event Entry Page..... | 472 |
| Absence Event Input Detail Page..... | 477 |
| Forecasting Absence Entitlement Balance During Absence Entry..... | 483 |
| Pages Used to Forecast Absence Entitlement Balances..... | 483 |
| Understanding Absence Entitlement Balance Forecasting..... | 484 |
| Absence Forecast Results Page..... | 485 |
| Forecast Messages Page..... | 487 |
| Viewing Current Absence Entitlement Balances and Running the Absence Entitlement Balance Inquiry Process..... | 488 |
| Pages Used to Start the Balance Inquiry Process and View Balances..... | 488 |
| Current Balance Page..... | 488 |
| Forecast Balance Page..... | 489 |
| Adjusting and Overriding Entitlement Balances..... | 490 |
| Pages Used to Adjust Entitlements..... | 490 |
| Adjust Balances - Absences Page..... | 491 |
| Adjust Balance Comments Modal..... | 492 |
| Assign Entitlements and Takes Page..... | 493 |
| Assign Entitlements and Takes Comments Modal..... | 495 |
| Reviewing Daily Absence Records..... | 496 |
| Chapter 17: Managing Extended Absences..... | 499 |
| Understanding Extended Absences..... | 499 |
| Understanding Attachments in Extended Absences..... | 499 |
| Understanding Configurable Sections in Extended Absences..... | 506 |
| Setting Up Configurable Sections for Extended Absences..... | 513 |
| Pages Used to Set Up Configurable Sections..... | 513 |
| Setup Record Definition Page..... | 514 |
| Setting Up Section Definition Page..... | 516 |
| Template Section Field Configuration Page..... | 518 |
| Configurable Section Setup - Template Page..... | 519 |
| Configurable Section Setup - Sections Page..... | 519 |
| Template Section Configuration Page..... | 520 |
| Section Field Default Value Page..... | 523 |
| Setting Up Extended Absences..... | 524 |
| Setup Tasks for Extended Absences..... | 524 |
| Requesting Extended Absences..... | 524 |
| Pages Used to Request Extended Absences..... | 524 |
| Request Extended Absence Page..... | 525 |
| Request Extended Absence (Configurable Sections) Page..... | 527 |
| Managing Extended Absences..... | 529 |

| | |
|---|------------|
| Pages Used to Manage Extended Absences..... | 529 |
| Extended Absence Request History Page..... | 529 |
| Administer Extended Absence Page..... | 530 |
| Chapter 18: Setting Up Self Service Absence Transactions..... | 533 |
| Understanding Self Service Setup Tasks..... | 533 |
| Prerequisite for Self-Service Setup Tasks..... | 533 |
| Common Elements Used for Self-Service Setup Tasks..... | 533 |
| Setup Tasks for Self Service Absence Transactions..... | 533 |
| Defining Self Service Absence Rules by Country..... | 534 |
| Pages Used to Define Self Service Absence Rules by Country..... | 534 |
| Entitlement Grid Page..... | 535 |
| History Grid Page..... | 536 |
| Forecasting Grid Page..... | 537 |
| Balances Page..... | 538 |
| Event Entry Page..... | 540 |
| Defining Self Service Absence Rules by Take Element..... | 542 |
| Pages Used to Define Self Service Absence Rules by Take Element..... | 542 |
| Understanding PeopleSoft Delivered Approval Process IDs and Approval Framework Events..... | 543 |
| Understanding Absence Duration and End Date Calculations..... | 544 |
| Understanding Forecasting Messages..... | 548 |
| Configure Country Take Setup - Absences Page..... | 548 |
| Configure Country Take Setup - Date Rules Page..... | 555 |
| Configure Country Take Setup - User Fields Page..... | 557 |
| Configure Country Take Setup - Forecasting Messages Page..... | 559 |
| Customize Messages Page..... | 561 |
| Configure Country Take Setup - Configurations Page..... | 562 |
| Defining Forecasting Rules for Self Service Absence Requests..... | 563 |
| Pages Used to Define Self Service Forecasting Rules..... | 563 |
| Forecasting Page..... | 564 |
| Balance Inquiry Page..... | 565 |
| Reviewing System Generated Forecasting Error Status Messages..... | 565 |
| Viewing or Modifying Text on Self Service Absence Pages..... | 570 |
| Delivered Text Catalog Entries for Absence Management..... | 571 |
| Chapter 19: Entering and Approving Self Service Absence Requests..... | 573 |
| Understanding the Absence Request Transactions..... | 573 |
| Managing Employee Self Service Pages..... | 574 |
| Self Service Pages Used by Employees to Manage Absence Requests..... | 574 |
| Request Absence Page..... | 574 |
| Monthly Schedule Page..... | 581 |
| View Absence Balances Page..... | 582 |
| Absence Request History Page..... | 583 |
| Request Details Page..... | 585 |
| Cancel Absence Page..... | 586 |
| Forecast Balance Page..... | 587 |
| Select Job Page..... | 589 |
| Managing Employee Absences Through Time and Labor Self Service..... | 590 |
| Managing Manager Self Service Pages..... | 591 |
| Self Service Pages Used by Managers to Manage Absence Requests..... | 591 |
| Request Absence Page..... | 592 |
| Absence Request History Page..... | 595 |

| | |
|--|------------|
| View Absence Balances Page..... | 596 |
| Absence Requests Page..... | 597 |
| Absence Request History Page..... | 599 |
| Cancel Absence Page..... | 600 |
| Multiple Absence Requests Page..... | 602 |
| Managing Manager Absences Through Time and Labor Self Service..... | 603 |
| Chapter 20: Using Approvals with Absence Management..... | 605 |
| Understanding the Approval Process..... | 605 |
| Approval Framework and Absence Management..... | 605 |
| Configuring Approval Transactions..... | 608 |
| Understanding the Approval Process Design..... | 609 |
| Chapter 21: Working with Delegations in Absence Management..... | 611 |
| Understanding Delegation..... | 611 |
| Delegation Framework..... | 611 |
| Reviewing Delivered Absence Management Delegation Set Up..... | 612 |
| Delivered Delegation Set Up for Absence Management..... | 612 |
| Reviewing Workflow Transactions..... | 612 |
| Reviewing Permission Lists and Roles for Delegation..... | 613 |
| Defining Installation Settings..... | 614 |
| Reviewing Delegation Transactions..... | 615 |
| Adding Delegation Request Through Self Service..... | 615 |
| Steps to Set Up Delegation Through Self Service..... | 615 |
| Example of Delegating Absence Authority..... | 616 |
| Chapter 22: Setting Up Overrides..... | 625 |
| Understanding Overrides..... | 625 |
| Common Elements Used for Overrides..... | 625 |
| Override Levels..... | 626 |
| Overrides Available for Primary Elements..... | 626 |
| Overrides Available for Supporting Elements..... | 627 |
| Begin and End Date Logic for Overrides..... | 628 |
| Payee Overrides and Segmentation..... | 628 |
| Defining Pay Entity Overrides..... | 631 |
| Page Used to Define Pay Entity Overrides..... | 631 |
| Understanding Processing Rules for Pay Entity Overrides..... | 631 |
| Supporting Element Overrides Page..... | 632 |
| Defining Pay Group Overrides..... | 633 |
| Page Used to Define Pay Group Overrides..... | 633 |
| Understanding Pay Group Overrides..... | 633 |
| Defining Payee Overrides..... | 633 |
| Page Used to Define Payee Overrides..... | 633 |
| Understanding Payee Overrides..... | 633 |
| Understanding Processing Rules for Payee Overrides..... | 634 |
| Supporting Elements Page..... | 634 |
| Defining Pay Calendar Overrides..... | 634 |
| Defining Overrides through Elements..... | 635 |
| Resolving Overrides in Batch Processing..... | 635 |
| Chapter 23: Managing Element Eligibility and Resolution..... | 637 |
| Element Eligibility..... | 637 |
| Element Resolution..... | 640 |
| Understanding Element Resolution..... | 640 |
| Definition as of Date..... | 640 |

| | |
|---|------------|
| Begin and End Dates..... | 640 |
| Generation Control..... | 640 |
| Overrides..... | 641 |
| Recalculate Options..... | 641 |
| Chapter 24: Processing Absences..... | 643 |
| Understanding Absence Processing..... | 643 |
| The Absence Entitlement Process..... | 643 |
| The Absence Take Process..... | 643 |
| Absence Processing Features..... | 646 |
| Absences and Segmentation..... | 647 |
| Absences and Retroactive Processing..... | 648 |
| Preparing to Run the Entitlement or Take Process..... | 648 |
| Absence Processing Preparations..... | 649 |
| Absence Processing Sequence..... | 650 |
| Absence Processing Phases and Options..... | 651 |
| Status Codes and Process Indicators..... | 653 |
| Entering Processing Instructions..... | 656 |
| Pages Used to Enter Processing Instructions and Define Run Control Parameters..... | 656 |
| Understanding Processing Instructions..... | 657 |
| Calculate Absence and Payroll Page..... | 658 |
| Restart Information Page..... | 663 |
| Debug and Tuning Options Page..... | 664 |
| Creating Group Lists..... | 673 |
| Page Used to Create a Group List..... | 674 |
| Group Lists Page..... | 674 |
| Creating Process Streams..... | 675 |
| Page Used to Create Streams..... | 675 |
| Understanding Stream Processing..... | 675 |
| Prerequisites..... | 675 |
| Streams Page..... | 676 |
| Chapter 25: Absence Assistant..... | 677 |
| Understanding Absence Assistant..... | 677 |
| Working with Absence Assistant Chatbot using ODA..... | 677 |
| PeopleSoft Employee Digital Assistant..... | 680 |
| Absence Assistant Interface..... | 680 |
| Setting Up Absence Assistant..... | 682 |
| Pages Used to Work with Absences as an Administrator Using the PeopleSoft Fluid User Interface..... | 682 |
| Enabling Absence Assistant..... | 682 |
| Bot Definition Page..... | 684 |
| Communicating with Absence Assistant..... | 687 |
| Pages Used to communicate with Absence Assistant..... | 688 |
| Absence Assistant Tile..... | 688 |
| Chapter 26: Viewing and Finalizing Absence Results..... | 707 |
| Common Elements Used to View and Finalize Absence Results..... | 707 |
| Viewing Absence Processing Results..... | 708 |
| Viewing the Log File..... | 708 |
| Viewing Processing Statistics..... | 713 |
| Pages Used to View Processing Statistics..... | 713 |
| By Calendar Group Page..... | 713 |
| By Calendar Page..... | 715 |

| | |
|--|-----|
| Viewing Payee Iterative Lists..... | 716 |
| Page Used to View Payee Iterative Lists..... | 716 |
| Payee Iterative List Page..... | 716 |
| Viewing Payee Messages..... | 718 |
| Pages Used to View Payee Messages..... | 718 |
| Payee Messages Page..... | 718 |
| Viewing Payee Status and Updating a Payee’s Processing Instructions..... | 719 |
| Page Used to View Payee Status and Update a Payee’s Processing Instructions..... | 720 |
| Payee Status Page..... | 720 |
| Viewing Results by Calendar..... | 722 |
| Pages Used to View Results by Calendar..... | 722 |
| Calendar Results Page..... | 723 |
| Results by Calendar - Result Segment Detail Page..... | 723 |
| Results by Calendar - Accumulators Page..... | 725 |
| Results by Calendar - Supporting Elements Page..... | 726 |
| Viewing Positive Input Results..... | 727 |
| Pages Used to View Positive Input Results..... | 727 |
| Positive Input - Absence Page..... | 728 |
| Generated Positive Input Page..... | 729 |
| Generated Positive Input - Supporting Element Overrides Page..... | 729 |
| Viewing Daily Results of the Absence Take Process..... | 730 |
| Pages Used to View Daily Results of the Absence Take Process..... | 730 |
| Absence Data Page..... | 731 |
| Absence Balance Data Page..... | 736 |
| Absence Begin/End Data Page..... | 738 |
| Configurable Fields Page..... | 739 |
| Work Schedule Data Page..... | 740 |
| Alternate Work Schedule Data Page..... | 741 |
| Viewing Results by Calendar Group..... | 742 |
| Pages Used to View Results by Calendar Group..... | 742 |
| Configuring the Processing Monitor..... | 742 |
| Pages Used to Configure the Processing Monitor..... | 742 |
| Understanding the Processing Monitor..... | 743 |
| Prerequisites for Processing Monitor Configuration..... | 744 |
| Monitor Configuration Page..... | 744 |
| Using the Processing Monitor..... | 749 |
| Pages Used to Use the Processing Monitor..... | 749 |
| Understanding the Processing Monitor..... | 749 |
| Update Processing Monitor Data page..... | 750 |
| Global Payroll Process Monitor Tile..... | 751 |
| Processing Monitor - By Calendar Group Page..... | 751 |
| Processing Monitor - By Calendar Page..... | 757 |
| Defining Administrator Absence Results..... | 759 |
| Page Used to Define Administrator Absence Results..... | 759 |
| Prerequisites..... | 759 |
| Define Administrator Results Page..... | 759 |
| Viewing Administrator Absence Results..... | 762 |
| Pages Used to View Administrator Absence Results..... | 762 |
| Understanding Administrator Absence Results..... | 762 |
| Summary Page..... | 763 |
| Administrator Results - Supporting Elements Page..... | 764 |

| | |
|--|------------|
| Administrator Results - Accumulators Page..... | 765 |
| Administrator Results - Absences Page..... | 766 |
| Viewing an Element Resolution Chain..... | 767 |
| Pages Used to View the Element Resolution Chain..... | 768 |
| Element Resolution Chain Page..... | 768 |
| Detail Audit Chain Page..... | 769 |
| Correcting Batch Processing and Data Entry Errors..... | 769 |
| Page Used to Create the Payee Messages Report..... | 769 |
| Understanding Batch Processing Errors..... | 770 |
| Understanding Batch Processing Messages..... | 770 |
| Payroll Messages Page..... | 774 |
| Finalizing an Absence Run..... | 776 |
| Canceling an Absence Run..... | 777 |
| Processing Special Situations..... | 777 |
| Reporting Absence Data..... | 778 |
| Page Used to Report Absence Data..... | 778 |
| Absence Results Register Page..... | 778 |
| Chapter 27: Using the PeopleSoft Fluid User Interface to Work with Absences..... | 781 |
| Using the PeopleSoft Fluid User Interface to Work with Absences as an Employee..... | 781 |
| Pages Used to Work with Absences as an Employee Using the PeopleSoft Fluid User Interface..... | 781 |
| Time Tile..... | 782 |
| Time Home Page..... | 783 |
| Manage Absences Tile..... | 784 |
| Manage Absences Page..... | 784 |
| Cancel Absences Tile..... | 793 |
| Cancel Absences Page..... | 793 |
| View Requests Tile..... | 796 |
| View Requests Page..... | 797 |
| Absence Details Page..... | 798 |
| Absence Balances Tile..... | 800 |
| Balances Page..... | 800 |
| Extended Absence Request Tile..... | 803 |
| Extended Absence Request Page..... | 804 |
| Extended Absence Request Activity Guide..... | 805 |
| Using the PeopleSoft Fluid User Interface to Work with Absences as a Manager..... | 808 |
| Pages Used to Work with Absences as a Manager Using the PeopleSoft Fluid User Interface..... | 809 |
| Team Time Tile..... | 810 |
| Team Time Page..... | 811 |
| Manage Absence (Select Employee) Page..... | 812 |
| Manage Absences Page..... | 813 |
| Cancel Absences (Select Employee) Page..... | 817 |
| Cancel Absences (View Requests) Page..... | 819 |
| Cancel Absences Page..... | 820 |
| View Requests (Select Employee) Page..... | 822 |
| View Requests Page..... | 824 |
| Request Details Page..... | 825 |
| Absence Balances Page..... | 826 |
| Balances Page..... | 827 |
| Using the PeopleSoft Fluid User Interface to Work with Absences as an Administrator..... | 828 |

| | |
|---|------------|
| Pages Used to Work with Absences as an Administrator Using the PeopleSoft Fluid User Interface..... | 828 |
| Absence Administration Tile..... | 832 |
| Absence Administration Dashboard..... | 833 |
| Administrative tasks Tile..... | 833 |
| Absence Exceptions Page..... | 834 |
| Absence Event Insights Tile..... | 836 |
| Absence Event Insights Dashboard..... | 837 |
| Processed Absence Insights Tile..... | 844 |
| Processed Absence Insights Dashboard..... | 845 |
| Approving Absence Transactions Using Fluid Approvals..... | 850 |
| Pages Used to Approve Absence Transactions Using Fluid Approvals..... | 850 |
| Approvals Navigation Collection..... | 851 |
| Pending Approvals - Absence Request Page..... | 851 |
| Additional Information Page..... | 853 |
| Pending Approvals - Cancel Absence Page..... | 854 |
| Pending Approvals — Attachment Page..... | 855 |
| Pending Approvals - Extended Absence..... | 857 |
| Extended Absence Detail Information — FMLA Eligibility..... | 861 |
| Attachments and Notes Page..... | 862 |
| Additional Information Page..... | 863 |
| Approval Chain..... | 863 |
| Pending Approvals — Leave Donations Page..... | 864 |
| Chapter 28: Using Absence Analytics..... | 869 |
| Understanding Absence Analytics..... | 869 |
| Preparing and Loading Absence Analytics Data..... | 869 |
| Pages Used to Prepare and Load Absence Analytics Data..... | 869 |
| Refresh Employee Information Page..... | 870 |
| Load Absence Analytics Data Page..... | 870 |
| Defining the Absence Analytics Dashboard Content and Layout..... | 871 |
| Pages Used to Define the Absence Analytics Dashboard Content and Layout..... | 871 |
| Personalize Content: Absence Analytics Dashboard Page..... | 871 |
| Personalize Layout: Absence Analytics Dashboard Page..... | 872 |
| Using the Absence Analytics Dashboard Pagelets..... | 874 |
| Understanding the Absence Analytics Dashboard..... | 874 |
| Common Elements Used in this Topic..... | 875 |
| Absence Analytics Dashboard Tile..... | 876 |
| Absence Cost Analysis Pagelet..... | 876 |
| Absence Events Analysis Pagelet..... | 877 |
| Absence Liability and Trends Pagelet..... | 879 |
| Periodic Absence Rate Pagelet..... | 880 |
| Absence by Take and Type Pagelet..... | 881 |
| Employee with Negative Balance Pagelet..... | 883 |
| Absence by Paid Unpaid Status Pagelet..... | 884 |
| By Generated Positive Input Pagelet..... | 885 |
| Using the PeopleSoft Fluid User Interface to Work with Absence Analytics as a Manager..... | 887 |
| Pages Used to Work with Absence Analytics as a Manager Using the PeopleSoft Fluid Interface..... | 887 |
| Absence Analytics Tile..... | 887 |
| Absence Analytics Page..... | 888 |
| Chapter 29: Transferring Leave Time..... | 891 |

| | |
|---|------------|
| Understanding Leave Transfers..... | 891 |
| Defining Leave Transfer Entitlements..... | 892 |
| Defining New Leave Transfer Entitlements..... | 892 |
| Modifying Originating Entitlement Accumulators..... | 894 |
| Setting Up Leave Transfers..... | 894 |
| Pages Used to Set Up Leave Transfers..... | 894 |
| Leave Program Definition Page..... | 895 |
| Leave Program Entitlements Page..... | 899 |
| Leave Program Board Members Page..... | 900 |
| Leave Transfer Configuration Page..... | 901 |
| Leave Transfer Recipients Page..... | 903 |
| Using Leave Donation Self Service Requests..... | 904 |
| Pages Used to Donate and Receive Leave Time..... | 904 |
| Request to Donate Leave Page..... | 904 |
| Request to Receive Donated Leave Page..... | 906 |
| Request to Return Unused Leave Page..... | 908 |
| Request to Terminate Participation Page..... | 909 |
| Leave Transfer Requests History Page..... | 911 |
| Using The PeopleSoft Fluid To Manage Leave Donation As An Employee..... | 912 |
| Pages Used to Manage Leave Donation..... | 913 |
| Manage Leave Donation Tile..... | 913 |
| Manage Leave Donation Home Page..... | 914 |
| Donate Leave Page..... | 915 |
| Receive Leave Donation Page..... | 919 |
| Return Unused Leave Page..... | 922 |
| End Leave Donation Page..... | 923 |
| Leave Donation History Page..... | 924 |
| Managing Leave Donation Programs..... | 926 |
| Pages Used to Administer Leave Transfer Programs..... | 926 |
| Manage and Approve Requests Page..... | 927 |
| Adjust Leave Program Balances Page..... | 928 |
| Initiate Requests Page..... | 929 |
| View Transaction History Page..... | 931 |
| Processing Leave Transfer Transactions..... | 932 |
| Page Used to Process Leave Transfer Transactions..... | 932 |
| Chapter 30: Managing Off Cycle Processing..... | 933 |
| Understanding Off-Cycle Processing..... | 933 |
| Common Elements Used for Off-Cycle Processing..... | 933 |
| Differences Between On and Off Cycle Absence Runs..... | 934 |
| Types of Off Cycle Transactions..... | 934 |
| Features of Off Cycle Processing..... | 934 |
| Steps for Entering an Off Cycle Payment..... | 934 |
| Processing and Postprocessing Steps..... | 935 |
| Off Cycle Batch Processing..... | 936 |
| System Elements for Developing Off Cycle Rules..... | 937 |
| Initiating Off Cycle Transactions..... | 937 |
| Pages Used to Initiate Off Cycle Transactions..... | 937 |
| Understanding the Preliminary Entry for Off Cycle Transactions..... | 938 |
| Off Cycle On Demand Page..... | 938 |
| Off Cycle Request Page..... | 940 |
| Correcting or Reversing Absence Results..... | 941 |

| | |
|---|-------------|
| Pages Used to Correct Absence Results..... | 941 |
| Understanding Absence Result Corrections..... | 941 |
| Correction Request Detail Page..... | 942 |
| Processing Advances..... | 943 |
| Pages Used to Process Advances..... | 943 |
| Understanding Advances..... | 943 |
| Advance Request Detail Page..... | 944 |
| Processing and Viewing Results for Off Cycle Transactions..... | 945 |
| Chapter 31: Setting Up Triggers..... | 947 |
| Understanding Triggers..... | 947 |
| Trigger Uses..... | 947 |
| Trigger Table Data..... | 948 |
| Trigger Generation..... | 954 |
| Managing Used or Obsolete Triggers..... | 958 |
| Defining Triggers Manually..... | 962 |
| Setting Up Trigger Definitions..... | 962 |
| Pages Used to Set Up Trigger Definitions..... | 962 |
| Understanding Trigger Definition Setup..... | 962 |
| Trigger Definitions Page..... | 965 |
| Trigger Definitions - Field Values Page..... | 969 |
| Implementing Triggers..... | 971 |
| Managing Automatically Generated Triggers and Defining Triggers Manually..... | 972 |
| Pages Used to Manage Triggers and Enter Triggers Manually..... | 972 |
| Understanding Trigger Management And Manual Trigger Entry..... | 973 |
| Segmentation Page..... | 973 |
| Retro Page..... | 978 |
| Iterative Page..... | 983 |
| Review Iterative Triggers Page..... | 987 |
| Reviewing PeopleSoft Delivered Triggers..... | 992 |
| Chapter 32: Setting Up Mass Triggers..... | 995 |
| Understanding Mass Triggers..... | 995 |
| Declaring and Calling the Generate_Triggers Function..... | 996 |
| Setting Up Mass Triggers..... | 997 |
| Pages Used to Set Up Triggers..... | 997 |
| Mass Trigger Definition Page..... | 997 |
| Mass Trigger SQL Page..... | 998 |
| View SQL Definition Page..... | 999 |
| Managing Mass Trigger Action Events..... | 1000 |
| Pages Used to Process Trigger Events..... | 1000 |
| Mass Trigger Events Page..... | 1000 |
| Affected Employees Page..... | 1001 |
| Retro Triggers Page..... | 1002 |
| Iterative Triggers Page..... | 1003 |
| Chapter 33: Defining Segmentation..... | 1005 |
| Understanding Segmentation Setup..... | 1005 |
| Types of Segmentation..... | 1005 |
| Relationship of Period, Segment, and Slice Dates..... | 1006 |
| Basic Rules of Element Resolution..... | 1007 |
| Effective-Dated Element Definitions..... | 1009 |
| Rules for Slicing Accumulators and Accumulator Members..... | 1010 |
| Rules for Parent and Child Element Resolutions..... | 1010 |

| | |
|---|-------------|
| Segmentation and Payee Overrides..... | 1016 |
| Proration and Segmentation..... | 1019 |
| Retroactive Processing and Segmentation..... | 1020 |
| Segmentation System Elements..... | 1020 |
| Setting Up Segmentation..... | 1021 |
| Pages Used to Set Up Segmentation..... | 1021 |
| Understanding Segmentation..... | 1021 |
| Segmentation Event Definition Page..... | 1022 |
| Trigger Definitions Page..... | 1024 |
| Managing Segmentation..... | 1024 |
| Page Used to Manage Segmentation..... | 1024 |
| Segmentation Page..... | 1024 |
| Chapter 34: Defining Retroactive Processing..... | 1027 |
| Understanding Retroactive Processing..... | 1027 |
| Common Elements Used for Retroactive Processing..... | 1027 |
| Understanding General Rules of Retro Processing..... | 1028 |
| Example: Corrective Retro—No Exceptions..... | 1028 |
| Tracking Recalculated Calendars..... | 1029 |
| Loading Balance Accumulators..... | 1030 |
| Storing Recalculated Results..... | 1030 |
| Setting Backward and Forward Retro Limits..... | 1030 |
| Setting Up Retroactive Processing..... | 1032 |
| Pages Used to Set Up Retroactive Processing..... | 1032 |
| Understanding Retroactive Processing Setup..... | 1032 |
| Countries Page..... | 1033 |
| Retro Process Definitions Page..... | 1034 |
| Retro Event Definitions Page..... | 1034 |
| Retro Limits Page..... | 1036 |
| Assign Retro Limits Page..... | 1041 |
| Additional Pages Affecting Retroactive Processing..... | 1042 |
| Understanding Complex Retro Processing..... | 1043 |
| Segmentation and Retro..... | 1043 |
| Retroactive Deletes..... | 1044 |
| Retroactive Adds..... | 1044 |
| Reviewing Tips for Retroactive Processing..... | 1044 |
| Chapter 35: Integrating Absence Management and the Payroll System..... | 1047 |
| Understanding How Absence Management Integrates with the Payroll System..... | 1047 |
| Mapping Absence Management Pay Groups to the Payroll System..... | 1047 |
| Mapping Absence Management Codes to the Payroll System..... | 1047 |
| Setting Up Job Level Data to Assign Absence Management to Payees..... | 1047 |
| Running Absence Management Processes to Create an Absence Generated Positive Input File..... | 1048 |
| Managing the Generated Positive Input File..... | 1048 |
| Running the Absence Management Conversion Process for Payroll for North America or Payroll Interface..... | 1048 |
| Running Payroll System Processes..... | 1048 |
| Configuring Absence Management Integration with PeopleSoft Payroll Systems..... | 1048 |
| Pages Used to Configure Absence Management Integration with Payroll for North America or Payroll Interface..... | 1049 |
| Absence Pay Group Mapping Page..... | 1049 |
| Absence Earns/Deductn Mapping Page..... | 1050 |

| | |
|---|-------------|
| Identifying Absence Management at the Payee Job Level..... | 1052 |
| Mng Generated Positive Input Page..... | 1052 |
| Integrating with Payroll for North America..... | 1055 |
| Page Used to Integrate Absence Management to Payroll for North America..... | 1056 |
| To Payroll for North America Page..... | 1056 |
| Running Payroll System Processes for Payroll for North America..... | 1059 |
| Running Payroll for North America through Time and Labor..... | 1060 |
| Calculating Absences with Payroll for North America..... | 1060 |
| Integrating with Payroll Interface..... | 1060 |
| Pages Used to Integrate Absence Management with Payroll Interface..... | 1061 |
| To Payroll Interface File Page..... | 1061 |
| Setting Up and Running Payroll Interface Processes..... | 1063 |
| Absence Management Integration and Retroactivity..... | 1064 |
| Chapter 36: Managing Applications and List Sets..... | 1065 |
| Understanding Applications and List Sets..... | 1065 |
| Prerequisite for Applications and List Sets..... | 1067 |
| Common Elements Used to Manage Applications and List Sets..... | 1067 |
| Setting Up Applications..... | 1067 |
| Pages Used to Set Up Application Definitions..... | 1068 |
| Define Application Page..... | 1068 |
| Define Values for Attribute Page..... | 1070 |
| Setting Up List Sets..... | 1071 |
| Pages Used to Define List Sets..... | 1071 |
| Define List Set Page..... | 1072 |
| Element Group Attributes Page..... | 1074 |
| Chapter 37: Using the Utilities..... | 1079 |
| Understanding the Absence Management Utilities..... | 1079 |
| Common Terms Used in This Documentation..... | 1079 |
| Utility Usage Guidelines..... | 1081 |
| The Packaging and Upgrading Processes..... | 1081 |
| Base and Related Languages..... | 1083 |
| The Versioning Functions..... | 1085 |
| The Delete Functions..... | 1085 |
| The Process of Connecting UNIX and NT Directories..... | 1086 |
| Defining Element Relationships..... | 1086 |
| Pages Used to Define Element Relationships..... | 1087 |
| Define/Build Page..... | 1087 |
| Validation Page..... | 1090 |
| Adding Records to an Element Map..... | 1091 |
| Adding Non-Rules to an Element Map..... | 1092 |
| Viewing Element Relationships..... | 1093 |
| Pages Used to View Element Relationships..... | 1093 |
| Uses Page..... | 1093 |
| Used By Page..... | 1095 |
| Creating and Exporting Rule Packages..... | 1096 |
| Pages Used to Create and Export Rule Packages..... | 1096 |
| Understanding How to Create and Export Rule Packages..... | 1097 |
| Package Definition Page..... | 1098 |
| Define Criteria By Element Page..... | 1099 |
| Define Criteria By Attribute Page..... | 1102 |
| Where Clause Page..... | 1106 |

| | |
|--|-------------|
| Define Criteria By Version Page..... | 1108 |
| Package Processing Page..... | 1108 |
| View Package Page..... | 1112 |
| View Version Detail Page..... | 1113 |
| Package Status Page..... | 1114 |
| View Scripts Page..... | 1114 |
| Importing, Comparing, and Upgrading Rule Packages..... | 1115 |
| Pages Used to Import, Compare, and Upgrade Rule Packages..... | 1116 |
| Understanding Rule Package Imports, Comparisons, and Upgrades..... | 1117 |
| Running the Compare Report..... | 1119 |
| Package Definition Page..... | 1122 |
| Package Processing Page..... | 1123 |
| Package Elements Page..... | 1129 |
| Package Compare Audit Page..... | 1133 |
| Package Status Page..... | 1135 |
| View Scripts Page..... | 1135 |
| Renaming Elements..... | 1136 |
| Page Used to Rename Elements..... | 1136 |
| Understanding How to Rename Elements..... | 1136 |
| Element Rename Page..... | 1137 |
| Creating and Exporting Non-Rule Packages..... | 1138 |
| Pages Used to Create and Export Non-Rule Packages..... | 1138 |
| Understanding How to Create and Export Non-Rule Packages..... | 1139 |
| Create Non-Rule Package – Package Definition Page..... | 1140 |
| Package Criteria Page..... | 1140 |
| Create Non-Rule Package – Package Records Page..... | 1142 |
| Create Non-Rule Package – Package Elements Page..... | 1143 |
| Export Non-Rule Package – Package Records Page..... | 1144 |
| View Script Page..... | 1146 |
| Package Status Page..... | 1146 |
| Importing, Comparing, and Upgrading Non-Rule Packages..... | 1147 |
| Pages Used to Import, Compare, and Upgrade Non-Rule Packages..... | 1147 |
| Understanding How to Import, Compare, and Upgrade Non-Rule Packages..... | 1148 |
| Import Non-Rule Elements – Package Definition Page..... | 1149 |
| Import Non-Rule Elements - Package Records Page..... | 1150 |
| Import Non-Rule Elements – Package Elements Page..... | 1151 |
| Import Non-Rule Records - Package Records Page..... | 1153 |
| Upgrade Non-Rule Package – Package Records Page..... | 1154 |
| Import Non-Rule Elements - View Script Page..... | 1155 |
| Package Status Page..... | 1156 |
| Copying Packages..... | 1157 |
| Pages Used to Copy Packages..... | 1157 |
| Copy Rule Package Page..... | 1157 |
| Copy Non-Rule Package Page..... | 1158 |
| Stamping and Packaging Elements by Version..... | 1158 |
| Pages Used to Stamp and Package Elements by Version..... | 1158 |
| Understanding How to Stamp and Package Elements by Version..... | 1159 |
| Version Stamping Page..... | 1159 |
| Define Version Relationships Page..... | 1161 |
| Chapter 38: Defining Security..... | 1163 |
| Understanding Security..... | 1163 |

| | |
|--|-------------|
| Element Usage Security..... | 1163 |
| Owner Security..... | 1163 |
| Override Levels..... | 1163 |
| Common Elements Used to Define Security..... | 1164 |
| Restricting User Access..... | 1164 |
| Page Used to Restrict User Access..... | 1165 |
| Understanding How to Restrict Access to Country-Specific Elements..... | 1165 |
| User Rules Profile Page..... | 1165 |
| Element Security..... | 1167 |
| Payee Security..... | 1174 |
| HR Security..... | 1174 |
| Group Security..... | 1174 |
| Chapter 39: Viewing Delivered Elements and System Data..... | 1177 |
| Understanding the Delivered System Data..... | 1177 |
| Legend..... | 1192 |
| System Elements Related to Work Schedule..... | 1192 |
| System Elements Related to Alternate Work Schedule..... | 1194 |
| System Elements Related to Holidays..... | 1195 |
| System Elements Related to Take Definition..... | 1195 |
| System Elements Related to the Absence Event Entry..... | 1196 |
| System Elements Calculated during the Absence Processing..... | 1201 |
| System Elements Related to the Forecasting Process..... | 1205 |
| Viewing the Delivered Elements..... | 1207 |
| Page Used to Access and Run the GP_ELEMENTS Query..... | 1207 |
| Understanding the GP_ELEMENTS Query..... | 1208 |
| Query Manager Page..... | 1208 |
| GP_ELEMENTS – Global Payroll Elements Page..... | 1209 |
| Chapter 40: Generating Report Data..... | 1211 |
| Understanding Report Data Generation..... | 1211 |
| The Data Reporting Process..... | 1211 |
| Filters..... | 1214 |
| Report Data and Segmentation..... | 1215 |
| Output Table Definitions..... | 1215 |
| User-Defined Parameter Definitions..... | 1216 |
| Batch Processing Setup..... | 1217 |
| Real-Time Processing Setup..... | 1218 |
| Building a Transaction That Uses Report Data..... | 1218 |
| Common Elements Used to Generate Report Data..... | 1219 |
| Defining Report Data..... | 1219 |
| Pages Used to Define Report Data..... | 1219 |
| Define Report Data Page..... | 1219 |
| Report Data Process Details Page..... | 1222 |
| Creating Input Filters..... | 1226 |
| Validating Report Data..... | 1227 |
| Page Used to Validate Report Data..... | 1227 |
| Report Validation..... | 1227 |
| Validate Report Data Page..... | 1228 |
| Using Report Data..... | 1232 |
| Chapter 41: Setting Up and Running Generic Reports..... | 1233 |
| Understanding Generic Reports..... | 1233 |
| Setting Up Generic Reports..... | 1234 |

| | |
|--|-------------|
| Pages Used to Set Up Generic Reports..... | 1234 |
| Generic Report Break Levels Page..... | 1234 |
| Generic Reports - Definition Page..... | 1236 |
| Rows or Columns Page..... | 1237 |
| Running Generic Reports..... | 1240 |
| Page Used to Run a Generic Report..... | 1241 |
| Create Generic Reports Page..... | 1241 |
| Chapter 42: Absence Management Reports..... | 1243 |
| Absence Management Reports: A to Z..... | 1243 |

Preface

Understanding the PeopleSoft Online Help and PeopleBooks

The PeopleSoft Online Help is a website that enables you to view all help content for PeopleSoft applications and PeopleTools. The help provides standard navigation and full-text searching, as well as context-sensitive online help for PeopleSoft users.

Hosted PeopleSoft Online Help

You can access the hosted PeopleSoft Online Help on the [Oracle Help Center](#). The hosted PeopleSoft Online Help is updated on a regular schedule, ensuring that you have access to the most current documentation. This reduces the need to view separate documentation posts for application maintenance on My Oracle Support. The hosted PeopleSoft Online Help is available in English only.

To configure the context-sensitive help for your PeopleSoft applications to use the Oracle Help Center, see [Configuring Context-Sensitive Help Using the Hosted Online Help Website](#).

Locally Installed PeopleSoft Online Help

If you're setting up an on-premises PeopleSoft environment, and your organization has firewall restrictions that prevent you from using the hosted PeopleSoft Online Help, you can install the online help locally. Installable PeopleSoft Online Help is made available with selected PeopleSoft Update Images and with PeopleTools releases for on-premises installations, through the [Oracle Software Delivery Cloud](#).

Your installation documentation includes a chapter with instructions for how to install the online help for your business environment, and the documentation zip file may contain a README.txt file with additional installation instructions. See *PeopleSoft 9.2 Application Installation* for your database platform, "Installing PeopleSoft Online Help."

To configure the context-sensitive help for your PeopleSoft applications to use a locally installed online help website, see [Configuring Context-Sensitive Help Using a Locally Installed Online Help Website](#).

Downloadable PeopleBook PDF Files

You can access downloadable PDF versions of the help content in the traditional PeopleBook format on the [Oracle Help Center](#). The content in the PeopleBook PDFs is the same as the content in the PeopleSoft Online Help, but it has a different structure and it does not include the interactive navigation features that are available in the online help.

Common Help Documentation

Common help documentation contains information that applies to multiple applications. The two main types of common help are:

- Application Fundamentals

- Using PeopleSoft Applications

Most product families provide a set of application fundamentals help topics that discuss essential information about the setup and design of your system. This information applies to many or all applications in the PeopleSoft product family. Whether you are implementing a single application, some combination of applications within the product family, or the entire product family, you should be familiar with the contents of the appropriate application fundamentals help. They provide the starting points for fundamental implementation tasks.

In addition, the *PeopleTools: Applications User's Guide* introduces you to the various elements of the PeopleSoft Pure Internet Architecture. It also explains how to use the navigational hierarchy, components, and pages to perform basic functions as you navigate through the system. While your application or implementation may differ, the topics in this user's guide provide general information about using PeopleSoft applications.

Field and Control Definitions

PeopleSoft documentation includes definitions for most fields and controls that appear on application pages. These definitions describe how to use a field or control, where populated values come from, the effects of selecting certain values, and so on. If a field or control is not defined, then it either requires no additional explanation or is documented in a common elements section earlier in the documentation. For example, the Date field rarely requires additional explanation and may not be defined in the documentation for some pages.

Typographical Conventions

The following table describes the typographical conventions that are used in the online help.

| <i>Typographical Convention</i> | <i>Description</i> |
|--|---|
| Key+Key | Indicates a key combination action. For example, a plus sign (+) between keys means that you must hold down the first key while you press the second key. For Alt+W , hold down the Alt key while you press the W key. |
| ... (ellipses) | Indicate that the preceding item or series can be repeated any number of times in PeopleCode syntax. |
| { } (curly braces) | Indicate a choice between two options in PeopleCode syntax. Options are separated by a pipe (). |
| [] (square brackets) | Indicate optional items in PeopleCode syntax. |
| & (ampersand) | When placed before a parameter in PeopleCode syntax, an ampersand indicates that the parameter is an already instantiated object. Ampersands also precede all PeopleCode variables. |

| Typographical Convention | Description |
|---------------------------------|--|
| ⇒ | This continuation character has been inserted at the end of a line of code that has been wrapped at the page margin. The code should be viewed or entered as a single, continuous line of code without the continuation character. |

ISO Country and Currency Codes

PeopleSoft Online Help topics use International Organization for Standardization (ISO) country and currency codes to identify country-specific information and monetary amounts.

ISO country codes may appear as country identifiers, and ISO currency codes may appear as currency identifiers in your PeopleSoft documentation. Reference to an ISO country code in your documentation does not imply that your application includes every ISO country code. The following example is a country-specific heading: "(FRA) Hiring an Employee."

The PeopleSoft Currency Code table (CURRENCY_CD_TBL) contains sample currency code data. The Currency Code table is based on ISO Standard 4217, "Codes for the representation of currencies," and also relies on ISO country codes in the Country table (COUNTRY_TBL). The navigation to the pages where you maintain currency code and country information depends on which PeopleSoft applications you are using. To access the pages for maintaining the Currency Code and Country tables, consult the online help for your applications for more information.

Region and Industry Identifiers

Information that applies only to a specific region or industry is preceded by a standard identifier in parentheses. This identifier typically appears at the beginning of a section heading, but it may also appear at the beginning of a note or other text.

Example of a region-specific heading: "(Latin America) Setting Up Depreciation"

Region Identifiers

Regions are identified by the region name. The following region identifiers may appear in the PeopleSoft Online Help:

- Asia Pacific
- Europe
- Latin America
- North America

Industry Identifiers

Industries are identified by the industry name or by an abbreviation for that industry. The following industry identifiers may appear in the PeopleSoft Online Help:

- USF (U.S. Federal)

- E&G (Education and Government)

Translations and Embedded Help

PeopleSoft 9.2 software applications include translated embedded help. With the 9.2 release, PeopleSoft aligns with the other Oracle applications by focusing our translation efforts on embedded help. We are not planning to translate our traditional online help and PeopleBooks documentation. Instead we offer very direct translated help at crucial spots within our application through our embedded help widgets. Additionally, we have a one-to-one mapping of application and help translations, meaning that the software and embedded help translation footprint is identical—something we were never able to accomplish in the past.

Using and Managing the PeopleSoft Online Help

Select About This Help in the left navigation panel on any page in the PeopleSoft Online Help to see information on the following topics:

- Using the PeopleSoft Online Help.
- Managing hosted Online Help.
- Managing locally installed PeopleSoft Online Help.

PeopleSoft HCM Related Links

[Oracle Help Center](#)

[PeopleSoft Online Help Home](#)

[PeopleSoft Information Portal](#)

[My Oracle Support](#)

[PeopleSoft Training from Oracle University](#)

[PeopleSoft Video Feature Overviews on YouTube](#)

[PeopleSoft Business Process Maps \(Microsoft Visio format\)](#)

[HCM Abbreviations](#)

[PeopleSoft Spotlight Series](#)

Contact Us

Send your suggestions to pssoft-infodev_us@oracle.com.

Please include the applications update image or PeopleTools release that you're using.

Follow Us

| <i>Icon</i> | <i>Link</i> |
|---|--|
|  | <u>Watch PeopleSoft on YouTube</u> |
|  | <u>Follow @PeopleSoft_Info on X.</u> |
|  | <u>Read PeopleSoft Blogs</u> |
|  | <u>Connect with PeopleSoft on LinkedIn</u> |

Chapter 1

Getting Started with Absence Management

Absence Management Overview

Absence Management handles absence processing and enables you to fine-tune the design of your system.

Absence Management contains no application-specific rules or code. Using items, called *elements*, you build rules that determine what absence components are calculated, on a payee-by-payee basis, during batch processing.

Related Links

[Absence Management Features](#)

Absence Management Business Processes

Absence Management provides these business processes:

- Absence entitlement processing.
 - Absence take processing.
 - Transfer of converted absence data to payroll.
-

Absence Management Integrations

Absence Management integrates with these applications:

- PeopleSoft Human Resources (HR)
- PeopleSoft Payroll for North America (directly or through PeopleSoft Time and Labor).
- PeopleSoft Payroll Interface.

Related Links

[Understanding How Absence Management Integrates with the Payroll System](#)

[Understanding Payee Data](#)

Absence Management and Global Payroll

Absence Management and Global Payroll share many of the same components. In addition, some of the fields and pages in the shared components apply only to the Global Payroll. These situations are noted throughout this documentation.

Important! This documentation is written for the Absence Management application. If you are using Global Payroll, refer to *PeopleSoft Global Payroll*.

Absence Management Implementation

PeopleSoft Setup Manager enables you to generate a list of setup tasks for your organization based on the features that you are implementing. The setup tasks include the components that you must set up, listed in the order in which you must enter data into the component tables, and links to the corresponding documentation.

Other Sources of Information

In the planning phase of your implementation, take advantage of all PeopleSoft sources of information, including the installation guides, table-loading sequences, data models, and business process maps.

Refer to the *PeopleSoft HCM 9.2 - Reorganization of Component Interface Permissions* (Doc ID [2342162.1](#)) MOS posting for a list of system-delivered CIs and their usage, the mapping of CIs and associated permission lists, and the mapping of CI permission lists and user roles.

See the product documentation for *PeopleSoft HCM: Application Fundamentals*, *PeopleTools: Setup Manager*, and *PeopleTools: Component Interfaces*.

Chapter 2

Understanding Absence Management

Common Elements, Absence Features, and Integration

This topic contains a review of terms used in this documentation, presents important absence management concepts and features, and discusses the integration to your payroll system.

Common Elements Used in This Documentation

| <i>Field or Control</i> | <i>Description</i> |
|----------------------------|---|
| Absence Event | The period of time that a payee is absent for the same reason. For example, if a payee is out sick Monday through Wednesday, the three-day absence is referred to as an <i>absence event</i> . |
| Absence Take | The element that represents the reason for the absence event. Note: The self service term for Absence Take is <i>Absence Name</i> . |
| Adjustment | An increase or decrease that is made to the entitlement balance. |
| Entitlement | The amount of paid time-off that a payee is entitled to take for each category of absence or each absence event, depending on your method of accrual. For example, payees in your organization may be entitled to receive 20 vacation days per year. |
| Entitlement Balance | The amount of unused entitlement. |
| Generation Control | A type of data filtering that provides more control over whether an element for a payee is processed during batch processing. This increased control is accomplished through generation control elements, which enable you to tell the system whether to process an element, based on criteria that you define. |
| Payee | Payees are the people in your organization that you want to pay. From an Absence Management perspective, payees are employees whose absence events are managed by the system. |

| <i>Field or Control</i> | <i>Description</i> |
|-------------------------|--|
| Units | The period of time in which entitlement, take, adjustments, balances, and other absence-related time periods are measured. Typically, units represent either hours or days. You choose the unit of measurement to use. |

Absence Management Features

Absence Management enables organizations to automate the processes for planning and compensating paid time off for a multinational workforce. It combines employee and manager capabilities and tracks all absences in a single application. Absence Management contains built in integration to PeopleSoft Payroll for North America, either directly or through PeopleSoft Time and Labor, and to third-party payroll solutions using PeopleSoft Payroll Interface.

This overview of Absence Management features includes the following topics:

- Schedules.
- Entitlements.
- Absence types and reasons.
- Takes.
- Absence entry, approvals, and self service features.
- Integrations.

Schedules

Tracking the time that payees are absent from work is critical to producing an accurate payroll. You need to know when payees are out sick, on vacation, or absent for any other reason and whether to pay them for this time. Schedules define workplace attendance expectations for groups of employees, and include definition of the workdays, scheduling units, and holidays. This information is important to the absence process because it tells the system whether a reported absence occurred during a scheduled work time. Absences during scheduled work periods may be paid if they meet your organization's absence rules.

Absence Entitlements

Absence entitlement elements define how much paid time off your organization gives payees for various kinds of absences. They also specify the entitlement period, the calculation frequency, and any automatic adjustments to make to entitlement balances. For example, you might set up a vacation entitlement element that gives payees 15 days of paid vacation each year. Also, you might specify that payees are compensated for half of any vacation days that are unused by April 1 of the following year. Entitlement can be granted for each absence or at the frequency that you specify.

For each absence entitlement element that you create, you indicate whether entitlement should accrue for each absence (for example, 40 days for each illness) or at the frequency that you specify (for example,

2 sick days per month). Absence-based entitlement is resolved when you run the Take process after an absence occurs; frequency-based entitlement is resolved when you run the Entitlement process. With frequency-based entitlement, you can use generation control to limit the conditions under which entitlement is resolved. For example, you can limit resolution to active payees only. Using automatic adjustments, you can specify what happens to a payee's frequency-based entitlement balance when certain conditions are met; for example, when a payee is terminated or when a certain date is reached. Payees can be compensated for all or part of the unused entitlement, or they can lose all or part of the unused entitlement. You use a generation control element to define the conditions under which the adjustment is made.

Absence Takes

Absence take elements define your rules for allowing paid time off. They define which kinds of absences are valid and the requirements that must be met before entitlement can be used. For example, a vacation take rule may require that payees be employed three months before using vacation entitlement. You can link each take element to one or more entitlement elements so that the system can calculate the number of paid and unpaid units and update the entitlement balances. If you link to more than one entitlement element, you specify the order in which the elements are to be used. When an absence occurs, the system takes from the first entitlement (until it is depleted) before taking from the next entitlement.

Absence Types and Reasons

Absence types define the broad categories of absences you want to track, such as illness, vacation, or maternity leave. Within each absence type, you can create a set of absence reasons that further classify absences. For example, if you create an absence type called illness, you may want to set up reasons such as cold, flu, stress, and so on.

You create absence types to describe the categories of absences that are relevant to your organization such as illness, vacation, personal, or work injury. Within each type, you can define codes that further describe the reason for the absence; for example, flu or back problems. The type and reason that are associated with an absence event populate system elements that you can use in absence formulas.

Absence Entry, Approval, and Self Service Features

Depending on how you set up the approvals framework, self service features may be available to employees and managers to enter, review, and, in the case of managers, approve absence transactions. Additionally, payroll or absence administrators can enter, modify, review and approve absence transactions through Absence Management pages.

- Absence entry.

To record actual absences into the system, users select the take element that identifies the absence and enter the dates of the absence. An absence reason can also be entered to further identify the cause of the absence (if you have defined absence reasons codes). Depending on your take rules, you can require online approval of absence entries before processing. If online forecasting is required for a take element, the system issues a warning when users try to save absence entries without first running the online forecasting process. Payees and managers can enter requests for absences through a web browser and view requests.

Users can enter full or partial day absences so that when a payee is out for the same number of hours during each day of an absence event, the user enters the hours only once or selects the Half Day check box, if appropriate.

Self service users can enter information in as many as 4 configurable fields when they enter absence events. This information updates the daily data when you run the Take process and can be available to your absence formulas. If you use this feature, we recommend that you provide users with guidelines for the types of data that they can enter.

Note: If you define rules for self-service absence transactions, employees, managers, or both can use the self service pages to enter requests for absences. You can also define rules for approving self-service absence requests. Requests entered through the self service pages are treated as actual absences once they are approved.

- Absence entitlement balance forecasting.

You can require the use of online absence entitlement balance forecasting during absence entry, or make its use optional. Managers can approve requests for absences and forecast absence entitlement balances as of a particular date. With forecasting, a user enters actual or planned absence events and launches an online process that processes future periods of time, starting with the last finalized calendar. It can return values for balances and other items that you define. You might use this feature, for example, to determine whether a payee has or will have enough entitlement to cover an absence.

- Balance inquiry.

Use this feature to display a payee's current entitlement balance. The online process displays the current entitlement balance and can be used to project entitlement for a take element as of the date that you specify.

- Delegate absence self service transactions.

Delegation is when a person authorizes another to serve as his or her representative for a particular task of responsibility. Users can authorize other users to perform managerial tasks on their behalf by delegating authority to initiate or approve managerial transactions.

Integration

Absence Management has functionality that enables you to enter and track absence information. However, that information must be available to your payroll system in order to process earnings and deductions related to absences. To accomplish this, Absence Management integrates with the following PeopleSoft applications:

- Payroll for North America, either directly or through Time and Labor.
- Payroll Interface, for customers that use a third-party payroll system.

Integration to Payroll for North America

To enable direct integration between Absence Management and Payroll for North America, Absence Management delivers the ability to export computed absence results (by employee and pay period) for

actual payment. Only a minimum amount of setup is required to map absence payment concepts to an existing Payroll for North America system.

For customers who use both Payroll for North America and Time and Labor, the functionality in Absence Management includes the ability to enter absences or view absence balances in Time and Labor on the Timesheet page. Time and Labor converts this data into payable time and adds sequence and reference numbers for eventual cost distribution. This integration eliminates double entry and custom interfaces.

Integration to Payroll Interface

To enable the integration between Absence Management and third-party payrolls, Absence Management enables you to export computed absence results (by employee and pay period) for actual payment. Only a minimum amount of setup is required to map absence payment concepts to an existing payroll interface process.

Chapter 3

Introducing the Core Application Architecture

Understanding the Core Application Architecture

Absence Management is built on a core application that organizations in all countries can use to create absence management systems. Understanding the core application architecture will enable you to better understand the complex details of Absence Management.

Understanding Elements

When you create your absence management system using Absence Management, you want to be sure that it meets all the requirements of your organization. One of the ways that PeopleSoft ensures this is by building the absence management system through the use of components called *elements*.

This topic discusses:

- What is an element?
- Combining elements into rules.
- Why the core application uses element name number (PIN) processing.

What Is an Element?

An element is the smallest component of Absence Management. Elements are building blocks that relate to other building blocks to define your absence management system.

You define each element only once and use it repeatedly anywhere in the system.

This table lists the element categories:

| <i>Type of Element</i> | <i>Description</i> |
|-------------------------------|---|
| Data retrieval | Retrieves data. Some are predefined elements (called <i>system elements</i>) that are delivered by PeopleSoft. Others you define when creating your absence management system. |
| Calculation | Performs a calculation. |
| Organizational | Defines the structure and framework for the system. |

This table lists alternative element categories:

| Type of Element | Description |
|------------------------|---|
| Primary | Represents primary rules for absence takes and entitlements. |
| Supporting | Usually not used alone, but used to create other, more complex elements. |
| Miscellaneous | Represents such things as eligibility criteria, accumulators, and certain types of rules. |

You can combine these elements in an unlimited number of ways to produce the results that you need for your absence management processing.

Related Links

[Understanding Elements](#)

Combining Elements Into Rules

In Absence Management, you create and store rules by entering data through the online pages.

These rules drive the core application and define the absence management process. Think of a *rule* as what defines how an element is calculated. Rules define the absence management process itself.

Each country using Absence Management defines its own rules. Absence Management enables you to define rules that address your specific absence management processing needs.

This diagram shows how elements and rules define your absence management process.



Important! There is usually no need to modify the Absence Management COBOL programs. Using the online pages, you can configure the system to meet your absence management processing needs. PeopleSoft strongly discourages the modification of the delivered COBOL programs—with the possible exception of modifying array size—because modifications can affect the integrity of the entire system.

Related Links

[Defining Array Elements](#)

Why the Core Application Uses Element Name Number (PIN) Processing

An element name number (PIN) is a numeric identifier for an element. Every element in Absence Management has a unique element name number, including the elements that you create and the elements

the PeopleSoft system delivers. Absence Management programs access and process an element by referring to its element name number, rather than its name.

A PIN is referred to as an *element* in Absence Management. A PIN and an element are identical, and a PIN number is the same as an element number. We explain the term PIN here because it is referenced throughout the programs and table structure of the application. Think of PIN as the technical name that is used in the programming and table structure and *element* as the functional name that is used on all pages and discussions.

This is necessary because Absence Management is designed for use by any organization in any country. Each organization will likely give the elements that form the basis for its absence management system different names, depending on its requirements. And organizations in different countries are going to name their elements using different languages. Also, the system elements delivered by PeopleSoft are often translated into many languages. If the name were the only way to identify an element, there could be problems.

PIN numbers also improve performance within batch processes. It is more efficient for the system to use numeric values than to use character values. This performance improvement is a result of being able to easily read the numeric values into the processing arrays and create a pointer to the correct place in the array.

PINs are numbered sequentially.

Note: The system assigns a PIN number to each element that you create. The first number the system assigns is 100,001. PIN numbers prior to 100,001 are reserved for the elements that are delivered with Absence Management.

This graphic shows how elements are accessed by PIN number rather than by element name.

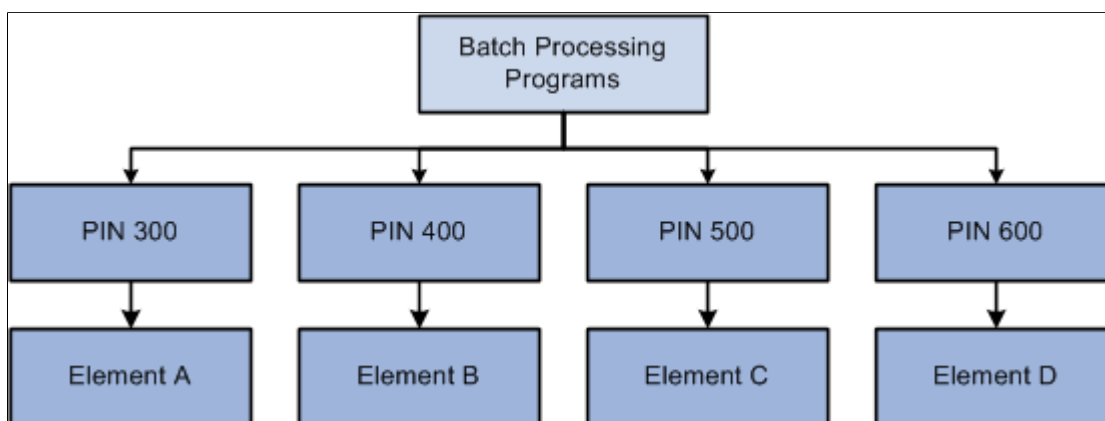

Understanding the Processing Framework

The Absence Management core application is a common foundation and structure that organizations use to build their own calculation rules. The core application determines the basic framework for your absence processing. This framework supplies the normal processing sequence, organizational structure, and processing structure for calculating absences.

This topic discusses:

- The processing sequence.
- The organizational structure.
- The processing structure.
- Calendars.

The Processing Sequence

An absence process consists of several processing phases, some of which you can run together. The typical processing sequence (the order in which Absence Management executes phases of a batch process) for an absence run consists of these phases:

- Identification (payee selection).
- Calculation.
- Finalization.

You can also run Cancel, Freeze, Unfreeze, and Suspend phases as needed and modify processing instructions by payee.

When you first launch the batch process, Absence Management determines which payees are to be selected and calculated for the absence run, based on the selection criteria that you have specified. This identification phase is executed only once for each calendar group ID.

During the calculation phase, absence calculations are performed. Each payee is processed sequentially. As the system encounters each payee, it processes each element that is identified in the process list. Various criteria such as eligibility and generation control are considered in selecting which elements to process.

The calculation process can be repeated any number of times; only the absences that are appropriate to calculate are processed. When a calculation is first executed, all absences are processed. During subsequent calculations, only the following absences are processed:

- Absences resulting from iterative triggers.
- Absences for which you have entered recalculate instructions.
- Absences that encountered errors during the previous run.

An iterative trigger can be produced when data changes for a payee. For example, a change to a payee's job record might create an iterative trigger. Or the addition of a new hire to the calendar group ID can produce iterative triggers.

Finalizing an absence run closes and completes the process.

Related Links

[Understanding Absence Processing](#)

[Trigger Table Data](#)

[Understanding Process Lists](#)

The Organizational Structure

The Absence Management core application determines the organizational structure for absence processing.

This diagram shows the hierarchy of components in the organizational structure.

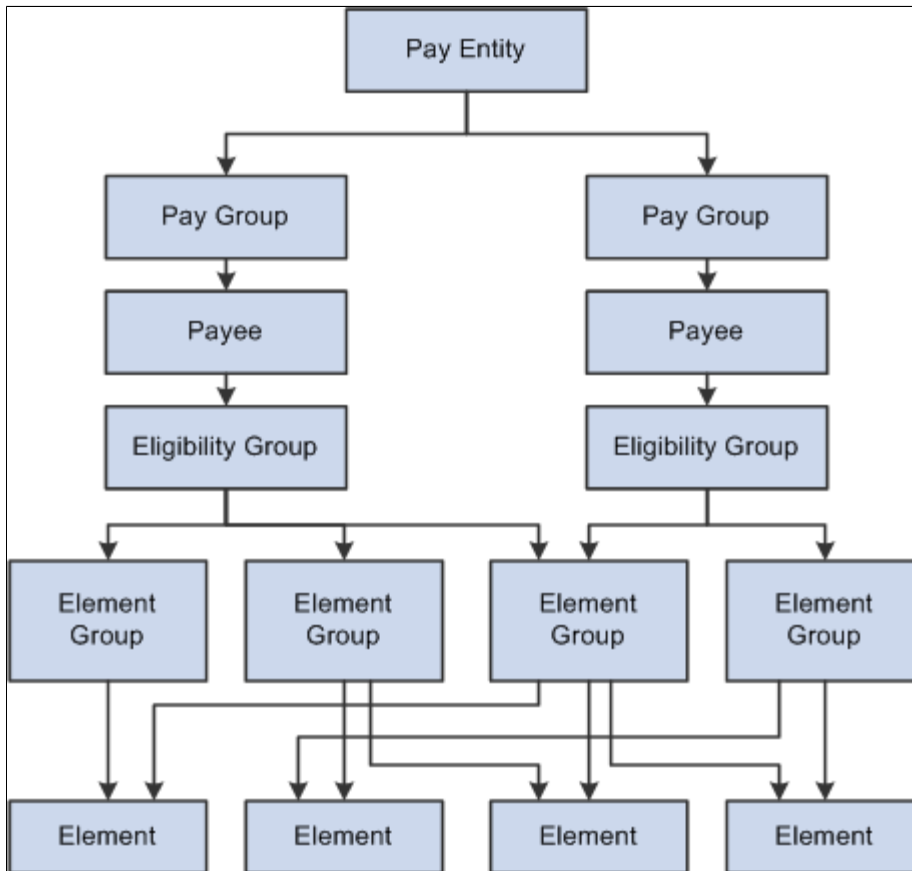

Pay Entity

Pay entity defines the organization managing absences for payees.

A pay entity can be linked to one or more pay groups. However, each pay group is linked with only one pay entity.

You associate a specific country with each pay entity. This country designation is important for many features in Absence Management such as the groups of calendars with a single calendar group ID, retroactive methods, and trigger definitions.

Pay group

Absence Management uses a logical grouping, called pay group, to qualify individuals for absence management. Typically, all individuals in a pay group have something in common that causes them to be processed at the same time in the absence management system.

Common examples of pay groups are salaried and hourly payees. You can assign a payee's default absence elements based on pay group if you select this option at installation time. A pay group can be associated only with a single pay entity.

Each pay group has a default eligibility group associated with it. This includes the default absence elements for the pay group population. The default eligibility group that is associated with a pay group is used as the payee level default. You can override these defaults.

pay groups are ultimately associated with pay calendars to process absences. It is important to group payees whose absences are calculated with the same frequency—weekly, monthly, and so on.

Payee

Payees are the people in your organization for which you want to calculate absence results.

Payees who are included in a pay group definition can be members of different eligibility groups. The only link between pay groups and eligibility groups is from a default perspective. The eligibility group that is defined on the Pay Group page is used as an initial default for the payee. You can override the default.

Eligibility Group

An eligibility group is a grouping of element groups. Eligibility groups indicate the specific elements for which a certain payee population is eligible. The default eligibility group is defined at the pay group level. A payee is assigned to an eligibility group through the default that is defined at the pay group level. You can override the default value.

For example, let's say that you have a pay group for all payees whose absences are calculated monthly. Of those payees, 99 percent are regular, salaried payees, who are eligible for regular absence entitlements and takes. However, you also have 10 executives whom you want to include in that same pay group. These executives are eligible for slightly different absence rules. You can override their eligibility group and assign them to the EXEC ABSENCES eligibility group. You can have only one default eligibility group for each pay group.

Element Group

Element groups provide a method of assigning a large number of elements to many eligibility groups without repeating the elements in each and every eligibility group. Element groups provide a means for grouping these elements. You can assign any number of element groups to an eligibility group.

Elements

Elements are the basic building blocks of Absence Management. The organizational structure of the system begins with the definition of these basic absence management components.

Related Links

[Understanding Payee Data](#)

[Understanding the Organizational Structure](#)

The Processing Structure

This diagram shows the components of the processing structure.

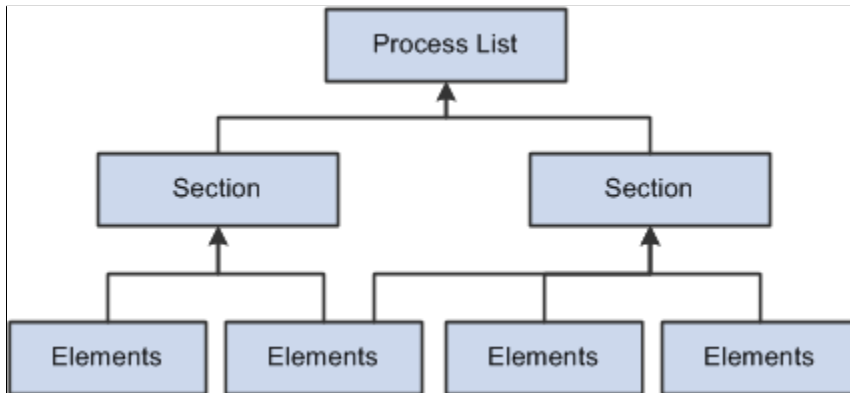

Process List

A process list specifies the order in which absence elements are processed and resolved. You add these elements to the process list by using sections. If you add sections to your process list, the sections are processed in the order in which you insert them into the list. You can also execute sections conditionally.

The Process List - Definition page indicates that the type of calculation is absence.

Section

A section is a grouping of elements and controls the order that those elements are processed on the process list. You can use the following types of sections for absence processing:

- Standard sections for regular processing.
- Payee sections for specifying, at the payee level, elements for processing.
- Absence take sections for processing absences in date sequence.

Once you have defined a section, you can reuse it in multiple process lists.

Elements

Elements are the basic building blocks in Absence Management. Some stand alone while others use several simple elements (called *supporting elements*) that are combined to form more complex elements.

During an absence processing run, the system resolves each element in the process list for each payee. The elements that are resolved depend on a payee, so the resolved value of an element depends on which payee is under consideration.

Related Links

[Understanding Processing Elements](#)

[Understanding Elements](#)

Calendars

To run an absence process, the relevant components of the system are tied together through the use of calendars. A calendar controls whose absence results will be calculated, and the period of time for which the absences are processed.

Only one pay group can be associated with a calendar. Through the use of various selection criteria, you can define who is going to be paid:

- Calendar run types define the type of absence run; for example, a regular absence run or an off-cycle absence run.
- Calendar period IDs define the period of time for which the absences are processed.
- Calendar group ID groups the calendars that you want to process at the same time.

This diagram shows how calendars ties together the components of an absence run.

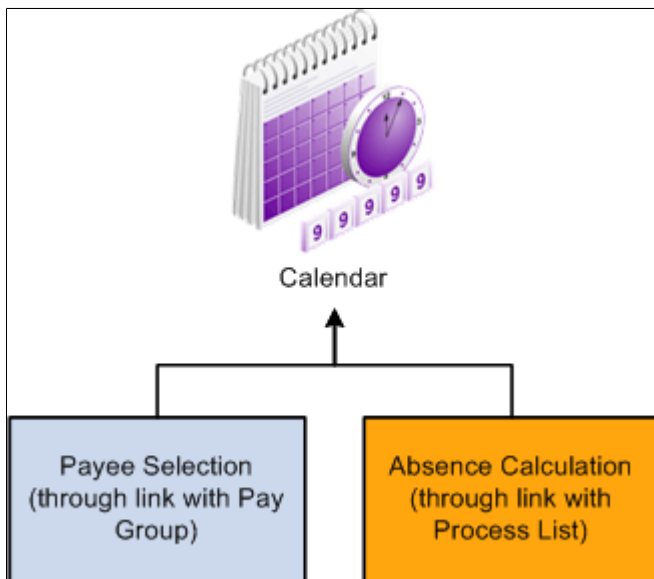

Related Links

[Understanding Calendars](#)

Understanding the Batch Architecture Process Flow

This topic discusses:

- Absence Management modes.
- Payee selection.
- Calculation (technical).
- Arrays used in batch processing (technical).

- Batch processing output tables.

Absence Management Modes

Absence Management processes payees and elements by utilizing a very specific processing order. All the components of the system that you define, such as payees, elements, and rules, come together at the time an absence run is executed.

Think of Absence Management as having two primary modes:

- Setup mode

During the setup mode, you define the various elements, rules, and other system configurations that make up your absence management system.

- Processing mode

During the processing mode, Absence Management looks at all the setup information that you've defined, along with any data that you've entered, and processes it according to your specifications.

Note: The discussion in this topic about the batch architecture process flow is a very high-level overview of the process. Each phase of the process is discussed in greater detail later in this documentation.

Payee Selection

When you run an absence batch process, the first program that the system calls is the Service program. The Service program acts as the coordinator between the selection of payees to be processed and the calculation process. The Service program initiates the payee selection process. Once the payees are selected, the Service program passes control of the data that was created during the payee selection phase to the Calculation program.

This diagram shows how the Service program coordinates the payee selection and calculation phases.

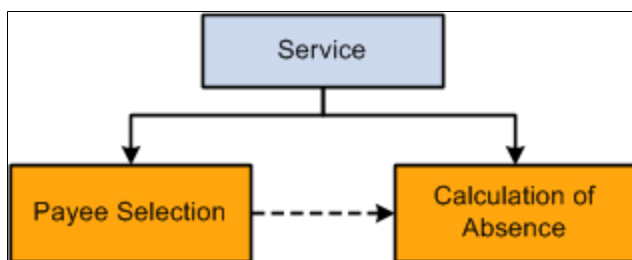

Before you can process absences, you must identify the payees that are to be processed. In Absence Management, this is called *payee selection* or *payee identification*. Payee selection is required in absence processing.

The payee selection process is separate from the calculation process. No rules are defined for payee selection that is associated with an absence calculation. The payee selection phase of the process only identifies the payees and creates the data that is later passed on to the calculation phase.

The pay calendar acts as the controlling function that coordinates and defines the payee selection and calculation processes. The Payroll/Absence Run Control also controls payee selection.

On the calendar definition page, you indicate whether you want active payees or listed payees selected. If you select active payees, you are offered a number of other defining choices. If you select listed payees, you insert the employee ID numbers for the payees that you want to select.

The payee selection process also uses retroactive and period segmentation triggers. Retroactive triggers can cause other periods besides the current absence period to be processed for a particular payee. Period segmentation triggers can cause the absence period to be split into segments, thus producing multiple calculations.

The result of the payee selection process is the creation of Process Status (GP_PYE_PRC_STAT) and Segment Status (GP_PYE_SEG_STAT) records. A Process Stat record is created for each payee for each calendar (including retroactive processes). A Segment Stat record is created for each payee for each segment in each calendar. The Process Stat and Segment Stat records are the storage places for the payee data that is related to the calendar that is being run. Essentially, the Process Stat and Segment Stat records list the payees and all the absence periods that are to be processed, including the current absence period and possible retroactive periods.

Related Links

[Understanding Absence Processing](#)

[Understanding Calendars](#)

Calculation (Technical)

Once payees have been selected, the Service program passes control to the calculation phase of the process. The calculation phase uses the data that is stored in the Process Stat and Segment Stat records as the beginning set of payee data.

The first step in calculating absences is to load process-level data into arrays, including data from sources such as pay entity, pay group, eligibility group, calendar, and the process list. This system data is more static than the payee-specific data.

The calculation programs process each payee, using the Payee Process Stat and Payee Segment Stat Records that were created during the payee selection phase. The program loads all the payee-level data into payee arrays, including data from table sources such as Job, Person, Compensation, and Overrides.

The process that loads the payee-level data into the arrays also refreshes its data or reset pointers to data between every absence run so that:

- The correct effective-dated information is always used.
- The correct year-to-date balances are always reflected.

At this stage, all the process-level and payee-level data is loaded into arrays, ready for processing.

Next, the calculation phase checks element eligibility.

The calculation program calls the Process List Manager program, which looks to the process list to determine which elements will be processed and in what order.

When the Process List Manager encounters an element to be processed, it calls the PIN Manager (a program that manages individual elements) to process each element that passed the element eligibility check earlier in the process. The PIN Manager references the PINV array during this process. The PINV array stores the results of all element resolutions during absence batch processing. If the data stored in

PINV indicates that an element has not already been resolved, the PIN Manager calls an PIN resolution program (a program that processes specific types of elements).

A separate array, called *PINW*, stores the accumulator data that is resolved during batch processing.

Each PIN resolution program resolves a specific type of element. For example, one PIN resolution program might resolve absence elements while another might resolve formula elements. The PIN resolution program loads the element definition into memory. Then the program overrides the definition that is stored in memory with any payee overrides or positive input that is designated for that payee. If any elements are referenced in the element and overrides definitions that are now in memory, the program calls the PIN Manager to resolve them. Remember, an element can comprise other elements. During processing, this means that to resolve a single element, the system might need to resolve any number of other elements from which the primary element is created. The results of this process are used to calculate the values of other elements, and pass the values back to the PIN Manager, which writes them to the main value array (PINV).

Each element is resolved in a cyclical (or *recursive*) manner; that is, each element is resolved, and the data is stored (in PINV or PINW). Then the Process List Manager again looks to the process list to see what element is to be processed next, and the process is repeated.

When all calculations are complete for the absence run, the program writes the results to the appropriate output tables. First, the program references the PINV and PINW arrays and writes the results to the database. Then it references all positive input and writes the data to the positive input history records. Finally, the program generates deltas for any future retroactive processing.

This diagram shows the calculation phase of the batch process.

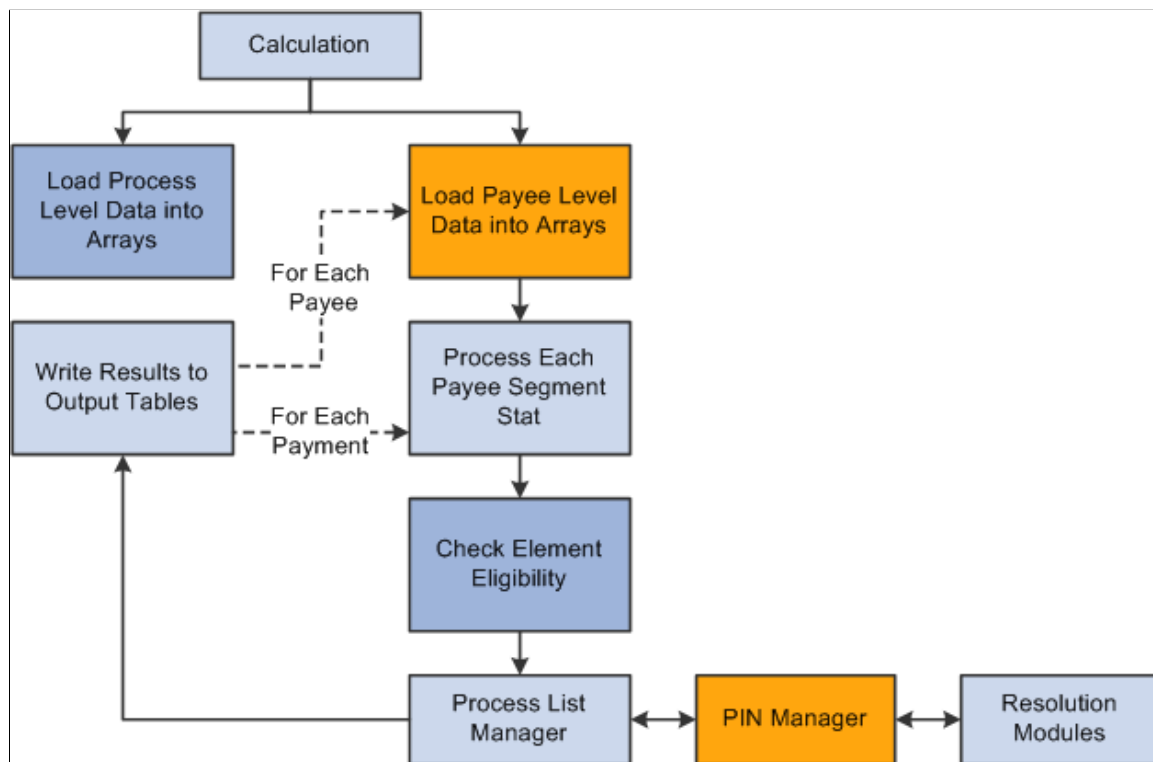

Related Links

[Element Eligibility](#)

Understanding Overrides

Arrays Used in Batch Processing (Technical)

In Absence Management batch processing, arrays are used to store data. Arrays are temporary tables that COBOL programs use to store data during processing. Once processing is complete, the programs write the data from the temporary arrays to the appropriate output tables.

Occasionally you might need to modify the COBOL programs to accommodate a larger maximum array size than is defined in the programs that are delivered by PeopleSoft. If an array is too small (the data overflows the array), you get an error message, and the batch process fails. The error message (MSGID-ARRAY-OFLOW) identifies the array and the COBOL file where the array is defined. This guides you to the location in the designated file that might need modification.

Increasing the Occurs Count in Arrays

The table access programs allocate a specified, limited amount of memory space to store in a table array all the details of the absence management process tables that are typical for an absence run.

You can increase the maximum size of an array by increasing the occurs count in the appropriate table access program.

Note: This is the only COBOL modification that we detail because COBOL modifications to the delivered Absence Management programs are *strongly* discouraged.

For example, let's look at a piece of unmodified code in GPCDPDM.CBL.

Below is an array and its related COUNT control field that prevents the program from aborting. When you make a modification, both *highlighted* numbers must be changed and kept in sync.

```
05  L-PMT-COUNT          PIC 9999    VALUE 0    COMP.
      88  L-PMT-COUNT-MAX          VALUE 20.

05  L-PMT-DATA          OCCURS 20
                          INDEXED BY PMT-IDX.
```

The assumption here is that there will never be more than 20 absences processed for a payee during any calendar run. If more than 20 absences were processed, the program would issue an error message (MSGID-ARRAY-OFLOW), and the absence management process would terminate.

While the system loads and refreshes this array once for each payee, the system refreshes other arrays for each absence, and loads and increments others throughout the entire process.

This type of modification is not difficult to deal with when you upgrade to a new Absence Management release, when PeopleSoft delivers a whole new set of source code. Simply move your array size modifications to the new code line. Whenever you change the size of an array, be sure to recompile the entire Global Payroll COBOL code line (GPP*).

Related Links

[Understanding the Absence Management Utilities](#)

Batch Processing Output Tables

The goal of an absence batch processing run is to produce a set of output tables, where your important batch processing data results reside. Once you know the type of information that resides in the output tables that are generated by Absence Management, you can use those tables to produce reports and other data manipulations that are relevant to your organization's needs.

This diagram shows the relationships between the batch processing output tables.

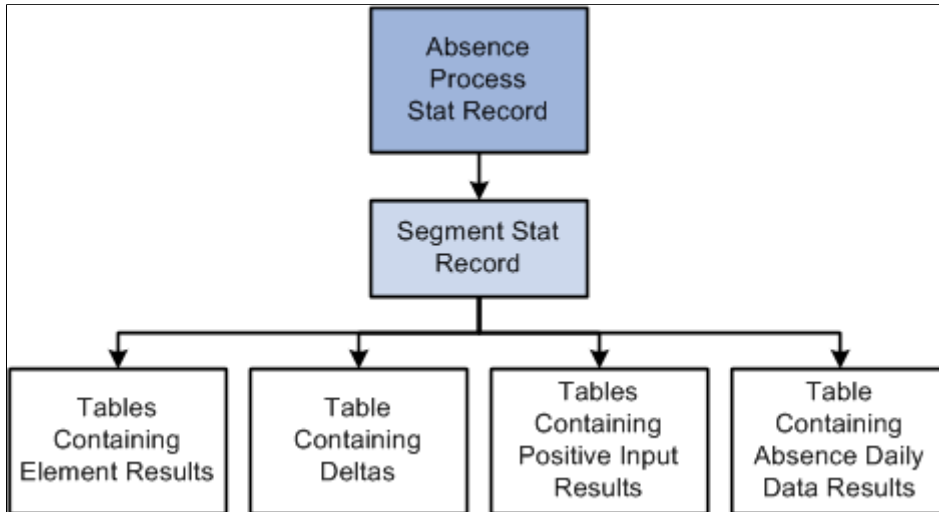

Tables Generated by Payee Selection Process

The payee selection process generates the following tables:

- Process Stat (status) record (GP_PYE_PRC_STAT).

There is one Process Stat record for every EMPLID/EMPL_RCD combination per calendar.

There is a one-to-one/many relationship between the Process Stat record and the Segment Stat record.

- Segment Stat record (GP_PYE_SEG_STAT).

The Segment Stat record is a child of the Process Stat record. There is one Segment Stat record for each gross to net within the calendar.

Tables Containing Element Results

The following tables contain element results:

- Generated Positive Input (GP_GEN_PI_DATA).

Contains the results of earnings and deductions after batch processing.

- Other Elements (GP_RSLT_PIN).

Contains the results of miscellaneous element resolutions after batch processing.

Table Containing Accumulator Results

The Accumulators table (GP_RSLT_ACUM) contains the results of accumulators after batch processing.

Table Containing Deltas

The Deltas table (GP_RSLT_DELTA) contains deltas, which are the differences between two element results. This data is often important for processing retroactivity. This table is a child table to the Segment Stat (segment status) table (GP_PYE_SEG_STAT), which is a child of the Process Stat table (GP_PYE_PRC_STAT).

Tables Containing Absence Daily Data Results

The following table contains the absence daily data results.

Absence Daily Data (GP_RSLT_ABS)

Defining Installation Settings

To define installation settings, use the Installation Table (INSTALLATION_TBL), Installation Settings (GP_INSTALLATION), and Countries (GP_COUNTRY) components.

When you install Absence Management, you select various settings and default values that are specific to your implementation.

Pages Used to Define Installation Settings

| <i>Page Name</i> | <i>Definition Name</i> | <i>Usage</i> |
|------------------------------------|------------------------|---|
| <u>Products Page</u> | INSTALLATION_TBL1 | Define the PeopleSoft applications installed. |
| <u>Country Specific Page</u> | INSTALLATION_TBL3 | Define country-specific information. |
| <u>Installation Settings Page</u> | GP_INSTALLATION | Define installation settings that are unique to Absence Management. |
| <u>Schedule Settings Page</u> | TL_INSTL_PUNCH | Define default settings for work schedules. |
| <u>Configuration Settings Page</u> | GP_ACTIVAT_SETTING | Enable and configure feature settings. |
| Dates Table Load Page | TL_DATE_LOAD | Load dates for use in resolving schedules. |
| <u>Countries Page</u> | GP_COUNTRY | Define country-level setup parameters. |

Products Page

Use the Products page (INSTALLATION_TBL1) to define the PeopleSoft applications installed.

Navigation:

Set Up HCM > Install > Installation Table > Products

If your organization also uses PeopleSoft Payroll for North America or PeopleSoft Payroll Interface, select the appropriate check box as well.

Note: To use the Absence Management application, the Global Payroll Core check box might be cleared.

Related Links

“Products Page” (Application Fundamentals)

Country Specific Page

Use the Country Specific page (INSTALLATION_TBL3) to define country-specific information.

Navigation:

Set Up HCM > Install > Installation Table > Country Specific

Use the Country field to define the primary country in which your organization does business. This should be the country with the majority of your payees.

Related Links

“Country Specific Page” (Application Fundamentals)

Installation Settings Page

Use the Installation Settings page (GP_INSTALLATION) to define installation settings that are unique to Absence Management.

Navigation:

Set Up HCM > Product Related > Global Payroll & Absence Mgmt > System Settings > Installation Settings > Installation Settings

This example illustrates the fields and controls on the Installation Settings page.

Installation Settings
Schedule Settings
Configuration Settings

Checkpoint Intervals

| | | |
|-------------------|-----------------------------------|---|
| Identify Phase | <input type="text" value="2000"/> | Intervals explained: One of the parameters that affect batch processing performance is the amount of work accumulated in the system before changes are committed to the database. The "Checkpoint Intervals" measure the accumulated work in terms of the number of payees processed in a given processing phase between each commit. The optimal setting is unique to each installation and phase. The "Progress Interval" controls when progress is recorded on the process log during the calculation phase. |
| Calculate Phase | <input type="text" value="1000"/> | |
| TL Feed Phase | <input type="text" value="3000"/> | |
| *Cancel Phase | <input type="text" value="2000"/> | |
| Progress Interval | <input type="text" value="500"/> | |

Absence Processing

Months of Absence History

Bundle PI on Output

Absence Event Entry

Days Before Current Date Days After Current Date

Role not allowed Approve Automatically

Hide Forecast Button

Hide Save For Later Button

Absence Analytics Settings

Days Before Current Date Days After Current Date

*Access Type

This example illustrates the fields and controls on the Installation Settings page.

Payment Processing

Database Identifier

Payment Count

Packager Processing Defaults

Script Location

Script Location example: C:\folder\

Rule Packager Defaults

Compare Report Print Options

Errors/Warnings
 Modified
 New
 Deleted
 Unchanged

Continue Upgrade Processing

With Errors
 With Warnings

Payslip Store Option

Store Option

Checkpoint Intervals

Checkpoint intervals control how many employees are processed between database commits. You can select a different interval for the identify and calculate processing phases. Employees that are *committed* do not need to be recalculated if the run has to be restarted because of a technical error.

| <i>Field or Control</i> | <i>Description</i> |
|--------------------------|---|
| Progress Interval | Controls how often the process writes a line to the process log stating how many employees have been processed. |

Absence Processing

| <i>Field or Control</i> | <i>Description</i> |
|--|--|
| Months of Absence History | Controls how many months of absence daily history to load into the batch process for use with the absence take element processing and duration element. The absence daily history is loaded from the result table, GP_RSLT_ABS. |
| Bundle PI on Output (bundle positive input on output) | <p>Selecting this check box causes the system to consolidate positive input during the absence process, when possible, so that you can send a single row of positive input to payroll. Positive input entries for the same absence event that share the same percent and rate are combined; the unit, amount, and base values are summed. In other words, the bundled generated positive input rows will be output from the absence process instead of daily rows. This is a consideration when considering the size of data storage for the generated positive input result table. Keep in mind, the daily earning/deduction element details will not be stored. This does not effect the actual earning/deduction calculation during the pay calculation. If this check box is off, daily rows would be inserted into the generated positive input result table from the absence process, and the daily rows would be bundled as part of the input process for the pay calculation.</p> <p>See “Absence Processing” (PeopleSoft Global Payroll).</p> |

Absence Event Entry

Use the fields in this group box to configure the [Create and Maintain Absence Requests Page](#) and the [Approve Absence Requests Page](#).

| <i>Field or Control</i> | <i>Description</i> |
|---|---|
| Days Before Current Date and Days After Current Date | Use these fields to define the default date range that appears in the Search group box of the Create and Maintain Absence Requests page in the From Date and Through Date fields. |

| <i>Field or Control</i> | <i>Description</i> |
|---|---|
| Role not allowed Approve Automatically | Users that have the role that you enter here cannot select the Approve Automatically value in the Submit Option field on the Create and Maintain Absence Requests page. |
| Hide Forecast Button | Select to hide the Forecast button on the Create and Maintain Absence Requests and Approve Absence Requests pages. |
| Hide Save For Later Button | Select to hide the Save For Later button on the Create and Maintain Absence Requests page. |

Absence Analytics Settings

Use the fields in this group box to establish default settings for the Absence Cost Analysis, Absence Events Analysis, Absence Liability and Trends, and Periodic Absence Rate pivot grids that appear on the Absence Analytics Dashboard.

| <i>Field or Control</i> | <i>Description</i> |
|---|---|
| Days Before Current Date and Days After Current Date | Use these fields to define the default date range for which the pivot grids display information. You can change this date range when you access the individual pivot grids. |
| Access Type | Enter the access type that the pivot grids use to determine direct reports for managers. |

For more information on the Absence Analytics Dashboard, see [Using the Absence Analytics Dashboard Pagelets](#).

Enable Pivot Grid Analytics

| <i>Field or Control</i> | <i>Description</i> |
|------------------------------------|---|
| Enable Pivot Grid Analytics | Select to enable the process that extracts data for the pivot grids that appear in the Absence Analytics Dashboard. For more information, see Preparing and Loading Absence Analytics Data . |

Payment Processing

Use this group box to define database-specific payment processing settings that are used when communicating payment information.

| Field or Control | Description |
|----------------------------|--|
| Database Identifier | Enter a unique alphanumeric identifier that the system adds to payment messages that it sends. |
| Payment Count | Enter the number of payments that you want the system to chunk together with each payment message. For example, if you enter 3000 here, the system will create and publish a separate payment message for every 3000 rows of payment data. |

Packager Processing Defaults

| Field or Control | Description |
|-------------------------------------|---|
| Script Location | <p>Enter the location where DMS scripts are created. The default will be blank. An example displays below the field to let you know how to enter the script location.</p> <hr/> <p>Note: The value will default for the rule and non-rule packages. This script location should match the location set up for the PSNT process scheduler in which you are using. This is set up in the psconfig.cfg file.</p> <hr/> |
| Compare Report Print Options | <p>This group box controls the sections of the Compare Report that will be printed. Select the sections of the report to print . The options on the Packager Processing page will default the values selected each time you run a Compare Report. The check boxes can be overridden on the processing pages.</p> <p>Values for the report sections include:</p> <ul style="list-style-type: none"> • <i>Errors/Warnings</i> – Select to print the warning or errors that have occurred during the compare. • <i>Modified</i> – Select to print the elements that are different from the ones in the target database. <p>The above two options reflect the delivered defaults.</p> <ul style="list-style-type: none"> • <i>New</i> – Select to print the new elements. • <i>Deleted</i> – Select to print the elements that will be deleted. • <i>Unchanged</i> – Select to print the elements that have not changed. |

| Field or Control | Description |
|---|---|
| <p>Continue Upgrade Processing</p> | <p>This group box controls the ability to upgrade when there are errors or warnings. The default for each value is cleared.</p> <p>Valid values include:</p> <ul style="list-style-type: none"> • <i>With Errors</i> – Select to upgrade the package even if there are errors after the compare. • <i>With Warnings</i> – Select to upgrade the package even if there are warnings after the compare. |

Schedule Settings Page

Use the Schedule Settings page (TL_INSTL_PUNCH) to define default settings for work schedules.

Navigation:

Set Up HCM > Product Related > Global Payroll & Absence Mgmt > System Settings > Installation Settings > Schedule Settings

This example illustrates the fields and controls on the Schedule Settings page.

The screenshot displays the 'Schedule Settings' page with the following sections:

- Installation Settings | Schedule Settings | Configuration Settings** (Navigation tabs)
- Load Dates** (with help icon):
 - Load Dates
 - Existing range covers 06/19/1998 through 11/29/2024.
- Scheduling and Punch Pattern**
 - *Schedule Resolution: Take Last Schedule Update
 - *Schedule Totaling: Exclude Breaks and Meals
 - Default Punch Pattern** (with help icon):

| *Punch Type | *Column Heading | | |
|-------------|-----------------|---|---|
| In | In | + | - |
| Break | Break | + | - |
| In | In | + | - |
| Meal | Lunch | + | - |
| In | In | + | - |
| Out | Out | + | - |
- Product Integration**
 - Allow Override to Schedule
- Payable Time Approvals** (with help icon)
 - Retain basic (non-AWE) model
- Email Notifications**
 - Enable Notifications
 - Enable Alert Notification
- Manager Notifications**
 - Exception Generated
 - Scheduled Event Modified
 - Payable Time Needs Approval
- Employee Notifications**
 - Payable Time Is Approved
- Employee Location**
 - Radius: Feet

| Field or Control | Description |
|----------------------------|---|
| Load Dates | Click to access the Dates Table Load page where you can load the range of dates to be used in schedules. Dates from 1994 to 2014 are pre-loaded. You need only use this feature to load dates before or after this date range. |
| Schedule Resolution | Specify how to resolve schedule changes. Select <i>Take Last Schedule Update</i> to have the system use the last update to resolve an employee's schedule, whether the update comes from a third-party, workforce scheduling system or an online override. Select <i>Take Online Override</i> to have the system look for an online schedule override to resolve the schedule for the day. The system does not look for changes from a third-party workforce scheduling system. |
| Schedule Totaling | This field applies only if People Soft Enterprise Time and Labor is installed. Specify whether to include or exclude meal times, breaks, or both in the scheduled hours totals on schedule definitions, shift definitions, and the Manage Schedules page. Options are <i>Exclude Meals and Breaks</i> , <i>Include Meals and Breaks</i> , <i>Include Meals</i> , and <i>Include Breaks</i> . The default is <i>Include Breaks</i> . |

Default Punch Pattern

Specify the default sequence for displaying punch types on the scheduling pages. You can also use the Grid Column Heading fields to modify the punch type labels that are to appear as column headings on the schedule pages.

Payable Time Approvals

| Field or Control | Description |
|---|--|
| Retain basic (non-AWE) model (retain basic non-Approval Workflow Engine model) | Select to use the basic model for approving Time and Labor payable time instead of Approval Workflow Engine. |

Email Notifications

| Field or Control | Description |
|-----------------------------|--|
| Enable Notifications | Select to enable email notifications. You cannot select any of the check boxes in the Manager Notifications or Employee Notifications group boxes unless the Enable Notifications check box is selected. |

Note: Oracle PeopleSoft delivers Notification Composer Framework to manage the setup and administration of all notifications in one central location.

Once you have adopted the Notification Composer feature, you must use it to create new notifications and manage your existing notifications.

Notifications delivered with HCM Image 47 or later must use Notification Composer.

For more information about Notification Composer Framework, see “Understanding Notification Composer” (Enterprise Components).

Manager Notifications

| <i>Field or Control</i> | <i>Description</i> |
|------------------------------------|---|
| Exception Generated | Select to generate a notification when an exception is generated. |
| Scheduled Event Modified | Select to generate a notification when a scheduled event is modified. |
| Payable Time Needs Approval | Select to generate a notification when payable time needs approval. |

Employee Notifications

| <i>Field or Control</i> | <i>Description</i> |
|---------------------------------|--|
| Payable Time Is Approved | Select to generate a notification when payable time is approved. |

Related Links

“Understanding Work Schedules” (PeopleSoft Global Payroll)

Configuration Settings Page

Use the Configuration Settings page (GP_ACTIVAT_SETTING) to enable and configure feature settings.

Navigation:

Set Up HCM > Product Related > Global Payroll & Absence Mgmt > System Settings > Installation Settings > Configuration Settings

This example illustrates the fields and controls on the Configuration Settings page.

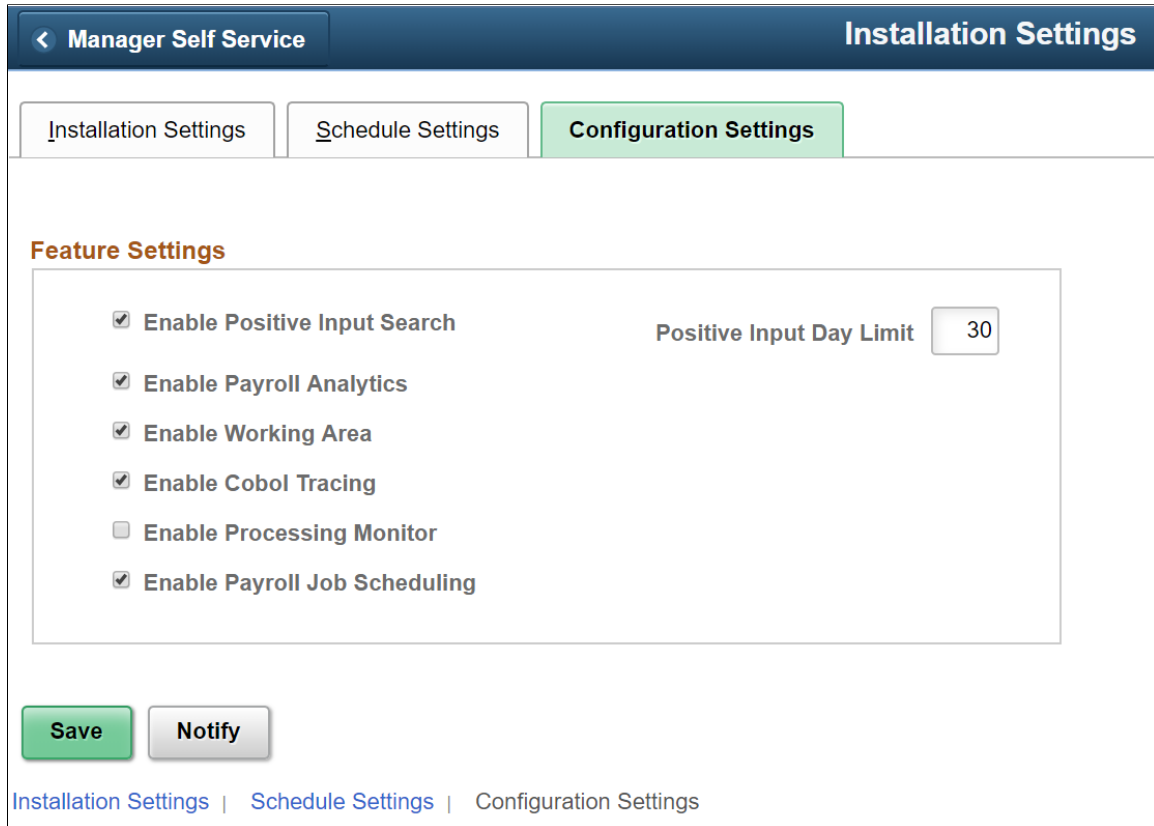

Feature Settings

| <i>Field or Control</i> | <i>Description</i> |
|-------------------------------------|--|
| Enable Positive Input Search | Select to enable the Positive Input Search page. If this check box is deselected, users trying to access the Positive Input Search page receive an error message explaining that this check box must be selected before the page can be accessed. |
| Positive Input Day Limit | Enter the number of days in history for which the keyword search retrieves results on the “Positive Input Search Page” (PeopleSoft Global Payroll). For example, if the value in this field is <i>100</i> , the search looks for positive input entries that match your keywords and that were entered 100 days ago or less. |
| Enable Payroll Analytics | Select to enable access to the “Global Payroll Analytics Page” (PeopleSoft Global Payroll). If this check box is deselected, users trying to access the page receive an error message explaining that this check box must be selected before the page can be accessed. |

| Field or Control | Description |
|--------------------------------------|--|
| Enable Working Area | Select to calculate work item counts during the payroll process. The system displays these counts on the “Payroll Work Items Page” (PeopleSoft Global Payroll). |
| Enable Cobol Tracing | Select to enable the Cobol Trace Parameters functionality on the “Debug and Tuning Options Page” (PeopleSoft Global Payroll). |
| Enable Processing Monitor | Currently, this functionality is not supported in PeopleSoft. |
| Enable Payroll Job Scheduling | Select to enable the scheduling of Payroll Job. If this option is selected the user can schedule the payroll job for Calculate (and Recalculate) option. The system retains the calendar control run parameters for scheduled run and in case if multiple users finalize or cancel the calendar, the stored run control parameters are deleted and its corresponding scheduled job is also cancelled. In case the user who scheduled the payroll job is different from the one who cancels or finalizes the calendar the mail notification is sent to user who scheduled the job about deletion of stored run control parameters and cancelation of scheduled run. |

Countries Page

Use the Countries page (GP_COUNTRY) to define country-level setup parameters.

Navigation:

Set Up HCM > Product Related > Global Payroll & Absence Mgmt > System Settings > Countries > Countries

This example illustrates the fields and controls on the Countries page.

Countries

Country Switzerland

Net Pay Validation Formula

*Default Retroactive Method

*On Conflict Retroactive Method

Store Non-Zero Delta Component

MultiContract Processing Order

Use Current Results+Adjustment

To Process Banking

To Process General Ledger

Process Payee Assignments

*Process Assignments Option

Prorate Assignments Start Date

Supporting Element Overrides

*Payee Level

Note: Although the fields on the Countries page are not directly applicable to Absence Management, you must use the Countries component to define a country record for each country that uses the Absence Management application. Creating country records is a prerequisite to defining self-service absence entry rules and for using some other features.

| Field or Control | Description |
|---------------------------------------|--|
| Net Pay Validation Formula | This field is not applicable to Absence Management. |
| Default Retroactive Method | Values are <i>Corrective</i> and <i>Forwarding</i> . The only valid value for Absence Management is <i>Corrective</i> . |
| On Conflict Retroactive Method | Select which retroactive method, <i>Corrective</i> or <i>Forwarding</i> . The only valid value for Absence Management is <i>Corrective</i> . |
| Prorate Assignments Start Date | This field is used when the Process Assignment Option is <i>Active Anytime within Segment</i> . It is not used with Absence Management. |

Store Non-Zero Delta Component

Select this check box in order for the system to store any delta amount or delta component that has a nonzero value, regardless of the setting on the Element Name (GP_PIN) page, Results group box for the element. Clear this check box in order for deltas to inherit the element's store option.

The following table provides an overview of how the system interprets the check box settings at different levels:

| <i>Element Store Option</i> | <i>Country Delta Option</i> | <i>Element is Stored</i> | <i>Delta is Stored</i> |
|-----------------------------|-----------------------------|--------------------------|------------------------|
| ON | ON | YES | YES |
| ON | OFF | YES | YES |
| OFF | ON | NO | YES |
| OFF | OFF | NO | NO |

Note: For additional information regarding retroactivity, see [Understanding Retroactive Processing](#).

MultiContract Processing Order

Select this check box to set the processing order to Emplid/Empl_Rcd for Swiss clients with Multi Contract. This field is displayed only for CHE Switzerland.

Use Current Results + Adjustment

The check boxes in this group box are not applicable to Absence Management.

Process Payee Assignments

The Process Assignments Option field determines when to process earning or deduction payee assignments. The options are:

- *Active as of the Segment End Date:* Select to have an element entered on the payee assignment page processed if the assignment is active as of the segment end date.
- *Active Anytime within Segment:* Select to have an element entered on the payee assignment page processed and prorated for rows falling within a segment in addition to rows active as of the segment end date.

Note: This option is used when the proration of earning/deduction assignments is desired. This is the first in a series of steps to setting up the proration of earning/deduction assignments functionality. Additionally a segmentation trigger definition must be defined for the payee assignment record (GP_PYE_OVRD).

Supporting Element Overrides

The Payee Level field determines the level at which Payee Supporting Element Overrides are resolved.

Available options are:

- By Segment: Override value applies to the full segment.
- By Slice: Override value can be resolved separately for each slice in case of Element Segmentation.

If no value is selected in this field, the option 'By Segment' is taken by default.

Chapter 4

Working with Payee Data

Understanding Payee Data

Absence Management uses payee data that is defined in HR, including job and personal data, and schedules.

Absence Management recognizes the following payee types:

- Employees
- Contingent workers

Absence Management can track absence information for these payee types.

When you add a payee into HR through the Job Data component, you indicate that Absence Management is the absence system for the payee and then you assign the payee to a pay group. The pay group defines the default processing instructions for the payee, which you can override.

Using elements defined in Absence Management, you can retrieve payee-specific data from HR during processing.

Several areas of HR are country-specific, such as those that deal with job and personal data. For more information about these topics, see the corresponding country-specific documentation for HR.

Note: Absence Management provides payee-level security that restricts the payees that a user can view.

Related Links

[Payee Security](#)

Understanding Data Retrieval from HR

This topic discusses how data in HR is retrieved and used in Absence Management using these elements:

- Database system elements
- Arrays
- Rate codes
- Frequency
- Triggers

Database System Elements

Database system elements contain payee-related data that is retrieved from HR and commonly used in absence calculations. You don't have to set up these elements or do anything special to resolve them. They are resolved when they're used in a calculation.

These HR tables populate database system elements:

- PERSON.
- PERS_DATA_EFFDT (personal data effective date).
- PER_ORG_ASGN_VW.
- JOB (including fields from country-specific sub records).
- PER_ORG_ASGN (person organizational assignment).
- PER_ORG_INST (person organizational instance).
- ADDRESSES.
- CONTRACT_DATA.
- WKF_CNT_TYPE (workforce contract type).

See [Working with System Elements](#).

Arrays

An array is an element that retrieves data from any table or view that database system elements do not retrieve. For example, you can use an array to retrieve data from the Benefit table or the Company table in HR for further processing in Absence Management.

See [Defining Array Elements](#).

Rate Codes

You use rate codes to retrieve multiple components of pay data from HR and bring into Absence Management. The system calculates the values in Absence Management, rather than transferring the data directly from HR, so that currency conversions can be calculated for every absence run. In Absence Management, you define a rate code element and link it to the corresponding rate code defined in a HR table.

See [Defining Rate Code Elements](#).

Frequency

HR has an effective-dated Frequency table, where you enter the annualization factor for each frequency. Defining the annualization factor is important for absence processing in Absence Management.

Absence Management accesses the same Frequency table as HR and uses it throughout Absence Management for annualization and deannualization. When you set up a frequency in HR, you associate a

factor with it. For example, an annual factor can be equal to one, a monthly factor can be equal to 12, and a weekly factor can be equal to 52.

The frequency formulas used for annualization and deannualization are the same for both HR and Absence Management:

- $(\text{Annualized Amount}) = (\text{Amount}) \times (\text{Frequency Factor})$.
- $(\text{Deannualized Amount}) = (\text{Annualized Amount}) / (\text{Frequency Factor})$.

Important! If you change the effective status, frequency type, or annualization factor of an existing frequency on the Frequency Table page in HR, you get a warning message saying that previous calculations using this frequency are out of sync with the new values of the frequency.

When defining absence elements in Absence Management, the system obtains the frequency factor from HR. The system annualizes the absence element, according to the specified frequency factor, and denationalize the absence element, according to the specified calendar period frequency. The only exception to this rule is when you've specified a generation control frequency. Then, the system annualizes the absence value according to the specified frequency factor, but denationalize it according to the generation control frequency.

In Absence Management, frequency is used with:

- Element definition.
- Generation control.
- Calendar periods (when defining the frequency that's being processed).
- Rate code elements.
- System elements.

See [Earnings and Deductions](#).

See "Understanding Frequency IDs" (Application Fundamentals).

Triggers

You can create triggers in Absence Management to detect changes made to data in HR. This enables Absence Management to identify payees automatically who need to be recalculated during an absence run. You can set up retro, segmentation, or iterative triggers. For example, you might want to create a retro trigger that detects changes to job data, thus telling the system that retroactivity should occur for this event.

Triggers can respond to field-level and record-level data changes.

With Absence Management, you can also create mass triggers. Mass triggers enable you to generate payee triggers based on changes to setup tables. Mass triggers can be established for specific records on specific components.

See [Understanding Triggers](#).

See .

Assigning an Absence System and Pay Group to a Payee

Page Used to Assign an Absence System and Pay Group to a Payee

| <i>Page Name</i> | <i>Definition Name</i> | <i>Usage</i> |
|---------------------|------------------------|---|
| <u>Payroll Page</u> | JOB_DATA2 | Select Absence Management as the absence system and assign pay group parameters for each payee whose absences are tracked through Absence Management. |

Understanding Absence System Assignment in HR

You use the Installation Table - Products page in HR to indicate that Absence Management is installed.

There are two actions for which you can select an absence system for a payee:

- Hire
- Rehire

During the hire or rehire process you select an absence system for a payee on the Job Data - Payroll page. This becomes part of the payee's Job record.

For example, suppose that you initially implemented HR, but used a third-party absence management system. On January 1, 2005, your organization decided to convert to Absence Management. You insert a new effective-dated row into the Job record with *Absence Management* selected in the Absence System list box. The payee's absence data will be calculated in Absence Management for absence periods that are in effect as of January 1, 2005.

See “Setting Up Implementation Defaults” (Application Fundamentals).

See “Understanding Job Data” (PeopleSoft Human Resources Administer Workforce).

Points to Remember

Here are some points to remember about assigning Absence Management as the absence system:

- In order for a payee to be processed in Absence Management, the payee must have a Job record, because information about the Absence System flag and the pay group are stored on the payee's Job record. This applies to all types of payees - employees and contingent workers.
- Absence Management processes only the payees for whom the Absence System indicator is set to *Absence Management* for the period of time that the payees are associated with that absence system.
- Absence Management does not prevent you from changing the Absence System indicator from *Absence Management* to another absence system going forward.
- Absence Management does not prevent you from changing the Absence System indicator from *Absence Management* to another absence system retroactively.

Note: It is recommended that you create retro and period segmentation triggers for the Absence System change.

- Absence Management does not support the **Payroll System** of *Other*.
- Absence Management will automatically default as the Absence System when *Global Payroll* is selected as the **Payroll System**.
- Absence Management may be used as a stand alone application and must have a **Payroll System** of *Global Payroll*.
- There is no integration between absence systems.

For example, if your organization switches from Absence Management to another absence management system, PeopleSoft does not automatically transfer the balances and the data. You must transfer that information yourself.

System Occurrences When a Job Data Record is Added or Modified

Certain things happen in the system when a Job record is created for a payee. For example, a row is inserted into the Schedule Assignment table, indicating that the person should use the default schedules that are assigned at the pay group level for Absence Management and at the work group level for PeopleSoft Time and Labor. This occurs regardless of whether or not the payee's absences are tracked in Absence Management.

Related Links

[Trigger Table Data](#)

“Assigning Schedules to a Group” (PeopleSoft Time and Labor)

“Products Page” (Application Fundamentals)

Payroll Page

Use the Payroll page (JOB_DATA2) to select Absence Management as the absence system and assign pay group parameters for each payee whose absences are tracked through Absence Management.

Navigation:

Workforce Administration > Job Information > Job Data > Payroll

This example illustrates the fields and controls on the Job Data - Payroll page.

The screenshot displays the 'Job Data - Payroll' page for employee Antonio Smith. The page is organized into several sections:

- Employee Information:** Antonio Smith, Empl ID K0W001, Empl Record 0.
- Payroll Information:** Effective Date 01/01/2000, Effective Sequence 0, HR Status Active, Payroll Status Active, Action Hire, Reason, Job Indicator Primary Job, Current.
- System Selections:** *Payroll System: Payroll for North America; Absence System: Absence Management.
- Payroll for North America:** Pay Group K01, Employee Type H, Tax Location Code KUCA00, Holiday Schedule KU01, GL Pay Type, Combination Code, Edit ChartFields.
- Absence Management System:** Pay Group K0WPG PNA1, Eligibility Group, Exchange Rate Type, Use Rate As Of.
- Settings:**
 - Use Pay Group Eligibility
 - Use Pay Group Rate Type
 - Use Pay Group As Of Date
- Navigation:** Job Data, Employment Data, Earnings Distribution, Benefits Program Participation.

Assigning Pay Groups and Overriding Pay Group Defaults

For each payee whose absences you will track in Absence Management, you must do the following:

1. Select *Absence Management* on the Installation Table - Products page.
2. Assign the payee to a pay group on the Job Data - Payroll page in HR.

The pay group assignment determines the default values for the payee's eligibility group. You can override these values for an individual payee on the Job Data - Payroll page.

Note: As part of the general setup for Absence Management, you must define payee job data defaults on the Pay Group Name page prior to selecting a pay group for a payee on the Job Data - Payroll page.

Note: If you do not select a holiday schedule for the payee on the Job Data - Payroll page, the system uses the holiday schedule assigned to the payee's pay group during absence processing .

Note: The Job Data - Payroll page is discussed in HR documentation. The Pay Group Name page is discussed elsewhere in this documentation.

See “Understanding Job Data” (PeopleSoft Human Resources Administer Workforce).

See [Understanding the Organizational Structure](#).

Viewing Payee Data

Page Used to View Job Information

| <i>Page Name</i> | <i>Definition Name</i> | <i>Usage</i> |
|---|------------------------|---|
| Review Job Information Page | GP_PYE_DATA | View Absence Management-specific information that is stored for a payee on the Job record in HR, as well as the pay entity that is associated with the pay group on the Job record. |

Understanding Payee Data Pages in Absence Management

Absence Management contains two payee data-related pages: Job Information and Retro Limits Assignment. This topic discusses how to view job data for a payee on the Job Information page. The Retro Limits Assignment page is discussed elsewhere in this documentation.

Related Links

[Setting Backward and Forward Retro Limits](#)

Review Job Information Page

Use the Review Job Information page (GP_PYE_DATA) to view Absence Management-specific information that is stored for a payee on the Job record in HR, as well as the pay entity that is associated with the pay group on the Job record.

Navigation:

Global Payroll & Absence Mgmt > Payee Data > Review Job Information > Review Job Information

This example illustrates the fields and controls on the Review Job Information page.

| Review Job Information | | | | | | |
|------------------------|----------------|---------------|---|---------------------------|--------------------|----------------|
| Employee ID K0W001 | | Empl Record 0 | | Name <u>Antonio Smith</u> | | |
| Job Data | | | Personalize Find View All First 1 of 1 Last | | | |
| Effective Date | Payroll System | Pay Group | Pay Entity | Eligibility Group | Exchange Rate Type | Use Rate As Of |
| 01/01/2000 | NA | K0WPG PNA1 | K0WPE ABS1 | | | |

To change data that appears on this page, you must update the Job record in HR using the Job Data - Payroll page or one of the other Job Data components.

| Field or Control | Description |
|--------------------------|--|
| Payroll System | Displays the payroll system for the payee. Values are: <i>GP</i> (Global Payroll) <i>NA</i> (Payroll for North America) <i>OT</i> (Other) This pay system flag is not supported in Absence Management. <i>PI</i> (Payroll Interface) |
| Pay Group | Displays the pay group for the payee. |
| Pay Entity | Displays the pay entity for the payee. |
| Eligibility Group | Displays the eligibility group for the payee. |

Note: The **Eligibility Group** field appears only if it is overridden at the payee level. The field is blank if the default value from the pay group is used.

Related Links

“Viewing Information About Current Exchange Rate Calculations” (Application Fundamentals)
[Setting Backward and Forward Retro Limits](#)

Updating Payee Data

When you need to change job or personal data for a payee, add a new effective-dated row. Making changes to an existing row in Job Data or Personal Data can lead to data corruption. To correct this, change the Job row back to the way it was and insert a new row with a different effective date sequence.

Sharing Schedule Data

This topic discusses how to:

- Share the holiday schedule with HR.
- Share schedule assignments with Time and Labor.

Sharing the Holiday Schedule with HR

Absence Management uses the holiday schedule that is created in HR. Holiday schedule information is stored on a payee’s Job record. Absence Management uses the holiday schedule during absence processing to create daily data and update leave balances. It also uses the holiday schedule to resolve count elements during absence processing.

If a holiday schedule is not defined for a payee at the job level in HR, Absence Management uses the holiday schedule defined for the payee's pay group. (The holiday schedule defined for the pay group does not appear, by default, on the Job record.)

Related Links

[“Setting Up Holiday Schedules” \(Application Fundamentals\)](#)

[Understanding the Organizational Structure](#)

Sharing Schedule Assignments with Time and Labor

Absence Management and Time and Labor use many of the same pages and records for setting up and assigning work schedules. If you're using both applications, you may need to create and assign schedules only once.

Absence Management handles batch processing for schedule assignments differently than Time and Labor. When processing in Absence Management, if a payee is using the default work schedule, the system retrieves the default work schedule from the pay group definition. In Time and Labor, if the payee is using the default work schedule, that system retrieves the default work schedule from the workgroup definition.

In Absence Management, you can also assign a schedule to a payee other than the pay group default. You can assign schedules and alternate schedules individually to payees on the Assign Work Schedule page (Primary Details tab and Alternate Details tab).

Points to Remember

Here are some points to remember about work schedules:

- A payee's default work schedule and alternate work schedule are not stored on the Job record.

This information is stored on the PS_SCH_ASSIGN table that is shared by Time and Labor and Absence Management. When a payee is hired, the system creates a new row and applies the default work schedule to the payee.

- You can override a payee's default work schedule and alternate work schedule information at the payee level on the Assign Work Schedule page (Primary Details tab and the Alternate Details tab).

Related Links

[Assigning Work Schedules](#)

[Understanding the Organizational Structure](#)

Chapter 5

Defining General Element Information

Understanding Elements

There are many types of elements in Absence Management; each has a unique purpose. Elements can be grouped into different categories, depending on how each one is used. An element can be used to retrieve data, calculate a formula, or organize the framework for a system. Some elements stand on their own, while others, called *supporting elements*, are building blocks for other elements.

Before defining elements, you perform some basic, one time setup tasks—such as, defining element types and entry types—to help classify your elements so that they make the most sense for your organization.

Although each element type is unique, all element types share a common set of attributes that are defined and stored the same way. Once you've defined an element name, you can add information (such as rules) to the element through its component.

Understanding Categorization of Elements

Elements can fall into different categories, depending on how they're used. This table categorizes elements by function:

| <i>Data Retrieval Elements</i> | <i>Calculation Elements</i> | <i>Organizational Elements</i> |
|---------------------------------------|------------------------------------|---------------------------------------|
| System Elements | Variables | Element Groups |
| Arrays | Dates | Sections |
| Writable Arrays | Duration | Process Lists |
| Brackets | Formulas | |
| Rate Codes | Rounding Rules | |
| Historical Rules | Counts | |
| | Proration Rules | |
| | Earnings | |

| Data Retrieval Elements | Calculation Elements | Organizational Elements |
|--------------------------------|-----------------------------|--------------------------------|
| | Deductions | |
| | Absence Entitlements | |
| | Absence Takes | |
| | Accumulators | |
| | Generation Control | |

Elements can also be categorized by element type: primary element, supporting element, or other type. A primary element can stand alone. A supporting element is used to create other, more complex elements. Other elements are used to define things like eligibility criteria, accumulators, and certain types of rules.

This table categorizes elements by element type:

| Primary Elements | Supporting Elements | Other Elements |
|-------------------------|----------------------------|-----------------------|
| Earnings | System Elements | Rounding Rules |
| Deductions | Arrays | Proration Rules |
| Absence Entitlements | Brackets | Accumulators |
| Absence Takes | Rate Codes | Element Group |
| | Variables | Sections |
| | Dates | Process List |
| | Durations | Generation Control |
| | Formulas | Historical Rules |
| | Counts | |
| | Writable Arrays | |

Understanding Data Retrieval Elements

PeopleSoft delivers some data retrieval elements; you can define others. This topic discusses:

- System elements
- Arrays
- Writable arrays
- Brackets
- Rate codes
- Historical rules

System Elements

System elements are delivered and maintained by PeopleSoft. You never have to change system elements or do anything special to define them. You cannot add system elements; however, you can rename them.

There are two types of system elements:

- Database system elements

Think of database system elements as payee-related elements. They contain data that can be used frequently in a calculation, such as department ID, location, and personal data. Database system elements are resolved only when they are used in a calculation.

- System-computed elements

System-computed elements are populated by the absence process, but are not physical database fields. If, when, and how often a system-computed element is resolved depends on its purpose and type.

For example, Period End Date and Period Type are resolved at the beginning of every segment calculation; daily data, which is used in absence calculations, is calculated daily. Other system-computed elements, such as those that are used with rate codes, are resolved only when a rate code element is encountered in a calculation.

Related Links

[Working with System Elements](#)

Arrays

An array is a link between a field and an element. An array retrieves data that's stored in the database tables that Absence Management does not provide in system elements. You can use arrays to retrieve complex data that's stored in any table outside Absence Management. For example, you can create an array to retrieve birthday data for a payee's dependents from the `DEPENDENT_BENEF` table in PeopleSoft HR.

Arrays are temporary tables that the COBOL programs use to store data during processing. Once processing is complete, the programs write the data from the temporary arrays to the output tables.

Using an array is a two-step process:

1. Retrieve data from the database.
2. Use that data for further processing.

When defining an array, you must provide enough information to the system so that it can perform both steps.

Related Links

[Defining Array Elements](#)

[Arrays Used in Batch Processing \(Technical\)](#)

Writable Arrays

A writable array writes the values of user-defined elements into a row in a table. Writable arrays are in many ways the opposite of standard arrays.

You can use writable arrays to populate your own result tables. You use PeopleSoft Application Designer to create the result table, and then you use the writable array pages in Absence Management to define the element that populates the table during batch processing.

Related Links

[Defining Array Elements](#)

Brackets

Use brackets to look up and retrieve values in a lookup table based on other values.

For example, say that your organization provides absence entitlements based on seniority. You build a bracket that lets you look up the correct entitlement amount based on a payee's years of service.

Note: It is important that you define all of the building blocks that are associated with your lookup rules before you define your bracket.

Related Links

[Defining Bracket Elements](#)

Rate Codes

You use rate codes to resolve multiple components of data. Rate codes retrieve multiple components of data from HR and bring that data into Absence Management.

HR rate codes (HR rate codes) are not automatically resolved in Absence Management. To use the rate code, you set up an absence element in Absence Management and use the rate code element within the definition of that element.

Note: When you define a rate code element in Absence Management, you associate it with a predefined HR rate code. The Absence Management rate code element is automatically created only if the HR rate codes are defined when Absence Management is installed.

Related Links

[Defining Rate Code Elements](#)

Historical Rules

You use historical rule elements to set up rules that retrieve data from prior periods. You can use historical rules in formulas.

A historical rule can be attached to any element that's stored in the Absence Management Accumulator results table, or the Absence Management Element results table.

Related Links

[Defining Historical Rule Elements](#)

Understanding Calculation Elements

You use calculation elements to calculate such elements as formulas, takes, and entitlements.

This topic discusses:

- Variables
- Dates
- Duration
- Formulas
- Rounding rules
- Counts
- Proration rules
- Absence entitlements
- Absence takes
- Accumulators
- Generation control

Variables

You use a variable element to define and store a value such as a character, date, or number. For example, assume that on January 1, you have three formulas and two elements that use a factor of 20 in their

calculations, and that this factor is scheduled to change on April 1 to a factor of 25. Without a variable element, you would have to make five effective-dated changes. However, if you define this factor as a variable element, you make just one effective-dated change to the variable itself. You can then use the new factor of 25 anywhere that the variable is used.

Variables are the only items that are used with arrays. When you create an array, you retrieve the values into variables.

Related Links

[Defining Variable Elements](#)

Dates

Using the date element, you can calculate a date by starting with an existing date and adding to or subtracting from it to come up with a new date. For example, to determine the date for a payee's five years of service, start with the payee's hire date and add five years to it.

You can also parse parts of a date. For example, if you want only the year of a date to be returned, use a date element to parse out the years, months, or days of the date.

Related Links

[Defining Date Elements](#)

Duration

Use a duration element to calculate the period of time between two dates. A duration is the result of subtracting one date from another. You define duration in years, months, or days.

For example, to determine a payee's age, calculate the duration between the payee's birth date and the calendar period end date.

Related Links

[Defining Duration Elements](#)

Formulas

Use formulas to create your own unique elements. You can define sophisticated rules, mathematical formulas, and iterative calculations as formula elements.

For example, you can define a formula to calculate an employee's vacation entitlement.

Related Links

[Defining Formula Elements](#)

Rounding Rules

Use rounding rules to round other elements such as formulas or absence elements that resolve to a numerical value. A rounding rule resolves to 1, if rounding is successful, or 0, if rounding is not successful.

For example, let's say that you define a rounding rule that truncates resolved values to two decimal places. During a calculation, you get a resolved value of 2.833333. The rounding rule truncates the value to 2.83.

You specify whether you want to round based on such factors as the number of digits or decimals, or round to an incremental value. You also select the type of rounding: Nearest, Round Up, Round Down, or Round Up if Greater Than or Equal To, Else Down.

Related Links

[Defining Rounding Rule Elements](#)

Counts

Counts are a way to calculate and summarize something on a daily basis. For example, you might track the number of hours that a payee worked. A count element provides a day-by-day check of the hours worked and keeps adding to the work hours for a defined period of time.

Once you define the calculation rules for a count, you can associate it with a proration rule. When segmentation occurs, the count elements used in the proration rule determine the numerator and denominator to use for prorating amounts.

Related Links

[Defining Count Elements](#)

Proration Rules

You can use a proration rule to prorate a value when segmentation occurs. A proration rule generally works in conjunction with segmentation.

A proration rule defines a numerator and a denominator to apply to an amount during segmentation. A proration rule defines the *from* and *to* dates for a count.

As an example, for a calculation period of June 1–30, with one segment from June 1 to June 10, you define the *numerator* as the time of the segmentation (June 1 to June 10) and the *denominator* as the time of the entire calculation period (June 1 to June 30). Therefore, you set up your formula as 10/30, and the proration rule resolves to .333 (10/30).

Related Links

[Defining Proration Rules](#)

Absence Entitlements

You use absence entitlement elements to track absences such as vacations or leaves of absence. There are two types of absence entitlements:

- Per frequency

The entitlement amount is calculated, regardless of whether there is an absence.

As an example, say that payees receive 12 days of vacation per year and that this entitlement is accumulated at 10 hours per month. This entitlement is a fixed, predetermined amount that is calculated and updated monthly, regardless of whether it is used.

- Per absence

The entitlement amount is calculated only if there is an absence.

Related Links

[Defining Absence Entitlement Elements](#)

Absence Takes

You use an absence-take element to define the conditions that must be met for an absence to be paid. An absence take involves defining rules for minimum and maximum absence takes. You set up absence takes to accumulate in hours, days, or other units.

For example, if your organization gives payees 12 days of vacation each year, and a payee goes on vacation for five days, the absence take for the payee is five days.

Once you've defined your absence take rules on the Absence Take pages, you can track absences by entering them on the Absence Event Entry page.

Related Links

[Defining Absence Take Elements](#)

Accumulators

You use accumulator elements to store and track balances. You can store an accumulator for a designated period of time. For example, you can store absence entitlement balance data for one year. The system can create accumulators automatically (*automatically generated accumulators*) or you can create them manually (*additional accumulators*).

You can add or subtract elements with accumulator members and define begin and end dates.

There are two types of accumulators:

- Segment accumulators, which accumulate values through segment calculation.
- Balance accumulators, which accumulate values over a period of time, such as a month or a year.

You can also define the level at which you want to track a balance. For example, you can track a balance by payee record number, payee ID, department, or organization. You set up the tracking levels that work best for your organization.

Related Links

[Understanding Accumulators](#)

[Automatically Generated Accumulators](#)

Generation Control

You use a generation control element to determine whether an element should be resolved. To define a generation control element, you must specify the criteria that have to be met before the element is processed, based on such factors as HR Status, Action, Frequency, Segment Status, and Formula.

Related Links

[Defining Generation Control Elements](#)

Understanding Organizational Elements

You use organizational elements to define the structure and framework for the system, such as the processing framework (process lists and sections) and organizational structure (element groups).

In the overall-processing framework, the calendar ties the element group (on the payee side) to the section and ties the process list to the process.

This topic discusses:

- Element and eligibility groups.
- Sections.
- Process lists.

Element and Eligibility Groups

Use element groups to create groupings of elements to associate with eligibility groups. You associate eligibility groups with pay groups and list sets.

You define element groups based on your organizational needs. For example, if your organization has a simple absence management system, you might group all entitlement elements into one element group and all take elements into another element group and use the two element group names to specify all entitlements and takes.

Related Links

[Defining Element Groups](#)

Sections

Sections are groups of elements that you add to a process list. Sections tell the system what elements to resolve when processing an absence run and the sequence for resolving them. The order of sections is important because it determines the order in which your elements and calculations are processed.

There are five types of sections:

- Standard, which is used for regular processing.
- Generate Positive Input which is used with Global Payroll.
- Payee, which is used to specify which elements should be processed and in what sequence, at the payee level.
- Sub-Process, which is used for segment calculations and other iterative processes.
- Absence Take, which is used to process absences according to date order.

Related Links

[Setting Up Sections](#)

Process Lists

You use process lists to control the order in which sections are processed during an absence run.

You can create a general or specific process list, based on your organization’s needs.

Related Links

[Functions of Process Lists](#)

[Understanding Process List Setup](#)

Defining Element Types

Page Used to Define Element Types

| <i>Page Name</i> | <i>Definition Name</i> | <i>Usage</i> |
|------------------------------------|------------------------|---|
| Element Types Page | GP_PIN_TYPE | Define element types, such as arrays, brackets, and earnings. You can also define the program ID that’s used to resolve each element. |

Understanding Element Types and Codes

PeopleSoft delivers the data for the Element Types page, which is used in batch processing to resolve the valid element types with the utility program. This table lists the two-character codes and corresponding element types that PeopleSoft delivers:

| <i>Element Type Code</i> | <i>Element Type</i> |
|---------------------------------|-----------------------------|
| AA | Auto Assigned |
| AC | Accumulator |
| AE | Absence Entitlement |
| AR | Array |
| AT | Absence Take |
| BR | Bracket |
| CT | Count |
| DD | Deduction |
| DR | Duration |
| DT | Date |
| EG | Element Group |
| EM | Error Message |
| ER | Earnings |
| FM | Formula |
| GC | Generation Control |
| HR | Manage Historical Data Rule |
| PO | Proration Rule |
| PR | Process |
| RC | Rate Code |
| RR | Rounding Rule |

| <i>Element Type Code</i> | <i>Element Type</i> |
|--------------------------|---------------------|
| SE | Section |
| SY | System Element |
| VR | Variable |
| WA | Writable Array |

You can modify the utility program, but it is recommended that you do not. Instead, create a new element type and utility program to resolve the new element type. Add the new element type and associated programs on the Elements Type page.

Note: If you know an element name, but you don't know what type of element it is, you can find this information on the Element Name inquiry page (**Set Up HCM > Product Related > Global Payroll & Absence Mgmt > Elements > View Element Names**). There is no security on the inquiry page, so users can view all elements on this page.

Element Types Page

Use the Element Types page (GP_PIN_TYPE) to define element types, such as arrays, brackets, and earnings.

You can also define the program ID that's used to resolve each element.

Navigation:

Set Up HCM > Product Related > Global Payroll & Absence Mgmt > System Settings > Element Types > Element Types

This example illustrates the fields and controls on the Element Types page.

The screenshot shows the 'Element Types' page with the following details:

- Element Type:** AE
- Resolution Information:**
 - No Resolution
 - Resolved by Utility Module
- *Program ID:** GPPUENTL
- *Description:** Absence Entitlement
- Short Description:** Abs Entl
- Comment:** (Empty text area with a small icon in the bottom right corner)

| <i>Field or Control</i> | <i>Description</i> |
|-------------------------|--|
| Element Type | Displays the element type value that you selected in the entry dialog box. |

Resolution Information

| <i>Field or Control</i> | <i>Description</i> |
|-----------------------------------|---|
| No Resolution | Select if you don't want the element resolved. In this case, the element that is associated with the element type is just a point of reference. For example, a pay group is a collection of elements and never resolves to a value. This option is used in batch processing. The PIN manager checks the element type to determine whether any resolution is needed. |
| Resolved by Utility Module | Select if you want the element that is associated with the element type to be resolved by a utility program that is delivered by PeopleSoft or created by you. |
| Program ID | <p>Select the utility program that is used to resolve each element. Program ID data is delivered by PeopleSoft.</p> <p>When a batch that is running encounters an array element, the process first looks to see which program should be called to resolve the element. This field provides a link for batch processing between an element type and the utility program that is to be used to resolve that element type.</p> <hr/> <p>Note: If you selected <i>No Resolution</i> in the Resolution Information group box, this field is unavailable for entry.</p> <hr/> |

Defining Entry Types

Page Used to Define Entry Types

| <i>Page Name</i> | <i>Definition Name</i> | <i>Usage</i> |
|-------------------------|------------------------|--|
| <u>Entry Types Page</u> | GP_ENTRY_TYPE | Enter entry types and define unique groupings of elements. |

Understanding Entry Types

Elements can use other elements. Sometimes there are restrictions on the types of elements that you can use in certain places. To restrict the entry types that are entered into an element definition, you use the Entry Types page.

Entry types can be elements, but they don't have to be. For example, an entry type can be an element name, an amount, or a date. You use entry types to determine what you're going to enter initially. The information from the Entry Types page is stored for every element.

For example, let's say that you have an entitlement (ENTITLEMENT1) with a calculation rule that is defined as ENTITLEMENT1 = Amount. Because it's defined as an amount, entry types for ENTITLEMENT1 can include numeric variables, numeric formulas, and numeric values, but you cannot enter a date in the amount field.

You use the Entry Types page mainly to associate a corresponding prompt view to use if the entry type is selected online. For each entry type that's defined, you associate a prompt view with it. For some entry types, you also associate additional, special prompts to be used for security and override areas (related to the Override fields on the Element Name page). Entry type prompts are closely related to entry types. Use an entry type prompt to indicate the entry types for a field in the application. The entry type prompts are then used and attached through Absence Management so that only those entry types are available. Based on the entry type that you selected, you go to the prompt views that are indicated for that entry type to get a list of elements to select from.

Entry Types Page

Use the Entry Types page (GP_ENTRY_TYPE) to enter entry types and define unique groupings of elements.

Navigation:

Set Up HCM > Product Related > Global Payroll & Absence Mgmt > System Settings > Entry Types > Entry Types

This example illustrates the fields and controls on the Entry Types page.

Entry Types

Entry Type **AE0**

*Description

Short Description

*Value Type

Prompt View Name

Prompt Views for Element Security and Overrides

| | |
|---|--|
| Calendar <input style="border-bottom: 1px solid black;" type="text" value="GP_PIN_AE0CL_VW"/> | Payee <input style="border-bottom: 1px solid black;" type="text" value="GP_PIN_AE0PY_VW"/> |
| Pay Entity <input style="border-bottom: 1px solid black;" type="text"/> | Positive Input <input style="border-bottom: 1px solid black;" type="text"/> |
| Pay Group <input style="border-bottom: 1px solid black;" type="text"/> | Via Element <input style="border-bottom: 1px solid black;" type="text" value="GP_PIN_AE0EL_VW"/> |
| Element Definition <input style="border-bottom: 1px solid black;" type="text"/> | |

| <i>Field or Control</i> | <i>Description</i> |
|-------------------------|---|
| Value Type | Select the type of field that appears on a page when an entry construct is used. Values are: <i>Character</i> , <i>Date</i> , <i>Element Name</i> , <i>Integer</i> , <i>Not Applicable</i> , and <i>Numeric</i> . If you select <i>Element Name</i> , you can enter information into the Prompt Views for Element Security and Overrides group box. For all other values, this group box is unavailable for entry. |
| Prompt View Name | Displays the value that appears in the Valid Entry Type field on the Entry Type Prompts page. Instead of hard-coding the values in the view text, the system controls the prompt by defining the values on the Entry Types page. |

Prompt Views for Element Security and Overrides

| <i>Field or Control</i> | <i>Description</i> |
|--|---|
| Calendar, Payee, Pay Entity, Positive Input, Pay Group, Via Element, and Element Definition | These fields are related to the Override Levels check boxes on the Element Name page. You can enter overrides at various levels and control additional security in prompt views. For example, if you are on the Pay Entity page, the system looks for the Pay Entity prompt view first (instead of the prompt view name). All eight prompt views (including the prompt view name and the seven prompt views in this group box) have the same purpose, but are coded differently. The prompt views in this group box also look at the security check boxes on the Element Name page. |

Selecting Entry Types and Displaying Record.Field Combinations

Pages Used to Select Entry Types and Display Record.Field Combinations

| <i>Page Name</i> | <i>Definition Name</i> | <i>Usage</i> |
|--------------------------------|------------------------|--|
| <u>Entry Type Prompts Page</u> | GP_ENTRY_PROMPT | Define which entry types are valid for a specific prompt view. View a list of all entry types for an entry prompt ID. Complete the Entry Types page prior to using this page. |

| Page Name | Definition Name | Usage |
|------------------------------------|------------------------|---|
| Record.Fields using Prompt ID Page | GP_ENTRY_PROMPT_VW | Displays the record.field combinations for the entry prompt ID. This page references the Entry Type Prompts page, providing an easy way to view the database fields that use this prompt. To change an entry type, check this page first to see which record.field combinations will be affected. |

Understanding Prompt Views

Prompt views are associated with an entry type to determine the list of valid values available in a field. Usually, before you select an actual element, you are prompted to select the entry type itself. This entry type is used to define what type of element is going to be used or whether a character, numeric, date, and so on is to be used. Based on the entry type that you select, you can prompt correctly on the next field.

For example, when you select a calculation rule on the Earning - Calculation page, the corresponding entry type fields appear on the page. If the calculation rule is Amount, you see two fields next to the Amount label: the first is the entry type and the second is the actual selection. The **Entry Type** field might display values of *Numeric*, *Accumulator*, *Bracket*, *Deduction*, *Earning*, *Formula*, *Payee Level*, *Rate Code*, and *Variable*, all of which are entry types. For example, if you select *Variable*, when you press the **tab** key to move out of the field and you prompt against the second field, only the variables appear as valid values. (If you had selected *Bracket*, only brackets would appear as valid values.)

For the example of an earning definition, if the calculation rule is Amount, an entry prompt ID, *GP_ENT_AMT_VW*, is defined. For this entry prompt ID, you have indicated (by selecting the Valid Entry Type check boxes) that the following entry types are valid: *Numeric*, *Accumulator*, *Bracket*, *Deduction*, *Earning*, *Formula*, *Payee Level*, *Rate Code*, and *Variable*. These are the valid entry types that appear when you prompt on the Earning - Calculation page for the **Amount Entry Type** field.

Entry Type Prompts Page

Use the Entry Type Prompts page (GP_ENTRY_PROMPT) to define which entry types are valid for a specific prompt view.

View a list of all entry types for an entry prompt ID. Complete the Entry Types page prior to using this page.

Navigation:

Set Up HCM > Product Related > Global Payroll & Absence Mgmt > System Settings > Entry Type Prompts

This example illustrates the fields and controls on the Entry Type Prompts page.

Entry Type Prompts

Entry Prompt ID *Description

[Records.Fields Using Prompt ID](#)

| Entry Types | | | |
|-------------|----------------------|-------------------------------------|----------------------|
| Entry Types | Calendar/Via Element | Pay Entity/Pay Group | Positive Input/Payee |
| 001 | Character | <input type="checkbox"/> | |
| 002 | Numeric | <input type="checkbox"/> | |
| 003 | Calendar Date | <input type="checkbox"/> | |
| AA0 | Auto Assigned | <input type="checkbox"/> | GP_PIN_AA0_VW |
| AC0 | Accumulator | <input type="checkbox"/> | GP_PIN_AC0_VW |
| AC4 | Segment Accumulator | <input type="checkbox"/> | GP_PIN_AC4_VW |
| AE0 | Absence Entitlement | <input type="checkbox"/> | GP_PIN_AE0_VW |
| AE5 | Absence Entitlement | <input checked="" type="checkbox"/> | GP_PIN_AE5_VW |
| AR0 | Array | <input type="checkbox"/> | GP_PIN_AR0_VW |
| AT0 | Absence Take | <input checked="" type="checkbox"/> | GP_PIN_AT0_VW |

You use the Entry Type Prompts page to define which entry types are valid for a specific prompt view. You select which Entry Types are valid and entered wherever this entry prompt ID is used.

Calendar, Payee, Pay Entity, Positive Input, Pay Group, Via Element, and Element Definition are related to the Override Levels check boxes on the Element Name page. You enter overrides at various levels to control additional security within prompt views. For example, if you are on the Pay Entity page, the system looks for the Pay Entity prompt view first instead of the prompt view name. So, all eight prompt views (including Prompt View Name and the seven prompt views found in the Prompt Views for Element Security/Override group box) have the same purpose, but they are coded a little differently. The prompt views in the Prompt Views for Element Security/Override group box also look at the security check boxes on the Element Name page. You select entry types for the entry prompt ID that you want to look at on the Entry Type Prompts page. You use entry type prompt IDs to create and maintain valid entry type prompt views. Entry types are not hard-coded in the prompt views.

Common Page Information

| <i>Field or Control</i> | <i>Description</i> |
|--------------------------------------|---|
| Record.Fields Using Prompt ID | Click to access the Record.Fields Using Prompt ID page. |

| Field or Control | Description |
|-------------------------|--|
| Entry Type | Displays information from the Entry Types page. You can select entry type for each entry prompt ID. For example, let's say that you have an entitlement element (ENTITLEMENT1). Valid entry types for the element can include <i>Numeric</i> and <i>Accumulator</i> . Select the check box associated with any of the valid entry types. If the Valid Entry Type check box is selected, the entry type appears as a valid value on the prompt. Based on the entry type that you select, the system returns to the corresponding entry type definition in the Prompt View Name field on the Entry Types page. |

Calendar/Via Element Tab

Select the Calendar/Via Element tab.

This example illustrates the fields and controls on the Entry Type Prompts page: Calendar/Via Elements tab.

Entry Type Prompts

Entry Prompt ID *Description

Records.Fields Using Prompt ID

Entry Types Personalize | Find | View All | | First 1-10 of 65 Last

Entry Types
Calendar/Via Element
Pay Entity/Pay Group
Positive Input/Payee
Element Definition

| Entry Type | Description | Calendar | Via Element |
|------------|---------------------|-----------------|-----------------|
| 001 | Character | | |
| 002 | Numeric | | |
| 003 | Calendar Date | | |
| AA0 | Auto Assigned | | GP_PIN_AA0EL_VW |
| AC0 | Accumulator | | GP_PIN_AC0EL_VW |
| AC4 | Segment Accumulator | | |
| AE0 | Absence Entitlement | GP_PIN_AE0CL_VW | GP_PIN_AE0EL_VW |
| AE5 | Absence Entitlement | GP_PIN_AE5CL_VW | |
| AR0 | Array | | |
| AT0 | Absence Take | GP_PIN_AT0CL_VW | GP_PIN_AT0EL_VW |

This tab pertains to calendar and via element overrides.

The prompt view name and the prompt views that appear on the Calendar/Via Element, Pay Entity/Pay Group, Positive Input/Payee, and Element Definition tabs are related displays, based on information that you entered on the Entry Types page (for each defined entry type). When you use these online, you are first prompted to select an entry type, and then (based on the entry type that you selected) you enter the second field.

For example, if you select an entry type of *Variable* for the **Earnings Amount** field, when you press **tab** to move out of that field and prompt on the next field, the system locates the prompt view name. The system uses that as the prompt for the next field; therefore, only variables appear.

The functionality of the prompts that are defined on these tabs is similar to the prompt view names. The difference is that the Override check boxes on the Element Name page (Pay Calendar, Pay Entity, Pay Group, Payee, Positive Input, Element Definition, and Via Element) are used to control where in the system you can override the element. You notice that on these tabs, you can define separate prompt views for each entry type. These views are defined just to take the Override check boxes on the Element Name page into consideration.

So, based on where you are in the system, you use either the prompt view name or the correct override prompt view name to prompt for valid values in the second field.

Pay Entity/Pay Group Tab

Select the Pay Entity/Pay Group tab.

This tab pertains to pay entity and pay group overrides.

Positive Input/Payee Tab

Select the Positive Input/Payee tab.

This tab pertains to positive input and payee overrides.

Element Definition Tab

Select the Element Definition tab.

This tab pertains to element definition overrides.

Defining Industries and Categories

Pages Used to Define Industries and Categories

| <i>Page Name</i> | <i>Definition Name</i> | <i>Usage</i> |
|-------------------------|------------------------|---|
| Industries/Regions Page | GP_PIN_INDUSTRY | Define industry and region codes that help classify elements and supporting elements. |
| Categories Page | GP_PIN_CATEGORY | Define category codes that help classify elements and supporting elements. |

Related Links

[Defining Element Names](#)

[Restricting User Access](#)

Understanding Industries and Categories

Industries and categories are ways to further classify elements. You create codes for the industries and categories that are applicable to your organization. For each code, you specify if it is applicable to all countries or a specific country.

You can view all industry and category codes through the Industries/Regions and Categories pages. Your security level, as defined on the User Rules Profile page, determines the countries for which you can add industries and categories.

You associate an industry and category with an element by selecting from prompt tables on the Element Name page. The country for which an element is defined determines the available industry and category codes.

Note: You cannot change or delete existing industry codes or categories because they are also entered in the GP_PIN table. Updating the Industries/Regions or the Categories page does not update the GP_PIN table.

Defining Element Names

Pages Used to Define Element Names

| <i>Page Name</i> | <i>Definition Name</i> | <i>Usage</i> |
|---|------------------------|---|
| Earnings Name Page | GP_PIN | Name an element and define its basic parameters. |
| Element Name - Custom Fields Page | GP_PIN_CUSTOM_SEC | Add user-defined fields to an element definition. |
| Comments for Element <Name> Page | GP_PIN_SEC | Enter or review detailed comments for an element. The comments that you enter are for informational purposes only and do not affect absence processing. |
| Forecasting for Element <Name> Page | GP_FORECAST_SEC | Select forecasting options for an element. |

Understanding Element Names

Although each element type has a unique purpose, all element types share a common set of attributes that are defined and stored on the first page of each element component. The object name of this page is always GP_PIN and it appears as the first page for all element definitions. The Element Name page is often labeled to identify the element type that is being created—for example, *Earnings Name*. Once you define an element name, you can enter additional information that is specific to the element type.

Understanding PIN Codes and Element Name Numbers

When you create an element name, the system assigns the element a PIN code and a Element Name number. The PIN code and the element name must be unique. As you create new elements, the system checks to see whether this unique set of identifiers already exists. You can rename an element name, but the PIN code is a constant.

Element Name numbers:

- Enable the system to track the element and its name wherever it's used, regardless of its name.

You can change an element name without affecting the system.

- Point to the data and the element name on the Element Name page.
- Are significant only within a database and can be different for the same element names across databases.
- Act as keys to the GP_PIN table and the value that is stored in other tables to represent an element.
- Are assigned sequentially.
- Are used only for batch-processing.

Related Links

[Understanding the Absence Management Utilities](#)

Understanding the Process of Selecting Definition As Of Dates

Elements can have many effective-dated rows. The definition as of date that you assign to an element on the Element Name page tells the system which effective-dated definition to retrieve for the element during processing.

You can select one of these dates: Calendar Period Begin Date, Calendar Period End Date, Payment Date, Process Begin Date, and Process End Date.

Note: You can override the process begin date and process end date for a payee and calendar group by using the Payee Calendar Groups page.

Example 1

Assume that an element has the following effective-dated rows (definitions) and values:

January 1, 1990 = 100

January 1, 2000 = 125

January 31, 2000 = 150

February 1, 2000 = 175

The January and February calendars have the following dates:

| Calendar Date | January Calendar | February Calendar |
|----------------------|-------------------------|--------------------------|
| Begin Date | January 1, 2000 | February 1, 2000 |
| End Date | January 31, 2000 | February 28, 2000 |

When you process the January calendar, the system retrieves the definition of the element based on the element’s definition as of date:

| Definition As Of Date | Effective-Dated Row Used | Value |
|------------------------------|---------------------------------|--------------|
| Calendar Begin Date | January 1, 2000 | 125 |
| Calendar End Date | January 31, 2000 | 150 |

Example 2

Process Begin Date and Process End Date can be especially useful for issuing advance payments. They refer to the begin date and end date of the calendar period in which the element is actually processed.

For example, suppose that in January you want to issue an advance payment to a payee who will be on vacation in February. To make the advance payment, you process the February calendar in January; however, you want the system to use the definition of the element as of January—the actual processing period.

This table shows which definition of the element the system retrieves, based on your choice of definition as of date:

| Definition As Of Date | Effective-Dated Row Used | Value |
|------------------------------|---------------------------------|--------------|
| Process Begin Date | January 1, 2000 | 125 |
| Process End Date | January 31, 2000 | 150 |
| Calendar Begin Date | February 1, 2000 | 175 |
| Calendar End Date | February 28, 2000 | 175 |

Related Links

[Entering Calendar Override Instructions for a Payee](#)

Earnings Name Page

Use the Earnings Name page (GP_PIN) to name an earnings element and define its basic parameters.

Navigation:

Set Up HCM > Product Related > Global Payroll & Absence Mgmt > Elements > Payroll Elements > Earnings > Earnings Name

This example illustrates the fields and controls on the Earnings Name page.

Note: The preceding example is a generic representation of the page that you use to create all element types. After you create an element on the Earnings Name page, you continue the process of defining each element in its appropriate component, as described elsewhere in this documentation.

| Field or Control | Description |
|-------------------------|---|
| Field Format | <p>Defines the format for the resolved value. Available values are based on the element type and can include <i>Date</i>, <i>Decimal</i>, <i>Character</i>, <i>Monetary</i>, or <i>Pointer</i> (for calculating generic formulas for a variable).</p> <p>For some element types you cannot change the displayed field format.</p> <hr/> <p>Note: The difference between <i>Decimal</i> and <i>Monetary</i> is that <i>Monetary</i> is currency-controlled and requires the entry of a currency code.</p> |

| Field or Control | Description |
|-------------------------------------|--|
| Definition As Of Date | <p>Select the date on which the system is to retrieve the element definition during a process run. Options are:</p> <p><i>Calendar Period Begin Date:</i> The begin date of the calendar period to which the element is linked.</p> <p><i>Calendar Period End Date:</i> End date of the calendar period to which the element is linked.</p> <p><i>Payment Date:</i> Payment date of the calendar period to which the element is linked.</p> <p><i>Process Begin Date:</i> Begin date of the calendar period in which the element is processed.</p> <p><i>Process End Date:</i> End date of the calendar period in which the element is processed.</p> <p>Selections are limited for some elements. For example, <i>Calendar Period End Date</i> is the only valid option for section and process list elements.</p> <p>Retroactivity is also a consideration for this field. During recalculation, the system always respects this day and uses the appropriate date based on individual recalculation period calendars.</p> |
| Element Nbr (element number) | The Element Name number. |

| Field or Control | Description |
|---------------------------|---|
| Always Recalculate | <p>Applies only to the period of time that is being resolved and is selected by default. If selected, the system recalculates the element every time that it encounters it in the calculation process. If this check box is clear, the system uses the previous resolved value of the element.</p> <p>Clear the check box when:</p> <ul style="list-style-type: none"> You update an element through an element-like formula. <p>Otherwise, each time that the system encounters the element, it initializes it according to the element's definition.</p> <ul style="list-style-type: none"> You think that the old value will be different from the value that you'll get if the system resolves this element again—for example, when a variable has been set up with a Via Element override on the Element Name page. <p>Select this check box if you think that the previous value is incorrect and needs to be updated—for example, in formulas that need to be applied within a loop, an array, or a count.</p> <hr/> <p>Note: If this check box is clear, and the Recalculate check box on the Section - Definition page is selected, the system resolves the element each time that it encounters it (when that section is processed). If the same element is encountered in a different section, where the check box is clear, the element is resolved only once.</p> <hr/> <p>When the PIN Manager encounters an element, it runs an eligibility check. If it determines that the element must be resolved, it looks at the recalculation logic. You can indicate an element's recalculation at the process list level, the section level, and the element level. If you indicate recalculation at any of these levels, the element is recalculated.</p> <p>For example, if the Always Recalculate check box is selected, the system recalculates the element. If the Always Recalculate check box is clear, the system looks at the table of resolved elements for a match between the same element and the same calculation dates. If there is a match, the system uses that value; otherwise, the system resolves the element.</p> |

See [Understanding the Process of Selecting Definition As Of Dates](#).

Element Use

In this group box, you define several security-related options.

| Field or Control | Description |
|-------------------------|---|
| Owner | <p>Identifies who controls and maintains the definition of the element. Values are:</p> <p><i>Customer Maintained:</i> Identifies the elements that you created. All fields are available for entry.</p> <p><i>PS Delivered/Maintained:</i> The element is delivered and maintained by PeopleSoft. To edit any fields, you can take control of the element by selecting the Customer Control Indicator check box. This changes the owner to <i>PS Delivered/ Customer Modified</i>. If PeopleSoft later releases an updated version of the element, you can accept the updated definition or retain your changes. Either way, element ownership does not change.</p> <p>If you change the name, description, override levels, class, industry, or category for an earning, deduction, or absence element, the system makes the same changes to all related components and auto generated accumulators and changes the owner for those items.</p> <hr/> <p>Important! Taking control of an element is irreversible.</p> <hr/> <p><i>PS Delivered/Not Maintained:</i> The element is delivered, but not maintained by PeopleSoft (for example, sample data or statutory data). You can update any editable fields.</p> <p><i>PS Delivered/Customer Modified:</i> Indicates that you have taken control of a PeopleSoft-delivered or maintained element.</p> <p><i>PS Delivered/Maintained/Secure:</i> The element is delivered and maintained by PeopleSoft. You can edit the name, description, override levels, results, custom fields, and comments (and for system elements, Use as Chartfield and prompt view). Any changes that you make can be overwritten by future PeopleSoft updates.</p> |

| Field or Control | Description |
|-------------------------|--|
| Class | <p>Indicates the type of rule for the element. Values are:</p> <p><i>Customary:</i> Sample rules that are created by PeopleSoft. They are not statutory requirements, but are commonly followed rules. An example of when a customary rule is used is with tariffs. Customary rules are often used in a production environment.</p> <p><i>Not Classified.</i></p> <p><i>Sample Data:</i> Rules that are created by PeopleSoft for sample data purposes. They are not used in a production environment.</p> <p><i>Statutory:</i> Rules that are created by PeopleSoft for calculating rules that are required by law.</p> <p><i>System Data:</i> Rules that are created by PeopleSoft. They are either system elements or system data that are delivered with the application—for example, common constants and dates.</p> <p>The Class field works with the Owner field to determine the level of support and security.</p> <hr/> <p>Note: Not all statutory rules are set to <i>PS Delivered/Maintained</i>. For some statutory rules, the owner is set to <i>PS Delivered/Not Maintained</i>. Typically these rules are statutory, but might need to be modified for organization-specific information.</p> |
| Used By | <p>Select whether the element is used by <i>All Countries</i> or a <i>Specific Country</i>. This field is also used in User Rules Profile security to determine which elements a user can access.</p> |
| Country | <p>If you selected <i>Specific Country</i> in the Used By field, the Country field appears. Select the country for which the security-related options apply.</p> <hr/> <p>Note: Element usage security is a way to limit the number of elements that you see on a prompt so that you see only the element information that's useful to you. You can check element usage security with the Used By and Country fields.</p> |
| Industry/Region | <p>To classify your element further, select an industry code or region code. You define industry codes on the Industry/Region Types page. If an element is created for a specific industry, select an industry code here. Typical industry codes include Banking, Insurance, and Metallurgy.</p> |

| Field or Control | Description |
|-----------------------------------|--|
| Category | To classify your element further, select a category code. Category codes are defined on the Categories page (GP_PIN_CATEGORY). |
| Customer Control Indicator | Appears only if you have authority to take control of the element according to the user profile rules. See the Owner field. |

See [Restricting User Access](#).

Override Levels

In this group box, you enable security-related override levels for the selected element. That is, you define when users can override the element's value, or, in some cases, exclude the element from processing. For example, if you select **Pay Calendar**, you can use the Calendar - Excluded Elements page to tell the system not to process this element for any payee associated with a particular calendar. If you select **Pay Calendar** for a bracket, date, duration, formula, or variable element, you can use the Calendar - Overrides page to have the system use an override value for the element when the system processes a particular calendar.

| Field or Control | Description |
|--|---|
| Pay Entity, Pay Group, Payee, Calendar, Via Elements, Element Definition and Positive Input | Select each type of override that you want to enable. Options vary by element type. |

See [Understanding Overrides](#).

Results

In this group box, you specify when to store the resolved value of the element in the result tables. The options vary by element type.

Select these options with caution to avoid creating large tables that are difficult to manage. Consider storing only the values that you need for reporting and auditing purposes or for retroactivity or other situations where you need to refer to the prior value of an element.

| Field or Control | Description |
|-------------------------|---|
| Store | Select to store the resolved value of the element in the result table during processing. For certain element types, you can specify the conditions under which the value is stored by selecting an option below the check box. When Store is clear, the resolved value is never stored. |

| Field or Control | Description |
|--|---|
| Always | This option (the default) appears only for earning and deduction elements. Select it to store the calculated result of the element, even when the value is 0. |
| If Element Is Non-Zero | Appears only for earning and deduction elements. Select it to store the resolved value of the element when it is not 0. |
| If Element or Comp is Non-Zero (if element or component is nonzero) | <p>Appears only for earning and deduction elements. Select the option if you want to store the resolved value of the element if it or one of its components (percent, base, rate, or unit) is nonzero.</p> <p>With this option, the element or component values are always stored if the arrears balance, the amount being paid back, the amount not taken, the adjustment value, or the retroactive adjustment value is nonzero.</p> |
| Store if Zero | <p>Appears for all element types except earnings and deductions. You cannot select this check box without first selecting Store.</p> <p>The Store if Zero check box is a way to further define what is sent to the results tables.</p> <p>Select Store if Zero to store a resolved value even when the value is 0.</p> <p>If you select Store but not Store if Zero, the element is written to the result tables only if the resolved value is not equal to zero, blank, or null. If you select both check boxes, the resolved value is written to the result tables, even if it is zero, blank, or null. If you select neither check box, the system never stores the resolved value.</p> |

Resolution Parameters

The fields in this group box apply only to earning and deduction elements.

See [Earnings Name Page](#).

Version Information

| Field or Control | Description |
|-------------------------|--|
| User Version | <p>You can enter up to 14 alphanumeric characters in this field to identify changes you make to the element definition. When you save the definition, the system adds a prefix of <i>INT_</i> to indicate that this is a user-defined value. You can use the Absence Management utilities to stamp and package elements by version.</p> <p>The value that you enter here appears in the Version field of the pages that you update.</p> |
| Version | <p>Displays the version of the element. The prefix <i>P_</i> identifies versions released by PeopleSoft. The prefix <i>C_</i> identifies versions created by customers.</p> <p>The system clears the version from this page when any of the following conditions occur:</p> <ul style="list-style-type: none"> • You save the page after making changes. (The version is cleared only on the page that you make corrections to.) • You enter a value in the User Version field and save the page. (The version is cleared only on the page to which you make corrections.) • You run the Stamping process for the element. In this case, the element is stamped with the new version. |

Additional Elements

| Field or Control | Description |
|-------------------------|--|
| Custom Fields | Click this link to access the Element Name - Custom Fields page. |
| Comments | Click this link to access the Element Name - Comments page. |
| Forecasting | This link appears for absence take and absence entitlement elements only. Click this link to access the Element Name - Forecasting page. |

Related Links

[Stamping and Packaging Elements by Version](#)

Element Name - Custom Fields Page

Access the Element Name - Custom Fields page (click the **Custom Fields** link on the Element Name page).

Use the fields on this page in any way that you want. For example, you can use the fields to classify elements or to indicate a sorting order for reports. The data that you enter is stored by system elements.

Comments for Element <Name> Page

Use the Comments for Element <name> page (GP_PIN_SEC) to enter or review detailed comments for an element.

The comments that you enter are for informational purposes only and do not affect absence processing.

Navigation:

Click the **Comments** link on the Element Name page.

For each system-computed system element that is delivered by PeopleSoft, you can view detailed comments including a general description, when the system element is available, and where it is used. This is useful information when you want to learn about what a specific system element does.

For elements that you define, you can use the Comments page to view or enter your own notes or details about an element.

Forecasting for Element <Name> Page

Use the Forecasting for Element <name> page (GP_FORECAST_SEC) to select forecasting options for an element.

Navigation:

Click the **Forecasting** link on the Element Name page. Available for absence take and absence entitlement elements only.

This example illustrates the fields and controls on the Element Name – Forecasting for Element <name> page.

Forecast Secondary Page

View Element Names

Forecasting for Element SICK ABS(Sick leave)

Forecasting

Forecasting Used

Forecasting Required

| <i>Field or Control</i> | <i>Description</i> |
|-----------------------------|---|
| Forecasting Used | <p>Select to enable the absence forecasting or balance inquiry feature for this element. This field also enables forecasting configuration under the take definition element as well as under Absence Management forecasting rules. It does not enable forecasting in Absence self service applications nor in Timesheets.</p> <p>See Defining Forecasting Rules for Self Service Absence Requests.</p> |
| Forecasting Required | <p>This field appears for absence take elements only. Select to have the system generate a warning if a user tries to save absence entries on the Absence Event Entry page without first running the Forecasting process.</p> <hr/> <p>Note: This field only applies to the Absence Event Entry page. To set up forecasting required for absence self service and Time and Labor Timesheets use the Forecasting page.</p> <hr/> <p>See Defining Forecasting Rules for Self Service Absence Requests.</p> |

Updating Component Element Information

Page Used to Update Component Element Information

| <i>Page Name</i> | <i>Definition Name</i> | <i>Usage</i> |
|---------------------------------|------------------------|---|
| Components Page | GP_PIN | Update information about component elements (such as rate, unit, base, and percent) that are generated when an earning, deduction, or absence entitlement element is created. |

Components Page

Use the Components page (GP_PIN) to update information about component elements (such as rate, unit, base, and percent) that are generated when an earning, deduction, or absence entitlement element is created.

Navigation:

Set Up HCM > Product Related > Global Payroll & Absence Mgmt > Elements > Supporting Elements > Components > Components

This example illustrates the fields and controls on the Components page.

On this page, only the **Description** field, the **Via Elements** check box, the **Custom Fields** link, and the **Comments** link are available for entry or selection.

All other fields are updated when the parent element value changes. (A *parent element* is an earning element, a deduction element, or an absence entitlement element.) These fields display the values that were entered for the parent element when it was created.

Override Levels

| <i>Field or Control</i> | <i>Description</i> |
|-------------------------|---|
| Via Elements | Select to indicate the override level for the component, if there is one. |

Related Links

[Element Name - Custom Fields Page](#)

[Understanding Overrides](#)

Defining Suffixes

Page Used to Define Suffixes

| <i>Page Name</i> | <i>Definition Name</i> | <i>Usage</i> |
|----------------------------------|------------------------|---|
| <u>Absence Entitlements Page</u> | GP_SUFFIX2 | Define suffixes for absence elements in the base language that you've selected. |

Understanding Suffixes

Absence Management uses suffixes to identify the components and auto-generated accumulators created for earning, deduction, and absence elements. For example, when you define an earning, deduction, or absence element, you must specify the components that make up the element, such as base, rate, unit, and percentage. The system *names* these components and auto-generated accumulators by appending a suffix to the element's name. For example, suppose that you define an earning element named EARN1 with this calculation rule: $EARN1 = Rate \times Unit$. The system automatically creates two additional elements for the components in the calculation rule:

- Rate element: EARN1_RATE
- Unit element: EARN1_UNIT

In this example, the suffixes used to name the components of the element are RATE and UNIT.

PeopleSoft delivers suffixes, but you can also create your own suffixes. Suffixes are defined by country, so you can define element components in your native language.

The system determines the suffix names to use, based on the country that is identified in the *Used By/ Country* fields on the Element Name page. If an element is defined as *All Countries* in the *Used By/ Country* fields, the system determines the correct suffix by identifying the entry on the Suffix page that has the *Default Country* check box selected.

Note: When you create an element, the system creates only the suffixes and components that are needed. For example, if you create an earning element and define it as $EARNINGS1 = Unit \times Rate$, the system creates suffixes only for the unit and the rate.

Note: You can only add, modify, and delete suffixes on the Element Suffixes (GP_SUFFIX) component that apply to elements defined for your own country or *All* countries.

Absence Entitlements Page

Use the Absence Entitlements page (GP_SUFFIX2) to define suffixes for absence elements in the base language that you've selected.

Navigation:

Set Up HCM > Product Related > Global Payroll & Absence Mgmt > System Settings > Element Suffixes > Absence Entitlements

This example illustrates the fields and controls on the Absence Entitlements page.

The screenshot shows the 'Absence Entitlements' page with the following fields and controls:

- Element Suffixes:** Country (ALL, All Countries), Suffix Separator (_), Find, View All, First (1 of 21), Last, and a checked checkbox for Default Suffix Set.
- Component Suffixes:** *Unit Paid (UNP) and *Unit Adjustment (UNAD).
- Accumulator Suffixes:** *Balance (BAL), *Entitlement (ENT), *Adjustment (ADJU), and *Take (TAKE).

Component Suffixes and Accumulator Suffixes

| <i>Field or Control</i> | <i>Description</i> |
|--------------------------------------|---|
| Unit Paid and Unit Adjustment | Define the suffixes to be appended to the components and accumulators that the system generates for absence entitlement elements. |

Related Links

[Absence Entitlements - Auto Generated Accumulators Page](#)

Copying Elements

Pages Used to Copy Elements

| <i>Page Name</i> | <i>Definition Name</i> | <i>Usage</i> |
|---|------------------------|---|
| Element Copy Configuration Page | GPSC_ECPY_CIDTL | Associate component interfaces with element types that can be copied. |
| Component Interface Collection Items Sequence Override Page | GPSC_ECPYCICOL_SEC | Configure the sequence numbers for collection fields. |
| Element Copy Page | GPSC_ECPY_MAIN | Copy existing elements. |

Understanding Copying Elements

Element creation is a fundamental and basic activity for PeopleSoft Global Payroll and PeopleSoft Absence Management. Depending on the type of element you are creating, you are required to define a

wide variety of parameters. The general parameters of all elements, however, tend to follow a standard structure. Entering all of this similar information for each new element can be extremely time consuming. The Element Copy component enables you to create new elements by copying existing elements, thereby completely avoiding most of the manual element configuration steps.

Related Links

- [Understanding Elements](#)
- [Understanding Absence Element Setup](#)
- [Understanding Accumulators](#)
- [Understanding Calculation Elements](#)
- [Understanding Data Retrieval Elements](#)
- [Understanding Earning and Deduction Elements](#)
- [Understanding Organizational Elements](#)
- [Understanding Processing Elements](#)



Element Copy Configuration Page

Use the Element Copy Configuration page (GPSC_ECPY_CIDTL) to associate component interfaces with element types that can be copied.

Navigation:

Set Up HCM > Product Related > Global Payroll & Absence Mgmt > Elements > Element Copy Configuration

This example illustrates the fields and controls on the Element Copy Configuration page.

| Element Copy Configuration | | | | | | | Personalize Find   | | First | 1-10 of 10 | Last |
|----------------------------|---------------------------|--------------------|----------------|------------------------------|--------------------|-----|--|--|-------|------------|------|
| *Element Type | *Component Interface Name | Message Set Number | Message Number | *Copy Options | | | | | | | |
| Accumulator | GPSC_ACCUMULATOR_CI | 0 | | 0 - None | Collection Details | + - | | | | | |
| Absence Entitlement | GPSC_ABS_ENTL_CI | 0 | | 1 - Auto Gen. Accumulators | Collection Details | + - | | | | | |
| Absence Take | GPSC_ABS_TAKE_CI | 0 | | 0 - None | Collection Details | + - | | | | | |
| Bracket | GPSC_BRACKET_CI | 17340 | 202 | 0 - None | Collection Details | + - | | | | | |
| Deduction | GPSC_DEDUCTION_CI | 0 | | 3 - Both Auto Gen. & Members | Collection Details | + - | | | | | |
| Element Group | GPSC_ELEMENT_GROUP_CI | 0 | | 0 - None | Collection Details | + - | | | | | |
| Earnings | GPSC_EARNING_CI | 0 | | 3 - Both Auto Gen. & Members | Collection Details | + - | | | | | |
| Formula | GPSC_FORMULA_CI | 17340 | 201 | 0 - None | Collection Details | + - | | | | | |
| Process | GPSC_PROCESS_CI | 0 | | 0 - None | Collection Details | + - | | | | | |
| Section | GPSC_SECTION_CI | 0 | | 0 - None | Collection Details | + - | | | | | |

Note: Customers cannot edit the setup for the delivered element types.

| Field or Control | Description |
|---------------------------------|--|
| Element Type | <p>Select the type of element that you want to configure for copying.</p> <p>PeopleSoft Global Payroll and Absence Management delivers element copy configuration for the following element types:</p> <ul style="list-style-type: none"> • <i>Absence Entitlement</i> • <i>Absence Take</i> • <i>Accumulator</i> • <i>Bracket</i> • <i>Deduction</i> • <i>Earnings</i> • <i>Element Group</i> • <i>Formula</i> • <i>Process</i> (process list) • <i>Section</i> |
| Component Interface Name | Enter the name of the component interface you want to associate with the element type. |
| Message Set Number | If you want special instructions to display for an element type after copying it, select a value of <i>17340</i> . Select <i>0</i> if no special instructions are required for the element type. |
| Message Number | If you select <i>17340</i> in the Message Set Number , enter the message number corresponding to the special instructions that you want to display when the element type is copied. |

| Field or Control | Description |
|---------------------------|--|
| Copy Options | Define which copy options are available on the Element Copy page. Options are: <ul style="list-style-type: none"> • <i>0 - None</i>: Select to make both the Create Auto Gen Accumulator and the Copy Member Elements check boxes unavailable on the Element Copy page. • <i>1 - Auto Gen. Accumulators</i> (auto generated accumulators): Select to make the Create Auto Gen Accumulator check box available on the Element Copy page. • <i>2 - Member Elements</i>: Select to make the Copy Member Elements check box available on the Element Copy page. • <i>3 - Both Auto Gen. & Members</i> (both auto generated accumulators and members): Select to make both the Create Auto Gen Accumulator and the Copy Member Elements check boxes available on the Element Copy page. |
| Collection Details | Click to access the Component Interface Collection Items Sequence Override Page for an element type. |

Related Links

[Element Copy Page](#)

Component Interface Collection Items Sequence Override Page

Use the Component Interface Collection Items Sequence Override page (GPSC_ECPYCOL_SEC) to configure the sequence numbers for collection fields.

Navigation:

Click the Collection Details button on the Element Copy Configuration page.

This example illustrates the fields and controls on the Component Interface Collection Items Sequence Override page.

Collection Details

Component Interface Collection Items Sequence Override

Collection Items - Sequence Details
Find | View All
First 1 of 7 Last

*Component Interface

*Collection Name

Used for Copying Members?

Required?

Collection Items - Sequence Details
Personalize | Find | View All
First 1-10 of 10 Last

| Original Sequence No. | Item Name | Revised Sequence No. |
|-----------------------|-----------------|----------------------------------|
| 473 | ACM_SIGN | <input type="text" value="473"/> |
| 471 | END_DT | <input type="text" value="471"/> |
| 472 | ENTRY_TYPE_ELEM | <input type="text" value="472"/> |
| 474 | ENTRY_TYPE_PCT | <input type="text" value="474"/> |
| 477 | MESSAGE_NBR | <input type="text" value="477"/> |
| 478 | MESSAGE_SET_NBR | <input type="text" value="478"/> |
| 475 | PCT_TO_ACM | <input type="text" value="475"/> |
| 469 | PIN_MBR_NUM | <input type="text" value="469"/> |
| 476 | PIN_PCT_NUM | <input type="text" value="476"/> |
| 479 | UNIT_IND | <input type="text" value="479"/> |

Use this page to override the sequence numbers defined as part of the component interface (CI) metadata. This is necessary when the collection’s key field is controlled by a non-key field or a derived record field on the PeopleSoft Internet Architecture (PIA) page. In this case, the CI metadata table assigns a lower sequence number for the collection’s key field, but for the purposes of element copying, we need to assign a value to the non-key field first and then to the key field to satisfy the component logic. For example, for a learning element’s supporting element override (SOVR) page, the element type (a non-key field) should be assigned a value first before assigning the supporting element (key field). To control this, it is necessary to configure a sequence number override.

Note: Customers cannot edit the sequence overrides defined for the delivered element types.

| Field or Control | Description |
|----------------------------------|---|
| Collection Name | Enter the name of the collection for which you want to define sequence numbers. |
| Used for Copying Members? | Select to designate the collection as being used for copying member elements. When you select this check box, the system automatically selects the Required? check box . |

| <i>Field or Control</i> | <i>Description</i> |
|-----------------------------|---|
| Required? | Select to make it a requirement to copy the collection details from the source element when creating the new element. |
| Revised Sequence No. | Enter a sequence number for the collection item. |

Element Copy Page

Use the Element Copy page (GPSC_ECPY_MAIN) to copy existing elements.

Navigation:

Set Up HCM > Product Related > Global Payroll & Absence Mgmt > Elements > Element Copy

This example illustrates the fields and controls on the Element Copy page.

The screenshot displays the 'Element Copy' interface. At the top, it shows 'Element Type' set to 'Earnings' and 'Name' as 'SALARY 3'. Below this are two main panels: 'Target Element Details' and 'Source Element Details'. Both panels show 'Element Details' (Name: SALARY 4, Description: Base Salary, Definition As Of Date: Calendar Period End Date, Field Format: Monetary, Version:) and 'Element Use' (Owner: PS Delivered / Not Maintained, Class: System Data, Used By: All Countries, Country: ALL, Industry/Region: , Category: BSA Base Salary). At the bottom, there are 'Copy Options' including 'Create Auto Gen Accumulator', 'Copy Member Elements', and 'Copy Historic Rows', along with a 'Create' button.

| Field or Control | Description |
|-------------------------|---|
| Element Type | <p>Select the type of element that you want to copy from the following options:</p> <ul style="list-style-type: none"> • <i>Absence Entitlement</i> • <i>Absence Take</i> • <i>Accumulator</i> • <i>Bracket</i> • <i>Deduction</i> • <i>Earnings</i> • <i>Element Group</i> • <i>Formula</i> • <i>Process</i> (process list) • <i>Section</i> |
| Name | Enter the name of the element that you want to copy. |
| Get Details | Click to display the Source Element Details group box for the element that you are copying, and the Target Element Details group box for the element that you are creating. The Copy Options group box also appears when you click this button. |
| Clear | <p>Click to remove the selected values from the Element Type and Name fields. When you click this button, the page no longer displays the Source Element Details, Target Element Details, and Copy Options group boxes.</p> <p>Once the page is cleared, you can enter new values to copy another element.</p> |

Source Element Details

Displays details for the element that you are copying. You can use these details as an easy reference as you are creating your new element. Click the element name link to access the [<Element> Name Page](#), where you can access the full definition of the source element.

Target Element Details

Use the fields in this group box to define parameters for the element that you are creating. For more information on defining basic element parameters, see [Defining Element Names](#).

| Field or Control | Description |
|------------------------------|---|
| Name | <p>Enter a unique name for the new element.</p> <hr/> <p>Note: The name you enter here must meet all the existing guidelines for naming an element.</p> <hr/> |
| Description | <p>Enter a description for the new element.</p> |
| Definition As Of Date | <p>Select the date on which the system is to retrieve the element definition during a process run. Options are:</p> <p><i>Calendar Period Begin Date:</i> The begin date of the calendar period to which the element is linked.</p> <p><i>Calendar Period End Date:</i> End date of the calendar period to which the element is linked.</p> <p><i>Payment Date:</i> Payment date of the calendar period to which the element is linked.</p> <p><i>Process Begin Date:</i> Begin date of the calendar period in which the element is processed.</p> <p><i>Process End Date:</i> End date of the calendar period in which the element is processed.</p> <p>Selections are limited for some elements. For example, <i>Calendar Period End Date</i> is the only valid option for section elements.</p> <p>Retroactivity is also a consideration for this field. During recalculation, the system always respects this day and uses the appropriate date based on individual recalculation period calendars.</p> |
| Field Format | <p>Defines the format for the resolved value. Available values are based on the element type and can include <i>Date</i>, <i>Decimal</i>, <i>Character</i>, <i>Monetary</i>, or <i>Pointer</i> (for calculating generic formulas for a variable).</p> <p>For some element types, such as earnings and deductions, you cannot change the displayed field format.</p> <hr/> <p>Note: The difference between <i>Decimal</i> and <i>Monetary</i> is that <i>Monetary</i> is currency-controlled and requires the entry of a currency code.</p> <hr/> |

| Field or Control | Description |
|-------------------------|---|
| Version | You can enter up to 14 alphanumeric characters in this field to identify the element definition. When you save the definition, the system adds a prefix of <i>INT_</i> to indicate that this is a user-defined value. You can use the Global Payroll utilities to stamp and package elements by version. |
| Owner | <p>Identifies who controls and maintains the definition of the element. Values are:</p> <p><i>Customer Maintained:</i> Identifies the elements that you created. All fields are available for entry. This is the only valid value for customer created elements.</p> <p><i>PS Delivered/Maintained:</i> The element is delivered and maintained by PeopleSoft.</p> <p><i>PS Delivered/Not Maintained:</i> The element is delivered, but not maintained by PeopleSoft (for example, sample data or statutory data). You can update any editable fields.</p> <p><i>PS Delivered/Customer Modified:</i> Indicates that you have taken control of a PeopleSoft-delivered or maintained element.</p> <p><i>PS Delivered/Maintained/Secure:</i> The element is delivered and maintained by PeopleSoft. You can edit the name, description, override levels, results, custom fields, and comments (and for system elements, Use as Chartfield and prompt view). Any changes that you make can be overwritten by future PeopleSoft updates.</p> |

| Field or Control | Description |
|----------------------------|---|
| Class | <p>Indicates the type of rule for the element. Values are:</p> <p><i>Customary:</i> Sample rules that are created by PeopleSoft. They are not statutory requirements, but are commonly followed rules. An example of when a customary rule is used is with tariffs. Customary rules are often used in a production environment.</p> <p><i>Not Classified.</i></p> <p><i>Sample Data:</i> Rules that are created by PeopleSoft for sample data purposes. They are not used in a production environment.</p> <p><i>Statutory:</i> Rules that are created by PeopleSoft for calculating rules that are required by law.</p> <p><i>System Data:</i> Rules that are created by PeopleSoft. They are either system elements or system data that are delivered with the application—for example, common constants and dates.</p> <p>The Class field works with the Owner field to determine the level of support and security.</p> |
| Used By and Country | <p>Indicate whether the element is used by all countries or a specific country. The new element that you are creating inherits these values from the element that you are copying.</p> |
| Industry/Region | <p>To classify your element further, select an industry code or region code. You define industry codes on the Industry/Region Types page. If an element is created for a specific industry, select an industry code here. Typical industry codes include Banking, Insurance, and Metallurgy.</p> |
| Category | <p>To classify your element further, select a category code. Category codes are defined on the Categories page (GP_PIN_CATEGORY).</p> |

Copy Options

| Field or Control | Description |
|--|--|
| Create Auto Gen Accumulator (create auto generated accumulator) | <p>Select to generate auto generated accumulators for the new element that are based on the auto generated accumulators defined for the source element.</p> <hr/> <p>Note: This check box is not available for all element types.</p> <hr/> |
| Copy Member Elements | <p>Select to associate the new element with the accumulator members of the source element.</p> <hr/> <p>Note: This check box is not available for all element types.</p> <hr/> |
| Copy Historic Rows | <p>Select to copy all of the effective-dated rows of the source element. When this check box is deselected, the system copies only the most recent effective-dated row of the source element.</p> |
| Create | <p>Click to create the new element based on the selected source element. After creating the new element, the New Element Details and Special Instructions group boxes appear at the bottom of the page.</p> |

This example illustrates how the Element Copy page appears after you create a copy of an element by clicking the Create button.

The screenshot shows the 'Element Copy' interface. At the top, there are fields for 'Element Type' (set to 'Earnings') and 'Name' (set to 'SALARY 3'), along with 'Get Details' and 'Clear' buttons. Below this, the page is divided into several sections:

- Target Element Details:** Contains 'Element Details' (Name: SALARY 4, Description: Base Salary, Definition As Of Date: Calendar Period End Date, Field Format: Monetary, Version:) and 'Element Use' (Owner: PS Delivered / Not Maintained, Class: System Data, Used By: All Countries, Country: ALL, Industry/Region: , Category: BSA Base Salary).
- Source Element Details:** Contains 'Element Details' (Element Nbr: 1151 SALARY 3, Description: Base Salary, Definition As Of Date: Calendar Period End Date, Field Format: Monetary, Version: P_9.00.00) and 'Element Use' (Owner: PS Delivered / Not Maintained, Class: System Data, Used By: All Countries, Country: ALL, Industry/Region: , Category: BSA Base Salary).
- Copy Options:** Includes checkboxes for 'Create Auto Gen Accumulator' (checked), 'Copy Member Elements', and 'Copy Historic Rows'.
- New Element Details:** Shows 'Element Nbr' 90940 SALARY 4, 'Description' Base Salary, and a 'View Log' link.
- Special Instruction(s):** A text box containing 'No specific instruction(s)'.

The **New Element Details** group box displays the element number, name, and description of the newly created element. Click the element name link to access the [<Element> Name Page](#) for the new element. Click the **View Log** link to view detailed information about how the system created the new element.

The **Special Instructions** group box displays any additional steps you need to take to complete following the creation of the new element. For example, when you create a new formula element, the **Special Instructions** group box indicates that you must still manually validate the new formula.

Chapter 6

Defining Data Retrieval Elements

Understanding Data Retrieval Elements

In Absence Management, you use data retrieval elements to retrieve data from the system.

There are five data retrieval elements included in the system:

- System elements
- Arrays
- Brackets
- Rate codes
- Historical rules

PeopleSoft defines and delivers system elements; you name and define the basic parameters of other elements, such as arrays and brackets.

Batch Processing

During processing, the system truncates data that is retrieved by system elements and arrays when the data exceeds these lengths:

Character fields: 30

Numeric fields: 12.6

Related Links

[Defining Element Names](#)

Working with System Elements

Pages Used to Modify and View System Elements

| <i>Page Name</i> | <i>Definition Name</i> | <i>Usage</i> |
|--|------------------------|---|
| System Element Name Page | GP_PIN | Name the element and define its basic parameters. |

| Page Name | Definition Name | Usage |
|---|------------------------|--|
| <u>Source And Use Page</u> | GP_SYSTEM_PIN | Displays whether a system element is a system-computed element or a database system element. For a database system element, it also displays the record and field that populates it and indicates whether the field is SetID controlled. |
| System Elements by Source Page | GP_SYSTEM_PIN_INQ | View system elements by source. |
| <u>Comments for Element <Name> Page</u> | GP_PIN_SEC | View detailed comments about system-computed system elements that Absence Management delivers. |

Understanding System Elements

System elements are delivered and maintained by PeopleSoft and usually contain payee-related data for use in calculations. Although you cannot add system elements, you have the ability to define and alter various parameters that control their use.

There are two types of system elements:

- Database system elements, which come from a predefined list of database records and fields.
- System-computed elements, which come from internally stored data.

System-computed elements are resolved at different times, for example, at the beginning of calculations, daily, or when a rate code element is encountered, depending on the element's purpose.

Note: To store the value of a database system element for reporting purposes, include the element in your process.

Understanding Batch Processing of System Elements

All system elements, whether they are database or system-computed elements, have several important considerations. A system element that is frequency controlled is annualized by the **Frequency** field and then deannualized, based on the calendar frequency. Thus, any absence element that uses the **Frequency** field should be defined as having a frequency equal to the use calendar period frequency. This approach ensures correct results, avoiding additional annualization or deannualization.

Database System Elements

For database elements from effective-dated records, the row selected is based on context. Typically the value is as of the segment end date. If referenced during resolution of a sliced element, the value is as of the slice end date. When retrieving values from job records, for example, the system matches on employee ID, employee record, and the segment and slice end date.

System element definitions for the country being processed and those used by all countries are loaded at the beginning of an absence run. System elements are resolved when used in the absence process.

Note: Only database system elements that are used and have been defined as Store = Yes are stored in the result tables.

PeopleSoft HR Database System Element Records

The following table lists the database tables that populate database system elements:

| Table Name | Description |
|--|---|
| PERSON | Not effective-dated. Select based on employee ID. |
| PERS_DATA_EFFDT (personal data effective date) | Max Effdt (maximum effective-dated) row is less than or equal to the segment end date. If referenced in a slice, looks at Max Effdt rows that are less than or equal to the slice end date. |
| JOB | The Max Effdt row is less than or equal to the segment end date. If referenced in a slice, looks at Max Effdt rows that are less than or equal to the slice end date. |
| PER_ORG_ASGN (person organization assignment) | Not effective-dated. Select based from the employee's organizational instance number |
| PER_ORG_INST (person organization instance) | Not effective-dated. |
| CONTRACT_DATA | Not effective-dated. Select based on CONTRACT_NUM (contract number) from the selected job record. |
| WKF_CNT_TYPE (workforce contract type) | The Max Effdt row is less than or equal to the segment end date where the contract number on this row matches the contract number on job. You can use CONTRACT_NUM from JOB or from CONTRACT_DATA, because the system synchronizes them. If the contract number is referenced in a slice, use the slice end date. |
| COMPENSATION | Includes all comp_effseq rows for each rate code (comp_ratecd) where Effdt and Effseq (effective sequence) match Effdt and Effseq from the Job table. |

Note: These HR tables are discussed in detail in the HR documentation.

See “Understanding Job Data” (PeopleSoft Human Resources Administer Workforce).

System-Computed Elements

System-computed elements appear on the output results table only if they are used, provided that the appropriate output options on the Source And Use page are selected.

During batch processing, all database system elements are retrieved and stored in arrays, whereas system-computed element values are retrieved and set by the appropriate processing module. For example, when you process absences, the system populates only those system elements that are specific to absences.

With system-element processing:

- The system populates the first active segment, based on all the active segments that are created for a specific process stat record.
- The system also populates the last active segment, based on all the active segments that are created for a specific process stat record.

System Element Name Page

Use the System Element Name page (GP_PIN) to name the element and define its basic parameters.

Navigation:

Set Up HCM > Product Related > Global Payroll & Absence Mgmt > Elements > Supporting Elements > System Elements > System Element Name

Note: You name every element and define its basic parameters on an element name page with the object name of GP_PIN. The page title and general appearance of this page change based on the type of Absence Management element that you name and define.

For each system-computed system element that is delivered by PeopleSoft, you can view detailed comments including a general description, when the system element is available, and where the element is used by clicking the **Comments** link. This is useful information when you want to learn more about how the system uses a specific system element.

Related Links

[Defining Element Names](#)

Source And Use Page

Use the Source And Use page (GP_SYSTEM_PIN) to displays whether a system element is a system-computed element or a database system element.

For a database system element, it also displays the record and field that populates it and indicates whether the field is SetID controlled.

Navigation:

Set Up HCM > Product Related > Global Payroll & Absence Mgmt > Elements > Supporting Elements > System Elements > Source and Use

This example illustrates the fields and controls on the Source And Use Page.

| System Element Name | | Source And Use | |
|--|--|---|--|
| Element Name | ABSENCE DATE | Absence date | |
| Owner | PS | Secure | |
| Element Detail | | | |
| <input checked="" type="radio"/> System-Computed | | <input type="radio"/> Database Field | |
| Record | <input type="text"/> | | |
| Field Name | ABSENCE_DATE | Absence Date | |
| | <input type="checkbox"/> Set ID Controlled | <input type="checkbox"/> Use As Chart Field | |
| Prompt View | <input type="text"/> | | |
| Set ID Element | <input type="text"/> | | |
| Version 8.00.00.00 | | | |

| Field or Control | Description |
|-------------------------|---|
| Record | Displays the record that the system element populates. |
| Field Name | Displays the field from which the system element obtains its information. |
| SetID Controlled | Selected if the field is controlled by SetID. Elements that are controlled by SetID have field name and prompt view values. |
| Use As Chart Field | This check box is not applicable to Absence Management. |
| Prompt View | Elements that are controlled by SetID have a prompt view specified. If a SetID-controlled system element is used as a supporting element override for positive input, it also requires a prompt view. |
| SetID Element | Displays the SetID field name for the system element. |

Related Links

“Business Units, Tablesets and Set IDs” (Application Fundamentals)

Comments for Element <Name> Page

Use the Comments for Element <name> page (GP_PIN_SEC) to view detailed comments about system-computed system elements that Absence Management delivers.

Navigation:

Click the **Comments** link on the System Element Name page.

This example illustrates the fields and controls on the Comments for Element <name> page.

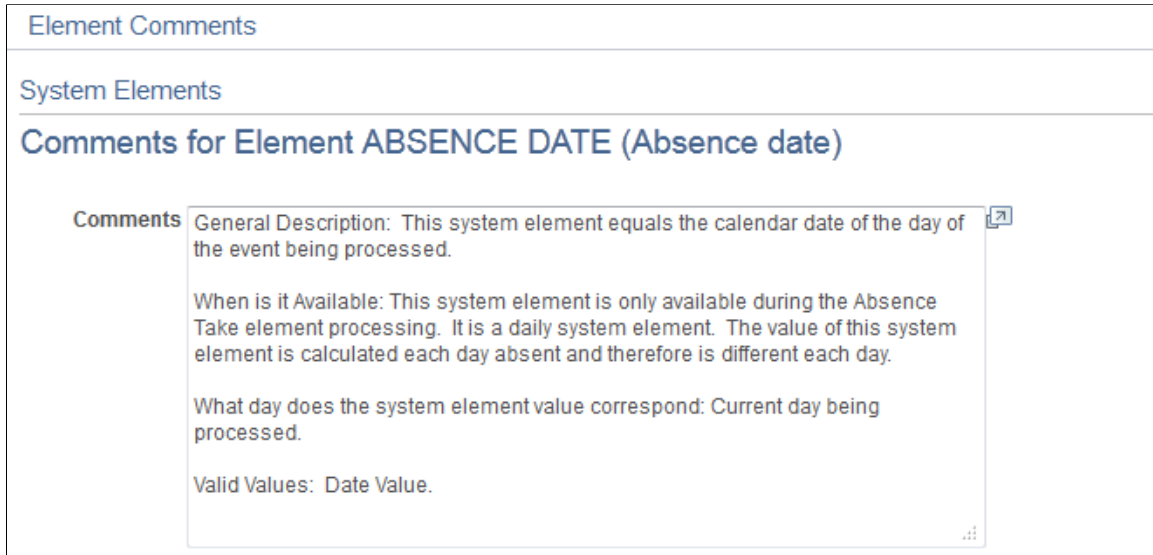

For each system-computed system element that is delivered by the PeopleSoft system, you can view detailed comments including a general description, when the system element is available, and where it is used by clicking the **Comments** link on the System Element Name page. This is useful information when you want to learn about what a specific system element does.

Defining Array Elements

Pages Used to Define Array Elements

| <i>Page Name</i> | <i>Definition Name</i> | <i>Usage</i> |
|--|------------------------|---|
| Array Name Page | GP_PIN | Name the element and define its basic parameters. |
| Field Map and Keys Page | GP_ARRAY_KEYS | <ul style="list-style-type: none"> Select the database table for the FROM clause of the SQL statement and define the values for the WHERE clause of the SQL statement the system uses when retrieving data for an array. Define the fields within an array. This provides the data for the SELECT clause of the SQL statement and determines the elements to resolve from this array call. You also use this page to define the sort order for retrieving rows from a database. |
| Processing Formulas Page | GP_ARRAY_PROCESS | Define all required formula processing. |

Understanding Array Elements

Arrays enable you to retrieve data from external sources such as HR tables—data that you need to use, evaluate, or process in your absence rules.

To build an array, you assemble a Structured Query Language (SQL) statement out of FROM, SELECT, and WHERE clauses using the Array Definition component.

- To define the FROM clause, you identify the table containing the required data in the **Record (Table) Name** field on the Field Map and Keys page.
- To build the SELECT clause, you identify the table columns (fields) containing the data in the **Fields Retrieved** group box on the Field Map and Keys page.
- To build the WHERE clause, you define the array keys and the conditions under which rows of data are to be pulled from the database table based on the values of the array keys.

To do this, you use the fields in the **Retrieval Criteria** group box on the Field Map and Keys page.

- After defining the SQL statement, you must map the database column values in the array to Absence Management variables.

These variables hold the column values and make them available for use in Absence Management rules.

To do this, use the **Variable Element Name** field on the Field Map and Keys page.

Note: After you construct your SQL statement, you can also define any formulas; you need to evaluate the data retrieved by the array.

Do this on the Array Processing Formulas page.

Note: Arrays are not effective-dated. Any changes are likely to affect retroactive processing.

Understanding Batch Processing of Arrays

Arrays can be used to access data in database tables or views that are not delivered by system elements. They do not resolve to a value but instead invoke processing.

You can create either payee-based arrays or non-payee-based arrays on the Field Map and Keys page. Payee-based arrays are resolved as of the slice or segment that is currently being resolved.

Arrays must be resolved for every segment and slice. If any element set by an array is used by another element that's being sliced, the array itself should be added to the event list to ensure that the array and all return column elements are also sliced. You must enter the array into the event list.

Payee-Based Array Processing

The system performs these steps when processing payee-based arrays:

1. Arrays call the database the first time that they are encountered in a calendar run.

All of the rows of data that fit the WHERE criteria (based on keys entered) are pulled into memory. The cursors are sorted by employee ID in ascending order, by employee record number in ascending order, and by effective date in descending order.

2. For each payee, a cursor is set to access the appropriate rows of data (the **Payee** and **Effective Date** fields based on field use on the Field Map and Keys page).

Payee-based arrays are aligned per absence based on the period end date. If segmentation occurs and the array is on the event list or is being used in an absence element that is being sliced or segmented, the array must be aligned by slice or segment end date.

3. The array process formulas are applied against the data that is stored in memory (for the payee cursor set above), based on the process code.
4. The database field is resolved to the last row of data against which the process formulas were applied.

Whenever the array is accessed, steps 2 through 4 are performed again. Step 1 is performed only if the payee has changed or if a new slice or segment is being resolved.

Non-Payee-Based Array Processing

When processing non-payee-based arrays, the system performs the following steps:

1. Arrays call the database the first time they are encountered in a calendar run.

All rows of data that fit the WHERE criteria (based on keys entered) are pulled into memory, so most effective-dated logic should be within the process formula logic.

2. If the table is effective-dated, the lookup formula references the system element that refers to the correct date (segment, slice, period).

If segmentation occurs and the array is on the event list or is being used in an absence element that's being sliced or segmented, the array must be aligned by slice or segment end date. Arrays can return multiple rows from the database. The process formulas are applied against the rows.

3. The array process formula is run.
4. The database field is resolved to the last row of data against which the process formula was applied.

Whenever the array is accessed, steps 2 through 4 are performed again. Step 1 is performed only if the *Reload for Each Resolution* or *Reload for Each Segment* value is selected on the Field Map and Keys page.

Related Links

[Arrays Used in Batch Processing \(Technical\)](#)

Array Name Page

Use the Array Name page (GP_PIN) to name the element and define its basic parameters.

Navigation:

Set Up HCM > Product Related > Global Payroll & Absence Mgmt > Elements > Supporting Elements > Arrays > Array Name

This example illustrates the fields and controls on the Array Name page.

The screenshot shows the 'Array Name' page with the following details:

- Array Name:** *Name: KOWAR FREQUENCY, *Description: Annual Factors
- Element Type:** Array, *Field Format: Decimal
- Element Nbr:** 2363, Always Recalculate
- Element Use:**
 - *Owner: PS Delivered / Not Maintained
 - *Class: Sample Data
 - *Used By: All Countries
 - Country: ALL
 - Industry/Region:
 - Category: ABS Absence
- Override Levels:**
 - Pay Entity, Via Elements
 - Pay Group, Element Definition
 - Payee, Positive Input
 - Calendar
- Results:**
 - Store, Store if Zero
- Resolution Parameters:** This element type does not require additional resolution parameters.
- Version Information:**
 - Last Updated: 11/30/04 12:00:00.000000AM
 - Last Updated By: PPLSOFT
 - User Version:
 - Version: P_8.90.00.00

Because arrays are temporary tables that store results only during processing, storing the results after processing isn't necessary. The system clears the **Store** and **Store if Zero** check boxes and makes them unavailable for entry.

In addition, arrays are not effective-dated, so this page has no definition as of date. To change an array definition, create a new array and new effective-dated elements that reference it. If a database table or view is renamed, create a new array.

Note: You name every element and define its basic parameters on an element name page with the object name of GP_PIN. The page title and general appearance of this page change based on the type of Absence Management element you are naming and defining.

Related Links

[Defining Element Names](#)

[Arrays Used in Batch Processing \(Technical\)](#)

Field Map and Keys Page

Use the Field Map and Keys page (GP_ARRAY_KEYS) to .

Navigation:

Set Up HCM > Product Related > Global Payroll & Absence Mgmt > Elements > Supporting Elements > Arrays > Field Map and Keys

This example illustrates the fields and controls on the Field Map and Keys page.

The screenshot displays the 'Field Map and Keys' configuration interface. At the top, it shows the element name 'K0WAR FREQUENCY' and owner 'PS Non-Mnt'. Below this, the 'Record (Table) Name' is set to 'FREQUENCY_TBL' and the 'Loading Option' is 'Reload for each resolution'. The interface is divided into two main sections: 'Map Retrieved Fields to Variable Elements' and 'Keys and Retrieval Criteria'. The first section contains a table with columns for 'Field Use', 'Field', 'Variable Element Name', 'Currency Field', and 'Order By'. The second section contains a table with columns for 'Key Type', 'Field', 'Operator', 'Element Type', and 'Element Name'. At the bottom, there is a 'Review Generated SQL Statement' section with a 'View Resulting Query' link and a 'Log statement at run time' checkbox. The version number 'Version P_8.90.00.00' is displayed at the very bottom.

| Field or Control | Description |
|----------------------------|---|
| Record (Table) Name | <p>Select the table for the SQL statement to use from the list of PeopleSoft defined tables. In the FROM clause of the SQL statement, the system appends the prefix <i>PS_</i> to the selected table name.</p> <p>You can also select views. The prompt list displays all SQL tables and views in the database.</p> |

| Field or Control | Description |
|-------------------------|---|
| Loading Option | <p>Select a value to control how often the array data are refreshed from the database.</p> <p>Values are:</p> <p><i>Employee-based look-up:</i> Select to create a payee-based array.</p> <p>Data is retrieved once for each payee. When that person is processed, the array storage becomes available for the next payee.</p> <p><i>Load once (small table):</i> Select to create a non payee-based array. Data is retrieved only once the very first time the array is referenced within the process. Compared to the two "Reload" alternatives, this option can significantly improve performance because the process only accesses the database once to load data. As indicated, this should be used only with smaller tables. The buffer for all arrays with this option combined can only hold 5000 rows. If the data in the table is changed by the process itself (and it is desirable to reflect these updates in the process, <i>Load once</i> is not a good option.</p> <p><i>Reload for each resolution:</i> Select to create a non payee-based array.</p> <p>Data is retrieved from the database every time the array is resolved.</p> <p><i>Reload for each segment:</i> Select to create a non payee-based array.</p> <p>Data is retrieved from the database once per segment being processed, regardless of the number of times the array may be resolved within each segment.</p> <hr/> <p>Note: The loading option that you select controls the key types that you can enter in the Key Type field.</p> <hr/> |

See the product documentation for *PeopleTools: Data Management*.

Map Retrieved Fields to Variable Elements

Specify the columns to be retrieved from selected rows in the **Array - Fields Retrieved** group box (this is the SELECT part of the SQL statement). Also specify the variable elements to populate with the selected columns' values. The system orders the *Keyed by Employee* arrays by employee ID (and employee record number and effective date, if specified), with employee ID and employee record number in ascending order and effective date in descending order.

| Field or Control | Description |
|------------------------------|---|
| Field Use | Select from these options: <i>Monetary:</i> When monetary conversion is required. <i>Pointer:</i> To specify that a column contains a PIN. <i>Other:</i> (default) For all other cases. |
| Field | Select a field from the list of columns in the database table. The system displays all columns in the database table that can be used in the SELECT AND/OR ORDER BY clause. |
| Variable Element Name | Define the host variable to populate with the value of the selected field. The Variable Element Name field is not required. If this field is blank, only the database field name column value is used in the ORDER BY clause. <hr/> Note: You cannot use the same variable name for two or more different field names. |
| Currency Field | If the field being retrieved from the database stores a monetary amount, enter a currency field name, indicating the column name of the field in the database that stores the corresponding currency code. If the currency code doesn't equal the processing currency, the system converts the monetary amount in the database to the processing currency. This field is available for entry only if you select <i>Monetary</i> in Field Use . |
| Order By | Define the sort order—ascending, descending, or none—for retrieving rows from the database. This is crucial because, depending on the defined lookup formula, you may want only the first row retrieved or use special formula logic dependent on the order. <hr/> Note: The same field can be assigned to more than one Absence Management variable, but it cannot be ordered in more than one way (for example, both ascending and descending). |

Keys and Retrieval Criteria

| Field or Control | Description |
|-------------------------|---|
| Key Type | <p>Select a key type.</p> <p>If the Loading Option is <i>Employee-based look-up</i>, the key types are <i>Effdt</i> (effective date), <i>EmplRcd</i> (employee record number), <i>EmplID</i> (employee ID), and <i>Other</i>. Select <i>Other</i> if you want to use any other database field in the table that you are querying as a key.</p> <p>If the Loading Option is <i>Load once (small table)</i>, <i>Reload for each resolution</i>, or <i>Reload for each segment</i>, all key fields are defined as <i>Other</i>.</p> <p>When specifying keys for a user-defined array, you generally define at least one key, but the system enables you to save this page without specifying keys. (In this case, the system loads the entire table.)</p> <hr/> <p>Warning! Changing the array keys clears the data in the Keys and Retrieved fields and the Processing Formulas pages.</p> |
| Field | <p>Enter the exact name of the record (table) column as defined in the database. This is the first half of the equation in the WHERE clause. For example, suppose that you have the equation WHERE EmplID equals System Element Payee ID1, EmplID is what you enter under Field.</p> <p>The field name must be the exact name of the column in the table in the database—not the field label or description</p> |
| Operator | <p>Indicates the user in the WHERE clause. You can enter an operator only if the key type is <i>Other</i>. Valid operators are: <, <=, <>, =, >=, >, and <i>N.A.</i></p> |
| Element Type | <p>Select <i>Bracket</i>, <i>Formula</i>, <i>System Element</i>, or <i>Variable</i>. You can enter an entry type only if the key type is <i>Other</i>.</p> |
| Element Name | <p>Select the element for the second half of the WHERE clause. For example, in the equation WHERE EmplID equals System Element Payee ID1, Payee ID1 is the element name. You can enter an element name only if the key type is <i>Other</i>.</p> |

Review Generated SQL Statement

| <i>Field or Control</i> | <i>Description</i> |
|----------------------------------|---|
| Log statement at run time | Select this check box to view the text of the SQL statement dynamically generated by the array module during batch processing. You can direct the output display into a file by selecting the Redirect Output option in PeopleTools Configuration Manager. |
| View Resulting Query | Click to view the SQL statement in real time. The system displays what SQL is to be created to pull data into the array, and lists how many rows are in the table defined in the Record (Table) Name field. |

Using System Elements as Key Values

Depending on your loading option, you can use *EmplID*, *EmplRcd#*, and *Effdt* as key fields.

If you select *EmplID* or *EmplRcd* as array keys, the system hides the **Operator** and **Element Name** fields and assumes an operator of equal to (=) current *EmplID* and *EmplRcd#*. For *Effdt*, the system assumes an operator of less than or equal to (<=) the date specified in the **Compare Effdt (effective date) against** field.

For example, if you select *Employee-based look-up* and enter a key type of *EmplID* (using field name *EmplID*), and a key type of *EmplRcd#* (using field name, *EmplRcd#*), the system builds a SQL statement that retrieves data for the current payee only.

Using Other as a Key Type in Payee-Based and Non-Payee-Based Arrays

If you are not using one or more of the three provided array key elements—or you want entries beyond those—specify a key field name, an operator, an entry type, and the correct element name.

1. Select the correct operator for the key field (record column) in the WHERE clause.
2. Select an entry type.
3. Enter an element name corresponding to the entry type—this must be a defined element of the type that you selected.

This is the data that the system uses to build the WHERE clause of the SQL statement that it needs for retrieving data for the array. You can enter multiple key fields for your definition.

Note: If you enter multiple rows on the page, the multiple conditions are processed as AND conditions.

Example: User-Defined Key Structure

Say that you're searching the database for a row of data with a matching department ID.

You enter Other DEPTID = System Element DEPTID. The system looks for a row in the Department table (DEPT_TBL) with a DEPTID (department ID) that equals the value in the system element DEPTID for the payee currently being processed when it encounters this array.

Processing Formulas Page

Use the Processing Formulas page (GP_ARRAY_PROCESS) to define all required formula processing.

Navigation:

Set Up HCM > Product Related > Global Payroll & Absence Mgmt > Elements > Supporting Elements > Arrays > Processing Formulas

This example illustrates the fields and controls on the Processing Formulas page.

The screenshot shows the 'Processing Formulas' page with the following details:

- Array Name:** KOWAR FREQUENCY Annual Factors
- Owner:** PS Non-Mnt
- Record (Table) Name:** FREQUENCY_TBL (Frequency Table)
- *Processing Option:** Look-up
- Error Formula:** (Empty field with search icon)
- Processing Formulas Table:**

| Formula Name | | |
|--------------|--|--|
| | | |

| Field or Control | Description |
|--------------------------|---|
| Processing Option | <p>Select one of these values to determine when and how the system applies a formula. Values are:</p> <p><i>By Formula, Apply all Rows:</i> The system selects all the rows required for the array, applies the first formula to all rows, applies the second formula to all rows, and continues for all formulas.</p> <p><i>By Row, Apply all Formulas:</i> The system selects a row of data from the database and applies each formula on this page to that row. It then selects the next row and applies each formula to that row, continuing for all rows.</p> <p><i>Look-up:</i> The system selects a row of data from the database, applies each formula on this page to that row, selects the next row, and applies each formula to that row. The first formula that resolves to a value of 1 stops the loop. So if you are searching data for a particular value, the system stops looking when it finds that value.</p> <p>Note: With regards to arrays with look-up processing, if you select a value of <i>Look-up</i>, but do not specify a formula value in the Formula Name field, the system uses the first row of data returned by the array.</p> |

| Field or Control | Description |
|-------------------------|--|
| Error Formula | Select an Error Formula Name for the system to use during error processing, if no rows are found. |
| Formula Name | <p>Select the formula that the system applies to each row of data to resolve the array.</p> <p>If you selected <i>Look-up</i> as the array processing option, select a Boolean formula here.</p> <hr/> <p>Note: Instead of using a formula, consider defining the array so that the desired row of data is always ordered first. Also, if the array will never return more than one row of data, and this row will always contain the desired data, no Formula Name field value is necessary with the processing option of <i>Look-up</i>.</p> |

Note: The system automatically assigns a sequence number to each formula. The sequence is unchangeable. If you make a mistake, delete all the items back to the mistake and add the formulas again in the correct order.

Related Links

[Defining Formula Elements](#)

Defining Writable Array Elements

Pages Used to Define Writable Array Elements

| Page Name | Definition Name | Usage |
|--|------------------------|--|
| Writable Array Name Page | GP_PIN | Name the element and define its basic parameters. |
| Definition and Fields Page | GP_WRITABLE_ARRAY | Identifies the table into which the writable array process inserts data. Also identifies the element that populates each column (field name) in the table. |

Understanding Writable Array Elements

Writable arrays are elements that you can use to populate user-defined result tables. You use PeopleSoft Application Designer to create the result table, then you use the writable array pages that are described in this topic to define the element that populates the table during batch processing. Writable arrays are in many ways the opposite of standard arrays. Instead of reading values from a row in a table to user-defined variables, a writable array writes the values of user-defined elements into a row in a table.

Writable arrays make it easy for you to design reports that exactly meet your needs—each row in your table can produce a corresponding line of information in your report. You can also combine multiple tables to create a report, for example, use one table for a report header, one for the body of the report, and another for the footer.

Finally, writable arrays can also conserve valuable storage space by consolidating many vertical rows of information into a single horizontal row.

To define a writable array:

1. Use PeopleSoft Application Designer to create the table that the writable array element populates.

The first seven fields in the table must be the same as the keys in the basic result tables. You can also use some of the optional result table keys, such as `INSTANCE` or `SLICE_BGN_DT`, and include keys that are not used in the basic result tables, such as `DEPTID`.

The seven fields are:

- **EMPLID**
- **CAL_RUN_ID**
- **EMPL_RCD**
- **GP_PAYGROUP**
- **CAL_ID**
- **ORIG_CAL_RUN_ID**
- **RSLT_SEG_NUM**

2. On the Writable Array Name page, define the naming information for the writable array.
3. On the Definition and Fields page, identify the table that the writable array is to populate, and map the elements that are to populate the table to the corresponding fields (columns) within the table.

Note: When you create a result table using a writable array, the table must include the basic segment status keys shared by all the standard result tables. You can include additional keys as well.

Understanding Storage Considerations for Writable Array Elements

While custom result tables can conserve storage space, they can also increase the need for space if they duplicate data from the standard result tables. Consider using writable arrays to consolidate or temporarily store the following types of results:

- Miscellaneous personal data required for audit purposes.

You might want to store these values in a single row instead of in the standard result tables and keep the records as long as you need them for auditing purposes.

- Period summary data.

If you need to summarize data by period on year-to-date reports, you can save summary data for each period for as far back as needed.

- Temporary data used in reports.

For reporting purposes, you may want to duplicate data found in the standard result tables but present it in a different form. You can then delete the data once you complete the reporting period.

Because you may want to delete temporary data at different times, we leave the management of the data in your result tables up to you.

Understanding Batch Processing of Writable Array Elements

Typically, each call to a writable array element creates one row of data. To produce multiple rows of output, you can use loops within a subprocess section and arrays to call the writable array multiple times. Using pointers and variables, you can populate the same field in a writable array with values from different elements, as long as you do not map character and numeric elements to the same field.

Writable Array Name Page

Use the Writable Array Name page (GP_PIN) to name the element and define its basic parameters.

Navigation:

Set Up HCM > Product Related > Global Payroll & Absence Mgmt > Elements > Supporting Elements > Writable Arrays > Writable Array Name

When a writable array resolves successfully, the element itself is set to one. Most likely, you will not want to store this value, so the **Store** and **Store if Zero** options on the Element Name page are not selected, by default. You can select them if you choose.

In addition, writable arrays are not effective-dated, so there is no definition as of date on the Writable Array Name page. If you need to change the element's definition, create a new writable array instead, and then create new effective-dated elements that reference the new writable array. If you rename a database table or view, create a new writable array.

Note: You name every element and define its basic parameters on an element name page with the object name of GP_PIN. The page title and general appearance of this page change based on the type of Absence Management element that you are naming and defining.

Related Links

[Defining Element Names](#)

Definition and Fields Page

Use the Definition and Fields page (GP_WRITABLE_ARRAY) to identifies the table into which the writable array process inserts data.

Also identifies the element that populates each column (field name) in the table.

Navigation:

Set Up HCM > Product Related > Global Payroll & Absence Mgmt > Elements > Supporting Elements > Writable Arrays > Definition and Fields

This example illustrates the fields and controls on the Definition and Fields page.

| Writable Array Name | | Definition and Fields | |
|--|--------------------------|-----------------------------|---------------------|
| Element Name | GP WA GUIDE | WA Segmentation Guide | Owner PS Mnt |
| *Record (Table) Name | GP_SEG_GUIDE_W | Segment Guide WA | |
| Bulk Insert Flag | | | |
| <input type="checkbox"/> Insert Rows Immediately | | | |
| Writable Array Fields | | Personalize Find View 5 | First 1-8 of 8 Last |
| *Field Name | *Entry Type | *Element Name | Description |
| COMPANY | System Element - Charact | COMPANY | Company |
| CONTRACT_NUM | System Element - Charact | CONTRACT NUMBER | Contract Number |
| DEPTID | System Element - Charact | DEPTID | Department |
| EMPL_CTG | System Element - Charact | EMPL CTG | Category Code |
| ESTABID | System Element - Charact | ESTABID | Establishment ID |
| LOCATION | System Element - Charact | LOCATION | Location Code |
| SETID_DEPT | System Element - Charact | SETID DEPT | Department SetID |
| SETID_LOCATION | System Element - Charact | SETID LOCATION | Location SetID |
| Version P_8.90.00.00 | | | |

Note: The writable array must have a record name and at least one field name in order to save.

| Field or Control | Description |
|--------------------------------|--|
| Record (Table) Name | <p>Enter the name of the table that the writable array is to populate. The only tables available for selection are those containing the seven required key fields of a writable array.</p> <p>The system appends the prefix <i>PS_</i> to the table name and uses the new name in the INSERT clause of a SQL statement.</p> |
| Insert Rows Immediately | <p>Select if you are defining a writable array to generate data for immediate use by a standard array in the same process. This ensures that the data is present in the database when the standard array element is processed.</p> <p>If this check box is not selected, the system does not immediately write data to the database table that the array is populating. It inserts the data at a later time using a bulk insert process.</p> <p>Note: Not all relational database management systems provide bulk insert. For these, the rows will always be inserted one-by-one as they are processed.</p> |

| <i>Field or Control</i> | <i>Description</i> |
|-------------------------|---|
| Field Name | <p>Enter the name of the writable array field that you want to populate. The list of available options includes only those fields that are included in the table that you selected in the Record (Table) Name field.</p> <p>The order in which you add field name is not important.</p> |
| Entry Type | Select the type of element that will populate the field. |
| Element Name | <p>Select the element whose value the system uses to populate the writable array key field that you are defining.</p> <hr/> <p>Note: During processing, the system populates the array with the current value of the selected element. (Linking an element to a writable array field does not, in itself, cause the element to resolve.)</p> <hr/> |

Defining Bracket Elements

Pages Used to Define Bracket Elements

| <i>Page Name</i> | <i>Definition Name</i> | <i>Usage</i> |
|---|------------------------|---|
| Bracket Name Page | GP_PIN | Name the element and define its basic parameters. |
| Lookup Rules Page | GP_BRACKET1 | Define the lookup rules for a bracket. |
| Search Keys/Return Columns Page | GP_BRACKET2 | Identify the search keys and the return columns for the bracket. |
| Brackets - Data Page | GP_BRACKET3 | Enter lookup values. The search key values and the return column values that you selected in the Brackets - Search Keys/ Return Columns page appear here. |
| Bracket Data Page | GP_BRACKET_DATA | Update search key values and return column values for existing bracket elements. |

Related Links

[Defining Element Names](#)

Understanding Bracket Elements

Brackets enable you to create simple lookup tables. Based on a table that you define in a bracket, a bracket is used to look up data and assign certain values based on the lookup data. Brackets are also called *bands* and *lookup tables*.

Brackets can use one or more lookup values (search columns). Using a lookup value, bracket processing returns one or more columns that are available for use in other elements such as formulas.

Before defining a bracket, create any elements that you need to use in the bracket definition. For example, before building a bracket that lets you look up, for example, additional absence entitlements based on years of service, create the duration element that returns the years of service.

To define a bracket:

1. Define the naming information for a bracket on the Bracket Name page.
2. Define the lookup rules for the bracket on the Lookup Rules page.
3. Select the search key values and the return column values that you'll use in the lookup table on the Search Keys/Return Columns page.
4. Enter the lookup values on the Brackets - Data page.

Understanding Interpolation Methods

When a search key doesn't exactly match the lookup values defined for the bracket (on the Bracket Data page), the interpolation method defines how the system calculates the values that the bracket returns.

You can select one of the following three interpolation methods on the Lookup Rules page:

- *Linear:*

Uses a mathematical formula to create a prorated value based on the next-higher and next-lower keys (works only with brackets that have one or two numeric keys and with numeric result columns). With the linear interpolation method, you can use a rounding rule to specify the type of rounding for the returned value.

- *Use Nearest:*

Uses the value from the row that has the nearest key (works only with brackets that have numeric or date keys).

- *Use Next Higher:*

Uses the value from the row that has the next-higher key (works with any bracket).

- *Use Next Lower:*

Uses the value from the row that has the next-lower key (works with any bracket).

Use Lowest and Highest Option

For the linear interpolation method, the system looks for the next-lower and next-higher rows to calculate the return value. When there isn't a lower or higher row, you can use the **Use Lowest/Highest Option**

check box on the Lookup Rules page to indicate whether the system should take the lowest or highest matching option.

Understanding Batch Processing of Bracket Elements

In bracket processing, the system looks up a row based on the key values and returns a bracket value.

Brackets always resolve to the value of the first column returned. They are resolved as they're encountered in the process. If an element in the return column of a bracket is encountered during processing, it doesn't automatically invoke resolution of the bracket, because the system doesn't know whether the element is associated with this bracket.

Brackets and all return columns are populated as of applicable slice and segment end dates that are used when encountered during processing, with these criteria:

- If a bracket is used by another element that's being sliced, the bracket and all return column elements are also sliced.
- If the bracket is encountered on the process list, it is resolved for the segment that's currently being processed.
- If a bracket return column needs to be re-resolved during segmentation, the bracket should be used in the calculation or the bracket should be on the event list.

How Brackets Use Interpolation Methods

Three factors need to be considered:

- Interpolation Method (corresponding **Use Lowest/Highest Option** check box if *Use Next Higher*, *Use Next Lower*, or *Linear* is selected).
- Outside Table Limits (only if there's no match on the first key).
- Error Processing Options (when there's no match using appropriate interpolation methods and selections).

Two options are available. If **Generate Error** is selected, the system does not resolve the bracket (or any of the return columns) and puts the calculation in error. If **Continue Process** is selected, the system resolves the bracket and all the other return columns to be either 0 or blank (depending on the field format).

This table clarifies how batch processing treats each interpolation method:

| <i>Interpolation Method</i> | <i>Batch Process</i> |
|------------------------------------|---|
| <i>Use Nearest</i> | <p>If mismatch key is nonnumeric, go to Error Processing Options.</p> <p>If mismatch key is numeric determine whether next-lower and next-higher values exist:</p> <ul style="list-style-type: none"> • If only next-lower value exists, use that row. • If only next-higher value exists, use that row. • If both next-lower and next-higher values exist, determine which value is nearer and return that row (if exactly halfway between, return the higher row). |
| <i>Use Next Lower</i> | <p>Determine whether next-lower row exists:</p> <ul style="list-style-type: none"> • If next-lower row exists, use that row. • If next-lower row doesn't exist, look at the Use Lowest/Highest Option check box (if lower value doesn't exist). • If Use Lowest/Highest Option check box is selected, use the lowest row where keys match. • If Use Lowest/Highest Option check box is not selected, go to Error Processing Options. |
| <i>Use Next Higher</i> | <p>Determine whether next-higher row exists:</p> <ul style="list-style-type: none"> • If next-higher row exists, use that row. • If next-higher row doesn't exist, look at the Use Lowest/Highest Option check box (if higher value doesn't exist). • If Use Lowest/Highest Option check box is selected, use the lowest row where keys match. • If Use Lowest/Highest Option check box is not selected, go to Error Processing Options. |

| Interpolation Method | Batch Process |
|-----------------------------|---|
| <i>Linear</i> | <p>If mismatch key is nonnumeric, go to Error Processing Options.</p> <p>If mismatch key is numeric determine whether next-lower and next-higher values exist:</p> <ul style="list-style-type: none"> • If only next-lower value or next-higher row exists, look at Use Lowest/Highest Option check box. • If Use Lowest/Highest Option check box is selected, use that row (no linear interpolation required). • If Use Lowest/Highest Option check box is not selected, go to Error Processing Options. <p>If both next-lower and next-higher values exist:</p> <ul style="list-style-type: none"> • In relation to the keys: <ul style="list-style-type: none"> • Determine the difference between the next-lower and next-higher rows (Key Difference 1). • Determine the difference between your value and the next-lower value (Key Difference 2). • Determine ratio by dividing Key Difference 2 by Key Difference 1 (Key Ratio). • For each return column: <ul style="list-style-type: none"> • Determine the difference between the values for the next-lower and next-higher rows (Return Column Difference 1). • Apply Key Ratio to the Return Column Difference (Return Column Difference 2). • Add Return Column Difference 2 to the value from the next-lower row. This is the value that should be returned for the return column. |

Additional Notes About Batch Processing for Bracket Elements

Search keys are considered in the order in which they are entered on the bracket definition. Values are in ascending order (based on key order).

For all interpolation methods, if all keys match, use that row. For all interpolation methods, try to match on keys sequentially (first key, second key, and so on).

What to Do When Keys Are Mismatched

If there's a mismatch on the first key:

- Determine whether the mismatch is specified in Outside of the Table Limits.
 - If the first key value is under the key 1 value defined on the first row:
 - If *Use First Row if Under* is selected, use the first row.
 - If *Use First Row if Under* isn't selected, go to Error Processing Options.
 - If the first key value is over the key 1 value defined on the first row:
 - If *Use Last Row if Over* is selected, use the last row.
 - If *Use Last Row if Over* isn't selected, go to Error Processing Options.
- If the mismatch isn't specified in Outside of the Table Limits and no interpolation method is selected, go to Error Processing Options.
- If an interpolation method is selected and the field format of the first key is nonnumeric, go to Error Processing Options.
- If an interpolation method is selected and the field format is numeric, go to the appropriate logic, based on the interpolation method process. See details of each interpolation method in the preceding table.
- If there's a mismatch on a subsequent key and no interpolation method is selected, go to Error Processing Options.
- If there's a mismatch on a subsequent key and an interpolation method is selected, consider only the rows where all keys have been matched.

Go to the appropriate logic based on the interpolation method process. Refer to the details of each interpolation method in the preceding table.

Bracket Name Page

Use the Bracket Name page (GP_PIN) to name the element and define its basic parameters.

Navigation:

Set Up HCM > Product Related > Global Payroll & Absence Mgmt > Elements > Supporting Elements > Brackets > Bracket Name

Note: You name every element and define its basic parameters on an element name page with the object name of GP_PIN. The page title and general appearance of this page change based on the type of Absence Management element that you are naming and defining.

Related Links

[Defining Element Names](#)

Lookup Rules Page

Use the Lookup Rules page (GP_BRACKET1) to define the lookup rules for a bracket.

Navigation:

Set Up HCM > Product Related > Global Payroll & Absence Mgmt > Elements > Supporting Elements > Brackets > Lookup Rules

This example illustrates the fields and controls on the Lookup Rules page.

| Field or Control | Description |
|---------------------------------|--|
| Error Processing Options | Select from the following values: <i>Generate Error:</i> Stops processing and generates an error. <i>Continue Process:</i> Continues processing without returning any value. |
| Outside Table Limits | Defines what happens if the key values are over or under those that are defined in the table: <i>Use First Limit if Under:</i> Select if key values are under those that are defined in the table. <i>Use Last Limit if Over:</i> Select if key values are over those that are defined in the table. |

| Field or Control | Description |
|----------------------------------|--|
| Interpolation Method | <p>Select an interpolation method that defines the values to return if the system doesn't find an exact match; for example, if the key values are between two rows on the table. All interpolation methods use only one search key, the first mismatched one. Select from the following values:</p> <p><i>Linear:</i> Uses a mathematical formula to create a prorated value based on the next-higher and next-lower keys (works only with brackets that have one or two numeric keys and with numeric result columns).</p> <p><i>Use Nearest:</i> Uses the value from the row that has the nearest key (works only with brackets that have numeric or date keys).</p> <p><i>Use Next Higher:</i> Uses the value from the row that has the next-higher key (works with any bracket).</p> <p><i>Use Next Lower:</i> Uses the value from the row that has the next-lower key (works with any bracket).</p> <p>See Understanding Interpolation Methods.</p> |
| Use Lowest/Highest Option | <p>When using linear interpolation, the system matches on all search columns that have already been matched. Then it looks for the next-lower and next-higher rows where the search columns match. When there isn't a lower or higher row where search columns match, you can use the Use Lowest/Highest Option check box to indicate whether the system should take the lowest or highest matching option.</p> <p>See Understanding Interpolation Methods.</p> |
| Rounding Rule Element | <p>With linear interpolation, you can use a rounding rule to specify the type of rounding for the returned value. The system applies this rounding rule to all return columns whose field format is numeric (decimal or monetary), because linear interpolation takes the ratio of the next-lower return column value and the next-higher value and returns the prorated value based on the ratio that is above the next-lower value. The result might be an excess of decimal places.</p> <p>See Understanding Interpolation Methods.</p> |

Search Keys/Return Columns Page

Use the Search Keys/Return Columns page (GP_BRACKET2) to identify the search keys and the return columns for the bracket.

Navigation:

Set Up HCM > Product Related > Global Payroll & Absence Mgmt > Elements > Supporting Elements > Brackets > Search Keys/Return Columns

This example illustrates the fields and controls on the Search Keys/Return Columns page.

The screenshot shows a web-based configuration interface for defining data retrieval elements. At the top, there are tabs for 'Bracket Name', 'Lookup Rules', 'Search Keys/Return Columns', and 'Data'. Below the tabs, the 'Element Name' is 'ABS BR IJSS DTS/TX', the description is 'Daily allwce entit & rates', and the 'Owner' is 'PS Non-Mnt'. The 'Definition' section shows 'Effective Date' as '01/01/2006' and 'Status' as 'Active'. There are navigation links for 'Find | View All' and 'First 1 of 1 Last'. The 'Search Columns' section contains five rows, each with a '*Search Key X Type' dropdown and an '*Element Name - Key X' text input field. The first two rows are populated: Key 1 Type is 'Variable' and Key 2 Type is 'Formula'. The 'Return Columns' section contains eight rows, each with a 'Return Entry Type X' dropdown and an 'Element Name - Value X' text input field. The first row is populated with 'Bracket' as the entry type. The rest of the fields are empty.

Search Columns

In the **Search Columns** group box, select the keys that the system uses to search the bracket data. For each key, select the **Search Key Type** (element type) that you're entering. Then select the corresponding **Element Name**. You can enter up to five search keys.

Return Columns

In the **Return Columns** group box, select the columns that tell the system where to store the values returned by the lookup. For each column, select the **Return Entry Type**(element type) that you're entering. Then select the corresponding **Element Name**. The bracket itself is the first returned column. You can enter up to eight return columns.

Brackets - Data Page

Use the Data page (GP_BRACKET3) to enter lookup values.

The search key values and the return column values that you selected in the Brackets - Search Keys/Return Columns page appear here.

Navigation:

Set Up HCM > Product Related > Global Payroll & Absence Mgmt > Elements > Supporting Elements > Brackets > Data

This example illustrates the fields and controls on the Data page.

The screenshot shows the 'Data' tab of the Oracle HRMS interface. At the top, the 'Element Name' is 'ABS BR IJSS DTS/TX' and the 'Owner' is 'PS Non-Mnt'. Below this, the 'Definition' section shows 'Effective Date' as '01/01/2006' and 'Status' as 'Active'. The main section is titled 'Bracket Search Keys and Return Column Values' and contains a table with the following data:

| Search Key | Return Column 1-4 | Return Column 5-8 | Search Key | Value | Controls |
|------------------|-------------------|-------------------|------------------|----------|----------|
| ABS VR NOM PRISE | | | ABS FM ENF BR IJ | | |
| CURE | | | | 0.000000 | + - |
| LG MALADIE | | | | 0.000000 | + - |
| LG MALADIE | | | | 3.000000 | + - |
| MALADIE | | | | 0.000000 | + - |
| MALADIE | | | | 3.000000 | + - |
| PATHOAP | | | | 0.000000 | + - |
| PATHOAP | | | | 3.000000 | + - |
| PATHOAV | | | | 0.000000 | + - |
| TRAVAIL | | | | 0.000000 | + - |

Bracket Search Keys and Return Column Values - Search Keys Tab

Enter the values of the search keys.

Bracket Search Keys and Return Column Values - Return Columns Tab

Enter the values to be returned for each search key value, based on your entries on the Search Keys/Return Columns page. You can enter multiple return values.

Bracket Data Page

Use the Bracket Data page (GP_BRACKET_DATA) to update search key values and return column values for existing bracket elements.

Navigation:

Set Up HCM > Product Related > Global Payroll & Absence Mgmt > Elements > Supporting Elements > Bracket Data

This example illustrates the fields and controls on the Bracket Data page.

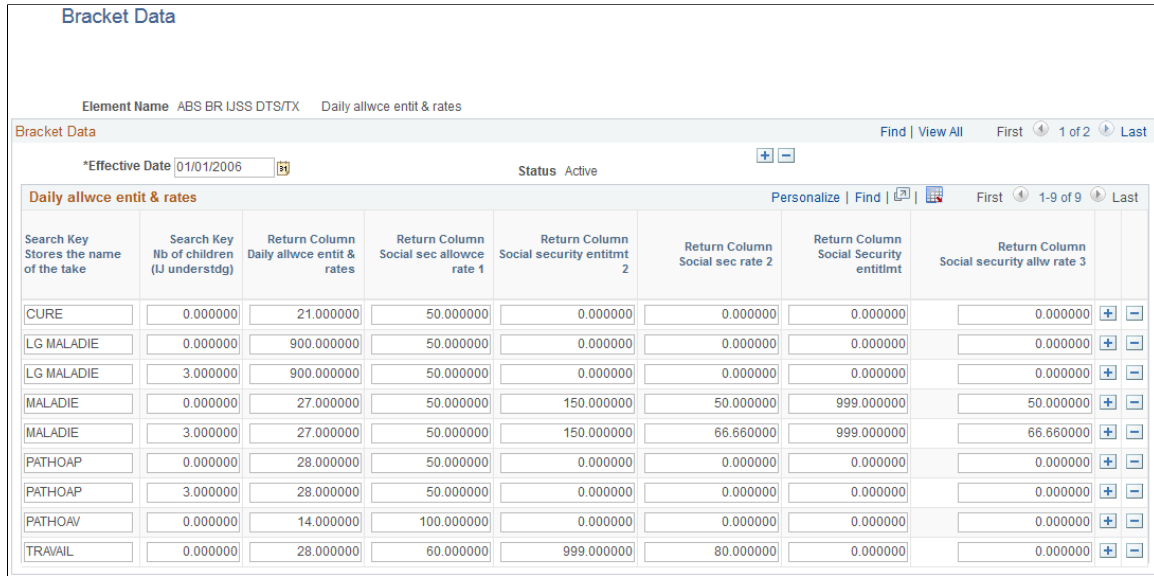

This page provides administrators with an easy way to update the search key values and return values for an existing bracket. You define the original search keys, return columns, and lookup values for brackets using the [Search Keys/Return Columns Page](#) and [Brackets - Data Page](#).

Defining Rate Code Elements

Pages Used to Create Rate Code Elements

| <i>Page Name</i> | <i>Definition Name</i> | <i>Usage</i> |
|-------------------------------------|------------------------|--|
| Rate Code Name Page | GP_PIN | Name the element and define its basic parameters. |
| Definition Page | GP_RATE_CODE | Create a rate code element and map it to a rate code defined in HR. You can also use the page to view rate code elements and change the mapping. |

Understanding Rate Code Mapping

You can use rate code elements to retrieve multiple components of pay that have been defined in HR—including base pay and non base-pay components.

To have the system retrieve the rate codes set up in HR, matching rate code elements must be defined in Absence Management and mapped to the corresponding HR rate codes. A HR rate code can be associated with only one Absence Management rate code element.

Rate code elements can be defined and mapped to HR rate codes in two ways:

1. If you install Absence Management after creating rate codes in HR, use the Rate Codes - Definition page to create rate code elements and map them to the corresponding rate codes in HR.

Mapping an element to a HR rate code makes the element take on the values of the HR rate code.

2. If Absence Management is installed when you create rate codes in HR, the creation of the rate code element is dependant on if a row exists on the User Rules Profile page for the rate code creators user ID.
 - a. If there is an entry on the User Rules Profile page for the User ID of the person who is creating the Rate Code in HR a matching rate code element is created automatically in Absence Management. This rate code will have the same Used By and Country values on the Rate Code Name page that are defined for the User ID of the person creating the rate code. If a different one is desired, a user will a user ID of All Countries will have to modify the rate code with the applicable change to the Used By and Country fields.
 - b. If there is no entry on the User Rules Profile page for the User ID of the person creating the Rate Code in HR, the system does not create a rate code in Global Payroll. It handles it just as in the same manner as described in #1 above. A user with the appropriate User ID set up on the User Rules Profile page will have to go into the Rate Code element in Global Payroll to create the rate code element.

See [Restricting User Access](#).

You can display the rate code elements via the Rate Codes - Definition page in Absence Management. You can also use the page to map the element to a different rate code.

This table lists the values that appear on the Rate Codes - Definition page:

| Field | Value |
|---------------------------|---------------------------|
| Name | Same as HR Rate Code Name |
| Element Type | Rate Code (RC) |
| Description | HR Rate Code description |
| Field Format | Decimal |
| Use Defn As Of | Calendar Period End Date |
| Always Recalculate | Off (No) |
| Owner | Customer Maintained |
| Class | Not Classified |

| Field | Value |
|------------------------|---|
| Used By | Same as the Used By value defined on the User Rules Profile page for the person creating the Rate Code in HR. |
| Country | Same as the Country value defined on the User Rules Profile page for the person creating the Rate Code in HR. |
| Industry/Region | Blank |
| Category | Blank |
| Override Levels | All options set to Off (No) |
| Store | On (Yes) |
| Store if Zero | On (Yes) |
| Customer Fields | Blank |
| Comments | Blank |

Understanding the Use of Rate Code Elements

Rate code elements return the values of rate codes defined in HR. To use a rate code to calculate a payee's absence information, use the rate code in the absence element definition—either directly, as part of the absence calculation rule, or within a formula or other element used by the absence calculation rule.

Related Links

[Ordering Elements and Sections in a Process List](#)

Understanding Batch Processing of Rate Code Elements

When the system encounters a rate code element during the absence process, it calls the Rate Code PIN Resolution program, which first determines whether the element, effective on the calendar period end date, represents a base pay rate code or a non base-pay rate code. It then follows the hierarchy for base pay or non base-pay rate code elements, as appropriate, to resolve the rate code.

Criteria for Selecting the Job Row

Absence Management uses the RATE AS OF DATE system element to determine to which maximum effective-dated job row it refers for the rate code.

- If RATE AS OF DATE is unpopulated, the system uses the end date of the current slice or segment to select the job row.

- If RATE AS OF DATE is greater than the calendar period end date, the system uses the calendar period end date to select the job row.
- If RATE AS OF DATE is before the first effective date on job, the rate code resolves to 0 and the payment is put in error.
- In all other cases, RATE AS OF DATE is used.

The FTE factor that applies to some rate codes is retrieved from the maximum effective-dated job row that is less than or equal to the RATE AS OF DATE or slice end date where the payment keys match.

Currency Conversion

When the currency code for a flat amount, hourly, or hourly plus flat amount rate code, as defined in HR, doesn't match the processing currency, Absence Management performs its standard currency conversion during processing. That is, it uses the payee's effective-dated exchange rate type to perform the conversion.

Note: Currency conversion is not required on percent or point rate codes, because returned values are non monetary.

Frequency Conversion

Absence Management also performs frequency conversion on any flat amount or hourly plus flat amount rate code, where the corresponding frequency code in HR doesn't match the calendar period frequency. The system annualizes the rate code using the corresponding frequency factor from HR. It then deannualizes for the calendar period frequency (using the applicable frequency factor). Define all earning elements that use rate codes as Use Calendar Period Frequency.

Note: Frequency conversion is not required on percent or point rate codes, because returned values are non monetary.

Resolving Multiple Instances of the Same Rate Code Element

If the PS_COMPENSATION record contains multiple instances for the same rate code (base pay or non base-pay), the system evaluates each instance separately, sums the instances, and returns one value to the rate code element. Absence Management references two system elements, RATE CODE GROUP and FTE INDICATOR, and applies the following rules:

- If the Rate Code Group differs between the instances, the system element RATE CODE GROUP is resolved according to the last instance and an error message is generated.
- If the FTE indicator differs between instances, the system resolves the system element named FTE INDICATOR according to the last instance and issues a warning message. The payee is not put into an error status. (Absence Management uses the FTE INDICATOR only for rate codes types of flat amount and hourly plus flat amount.)

For example, if a flat amount rate code has one instance in which FTE applies, Absence Management uses the FTE_COMPRATE for this instance. If a second instance indicates that FTE doesn't apply, the system uses the COMPRATE field value for the second instance and sums the two instances.

Hierarchy for Resolving Base Pay Rate Code Elements

When the system encounters a rate code element that's mapped to a HR base pay rate code, it finds the appropriate rows on the PS_COMPENSATION record, where the element matches the rate code. It then identifies the value to be returned, based on the rate code type, as shown in this table:

| Rate Code Type | Fields Evaluated on PS_ COMPENSATION | Value Returned for Rate Code |
|-----------------------|---|--|
| Percent | COMP_PCT | Percent |
| Points | COMP_RATE_POINTS | Points |
| Flat Amount | COMPRATE and FTE_INDICATOR | If FTE_INDICATOR = Yes, return COMPRATE * FTE factor (stored on JOB) If FTE_INDICATOR = No, return COMPRATE |
| Hourly | COMPRATE | Hourly rate |

Hierarchy for Resolving Non Base-Pay Rate Code Elements

When the system encounters a rate code element that's mapped to a HR non base-pay rate code, it derives the rate from the following hierarchy, stopping when it finds the rate:

- Compensation table (PS_COMPENSATION).
- Job Code table (PS_JOB_CD_COMP_RATE).

The system looks for the row where the **SetID** and **Job** code fields match the SETID_JOB_CODE and JOB_CODE system elements.

- HR Comp Rate table (PS_COMP_RATE_CD_TBL).

The system identifies the value to be returned, based on the rate code type and FTE_INDICATOR, as shown in this table:

| Rate Code Type | Fields Evaluated on PS_ COMPENSATION | Value Returned for Rate Code |
|-----------------------|---|-------------------------------------|
| Percent | COMP_PCT | Percent |
| Points | COMP_RATE_POINTS | Points |

| Rate Code Type | Fields Evaluated on PS_ COMPENSATION | Value Returned for Rate Code |
|--------------------------------------|---|---|
| Flat Amount, or Hourly + Flat Amount | COMP_RATE FTE_INDICATOR | If FTE_INDICATOR = Yes, return COMPRATE * FTE factor (stored on JOB) If FTE_INDICATOR = No, return COMPRATE |
| Hourly | COMPRATE | Hourly rate |

Common Elements Used in This Section

| Field or Control | Description |
|-----------------------------------|--|
| Base pay components | Components that contribute to a payee's base pay are called base pay components. All base pay components are stored in the PS_COMPENSATION record in HR. |
| Multiple components of pay | This functionality enables your organization to compensate a payee at more than one <i>rate</i> of pay, such as regular pay and merit pay. Components can represent a flat amount, hourly rate, hourly rate plus flat amount, percentage of the worker's compensation package, or salary points. |
| Non-base-pay components | Components that do not contribute to base pay are called non base-pay components and may or may not be stored in the PS_COMPENSATION record. When you run the absence process, the system follows a hierarchy to determine the applicable rate. |

Rate Code Name Page

Use the Rate Code Name page (GP_PIN) to name the element and define its basic parameters.

Navigation:

Set Up HCM > Product Related > Global Payroll & Absence Mgmt > Elements > Supporting Elements > Rate Codes > Rate Code Name

Note: You name every element and define its basic parameters on an element name page with the object name of GP_PIN. The page title and general appearance of this page change based on the type of Absence Management element that you are naming and defining.

Related Links

[Defining Element Names](#)

Definition Page

Use the Definition page (GP_RATE_CODE) to create a rate code element and map it to a rate code defined in HR.

You can also use the page to view rate code elements and change the mapping.

Navigation:

Set Up HCM > Product Related > Global Payroll & Absence Mgmt > Elements > Supporting Elements > Rate Codes > Definition

This example illustrates the fields and controls on the Rate Codes - Definition page.

| Field or Control | Description |
|-------------------------------|--|
| Compensation Rate Code | Enter the HR rate code to which you want to map this element. When you select the rate code, the lower half of the page displays information that is defined for the rate code in HR. You cannot change this information in Absence Management. |
| Frequency Conversion | This check box is selected by default to indicate that the system is to perform frequency conversion (annualization and deannualization) on the value returned by the rate code. Clear this check box if you want the system to return the value from the rate code definition without performing frequency conversion. |

| Field or Control | Description |
|-------------------------|--|
| Generate Warning | <p>This check box applies only to rate codes that represent a base pay component. It is selected automatically to indicate that the system generates a warning message during batch processing if it does not find the rate code on the payee's compensation record.</p> <p>Clear the check box if you do not want the system to generate a warning message in these situations.</p> |

Related Links

[Understanding Data Retrieval from HR](#)

Defining Historical Rule Elements

To define historical rule elements, use the Historical Rules (GP_HIST_RULE) component.

Pages Used to Define Historical Rule Elements

| Page Name | Definition Name | Usage |
|--|------------------------|---|
| Historical Calculation Name Page | GP_PIN | Name the element and define its basic parameters. |
| Processing Period Page | GP_HIST_RULE1 | Define the details of the processing period for the historical rule. Depending on what you select as the rule type, some fields may not be available for entry. |
| Parameters and Mapping Page | GP_HIST_RULE2 | Define the formula for a historical rule. |

Understanding Historical Rule Elements

You can use historical rule elements to set up rules that retrieve data from prior periods. Historical rules can be used in formulas.

A historical rule can be associated with any element that's stored in the Earnings/Deductions results table, Accumulators results table, or Other Elements results table.

To define a historical rule:

1. Define the naming information for the historical rule on the Historical Rules Name page.
2. Define the rule type and the periods to be processed on the Processing Period page.
3. Define the formula for a historical rule on the Parameters and Mapping page.

Understanding Batch Processing of Historical Rule Elements

You can attach a historical rule to an earning or deduction element on the Formula Definition page or to any element that's stored in the Earnings/Deductions results table (GP_RSLT_ERN_DED), Accumulators results table (GP_RSLT_ACUM), or Other Elements results table (GP_RSLT_PIN).

A historical rule resolves to one if it's successful and to zero if it's not successful. This works the same way as an array element. A historical rule can then be used in a formula such as:

```
IF HIST_RULE_TEST =1, THEN
```

```
Use variable elements populated by historical rule
```

```
ELSE
```

```
Generate an error
```

```
END-IF
```

A historical rule is set to one when either the end-of-process formula resolves without errors, or if that formula is not used in the processes, the stop-process-if-true variable is set to TRUE.

In all other situations, a historical rule is set to zero and SQL returns no data.

How the System Processes Historical Rule Elements

Here's how the system processes historical rules:

1. The system dynamically creates SQL to load elements requested from the Absence Management result tables.

It can get data from multiple result tables at one time by using a SQL UNION, meaning direct access to the database each time the historical rule is called. A SELECT and a series of FETCHES are performed each time. The use of this element type affects performance.

2. The system maps columns to variables.

The variables are available for use in a formula.

3. The first fetch establishes the keys for the first retrieved segment.

The program continues fetching records until there is a break in the segment keys. It then populates the input and output interface copybook (PINL) with the values for the retrieved elements or with the null values for the elements in the element mapping that were not found. Then the program requests the resolution of Formula to Execute By Segment.

4. The system performs formula resolution per segment.

5. The system resolves an end of process formula for additional calculations such as averaging.

This table lists how calendars and segments are processed in the reverse order in which they were initially run:

| <i>Original Processing Sequence</i> | <i>Processing Sequence for Historical Rules</i> |
|-------------------------------------|---|
| January absence calendar | February absence calendar |
| February absence calendar | January absence calendar |

Historical Calculation Name Page

Use the Historical Calculation Name page (GP_PIN) to name the element and define its basic parameters.

Navigation:

Set Up HCM > Product Related > Global Payroll & Absence Mgmt > Elements > Supporting Elements > Historical Rules > Historical Calculation Name

Note: You name every element and define its basic parameters on an element name page with the object name of GP_PIN. The page title and general appearance of this page change based on the type of Absence Management element that you are naming and defining.

Related Links

[Defining Element Names](#)

Processing Period Page

Use the Processing Period page (GP_HIST_RULE1) to define the details of the processing period for the historical rule.

Depending on what you select as the rule type, some fields may not be available for entry.

Navigation:

Set Up HCM > Product Related > Global Payroll & Absence Mgmt > Elements > Supporting Elements > Historical Rules > Processing Period

This example illustrates the fields and controls on the Processing Period page.

Note: On the Processing Period page, you create the periods from the *date from* to the *date to* date. You then map the selected result data to the processing periods. If no data exists for an element in a period, it is set to spaces for character and date elements and to zeros for numeric and monetary elements.

| Field or Control | Description |
|----------------------------------|---|
| Rule Type | <p>Select the type of historical rule from these options:</p> <p><i>Use in Fictitious Calculation:</i> This is not used with Absence Management.</p> <p><i>Retrieve Values:</i> Select when you want to use a historical rule element in a formula to retrieve previously calculated values.</p> |
| Go back from Date Range | <p>Define the date from, date to type, date from element, and date to element to establish the rule's date range. If you select a <i>Retrieve Values</i> rule type, this field appears as Go Back From Date Range.</p> <p>Select from the following values in the Date From Type and Date To Type fields:</p> <p><i>Bracket</i></p> <p><i>Cal Date</i> (calendar date) Enter a date instead of an element that resolves to a date. In the next field, specify the date to start going back from.</p> <p><i>Date</i></p> <p><i>Formula</i></p> <p><i>SystemElem</i> (system element)</p> <p><i>Variable</i></p> |
| Use Based On | <p>Select a date that tells the system which data values from the GP_RSLT tables are processed by a historical rule. Select from these values: <i>Period End Date</i>, <i>Period Begin Date</i> or <i>Payment Date</i>.</p> |
| Log statement at run time | <p>Select this check box to see the text of the SQL statement dynamically generated by the array module during batch processing. You can direct the output display into a file by selecting the Redirect Output option in PeopleTools Configuration Manager.</p> |

Example

You want to determine three months of salary (element SALARY) for the period between March 28 and June 27. This table lists the GP_RSLT table values:

| Period Payment Date | Result | Period Begin | Period End Date | Payment Date |
|----------------------------|---------------|---------------------|------------------------|---------------------|
| January 2003 | 100 | January 1, 2003 | January 31, 2003 | February 2, 2003 |
| February 2003 | 100 | February 1, 2003 | February 28, 2003 | March 2, 2003 |
| March 2003 | 100 | March 1, 2003 | March 31, 2003 | April 2, 2003 |
| April 2003 | 100 | April 1, 2003 | April 30, 2003 | May 2, 2003 |
| May 2003 | 100 | May 1, 2003 | May 31, 2003 | June 2, 2003 |
| June 2003 | 100 | June 1, 2003 | June 30, 2003 | July 2, 2003 |
| July 2003 | 100 | July 1, 2003 | July 31, 2003 | August 2, 2003 |

If you select *Period Begin Date*, the historical rule processes only June, May, and April. It does not process July, because July 1, 2003 (the period begin date) is later than the date from date of the historical period (June 27, 2003). It also does not process March, because March 1, 2003 (the period begin date) is before the date to date of the historical period (March 28, 2003).

Note: Historical rules start from the date from date and look at periods and segments in the reverse order in which they were originally processed and go back to the date to date.

If you select *Period End Date*, the rule processes May, April, and March. It does not process June, because June 30, 2003 (the period end date) is later than the date from date of the historical period (June 27, 2003). It also does not process February, because February 28, 2003 (the period end date) is before the date to date of the historical period (March 28, 2003).

If you select *Payment Date*, the rule processes May, April, and March. It does not process June, because July 2, 2003 (the payment date) is later than the date from date of the historical period (June 27, 2003). It also does not process February, because March 2, 2003 (the payment date) is before the date to date of the historical period (March 28, 2003).

See the product documentation for *PeopleTools: Data Management*

Related Links

[Understanding Segmentation Setup](#)

Parameters and Mapping Page

Use the Parameters and Mapping page (GP_HIST_RULE2) to define the formula for a historical rule.

Navigation:

Set Up HCM > Product Related > Global Payroll & Absence Mgmt > Elements > Supporting Elements > Historical Rules > Parameters and Mapping

This example illustrates the fields and controls on the Parameters and Mapping page.

When you run an absence run, the system resolves the **Formula to Execute by Segment** field per historical period until the **Stop Process If True** variable is not equal to zero or the last historical period is processed. The system then resolves the formula specified in the **Formula To Execute at End** field.

| Field or Control | Description |
|--------------------------------------|--|
| Formula to Execute By Segment | Enter the formula to be resolved for each segment or period. |
| Stop Process If True | Enter a variable. The process keeps looping through periods, resolving the formula for each period, until this variable doesn't equal zero, the date to date is reached, or no more data is found. |
| Formula To Execute At End | Select the formula to resolve when period processing is completed. |
| Use Period If True | This field appears for <i>Use in Fictitious Calculation</i> rule types only. This is not used with Absence Management. |

Element Mapping

The grid in the **Element Mapping** group box lists the elements for retrieval from the Absence Management result tables for a historical rule.

| Field or Control | Description |
|-------------------------|---|
| Element Type | Select the type of element—such as the earning, deduction, or variable—to retrieve. |

| Field or Control | Description |
|----------------------------------|---|
| Historical Period Element | Enter the element that you want to retrieve. |
| Current Period Element | Enter the variable in which the retrieved value is to be stored. This variable becomes available for use in the Formula to Execute By Segment field. |
| Slice Option | <p>Specify how the system resolves multiple instances of an element in the historical period. Values are:</p> <ul style="list-style-type: none"> • <i>Sum Slices</i>: The system sums all slices. • <i>Use Last Slice</i>: The system uses the value of only the last slice. • <i>Sum Slices - Current Empl Rcd</i>: The system sums all slices, but only for rows of data where the EMPL_RCD equals the current EMPL_RCD. • <i>Use Last Slice - Cur. Empl Rcd</i>: The system uses the value of only the last slice, but only for rows of data where the EMPL_RCD equals the current EMPL_RCD. |

Defining Calculation Elements

Understanding Calculation Elements

Supporting elements are the building blocks of your system. Calculation elements, a subset of supporting elements, assist in the calculation process and are used to further refine the more complex elements.

This topic discusses:

- Calculation element names
- Element pointers

Calculation Element Names

You must name every element and define its basic parameters on an Element Name page. All element page components share the same first Element Name page (GP_PIN).

Related Links

[Defining Element Names](#)

Element Pointers

An element pointer is an element that points to another element by its system identifying number (PIN).

Once you define an element, its value may change. This presents a dilemma when you try to use elements to calculate other elements. The problem is especially evident when you are creating formulas. Element pointers help you alleviate this problem.

Advantages of Element Pointers

The following are advantages of using element pointers:

- You can use them in formulas to make formulas generic and reusable.
- Different absence calculations can use the same formula.
- When you define a formula, the values for the various elements that constitute the formula will likely change. Rather than referring to the element's value, you can refer to its system identifying number—its *element number*.
- Because you point to its element number—which remains constant—a formula using the element can remain useful over time because the element values will be valid.

Elements that can Use Element Pointers

Pointers can reference almost all elements that use the Definition page.

Use the following major elements to retrieve, store, and assign element pointers:

- Variables
- Brackets

When using brackets, element pointers can store values that are returned by the lookup. Select a pointer for storing bracket values on the Search Keys/Return Column page.

- Formulas
- Arrays

Use a pointer to tell the system that a column to be retrieved contains a PIN number. Use the Fields Retrieved page to enter instructions for retrieving columns for an array

Related Links

[Understanding Element Pointers in Formulas](#)

Defining Duration Elements

To define duration elements, use the Durations (GP_DURATION) component.

Pages Used to Define Duration Elements

| <i>Page Name</i> | <i>Definition Name</i> | <i>Usage</i> |
|---|------------------------|--|
| Duration Name Page | GP_PIN | Name the element and define its basic parameters. |
| Definition Page | GP_DURATION | Define the number of days, months, or years between two dates. |
| Set Daily HR Status Criteria Page | GP_DUR_STAT_SEC | Specify time periods for duration calculation, excluding or including them according to HR status codes. |

Understanding Duration Elements

A duration element calculates the time between two dates, by subtracting one date from another. For example, age at Pay Period End Date is calculated as Pay Period End Date minus Birth Date. The resulting value is a duration.

Duration elements always resolve to a number. You can define durations in years, months, or days. If you define duration in days, you can include or exclude certain periods of time based on PeopleSoft HR status codes. You can also include or exclude absence days that have been entered in Absence Management.

Including or Excluding Absences

The Include Absence Days check box on the Durations - Definition page is typically used to exclude absence days from a duration. For example, say that you are calculating a service duration and want to exclude sick days. The daily absence formula will be resolved for each day between the absence begin date and end date. Have the formula return a 1 for each paid sick day (else return a zero). The duration program will sum up each day's value. If a payee was sick 15 days within this time period and the Include Absence Days check box page is not selected, the system subtracts 15 from the total number of calendar days in the period.

Your formula can call any of the system elements that are designed specifically for absence duration. These elements have the same names as those that are used to generate the absence daily data, but they end with the suffix DU. For example, you can use the system element, ABS END DATE DU, to retrieve an absence end date for a particular absence.

Example 1: Rounding

On the Duration - Definition page, you can define whether the duration is a decimal and how to round the duration. This topic provides an example of how rounding works for decimal durations.

The result (before rounding) is 2 years, 5 months, and 20 days and you want the result in months, without rounding. The result is:

$$(2 \text{ Years} * 12) + 5 \text{ Months} = 29 \text{ Months} + 20/30 = 29.666667$$

If the **Return Duration With Decimals** check box is cleared, the value is 29.

If you select the **Return Duration With Decimals** check box and **Add 1 Month if Days**, with a value of 15, the result is:

$$(2 \text{ Years} * 12) + 5 \text{ Months} + 1 \text{ Month (because days are } > 15) = 30$$

The small difference in the results can be significant when the duration resolution is used throughout the system.

Example 2: Rounding

In this example, assume that:

The Duration From date is January 1, 1999 and the Duration To date is January 31, 2001.

This table illustrates how various options, used together, affect the value returned by a duration element (the system's standard field size is 12.6, so all values are shown to the full six decimal places):

| Return Duration In | Rounding Add 1 Year If Months >= | Rounding Add 1 Month If Days >= | Return Duration With Decimals | Value |
|---------------------------|--|---|--|--|
| Years | No | No | Yes | 2.083333 |
| Years | No | No | No | 2.000000 |
| Years | Yes, 1 | No | No | 2.000000 |
| Months | No | No | Yes | 25.000000 |
| Months | No | Yes, 15 | No | 25.000000 |
| Days | | | Yes | Impossible. An online error message appears. |
| Days | No | No | No Inclusive = No | 761.000000 |
| Days | No | No | No Inclusive = Yes | 762.000000 |

Note: The Duration program uses the PeopleTools utility PTPDTWRK to get the difference between two dates. When the GP Duration option is to return the value in Years, PTPDTWRK is called with the AGE option, which gives a result in years, months, and days. For example, when the dates are April 1, 2003 to April 1, 2004 PTPDTWRK returns 1 year, 0 months, and 0 days. When the end date is March 31, 2004, PTPDTWRK returns 0 years, 11 months, and 30 days. You might think that the decimal difference between these two dates would be calculated as $364/365 = .99726$, but this is not what is happening. PTPDTWRK can return the value between dates in days, but to convert this into years would require calculating the number of leap years involved .

Including/Excluding HR Status Days

Using the Set Daily HR Status Criteria page you can include or exclude time periods from the duration calculation, based on HR status codes.

If status **Include** or **Exclude** criteria are defined as part of the duration definition:

- The Date From date cannot be earlier than the first effective-dated PS_JOB row.

If the Date From date is before the first effective-dated PS_JOB row, the duration calculation uses the earliest effective-dated PS_JOB row for this EmplID/Empl_Rcd combination as the default Date From date. The duration calculation doesn't limit the Date From date based on other fields.

- The Date To date cannot be after the Calendar Period End Date.

If the Date To date is after the Period End Date, the duration calculation uses the Period End Date as the default Date To date.

- Only the maximum effective sequence PS_JOB row is considered, because any non maximum effective sequence PS_JOB rows mean nothing from a status perspective.
- No warnings or errors are issued if the Date From or Date To dates are modified to be the effective date of the first PS_JOB row or the Period End Date in the above situations.

For example, if the first effective date PS_JOB row is January 7, 1995 but the Date From date is January 1, 1995, the system uses January 7, 1995 because the Date From date cannot be less than the first PS_JOB effective date.

Note: Payment keys are ignored in Status Control **Include** or **Exclude** calculations.

Example 1: Including/Excluding HR Status Days

For this example, assume the following:

Date From: January 1, 2000.

Date To: January 31, 2000.

Unit of measure: Days.

Include From and To Date selected.

Payee Status: Leave effective January 22, 2000

Days Active: 21 Days, Inactive: 10, Result of absence formula: 5

This table shows how the system resolves the duration value, based on various Include/Exclude options:

| <i>HR Status</i> | <i>Absence Formula</i> | <i>Duration with Inclusive ON</i> | <i>Duration with Inclusive OFF</i> | <i>Reason</i> |
|-------------------------|-------------------------------|--|---|----------------------------|
| Include-Active | Blank | 21 days | 21 days | Active days only |
| Include-Inactive | Blank | 10 days | 9 days | Leave days only |
| Include-Active | Include | 26 days | 26 days | Active Days + Formula Days |
| Include-Inactive | Include | 15 days | 14 days | Leave Days + Formula Days |
| Include-Active | Exclude | 16 days | 16 days | Active Days - Formula Days |

| HR Status | Absence Formula | Duration with Inclusive ON | Duration with Inclusive OFF | Reason |
|------------------|------------------------|-----------------------------------|------------------------------------|----------------------------|
| Include-Inactive | Exclude | 5 days | 4 days | Leave Days - Formula Days |
| Blank | Include | 5 days | 5 days | Formula Days only |
| Blank | Exclude | 26 days | 25 days | Total Days - Formula Days |
| Blank | Blank | 31 days | 30 days | Total Days |
| Exclude-Active | Blank | 10 days | 9 days | Leave Days only |
| Exclude-Inactive | Blank | 21 days | 21 days | Active Days only |
| Exclude-Active | Include | 15 days | 14 days | Leave Days + Formula Days |
| Exclude-Inactive | Include | 26 days | 26 days | Active Days + Formula Days |
| Exclude-Active | Exclude | 5 days | 4 days | Leave Days - Formula Days |
| Exclude-Inactive | Exclude | 16 days | 16 days | Active Days - Formula Days |

Example 2: Including/Excluding HR Status Days

Assume that a duration is set up as follows:

- Date From: June 23, 2005.
- Date To: September 23, 2005.

A sub period is defined as follows:

- Include if status is *Active*.
- Sub period > 5 days.

This table lists a payee's PS_JOB rows:

| Status | Effective Date |
|---------------|-----------------------|
| Active | June 23, 2005 |
| Suspended | July 1, 2005 |
| Active | August 1, 2005 |
| Terminated | August 10, 2005 |

The duration resolves to eight days (first Active) plus nine days (second Active), meaning a value of 17 days. Both Active periods are included because they are both greater than five days.

Note: Payment keys and fields besides **Employee Status** aren't considered during the **Status** inclusion/exclusion calculations.

Only PS_JOB rows that are less than or equal to the period end date are considered. The Date From or Date To dates can be modified to be the effective date of the first PS_JOB row, or the Period End Date, because of the system rule that the Date From date cannot be before the first PS_JOB effective date.

Related Links

[“Understanding Job Data” \(PeopleSoft Human Resources Administer Workforce\)](#)

[The Absence Take Process](#)

Understanding Batch Processing of Duration Elements

The duration module resolves a duration element by:

1. Resolving Date From and Date To, if needed.
2. If there are status entries, validating that the first PS_JOB row isn't less than the Date From and that Date To isn't after the period end date.
3. Calculating the duration period (years, months, or days) between Date From and Date To.
4. If there are Human Resource status entries, processing them.
5. Including or excluding absence days, if applicable.
6. Applying rounding.
7. Truncating decimals if Return Duration With Decimals isn't selected.

If you've indicated on the Duration - Definition page that the value should be returned in years and you've selected both the **Add 1 Year if Months >=** and **Add 1 Month if Days >=** options, the system evaluates the **Add 1 Month if Days >=** option and then evaluates and applies the **Add 1 Year if Months >=** option.

Duration Name Page

Use the Duration Name page (GP_PIN) to name the element and define its basic parameters.

Navigation:

Set Up HCM > Product Related > Global Payroll & Absence Mgmt > Elements > Supporting Elements > Durations > Duration Name

You name every element and define its basic parameters on an Element Name page. All element components in Absence Management share the same Element Name page (GP_PIN).

Related Links

[Defining Element Names](#)

Definition Page

Use the Definition page (GP_DURATION) to define the number of days, months, or years between two dates.

Navigation:

Set Up HCM > Product Related > Global Payroll & Absence Mgmt > Elements > Supporting Elements > Durations > Definition

This example illustrates the fields and controls on the Durations - Definition page.

| Element Name | PR | DR | DAYS | PRD | Days in current period | Owner | PS | Non-Mnt |
|--------------|----|----|------|-----|------------------------|-------|----|---------|
| Definition | | | | | | | | |

Effective Date: 01/01/1990 | *Status: Active

Define Input Parameters

*Date From Type: SystemElem | Date From: PERIOD BEGIN DATE

*Date To Type: SystemElem | Date To: PERIOD END DATE

Define Return Value

*Return Duration in: Days

Include From and To Date

Include Absence Days

Daily Absence Formula: | Set Daily HR Status Criteria

Version: P_8.00.00.00

| Field or Control | Description |
|---------------------------------|---|
| Date From Type and Date To Type | Select the type of element that returns the Date From and Date To days. Valid values are: <i>Bracket</i> , <i>Cal Date</i> (calendar date), <i>Date</i> , <i>Formula</i> , <i>System Elem</i> (system element), and <i>Variable</i> . |

| Field or Control | Description |
|------------------------------|---|
| Date From and Date To | <p>Define the first and last day that the system is to include in the duration calculation.</p> <p>Select the names of the elements that return the dates.</p> <p>If the Date From date is the same as or greater than the Date To date, the duration element resolves to zero.</p> |
| Return Duration in | <p>Select the unit of measure for the returned duration value. Valid values are:</p> <ul style="list-style-type: none"> • <i>Years</i> - Select to return the duration in years. This is the default value. • <i>Months</i> - Select to return the duration in months. • <i>Days</i> - Select to return the duration in days. <p>If you select <i>Days</i>, the Include From and To Date and Include Absence Days check boxes become available.</p> <p>Select the Include From and To Date check box to include the from and to dates in the calculation.</p> <p>For example, if the date from and date to are February 1, 2006 and February 5, 2006, and you select Include From and To Date, the system counts five days. If you don't select Include From and To Date, the system ignores the last day and returns a count of four. It also ignores the last day when it applies any instructions that you enter for including/excluding absences or including/excluding days based on HR status.</p> <p>(The system returns a value of zero when the begin date and end date are the same if you select <i>Days</i> but don't select Include From and To Date. It returns a value of one if you select Include From and To Date.)</p> |

| Field or Control | Description |
|-------------------------------------|---|
| Return Duration in Decimals | <p>Select to receive the duration result in decimal form. .</p> <p>If you select Return Duration in Decimals, the system converts durations to decimals after applying any rounding rules you may have defined.</p> <p>The system expresses the results as follows, depending on Return Duration in value:</p> <p><i>Years</i>: The system returns years and the remaining number of months and days in decimal form. To calculate the decimal amount, the system divides the number of days by 30 and adds the result to the number of months. It then divides the number of months by 12 and adds the result to the number of years. For example, a duration of two years and one month returns a value of 2.08333.</p> <p><i>Months</i>: The system returns the number of months plus any additional days (partial month) in decimal form. Days are divided by 30 for calculation of the decimal value.</p> <p><i>Days</i>: Invalid.</p> <hr/> <p>Note: A month is defined as the period between the first day of one month and the first day of the next month. For example, January 1, 2006 to January 31, 2006 isn't a month—it's 30 days. To make it a month, select Return Duration in Decimals. The system returns 30 days, which equals one month. If you don't select Return Duration in Decimals and you're counting months, the result is zero.</p> |
| Round months up from N days | Select and enter the number of days to which the system rounds the month. |
| Round years up from N months | Select and enter the number of the months to which the system rounds the year. |

These fields are used to apply rounding rules to the result of your duration calculation. If you do not select a check box, no rounding occurs.

If you select either of these check boxes, and the months or days value is greater than the value that you enter, the calculation adds one year or one month, respectively.

For example, if **Return Duration in** is *Years*, and you select **Round years up from N months** and enter 6, the system returns a duration of 3 years and 6 months as a value of 4 years.

Note: The system applies the selected rounding rule before converting durations to decimals. If you select the **Return Duration in Decimals** check box and a rounding option, the system rounds up the months or years, as applicable, leaving no decimal value.

| Field or Control | Description |
|---------------------------------|--|
| Include From and To Date | <p>This check box becomes available when the Return Date In value is <i>Days</i>.</p> <p>Select to include the from and to dates in the calculation.</p> |
| Include Absence Days | <p>Leave this check box cleared to exclude days. For example, if you leave this check box cleared, you can calculate a duration of time minus sick days.</p> <p>Select the Include Absence Days check box to include absence days in the duration calculation.</p> <p>This check box becomes available when the Return Date In value is <i>Days</i>.</p> <hr/> <p>Note: The system automatically excludes absences if you do not select Include Absence Days and specify a daily absence formula.</p> <hr/> |
| Daily Absence Formula | <p>This field becomes available when the Return Date In value is <i>Days</i>.</p> <p>To include or exclude the days that a payee is absent, select the formula that returns the number of absent days. To include the days that a payee is absent, you select the Include Absence Days check box. To exclude the days that a payee is absent, clear the Include Absence Days check box; now the number of absent days will be subtracted from the total duration count.</p> <p>The formula is resolved for every day of absence daily history between the from and to dates (including those dates), and should return a 1 for each absence day it wants to count. The duration program cumulates the formula for each row of absence daily data (GP_RSLT_ABS, which is the output of the Absence Take process) and totals the results of the formula for all of the rows where the absence dates fall within the From and the To dates. (Keep in mind that the first and last day is considered only if the Include From and To Date check box is selected.)</p> <p>Your formula must specify the take elements that you want to count. For example, you can use the absence type in an IF statement to count only sick time.</p> <p>Your formula can call any of the system elements that are designed specifically for absence duration. These elements have the same names as those that are used to generate the absence daily data, but they end with the suffix DU. For example, you can use the system element, ABS END DATE DU to retrieve an absence end date for a particular absence.</p> |

| Field or Control | Description |
|-------------------------------------|--|
| Set Daily HR Status Criteria | <p>This field becomes available when the Return Date In value is <i>Days</i>.</p> <p>Click this link to access the Set Daily HR Status Criteria page, where you can include or exclude time periods in the calculation based on HR status codes.</p> |

If you enter instructions to include daily absence data *and* include or exclude days based on status codes, the system performs two separate counts and combines the results. For example, if you include active days (based on HR status) and exclude absence days, the system counts the number of days the payee was active and subtracts the number of days the payee was absent.

Warning! Double counting can occur, depending on the instructions that you enter in the two group boxes. For example, if you include active days *and* days a payee is out sick, the days on which a payee is both active and sick are counted twice.

Set Daily HR Status Criteria Page

Use the Set Daily HR Status Criteria page (GP_DUR_STAT_SEC) to specify time periods for duration calculation, excluding or including them according to HR status codes.

Navigation:

Click the **Set Daily HR Status Criteria** link on the Durations - Definition page, which is activated when you select Days.

This example illustrates the fields and controls on the Set Daily HR Status Criteria page.

Generation Control HR Status

Durations

Set Daily HR Status Criteria

Indicate whether to include or exclude days based on the payee's HR status on the day. You can further indicate whether days should be included or excluded based on the time the payee was in that status. For example:

- Always include days when payee was Active.
- Include days when payee was suspended if he was in that status for less than a month.

Listed Status Should Be

Included

Excluded

List HR Status Personalize | Find | View All | | First 1 of 1 Last

| Pay Status | If Each Sub-Period | Operand | Value | Period | | |
|------------|--------------------------|---------|-------|--------|--|--|
| ▼ | <input type="checkbox"/> | | | | | |

If the unit of measure on the Durations - Definition page is set to *Days*, you can include or exclude time periods from the duration based on HR status codes. You can also specify minimum and maximum periods to check against.

| Field or Control | Description |
|--------------------------------|---|
| Listed Status Should Be | <p>Select Included or Excluded to include or exclude the status combinations that you specify in the List HR Status group box. Including or excluding status combinations has the following implications at processing time:</p> <p>Include directs the system to include the period with that status combination in the duration.</p> <p>Exclude directs the system to exclude the period with that status combination in the duration.</p> |

The code combinations that you enter are, as a group, either included or excluded, meaning that when you include specific status codes, those that you omit are automatically excluded. If you exclude certain codes, those that you don't exclude are automatically included.

The time period indicated includes the PS_JOB Effective Date.

Additional Period Definitions

Use the following fields to further define the periods that you want to include or exclude from the duration.

| Field or Control | Description |
|---------------------------|--|
| If Each Sub-Period | <p>Select to include or exclude sub periods of a specified length from the duration. A sub period is a consecutive number of days that a payee's status remains unchanged.</p> <p>Whether you can add sub periods together depends on whether the sub periods are in the same period. Sub periods are added together if they individually fulfill the criteria. The system calculates period by period; for each period, it checks the criteria that is defined on this page. If the criteria are met, the system considers the period for inclusion or exclusion. If the criteria are not met, the system ignores the period.</p> |
| Operand | <p>Select from <, <=, >, and >= to determine whether the time period is included in or excluded from the duration calculation. The operand is used with the Value and Period fields.</p> |
| Value | <p>The number of years, months, or days to include or exclude from the duration. This value is used with the operand to determine whether the length of time in the selected status is included in or excluded from the calculation.</p> |

| Field or Control | Description |
|-------------------------|---|
| Period | The period of time defined in the previous field: <i>Days</i> , <i>Months</i> , or <i>Years</i> . |

Defining Variable Elements

Pages Used to Define Variable Elements

| Page Name | Definition Name | Usage |
|------------------------------------|------------------------|--|
| <u>Variable Name Page</u> | GP_PIN | Name the element and define its basic parameters. |
| <u>Variables - Definition Page</u> | GP_VARIABLE | Define the value of a variable according to the format specified on the Variable Name page. |
| Variables By Category Page | GP_VARIABLE_BY_CAT | View or update the values of one or more variables within the same category. (Variables are assigned to categories on the Variable Name page.) One or two Values tabs can appear on this page: <ul style="list-style-type: none"> • The Numeric Values tab displays variables defined with decimal values or monetary values (along with the currency code). • The Character Values tab displays variables defined with character values or date values. You can't create or delete variables using this page. |

Understanding Variable Elements

Variables are a means of storing a value and using it later. In situations requiring you to input a value—whether in a formula, in a calculation component, or elsewhere—the system enables you to identify the input as a variable and use the same value repeatedly. Using variables, you can define this value and invoke it anywhere in your formulas and calculations.

Example

On January 1, the batch process resolves three formulas and two earnings using a numeric factor of 20 in their calculations. This factor changes to 25 on April 1. If you assign this factor a format type of *numeric*, you have to make five effective-dated changes, but if you define this factor as a variable element, you

have to make only one effective-dated change for the new factor, 25, to be used anywhere the variable is referenced.

Understanding Field Formats

Variables can be defined with any one of the following field formats:

- Character

The field length for variables with a character field format is 30 spaces.

- Date
- Decimal

The field length for variables with a decimal field format is 12.6.

- Monetary

The field length for variables with a monetary field format can be up to 12.6, depending on the currency code you are using.

- Pointer

Variables can be defined with the *Element Pointer* field format, which enables you to link a variable element to another element. This concept is useful when you use variable elements as components of a formula element to make the formula more generic and applicable to changing situations.

An element pointer is a means of storing the element number of another element, not the element's actual value. When you use the element pointer variable, the process uses the value of the element pointed to by the element pointer.

Note: When you assign a value to a variable either directly or by means of another element (for example, an array), consider whether the variable can support the assigned value in terms of field length and field format. For example, 50 characters should not be assigned to a character variable with a field length of 30. Similarly, a monetary value should not be assigned to a variable with a character format.

Related Links

[Understanding Element Pointers in Formulas](#)

Understanding Batch Processing of Variables

Being data input elements, variables are resolved as they are encountered during batch processing. The resolution of the value equals the value you put in the definition.

If you selected the Store check box on the Variable Name page, all resolutions of the variable are stored.

Variable Name Page

Use the Variable Name page (GP_PIN) to name the element and define its basic parameters.

Navigation:

Set Up HCM > Product Related > Global Payroll & Absence Mgmt > Elements > Supporting Elements > Variables > Variable Name

You name every element and define its basic parameters on an Element Name page. All element components in Absence Management share the same Element Name page (GP_PIN).

Related Links

[Defining Element Names](#)

Variables - Definition Page

Use the Variables - Definition page (GP_VARIABLE) to define the value of a variable according to the format specified on the Variable Name page.

Navigation:

Set Up HCM > Product Related > Global Payroll & Absence Mgmt > Elements > Supporting Elements > Variables > Definition

This example illustrates the fields and controls on the Variables - Definition page.

| Field or Control | Description |
|---|--|
| Value | Enter the value to assign to this variable. The type of value that you assign depends on the format type that you designated on the Variable Name page. |
| Use As Chart Field and Prompt View | These fields apply only when using PeopleSoft Global Payroll. |

Defining Date Elements

To define date elements, use the Dates (GP_DATE) component.

Use a date element to include a date in a calculation or determine a new date by taking a starting date and adding or subtracting a period of time to get another date.

Note: Date elements are used for defining specific dates. If you need to subtract one date from another and determine the intervening duration, use a duration element, not a date element.

Pages Used to Define Date Elements

| <i>Page Name</i> | <i>Definition Name</i> | <i>Usage</i> |
|---|------------------------|--|
| Date Name Page | GP_PIN | Name the element and define its basic parameters. |
| Dates - Definition Page | GP_DATE | Define a date or calculate a new date based on an existing date. |
| Extract Page | GP_DATE_EXTRACT | Assign a unique identifier to each element that you enter on the Dates Definition page, allowing reuse of the Year, Month, and Day fields, individually or together. |

Related Links

[Defining Duration Elements](#)

Date Name Page

Use the Date Name page (GP_PIN) to name the element and define its basic parameters.

Navigation:

Set Up HCM > Product Related > Global Payroll & Absence Mgmt > Elements > Supporting Elements > Dates > Date Name

You name every element and define its basic parameters on an Element Name page. All element components in Absence Management share the same Element Name page (GP_PIN).

Related Links

[Defining Element Names](#)

Dates - Definition Page

Use the Dates - Definition page (GP_DATE) to define a date or calculate a new date based on an existing date.

Navigation:

Set Up HCM > Product Related > Global Payroll & Absence Mgmt > Elements > Supporting Elements > Dates > Definition

This example illustrates the fields and controls on the Dates - Definition page.

| Field or Control | Description |
|-------------------------------------|---|
| Provide Date | Select to provide the date, and specify the entry type of the element containing the date in the Date From Type field. Define the date or date element in the Date From or Date From Element field. (The Date From field appears when you select <i>Cal Date</i> in the Date From Type field.) |
| Build Date | Select to have the system build the date, based on elements that you select. When you select Build Date , the Year Entry Type , Month Entry Type , and Day Entry Type fields become available. Use these fields to define the entry type of the elements containing the month, day, or year. Identify the date element or date value in the fields to the right. |
| Return Last Day of the Month | Select to have the system return the last day of the month as a value. You can use this with the Provide Date or Build Date option. Select to have the system override the provided or build date by moving the last day of the month into the day portion of the date. |

Parameters to Modify Built Date (Optional - Default None)

| <i>Field or Control</i> | <i>Description</i> |
|-------------------------------------|---|
| None | Select if you don't want any calculations performed using this date—the date value remains as defined in the group box above. |
| Add | Select to add to the value defined in the Parameters to Build Date group box. The Calculated Year Entry Type , Calculated Month Entry Type , and Calculated Day Entry Type fields become available, offering a list of entry types. Enter the elements corresponding to these entry types in the fields on the right. The value that you select is added to the date value in the Definition group box. |
| Subtract | Select to subtract from the value defined in the Parameters to Build Date group box. The Calculated Year Entry Type , Calculated Month Entry Type , and Calculated Day Entry Type fields become available, offering a list of entry types. Enter the elements corresponding to these entry types in the fields on the right. The value that you select is subtracted from the date value in the Parameters to Build Date group box, to arrive at the resolved date value. |
| Return Last Day of the Month | Select to have the system return the last day of the month as a value. This result occurs only after the Add or Subtract calculation is complete, and it's independent of the Return Last Day of the Month field in the group box titled Parameters to Build Date. |

Examples

This table illustrates what date values result from various page selections:

| <i>Provide Date/ Build Date</i> | <i>Entry Type, Value</i> | <i>Return Last Day of the Month</i> | <i>Calculate Option</i> | <i>Entry Type, Value</i> | <i>Return Last Day of the Month</i> | <i>Resolved Value</i> |
|-------------------------------------|------------------------------|---|-----------------------------|------------------------------|---|---------------------------|
| Provide Date | Date, November 22, 2004 | No | Add | Month: Numeric, 2 | No | January 22, 2005 |

| <i>Provide Date/ Build Date</i> | <i>Entry Type, Value</i> | <i>Return Last Day of the Month</i> | <i>Calculate Option</i> | <i>Entry Type, Value</i> | <i>Return Last Day of the Month</i> | <i>Resolved Value</i> |
|-------------------------------------|------------------------------|---|-----------------------------|---|---|---------------------------|
| Provide Date | Date, November 22, 2004 | No | Add | Month: Numeric, 2 Day: Numeric, 3 | No | January 25, 2005 |

Extract Page

Use the Extract page (GP_DATE_EXTRACT) to assign a unique identifier to each element that you enter on the Dates Definition page, allowing reuse of the Year, Month, and Day fields, individually or together.

Navigation:

Set Up HCM > Product Related > Global Payroll & Absence Mgmt > Elements > Supporting Elements > Dates > Extract

This example illustrates the fields and controls on the Extract page.

| <i>Field or Control</i> | <i>Description</i> |
|---|---|
| Year Element, Month Element, and Day Element | <p>Select the variable to extract the year, month, and day, as applicable.</p> <p>For example, say that you want to capture the year that your date element resolves to. You create a variable called YEAR and select it in the Year Element field. Now, say that the date element resolves to January 10, 2008. The system stores the value, 2008, in the YEAR variable.</p> <p>The YEAR variable can then be used in another date formula to build a new date.</p> |

Defining Formula Elements

To define formula elements, use the Formulas (GP_FORMULA) component.

Pages Used to Define Formula Elements

| Page Name | Definition Name | Usage |
|---------------------------------------|------------------------|--|
| <u>Formula Name Page</u> | GP_PIN | Name the element and define its basic parameters. |
| <u>Field-by-Field Definition Page</u> | GP_FORMULA2_V2 | Define formulas for use in calculations. View formula definitions. |
| <u>Element Attributes Page</u> | GP_FORMULA_F1_SEC | Assign a rounding rule and element pointer selection to the field in your formula. |
| <u>Text Definition Page</u> | GP_FORMULA2_V2 | View your formula and confirm that it's correct. |

Understanding Element Pointers in Formulas

When you define a formula, the values of the elements that comprise it are likely to change. If you refer to an element's specific value at a given time, you have to change the formula every time a component element value changes. Rather than referring to the element's value, you can use an *element pointer* to refer to its system identifying number—its element number. When you do this, you are telling the system that during processing, it should return whatever value is stored in the element's array. Because the element number remains constant, a formula using the element remains useful indefinitely, because the element values are valid.

During batch processing, any variable defined with a *Pointer* field format has a value stored in the Element Pointer field in the PINV array. That is, only the element number is stored and the variable element isn't resolved to an actual character, numeric, or date value.

If the field format for the variable element used in a formula isn't equal to *Pointer* and you select the Use Element Value option on the Element Attributes page, the formula uses the element's value.

If the field format for the variable element used in a formula isn't equal to *Pointer* and you select the Use Element Number option on the Element Attributes page, the formula uses the element's number.

If the field format for the variable element used in a formula is equal to *Pointer* and you select the Use Element Value option on the Element Attributes page, the formula uses the value of the element to which the pointer element is pointing.

If the field format for the variable element in a formula equals *Pointer* and you select the Use Element Number option on the Element Attributes page, the formula uses the value of the pointer element. In other words, it uses the element number, because that's what elements with a field format equal to *Pointer* store.

This table summarizes which values are used with different configurations:

| Field Format | Use Element Value Option Selected | Use Element Number Option Selected |
|-------------------------|--|---|
| Field Format <> Pointer | Element Value | Element Number |
| Field Format = Pointer | Value of the element pointed to by Pointer Value | Pointer Value (an element number) |

Example

Say that before a certain formula is used, the values for the elements are as follows:

| Element Number | Element Name | Element Type | Field Format | Decimal Value | Character Value | Pointer Value |
|-----------------------|---------------------|---------------------|---------------------|----------------------|------------------------|----------------------|
| 1000 | V1 | Variable | Decimal | 150 | | |
| 2000 | V2 | Variable | Character | | ABC | |
| 3000 | V3 | Variable | Decimal | 250 | | |
| 4000 | V4 | Variable | Pointer | | | 1000 |

You've selected the **Use Element Value** option on the Element Attributes page.

If an element's field format isn't *Pointer*, the formula uses the value of the element. So, if you're using the following statement in your formula:

V1 Assign to V3

then, after the resolution of the formula, V3 equals 150.

If an element's field format is *Pointer*, the formula uses the value of the element pointed to by the pointer. So, if you're using the following statement in your formula:

V4 Assign to V3

then, after the resolution of the formula, V3 equals 150.

If you want to use V4 in your formula, the formula checks whether the Use Element Value or Use Element Number option is selected. In this example, it's Use Element Value. The formula then checks whether the field format is *Pointer*. In this example, it's *Pointer*. The pointer value is 1000. Because 1000 is an element number and this element number represents V1, the formula uses the value of V1 (150).

Assume also that you've selected the Use Element Number option on the Element Attributes page.

If the field formats for Element Name 1 and Element Name 2 aren't *Pointer*, the formula uses the element number. So, if you're using the following statement in your formula:

V2 Assign to V4

and you're using pointers, then, after resolution of the formula, V4 contains 2000 in the pointer value.

If the field formats for Element Name 1 and Element Name 2 are *Pointer*, the formula uses the pointer value. So, if you're using the following statement in your formula:

If V4 = 2000

then the condition is true, because the pointer value of V4 equals 2000.

If you want to use V2 in your formula, the formula checks whether the Use Element Value or the Use Element Number option is selected. In this example, it's Use Element Number. The formula then checks whether the field format is a *Pointer*. In this example, it isn't. This directs the formula to use the element number of V2, whose element number is 2000. So, 2000 will be assigned to the pointer value of V4.

Note: If you're using the element number V2, the Assign To element must be in **Pointer** field format and the **Use Element Number** option must be selected on the Element Attributes page for Element 1, Element 2, and Assign To Element.

Related Links

[Understanding Field Formats](#)

[Defining Variable Elements](#)

Formula Name Page

Use the Formula Name page (GP_PIN) to name the element and define its basic parameters.

Navigation:

Set Up HCM > Product Related > Global Payroll & Absence Mgmt > Elements > Supporting Elements > Formulas > Formula Name

You name every element and define its basic parameters on an Element Name page. All element components in Absence Management share the same Element Name page (GP_PIN).

Related Links

[Defining Element Names](#)

Field-by-Field Definition Page

Use the Field-by-Field Definition page (GP_FORMULA2_V2) to define formulas for use in calculations.

View formula definitions.

Navigation:

Set Up HCM > Product Related > Global Payroll & Absence Mgmt > Elements > Supporting Elements > Formulas > Field-by-Field Definition

This example illustrates the fields and controls on the Field-by-Field Definition page.

Building Your Formula

Build your formula in the Field-by-Field Area group box, specifying one operation or result in each row.

| Field or Control | Description |
|--|---|
| Function | Select the type of function or qualifier for the formula. Options include <i>And, Average, Comment, Else, Endif, Exit, If, In, Maximum, Minimum, Or, Sum, and Then.</i> |
| ((left parenthesis) | Select to group your formula calculations. Selecting this check box requires that you must select the) check box. How you group your formula calculations with parentheses can affect the calculation sequence. |
| Entry Type 1 or 2, Element 1 or 2, Calendar Date 1 or 2, Character Value 1 or 2, and Numeric Value 1 or 2 | Select the entry type for the operation. If you select the <i>Character, Cal Date, Date, or Numeric</i> entry type, enter a value in the corresponding Date Value, Numeric Value, or Character Value field. If you select any other entry type, the system prompts for the correct element in the corresponding Element Name field. |
|  | Click to access the Element Name Attributes page and assign a rounding rule, previous period rule, or element pointer selection to a field that you're using in your formula. The check box to the right of the entry type list is selected if additional information has been entered on the Formula - Field Details page. |

| Field or Control | Description |
|---|---|
| Operator | Select the operator to perform on the operands that you entered. The following standard operators are available: (none), -, *, /, +, <, <=, <>, =, >, and >=. |
|) (right parenthesis) | Select to group your formula calculations. If you select this check box, you must select the (check box. How you group your formula calculations with parentheses can affect the calculation sequence. |
| Assign To Type and Assign To Element | <p>To assign a value to an element, first select the entry type and then select the element.</p> <p>For example, you are defining a formula named SICK LEAVE to calculate entitlement for absences due to sickness. To have the system assign the resolved value of the formula element to the SICK LEAVE formula, enter SICK LEAVE in Assign To Element field.</p> <p>Before you can select the formula in this field, you must save the formula definition with an effective date.</p> |

Note: Under either parenthesis, you can enter multiple sets of parentheses. To do so, use multiple lines. You can enter only one (or) per row.

Validating Your Formula

After you define your formula, save it, then validate and edit the formula. Whenever you alter the formula, re-validate it.

| Field or Control | Description |
|-------------------------|---|
| Validate | Click this button to validate your formula. (Validating a formula automatically saves the formula.) |
| Validated | This check box is selected if you clicked the Validate button and the formula passed validation. |

Note: If you try to run a process using a formula that you've changed without validating, you get an error. Save the page before clicking the **Validate** button. You can save the page anytime, but no validation against the database occurs until you click the **Validate** button.

Example: Setting Up a Formula

Using the formula element, you can create elements using mathematical and logical operands, rules, and mathematical formulas.

In this example, you need a simple formula to forecast whether there is sufficient entitlement to cover an absence event. The requirements are as follows:

- If the system element, DAY COUNT UNP (day count unpaid) is greater than zero, return a value of NOT ELIGIBLE.
- Otherwise, return a value of ELIGIBLE.

Start by turning the calculation into a mathematical formula. In this example, K0FM PTO ELIGIBLE is the name of the formula that you are defining.

```
If DAY COUNT UNP > 0, then
  'NOT ELIGIBLE' >> K0FM PTO ELIGIBLE
else
  'ELIGIBLE' >> K0FM PTO ELIGIBLE
Endif
```

Formulas can often be expressed in multiple ways. To streamline processing, use the simplest version that requires the least processing.

After turning the calculation into a mathematical formula, you enter the formula into the system. If you haven't defined the element and entered the basic descriptions, do so on the Formula Name page. Then, on the Field-by-Field Definition page, define the formula, line by line.

This table shows how you enter your forecasting formula:

| Sequence Number | Function | (| Entry Type 1 / Element 1 or value | Operator | Entry Type 2 / Element 1 or value |) | Assign To Type/ Assign To Element |
|-----------------|----------|---|-----------------------------------|----------|-----------------------------------|---|-----------------------------------|
| 1 | If | | SystemElem / DAY COUNT UNP | > | Numeric / 0 | | |
| 2 | Then | | | | Character / NOT ELIGIBLE | | Formula / K0FM PTO ELIGIBLE |
| 3 | Else | | | | Character / ELIGIBLE | | Formula / K0FM PTO ELIGIBLE |
| 4 | Endif | | | | | | |

Note: Every If statement must end with an Endif.

Each element name must be associated with an appropriate entry type. For example, on the first line, Element Name 1 (DAY COUNT UNP) is associated with the entry type *System Element*.

You can view your formula by accessing the Text Definition page. When you have defined the formula, validate it by clicking the **Validate** button on the Field-by-Field Definition page.

Related Links

[Understanding Element Pointers in Formulas](#)

Element Attributes Page

Use the Element Attributes page (GP_FORMULA_F1_SEC) to assign a rounding rule and element pointer selection to the field in your formula.

Navigation:

Click the Element 1 Attributes (or Element 2 Attributes) button on the Formulas - Field-by-Field Definition page.

This example illustrates the fields and controls on the Element Attributes page.

| Formula Element 1 Attributes | |
|---|--|
| Formulas | |
| Element 1 Attributes | |
| Element 1 K0VR CLC SICK K0VR CLC SICK | |
| Rounding Rule Element <input type="text" value=""/>  | |
| Value / Pointer Selection | Old Value Selection |
| <input checked="" type="radio"/> Use Element Value <input type="radio"/> Use Element Number | <input type="checkbox"/> Use Previously Calculated Value |

| Field or Control | Description |
|------------------------------|---|
| Rounding Rule Element | <p>If the field format of the element that you selected on the Formula Name page is <i>Decimal</i>, <i>Monetary</i>, or <i>Pointer</i>, select a rounding rule from the list. This field is only visible for elements with these field formats.</p> <p>The rounding rule applies only to the operand for which you've entered it. The element itself isn't updated; only the calculation is affected.</p> |

Value/Pointer Selection

Use these fields to define element pointers in your formula.

| Field or Control | Description |
|---------------------------|---|
| Use Element Value | Select to use an element's value in the calculation. |
| Use Element Number | <p>The default value is <i>Use Element Value</i> in formulas. You can also build formulas that use elements by their element number.</p> <p>Select to reference an element by using its system identifying number (element number), not its current value.</p> <p>For example, you have written a formula to calculate garnishments, but different payees have different garnishments. If you use element pointers in your formula expression to point to an element using its identifying element number, then you won't have to rewrite the formula every time the number and type of garnishment changes for different payees. The formula will adapt its calculations because it is retrieving current values for the elements referenced by the element pointer.</p> |

Old Value Selection

| Field or Control | Description |
|--|--|
| Use Previously Calculated Value | Select to use the previously calculated value. |

Text Definition Page

Use the Text Definition page (GP_FORMULA2_V2) to view your formula and confirm that it's correct.

Navigation:

Set Up HCM > Product Related > Global Payroll & Absence Mgmt > Elements > Supporting Elements > Formulas > Text Definition

This example illustrates the fields and controls on the Text Definition page.

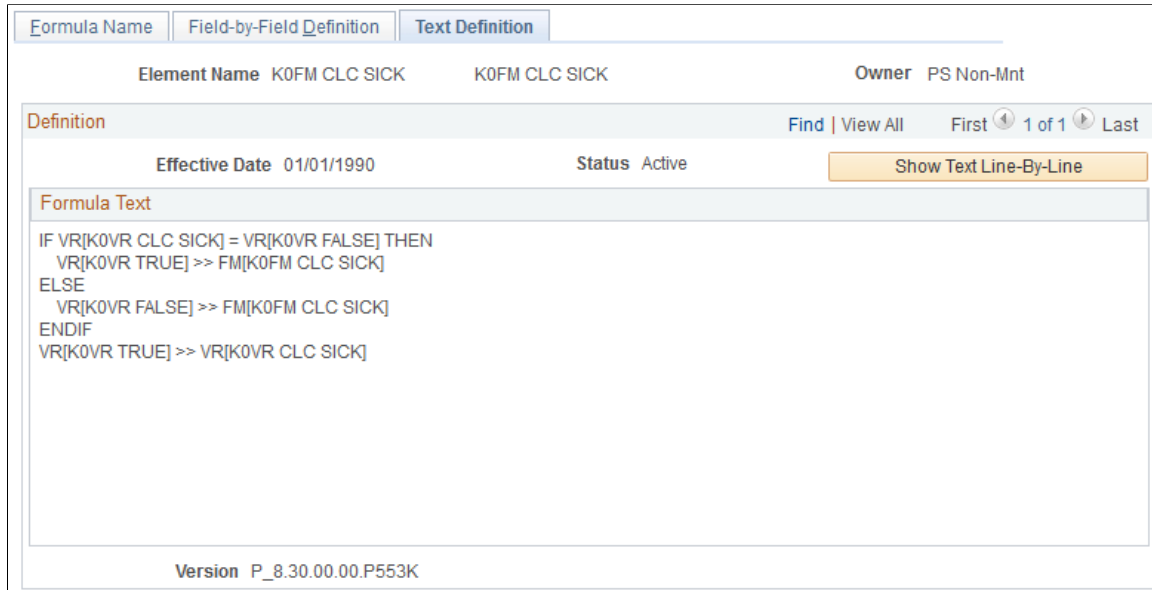

Use the Text Definition page to view the formula that you created on the Formula - Field-by-Field Definition page. If something isn't correct, return to the Field-by-Field Definition page and adjust the formula.

| Field or Control | Description |
|-------------------------------|--|
| Show Text Line-By-Line | <p>Click to view the text of the formula that you created on the Formula - Field-by-Field Definition page, as it was entered, line-by line.</p> <p>This view can be useful when troubleshooting a formula with errors. Any errors created by SaveEdit will be noted within the text as well as by an error message at the bottom of the page.</p> <hr/> <p>Note: In the line-by-line view each line is prefixed by its row/line number and the error location is updated to reflect the number of the line displayed in the formula text.</p> |

Defining Message Elements

Message elements are closely related to formula elements. To fully understand message elements, read the section on formulas before reading this topic.

In this topic, we discuss how to define message elements.

Note: No online pages specifically define message elements, because they are provided in system data.

By referencing the message element in a formula, you can manage the error messages that are created during batch processing. A message element calls a program that writes an error message into the error message table (PS_GP_MESSAGES) and then, optionally, puts the payment in error.

Many of the fields in the PS_GP_MESSAGES table are system-populated. Others are populated during batch processing. By using these field values as components of a formula, you can create your own message and error conditions during batch processing.

To populate fields that aren't system-populated, these components and processes are provided:

- Five system elements (MSG_BIND1_PTR ... MSG_BIND5_PTR), with the *Pointer* field format.

These pointers point to the parameters that you're using in your error messages.

- Five numeric system elements (MSG_BIND1_NM_IND ... MSG_BIND5_NM_IND).

If the value of MSG_BINDx_NM_IND equals zero, the system displays on the Payee Messages page the element name to which the MSG_BINDx_PTR element points. Otherwise it displays the value of the element that is pointed to by MSG_BINDx_PTR.

- Numeric system elements for the message number (MSG_NBR) and MSG_SET_NBR.
- A numeric system element (MSG_PAYMENT_ERR) that can put the calculation in error.

If the value of this system element doesn't equal 0, the calculation is in error.

- An error message element type.

This element type has only one element in the GP_PIN_NM table (MESSAGE). The field format is *Decimal*. The **Re-calc** (recalculation) check box must be cleared. This entry type is available only on the Field-by-Field Definition page and for Element 1 and Element 2. When the batch process encounters this message (formula) element, it inserts a row in the PS_GP_MESSAGES table for the message ID and parameters specified. If there's no error, the MESSAGE element equals zero. If there's an error, the MESSAGE element equals one. The primary purpose of this element type is to enable the batch process to recognize that a user error needs invoking. The batch process doesn't look at its value.

Every system element that is related to an error message is reset to blank or zero.

Note: You can create your own error messages only by using formula elements.

Example

This table gives an example of a formula element setup (a portion of an entire formula expression):

| Sequence Number | Function | Element 1 | Operator | Element 2 | Assign To Element |
|------------------------|-----------------|------------------|-----------------|------------------|--------------------------|
| 1 | If | XXXXX | = | YYYYY | |
| 2 | Then (error) | | | 17005 | MSG_SET_NBR |
| | | | | 1015 | MSG_NBR |

| Sequence Number | Function | Element 1 | Operator | Element 2 | Assign To Element |
|------------------------|-----------------|------------------|-----------------|-----------------------------------|---------------------------------------|
| 3 | | | | ELEMENT_A (Use Element Number) | MSG_BIND1_PTR (Use Element Number) |
| 4 | | | | ELEMENT_B (Use Element Number) | MSG_BIND2_PTR (Use Element Number) |
| 5 | | | | 1 | MSG_BIND1_NM_IND |
| 6 | | | | 1 | MSG_PAYMENT_ERR |
| 7 | If | MESS_AGE | = | 0 | |
| 8 | ... | | | | |

This table provides explanations of the formula described in the previous table:

| Sequence Number | Explanation |
|------------------------|---|
| 1 | This is a regular expression in the formula. |
| 2, 3 | Assign the error message number to the system element MSG_NBR and MSG_SET_NBR. |
| 3 | Assign the element number ELEMENT_A (represents the element in error) to MSG_BIND1_PTR pointer value. |
| 4 | Assign the element number ELEMENT_B (represents the element in error) to MSG_BIND2_PTR pointer value. |
| 5 | Assign the value 1 to MSG_BIND1_NM_IND to indicate that ELEMENT_A contains an element number. Because no value has been assigned to MSG_BIND2_NM_IND, it appears as an element value. |
| 6 | Assign the value 1 to element MSG_PAYMENT_ERR, which puts the calculation status in error. |

| <i>Sequence Number</i> | <i>Explanation</i> |
|------------------------|--|
| 7 | Use the message element, which calls the resolution program for this element type. |

Note: An indicator tells the system whether a number value is an element number so that the formula message program knows whether to leave that value alone or retrieve that element's value. Leaving that value alone means that the element name is displayed on the online message page.

Related Links

[Understanding Element Pointers in Formulas](#)

Defining Rounding Rule Elements

To define rounding rule elements, use the Rounding Rules (GP_ROUNDING) component.

Pages Used to Define Rounding Rule Elements

| <i>Page Name</i> | <i>Definition Name</i> | <i>Usage</i> |
|------------------------------------|------------------------|---|
| Rounding Name Page | GP_PIN | Name the element and define its basic parameters. |
| Definition Page | GP_ROUND_RULE | Define how numeric values are rounded. |

Understanding Rounding Rule Elements

When performing calculations that resolve to a numeric value, the value may need rounding. The rounded value is what gets stored or used in further calculations. Rounding is a tool that enables you to systematically change values according to predefined rules.

Once you've defined your rounding rule elements, you can apply them to other elements throughout the system to determine how rounding will occur.

Note: Many rounding rules apply to specific features of the system. They are explained in the section of this documentation that discusses those features. The text here describes only the generic functionality of the rounding rules element.

Examples of Size Rounding

This table provides examples of how the rounding rules work if you select **Rounding** on the Rounding - Definition page:

| Size | Option | Amount Before Rounding | Rounded Value |
|------------------|----------------------------|-------------------------------|----------------------|
| 2 Decimal Places | Truncate/Down | 123.454999 | 123.450000 |
| | Truncate/Down | 123.455000 | 123.450000 |
| | Truncate/Down | 123.450001 | 123.450000 |
| | Truncate/Down | 123.450000 | 123.450000 |
| | Up | 123.454999 | 123.460000 |
| | Up | 123.455000 | 123.460000 |
| | Up | 123.450001 | 123.460000 |
| | Up | 123.450000 | 123.450000 |
| | Round Up If >= 4 Else Down | 123.454999 | 123.460000 |
| | Round Up If >= 4 Else Down | 123.455000 | 123.460000 |
| | Round Up If >= 4 Else Down | 123.450001 | 123.450000 |
| | Round Up If >= 4 Else Down | 123.450000 | 123.450000 |
| 0 Decimal Places | Truncate/Down | 123.499999 | 123.000000 |
| | Truncate/Down | 123.500000 | 123.000000 |
| | Truncate/Down | 123.000001 | 123.000000 |
| | Truncate/Down | 123.000000 | 123.000000 |
| | Up | 123.499999 | 124.000000 |
| | Up | 123.500000 | 124.000000 |
| | Up | 123.000001 | 124.000000 |

| Size | Option | Amount Before Rounding | Rounded Value |
|----------------|----------------------------|-------------------------------|----------------------|
| | Up | 123.000000 | 123.000000 |
| | Round Up If >= 4 Else Down | 123.499999 | 124.000000 |
| | Round Up If >= 4 Else Down | 123.500000 | 124.000000 |
| | Round Up If >= 4 Else Down | 123.000001 | 123.000000 |
| | Round Up If >= 4 Else Down | 123.000000 | 123.000000 |
| 1 Digit - 10's | Truncate/Down | 124.999999 | 120.000000 |
| | Truncate/Down | 125.000000 | 120.000000 |
| | Truncate/Down | 120.000001 | 120.000000 |
| | Truncate/Down | 120.000000 | 120.000000 |
| | Up | 124.999999 | 130.000000 |
| | Up | 125.000000 | 130.000000 |
| | Up | 120.000001 | 130.000000 |
| | Up | 120.000000 | 120.000000 |
| | Round Up If >= 4 Else Down | 124.999999 | 130.000000 |
| | Round Up If >= 4 Else Down | 125.000000 | 130.000000 |
| | Round Up If >= 4 Else Down | 120.000001 | 120.000000 |
| | Round Up If >= 4 Else Down | 120.000000 | 120.000000 |

Examples of Incremental Rounding

This table provides examples of how the rounding rules work if you select the **Increment** on the Rounding - Definition page:

| <i>Increment</i> | <i>Option</i> | <i>Amount Before Rounding</i> | <i>Rounded Value</i> |
|-------------------------|-----------------------------------|--------------------------------------|-----------------------------|
| 25 | Truncate/Down | 137.499999 | 125.000000 |
| | Truncate/Down | 137.500000 | 125.000000 |
| | Truncate/Down | 150.000001 | 150.000000 |
| | Truncate/Down | 150.000000 | 150.000000 |
| | Up | 137.499999 | 150.000000 |
| | Up | 137.500000 | 150.000000 |
| | Up | 150.000001 | 175.000000 |
| | Up | 150.000000 | 150.000000 |
| | Round Up If >= 12.4 Else Down | 137.499999 | 150.000000 |
| | Round Up If >= 12.4 Else Down | 137.500000 | 150.000000 |
| | Round Up If >= 12.4 Else Down | 150.000001 | 150.000000 |
| | Round Up If >= 12.4n Else Down | 150.000000 | 150.000000 |
| 2.5 | Truncate/Down | 137.499999 | 135.000000 |
| | Truncate/Down | 137.500000 | 137.500000 |
| | Truncate/Down | 150.000001 | 150.000000 |
| | Truncate/Down | 150.000000 | 150.000000 |
| | Up | 137.499999 | 137.500000 |

| <i>Increment</i> | <i>Option</i> | <i>Amount Before Rounding</i> | <i>Rounded Value</i> |
|------------------|----------------------------------|-------------------------------|----------------------|
| | Up | 137.500000 | 137.500000 |
| | Up | 150.000001 | 152.500000 |
| | Up | 150.000000 | 150.000000 |
| | Round Up If >= 1.25 Else Down | 137.499999 | 137.500000 |
| | Round Up If >= 1.25 Else Down | 137.500000 | 137.500000 |
| | Round Up If >= 1.25 Else Down | 150.000001 | 150.000000 |
| | Round Up If >= 1.25 Else Down | 150.000000 | 150.000000 |

Rounding Name Page

Use the Rounding Name page (GP_PIN) to name the element and define its basic parameters.

Navigation:

Set Up HCM > Product Related > Global Payroll & Absence Mgmt > Elements > Supporting Elements > Rounding Rules > Rounding Name

You name every element and define its basic parameters on an Element Name page. All element components in Absence Management share the same Element Name page (GP_PIN).

Related Links

[Defining Element Names](#)

Definition Page

Use the Definition page (GP_ROUND_RULE) to define how numeric values are rounded.

Navigation:

Set Up HCM > Product Related > Global Payroll & Absence Mgmt > Elements > Supporting Elements > Rounding Rules > Definition

This example illustrates the fields and controls on the Rounding - Definition page.

The screenshot shows the 'Rounding - Definition' page for the element 'GBR RR ROUNDUP ODP'. The page is titled 'Definition' and shows the following fields and controls:

- Element Name:** GBR RR ROUNDUP ODP
- Round Up:** 0 decimal places
- Owner:** PS Non-Mnt
- Effective Date:** 01/01/1990
- Status:** Active
- Rounding Options:**
 - Rounding
 - Increment
- Round Size:** 0 (x.000000)
- Round Adjustment Number:** 5
- Rounding Result Examples:**
 - Rounding Result Up if: 0.000000
 - Rounding Result Up: 0.000000
 - Rounding Result Down: 0.000000
- Version:** P_8.00.00.00

| Field or Control | Description |
|------------------------------------|---|
| Rounding | Select to use traditional rounding rules. |
| Increment | Select to set rounding increments. When you select this option, the Increment field appears, where you define the incremental value. |
| Round Size | This field appears when you select the Rounding option. Specify a round size from the list. Values are 01 through 11, or 0 to 5 decimal places. The example fields on the bottom right half of the page enable you to view examples of each type of rounding. |
| Round Up if >= Else Down | Select to round up if the result is greater than or equal to the value you enter in the Round Adjustment field, based on the number of digits or decimal places entered. If the result doesn't exceed or equal the value, the result is rounded down. The default value is 5 for rounding. If you select the Rounding check box, you can enter only one digit in the Round Adjustment field. If you select the Increment option, you can enter a value of up to eight digits. This digit looks at the decimal place to the right of what is being rounded. For example, if you're rounding to the tens (one decimal place), it looks to the hundreds field. |
| Up | Select to round up, based on the number of digits or decimal places entered. It rounds up if the value to the right of the digits or decimal places specified is greater than zero. The system looks at all the remaining digits or decimal places, not just the next digit. |

| <i>Field or Control</i> | <i>Description</i> |
|-------------------------|--|
| Truncate/Down | Select to truncate (round down), based on the number of digits or decimal places entered. All digits or decimal places to the right of the number specified are changed to zero, and the rest are truncated. |
| Rounding Sample | Enter a value to see how the system would round the amount based on your page selections. |

Defining Count Elements

To define count elements, use the Counts (GP_COUNT) component.

Pages Used to Define Count Elements

| <i>Page Name</i> | <i>Definition Name</i> | <i>Usage</i> |
|---------------------------------|------------------------|---|
| <u>Count Name Page</u> | GP_PIN | Name the element and define its basic parameters. |
| <u>Counts - Definition Page</u> | GP_COUNT | Define a count element. Use this page to select an existing counting formula. |

Understanding Count Elements

You might need a process for counting the number of scheduled work days or hours from a specific period of time. For this purpose, you use count elements, which are primarily for proration calculations but can be used in other situations.

When you define a count element, you reference a formula that you've defined as the counting formula. That is, you define a formula that counts the number of scheduled work days or hours; then you reference that formula on the Counts - Definition page so that the system knows that it should process the referenced formula as a counting formula.

The count element refers to the work schedule that is associated with each payee to count the correct workdays. When the system finishes checking each day's work schedule, it counts the number of days or hours for the sub periods, either segments or slices.

The formula is resolved for each day in the work schedule within a date range. Set up the formula to return the number of units for each day. The count program will cumulate the formula results. If the count element is called from the proration element, the counting period is set by the proration element. If the count formula is not called from a proration element, the counting period is the segment.

An example of a simple count formula (GP COUNT WRK DAYS) follows.

```
IF SCHED_HRS > 0 THEN
```

```

GP TRUE => GP COUNT WRK DAYS
ELSE
GP FALSE => GP COUNT WRK DAYS
Endif

```

Related Links

[Understanding Work Schedules](#)

[Defining Proration Rules](#)

[Defining Formula Elements](#)

[Understanding Segmentation Setup](#)

Count Name Page

Use the Count Name page (GP_PIN) to name the element and define its basic parameters.

Navigation:

Set Up HCM > Product Related > Global Payroll & Absence Mgmt > Elements > Supporting Elements > Counts > Count Name

You name every element and define its basic parameters on an Element Name page. All element components in Absence Management share the same Element Name page (GP_PIN).

Related Links

[Defining Element Names](#)

Counts - Definition Page





Use the Counts - Definition page (GP_COUNT) to define a count element.

Use this page to select an existing counting formula.

Navigation:

Set Up HCM > Product Related > Global Payroll & Absence Mgmt > Elements > Supporting Elements > Counts > Definition

This example illustrates the fields and controls on the Counts - Definition page.

| Count Name | Definition |
|---|--|
| Element Name | GP WORK DAY COUNT Work Day Count |
| Owner | PS Mnt |
| Definition Find View All First 1 of 1 Last | |
| *Effective Date | 01/01/1990  |
| *Status | Active   |
| Count Formula | GP COUNT WORK DAYS  Work Day Count |
| Version | 8.00.00.00 |

| | |
|-------------------------|---|
| Field or Control | Description |
| Count Formula | Enter the name of the formula that performs the count. |
| Field or Control | Description |
| <Formula Name> | Click the link next to the Count Formula field to view the formula definition pages. |

Defining Proration Rules

To define proration rules, use the Proration Rules (GP_PRORATION) component.

Pages Used to Define Proration Rules

| Page Name | Definition Name | Usage |
|---|------------------------|---|
| Proration Name Page | GP_PIN | Name the element and define its basic parameters. |
| Proration Rules - Definition Page | GP_PRORATION | Define numerators and denominators that comprise proration factors. |

Understanding Proration Rules

A proration rule can be triggered by segmentation or with the system element, PRORATE. You define what values to use as the numerator and denominator of a proration rule. When the system applies a proration rule, it multiplies the amount by the numerator, and divides the result by the denominator.

You can use a proration rule in the definition of an absence entitlement element (frequency-based). Proration applies to the entitlement units. You can assign a default proration rule on the Pay Group - Defaults page.

When defining a frequency-based absence entitlement element, you have three choices for proration:

- Use no proration, regardless of segmentation.
- Use the pay group proration rule.
- Specify a unique proration rule.

Denominator Schedule Example

The Denominator Schedule group box on the Proration - Definition page enables you to select which work schedules to include in the denominator calculation. Assume that a payee has two work schedules:

- Work Schedule A, 5 days a week.
- Work Schedule B, 3 days a week.

Also assume that February has exactly 4 weeks and that the proration rule is defined to use the number of workdays, then:

- If the payee has only Work Schedule A, the denominator is 20 (5 days \times 4 weeks).
- If the payee has only Work Schedule B, the denominator is 12 (3 days \times 4 weeks).
- If the payee has Work Schedule A for the first 2 weeks and Work Schedule B for the second 2 weeks, you can tell the system to use a denominator of:
 - 12 (3 \times 4), if you're using the work schedule as of the end of the period.
 - 16 ((5 \times 2) + (3 \times 2)), if you're using both (all) work schedules.

Note: When you define a proration element, the **Always Recalculate** check box on the Proration Name page is automatically selected. This is to ensure that the system correctly calculates the proration factor when there is element segmentation.

Proration Name Page

Use the Proration Name page (GP_PIN) to name the element and define its basic parameters.

Navigation:

Set Up HCM > Product Related > Global Payroll & Absence Mgmt > Elements > Supporting Elements > Proration Rules > Proration Name

You name every element and define its basic parameters on an Element Name page. All element components in Absence Management share the same Element Name page (GP_PIN).

Related Links

[Defining Element Names](#)

Proration Rules - Definition Page

Use the Proration Rules - Definition page (GP_PRORATION) to define numerators and denominators that comprise proration factors.

Navigation:

Set Up HCM > Product Related > Global Payroll & Absence Mgmt > Elements > Supporting Elements > Proration Rules > Definition

This example illustrates the fields and controls on the Proration Rules - Definition page.

| Field or Control | Description |
|--|--|
| <p>Numerator Entry Type, Denominator Entry Type, Numerator Element, and Denominator Element</p> | <p>Select the types of elements that define the numerator (slice period) and the denominator (the full pay period). Values are <i>Accumulator</i> (accumulator), <i>Count</i>, <i>Formula</i>, <i>Duration</i>, and <i>Variable</i>.</p> <p>Enter the element name in the Numerator Element or Denominator Element field to the right.</p> <p>Counts are perhaps the most common element type used to define proration rules. For example, you can define count elements to count the number of scheduled work days or hours in a pay period. When a payee has segmentation, the system resolves the count element for the numerator for the slice period (or segment if no slices exist). The count element for the denominator resolves for the entire period.</p> <p>To count calendar days, a duration element provides better performance than a count element. For the numerator, calculate the calendar duration between the slice begin and slice end date. For the denominator, use a duration element that calculates the calendar days between the period begin and period end dates.</p> <p>You might use a variable if you aren't concerned with the number of days in a calendar period and prefer a static value. For example, in a monthly calculation cycle, the number of calendar days in the period fluctuates every month but you may want to ignore this fluctuation. You can create a variable with a value of 30.00 and use it as the denominator.</p> |

Denominator Schedule

Use these fields to specify which work schedules to include in the denominator calculation.

| Field or Control | Description |
|---|--|
| <p>Use Last Schedules in Segment</p> | <p>Select to use the last schedule in the segment.</p> |

| Field or Control | Description |
|------------------------------------|---|
| Use All Schedule in Segment | Select to use all schedules in the segment. |

Defining Generation Control Elements

To define generation control elements, use the Generation Control (GP_GCTL_CONDITION) component.

Pages Used to Define Generation Control Elements

| Page Name | Definition Name | Usage |
|--|------------------------|---|
| <u>Generation Control Name Page</u> | GP_PIN | Name the element and define its basic parameters. |
| <u>Generation Control - Conditions Page</u> | GP_GCTL_CONDITION | Define the criteria for use in directing the system to include or exclude certain element conditions during batch processing. |
| <u>HR Status for Element <Name> page</u> | GP_GCTL_ST_SEC | Exclude or include employee status conditions during batch processing. |
| <u>HR Action/Reason for Element <Name> Page</u> | GP_GCTL_AR_SEC | Exclude or include action/reason code combinations. |
| <u>Generation Control - Frequency for Element <Name> Page</u> | GP_GCTL_FQ_SEC | Exclude or include frequency codes. |
| <u>Generation Control - Segment Status for Element <Name> Page</u> | GP_GCTL_SS_SEC | Exclude or include segment status conditions. |
| <u>Generation Control - Formula for Element <Name> Page</u> | GP_GCTL_FM_SEC | Exclude or include formula elements. |
| <u>Generation Control - Run Type for Element <Name> Page</u> | GP_GCTL_RT_SEC | Exclude or include run types. |

Understanding Generation Control Elements

In the basic processing of an element, the system assumes that the element is to be processed whenever a payee is processed. But sometimes you don't want an element processed every time for every payee.

Generation control provides a type of filtering that enables you to control whether an element for a payee is processed during batch processing. Using generation control elements, you can tell the system whether to process an element based on predefined criteria.

The following six parameters are used to define generation control elements:

- HR Status
- HR Action/Reason
- Segment Status
- Frequency
- Formula
- Run Types

For each control parameter, you specify whether the entries exclude or include the element during batch processing. If you include the element, only payees that match on the selected values have the element processed. All other values are excluded. If you exclude the element, the element isn't processed for payees that match on the selected value or values. All other values are included.

HR Status Example 1

You want to include for processing all payees whose HR status is *Active*, so you create a generation control element that includes all payees with this status. You then associate this generation control element with the elements that you want to control. So, in batch processing, only payees with an *Active* HR status have these elements processed. All payees with a different HR status, such as *Inactive* or *Terminated*, don't have the element processed.

HR Status Example 2

This table lists the PS_JOB rows for a payee:

| Effective Date | HR Employee Status |
|-----------------------|---------------------------|
| January 1, 1999 | Active |
| January 10, 1999 | Leave of Absence |
| January 20, 1999 | Active |

This table shows how elements E1 and E2 have the following generation control conditions applied to them with the HR Status page controls:

| Element | Include/ Exclude | Employee Status | All Job Records in Segment | Last Job Record |
|----------------|-------------------------|------------------------|-----------------------------------|------------------------|
| E1 | Include | Leave of Absence | No | Yes |
| E2 | Include | Leave of Absence | Yes | No |

E1 isn't processed, because the last Job row isn't Leave of Absence. E2 is processed, because the Job row with Leave of Absence is in the segment.

Note: Typically, you record leaves of absence through the absence entry pages; however, in some cases, you may want to use the HR status to track long-term leaves of absence.

HR Action/Reason Example (without Segmentation)

This table lists a payee's PS_JOB row:

| Effective Date | Action | Reason |
|-----------------------|---------------|---------------|
| January 1, 1990 | Hire | New Position |

This table shows how element E1 has the following generation control conditions applied to it with the HR Action/Reason page controls:

| Element | Include/ Exclude | Action | Reason |
|----------------|-------------------------|---------------|---------------|
| E1 | Include | Hire | New Position |

If you're processing January 1, 1999 through January 31, 1999, E1 isn't processed, because the PS_JOB row doesn't have an effective date in the segment.

HR Action/Reason Example (with Segmentation)

This table lists a payee's PS_JOB rows:

| Effective Date | Action | Reason |
|-----------------------|---------------|---------------|
| January 1, 1990 | Hire | New Position |
| January 15, 1999 | Termination | Dishonesty |

This table shows how element E1 has the following generation control conditions applied to it with the HR Action/Reason page controls:

| Element | Include/ Exclude | Action | Reason |
|----------------|-------------------------|---------------|---------------|
| E1 | Include | Termination | Dishonesty |

For the January 1999 pay period, this payee has two segments: Segment 1 (January 1, 1999 through January 15, 1999) and Segment 2 (January 16, 1999 through January 31, 1999).

E1 is processed in Segment 1, because the effective date falls within the segment's date parameters. E1 isn't processed in Segment 2, because the effective date doesn't fall within these parameters.

HR Action/Reason Example (with Last Day Worked)

In this example, assume that you want a certain absence balance to a payee upon termination. This table shows how elements E1 and E2 have the following generation control conditions applied to them on the HR Action/Reason page:

| Element | Include/ Exclude | Action | Last day Worked |
|----------------|-------------------------|---------------|------------------------|
| E1 | Include | Termination | Yes |
| E2 | Include | Termination | No |

Assume the following:

Pay period is January 1, 2001 – January 31, 2001.

Payee's last day of work is January 31, 2001.

Accordingly, a job row is inserted with an effective date of February 1, 2001 (which is the first day the person is terminated, or not active) with an Action of *Termination*.

E1 is processed because the system looks at the Last Day Worked (on the Employment record) to see if the action is within the period.

E2 is *not* processed in January because the effective date is February 1, 2001. If the payee is paid in February for some reason, E2 would be processed.

Note: The Generation Control HR Action/Reason page considers all PS_JOB rows for a given segment. The PS_JOB row must have an effective date in the segment.

Frequency Code Example

You have a weekly calculation period and want a particular type of entitlement to accrue only to the first pay period of the month. But you want to use the same process list for all four weekly absence runs during the month. To avoid having to create a new process list just to accommodate your needs for the first calculation period, you can use the frequency generation control feature to define a frequency with a *First of the Month* value. In this way, you can use the same process list for all four pay periods and confine the particular deduction processing to the first pay period.

Understanding Batch Processing of Generation Control Elements

The Generation Control program is called from the absence entitlement programs. The calling programs pass the Generation Control element to be resolved. The PIN Manager acts as the central program controlling the process.

Generation Control Name Page

Use the Generation Control Name page (GP_PIN) to name the element and define its basic parameters.

Navigation:

Set Up HCM > Product Related > Global Payroll & Absence Mgmt > Elements > Supporting Elements > Generation Control > Generation Control Name

You name every element and define its basic parameters on an Element Name page. All element components in Absence Management share the same Element Name page (GP_PIN).

Related Links

[Defining Element Names](#)

Generation Control - Conditions Page

Use the Generation Control - Conditions page (GP_GCTL_CONDITION) to define the criteria for use in directing the system to include or exclude certain element conditions during batch processing.

Navigation:

Set Up HCM > Product Related > Global Payroll & Absence Mgmt > Elements > Supporting Elements > Generation Control > Conditions

This example illustrates the fields and controls on the Generation Control - Conditions page.

| <i>Field or Control</i> | <i>Description</i> |
|---|---|
| HR Status (human resources status) | Click this link to access the HR Status page. Indicate which employee status conditions to process. |

| Field or Control | Description |
|-------------------------|---|
| Action/Reason | Click this link to access the HR Action/Reason page. Indicate which Action/Reason code combinations to process. |
| Frequency | Click this link to access the Generation Control - Frequency page. Indicate which frequencies to process. |
| Segment Status | Click this link to access the Segment Status page. Indicate which segment status conditions to process. |
| Formula | Click this link to access the Generation Control - Formula page. Indicate which formulas to process. |
| Run Type | Click this link to access the Generation Control - Run Type page. Indicate which run types to process. |

Important! When more than one generation control parameter type (such as HR status and frequency) is entered, the payee must meet both criteria to pass generation control. When more than one value (such as Actions of *Hire* or *Rehire*) for a particular generation control type is entered, the payee must meet only one of the criteria to pass generation control.

HR Status for Element <Name> page

Use the HR Status for Element <name> page (GP_GCTL_ST_SEC) to exclude or include employee status conditions during batch processing.

Navigation:

Click the **HR Status** link on the Conditions page.

This example illustrates the fields and controls on the HR Status for Element <name> page.

Generation Control - Empl Stat

Generation Control

HR Status for Element CH_AB_VAC_GEN ()

Include
 Exclude

Employee Status Find | View All First 1 of 1 Last

All Job Records in Segment + -
 Last Job Record

*Employee Status

| Field or Control | Description |
|-----------------------------------|---|
| Include and Exclude | Select the option to include or exclude the employee status conditions that you enter in the group box below. |
| All Job Records in Segment | Select to tell the system to look at all job rows in the segment. If any row contains the value indicated in the Employee Status field, it's considered a match. |
| Last Job Record | Select to tell the system to look only at the maximum effective-dated PS_JOB row for the match, within the period in question. |
| Employee Status | Select a status code from the list. |

HR Action/Reason for Element <Name> Page

Use the HR Action/Reason for Element <name> page (GP_GCTL_AR_SEC) to exclude or include action/reason code combinations.

Navigation:

Click the **Action/Reason** link on the Generation Control - Conditions page.

This example illustrates the fields and controls on the HR Action/Reason for Element <name> page.

| Field or Control | Description |
|----------------------------|---|
| Include and Exclude | Select the option to include or exclude the action/reason code combinations that you insert in the group box below. |
| Use Last Day Worked | Select to use the last day worked. |
| Action and Reason | Select from the list of HR Action codes. |

Note: If an action is entered with no reason, the system assumes that all reasons are valid.

Generation Control - Frequency for Element <Name> Page

Use the Generation Control - Frequency for Element <name> page (GP_GCTL_FQ_SEC) to exclude or include frequency codes.

Navigation:

Click the **Frequency** link on the Generation Control - Conditions page.

This example illustrates the fields and controls on the Generation Control - Frequency for Element <name> page.

| <i>Field or Control</i> | <i>Description</i> |
|----------------------------|---|
| Include and Exclude | Select the option to include or exclude the frequency codes that you insert into the group box below. |
| Frequency | Select from the list of codes. |

Generation Control - Segment Status for Element <Name> Page

Use the Generation Control - Segment Status for Element <name> page (GP_GCTL_SS_SEC) to exclude or include segment status conditions.

Navigation:

Click the **Segment Status** link on the Generation Control - Conditions page.

This example illustrates the fields and controls on the Generation Control - Segment Status for Element <name> page.

| <i>Field or Control</i> | <i>Description</i> |
|----------------------------|---|
| Include and Exclude | Select the option to include or exclude the segment status conditions that you insert in the group box below. |
| Segment Status | Select from the list of conditions. |

Generation Control - Formula for Element <Name> Page

Use the Generation Control - Formula for Element <name> page (GP_GCTL_FM_SEC) to exclude or include formula elements.

Navigation:

Click the **Formula** link on the Generation Control - Conditions page.

This example illustrates the fields and controls on the Generation Control - Formula for Element <name> page.

| <i>Field or Control</i> | <i>Description</i> |
|----------------------------|--|
| Include and Exclude | Select the option to include or exclude the formula elements that you insert into the group box below. |
| Formula Name | Select from the list of elements. |

Generation Control - Run Type for Element <Name> Page

Use the Generation Control -Run Type for Element <name> page (GP_GCTL_RT_SEC) to exclude or include run types.

Navigation:

Click the **Run Type** link on the Conditions page.

This example illustrates the fields and controls on the Generation Control - Run Type for Element <name> page.

The screenshot shows a web interface titled "Generation Control - Run Type" for element "CH_AB_VAC_GEN ()". It features two radio buttons: "Include" (selected) and "Exclude". Below is a table with columns "Run Type" and "Description". The table has a search icon in the "Run Type" column and "+" and "-" icons in the "Description" column. Navigation controls at the top right include "First", "1 of 1", and "Last".

| <i>Field or Control</i> | <i>Description</i> |
|----------------------------|--|
| Include and Exclude | Select the option to include or exclude the run type that you insert in the group box below. |
| Run Type | Select from the list of run types. |

Defining Generation Control Frequency

To define generation control frequency, use the Generation Control Frequencies (GP_GCTL_FREQUENCY) component.

Page Used to Define Generation Control Frequency

| <i>Page Name</i> | <i>Definition Name</i> | <i>Usage</i> |
|--|------------------------|--|
| <u>Generation Control Frequencies Page</u> | GP_GCTL_FREQUENCY | Define a generation control frequency. |

Understanding Generation Control Frequency

The frequency tag element is used to define an intermediary table so that the system can associate a HR frequency (residing in the HR Frequency Table, FREQUENCY_TBL) with an Absence Management frequency. There are many frequencies that you use infrequently, and this feature enables you to define them through a table in Absence Management rather than through the HR Frequency Table.

Through use of the frequency tag, generation control is also related to how the system annualizes and deannualizes elements.

When you aren't using generation control, the numerator for annualization is the element's frequency and the denominator is the calendar period frequency. When you are using generation control, the numerator for annualization is still the element's frequency but the denominator is the generation control frequency.

Generation Control Frequencies Page

Use the Generation Control Frequencies page (GP_GCTL_FREQUENCY) to define a generation control frequency.

Navigation:

Set Up HCM > Product Related > Global Payroll & Absence Mgmt > Elements > Supporting Elements > Generation Control Frequencies > Generation Control Frequency

This example illustrates the fields and controls on the Generation Control Frequencies page.

Generation Control Frequencies

Frequency Tag

*Description

Short Description

*Frequency

Frequency Type

Frequency Annualization Factor

| <i>Field or Control</i> | <i>Description</i> |
|-------------------------|--|
| Frequency | Select from the list of available values (<i>Annual, Biweekly, Contract, Daily</i> , and so on.) The values in this field come from FREQUENCY_TBL. |

Chapter 8

Defining Earning and Deduction Elements

Understanding Earning and Deduction Elements

This topic discusses:

- Earnings and deductions.
- Calculation rules.
- Components.
- Automatically generated accumulators.

Earnings and Deductions

Earning and deduction elements enable you to send absence-related data to your payroll system so that payees can be appropriately compensated for time off. Think of earnings as adding to a person's pay and deductions as subtracting from a person's pay. There's little difference between defining earning elements and defining deduction elements.

The payroll system with which Absence Management is integrated determines whether you should create earning elements, deduction elements, or both:

- If using PeopleSoft Payroll for North America, create earning elements.
- If using PeopleSoft Payroll Interface with a third-party payroll system, create earning elements, deduction elements, or both as needed.

After you create earning and deduction elements in Absence Management, you map these elements to their counterparts in your payroll system. The rules that you define in Absence Management should be consistent with the corresponding earning and deduction rules in your payroll system.

Related Links

[Integration](#)

Calculation Rules

When you define an earning or deduction element, you select from one of four calculation rules:

- $\text{Unit} \times \text{rate}$.
- $\text{Unit} \times \text{rate} \times \text{percent}$.
- $\text{Base} \times \text{percent}$.

- Amount.

An element's calculation rule determines which values the system can transmit to your payroll system after you process absence events.

In most cases, you'll want to select a calculation rule of unit \times rate or unit \times rate \times percent. This enables you to pass the units of paid and unpaid time calculated by the Absence Take process to your payroll system. Absence Management will pass along the retrieved value for rate, percent, and amount, if these are part of the calculation rule, but it does not calculate values for these components.

Components

Saving an element definition causes the system to automatically generate the following components based on the selected calculation rule: unit, rate, base, percent.

Automatically generated components have the same name as the earning or deduction element plus a suffix. For example, if you create the earning element VACATION = Unit \times Rate, the system automatically generates two component elements named VACATION_UNIT and VACATION_RATE. Suffix names are determined by the country that you specify for the earning or deduction element on the Element Name page.

Note: Names of earning and deduction elements are limited to 12 characters because of suffixes. Other element names can have as many as 18 characters.

Components take on the attributes of the earning or deduction element. If you change the attributes of the earning or deduction element, the component attributes also change. To continue with the previous example, if you change the name of the VACATION earning element to PTO, the system changes the component names to PTO_UNIT and PTO_RATE. The only attributes of a component that you can change directly are the description, comments, customer fields, and the Via Element Overrides option. You make these changes on the Components page.

A component is also an element and can therefore be used in another element's definition. As an example, assume that you define the following elements:

- SICK1 = Unit \times Rate.
- SICK2 = Unit \times Rate.
- SICK2 Rate = SICK1 Rate.

When the system calculates the rate for SICK2, it uses the rate for SICK1. You don't have to redefine the rate for every new element. No matter how the rate for SICK1 is defined (numeric, formula, and so on), the rate for SICK2 always equals the rate for SICK1.

Related Links

[Updating Component Element Information](#)
[Defining Suffixes](#)

Automatically Generated Accumulators

When you define an earning or deduction element, you can specify which accumulators to create. For example, a year-to-date accumulator for an earning or deduction element. You can base the accumulators on calendar periods, fiscal periods, or both. You can also indicate whether you want to store amounts, units, or both and the periods that you want to store in the accumulator: period-, month-, quarter-, or year-to-date.

Note: Although the system creates automatically generated accumulators for earning and deduction elements, it does not update these accumulators. This is because Absence Management does not resolve earning and deduction elements. The use of these accumulators is applicable to PeopleSoft Global Payroll.

Like components, automatically generated accumulators take on the attributes of the corresponding earning or deduction element and use the suffixes that you define on the Earnings and Deductions page of the Element Suffixes component (GP_SUFFIX).

Note: The only accumulators whose attributes are tied directly to an earning element or deduction element are those that are automatically generated by the Earning component (GP_EARNING) or the Deductions component (GP_DEDUCTION). Attributes of accumulators that you create using the Accumulators component (GP_ACCUMULATOR) are not tied directly to earning or deduction elements.

Related Links

[Understanding Accumulators](#)

Defining Earning Elements

To set up earning elements, use the Earning (GP_EARNING) component.

Pages Used to Define Earning Elements

| <i>Page Name</i> | <i>Definition Name</i> | <i>Usage</i> |
|---|------------------------|--|
| Earnings Name Page | GP_PIN | Name the element and define its basic parameters. |
| Calculation Page | GP_ERN_DED_CALC | Define calculation rules for an earning element. |
| Earnings - Generated Elements for Element <Name> Page | GP_AUTOGEN_SEC | Displays the system-generated components and accumulators that have been created for an earning element. |

Understanding Setup Steps for Earning Elements

In Absence Management, earnings represent compensation that payees receive for paid absence events. You define earning elements to represent your organization's earning rules. The earning elements that you create in Absence Management should correspond to earning codes that are defined in your payroll system. For example, if your payroll system has an earning code for vacation pay, you should set up an earning element in Absence Management for vacation pay. After you define earning and deduction elements, you map them to payroll earning and deduction codes.

To create an earning element:

1. Define the earning name, security levels, and allowable overrides on the Earnings Name page.
2. Set up the calculation rule on the Earning - Calculation page.

You select the components that make up the calculation rule: an amount or a combination of a base, percent, rate, and unit.

Note: You cannot change a calculation rule after you run the Absence Take process.

Earnings Name Page

Use the Earnings Name page (GP_PIN) to name the element and define its basic parameters.

Navigation:

Set Up HCM > Product Related > Global Payroll & Absence Mgmt > Elements > Payroll Elements > Earnings > Earnings Name

This example illustrates the fields and controls on the Earnings Name page.

The screenshot displays the 'Earnings Name' page with the following details:

- Navigation Tabs:** Earnings Name (selected), Calculation, Rounding/Proration, Auto Generated Accumulators, Accumulators, Supporting Element Overrides.
- Basic Information:**
 - *Name: K0WJURY PAID
 - *Description: Jury Leave
 - *Definition As Of Date: Calendar Period End Date
 - Element Type: Earnings
 - *Field Format: Monetary
 - Element Nbr: 2318
 - Always Recalculate
- Element Use:**
 - *Owner: PS Delivered / Not Maintained
 - *Class: Sample Data
 - *Used By: All Countries
 - Country: ALL
 - Industry/Region:
 - Category: ABS Absence
- Override Levels:**
 - Pay Entity
 - Pay Group
 - Payee
 - Calendar
 - Via Elements
 - Element Definition
 - Positive Input
- Results:**
 - Store
 - Always Store
 - If Element Is Non-Zero
 - If Element Or Comp Is Non-Zero
- Resolution Parameters:**
 - Driver Accumulator:
 - User Fields:
- Version Information:**
 - Last Updated: 11/30/04 12:00:00.000000AM
 - Last Updated By: PPLSOFT
 - User Version:
 - Version: P_8.90.00.00
- Footer:** Custom Fields, Comments

Note: You name every element and define its basic parameters on an Element Name page. All element components within Absence Management share the same first Element Name page (GP_PIN). However, the Earnings Name page contains the following additional fields that apply only to earnings.

| Field or Control | Description |
|-------------------------|--|
| Driver Accumulator | This field applies only to Global Payroll. |
| User Fields | This link applies only to Global Payroll. |

Note: For information on the remaining fields on the Earnings Name page, see [Defining Element Names](#).

Calculation Page

Use the Calculation page (GP_ERN_DED_CALC) to define calculation rules for an earning element.

Navigation:

Set Up HCM > Product Related > Global Payroll & Absence Mgmt > Elements > Payroll Elements > Earnings > Calculation

This example illustrates the fields and controls on the Earnings - Calculation page.

The screenshot displays the 'Calculation' tab for an element named 'K0WJURY PAID' (Jury Leave) owned by 'PS Non-Mnt'. The 'Definition' section shows an effective date of 01/01/1990 and a calculation rule of 'Unit * Rate * Percent'. Below this, there are dropdown menus for 'Unit Type', 'Rate Type', 'Base Type', 'Percent Type', and 'Amount Type', each with a corresponding 'Element' field. The 'Retro Recalculation Option' section has 'Always Recalculate' selected. The 'Frequency Option' is set to 'Use Calendar Period Frequency'.

| Field or Control | Description |
|---|--|
| Calculation Rule | <p>Define the calculation rule for the element. Valid values are <i>Amount</i>, <i>Base x Percent</i>, <i>Unit x Rate</i>, and <i>Unit x Rate x Percent</i>. Your selection affects the availability of other fields.</p> <p>When you process absence events, the system can generate units for the earning elements, which you can transmit to your payroll system. If you integrate Absence Management with Payroll for North America or Payroll Interface, select a calculation rule that includes units. <i>Unit x Rate x Percent</i> is recommended because it enables you to send both rate and percent information to your payroll system.</p> <p>Once you define a calculation rule for an element, you cannot change the rule after output results are generated for the element. If you need to change the element definition, create a new element.</p> |
| Unit Type, Rate Type, Base Type, Percent Type, and Amount Type | <p>The fields that you can update here depend on the selected calculation rule. Select <i>Payee Level</i> for each applicable component.</p> <hr/> <p>Note: In Global Payroll, these fields tell the system how to determine the component values or amount. In Absence Management, you use the Absence Take - Day Formula page (when you link the earning element to a take element) to tell the system how to determine the component values or amount.</p> <hr/> |
| Unit Element, Rate Element, Base Element, Percent Element, Amount Element, Amount Value and Amount Currency | <p>These fields are not available when you select Payee as the component type.</p> |
| Generation Control | <p>This field applies only to Global Payroll.</p> |
| Pre Process Formula and Post Process Formula | <p>These fields apply only to Global Payroll.</p> |
| Frequency Option and Frequency | <p>These fields apply only to Global Payroll.</p> |
| Retro Recalculation Option | <p>Specify whether to recalculate an element during retroactive processing. Values are:</p> <p><i>Always Recalculate</i></p> <p><i>Do Not Recalculate</i></p> <p>If you select <i>Always Recalculate</i> here, the element is recalculated during processing the element in a retroactive situation.</p> <hr/> <p>Note: You can override this field on the Retro Process Overrides page.</p> <hr/> <p>See Understanding Retroactive Processing.</p> |

Earnings - Generated Elements for Element <Name> Page

Use the Earnings - Generated Elements for Element <name> page (GP_AUTOGEN_SEC) to displays the system-generated components and accumulators that have been created for an earning element.

Navigation:

Set Up HCM > Product Related > Global Payroll & Absence Mgmt > Elements > Payroll Elements > Earnings > Auto Generated Accumulators

Click the **View Generated Elements** link.

This example illustrates the fields and controls on the Earnings - Generated Elements for Element <name> page.

[Auto Generated Elements](#)

Earnings

Generated Elements for Element K0WJURY PAID (Jury Leave)

Components

| | | |
|--------------|-------------------|-----------------|
| Unit Element | K0WJURY PAID_UNIT | Base Element |
| Rate Element | K0WJURY PAID_RATE | Percent Element |
| | K0WJURY PAID_PCT | |

Auto Generated Accumulators [Personalize](#) |

| Accumulator Type | Name |
|------------------|------|
| | |

| <i>Field or Control</i> | <i>Description</i> |
|------------------------------------|---|
| Components | Displays the automatically generated element for each component of the earning element. |
| Auto Generated Accumulators | Displays automatically generated accumulators. |

Related Links

[Defining Suffixes](#)

Defining Deduction Elements

To set up deduction elements, use the Deductions (GP_DEDUCTION) component.

Pages Used to Define Deduction Elements

| <i>Page Name</i> | <i>Definition Name</i> | <i>Usage</i> |
|--|------------------------|---|
| Deduction Name Page | GP_PIN | Name the element and define its basic parameters. |
| Calculation Page | GP_ERN_DED_CALC | Define calculation rules for a deduction element. |
| Generated Elements for Element <Name> Page | GP_AUTOGEN_SEC | Displays the system-generated components and accumulators that have been created for a deduction element. |

Understanding Setup Steps for Deduction Elements

A deduction is a payroll element that subtracts from a person's pay. If you are using Absence Management with Payroll Interface, you can create deduction elements in addition to earning elements to compensate payees for time off. Do not create deduction elements if you are using Payroll for North America with Absence Management. Absence Management does not transmit deduction data to Payroll for North America.

To create a deduction element, define the deduction name and calculation rule.

Related Links

[Defining Earning Elements](#)

Deduction Name Page

Use the Deduction Name page (GP_PIN) to name the element and define its basic parameters.

Navigation:

Set Up HCM > Product Related > Global Payroll & Absence Mgmt > Elements > Payroll Elements > Deductions > Deduction Name

You name every element and define its basic parameters on an Element Name page. All element components within Absence Management share the same first Element Name page (GP_PIN).

The Deduction Name page is similar to the [Earnings Name Page](#).

Calculation Page

Use the Calculation page (GP_ERN_DED_CALC) to define calculation rules for a deduction element.

Navigation:

Set Up HCM > Product Related > Global Payroll & Absence Mgmt > Elements > Payroll Elements > Deductions > Calculation

The Deduction - Calculation page is similar to the [Calculation Page](#).

Generated Elements for Element <Name> Page

Use the Generated Elements for Element <name> page (GP_AUTOGEN_SEC) to displays the system-generated components and accumulators that have been created for a deduction element.

Navigation:

Set Up HCM > Product Related > Global Payroll & Absence Mgmt > Elements > Payroll Elements > Deductions > Auto Generated Accumulators

Click the **View Generated Elements** link on the Deductions - Auto Generated Accumulators page.

The Generated Elements for Element <name> page is similar to the [Earnings - Generated Elements for Element <Name> Page](#).

Chapter 9

Setting Up Accumulators

Understanding Accumulators

This topic discusses:

- Accumulator elements.
- Balance accumulators in batch processing.
- Retroactive processing and accumulators.

Accumulator Elements

Accumulators are elements that store the cumulative values of defined items as they're processed. For example, they can store accrued entitlement balances and other cumulative values.

Accumulators can be defined:

- Automatically

When you create an entitlement element, the system can automatically generate a set of accumulators to track the value of the element over time. Automatically generated accumulators typically accumulate values for a single element. You specify the periods of time that the accumulators are to track.

- Manually

You can create accumulators to track several elements, such as all accrued entitlement. You select the elements that the accumulator is to track and define the period of time that the accumulator is to cover. You can accumulate a single value or multiple values over time.

There are two types of accumulators, some that pertain to a single segment, and others that span several calculation periods:

- Segment accumulators accumulate values during a single segment.
- Balance accumulators accumulate values over a period of time, such as a month or a year.

Related Links

[Understanding Auto Generated Accumulators](#)

Balance Accumulators in Batch Processing

This section describes various aspects of how the batch process handles balance accumulators.

Updating Balances

The system loads the value for an accumulator from the end of the previous period. When the accumulator is processed, the value for the current period is added to the historic value to maintain an up-to-date balance. For each period, the batch process pulls forward the accumulator likewise.

Creating New Instances

When defining an accumulator, assign such attributes as level, based-on date, and period to cover—such as calendar year. Level determines whether to keep separate counts per job or across jobs by employee. You can add specifications by adding user keys, such as contract or department. The period and based-on date determine the applicable time period. These attributes determine how and when the batch process creates and keeps separate instances of the same accumulator. The system creates a new instance of balance and segment accumulators anytime that you change the value of a key field. Balance accumulators also spin off a new instance for each new period.

Writing to the Result Tables

How you set up the Accumulator page tells the system whether to write the accumulator to the results tables. The system determines when to drop balance accumulators, using the number of months to maintain after end date and comparing the accumulate through date of each instance with the current pay period begin date.

Related Links

[Understanding Processing Elements](#)

Retroactive Processing and Accumulators

Accumulators reflect new retroactive values in the retroactive period by default.

Define all absence balance accumulators as corrective. This makes it possible for the true balance of the accumulator to be reflected in each period.

Related Links

[Loading Balance Accumulators](#)

Defining Accumulators

To define accumulators, use the Accumulators (GP_ACCUMULATOR) component.

Pages Used to Define Accumulators

| <i>Page Name</i> | <i>Definition Name</i> | <i>Usage</i> |
|---------------------------------------|------------------------|--|
| Accumulator Name Page | GP_PIN | Name an accumulator element and define its basic parameters. |

| Page Name | Definition Name | Usage |
|--|------------------------|--|
| Accumulators - Definition Page | GP_ACCUMULATOR_2 | Define the period information and indicate the timing of the accumulator's resolution. |
| Accumulators - Level Page | GP_ACCUMULATOR_1 | Specify keys for accumulators. |
| Accumulators - Members Page | GP_ACCUMULATOR_3 | Define the list of elements that contribute to an accumulator. |

Accumulator Name Page

Use the Accumulator Name page (GP_PIN) to name an accumulator element and define its basic parameters.

Navigation:

Set Up HCM > Product Related > Global Payroll & Absence Mgmt > Elements > Supporting Elements > Accumulator Totals by TRC > Accumulator Name

You must name every element that you create and define its basic parameters on an Element Name page. All element page groups share the same first Element Name page (GP_PIN).

Note: When creating an accumulator, you can select a decimal or monetary field format. Select *decimal* for elements that accumulate non-monetary values, such as holiday hours or years of service.

Related Links

[Defining Element Names](#)

Accumulators - Definition Page

Use the Accumulators - Definition page (GP_ACCUMULATOR_2) to define the period information and indicate the timing of the accumulator's resolution.

Navigation:

Set Up HCM > Product Related > Global Payroll & Absence Mgmt > Elements > Supporting Elements > Accumulators > Definition

This example illustrates the fields and controls on the Accumulators - Definition page.

| Accumulator Name | Definition | Level | Members |
|--|---------------|---|------------------|
| Element Name | K0WAE VAC_BAL | Vacations Balance Hrs | Owner PS Non-Mnt |
| Accumulator Period | | | |
| *Period Year to Date | | | |
| *Begin Option Use Pay Entity Calendar | | | |
| Initialize Rule | | Maintain After End Date | |
| Initialize Rule Element K0WFM CARRY OVER | | Number of Months | |
| Accumulate Based On | | Accumulator Timing | |
| *Based On Period End Date | | <input checked="" type="radio"/> As Contributing Member <input type="radio"/> As Accumulator Is Encountered <input type="radio"/> At End of Calculation | |
| Retroactive Behavior | | Storage Option | |
| <input checked="" type="checkbox"/> Use Corrective | | <input checked="" type="radio"/> All Calculations <input type="radio"/> Absence Calculation <input type="radio"/> Payroll Calculation | |
| Version P_8.90.00.00 | | | |

Accumulator Period

An accumulator period is the period for which an accumulator collects and accumulates amounts.

| Field or Control | Description |
|------------------|---|
| Period | <p>Select from the following options:</p> <p><i>Segment:</i> Represents one segment. If there's no segmentation, a segment period and an absence period are identical.</p> <p><i>Calendar Period:</i> The period begin and end dates come from the current calendar period.</p> <p><i>Month to Date:</i> The system collects information monthly.</p> <p><i>Quarter to Date:</i> The system collects information quarterly.</p> <p><i>Year to Date:</i> The system collects information yearly.</p> <p><i>Custom Period:</i> A custom period enables you to create an accumulator that's completely open-ended—an end date is not required, as might a custom period to track an employee's lifetime wages. When you select this option, the Date field appears for the begin date. Select the element type from the list in this new field.</p> |

| <i>Field or Control</i> | <i>Description</i> |
|-------------------------|---|
| Begin Option | <p>Select the accumulator's starting point. This field appears if you select <i>Month to Date</i>, <i>Quarter to Date</i>, or <i>Year to Date</i> in the Period field. Values are:</p> <p><i>Specify Date:</i> The Begin Month and the Begin Day fields appear. Enter the day and month or select variables to return these values.</p> <p><i>Use Paying Entity Calendar and Use Paying Entity Fiscal:</i> The system uses the defaults set on the Pay Entity Processing Details page.</p> |

Initialize Rule

| <i>Field or Control</i> | <i>Description</i> |
|--------------------------------|---|
| Initialize Rule Element | <p>Enter a formula element to be invoked when a new instance of an accumulator is created for a new period. This formula must also be a member of the accumulator for its results to be added to the accumulator. For example, at the beginning of a calendar year, you might want to have a YTD accumulator that contains accrued vacation time carry over the previous year's value, with certain limits. The formula that you select here can serve this purpose. When the accumulator for the new year is created, the formula is invoked. If you leave this field blank, no special processing occurs.</p> |

Maintain After End Date

| <i>Field or Control</i> | <i>Description</i> |
|-------------------------|---|
| Number of Months | <p>Specify how long an accumulator remains in the output results table after its stop date. You can use this to access a previous accumulator value for a current calculation.</p> <hr/> <p>Note: If you select <i>Segment</i> in the Period field, this field becomes unavailable.</p> <hr/> |

Custom Period End Date Options

These fields are only available for custom period accumulators.

Note: The two fields in this group box work independently.

| Field or Control | Description |
|-----------------------------|---|
| Set End Date If Zero | <p>Select this option to set the accumulator's end date to the segment end date in the period when the accumulator value equals zero. This lets the system display the accumulator's value when it reaches zero and then cease storing this value in the subsequent period.</p> <p>For example, when tracking entitlement for vacations, you could use this field to display the balance until it reaches zero. If you select this check box, the system populates the Duration in Months field to 999 by default (equivalent to no end date).</p> |
| Duration in Months | <p>Enter the accumulator's length of duration. The custom period ends after this duration. For example, when tracking maternity leave, you could use this field to display the accumulator for a set entitlement number of months. You should not enter a value in this field if you select the Set End Date if Zero check box. If you select the Set End Date If Zero check box, the system will overwrite any value you enter in the Duration in Months field with a value of 999 (equivalent to no end date).</p> |

Accumulate Based On

| <i>Field or Control</i> | <i>Description</i> |
|-------------------------|--|
| Based On | <p>Select the calendar period date to use when determining the correct period for recording accumulators. Select from <i>Period Begin Date</i>, <i>Period End Date</i> (default), <i>Payment Date</i>, or <i>Specified Date</i>. <i>Specified Date</i> is commonly used in absence situations. An absence is often linked back to its initial date, even if that was in another period.</p> <p>Example:</p> <p>A certain monthly accumulator has one member: E1.</p> <p>A weekly pay group has these period dates:</p> <p>Begin Date = January 26, 2005</p> <p>End Date = February 3, 2005</p> <p>Payment Date = February 4, 2005</p> <p>E1 = 10</p> <p>The Based On field value tells the system whether the 10 of E1 is added to the monthly value for January or February. If you select <i>Period Begin Date</i>, the 10 is added to the January balance. If you select <i>Period End Date</i>, (or <i>Payment Date</i>), the 10 is added to the February balance.</p> <hr/> <p>Note: This field is available only if you select <i>Month to Date</i>, <i>Quarter to Date</i>, or <i>Year to Date</i> in the Period field.</p> <hr/> |

Retroactive Behavior

| <i>Field or Control</i> | <i>Description</i> |
|-------------------------|--|
| Use Corrective | <p>Select this check box. (This option has added functionality for PeopleSoft Global Payroll.)</p> <hr/> <p>Note: This check box must be selected to correctly process retroactivity in Absence Management.</p> <hr/> |

Accumulator Timing

Select the method for resolving the accumulator. Every accumulator has a list of elements associated with it (defined on the Accumulator Elements page). If you reference the accumulator during processing, the value of the accumulator varies, depending on the time that you specify for the accumulation.

| Field or Control | Description |
|--------------------------------------|---|
| As Contributing | As each contributing element is resolved, the accumulator is updated to reflect the new value. The system adds the value of an element—such as an earning or an entitlement—to the accumulator as the system calculates the element. The accumulator doesn't need to appear on the process list. |
| As Accumulator is Encountered | The accumulator is resolved whenever it is encountered, for example, within a formula. The accumulator does not need to appear on the process list to be resolved. When a contributing element to an accumulator is resolved, the accumulator itself is not automatically updated with the new value. |
| At End of Calculation | The accumulator is not updated during the main calculation process, but maintains the value loaded from the end of the last finalized segment. Only after all other elements are resolved does the system update the accumulator to reflect the new, current values of its contributing members. This is done automatically: the accumulator does not need to be on the process list. By default, auto-generated accumulators are defined as <i>at end of calculation</i> . |

Storage Option

| Field or Control | Description |
|-------------------------|---|
| Storage Option | <p>Select the run types during which you can change and store accumulators. Options are:</p> <ul style="list-style-type: none"> • <i>All Calculations</i>: The accumulator value can be changed during any run type. The value is stored after every run. <hr/> <p>Note: Select this option only if truly necessary. Storing values after every run can consume significant storage space.</p> <hr/> <ul style="list-style-type: none"> • <i>Payroll Calculation</i>: This option applies only when using Global Payroll with Absence Management. • <i>Absence Calculation</i>: The accumulator value can be changed during an absence run only. The value is only stored after an absence run. |

Note: The system displays an error message if an accumulator is updated during the inappropriate run type. The error message appears, for example, if you attempt to update an absence accumulator in a payroll run.

Warning! You should select the storage option before performing batch processing. This is to ensure that the method the batch system uses to load accumulator balances is consistent with the results already generated.

Accumulators - Level Page

Use the Accumulators -Level page (GP_ACCUMULATOR_1) to specify keys for accumulators.

Navigation:

Set Up HCM > Product Related > Global Payroll & Absence Mgmt > Elements > Supporting Elements > Accumulators > Level

This example illustrates the fields and controls on the Accumulators - Level page.

| Accumulator Name | Definition | Level | Members |
|--|---------------|-----------------------|------------------|
| Element Name | K0WAE VAC_BAL | Vacations Balance Hrs | Owner PS Non-Mnt |
| Accumulator Level | | | |
| <input type="radio"/> Payee (EMPLID) <input checked="" type="radio"/> Job (EMPLID/EMPL_RCD) | | | |
| User Key Type 1 | SystemElem | Key Element 1 | COMPANY |
| User Key Type 2 | SystemElem | Key Element 2 | PAY ENTITY |
| User Key Type 3 | SystemElem | Key Element 3 | GP PAYGROUP |
| User Key Type 4 | SystemElem | Key Element 4 | CONTRACT NUMBER |
| User Key Type 5 | | Key Element 5 | |
| User Key Type 6 | | Key Element 6 | |

| Field or Control | Description |
|--|---|
| Payee (EMPLID) (payee employee ID) | Select to have the accumulator store the results for all of a payee's jobs together. This is the default option. |
| Job (EMPLID/EMPL_RCD) (job employee ID/employee record) | Select to have the system store the results for each job that a payee holds in a separate accumulator with EMPLID/Rcd as a key. |
| User Key Type | <p>You can define up to six user keys for an accumulator. User keys enable you to track a given accumulator at levels below employee record. For example, you can track an employee's year-to-date earnings by contract number or company.</p> <p>Enter the type of element for the user key. Values are <i>Variable</i> and <i>SystemElem</i>.</p> |

| Field or Control | Description |
|-------------------------|---|
| Key Element | <p>Use these fields to select the elements to use as the accumulator keys. For example, to track an accumulator by company, select the system element COMPANY as a user key, which directs the system to maintain different accumulated numbers for each location of the employee.</p> <p>The following guidelines apply:</p> <ul style="list-style-type: none"> • The system doesn't accumulate employee data across pay groups and pay entities in different countries. Thus, COUNTRY is not a meaningful user key. • Key values are limited to 25 characters and can be characters, dates, or integers. Before selecting user keys, know how their values are stored in the results table. • You can use decimal and monetary elements as user keys, but the system uses only the whole number and ignores the decimal part. Negative values are converted and stored as positive values. |

Related Links

[Retroactive Processing and Accumulators](#)

Accumulators - Members Page

Use the Accumulators - Members page (GP_ACCUMULATOR_3) to define the list of elements that contribute to an accumulator.

Navigation:

Set Up HCM > Product Related > Global Payroll & Absence Mgmt > Elements > Supporting Elements > Accumulators > Members

This example illustrates the fields and controls on the Accumulators - Members page: Members tab.

| Accumulator Name Definition Level Members | | | | | |
|--|------------------|-----------------------|-----------------------|----------|------------------|
| Element Name | | K0WAE VAC_BAL | Vacations Balance Hrs | Owner | PS Non-Mnt |
| Element Member List | | | | | |
| Personalize Find First 1-4 of 4 Last | | | | | |
| Members Contributions | | | | | |
| Element Type | Element Name | Description | *Begin Date | End Date | Accumulator Sign |
| Abs Entitl | K0WAE VAC | Vacations Entitlement | 01/01/1990 | | Add |
| Auto Assgn | K0WAE VAC_UNP | Vacations Entitlement | 01/01/1990 | | Subtract |
| Auto Assgn | K0WAE VAC_UNAD | Vacations Entitlement | 01/01/1990 | | Add |
| Formula | K0WFM CARRY OVER | Carry Over Formula | 01/01/1990 | | Add |

Members

Select the Members tab.

Use the fields on this tab to specify which elements contribute to the accumulator's total.

| Field or Control | Description |
|--------------------------------|--|
| Element Type | Select from the list of element types. Values are <i>Abs Entitl</i> , <i>Array</i> , <i>Auto Assgn</i> , <i>Bracket</i> , <i>Deduction</i> , <i>Duration</i> , <i>Earnings</i> , <i>Formula</i> , <i>Seg. Accum</i> , <i>System Elem</i> , and <i>Variable</i> . |
| Element Name | Select elements that contribute to the accumulator's total. An element can accumulate to multiple accumulators; accumulators can contribute to other accumulators. |
| Begin Date and End Date | Tell the system when a member must start and stop calculating an accumulator. If this field is blank, the system continues updating the accumulator indefinitely while the elements remain valid. |
| Accumulator Sign | Select <i>Add</i> or <i>Subtract</i> to indicate if the element adds to or subtracts from the accumulator. |

Contributions

Select the **Contributions** tab.

This example illustrates the fields and controls on the Accumulators - Members page: Contributions tab.

The screenshot shows the 'Contributions' tab selected. At the top, there are tabs for 'Accumulator Name', 'Definition', 'Level', and 'Members'. Below these, the 'Element Member List' is displayed. The table has the following data:

| Element Type | *Element Name | Percent Type | Percent to Accumulate |
|--------------|------------------|--------------|-----------------------|
| Abs Entitl | K0WAE VAC | Numeric | 100.000000 |
| Auto Assgn | K0WAE VAC_UNP | Numeric | 100.000000 |
| Auto Assgn | K0WAE VAC_UNAD | Numeric | 100.000000 |
| Formula | K0WFM CARRY OVER | Numeric | 100.000000 |

The system lists the elements that you selected on the **Members** tab.

| Field or Control | Description |
|---|---|
| Percent Type and Percent to Accumulate | <p>Specify the portion of the element's value that the system contributes to or subtracts from the accumulator. Values are:</p> <p><i>Numeric:</i> Select to specify a percentage of up to 100 percent. Enter the percentage in the Percent to Accumulate field.</p> <p><i>Variable or Formula:</i> Select to have a variable or formula element return the value to accumulate or subtract. Select the variable or formula name in the Element Name field.</p> |

Adjusting Accumulator Balances

Page Used to Adjust Accumulators

| Page Name | Definition Name | Usage |
|--|------------------------|---|
| <u>Adjust Balances - Accumulators Page</u> | GP_ACM_USER_ADJ | Adjust an accumulator balance for a given payee in a finalized calendar group. |
| <u>Accumulators Comments Modal</u> | GP_ACC_COMACC_SCF | Enter the comments for the adjustments. You can manage multiple comments according to the need. |

Understanding Accumulator Adjustments

For a given payee in a finalized calendar group, you can:

- Adjust an accumulator's results or add a new instance to the results.
- Insert a new accumulator into the results.

When adjusting accumulator results, adjust the accumulator that's loaded as the starting point for a calculation. For example, say that you finalize the March run, and then realize that an adjustment needs to be made to a March year-to-date accumulator. You make the adjustment. When you process the April run, the system reads the March year-to-date balance with the adjustment and uses it as the starting value for the accumulator. In contrast, if you ran April with a retroactive trigger that caused March to be recalculated, the starting balance would come from February and the adjustment would be ignored.

Note: We recommend using the Adjust Absence Balances (GP_PI_MNL_AE) page to adjust absence accumulators.

See [Adjusting and Overriding Entitlement Balances](#).

Adjust Balances - Accumulators Page

Use the Adjust Balances - Accumulators page (GP_ACM_USER_ADJ) to adjust an accumulator balance for a given payee in a finalized calendar group.

Navigation:

Global Payroll & Absence Mgmt > Payee Data > Adjust Balances > Accumulators > Accumulators

This example illustrates the fields and controls on the Adjust Balances - Accumulators page.

Accumulators

| | | |
|--------------------------------------|--------------------|-----------------------------|
| Employee ID 0034 | Alex Edmond | Empl Record 0 |
| Calendar Group ID K0CGK0CAK0PNA13B25 | K0CAK0PNA13B25 | Calendar ID K0CA K0PNA13B25 |
| Pay Group K0WPG KU2 | US Biweekly Hourly | |
| Pay Entity K0WPE PNA | Pay Entity PNA | |

Accumulator

Accumulator 401k Gross YTD

Instances

From Date Through Date

User Key 1 User Key 2

User Key 3 User Key 4

User Key 5 User Key 6

Value 0.000000 Applied Adjustment 0.000000

Adjustments

| Amount | Reason | Updated at | Updated by | Comments |
|-----------|--------|-------------------|------------|----------|
| 13.000000 | | 08/11/2020 6:00AM | PS | |

Note: You cannot adjust accumulators that are in an unfinalized calendar group.

Accumulator

| <i>Field or Control</i> | <i>Description</i> |
|-------------------------|--|
| Accumulator | Select the accumulator to adjust. Once selected, the system displays the accumulator's description to the right of this field and populates the Instances group box with information from the result tables. If no results are returned, the accumulator has no recorded balance for the identified employee record and calendar. |

Instances

This group box displays the recorded balance, if any, for the selected employee record and calendar. You can enter new instances to add to the result tables at the end of the calendar ID that appears.

| Field or Control | Description |
|--|--|
| From Date and Through Date | The begin and end dates for the accumulator period. |
| User Key | The user keys that are associated with the accumulator. |
| Value | The value of the accumulator for the employee (and employee record) at the end of that calendar ID period. |
| Accumulator Empl record (accumulator employee record) | <p>This field can be helpful when payees have more than one job. It identifies the employee record number to which the accumulator values pertain.</p> <p>All accumulator data for an employee ID is passed from one segment to another regardless of job. Therefore, when you access a particular Empl Rcd Nbr to view or adjust the accumulator values that resulted from processing that job, you can view and adjust the accumulator values for the payee's other jobs as well.</p> <p>As an example, assume that a payee has two jobs:</p> <ul style="list-style-type: none"> • Empl_rcd = 0 that accrues 10 hours of entitlement each month. • Empl_rcd = 1 that accrues 11 hours of entitlement each month. <p>Assume also that Empl_rcd is a key for the year-to-date absence entitlement accumulator. Now, suppose that you process absences for two segments: January/Job 1 and January/Job 2. If you were to access the Adjust Accumulator Balance page for Empl_rcd 0 for the January calendar (and click the Retrieve Data button), the system would display a value of 10 for Accumulator Empl Rcd Nbr 0. (The system provides a snapshot of what it processed for the first segment.) If you were to access this page for Empl_Rcd 1 instead, the system would again display a value of 10 for Accumulator Empl Rcd Nbr 0. In addition, it would display a value of 11 for Accumulator Empl Rcd Nbr 1, when you click the link for the next job.</p> <hr/> <p>Note: If you adjust the accumulator balance for Empl_rcd 0, Empl_rcd_acum 0, but the last segment processed for the payee was Empl_rcd 1, the system will ignore the adjustment. You should adjust the balance for Empl_rcd 1, Empl_rcd_acum 0 instead, because this balance becomes the source for the next calendar.</p> <hr/> |

| <i>Field or Control</i> | <i>Description</i> |
|---------------------------|---|
| Applied Adjustment | The sum of adjustments that have been made to this accumulator instance. When you click Save , this number is updated to reflect all accumulator adjustments that are currently entered in the Adjustments group box. |

Adjustments

| <i>Field or Control</i> | <i>Description</i> |
|--|--|
| Amount | Enter the adjustment amount, either positive or negative. |
| Reason | Enter the reason for the adjustment |
| Updated At and Updated by | The system populates these fields when you save the page and displays them when you query adjustments. |
|  | Select to open the Accumulators Comments Modal . |

Note: You can add new instances and adjust accumulators, but you cannot delete entered data. All adjustments remain in the system for an audit trail. To reverse a prior adjustment, enter a row with an offsetting or negative value.

Accumulators Comments Modal

Use the Accumulators Comments Modal (GP_ACC_COMACC_SCF) to enter the comments for the adjustments. You can manage multiple comments according to the need.

The following video provides more information on comments added to Accumulators and Balance Adjustments:

Video: [Image Highlights, PeopleSoft HCM Update Image 36: Comments to Accumulators and Balance Adjustments](#).

This example illustrates the fields and controls on the Accumulators Comments Modal.

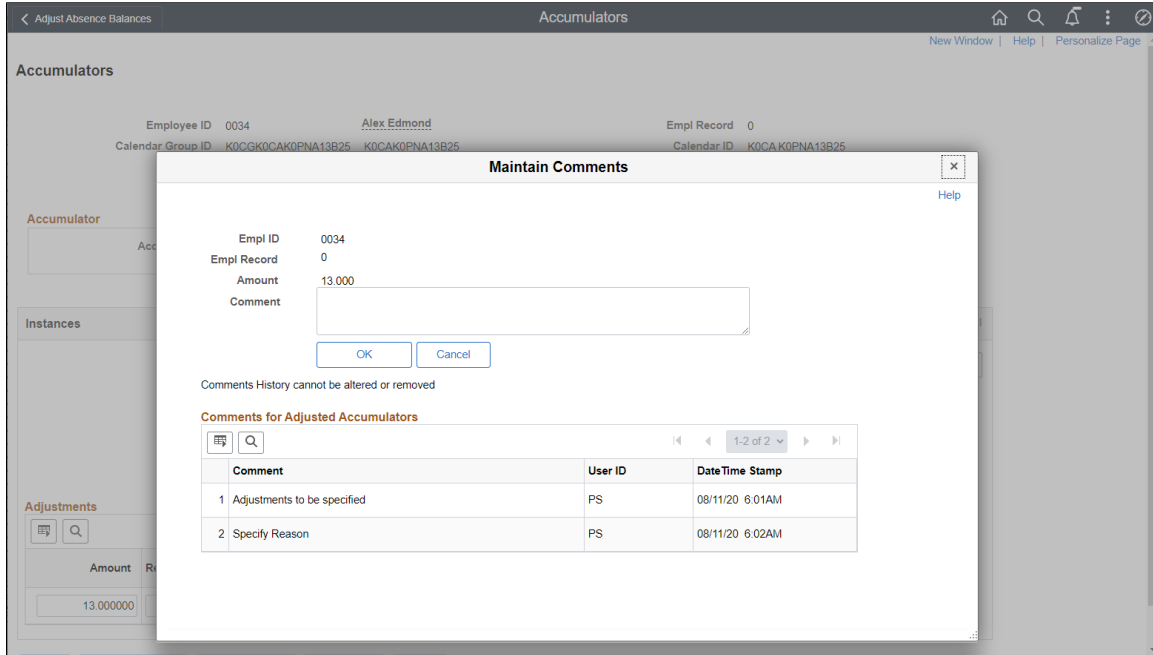

Note: You can edit comments until you save the Accumulators page. The comments are saved only after saving the Accumulators page.

Chapter 10

Defining Processing Elements

Understanding Processing Elements

Absence Management enables you to define absence take and absence entitlement processes. To set up processing:

1. Create *sections*, which are logical groups of elements that are resolved during an absence run.
2. Add the sections to a *process list* that identifies the sequence and conditions under which each section of elements is resolved.

You can create any number of process lists.

3. Attach each process list to a calendar, by associating the process list with a run type.
4. Schedule the calendars for processing.

To run an absence process, run the process that you defined. The Process List Manager program starts at the top of the process list and, for each payee, works with the PIN Manager to resolve elements sequentially in each process list section. The system creates a set of files and tables to hold the processing results.

Common Elements Used for Element Processing

| <i>Field or Control</i> | <i>Description</i> |
|----------------------------------|--|
| Seq Nbr (sequence number) | <p>Enter a sequence number for the element in the section to specify processing order. The processing sequence is extremely important; it can directly affect absence calculations.</p> <p>Numbers can be up to 5 digits, and each number in the section must be unique. Assign numbers in increments of 10 or some other factor to avoid having to renumber to insert an element.</p> |
| Recalculate | <p>Select this check box to instruct the PIN Manager to recalculate the element if it encounters it more than once in the process list. Clear the check box to have the PIN Manager adhere to the Always Recalculate check box setting on the Element Name page for the element.</p> <p>Avoid recalculating elements, which can slow down processing.</p> |

Understanding Sections

This topic discusses:

- Section types
- Standard sections
- Payee sections
- Absence take sections

Section Types

Sections control the processing order of individual elements, breaking down large process lists into manageable pieces. Each section can have one or more individual elements. You can't add element groups to a section and generally can't include sections in sections.

Using sections enables reuse of work. For example, if several processes use the same set of take elements, you can create one section for takes and attach it to multiple process lists.

Sections are effective-dated—during processing, the system retrieves sections attached to the process list, based on your calendar period end date.

You can define four section types, which determine:

- How the system processes section elements during absence runs.
- What types of elements—such as absence take elements, and supporting elements—you can add to the section.

This table lists the section types and what each section is used for:

| Section Type | Use |
|---------------------|---|
| Standard | For regular processing when defining absence entitlement or absence take processes. |
| Payee | For specifying, at the payee level, elements for processing and their sequence. |
| Absence Take | For resolving absence takes in chronological order based on the absence begin date. |

Standard Sections

Most sections in your process list are probably standard sections. When the Process List Manager encounters a standard section, it reads and resolves each element in the section in the specified order.

Payee Sections

Payee sections enable you to control which elements are processed for a specific payee and their processing order.

Having created a payee section, use the Section Overrides page to define the elements to be resolved for a particular payee. When encountering a payee section in a process list, the system retrieves the appropriate payee section and processes the elements in the section one by one.

Process lists can have multiple payee sections.

Absence Take Sections

Absence take sections enable you to process take elements based on the order in which absences occurred, rather than the processing sequence defined in a section. These sections are useful when there are dependencies between take elements, and processing in chronological order is necessary to determine correctly which absences to pay.

Absence Take Section Example

Assume that there's a requirement to reduce sickness entitlement by the number of days a payee was absent for sickness or an industrial accident over the past year. In February, a payee is absent 7 days for sickness, 6 days for an industrial accident, and 8 days for sickness, in that order.

You create a section that includes take elements in this processing sequence: SICK, IND ACC. As the following paragraphs illustrate, section type affects the amount of entitlement that's available to cover the takes:

- If the section type is standard, the system processes both SICK takes before it processes the IND ACC take.

Consequently, it does not consider any days that were taken for the industrial accident when it determines the entitlement balance that is available for the second SICK take.

- If the section type is absence take, the system processes the absences in the order of occurrence.

As a result, it reduces the entitlement balance for the last SICK take by the number of days that were taken (paid) for the industrial accident and for prior sicknesses over the last year.

Rules for Absence Take Sections

Following are the rules for absence take sections:

- Absence take sections can include take elements only.
- Takes are processed based on absence begin date.

The system looks at the Absence Event record (GP_ABS_EVENT) to find the absence event with the earliest begin date.

- If more than one absence has the same date, the system refers to the processing sequence defined for the section to determine which take to process first.

For example, assume that an absence take section includes Takes A and B in that order and that the following absence events are reported: June 2–3 (Take B) and June 3 (Take A). The system will process the absent days in this order:

- June 2, Take B (the event with the earliest begin date).
 - June 3, Take A.
 - June 3, Take B.
- If a take element (parent element) is mapped to another take element (child element):
 - The child element is processed immediately after the parent element for the day being processed.

List the child element after the parent element on the process list. The system proceeds to the next day, only after processing all generated and manually entered take elements for that day.
 - Child elements that are not included in the section where the parent element is being processed are not processed until the system resolves the section that lists the child element.

Note: Mapping refers to linking one take to another by completing the **Mapped To Element** field on the Absence Take - Day Formula page or the **Take with Other Absence** field on the Absence Take - Negative Balances page.

See [Absence Takes - Day Formula Page](#).

See [Absence Takes - Negative Balances Page](#).

Understanding Process Lists

This topic discusses:

- Functions of process lists.
- Batch processing and the Process List Manager.
- Ordering elements and sections in a process list.
- Retroactive processing considerations for process lists.

Functions of Process Lists

Process lists control absence processing at the highest level. They identify the sections, or sets of elements, to resolve during processing and the order in which they resolve.

Batch Processing and the Process List Manager

The Process List Manager, a program that calls the PIN Manager during processing to resolve elements on the process list, begins at the top of the process list and reads one section at a time, according to the specified sequence. Whenever the Process List Manager encounters a conditional formula, it calls the

PIN Manager for resolution. If the formula resolves to zero, the section is not processed; if the formula resolves to a nonzero number, the section is processed.

This diagram illustrates how the Process List Manager and PIN Manager work together to resolve each section of the process list during an absence run.

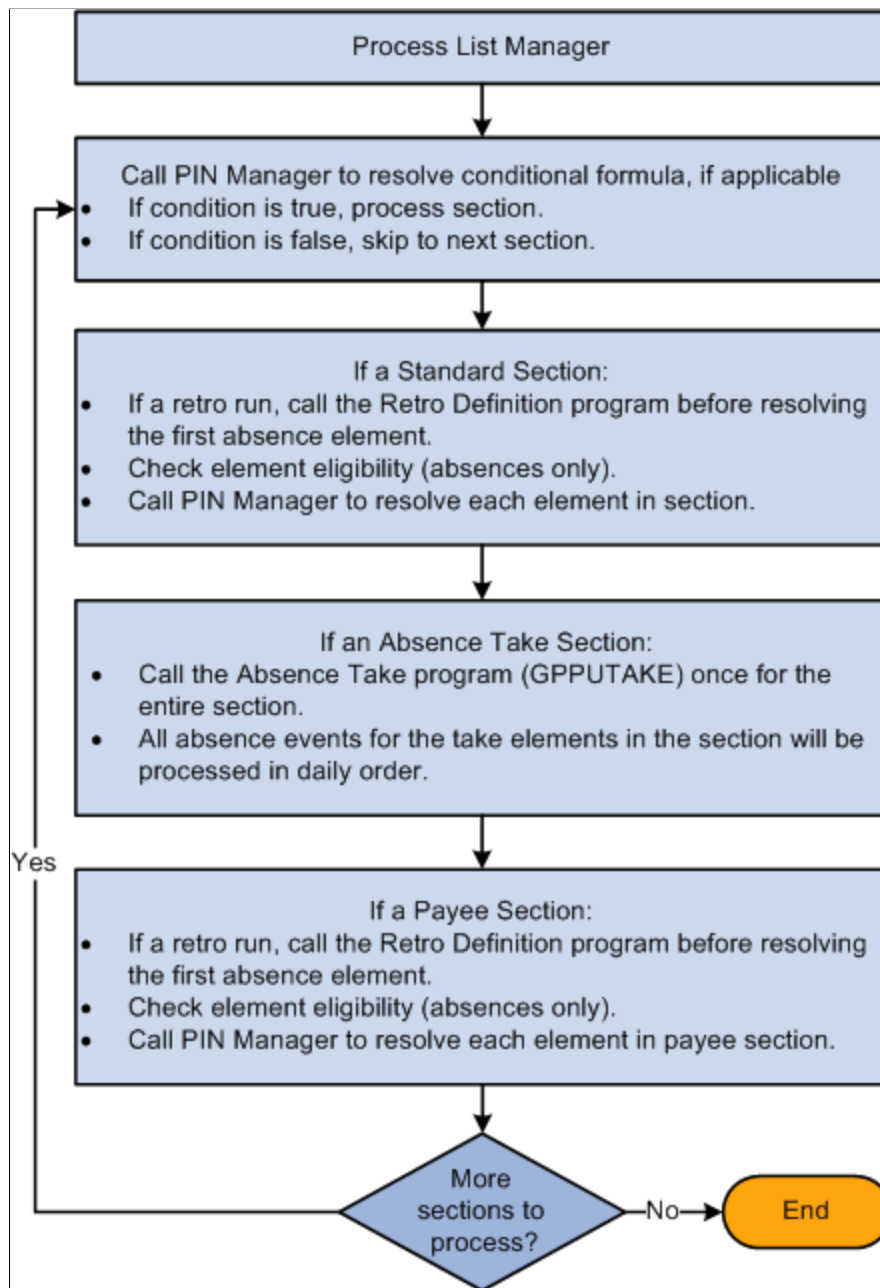

Related Links

[Understanding the Batch Architecture Process Flow](#)

Ordering Elements and Sections in a Process List

Here are some guidelines for verifying that elements in sections and sections in process lists are ordered logically in the correct sequence:

- Entitlement processing for absences adds to the entitlement balance.
Take processing takes away from the entitlement balance. If you include absence entitlement and absence take elements on the same process list and put the entitlement elements before the take elements, the additional entitlement balance becomes available for take processing.
- If an array needs to populate data fields before the system can execute a conditional formula, add the section with the array before the conditional section.
- Non-percent rate codes need to be resolved before percent rate codes, so that members of any Comp Rate (compensation rate) code group that need to be used in a percent calculation have been resolved.
- Base pay rate codes need resolving before any non base-pay rate codes, so that the appropriate hourly rate can be calculated and available for any hourly, plus flat amount rate code calculations.

Retroactive Processing Considerations for Process Lists

This topic discusses how changes to a process list can affect retroactive processing.

How Changes to a Process List Can Affect Retroactive Processing

Pay attention to effective dates. If you modify an effective-dated set of data that applies to previously processed periods, when retroactive processing is run, the results will vary. If you want to change the section for future periods only, add a new effective-dated row to the section, then modify the list of elements.

Related Links

[Understanding Retroactive Processing](#)

Setting Up Sections

To set up sections, use the Sections component (GP_SECTION).

Pages Used to Set Up Sections

| <i>Page Name</i> | <i>Definition Name</i> | <i>Usage</i> |
|--|------------------------|---|
| Section Name Page | GP_PIN | Name a section and define its basic parameters. |
| Sections - Definition Page | GP_SECTION | Select elements that constitute a section. |
| Payee Sections Page | GP_PYE_SECTION | Create a payee section for a process list. |

Understanding Section Set Up

Sections are the building blocks for creating process lists. You create a section by giving it an element name, selecting the section type, and entering elements in processing order. Eligible elements depend on the section type.

This diagram shows the element types that you can include in each section type.

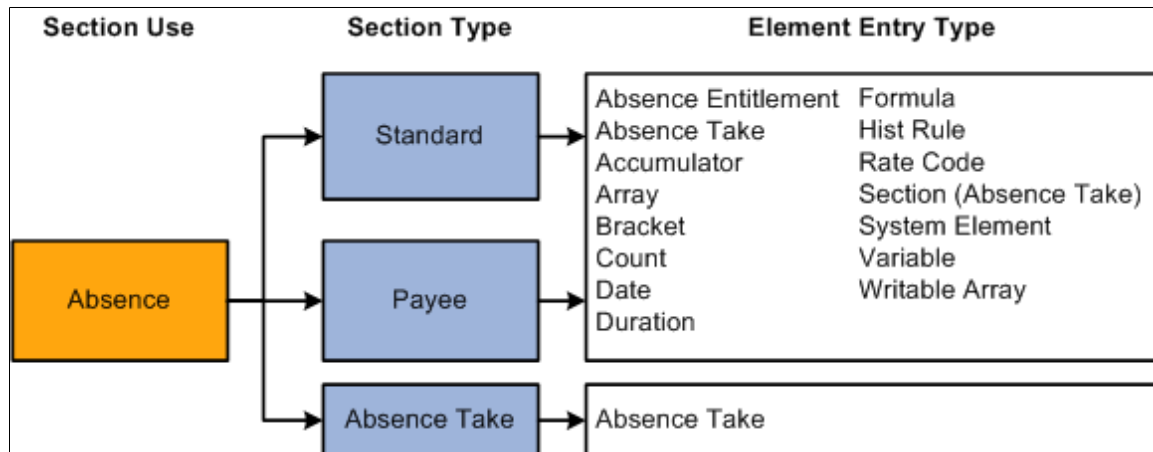

Note: Earnings and deductions are not included in process lists.

Warning! Adding or deleting an element from a section and then trying to process a retroactive run may yield incorrect results. Before changing any element in a section, assess the impact on retroactive processing.

Related Links

[Setting Up Sections](#)

[Ordering Elements and Sections in a Process List](#)

Section Name Page

Use the Section Name page (GP_PIN) to name a section and define its basic parameters.

Navigation:

Set Up HCM > Product Related > Global Payroll & Absence Mgmt > Framework > Processing > Sections > Section Name

You must enter the basic parameters of each section on the Section Name page. All elements within Absence Management share the same name page (GP_PIN).

Note: On the Section Name page, *Calendar Period End Date* is the only value for the **Definition as of Date** field. When you run an absence process, the system reads the calendar period end date to determine which effective-dated sections and process list to use.

Related Links

[Defining Element Names](#)

Sections - Definition Page

Use the Sections - Definition page (GP_SECTION) to select elements that constitute a section.

Navigation:

Set Up HCM > Product Related > Global Payroll & Absence Mgmt > Framework > Processing > Sections > Definition

This example illustrates the fields and controls on the Sections - Definition page.

| Field or Control | Description |
|-------------------------|--|
| Section Use | This field displays Absence Process Only. You cannot change this value. |
| Section Type | <p>Select the section type. This specifies how the Process List Manager processes the elements in this section. Options are <i>Standard</i>, <i>Absence Take</i>, and <i>Payee Section</i>.</p> <p>If you select <i>Payee Section</i>, all fields become unavailable for entry. After saving this page, you can access the Section Overrides page and select the elements to be resolved for a particular payee.</p> |
| Element Type | <p>Select the type of element that you're adding to the section. Values depend on your Section Type selection:</p> <p>Standard sections: Select <i>Abs Entitl</i> (frequency-based absence entitlement), <i>Abs Take</i> (absence take), <i>Accumulator</i>, <i>Array</i>, <i>Bracket</i>, <i>Count</i>, <i>Date</i>, <i>Duration</i>, <i>Formula</i>, <i>Hist Rule</i> (historical rule), <i>Rate Code</i>, <i>Section</i>, <i>System Element</i>, <i>Variable</i>, or <i>Writable Array</i>.</p> <p>Absence take section: Select <i>Abs Take</i>.</p> |

| Field or Control | Description |
|-------------------------|--|
| Element Name | Enter the name of the element to include in the section. Selectable names depend on the element type. |

Note: The Driver Accumulator tab is used with PeopleSoft Global Payroll only.

Payee Sections Page

Use the Payee Sections page (GP_PYE_SECTION) to create a payee section for a process list.

Navigation:

Global Payroll & Absence Mgmt > Payee Data > Create Overrides > Payee Sections > Section Overrides

This example illustrates the fields and controls on the Payee Sections page.

Before using this page, create a payee section using the Sections - Section Name and Sections - Definition pages.

| Field or Control | Description |
|-------------------------|--|
| Element Name | Enter the name of the payee section, as defined on the Sections - Section Name page. |
| Section Use | When you select the element name, the system displays <i>Absence</i> , to identify the purpose of the section. |

Payee Section Elements

| Field or Control | Description |
|-------------------------|--|
| Element Type | Select the type of element that you're adding to the section: <i>Absence Entitlement</i> (frequency-based entitlement elements), <i>Absence Take</i> , <i>Accumulator</i> , <i>Array</i> , <i>Bracket</i> , <i>Count</i> , <i>Date</i> , <i>Duration</i> , <i>Formula</i> , <i>Historic Rule</i> , <i>Rate Code</i> , <i>Section - Absence Take</i> , <i>System Element</i> , <i>Variable</i> , or <i>Writable Array</i> . |
| Element Name | Select the name of the element that you're adding to the section. |

Setting Up Process Lists

To set up a process list, use the Process Lists component (GP_PROCESS).

Pages Used to Set Up Process Lists

| Page Name | Definition Name | Usage |
|---|------------------------|---|
| Process List Name Page | GP_PIN | Name a process list and define its basic parameters. |
| Process Lists - Definition Page | GP_PROCESS | Identify sections comprising the process list and the order of execution. |

Understanding Process List Setup

Before creating a process list, you define the sections to include in the process, grouping sets of elements into sections for addition to your process list. In your process list, you can use conditional logic to specify when each section is executed.

This diagram illustrates the relationship between elements, sections, and process lists.

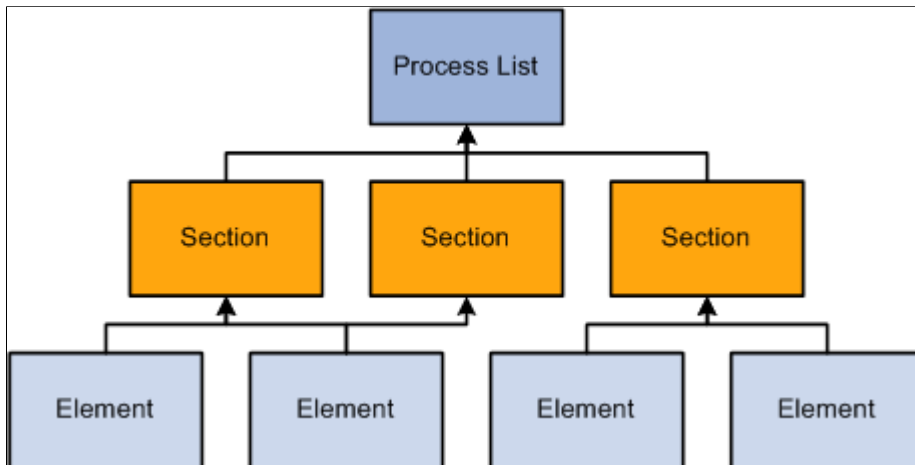

You can create multiple process lists for absence processing. For example, you can create a separate process list for entitlement and take or create one process list that handles both, depending on how you run your processes.

Having created a process list, you attach it to one or more calendars (through a run type). A calendar determines:

- Who's processed.
Specified by the pay group and payee selection criteria on the calendar.
- What's processed.
Specified by the process list associated with the calendar.
- What period of time and frequency apply.
Specified by the period ID linked to the calendar.

When running a process, the system reads the pay period end date for the calendar; finds the appropriate effective-dated process list; and processes the selected payees, one by one.

Related Links

[Understanding Calendars](#)

[Understanding Absence Processing](#)

Process List Name Page

Use the Process List Name page (GP_PIN) to name a process list and define its basic parameters.

Navigation:

Set Up HCM > Product Related > Global Payroll & Absence Mgmt > Framework > Processing > Process Lists > Process List Name

You must enter the basic parameters of the process list on the Process List Name page. All elements within Absence Management share the same name page (GP_PIN).

Note: On the Process List Name page, *Calendar Period End Date* is the only value for the **Definition as of Date** field. When you run the absence process, the system reads the calendar period end date to determine which effective-dated process list and sections to use.

Related Links

[Defining Element Names](#)

Process Lists - Definition Page

Use the Process Lists -Definition page (GP_PROCESS) to identify sections comprising the process list and the order of execution.

Navigation:

Set Up HCM > Product Related > Global Payroll & Absence Mgmt > Framework > Processing > Process Lists > Definition

This example illustrates the fields and controls on the Process Lists -Definition page.

The screenshot displays the 'Definition' page for the process list element 'K0PR ABS'. The page includes the following fields and controls:

- Element Name:** K0PR ABS
- Process:** Process Absence
- Owner:** PS Non-Mnt
- Effective Date:** 01/01/1990
- *Calculation Type:** Absence Calculation
- *Status:** Active
- Gross Pay Element:** (Empty)
- Net Pay Element:** (Empty)
- Minimum Net Entry Type:** (Empty)
- Element Name:** (Empty)

The 'Process List Members' table is as follows:

| *Seq Nbr | Section Element Name | Section Description | Condition Type | Condition Element Name | Condition Description |
|----------|----------------------|---------------------|----------------|------------------------|-----------------------|
| 1 | KOSE INIT | Initial Section | | | |
| 2 | KOSE ABS | Absences | | | |
| 3 | KOWSE ABSENCE | Absences | | | |

| Field or Control | Description |
|-------------------------------|--|
| Calculation Type | The system displays <i>Absence Calculation</i> . You cannot change this value. |
| Gross Pay Element | This field does not apply. It is used with Global Payroll only. |
| Net Pay Element | This field does not apply. It is used with Global Payroll only. |
| Minimum Net Entry Type | This field does not apply. It is used with Global Payroll only. |

| <i>Field or Control</i> | <i>Description</i> |
|--------------------------------|---|
| Minimum Net Element | This field does not apply. It is used with Global Payroll only. |

Process List Members

| <i>Field or Control</i> | <i>Description</i> |
|--------------------------------|--|
| Section Element Name | Select the name of the section that you're adding. You can use a section only once in a process list, but you can add the same section to more than one process list. |
| Condition Type | Select <i>Formula</i> or <i>Variable</i> to specify a condition for resolving the section that you're adding to the process list. |
| Condition Element Name | Required if you selected a condition type. Select the name of the element that defines the condition. If the element resolves to zero, the condition is considered false and the section isn't resolved. If the element resolves to a nonzero value (for example, -2, -1, 1, or 2), the condition is considered true and the system tries resolving the section. |

Related Links

[Ordering Elements and Sections in a Process List](#)

Chapter 11

Defining Absence Elements

Understanding Absence Element Setup

This topic discusses:

- Prerequisites.
- Setup guidelines and dependencies.
- Absence formulas.

Prerequisites

Before you define any absence elements, review the introductory topic that provides an overview of absence features.

Related Links

[Absence Management Features](#)

Setup Guidelines and Dependencies

You define the policies or rules that your organization follows for tracking and compensating payees for absences by creating absence entitlement and take elements. Absence entitlement elements define the conditions under which payees accrue paid time off and the amount of time that they can accrue. Absence take elements specify the rules that the Take process applies to determine whether an absence should be paid.

Consider the following factors before you begin your set up:

- Several absence features require the use of formulas.

At a minimum, you define a day formula for the take definition. If you're creating entitlement elements that resolve per absence, you also define a per absence formula element. You cannot save the entitlement element until you enter the name of the formula on the Absence Entitlements - Calculation page.

- Entitlement and take elements are linked.

When you define a take element, you specify which entitlement rules apply. If you define take elements before defining entitlement elements, return to the take pages in correction mode to select the entitlement elements.

- You assign an absence type to each absence take element.

Absence types provide a way to group or categorize absences. You can assign the same absence type to more than one take element.

- Depending on your take rules, take elements can have several interdependencies.

Mapping out the relationships between these elements can reduce setup time. Take elements are related when:

- You allow payees to use an entitlement that is associated with another take when they exceed the entitlement balance.
- You request the system to create a duplicate event for a second take element.
- You prevent users from entering more than one absence for the same payee for the same day, but you want an error message to give information about the priority of the conflicting events.
- Entitlement, adjustments, balances, and other absence-related values are stated in the same units (hours, days, or some other period of time).

For example, if you express entitlement in days, make sure that any supporting elements that define adjustments, balances, and other absence-related amounts also resolve to days. The units that you use to define absence elements must match the units that the users enter when they adjust or override an entitlement.

- Although you define most absence entitlement and take elements during implementation, you can create additional absence elements anytime.

As your business needs change, we recommend creating new absence elements, rather than modifying existing elements. Changing existing elements can affect retroactive processing.

Absence Formulas

Formulas offer a convenient way to implement various absence management features. You can create different formulas for the features that you use or use the same formula in as many situations as you need to.

This table lists the absence-related formulas that you may need:

| Formula and Page | Use | Element Populated | Value Returned |
|---|---|--------------------------|---|
| Per Absence Formula Element (Absence Entitlements - Calculation page) | Required for <i>per-absence</i> entitlement elements. Defines when to resolve entitlement. Resolved each day if the balance is needed during processing. | | 0 = do not resolve entitlement. Nonzero value = resolve entitlement. |

| Formula and Page | Use | Element Populated | Value Returned |
|---|---|--------------------------|--|
| Day Formula (Absence Take - Day Formula page) | Required for all take elements. Interprets each absent day and returns the units to compare to the entitlement balance. Always resolved per day. | DAY COUNT | Count that represents units for the absent day. |
| Offset Formula (Absence Take - Day Formula page) | Per-absence entitlements only. Automatically reduces beginning entitlement balance. Resolved immediately after a per-absence entitlement is resolved. | | Count that can be added to or subtracted from the entitlement balance. |
| Conditional Formula (Absence Take - Day Formula page) | Defines conditions for generating an absence event for another take element. | | Zero or nonzero value. |
| (Wait) Count Formula (Absence Take - Period page) | Returns the number of remaining days that a payee must be absent before a wait period is satisfied. Often the formula that is used for the Wait Count is the same as the formula that is used for the Day Formula. For example, <i>workday</i> could be counted. | WAIT COUNT | Count |
| Forecast Element (Absence Take - Forecasting page) | Used during the Forecasting process to evaluate an absence. The result of the formula appears on the Absence Event Entry page. Resolved for each day of an absence event. The system saves only the value that is resolved for the last day of the absence. | ABS EVT FCST VAL | Up to 30 alphanumeric characters. |

Many system elements are designed for use within absence formulas and point to columns in the absence daily data table.

For example, assume that you use the system element named SCHED HRS in your Day Formula and that you define the formula, named WRK DAY, as follows:

```
IF SCHED HRS > 0
THEN 1 --> WRK DAY
ELSE 0 --> WRK DAY
END IF
```

The formula checks to see if scheduled hours are greater than zero. If they are, the day equals one workday. If they are not, it is not a workday. As long as there is at least one scheduled hour, the absent day is considered a workday.

The formula processes each row of the daily data for the specified period for the absence take element that is being processed. For each row, the system retrieves the value for SCHED HRS from the daily data table.

Note: Absence system elements in the rows of daily data reflect what the current process row contains. You can use other system elements in your formulas; however, the system resolves them only once—not for each row. For example, if you use a system element from the Job row, such as Department, the value for Department does not change for each row.

Related Links

[Working with System Elements](#)

Defining Absence Types and Reasons

To set up absence types and reasons, use the Absence Take Types (GP_ABS_TYPE) component.

Page Used to Define Absence Types

| <i>Page Name</i> | <i>Definition Name</i> | <i>Usage</i> |
|---|------------------------|--|
| Absence Take Types Page | GP_ABS_TYPE | Define the types of absences that your organization recognizes. You can define reasons in each absence type. |

Understanding Absence Types and Reasons

When you define an absence take element, you assign it an absence type that describes the category of the absence; for example, vacation or sick. You can specify whether an absence type applies to all countries or a specific country. For each absence type, you can define an unlimited number of absence reasons.

When reporting absence events, the system displays the absence type associated with the take that you enter. Entering an absence reason is optional. During the batch and online forecasting processes, the absence type and reason code populate system elements (for example, ABSENCE_TYPE, ABSENCE_TYPE_DB (absence type day before), and ABSENCE_REASON) that you can access within your absence formulas.

Absence Take Types Page

Use the Absence Take Types page (GP_ABS_TYPE) to define the types of absences that your organization recognizes.

You can define reasons in each absence type.

Navigation:

Set Up HCM > Product Related > Global Payroll & Absence Mgmt > Elements > Absence Elements > Absence Take Types

This example illustrates the fields and controls on the Absence Take Types page.

Absence Take Types

Country CYM Cayman Islands

Absence Type VAC

Definition Find | View All First 1 of 1 Last

*Effective Date *Status Active

Description

Short Description Allow Request in Self Service

Absence Reason Personalize | Find | View All First 1 of 1 Last

| *Absence Reason | *Description | Short Description | | |
|----------------------------------|---|---|---|---|
| <input type="text" value="UNP"/> | <input type="text" value="Personal Time Unpaid"/> | <input type="text" value="Time Unpai"/> | + | - |

Cancel Reason Personalize | Find | View All First 1-7 of 7 Last

| Cancel Reason | *Description | Short Description | | |
|----------------------------------|---|----------------------|---|---|
| <input type="text" value="CC"/> | <input type="text" value="Child Care"/> | <input type="text"/> | + | - |
| <input type="text" value="FE"/> | <input type="text" value="Family Emergency"/> | <input type="text"/> | + | - |
| <input type="text" value="JD"/> | <input type="text" value="Jury Duty"/> | <input type="text"/> | + | - |
| <input type="text" value="PEC"/> | <input type="text" value="Previous Engagement Canceled"/> | <input type="text"/> | + | - |
| <input type="text" value="TA"/> | <input type="text" value="Travel Advisory"/> | <input type="text"/> | + | - |
| <input type="text" value="TC"/> | <input type="text" value="Trip Canceled"/> | <input type="text"/> | + | - |
| <input type="text" value="WR"/> | <input type="text" value="Work Related"/> | <input type="text"/> | + | - |

| Field or Control | Description |
|--------------------------------------|--|
| Allow Request in Self Service | Selecting this check box enables you to configure all associated take elements for self service absence functionality. |
| Absence Reason | Enter up to three alphanumeric characters for the Absence Reason code. |

Cancel Reason

Use this grid to enter the reasons users can cancel absences associated with the take type. The values that you enter in the **Description** field appear as values that users can select in the Cancel Reason field on the Cancel Absence self-service pages.

Defining Absence Entitlement Elements

Use the Absence Entitlements component (GP_ABS_ENTL) to create an absence entitlement element for each type of entitlement that your organization offers. For example, if you have separate accrual policies for sick time, vacations, maternity leave, and so on, create a separate entitlement element for each.

Pages Used to Define Entitlement Elements

| Page Name | Definition Name | Usage |
|--|------------------------|--|
| Absence Entitlement Name Page | GP_PIN | Name the element and define basic parameters. |
| Forecasting for Element <name> Page | GP_FORECAST_SEC | Enable forecasting. for an entitlement element. |
| Absence Entitlements - Calculation Page | GP_ABS_ENTL | Define the method of accruing entitlement, the entitlement amount, generation control, and enter instructions for adjusting the entitlement balance under certain conditions. |
| Absence Entitlements - Rounding/ Proration Page | GP_ABS_RND_PRORTN | Define rounding and proration rules for an entitlement element. |
| Absence Entitlements - Auto Generated Accumulators Page | GP_AUTOGEN_ACUM | Define user keys for tracking entitlement balances and specify when the accumulation of entitlement occurs. |
| Absence Entitlements - Accumulator Periods for Element <Name> Page | GP_AUTOGEN_SEC | Define the start date and length of the entitlement accumulation period (for example, month-to-date or year-to-date) and select auto-generated accumulators to track entitlement, adjustments, and paid units. |
| Absence Entitlements - Generated Elements for Element <Name> Page | GP_ABS_ACM_SEC | View the list of auto-generated accumulators for the entitlement element after saving the element's definition. |
| Absence Entitlements - Supporting Element Overrides Page | GP_ELM_DFN_SOVR | Override the value of a supporting element that is used in the definition of the entitlement element. |

Understanding Auto Generated Accumulators

When you define and save a new entitlement element, the system generates an accumulator to track the entitlement balance.

After you save the element, you can go to the accumulator definition and enter additional instructions for the balance accumulator:

- For frequency-based entitlements, you can specify an Initialize Rule if you want the system to carry forward all or part of the balance at the end of the accumulation period. If you do not select an Initialize Rule, the system sets the remaining balance to 0 at the beginning of the new accumulation period.
- For absence-based and frequency-based entitlements, you can configure the way the entitlement balance is updated by adding or removing elements that contribute to or deduct from the balance. The system uses the following formula to calculate the entitlement balance:

$$\text{Entitlement balance} = \text{Entitlement} - \text{Units Paid} + \text{Units Adjusted}$$

Units Paid and Units Adjusted are assigned elements that the system creates when it generates the accumulator for the entitlement balance.

Example

If you create an entitlement element called VACATION, the system automatically creates a balance accumulator for the entitlement. This table lists the elements defined on the Members page for the accumulator (suffix names may differ by country) and explains when the elements are resolved:

| <i>Element Name</i> | <i>Element Type</i> | <i>Accumulator Sign</i> | <i>When Resolved</i> |
|--------------------------------|---------------------|-----------------------------------|---|
| VACATION (entitlement) | Absence Entitlement | Add | When entitlement is resolved. |
| VACATION_TAKE (units paid) | Auto-assign | Subtract | During the Take process the paid units are assigned to this element each day. |
| VACATION_ADJU (units adjusted) | Auto-assign | Add (positive or negative number) | When entitlement adjustment is resolved. |

Absence Entitlement Name Page

Use the Absence Entitlement Name page (GP_PIN) to name the element and define basic parameters.

Navigation:

Set Up HCM > Product Related > Global Payroll & Absence Mgmt > Elements > Absence Elements > Absence Entitlements > Absence Entitlement Name

You must name every element and define its basic parameters on an Element Name page. All element components in Absence Management share the same Element Name page (GP_PIN).

Enabling Forecasting

If the entitlement element that you're defining will be linked to a take element for which absence forecasting is allowed, click the Forecasting link at the bottom of the Absence Entitlement Name page to access the Forecasting page. Select the **Forecasting Used** check box.

To avoid degrading system performance, select the feature only for those takes and entitlements that you're interested in forecasting.

Related Links

[Defining Element Names](#)

[Absence Entry, Approval, and Self Service Features](#)

Absence Entitlements - Calculation Page

Use the Absence Entitlements - Calculation page (GP_ABS_ENTL) to define the method of accruing entitlement, the entitlement amount, generation control, and enter instructions for adjusting the entitlement balance under certain conditions.

Navigation:

Set Up HCM > Product Related > Global Payroll & Absence Mgmt > Elements > Absence Elements > Absence Entitlements > Calculation

This example illustrates the fields and controls on the Absence Entitlements - Calculation page.

The screenshot displays the 'Calculation' tab of the 'Absence Entitlement Name' page for the element 'K0WAE SICK'. The page is organized into several sections:

- Definition:** Contains fields for *Effective Date (01/01/1990), *Status (Active), *Entitlement Type (Formula), and Entitlement Element (K0WFM SICK ENTITL).
- Specify Frequency:** Includes radio buttons for 'Calculate When Absence Occurs', 'Calculate Per Pay Period', and 'Calculate Per Other Frequency' (which is selected). Below this, there is a *Frequency ID (M) and an Entitlement Generation Control Element field.
- Adjustment and Payoff:** Features dropdown menus for 'Adjustment Type' and 'Payoff Type'.

At the bottom of the page, the version is listed as 'Version P_8.90.00.00'.

| Field or Control | Description |
|----------------------------|---|
| Entitlement Type | Select the type of element to use to resolve the entitlement amount. Values are <i>Accumulator</i> , <i>Bracket</i> , <i>Formula</i> , <i>Numeric</i> , <i>Payee Level</i> , <i>System Element</i> , <i>Variable</i> . If you select <i>Payee Level</i> , the entitlement element is resolved only if the element is assigned to the payee on the Entitlement/ Take Assignment page. |
| Entitlement Element | If you selected a value other than <i>Numeric</i> in the Entitlement Type field, select the name of the element that calculates entitlement. |
| Entitlement Unit | If you selected <i>Numeric</i> in the Entitlement Type field, type the number of units in this field. |

Specify Frequency

The fields that appear in this group box vary according to the frequency option that you select.

| Field or Control | Description |
|--------------------------------------|---|
| Calculate When Absence Occurs | Select to grant entitlement only when an absence occurs; for example, you want payees to accrue 42 days of entitlement for each illness. Clear to grant entitlement at a regular frequency such as monthly or annually. |
| Calculate Per Pay Period | Select if the entitlement is frequency-based, and you want entitlement to accrue each pay period. |

| Field or Control | Description |
|--|--|
| <p>Calculate Per Other Frequency and Frequency ID</p> | <p>Select if the entitlement is frequency-based and is to accrue at the frequency that you specify in the Frequency ID field. Frequencies include, but are not limited to <i>Annual, Daily, Weekly, Monthly, Quarterly,</i> and <i>Semimonthly</i>.</p> <hr/> <p>Note: Frequency values are defined in PeopleSoft HR.</p> <hr/> <p>The system uses the frequency to determine the entitlement amount to accrue each pay period. For example, if payees accrue one day of entitlement at a <i>Monthly</i> frequency, the system annualizes (calculates the annual entitlement) by multiplying 1 (day) by 12 (months). It uses the calendar period for the absence run to deannualize the amount. So, if payees' absences are run weekly, the system calculates the amount to accrue during each absence run by dividing 12 by 52. Therefore, payees accrue 12/52, or .23 days of sick time each pay period.</p> <p>To deannualize entitlement using a frequency other than the pay period, select a generation control frequency in the Entitlement Generation Control Element field.</p> |
| <p>Per Absence Formula Element</p> | <p>This field appears only if you selected Calculate When Absence Occurs. Select a formula element. When you run the Take process, the system resolves the day formula (defined for the take element on the Absence Take - Day Formula page) and evaluates the day to determine whether the entitlement balance is needed. If it is, the system resolves the per absence formula element.</p> <p>If the condition is met (the formula returns a non zero value), the Take process resolves the entitlement. If the condition is not met, the existing entitlement balance is used.</p> <p>When a take element linked to this entitlement has a minimum pay period, eligibility period, or wait period, the per absence formula is executed only after these periods have been met.</p> |

| Field or Control | Description |
|---|--|
| Entitlement Generation Control Element | <p>Select a generation control element to limit the conditions under which the entitlement element is resolved. This field appears when you select Calculate Per Pay Period or Calculate Per Other Frequency.</p> <p>For example, use generation control to restrict resolution of the element to active payees. If you are defining a frequency-based entitlement and you selected Calculate Per Other Frequency, you can select a generation control frequency element. The system uses the frequency that is defined by the generation control element, rather than the frequency of the pay calendar, to deannualize the entitlement amount and to determine when to resolve the entitlement.</p> |

Adjustment and Payoff

For frequency-based entitlements, you can instruct the system to reduce or pay off all or a portion of a payee's entitlement balance when a certain event occurs. Use generation control to define when you want the adjustment to occur.

| Field or Control | Description |
|--|---|
| Adjustment Type | <p>Select the type of supporting element that returns the number of units that you want added to or deducted from the entitlement balance. The system <i>adds</i> the returned amount to the entitlement balance; to reduce the balance, be sure that the element returns a negative number. Select from these element types: <i>Accumulatr</i>, <i>Bracket</i>, <i>Formula</i>, <i>SystemElem</i>, or <i>Variable</i>.</p> |
| Adjustment Element | <p>Select the name of the supporting element that is to return the adjustment units.</p> <p>For example, let's say that payees can carry up to three months of unused vacation into the new year, at which time any unused entitlement is lost. On March 31, a payee has three unused vacation days carried over from the previous period. The element that you select in this field returns a value of -3.</p> |
| Adjustment Generation Control Element | <p>This field is required if you completed the Adjustment Type field. Select the generation control element that identifies when the adjustment is to occur.</p> |

| Field or Control | Description |
|-------------------------|---|
| Payoff Type | Use to compensate payees for all or some of the units that they will lose. Select the supporting element that returns the number of units that are to be paid off. Values are <i>Accumulatr</i> , <i>Bracket</i> , <i>Formula</i> , <i>SystemElem</i> , and <i>Variable</i> . |
| Payoff Element | Select the name of the supporting element that is to return the units to be paid off. |
| Payoff Earning | If you completed the Payoff Element field, select the earning element with which the payoff units are associated. When you run the Take process, the system generates positive input for the target calendar that is specified on the current calendar. |

Entitlement Carryover

When the system creates a new accumulator at the start of a new accumulation period, it assigns the value of the old accumulator to the system element named PREV VALUE ACCM. If you want entitlement balances to carry forward to the new accumulation period, you can create an initialization formula (on the Accumulator - Period page) that retrieves the old value from PREV VALUE ACCM and assigns its value to the formula. Add the formula element to the element member list for the accumulator (by selecting *Add* for the Accumulator Sign) via the Members page. When you do this, the value of PREV VALUE ACCM will be assigned to the formula, which will then be added to the balance accumulator. You can add the entire previous balance to the new accumulator, or whatever portion you want.

Related Links

[Defining Generation Control Frequency](#)

[Defining Generation Control Elements](#)

[Accumulators - Definition Page](#)

Absence Entitlements - Rounding/Proration Page

Use the Absence Entitlements - Rounding/Proration page (GP_ABS_RND_PRORTN) to define rounding and proration rules for an entitlement element.

Navigation:

Set Up HCM > Product Related > Global Payroll & Absence Mgmt > Elements > Absence Elements > Absence Entitlements > Rounding/Proration

This example illustrates the fields and controls on the Absence Entitlements – Rounding/Proration page.

You can have the system round entitlement units or prorate those units when there is period segmentation. Proration applies to frequency-based entitlement only. If you select both a rounding rule and a proration rule, the system prorates and then rounds the entitlement units. Adjustment and payoff units are never rounded or prorated.

| Field or Control | Description |
|---|--|
| Rounding Rule Option and Rounding Rule Element | <p>To have the system round the entitlement units, specify where you defined the rounding rule by selecting one of the following values in the Rounding Option field.</p> <p><i>Use Pay Group Rounding:</i> The system applies the rounding rule that is defined for the payee's pay group.</p> <p><i>Use Specified Rounding:</i> The system applies the rounding rule that you select in the Rounding Rule Element field.</p> |
| Proration Option and Proration Element | <p>These fields applies to frequency-based entitlements only. To prorate entitlement units when the pay period is segmented, specify where the proration rule is defined by selecting a value in the first field:</p> <p><i>Use Pay Group Proration Rule:</i> The system applies the proration rule that is defined for the payee's pay group.</p> <p><i>Use Specified Proration Rule:</i> The system applies the proration rule that you select in the Proration Rule field.</p> |

Note: You can use the PRORATE system element to invoke proration for an entitlement element, even when there's no segmentation. You set the value of PRORATE to Y or N (yes or no) to activate and deactivate proration. For example, you might create a formula that sets PRORATE to Y, prior to processing the entitlement element. After the entitlement element, you reset the system element PRORATE to N.

Related Links

[Defining Rounding Rule Elements](#)

[Defining Proration Rules](#)

Absence Entitlements - Auto Generated Accumulators Page

Use the Absence Entitlements - Auto Generated Accumulators page (GP_AUTOGEN_ACUM) to define user keys for tracking entitlement balances and specify when the accumulation of entitlement occurs.

Navigation:

Set Up HCM > Product Related > Global Payroll & Absence Mgmt > Elements > Absence Elements > Absence Entitlements > Auto Generated Accumulators

This example illustrates the fields and controls on the Absence Entitlements - Auto Generated Accumulators page.

| Absence Entitlement Name | Calculation | Rounding/Proration | Auto Generated Accumulators | Supporting Element Overrides |
|--|---------------------|-------------------------|------------------------------------|------------------------------|
| Element Name | K0WAE SICK | Sick | Owner | PS Non-Mnt |
| Level | | | | |
| <input type="radio"/> Payee (EMPLID) <input checked="" type="radio"/> Job (EMPLID/EMPL_RCD) | | | | |
| User Key Type 1 | SystemElem | | Key Element 1 | COMPANY |
| User Key Type 2 | SystemElem | | Key Element 2 | PAY ENTITY |
| User Key Type 3 | SystemElem | | Key Element 3 | GP PAYGROUP |
| User Key Type 4 | | | Key Element 4 | |
| User Key Type 5 | | | Key Element 5 | |
| User Key Type 6 | | | Key Element 6 | |
| Accumulate Based On | | | | |
| *Based On Period End Date | | | | |
| Resolution Timing | | | | |
| Entitlement Accumulators are always updated when the contributing Entitlement is resolved. | | | | |
| Retroactive Behavior | | | | |
| Absence accumulators always use the Corrective retroactive method. | | | | |
| Go to | Accumulator Periods | View Generated Elements | | |

The fields on this page are the same as the fields on the Accumulators - Level page and Accumulators - Definition page in the Accumulators component. Only the settings that are specific to absence entitlement elements are described below.

Level

| Field or Control | Description |
|---|---|
| <p>User Key Type 1...6 and Key Element 1...6</p> | <p>To have linked take elements share a per-absence entitlement balance when a user enters absence events with the same original begin date, you can select user keys to set up these instructions.</p> <p>Select <i>SystemElem</i> for one of the user keys, and select <i>ORIG BEGIN DATE</i> (original begin date) in the corresponding Key Element field. On the Accumulator Periods for Element <name> page, select <i>Custom Period</i> in the Period field. In the Date field, select <i>System Element - Date</i> and select <i>ORIG BEGIN DATE</i> in the Begin Date Element field.</p> <p>Now, when you enter two absence events for the same take element and both events have the same original begin date, the second event uses the entitlement balance of the first event.</p> |

Resolution Timing

Accumulator timing identifies when the entitlement balance accumulator is resolved. As the online message indicates, as each element contributing to the accumulator is resolved, the accumulator itself is also updated. The accumulator does not need to appear on the absence process list to be updated.

Retroactive Behavior

Retroactive behavior identifies how the accumulator is updated during retroactive processing. Absence accumulators always use the corrective retroactive method. The accumulator is updated with the newly calculated values of the member elements at the end of a retro recalculation.

Related Links

[Accumulators - Level Page](#)

Absence Entitlements - Accumulator Periods for Element <Name> Page

Use the Absence Entitlements - Accumulator Periods for Element <name> page (GP_AUTOGEN_SEC) to define the start date and length of the entitlement accumulation period (for example, month-to-date or year-to-date) and select auto-generated accumulators to track entitlement, adjustments, and paid units.

Navigation:

Click the **Accumulator Periods** link on the Absence Entitlements - Auto Generated Accumulators page.

This example illustrates the fields and controls on the Absence Entitlements - Accumulator Periods for Element <name> page.

Absence Ent. Acum AutoGen2

Absence Entitlements

Accumulator Periods for Element K0WAE SICK (Sick)

Accumulator Period

*Period Year to Date ▼

*Begin Option Specify Date ▼

*Begin Month Option Month ▼

*Begin Month Value 01 January

*Begin Day Option Number ▼

*Begin Day Value 1

Auto Generated Accumulators

Balance Use these indicators to automatically generate balances for the Absence Entitlement element you are defining.

Entitlement

Adjustment It is strongly recommended that these accumulators are kept to a minimum for performance and data volume considerations.

Paid Units

Accumulator Periods

| <i>Field or Control</i> | <i>Description</i> |
|--------------------------------|---|
| Period | <p>Select the period of time you want the accumulators to track. Depending on the option that you select, other fields may appear. Options are:</p> <p><i>Calendar Period</i></p> <p><i>Custom Period:</i> If you select this option, complete the Date fields.</p> <p><i>Month to Date:</i> If you select this option, complete the Begin Option and Begin Day fields.</p> <p><i>Quarter to Date:</i> If you select this option, complete the Begin Option, Begin Month, and Begin Day fields.</p> <p><i>Segment</i></p> <p><i>Year to Date:</i> If you select this option, complete the Begin Option, Begin Month, and Begin Day fields.</p> |

| Field or Control | Description |
|----------------------------------|--|
| Date and Begin Date Value | <p>If you selected <i>Custom</i> in the Period field, select the type of supporting element that defines the start date of the accumulation period. Options are: <i>Bracket - Date</i>, <i>Calendar Date</i>, <i>Date</i>, <i>Formula - Date</i>, <i>System Element - Date</i>, and <i>Variable - Date</i>.</p> <p>(<i>Calendar Date</i> enables you to choose a specific date; <i>Date</i> enables you to use a <i>Date</i> element.)</p> <p>In the Begin Date Value field, select the name of the element that defines the date. Or, if you selected <i>Cal Date</i> in the first field, select a date in this field.</p> |
| Begin Option | <p>If you selected <i>Quarter to Date</i> or <i>Year to Date</i> in the Period field, select the type of supporting element that defines the start date of the accumulation period. Options are:</p> <p><i>Specify Date</i>: The accumulation period will begin on the date you specify by completing the Begin Month and Begin Day fields.</p> <p><i>Use Pay Entity Calendar</i>: The accumulation period begins on the same day as the calendar that is defined for the pay entity.</p> <p><i>Use Pay Entity Fiscal</i>: The accumulation period begins on the same day as the fiscal calendar that is defined for the pay entity.</p> <p>You define the pay entity calendar and fiscal calendar on the Pay Entity - Processing Details page.</p> |
| Begin Month Option | <p>This field appears only if you select <i>Quarter To Date</i> or <i>Year To Date</i>. Select the month in which you want the accumulation period to begin.</p> |
| Begin Day Option | <p>This field appears only if you select <i>Month To Date</i>, <i>Quarter To Date</i>, or <i>Year To Date</i>. Select the day of the month on which you want the accumulation period to begin.</p> |

Warning! If you change the **Begin Month** or **Begin Day** field after you run the Entitlement or Take process, accumulator results may be inaccurate.

Auto Generated Accumulators

When the system generates the accumulators, it automatically adds a suffix to each accumulator's name to identify what the accumulator represents: the balance, entitlement, adjustment, or paid units. For

example, an entitlement element named Vacation might have accumulators named VACATION_BAL, VACATION_TAKE, and so forth.

| Field or Control | Description |
|-------------------------|---|
| Balance | Selected by default to remind you that the system always creates a balance accumulator to track the unused entitlement units that a payee has accrued. When it creates the balance accumulator, the system also generates two system-assigned elements that contribute to the entitlement balance accumulator: Units Adjusted and Units Paid. |
| Entitlement | Select to create a separate accumulator that tracks the total number of entitlement units that the payee has accrued during the accumulation period, including those that have been used. |
| Adjustment | Select to create a separate accumulator for the automatically assigned Units Adjusted element. The accumulator tracks the adjustments that have been made, including manual and automatic adjustments. |
| Paid Units | Select to create a separate accumulator for the automatically assigned Units Paid element. The accumulator tracks the total number of entitlement units the payee has used during the accumulation period. |

Absence Entitlements - Generated Elements for Element <Name> Page

Use the Absence Entitlements - Generated Elements for Element <name> page (GP_ABS_ACM_SEC) to view the list of auto-generated accumulators for the entitlement element after saving the element's definition.

Navigation:

Click the **View Generated Elements** link on the Absence Entitlements - Auto Generated Accumulators page.

This example illustrates the fields and controls on the Absence Entitlements - Generated Elements for Element <name> page.

| | |
|--|-----------------|
| Auto Generated Elements | |
| Absence Entitlements | |
| Generated Elements for Element K0WAE SICK (Sick) | |
| Components | |
| Adjustment Element | K0WAE SICK_UNAD |
| Units Paid Element | K0WAE SICK_UNP |
| Auto Generated Accumulators Personalize | |
| Accumulator Type | Name |
| Calendar YTD Units | K0WAE SICK_BAL |
| Calendar YTD Units | K0WAE SICK_ENT |
| Calendar YTD Units | K0WAE SICK_ADJU |
| Calendar YTD Units | K0WAE SICK_TAKE |

You can see the list of automatically generated accumulators after you save the entitlement element's definition.

Absence Entitlements - Supporting Element Overrides Page

Use the Absence Entitlements - Supporting Element Overrides page (GP_ELM_DFN_SOVR) to override the value of a supporting element that is used in the definition of the entitlement element.

Navigation:

Set Up HCM > Product Related > Global Payroll & Absence Mgmt > Elements > Absence Elements > Absence Entitlements > Supporting Element Overrides

Defining Absence Take Elements

Use the Absence Take (GP_ABS_TAKE) component to create an absence take element for each type of absence that your organization recognizes. For example, if you have separate rules for compensating sick time, vacation time, leaves of absence, and so on, create a separate take element for each.

Pages Used to Define Absence Take Elements

| Page Name | Definition Name | Usage |
|--|------------------------|--|
| <u>Absence Take Name Page</u> | GP_PIN | Name the element and define basic parameters. |
| Forecasting for Element <name> | GP_FORECAST_SEC | Enable forecasting rules to be entered on the Absence Take - Forecasting page. |
| <u>Absence Takes - Calculation Page</u> | GP_ABS_TAKE | Define general calculation rules for take elements, select the absence type, link entitlement elements, and specify whether absence events require online approval. Also contains user-defined fields. |
| <u>Absence Takes - Day Formula Page</u> | GP_ABS_TAKE2 | Specify the day formula for calculating the day count; linked earning and deduction elements; conditions for reducing the beginning entitlement balance; and mapped take elements. |
| <u>Absence Takes - Period Page</u> | GP_ABS_TAKE3 | Define eligibility, minimum absence, or wait per absence requirements. Link related absences. |
| <u>Absence Takes - Negative Balances Page</u> | GP_ABS_TAKE4 | Define negative balance rules (what happens when the entitlement balance is not sufficient to cover an absence). |
| <u>Absence Takes - Priority Page</u> | GP_ABS_TAKE5 | Specify if users can enter more than one absence for a payee for the same day and to assign a priority to absence takes if only one type of absence is allowed each day. |
| <u>Absence Takes - Forecasting Page</u> | GP_ABS_TAKE6 | Specify the formula to use for absence forecasting and the list of elements that are displayed by the Absence Forecasting process. |
| <u>Absence Takes - Balance Inquiry Page</u> | GP_ABS_TAKE7 | List the elements that are displayed by the Balance Inquiry process. |
| <u>Absence Takes - User Defined Result Fields Page</u> | GP_ABS_TAKE8 | Select the user-defined fields that can be overwritten by a system element during processing. |

| Page Name | Definition Name | Usage |
|--|------------------------|---|
| Absence Takes - Supporting Element Override Page | GP_ELM_DFN_SOVR | Override the value of a bracket, date, duration, formula, or variable element that is used in the definition of the take element. |

Understanding Absence Take Elements

This topic discusses:

- Mapping.
- Eligibility, minimum absence, and wait period criteria.
- Linked absence takes.
- System elements for overwriting daily data from user-defined fields.

Mapping

You can instruct the system to generate a matching absence for another take element (such as TAKE2) when a user enters an absence for this take (for example, TAKE1). When you run the Take process, the system creates additional days in the daily absence results for TAKE2, using the same data that you entered for TAKE1, but applying the take rules that you defined for TAKE2. This feature enables you to evaluate a single absence event using more than one set of entitlement and take rules.

For example, your organization offers a supplemental sick plan in addition to the statutory sick plan. For payees to receive benefits from both plans when you enter sick time, you map the take element for your statutory plan (let's call it SICK) to the take element for the supplemental plan (let's call it SUPP SICK). Now, when a user enters an absence event for SICK, the system creates additional absence days for SUPP SICK. When the Take processing is complete, you can see these additional days in the daily absence results (GP_RSLT_ABS), but not in the absence event record (GP_ABS_EVENT). Define a linked absence take on the Absence Take - Day Formula page.

Eligibility, Minimum Absence, and Wait Period Criteria

When you define an absence take element, you can select up to three time periods that must be met before an absence can qualify for payment:

- Minimum absence

Define the number of calendar days that an absence must last before it can be paid. If the minimum is not satisfied, the entire absence is unpaid.

- Eligibility period

Specify the date that must be reached before an absence can be paid.

- Wait per absence

Define a minimum waiting period per absence. An absence qualifies for payment only after the wait period has been satisfied. Only the days that exceed the wait period qualify. If you link related

absences, you can specify that one wait period applies to all linked events or that a separate wait period applies to each event.

When you run the Take process, the system resolves the day formula, evaluates the day, and checks to see whether the period requirements have been met, in the order listed above. If the minimum pay period is not met, no further processing is done for that day, and the day count that is returned by the day formula is considered unpaid. If the minimum period is met, the system checks to see whether the eligibility period is met, and then the wait period. Define the criteria for eligibility, minimum absence, and wait periods on the Absence Take — Period page.

See [Absence Takes - Period Page](#).

Linked Absences Takes

You can instruct the system to link related absences that fall in a defined period of time. When occurrences of the same absence are linked, they can share the same per-absence entitlement or the same wait period. Define the criteria for linked absences on the Absence Take - Period page.

When you run the Take process, the system determines whether the new absence falls within the valid linking period. If it does, the system sets the system element named LINK YES-NO, which is associated with the new event, to YES. The per absence formula element (selected on the Absence Entitlements - Calculation page) refers to the value of the LINK YES-NO element to determine whether to resolve entitlement or to use the existing entitlement balance.

The system always compares the start date of the current event to the last matching absence event to determine whether the event falls within the linking period. You define what qualifies as the last matching event. If you specify that the Original Begin Date field on the Absence Event Entry page is used to identify linked absence, absence entries with the same absence type and original begin date are treated as one absence period.

For example, if a payee is out from January 23 to January 25 because of a broken leg and is out again from February 7 to February 8 for the same reason, this table shows how the absence is entered for the person on the Absence Event Entry page:

| Absence Type | Reason (not entered online) | Begin Date | End Date | Original Begin Date |
|---------------------|------------------------------------|-------------------|-----------------|----------------------------|
| Sick | Broken leg | January 23 | January 25 | January 23 |
| Sick | Broken leg complications | February 7 | February 8 | January 23 |

This diagram gives examples of how linking works.

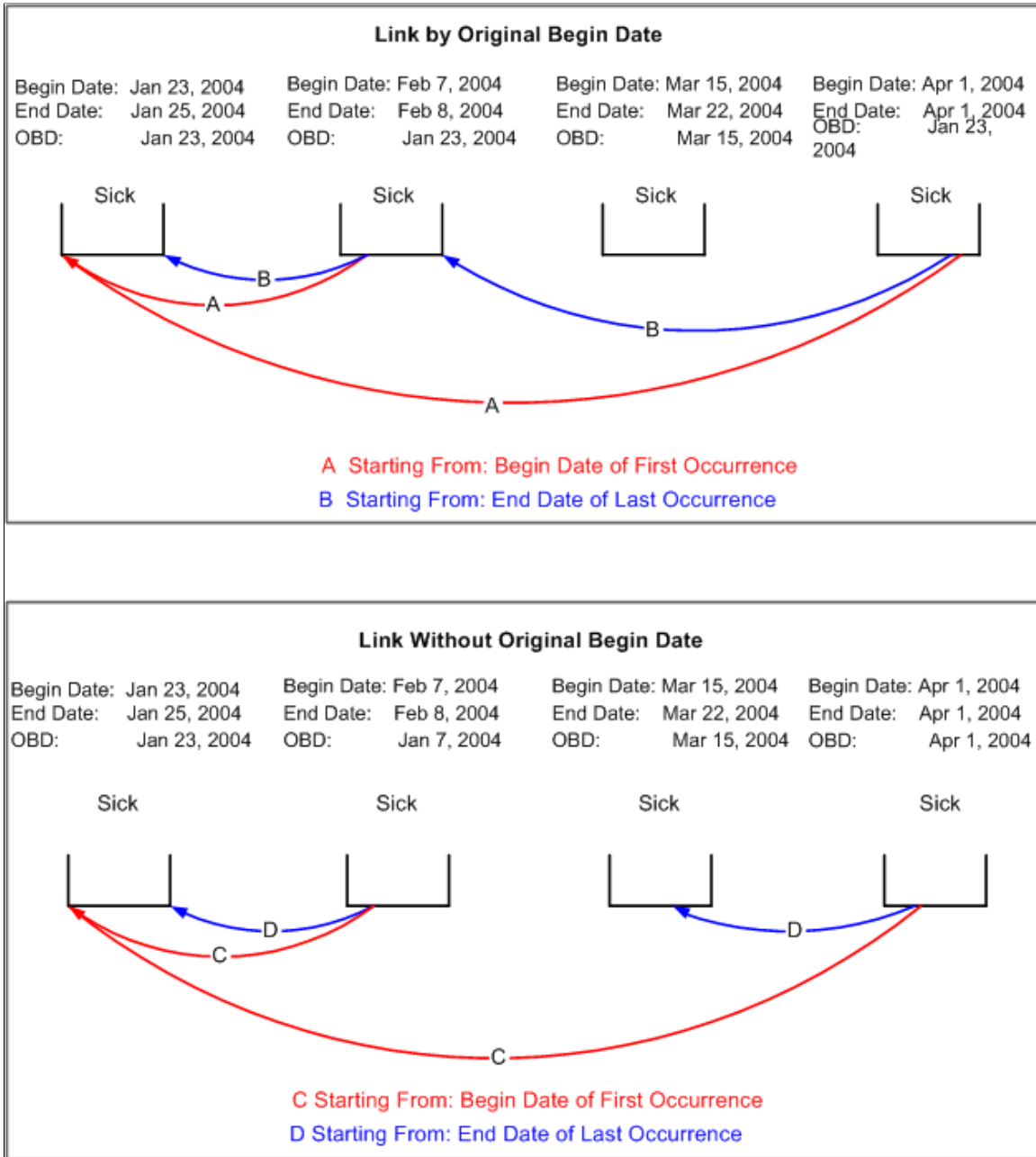

System Elements for Overwriting Daily Data from User Defined Fields

You can use up to 16 system elements to overwrite absence data that's entered into the user-defined fields (labeled Date 1, Date 2, Decimal 1, Decimal 2, and so on) on the Absence Event Input Detail page. When you run the Take process, the system writes the values that are assigned to the system elements to the daily data in the Absence Results (GP_RSLT_ABS) table in place of the user-entered values. You can use system elements to overwrite data for every day of an absence event or for selected days.

The following table lists the system elements, the corresponding fields that they overwrite in the Absence Results table, and the labels for the user-defined fields on the Absence Event Input Detail page:

| System Element | Field Overwritten in Absence Results Table | Field Labels on Absence Event Input Detail Page |
|-----------------------|---|--|
| EVT CONFIGx DT UPD | EVT CONFIGx DT | Date 1, 2, 3, 4 |
| EVT CONFIGx DC UPD | EVT CONFIGx DC | Decimal 1, 2, 3, 4 |
| EVT CONFIGx CH UPD | EVT CONFIGx CH | Character 1, 2, 3, 4 |
| EVT CONFIGx MN UPD | EVT CONFIGx MN | Monetary 1, 2, 3, 4 |

where x = 1, 2, 3, or 4

For example, say that a user enters a value of 100 USD in the Monetary 1 field (EVT CONFIG1 DC) on the Absence Event Input Detail page. Using the EVT CONFIG1 DC UPD system element, you can have the system write 150 USD to the result table for the first day of the absence event, and use the value entered by the user for the remaining days of the event

To use the system elements:

- Specify which user-defined fields can be overwritten.
Select these fields on the Absence Take - User Defined Result Fields page.
- Use a formula or rule to define the conditions for assigning a value to the system elements.

Related Links

[Absence Takes - Period Page](#)

[Absence Takes - User Defined Result Fields Page](#)

Absence Take Name Page

Use the Absence Take Name page (GP_PIN) to name the element and define basic parameters.

Navigation:

Set Up HCM > Product Related > Global Payroll & Absence Mgmt > Elements > Absence Elements > Absence Takes > Absence Take Name

This example illustrates the fields and controls on the Absence Take Name page.

The screenshot displays the 'Absence Take Name' page with the following details:

- Name:** KOATSICK
- Description:** Long Term Sickness
- Definition As Of Date:** Calendar Period End Date
- Element Type:** Absence Take
- Field Format Short Name:** (Invalid Value)
- Element Nbr:** 2224
- Always Recalculate:**
- Element Use:**
 - Owner:** PS Delivered / Not Maintained
 - Class:** Sample Data
 - Used By:** All Countries
 - Country:** ALL
 - Industry/Region:** (empty)
 - Category:** (empty)
- Override Levels:**
 - Pay Entity
 - Pay Group
 - Payee
 - Calendar
 - Via Elements
 - Element Definition
 - Positive Input
- Results:**
 - Store
 - Store if Zero
- Resolution Parameters:** This element type does not require additional resolution parameters.
- Version Information:**
 - Last Updated:** 08/29/06 3:11:08.000000PM
 - Last Updated By:** PPLSOFT
 - User Version:** (empty)
 - Version:** P_9.00.00

You must name every element and define its basic parameters on an Element Name page. All element components in Absence Management share the same first Element Name page (GP_PIN).

Enabling Configuration of Forecasting

Before you can define forecasting rules for a take element on the Absence Take - Forecasting page, you need to enable the take element for forecasting. To do this, click the Forecasting link at the bottom of the Absence Take Name page to access the Forecasting page. Select the **Forecasting Used** check box. Select the **Forecasting Required** check box if users are required to run the forecasting process before entering an absence through the Absence Event Entry page.

To avoid degrading system performance, enable the forecasting feature only for those takes that you're interested in forecasting.

Related Links

[Defining Element Names](#)

[Absence Entry, Approval, and Self Service Features](#)

Absence Takes - Calculation Page

Use the Absence Takes - Calculation page (GP_ABS_TAKE) to define general calculation rules for take elements, select the absence type, link entitlement elements, and specify whether absence events require online approval.

Also contains user-defined fields.

Navigation:

Set Up HCM > Product Related > Global Payroll & Absence Mgmt > Elements > Absence Elements > Absence Takes > Calculation

This example illustrates the fields and controls on the Absence Takes - Calculation page.

| Field or Control | Description |
|----------------------------------|--|
| Absence Type | Select the absence type. You define absence types on the Absence Types page. |
| Manager Approval Required | Select if a manager must approve every absence that is associated with this take. When a user enters an absence, someone must select the Manager Approved check box on the Absence Event Input Detail page, or the event will not be processed when you run the Take process. The system does not verify that the user who selects the check box is a manager. Note: This field does not apply to absence requests entered through the self service pages. Fields on the self service setup pages control the approval requirements for these requests. |

| Field or Control | Description |
|---------------------------|---|
| Multiple Instances | <p>Select to have the system create a separate bundle for the instances of positive input that are generated for the earning or deduction elements (associated with this take element).</p> <p>For example, say that a payee is sick on two separate occasions during the January processing period:</p> <ul style="list-style-type: none"> • Event 1: January 1-2. • Event 2: January 20-22 . <p>If Multiple Instances is selected, the system creates one row of positive input for Event 1 and one row of positive input for Event 2, enabling you to report the two events separately.</p> <p>Both Absence Begin Date and Absence Period Begin Date are populated when you select this check box, so select it if these dates are significant to your earning and deduction processing rules.</p> <p>If this check box is cleared, the system bundles the positive input that is generated for all absence events that occur for this take during the same period. A single row of positive input will represent the consolidated absence events.</p> |

Entitlement Member List

Use these fields to link the take element to one or more entitlement elements. When you run the Take process, the system reduces entitlement balances in the order that you specify. For example, if you link vacation take to entitlement for floating holidays and then to vacation entitlement, the system uses the floating holiday entitlement until it's depleted and then reduces vacation entitlement.

All entitlement elements that you add to the Entitlement Member List must be of the same type: per-absence entitlement or frequency-based entitlement. The first element that you add to the list limits the choice of entitlement elements that you can add in subsequent rows.

| Field or Control | Description |
|----------------------------|---|
| Priority | Enter up to three digits to identify the relative order in which the absence take should be applied to the entitlement element. |
| Entitlement Element | <p>Select the entitlement element that you want to link to the take element.</p> <p>If you've already added a row for an entitlement element, you can select only absence-based or frequency-based entitlement elements, depending on the Specify Frequency option selected on the Calculation page.</p> |

| Field or Control | Description |
|-------------------------|--|
| Per Absence | If the entitlement is absence-based (the Calculate When Absence Occurs option is selected on the Calculation page), the system selects this check box. The value that you select for the first row determines the type of entitlement elements that you can select in additional rows. |

User Defined Fields

The system provides four user defined fields that you can use to add any information you want to the take definition. When you run the Take process, the data that you enter populates the TAKE CONFIG1 through TAKE CONFIG4 system elements.

| Field or Control | Description |
|---|---|
| Field 1: through Field 4: | Enter up to 10 alphanumeric characters in each field. |

Absence Takes - Day Formula Page

Use the Absence Takes - Day Formula page (GP_ABS_TAKE2) to specify the day formula for calculating the day count; linked earning and deduction elements; conditions for reducing the beginning entitlement balance; and mapped take elements.

Navigation:

Set Up HCM > Product Related > Global Payroll & Absence Mgmt > Elements > Absence Elements > Absence Takes > Day Formula

This example illustrates the fields and controls on the Absence Takes - Day Formula page.

The screenshot displays the 'Absence Takes - Day Formula' configuration page for element K0ATSICK (Long Term Sickness). The page is divided into several sections:

- Header:** Shows the element name 'K0ATSICK', description 'Long Term Sickness', and owner 'PS Non-Mnt'.
- Definition:** Includes the effective date '01/01/1990' and status 'Active'. It features a 'Beginning Balance Offset' section with the following fields:
 - Offset Formula Element: K0FM SICK TAKE
 - *From Type: Date
 - *To Type: Date
 - Date From: K0DT OFFSET START
 - Date To: K0DT OFFSET END
- Additional Fields:** Includes 'Mapped To Element' and 'Day Formula Element' (K0FM C SICK).
- Generate Positive Input Member List:** A table with columns for Order, Element Type, Element, Unit Element Type, and Unit Element.

| *Order | *Element Type | Element | *Unit Element Type | Unit Element |
|--------|---------------|---------|--------------------|--------------|
| 1 | Earnings | K0WRKAC | SystemElem | DAY COUNT |
| 2 | Earnings | K0SICK1 | SystemElem | DAY COUNT PD |

Beginning Balance Offset

If the take element is linked to a per-absence entitlement, select a formula that defines the conditions under which the beginning entitlement balance is reduced. The system executes the beginning balance offset formula only if the entitlement element is resolved (the conditional resolution formula is true).

You might use this feature to reduce entitlement when a payee has already received entitlement for related absences that occurred in the past. For example, you could use the beginning balance offset to reduce a sickness entitlement amount by the number of days that were used during the last 12 months.

| Field or Control | Description |
|--|---|
| Offset Formula Element | <p>Select the formula that the system is to execute. The formula is executed each day of the period that you define in the Date From and Date To fields, but only if the entitlement element is resolved. It should return the number of units that you want the system to subtract from the beginning entitlement balance.</p> <p>When the formula is executed, the system loops through the daily absence rows that are defined by the Date From and Date To fields and resolves the formula per row for every take element.</p> <p>For example, your formula assigns a unit amount to each row (or day) that is associated with the variable SICK_PD_TAKEN. If the variable is a member of the entitlement balance accumulator and has an action of subtract, then each day that it resolves, it contributes to the accumulator and subtracts from the beginning entitlement balance.</p> <p>It's important that the formula specify which take elements and events you want the system to consider. Your formula can look at any information in the daily absence rows.</p> |
| From Type, To Type, Date From and Date To | <p>Select the type of element that defines the begin (<i>From</i>) date or end (<i>To</i>) date of the period to which the formula is applied. Values are <i>Bracket-Date</i>, <i>Calendar Date</i>, <i>Date</i>, <i>Formula-Date</i>, <i>System Element-Date</i>, and <i>Variable-Date</i>. (<i>Calendar Date</i> enables you to select a date; <i>Date</i> enables you to use a <i>Date</i> element.)</p> <p>In the Date From and Date To fields, select the name of the element that defines the date. Or, if you selected <i>Calendar Date</i>, select a date in this field.</p> |
| Mapped To Element | <p>For the system to generate take for another take element at the same time that it generates take for this element, select the name of the linked element.</p> <p>When the Take process resolves the element, it inserts a row of duplicate absence daily data for the current day that is being processed, but alters the take element and the take user-defined fields.</p> <hr/> <p>Important! The order in which you add mapped take elements to the take process list is critical. The element that you select in this field is always processed after its source element. Otherwise, the linked take element is not resolved.</p> <hr/> |

| Field or Control | Description |
|----------------------------|---|
| Conditional Element | <p>If you completed the Mapped To Element field, select a conditional formula that is executed for each day of the absence event to determine whether to generate a duplicate entry for the linked element.</p> <p>If the formula returns an amount other than zero, or if you leave this field blank, a duplicate row is created.</p> |
| Day Formula Element | <p>Select the formula element that the system uses to evaluate each day of the absence event. The goal of the formula is to return the units for the absent day to compare to the absence entitlement balance. The Take process uses the take rules, the beginning balance, and the absent units to calculate the paid and unpaid units to pass to payroll.</p> <p>The day formula interprets each absent day in any way that your plan requires. For example, if a payee is scheduled to work 8 hours but works only three hours, the day count formula determines whether this constitutes absence for a full day, half a day, no days, or five-eighths of a day.</p> <p>For example, your day formula might look like this:</p> <pre>IF SCHED_HRS > 0 THEN 1 ->> WRK_DAY ELSE 0 ->> WRK_DAY END IF</pre> <p>Assume that a payee is on vacation from February 1 to 5:</p> <p>Wednesday, February 1, 8 hours</p> <p>Thursday, February 2, 8 hours</p> <p>Friday, February 3, 8 hours</p> <p>Saturday, February 4, 0 hours</p> <p>Sunday, February 5, 0 hours</p> <p>The day formula evaluates each day. When the system processes February 1, it populates the system element, SCHED HRS, and the day formula, <i>WRK DAY</i>, resolves to 1. On January 4, the payee is not scheduled to work. The system populates SCHED HRS with 0, so <i>WRK DAY</i> resolves to 0.</p> |

Generate Positive Input Member List

Complete these fields to have the Take process generate positive input for one or more earning and deduction elements with a calculation rule of Rate \times Units or Rate \times Units \times Percent. Specify the

supporting element that returns a value for the Units component of the calculation rule. You can also select the supporting elements that will return the percent, rate, and amount values.

Common Page Information

| Field or Control | Description |
|-------------------------|--|
| Order | <p>Enter up to three digits to specify the order in which the Take process should generate positive input for the earning or deduction elements when performing the day-by-day processing for this take. The lower the number, the sooner the element will be processed.</p> <p>Order is important only if there are dependencies between the elements. For example, if data generated by Earning 1 is needed to resolve Earning 2, assign Earning 1 a lower order number.</p> |
| Element Type | <p>Select the type of element positive input that is to be generated when you run the Take process: <i>Deduction</i> or <i>Earning</i>.</p> |
| Element | <p>Select the name of the earning or deduction element for which the positive input should be generated.</p> <p>Only earnings and deductions with a calculation rule of "Rate x Unit", or "Rate x Unit x Percent" are allowed.</p> |

Units

| Field or Control | Description |
|--------------------------|--|
| Unit Element Type | <p>Select the type of supporting element that returns the value of the paid or unpaid units that are associated with the earning or deduction. The elements are: <i>Accumulator</i>, <i>Bracket</i>, <i>Formula</i>, <i>SystemElem</i>, or <i>Variable</i>.</p> <p>For example, to return the number of paid units that are calculated by the day formula, you could select the system element DAY COUNT PD. Or, to return the number of unpaid units, you could select DAY COUNT UNPD.</p> <p>To convert the units that are returned by the day formula—from days to hours, for example—use a formula element that uses the following system elements:</p> <ul style="list-style-type: none"> • DAY COUNT (result of the day formula). • DAY COUNT PD (paid portion of the day formula). • DAY COUNT UNPD (unpaid portion of the day formula). • SCHED HRS (hours that the payee was scheduled to work). <hr/> <p>Note: For absence take elements that do not have associated absence entitlement elements, the system does not generate the paid and unpaid elements. You must use DAY COUNT.</p> <hr/> |
| Unit Element | <p>Select the name of the supporting element that returns the units that are associated with the earning or deduction element.</p> |

Rate

Select the Rate tab.

| Field or Control | Description |
|--------------------------|--|
| Rate Element Type | <p>Select the type of supporting element that returns the value of the Rate component. Values are: <i>Bracket</i>, <i>Formula</i>, <i>SystemElem</i>, or <i>Variable</i>.</p> <p>The take process applies the instructions that you enter day by day. If the value of the Rate component changes (during the absence period, for example) the change is applied on the correct day.</p> <p>For example, if payees receive 100 percent of their payment for an illness and the rate changes due to seniority, you might use a system element to retrieve the correct rate for the generated positive input.</p> |
| Rate Element | <p>If you selected an element type, select the name of the supporting element that returns the value of the Rate component.</p> |

Percent

Select the Percent tab.

| Field or Control | Description |
|-----------------------------|--|
| Percent Element Type | <p>If the calculation rule for the earning or deduction element is defined as Rate x Unit x Percent, select a supporting element that returns the value of the Percent component. Values are <i>Bracket</i>, <i>Formula</i>, <i>SystemElem</i>, and <i>Variable</i>.</p> <p>The Take process applies the instructions that you enter day by day. If the value of the percent components changes (during the absence period, for example), the change is applied on the correct day.</p> <p>For example, if payees receive 100 percent of their pay for the first 30 days of an illness and 75 percent for each day thereafter, you might use a bracket element that returns the appropriate percent, based on the length of the absence.</p> |
| Percent Element | <p>If you selected an element type, select the name of the supporting element that returns the value of the Percent component.</p> |

Amount

Select the Amount tab.

| Field or Control | Description |
|----------------------------|---|
| Amount Element Type | Select an element that returns the value of the amount component for the earning or deduction element. The amount overrides any values returned by other components of the element's calculation rule. Although you can still select elements to return the rate or percent, the values of these components are not used for calculations. Values are <i>Accumulator</i> , <i>Bracket</i> , <i>Formula</i> , <i>SystemElem</i> , or <i>Variable</i> . |
| Amount Element | Select the name of the element that returns the value of the Amount component. |

Related Links

[Understanding Processing Elements](#)

Absence Takes - Period Page

Use the Absence Takes - Period page (GP_ABS_TAKE3) to define eligibility, minimum absence, or wait per absence requirements.

Link related absences.

Navigation:

Set Up HCM > Product Related > Global Payroll & Absence Mgmt > Elements > Absence Elements > Absence Takes > Period

This example illustrates the fields and controls on the Absence Takes - Period page.

The screenshot displays the 'Absence Takes - Period' configuration page for the element 'K0ATSICK' (Long Term Sickness). The page is organized into several sections:

- Header:** Shows the element name 'K0ATSICK', description 'Long Term Sickness', and owner 'PS Non-Mnt'.
- Definition Section:**
 - Effective Date:** 01/01/1990
 - Active:** Active
 - Eligibility:** Checked. *Entry Type is 'Cal Date'. Eligibility Date Value is a text field.
 - Minimum Absence:** Checked. *Absence Period Type is 'Numeric'. Absence Value is a text field followed by 'Days'.
 - Wait Per Absence:** Checked. *Wait Period Type is 'Numeric'. *Wait Period Value is '3.00'. Count Formula is 'K0FM8'.
 - Link Absence:** Unchecked.
 - By Original Begin Date:** Unchecked. *Starting From is 'End Date of Last Occurrence'.
 - *Duration Between Two Absences:** 'Numeric'.
 - Duration Value:** A text field.
 - *Unit:** 'Days'.

Eligibility

Complete the **Eligibility**, **Entry Type**, and **Eligibility Date Value** fields if payees are eligible to use entitlement only on or after a certain date.

| Field or Control | Description |
|---|--|
| Eligibility | Select to define an eligibility period for this take. |
| Entry Type and Eligibility Date Value | <p>In the Entry Type field, select the type of supporting element that defines the eligibility date. The Take process treats days that are taken before the eligibility date as unpaid units. Absences that are taken on or after this date can be applied against the entitlement balance. For example, if the eligibility date is June 1, an absence on June 1 qualifies for payment.</p> <p>Values are <i>Bracket</i>, <i>Cal Date</i>, <i>Date</i>, <i>Formula</i>, <i>System Element</i>, and <i>Variable</i>. (<i>Cal Date</i> enables you to select a specific date; <i>Date</i> enables you to select a date element.)</p> <p>In the Eligibility Date Value field, select the name of the element that defines the date. Or, if you selected <i>Calendar Date</i> in the Entry Type field, select the appropriate date.</p> |

Minimum Absence

Complete the **Minimum Absence**, **Absence Period Type**, and **Absence Value** fields if payees must be absent a minimum number of calendar days before an absence event is paid. If the absence event is longer than the minimum period, the entire absence qualifies for payment. If the minimum period is not met, the entire absence is unpaid. (The system does not consider linked absences when determining whether the minimum period has been met. Linked absences are described below.)

The system refers to the end date of an absence to determine whether the minimum period has been met—even when the end date falls in a different calendar period.

| Field or Control | Description |
|-------------------------|--|
| Minimum Absence | Select to define a minimum absence rule for this take. |

| Field or Control | Description |
|--|---|
| Absence Period Type and Absence Value | <p>In the Absence Period Type field, select the type of supporting element that defines the minimum absence period. The period must be in calendar days. Values are <i>Accumulator</i>, <i>Bracket</i>, <i>Duration</i>, <i>Formula</i>, <i>Numeric</i>, <i>System Element</i>, and <i>Variable</i>.</p> <p>In the Absence Value field, select the name of the element. Or, if you selected <i>Numeric</i> in the first field, enter up to 8 digits in this field.</p> <p>For example, if an absence of less than 4 days is unpaid, select <i>Numeric</i> in the first field and type <i>4</i> in the field to the right.</p> |

Wait Per Absence

Complete the **Wait Per Absence**, **Wait Period Type**, **Wait Period Value**, and **Count Formula** fields if each absence event must satisfy a minimum waiting period before it can be paid. When the minimum wait period is met, the payee can be paid only for the period of time that exceeds the wait period.

If you define a **Wait Per Absence** and also select the **Link Absence** check box on this page, you can create a formula that enables linked events to share the same waiting period.

| Field or Control | Description |
|-------------------------|---|
| Wait Per Absence | Select to define a minimum waiting period for each absence. |

| Field or Control | Description |
|--|--|
| <p>Wait Period Type and Wait Period Value</p> | <p>In the Wait Period Type field, select the type of supporting element that defines the number of remaining wait units the payee must be absent before the event can be paid. This element is resolved on the first day of the absence event.</p> <p>Values are <i>Accumulator, Bracket, Duration, Formula, Numeric, System Element, and Variable</i>.</p> <p>In the Wait Period Value field, select the name of the element. Or, if you selected <i>Numeric</i> in the first field, enter up to 8 digits in this field. For example, if you select <i>Numeric</i>, and you enter 3 in the field to the right, the first three days of the absence are not paid.</p> <p>If you select the Link Absence check box to link related events, you can have the value that is returned by a Period formula apply to the linked absence period, rather than to each event.</p> <p>In a Period formula, you can reference one of the following system elements:</p> <ul style="list-style-type: none"> • LINK YES-NO (linked event, yes or no) is set to Yes if the current event is linked to a previous event. • ABS CUM LINK WAIT (cumulative linked wait) captures the total wait units that are taken for the linked events and the current event. <p>Values are stored on the absence results table and carried forward from period to period.</p> |
| <p>Count Formula</p> | <p>If you selected Wait Per Absence, select a formula in this field. The count formula interprets the days that are to be counted against the wait period. This formula is similar to, and usually the same as, the day formula, though this is not a requirement. For example, you might want the day formula to consider workdays and the count formula to consider calendar days.</p> <p>The count formula is resolved each day of the absence event until the wait period is met.</p> <hr/> <p>Note: For payees to be compensated for partial hours worked on the day that the waiting period is met, the count formula must be the same as the day formula.</p> <hr/> |

Linking

| <i>Field or Control</i> | <i>Description</i> |
|---|--|
| Link Absence | Select to have the system link related absences. |
| By Original Begin Date | Select to have the system link the current absence event to the last absence event with the same original begin date. If you do not select this check box, the system treats the event begin date as the original begin date. |
| Starting From | Specify the start date that the system uses to determine if a linked absence falls within the allowed period. When you run the Take process, the system compares the first day of the current absence event to the date that you specify in this field. If the period is greater than that defined by the Duration Between Two Absences field, the absences are not linked. Values are: <i>End Date of Last Occurrence:</i> The system looks at the end date of the last matching event. (If you selected By Original Begin Date , the last matching event is the last event with the same original begin date.) <i>Begin Date of First Occurrence:</i> The system looks at the begin date of the first matching event. |
| Duration Between Two Absences, Duration Value and Unit | In the Duration Between Two Absences field, select the type of element that defines the duration period. Values are <i>Accumulator, Bracket-Numeric, Duration, Formula-Numeric, Numeric, System Element-Numeric, and Variable-Numeric.</i> In the Duration Value field, select the name of the element that defines the duration period. If you selected <i>Numeric</i> in the Duration Between Two Absences field, enter the number of units here. In the Unit field, select the unit of measurement you want to use. Values are <i>Days, Months, and Weeks.</i> |

Absence Takes - Negative Balances Page

Use the Absence Takes - Negative Balances page (GP_ABS_TAKE4) to define negative balance rules (what happens when the entitlement balance is not sufficient to cover an absence).

Navigation:

Set Up HCM > Product Related > Global Payroll & Absence Mgmt > Elements > Absence Elements > Absence Takes > Negative Balances

This example illustrates the fields and controls on the Absence Takes - Negative Balances page.

| Absence Take Name | Calculation | Day Formula | Period | Negative Balances | Priority | Forecasting | Balance Inquiry | D |
|--------------------------|-------------------------|--------------------|--------|-------------------|------------|-------------|-----------------|-------------------|
| Element Name | K0ATSICK | Long Term Sickness | | Owner | PS Non-Mnt | | | |
| Definition | | | | | | | | Find View All |
| Effective Date | 01/01/1990 | | | Active | | | | First 1 of 1 Last |
| *Negative Balance Option | Take with Other Absence | | | | | | | |
| Absence Take | K0AT SICK2 | | | | | | | |

On this page, you specify what the system is to do if a payee's absence take exceeds the entitlement balance; that is, if the entitlement balance drops below zero. You can allow payees to:

- Carry a negative balance up to the limit that you specify.
- Take the absence as unpaid time.
- Use the accrued entitlement that is associated with another type of absence.

Negative balance rules do not take effect until the payee has depleted all the linked entitlements that are defined on the Calculation page.

| Field or Control | Description |
|-----------------------------------|--|
| Negative Balance Option | <p>Specify what the system is to do if a payee's absence take exceeds the entitlement balance; that is, if the entitlement balance drops below zero. Valid values are:</p> <ul style="list-style-type: none"> • <i>Allow Negative Balance</i> – Select if your organization allows employees to take more paid time than they have accrued. Absence time that exceeds accrued entitlement is paid up to the limit that you specify. • <i>Take as Unpaid Time</i> – Select to process any take that exceeds the entitlement balance as unpaid time. When you run the Take process, the system element DAY COUNT UNP is populated with the number of unpaid units. (To have unpaid units processed as a deduction, add the deduction element to the grid at the bottom of the Day Formula page.) • <i>Take with Other Absence</i> – Select if payees can apply the entitlement that is associated with another type of absence to this take. <p>When this option is selected the Absence Take field will open below. Select the take element that is associated with the entitlement that you want to use.</p> <p>For example, your organization pays 100 percent of salary for the first 60 days of maternity leave and 50 percent for the next 30 days. You create two take elements, one called Maternity60 and another called Maternity30. When you define Maternity60, you select <i>Take with Other Absence</i> and link to the Maternity30 element. When the payee's actual maternity leave is entered on the Absence Event Entry page, all 90 days are entered, using the Maternity60 element. The system pays the first 60 days at 100 percent, depleting the maternity entitlement. The system then redirects the next 30 days to the Maternity30 element; that is, it adds a new row for each day after the sixtieth day, using the redirected element.</p> |
| Limit Type and Limit Value | <p>These fields are only available if the Negative Balance Option selected is <i>Allow Negative Balance</i>.</p> <p>To limit the amount of negative entitlement balance allowed, select the supporting element that defines the limit. Any take that exceeds the limit will populate the DAY COUNT UNP system element. A limit of 3, for example, indicates that up to three days will be paid.</p> <p>In the Limit Value, select the name of the element. If you selected <i>Numeric</i> in the first field, enter a number in this field.</p> |
| Absence Take | <p>These fields are only available if the Negative Balance Option selected is <i>Take with Other Absence</i>.</p> <p>Select the take element that is associated with the entitlement that you want to use.</p> |

Absence Takes - Priority Page

Use the Absence Takes - Priority page (GP_ABS_TAKE5) to specify if users can enter more than one absence for a payee for the same day and to assign a priority to absence takes if only one type of absence is allowed each day.

Navigation:

Set Up HCM > Product Related > Global Payroll & Absence Mgmt > Elements > Absence Elements > Absence Takes > Priority

This example illustrates the fields and controls on the Absence Takes - Priority page.

| Field or Control | Description |
|--------------------------------|---|
| <p>Allow Duplicates</p> | <p>Select to enable users to enter more than one absence for the same day on the Absence Event Entry page. For example, if an employee has a two-hour union meeting in the morning and takes six hours of vacation on the same day, select Allow Duplicates to enable the user to enter and save the two absences for the same day. Clear this check box to prevent users from entering more than one absence for the same day.</p> <p>When a user enters multiple events for the same day on the Absence Event Entry page and tries to save the entries, the system displays a message. If the user clicks OK, the system applies the take definition with the highest priority for the date in conflict (that is, the event with the lowest priority number).</p> <p>You designate the priority of the take element in the Event Priority field. The priority number appears on the Absence Event Entry page when you enter an absence using this take element.</p> <p>Using the same example, if you want the system to display the above message when a user tries to save the entries for a union meeting and vacation that occur the same day, do not select Allow Duplicates.</p> |

| <i>Field or Control</i> | <i>Description</i> |
|-------------------------|--|
| Event Priority | <p>You can specify the priority of this absence take element in relation to others by entering a unique number of up to three digits in this field. Lower numbers represent higher priority.</p> <p>When a user tries to enter more than one type of absence for the same day, and duplicates are not allowed, the system displays a message that provides information about take priorities. It also enables the user to invoke a process that causes the system to use the take definition with the highest priority for the date in conflict.</p> |

Take Codes Allowed for the Same Day

| <i>Field or Control</i> | <i>Description</i> |
|-------------------------|--|
| Absence Take | <p>If you selected Allow Duplicates, specify the types of absences that can be taken the same day. Add a row for each allowable absence take element. Select at least one element.</p> <p>When you run the Take process, the system calculates total partial hours that were written to the results table for events that occurred on the same day. It returns the total to the system element named ABS CUM PARTIAL HR. (You might consider creating a formula that generates an error if scheduled hours exceed total partial hours.)</p> |

Absence Takes - Forecasting Page

Use the Absence Takes - Forecasting page (GP_ABS_TAKE6) to specify the formula to use for absence forecasting and the list of elements that are displayed by the Absence Forecasting process.

Navigation:

Set Up HCM > Product Related > Global Payroll & Absence Mgmt > Elements > Absence Elements > Absence Takes > Forecasting

This example illustrates the fields and controls on the Absence Takes - Forecasting page.

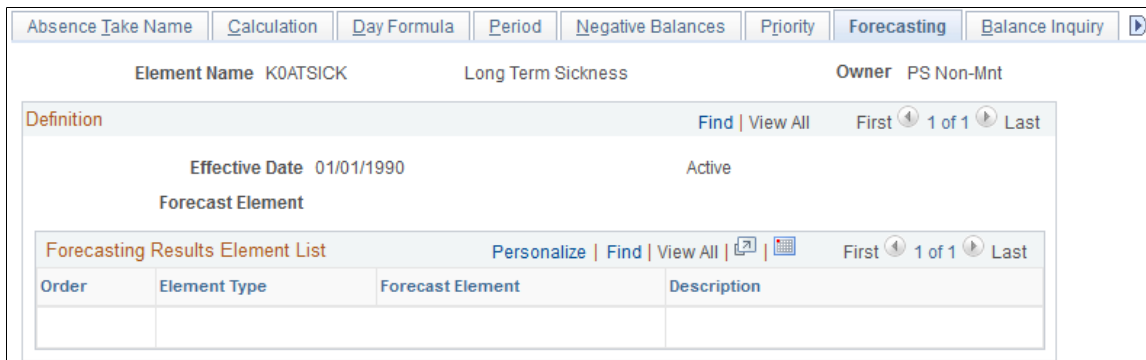

Complete the Forecasting page if you want users to be able to run the Forecast process when entering absences.

Note: To enter information on this page, the **Forecasting Used** check box must be selected on the Forecasting page that you access through the link at the bottom of the Absence Take – Name page.

| Field or Control | Description |
|-------------------------|--|
| Forecast Element | <p>Select the formula that you want the system to resolve during the Forecasting process.</p> <p>Only formulas with a field type of character are allowed. The system resolves this formula for each day of the absence event immediately after the day is evaluated (after the DAY COUNT, DAY COUNT PD, and DAY COUNT UNPD elements are resolved). It stores the last resolved value.</p> <p>As an example, say you want your formula, named FM ELIG, to return a value of ELIGIBLE or NOT ELIGIBLE depending on whether a payee has enough entitlement to cover an absence. Your forecast formula might look like this:</p> <pre>IF DAY COUNT UNP > 0 THEN NOT ELIGIBLE >> FM ELIG ELSE ELIGIBLE >> FM ELIG ENDIF</pre> |

Forecasting Results Element List

This group box controls what appears on the Absence Forecast Results page (in the Absence Event Entry component) after you run the Forecasting process. Select the elements for which you would like to view results. For example, you may want a duration element to display the length of the absence and an accumulator element to display the entitlement balance.

The elements that you select should be those that are normally resolved during absence processing. Element types are: *Accumulator, Bracket, Date, Duration, Formula, System Element, and Variable.*

Related Links

[Absence Formulas](#)

Absence Takes - Balance Inquiry Page

Use the Absence Takes - Balance Inquiry page (GP_ABS_TAKE7) to list the elements that are displayed by the Balance Inquiry process.

Navigation:

Set Up HCM > Product Related > Global Payroll & Absence Mgmt > Elements > Absence Elements > Absence Takes > Balance Inquiry

This example illustrates the fields and controls on the Absence Takes - Balance Inquiry page.

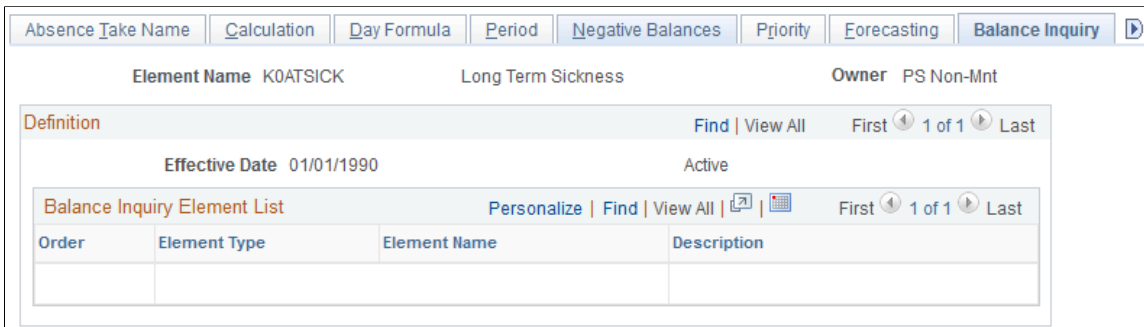

Note: To enter information on this page, the **Forecasting Used** check box must be selected on the Absence Take Name page.

Balance Inquiry Element List

This group box controls what appears on the Forecast Balance page after you run the Balance Inquiry process. Select the elements for which you would like to view results; for example, accumulators that track entitlement balances for the take, and system elements that help explain the balances.

Element types are: *Accumulator, Bracket, Date, Duration, Formula, System Element, and Variable.*

Absence Takes - User Defined Result Fields Page

Use the Absence Takes - User Defined Result Fields page (GP_ABS_TAKE8) to select the user-defined fields that can be overwritten by a system element during processing.

Navigation:

Set Up HCM > Product Related > Global Payroll & Absence Mgmt > Elements > Absence Elements > Absence Takes > User Defined Result Fields

This example illustrates the fields and controls on the Absence Takes - User Defined Result Fields page.

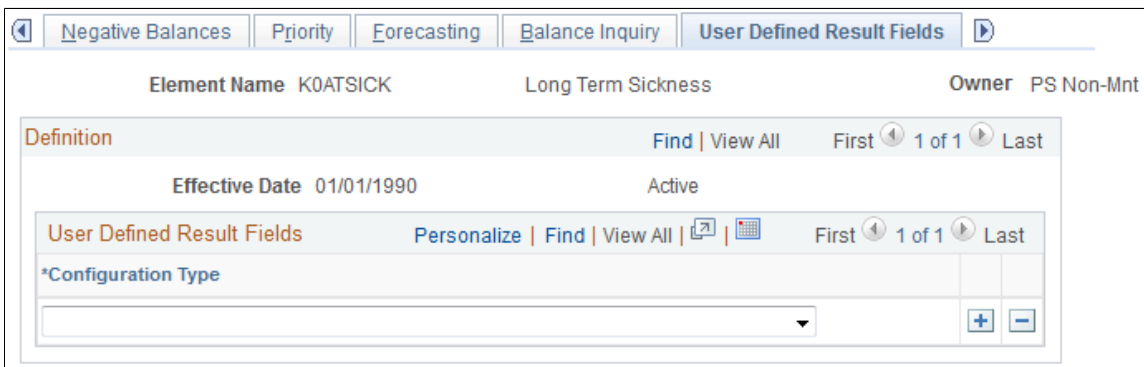

In the Configuration Type field, select the user-defined fields that can be overwritten by a system element. During batch processing, the value that's assigned to the corresponding system element will overwrite the user-entered value in the absence results table (GP_RSLT_ABS). Select only those fields that you will use in your rules.

For example, to specify that the value a user enters in the Date 3 field on the Absence Event Input Detail page can be overwritten, select *User Defined Date 3* in the Configuration Type field.

Related Links

[Understanding Absence Element Setup](#)

Absence Takes - Supporting Element Override Page

Use the Absence Take - Supporting Element Override page (GP_ELM_DFN_SOVR) to override the value of a bracket, date, duration, formula, or variable element that is used in the definition of the take element.

Navigation:

Set Up HCM > Product Related > Global Payroll & Absence Mgmt > Elements > Absence Elements > Absence Takes > Supporting Element Override

Preparing Absence Elements for Use

Once you've created absence entitlement and take elements, follow these steps to prepare them for use:

1. Assign elements to payees.

Begin by adding the elements to an element group. (Element groups are linked to eligibility groups, which are linked to pay groups. A pay group is associated with each payee.) Payees can accrue entitlement and be paid for absences only when they are associated with absence elements. Exception: It is not necessary to assign per-absence entitlement elements to payees. When you assign related take elements, payees are eligible for the per-absence entitlement. To assign entitlement elements that are defined at the Payee Level (you selected *Payee Lvl* in the Entitlement field on the Absence Entitlements - Calculation page), use the Entitlement/Take Assignment page.

2. Add elements to the absence processing framework.

Sections tell the system which elements to resolve during processing. You can create a separate section for the entitlement and take processes, or you can create one section for both, depending on your organization's needs. Per-absence entitlement elements do not need to be included on a process list via a section. They are processed automatically when the Take program processes the related take element.

Related Links

[Defining Element Groups](#)

Setting Up Absence Entitlement Balance Forecasting and Inquiry

Pages Used to Create a Transaction Definition and Filter Self Service Absence

| <i>Page Name</i> | <i>Definition Name</i> | <i>Usage</i> |
|------------------------------------|------------------------|--|
| <u>Transaction Definition Page</u> | GP_TXN | Create a transaction definition by linking a calendar group template to the Absence Forecasting process or Balance Inquiry process. A transaction definition is tied to a specific country. |
| <u>Forecasting Filter Page</u> | GP_TXN_FILTER | Select the status of the absence self service absences that the system is to consider when you run the Forecasting process. If integrating with Time and Labor, the status selected will be considered with forecasting processes on Timesheets also. |

Understanding How to Enable Absence Entitlement Balance Forecasting and Inquiry

Before using absence forecasting or balance inquiry, you must activate these features for each absence take and entitlement element to which they apply, except for per-absence entitlement elements. For example, to forecast entitlement for vacations only, you activate forecasting for the vacation take and vacation entitlement elements.

Following is an overview of steps to enable absence forecasting or balance inquiry:

1. Define forecast formulas for absence takes (absence forecasting only).

A forecast formula evaluates an absence according to the business rules you define. For example, your formula might determine if there is sufficient entitlement to cover an absence and, if not, what action to take. It returns a user-defined character string that appears on the Absence Event Entry page. For example, it might display "Eligible" or "Success" if there is enough entitlement to cover an absence. The system resolves the forecast formula for each day of the absence, immediately after it resolves the day count, day count paid, and day count unpaid. Only the last value of the formula is stored and is moved to the Absence Event table (GP_ABS_EVENT) during the Absence Forecasting process. The value is also moved to the results table (GP_RSLT_ABS) when the event is processed during the Absence Take process.

The formula can check to see if there are any unpaid units for the day and why the units are unpaid—perhaps because of a waiting period. To determine this, you refer to other absence system elements, such as the beginning wait balance, ABS BEGIN WAIT BAL, and the ending balance, ABS END WAIT BAL.

You can use the results of the forecast formula to invoke other actions. For example, you might create a formula, that when resolved to Eligible, populates the units element that is used to generate positive input. (You select the Units element on the Take - Day Formula page.)

2. Enable forecasting and/or balance inquiry for the take element on the Forecasting page that you access through the Element Name page.
 - a. For absence forecasting, indicate whether forecasting is allowed (select Forecasting Used) or required (select Forecasting Required).
 - b. For balance inquiry, select **Forecasting Used**.

Note: The **Forecasting Used** field is not used to enable forecasting for absence self-service. To enable forecasting for absence self-service select the **Allow Forecasting** field on the Forecasting Messages page on the Country Take component.

If you are integrating with PeopleSoft Time and Labor, the **Allow Forecasting** field on the Forecasting Messages page of the Country Take component. is used to enable forecasting on Timesheets.

3. Complete the Take - Forecasting and Take - Balance Inquiry pages, as applicable.
 - a. For absence forecasting, select the forecast formula and the elements that are to return the results of the forecast process on the Take - Forecasting page.
 - b. For balance inquiry, select the elements that are to return the results of the balance inquiry process on the Take - Balance Inquiry page.

4. Enable forecasting for associated entitlement elements.

Repeat step 2 for each linked, frequency-based entitlement element.

Note: For entitlements the **Forecast Used** field will also apply to those entitlements used in event entry through absence self service, as well as, Time and Labor Timesheets if you are integrating with Time and Labor.

5. Enable forecasting for redirected take elements.

If you've redirected this take element to another take element on the Take - Negative Balances page, follow step 2 for the redirected take element and its associated entitlement elements.

6. Create a Calendar Group template.

When you run the Forecasting or Balance Inquiry process, the system must know which absence calendars to refer to so that it can identify the elements to process, the period of time to evaluate, and so on. Use the Calendar Group page to select the applicable absence calendars. (These should be the same calendars that you use when running the Take and Entitlement processes.) Also select the **Use as a Template** check box on the Calendar Group page to indicate that the calendar group is to be used by the forecasting process.

The template should cover the forecasting period, which runs from the earliest calendar that has not been finalized for the payee to the end date of the latest absence event (or the as of date, for Balance Inquiry). Most likely, you'll want the calendar group to span one or more years. (It can include

up to 225 calendars.) The template should also include all pay groups whose employees could be forecasted.

7. Create transaction definitions.

Use the Transaction Definition page to link the calendar group template (created in the previous step) to the absence forecasting or balance inquiry process. If you plan to use both processes, create a transaction definition for each. When you launch the Forecasting or Balance Inquiry process, the transaction ID tells the system which calendar group to look for.

8. Specify the status of the absence events to be considered by the Forecasting process.

You have the Forecasting process consider only those absence events that are in one of the statuses that you specify. Use the Forecasting Filters page to select the statuses.

Related Links

[Absence Entry, Approval, and Self Service Features](#)

[Forecasting Absence Entitlement Balance During Absence Entry](#)

[Viewing Current Absence Entitlement Balances and Running the Absence Entitlement Balance Inquiry Process](#)

[Defining Element Groups](#)

Transaction Definition Page

Use the Transaction Definition page (GP_TXN) to create a transaction definition by linking a calendar group template to the Absence Forecasting process or Balance Inquiry process.

A transaction definition is tied to a specific country.

Navigation:

Set Up HCM > Product Related > Global Payroll & Absence Mgmt > Elements > Absence Elements > Absence Forecast Transactions > Transaction Definition

This example illustrates the fields and controls on the Transaction Definition page.

The screenshot shows the 'Transaction Definition' page with two tabs: 'Transaction Definition' (selected) and 'Forecasting Filter'. The page displays the following information:

- Country: AUS (Australia)
- Transaction ID: 100
- *Description: Forecast Transaction
- Short Description: Forecast
- *Calendar Group ID: KA_TEMPLATE (with a magnifying glass icon and 'Forecasting Template' text)

| Field or Control | Description |
|--------------------------|--|
| Transaction ID | Values are: <i>100</i> : Absence Forecasting process. <i>110</i> : Balance Inquiry process. <hr/> Note: You can define one of each type of transaction ID per country. |
| Calendar Group ID | Select the appropriate calendar group ID. You can choose from the list of calendar group IDs that have been set up as templates. |

Forecasting Filter Page

Use the Forecasting Filter page (GP_TXN_FILTER) to select the status of the absence self service absences that the system is to consider when you run the Forecasting process.

If integrating with Time and Labor, the status selected will be considered with forecasting processes on Timesheets also.

Navigation:

Set Up HCM > Product Related > Global Payroll & Absence Mgmt > Elements > Absence Elements > Absence Forecast Transactions > Forecasting Filter

This example illustrates the fields and controls on the Forecasting Filter page.

The system uses status values, such as Saved, Submitted, and Approved, to track and manage the approval of absence requests.

If you are using absence self service, use this page to specify which absence statuses the system is to consider when using forecasting. For example, you may want the forecasting process to evaluate only those absences that have a status of *Approved*. In this case, you would select *Approved* in the **Workflow Status** field.

Note: If integrating with Time and Labor, use this page to specify which absence statuses the system is to consider when using forecasting on Timesheets.

When an absence is requested through the Absence Event Entry page the **Workflow Status** field is set to blank. If you run the absence forecasting, such events will be considered during forecasting. If you have events entered through event entry and self service, when you run forecasting it will consider all the events entered through event entry plus those entered through self service and whose statuses were included in the Forecasting Filter page.

Chapter 12

Using Schedules

Understanding Work Schedules

In Absence Management, work schedules provide a way to communicate and manage workforce attendance expectations. They also enable the absence process to determine when a payee's absence falls on a scheduled work day. For exception time reporting payees, you set up schedules and enter exception data. For positive time reporting payees, the system compares reported hours with schedules to determine pay.

Note: Absence Management and PeopleSoft Time and Labor use many of the same pages and records for schedule setup and assignment. If you're using both applications, you need to create and assign schedules only once. The information that displays on the scheduling pages may vary somewhat, depending on which application you use to access them.

This topic discusses:

- Types of schedules.
- Types of shifts.
- Schedule definitions and calendars.
- Rotating schedules.
- Self service scheduling features.
- Schedule settings.

Type of Schedules

You can define three main types of schedules:

- Punch schedules include punch detail such as In, Out, Meal, Break, and Transfer.
- Elapsed schedules show the duration of time to be worked—for example, eight hours on Monday.
- Flex schedules are practical when a payee has some flexibility to begin and end the workday.

Types of Shifts

A shift represents a set of punch types from which it is built. You can create three types of shifts:

- Elapsed shifts

Define one elapsed punch entry for the shift, such as an elapsed shift of 8 hours, which is non-clock time. Elapsed shifts cannot exceed 24 hours.

- Punch shifts

Use punch shifts to create shifts that define specific work times. Punch shifts are defined by an in punch and the first subsequent instance of an out punch. Other punches such as break, meal, or transfer, can occur between the in and out punches. Punch times are associated with each punch. The duration of a punch can be entered, or the system can calculate the duration when the next punch time is entered.

- Flex (flexible) shifts

The system supports flexible shifts, giving payees latitude for beginning and ending shifts. You can enter core, required hours and the weekly number of hours that the flexible shift requires, but the system uses the weekly information only if you set up an array for processing.

See [Defining Array Elements](#).

Example: Flex Shifts

| Type of Flex Shift | In Punch | Out Punch | Scheduled Hours | Flex Start | Flex End | Flex Weekly Hours |
|---------------------------|-----------------|------------------|------------------------|-------------------|-----------------|--------------------------|
| 1 Flex Band | 06:00 | 18:00 | 8 | 09:00 | 15:00 | 40 |
| 2 Flex Range | 06:00 | 19:00 | 8 | | | 40 |
| 3 Flex Core | 00:00 | 23.59 | 8 (daily average) | 09:00 | 15:00 | 40 |
| 4 Flex Core Plus | 00:00 | 23.59 | 8 | 09:00 | 15:00 | 40 |

In this example:

1. Payees begin and end their workdays within a range of flexible hours in the morning and afternoon (begin between 06:00 and 09:00 and end between 15:00 and 18:00). They must work 8 hours a day, 40 hours a week and must work during the core hours, 09:00 to 15:00. A payee's begin and end times can vary daily within the flexible hours.
2. Payees work any 8 hours during the day, within a range of flexible hours (between 06:00 and 19:00), and there's no company-defined core period. They must work 40 hours a week.
3. Payees work anytime during the week, provided that they work 40 hours a week and during the core hours, 09:00 to 15:00. A payee's begin and end times can vary daily within the flexible hours, and the length of the workday can vary, provided that the weekly 40-hour requirement is met.
4. Payees work 40 hours a week and during the core hours, 09:00 to 15:00. A payee's begin and end times can vary daily within the flexible hours, but the workday must be 8 hours.

Schedule Definitions and Schedule Calendars

A schedule definition defines a work schedule and is identified by a schedule ID. After creating schedule definitions, you can assign them to pay groups and payees. The same schedule can be assigned to multiple pay groups. You also have the option of creating and assigning a personal schedule to a given payee.

The system uses schedule definitions to derive schedule calendars and to resolve payee schedules. A schedule calendar is a range of dates with specified work and non-work time.

Rotating Schedules

You can define rotating schedules that enable you to assign the same schedule to several payees with different start dates. For example, a basic rotating schedule for a continuously operating factory operation might consist of:

- Seven days
- One off
- Seven afternoons
- One off
- Seven nights
- Five off

To keep the factory staffed 24 hours, seven days per week, there are four groups, or rotations, of workers. Each rotation uses the same schedule, but the actual days are staggered so that there is always one rotation covering each of the shifts. This table represents what the actual rotations would look like for a month:

| Start Day | Rotation 1 | Rotation 2 | Rotation 3 | Rotation 4 |
|------------------|-------------------|-------------------|-------------------|-------------------|
| 1 | Day | Off | Afternoon | Night |
| 2 | Day | Afternoon | Off | Night |
| 3 | Day | Afternoon | Night | Off |
| 4 | Day | Afternoon | Night | Off |
| 5 | Day | Afternoon | Night | Off |
| 6 | Day | Afternoon | Night | Off |
| 7 | Day | Afternoon | Night | Off |
| 8 | Off | Afternoon | Night | Day |

| Start Day | Rotation 1 | Rotation 2 | Rotation 3 | Rotation 4 |
|------------------|-------------------|-------------------|-------------------|-------------------|
| 9 | Afternoon | Off | Night | Day |
| 10 | Afternoon | Night | Off | Day |
| 11 | Afternoon | Night | Off | Day |
| 12 | Afternoon | Night | Off | Day |
| 13 | Afternoon | Night | Off | Day |
| 14 | Afternoon | Night | Off | Day |
| 15 | Afternoon | Night | Day | Off |
| 16 | Off | Night | Day | Afternoon |
| 17 | Night | Off | Day | Afternoon |
| 18 | Night | Off | Day | Afternoon |
| 19 | Night | Off | Day | Afternoon |
| 20 | Night | Off | Day | Afternoon |
| 21 | Night | Off | Day | Afternoon |
| 22 | Night | Day | Off | Afternoon |
| 23 | Night | Day | Afternoon | Off |
| 24 | Off | Day | Afternoon | Night |
| 25 | Off | Day | Afternoon | Night |
| 26 | Off | Day | Afternoon | Night |
| 27 | Off | Day | Afternoon | Night |

| Start Day | Rotation 1 | Rotation 2 | Rotation 3 | Rotation 4 |
|------------------|-------------------|-------------------|-------------------|-------------------|
| 28 | Off | Day | Afternoon | Night |

Self-Service Scheduling Features

Self-service scheduling pages are available to managers and payees. Managers can use these pages to view schedules, view payee's scheduling preferences and change schedule assignments, and create schedules for individual payees. Employees can use these pages to view their monthly schedules and to enter personal scheduling preferences.

Schedule Settings

Use the Schedule Settings page to define the labels to display for punch types, the range of dates for the Dates table (TL_DATES_TBL), and other scheduling settings. The Dates table stores date-related information, such as the day of week, day of month, and calendar year that the system needs to build calendar schedules.

Related Links

[Schedule Settings Page](#)

[Using Self-Service Scheduling Features for Managers](#)

[Using Self-Service Scheduling Features for Employees](#)

Creating and Viewing Schedules

To create schedules, use the Schedule Groups (SCH_GROUP), Shifts (SCH_SHIFTS), Workdays (SCH_WRKDAY), and Definitions (SCH_DEFINITION) components.

Note: Self-service pages are available to managers for creating, viewing, and modifying work schedules.

Pages Used to Define and View Schedules

| Page Name | Definition Name | Usage |
|---|------------------------|---|
| Schedule Group Page | SCH_GROUP | Define schedule groups. |
| Shift Page | SCH_SHIFT | Set up elapsed, flex, and punch shifts. |
| Workday Page | SCH_WRKDAY | Set up workdays. |
| Schedules - Definition Page | SCH_DEFINITION | Define basic schedule definition details. |
| Schedule Shifts Page | SCH_DEFINITION_2 | Define shifts for schedule definitions. |

| Page Name | Definition Name | Usage |
|-------------------------------|------------------------|---|
| Shift Information Page | SCH_DEFN_SEC | Define or view shift details. |
| <u>Schedule Calendar Page</u> | SCH_CLND_VW_SEC | View the schedule calendar derived from a specific schedule definition. |

Related Links

[Using Self-Service Scheduling Features for Managers](#)

Understanding Schedule Creation

To create work schedules:

1. Create schedule groups.

Schedule groups provide a way to organize schedules and group payees with like schedules. Each schedule group is associated with a SetID (as is each shift, workday, and schedule definition). When you assign schedules, you select the schedule group, which filters the schedules that you can assign.

2. Create shifts (optional).

You can create elapsed, flex, and punch shifts with the Shifts component (SCH_SHIFT) or you can enter shift information manually when you create a schedule definition.

3. Create workdays (optional).

You can create workdays to be used as labels for the days within a schedule definition.

4. Create schedule definitions.

Schedule definitions comprise a series of short term or long term workdays. When you create schedule definitions, you can incorporate predefined shifts and workdays. You can also enter shift information manually.

5. View schedule calendar.

The system derives the schedule calendar from the schedule definition.

Creating Personal Schedules

At times, you may want to create a schedule definition that applies only to a specific payee. In these cases, you use the Personal Schedule Definition component (SCH_DEFN_ADHOC) that you access through the Work Schedule Assignment page. The personal schedule definition pages are identical to the pages in the Schedule Definition component that you use to define all other work schedules.

Related Links

[Personal Schedule Definition - Definition Page](#)

Schedule Group Page

Use the Schedule Group page (SCH_GROUP) to define schedule groups.

Navigation:

Set Up HCM > Product Related > Global Payroll & Absence Mgmt > Schedules > Schedule Groups > Schedule Group

This example illustrates the fields and controls on the Schedule Group page.

Schedule Group

Schedule Group K0CYM

*Description

Short Description

Default Record Group Set IDs

| | | |
|-------------------------------|------------------------------------|------------------------------|
| Default Set ID | <input type="text" value="SHARE"/> | Table Set shared across Corp |
| Clone Existing Schedule Group | <input type="text"/> | |

Think of a schedule group as a way to organize schedules. Shifts, workdays, and schedule definitions are created based on a SetID value. Schedule groups group these together by way of the Set Control value.

When you assign a schedule to a pay group or directly to a payee, you must first select the associated schedule group. This selected schedule group filters the schedules that you can choose from.

| <i>Field or Control</i> | <i>Description</i> |
|--------------------------------------|--|
| Clone Existing Schedule Group | If you clear the Default SetID field, you can select a schedule group to clone. The system copies the SetID from the definition of the cloned schedule group. |

Related Links

“Understanding PeopleSoft HCM System Data Regulation” (Application Fundamentals)

Shift Page

Use the Shift page (SCH_SHIFT) to set up elapsed, flex, and punch shifts.

Navigation:

Set Up HCM > Product Related > Global Payroll & Absence Mgmt > Schedules > Schedule Shifts > Shift

This example illustrates the fields and controls on the Shift page.

Shift

Set ID AUS01 Setid for AUS01 BU
Shift ID KAPCH 0800

Shift Elements 1 of 1 | View All

*Effective Date *Description

*Shift Type Short Description

Off Shift Sched Hrs

Start Time End Time

Taskgroup for Time Reporting

Taskgroup

Task Template ID

TR Template

Schedule Configuration Totals

| | | | | | | | |
|---------|------|---------|------|---------|------|---------|------|
| Total 1 | 0.00 | Total 2 | 0.00 | Total 3 | 0.00 | Total 4 | 0.00 |
|---------|------|---------|------|---------|------|---------|------|

Shift Details 1-6 of 6 |

Shift Time

| *Punch Type | Time | Time Zone | Duration | Task Profile ID | Cfg 1 | Cfg 2 | Cfg 3 | Cfg 4 | | |
|---|---|---|-----------------------------------|---|--------------------------|--------------------------|--------------------------|--------------------------|----------------------------------|----------------------------------|
| <input type="text" value="In"/> <input type="button" value="v"/> | <input type="text" value="8:00:00AM"/> | <input type="text"/> <input type="button" value="🔍"/> | <input type="text" value="4.00"/> | <input type="text"/> <input type="button" value="🔍"/> | <input type="checkbox"/> | <input type="checkbox"/> | <input type="checkbox"/> | <input type="checkbox"/> | <input type="button" value="+"/> | <input type="button" value="-"/> |
| <input type="text" value="Meal"/> <input type="button" value="v"/> | <input type="text" value="12:00:00PM"/> | <input type="text"/> <input type="button" value="🔍"/> | <input type="text" value="1.00"/> | <input type="text"/> <input type="button" value="🔍"/> | <input type="checkbox"/> | <input type="checkbox"/> | <input type="checkbox"/> | <input type="checkbox"/> | <input type="button" value="+"/> | <input type="button" value="-"/> |
| <input type="text" value="In"/> <input type="button" value="v"/> | <input type="text" value="1:00:00PM"/> | <input type="text"/> <input type="button" value="🔍"/> | <input type="text" value="2.00"/> | <input type="text"/> <input type="button" value="🔍"/> | <input type="checkbox"/> | <input type="checkbox"/> | <input type="checkbox"/> | <input type="checkbox"/> | <input type="button" value="+"/> | <input type="button" value="-"/> |
| <input type="text" value="Break"/> <input type="button" value="v"/> | <input type="text" value="3:00:00PM"/> | <input type="text"/> <input type="button" value="🔍"/> | <input type="text" value="0.25"/> | <input type="text"/> <input type="button" value="🔍"/> | <input type="checkbox"/> | <input type="checkbox"/> | <input type="checkbox"/> | <input type="checkbox"/> | <input type="button" value="+"/> | <input type="button" value="-"/> |
| <input type="text" value="In"/> <input type="button" value="v"/> | <input type="text" value="3:15:00PM"/> | <input type="text"/> <input type="button" value="🔍"/> | <input type="text" value="1.75"/> | <input type="text"/> <input type="button" value="🔍"/> | <input type="checkbox"/> | <input type="checkbox"/> | <input type="checkbox"/> | <input type="checkbox"/> | <input type="button" value="+"/> | <input type="button" value="-"/> |
| <input type="text" value="Out"/> <input type="button" value="v"/> | <input type="text" value="5:00:00PM"/> | <input type="text"/> <input type="button" value="🔍"/> | <input type="text" value="0.00"/> | <input type="text"/> | <input type="checkbox"/> | <input type="checkbox"/> | <input type="checkbox"/> | <input type="checkbox"/> | <input type="button" value="+"/> | <input type="button" value="-"/> |

| Field or Control | Description |
|-------------------------|---|
| Effective Date | <p>Enter a date for this shift. If you modify a previously saved shift, the effective date that you select has some limitations. You cannot change the effective date of the shift to:</p> <ul style="list-style-type: none"> A date before the earliest effective date of all workdays that contain that shift. A date later than the start date of any schedule calendar containing it. A date later than the earliest effective date of all pay groups whose default schedule IDs contain that shift. |

| Field or Control | Description |
|--|--|
| Shift Type | <p>Select a type. Options are:</p> <p><i>Elapsed</i>: Only the <i>Elapsed</i> punch types appear in the prompt. An <i>Elapsed</i> shift can contain only one punch entry.</p> <p><i>Punch</i>: <i>In</i>, <i>Out</i>, <i>Break</i>, <i>Meal</i>, and <i>Transfer</i> punch types can be entered. The Flex Shift Information group box doesn't appear on the page. To save punch shifts, you need an <i>In</i> and <i>Out</i> punch.</p> <p><i>Flex</i>: Only <i>In</i> and <i>Out</i> punches can be entered. The Flex Shift Information group box appears, available for entry. To save flex shifts, you need an <i>In</i> and <i>Out</i> punch.</p> <p>If you change this field in Add mode and punch detail is already entered, you're warned that punch detail is deleted if the type field is changed. For all effective-dated rows, the system deletes the punch details for all effective-dated rows and the type field is updated to the new type that you selected.</p> <p>Having saved a shift as one type, you cannot change it to another.</p> |
| Off Shift | <p>Select to identify this day as an off day.</p> <hr/> <p>Note: If you are including off days for the self service absence duration calculation you will need to add the hours you would like to use for an off day in the duration field.</p> <hr/> |
| Scheduled Hrs (scheduled hours) | <p>Displays the total amount of work time for the shift. For example, you require payees to punch in at 09:00 and punch out at 17:00, but the shift includes a one-hour non-punch lunch break. The field calculates nine hours, but your organization is paying for eight hours worked, so the scheduled hours are eight.</p> <p>This field's value is calculated from the sum of the durations of punches in the group box at the bottom of the page—except <i>Meal</i> punches. You can edit this number for <i>Punch</i> and <i>Flex</i> shifts. For an <i>Elapsed</i> shift, this field equals the <i>Elapsed</i> punch entry's duration and is unchangeable.</p> <p>If you make changes affecting punch time or punch duration, the Scheduled Work Hours field recalculates.</p> |
| Start Time and End Time | <p>These fields indicate the starting and ending times of the shift. For fixed and punch shifts, the system populates these fields automatically based on the information you enter in the Shift Detail group box.</p> |

Taskgroup for Time Reporting

This group box enables you to view time reporting and task elements while you build the schedule definition. It appears only if you have Time and Labor installed.

| Field or Control | Description |
|-----------------------------------|---|
| Taskgroup | Select a taskgroup. The system populates the Time Reporting Template ID field with the associated time reporting template. See “Understanding Task Reporting Requirements” (PeopleSoft Time and Labor). |
| Task Template ID | Displays the task template associated with the taskgroup you select. Click the link next to view details about the task template. See “Understanding Task Reporting Requirements” (PeopleSoft Time and Labor). |
| Time Reporting Template ID | The system populates this field with the time reporting template associated with the taskgroup you select. Click the link next to this field to view details about the time reporting template. See “Creating Time Reporting Templates” (PeopleSoft Time and Labor). |

The task template and the related time reporting template determine which task elements and time reporting elements appear as columns in the grid for scheduling purposes.

Schedule Configuration Totals

Total durations appear for the punches being tracked. For each selected check box that appears in the group box at the bottom of the page, the corresponding configuration total is updated with the number of hours corresponding to the total of all marked entries.

Flex Shift Information

If the *Flex* shift type is selected, these times represent the required core hours for the flex shift.

| Field or Control | Description |
|--------------------------------|---|
| Core Begin and Core End | Enter the times for the core period, the period when payees must be at work, excluding meal and break time. The core begin time must be after the shift's <i>In</i> punch; the core end time must be before the shift's <i>Out</i> punch. |
| Weekly Hours | Enter how many hours this shift requires. |

Shift Details

This group box label varies, depending on which shift type you selected. Saving the shift requires at least one line of punch detail.

| Field or Control | Description |
|-------------------------|---|
| Type | <p>Select a punch type. You cannot have consecutive punches (except transfer punches) of the same type. Options are:</p> <p><i>In</i>: Start of a work period—at the beginning of a shift or for returning to work after a break or meal. The first punch of a punch or flex shift must be an <i>In</i> punch. Punch and flex shifts cannot be saved if an <i>In</i> punch lacks a punch time and duration.</p> <p><i>Transfer</i>: Start of a work period that generally denotes a change in task and compensation-related characteristics.</p> <p><i>Break</i>: Start of a break period. If you enter a <i>Break</i> punch, you must follow this with an <i>In</i> or <i>Transfer</i> punch.</p> <p><i>Meal</i>: Start of a meal period. If you enter a <i>Meal</i> punch, an <i>In</i> or <i>Transfer</i> punch must follow immediately, or the system can't save the page.</p> <p><i>Out</i>: Start of unpaid, non-work time. Required as the last punch of a punch or flex shift. The <i>Duration</i> field is unavailable for entry. You can't enter an <i>Out</i> punch if an <i>In</i> punch doesn't precede it somewhere in the shift. <i>Punch</i> and <i>Flex</i> shifts cannot be saved if an <i>Out</i> punch lacks a punch time. For a <i>Punch</i> or <i>Flex</i> shift, you must enter an <i>Out</i> punch. No punches can be added to a shift after the <i>Out</i> punch row.</p> <p><i>Elapsed</i>: For <i>Elapsed</i> shifts. The associated duration reflects the elapsed duration of the shift. An <i>Elapsed</i> shift cannot be saved if an <i>Elapsed</i> punch lacks a punch duration.</p> <hr/> <p>Note: This documentation uses <i>punch</i> and <i>punch type</i> interchangeably.</p> <hr/> |

| Field or Control | Description |
|-------------------------|---|
| Time | <p>For <i>Punch</i> and <i>Flex</i> shifts; all punches (except the <i>Out</i> punch) in <i>Punch</i> and <i>Flex</i> shifts require a time and duration. Enter the time this punch is scheduled. The first punch time of a shift must be entered. You can enter subsequent punch times, or the system can calculate punch times based on the duration of the preceding punch.</p> <p>If you change the time of a punch besides the last punch, the duration changes, based on the new and the subsequent punch time. If it's not the first punch, the duration of the previous punch changes, based on the changed punch's new punch time.</p> <p>If you enter a punch time, the system calculates the duration based on the punch time of the previous row. If you enter a duration, the system calculates this field on the next punch row.</p> |
| Time Zone | Enter a time zone that is assigned to time entered for this shift. |
| Duration | <p>Displays the length of the punch in hours. You can enter it, or the system can calculate it when the next punch time is entered.</p> <p>If you change the time of a punch besides the last punch, the duration changes, based on the new and the subsequent punch time. If it's not the first punch, the previous punch's duration changes, based on the changed punch's new punch time.</p> <p>If you delete a row, the duration of the punch above the deleted row changes to the difference between the punch times of that row and of the row that followed the deleted row.</p> <p>The system warns you if a punch or flex shift is over 24 hours.</p> <p>The duration is displayed as a percentage of an hour.</p> <p>You can store a determined number of hours in this field when a shift is marked as an off-shift. This duration will be helpful in absence self service when calculating either absence end date or duration.</p> |

| Field or Control | Description |
|---|--|
| <p>Cfg1 to Cfg4 (schedule configuration)</p> | <p>These fields are populated based on check boxes that you select in the Shift Details group box. The corresponding Schedule Configuration Total fields are updated with the corresponding number of hours.</p> <p>For example, to have the system calculate how many hours in a shift are in the morning and how many in the afternoon, select Cfg1 for morning punches and Cfg 2 for afternoon punches.</p> <hr/> <p>Note: These fields are available for off days for flex and punch schedules used with the absence self-service duration calculation.</p> |

Workday Page

Use the Workday page (SCH_WRKDAY) to set up workdays.

Navigation:

Set Up HCM > Product Related > Global Payroll & Absence Mgmt > Schedules > Schedule Workdays > Workday

This example illustrates the fields and controls on the Workday page.

Workday

Set ID AUS01 Setid for AUS01 BU

Workday ID KA8HRDAY

Workday Information 1 of 1 | View All

*Effective Date

*Description Short Description

You use workdays to group shifts when creating a schedule definition. Enter an effective date and a description for the workday. The effective date of a workday must be earlier than or equal to the effective dates of the schedule definitions in which you use it.

Note: Setting up workdays is not a prerequisite for creating schedule definitions. You can define shift information that is not grouped by workday when you create schedule definitions.

Schedules - Definition Page

Use the Schedules - Definition page (SCH_DEFINITION) to define basic schedule definition details.

Navigation:

Set Up HCM > Product Related > Global Payroll & Absence Mgmt > Schedules > Definitions > Definition

This example illustrates the fields and controls on the Schedules - Definition page.

The screenshot shows the 'Definition' tab of the 'Schedules - Definition' page. At the top, it displays 'Set ID AUS01 Setid for AUS01 BU' and 'Schedule ID KA8HRELAPSED'. Below this is a 'Schedule Details' section with a search bar and navigation controls. The main form contains the following fields and controls:

- Effective Date:** 01/01/1980 (with a calendar icon)
- *Status:** Active (with '+' and '-' buttons)
- *Description:** 8 hour Elapsed
- Short Description:** 8 hour Ela
- *Definition Type:** Elapsed (dropdown menu)
- Days in Schedule:** 7
- Rotating Schedule
- *Daylight Saving Rule:** Fixed Time (dropdown menu)
- Country:** Brazil (with a flag icon)
- Work Shift type:** (dropdown menu)
- Shift Type Detail:** (text input field)
- Taskgroup for Time Reporting:** (section header)
- Default Taskgroup:** (text input with search icon)
- Task Template ID:** (text input)
- Time Reporting Template ID:** (text input with search icon)

| <i>Field or Control</i> | <i>Description</i> |
|-------------------------|--|
| Schedule ID | Displays the value that you entered to access this page. |

Schedule Details

| <i>Field or Control</i> | <i>Description</i> |
|-------------------------|---|
| Effective Date | Enter the first day of the schedule definition. For example, if the schedule begins on a Monday, make sure that the date you enter falls on a Monday. |

| Field or Control | Description |
|-----------------------------|--|
| Definition Type | <p>Select a type. Options are:</p> <p><i>Elapsed</i>: Only <i>Elapsed</i> shifts can be used in the definition.</p> <p><i>Punch</i>: Only <i>Punch</i> shifts can be used in the definition.</p> <p><i>Flex</i>: Only <i>Flex</i> shifts can be used in the definition.</p> <p>You cannot combine different types of shifts in the same definition.</p> <p>If you change this field in Add mode and shift detail rows are already entered, you're warned that shift detail rows are deleted if the type field is changed.</p> <p>When a schedule definition is saved as a particular type, such as <i>Elapsed</i>, it cannot be changed to another type, such as <i>Punch</i>.</p> |
| Rotating Schedule | <p>Select to indicate that this definition is for a rotating schedule. When you select this check box, the Rotation Details group box becomes available.</p> |
| Days in Schedule | <p>Enter the number of days in the schedule. You can change this at anytime. If you do make a change, the system automatically inserts or deletes the appropriate number of rows from the SCH_DEFN_DTL table to ensure that there is one row for each day in the schedule.</p> |
| Daylight Saving Rule | <p>This field applies to punch and flex schedules.</p> <p>Select the method that the system uses to resolve the schedule on days where daylight saving time changes fall within a shift.</p> <p><i>Fixed Time</i>: The system uses the specified out time that you enter even if it shortens or lengthens the shift by one hour.</p> <p><i>Fixed Duration</i>: The system adjusts the schedule to maintain the total duration that you specify for the shift.</p> |

(BRA) Brazil

| Field or Control | Description |
|--------------------------|---|
| Work Shift type | <p>Select an applicable type of work shift. Values are:</p> <p><i>Others</i></p> <p><i>Regular</i></p> <p><i>Regular Except Sunday Off</i></p> <p><i>Regular Periodic Sunday Off</i></p> <p><i>Regular Sunday Off</i></p> <p><i>Rotating Shift</i></p> <p><i>Scale of work 12x36</i></p> <p><i>Scale of work 24x72</i></p> <p><i>Uninterrupted Rotation Shift</i></p> <p>This data is used in eSocial reporting, for example, loading of employee information, hiring, and contract data updates of company employees).</p> |
| Shift Type Detail | <p>Enter a description for the selected work shift type. This is required if the selected work shift type is <i>Others</i>, <i>Rotating Shift</i>, or <i>Scale of work 24x72</i>.</p> |

Taskgroup for Time Reporting

This group box enables you to view the time reporting and task elements while you build the schedule definition. It appears only if you have Time and Labor installed.

| Field or Control | Description |
|--------------------------|--|
| Default Taskgroup | <p>Select a taskgroup. The system populates the Time Reporting Template ID field with the associated time reporting template.</p> <p>See “Understanding Task Reporting Requirements” (PeopleSoft Time and Labor).</p> |

| Field or Control | Description |
|-----------------------------------|---|
| Task Template ID | Displays the task template associated with the taskgroup you select. Click the link next to view details about the task template. See “Understanding Task Reporting Requirements” (PeopleSoft Time and Labor). |
| Time Reporting Template ID | The system populates this field with the time reporting template associated with the taskgroup you select. Click the link next to this field to view details about the time reporting template. See “Creating Time Reporting Templates” (PeopleSoft Time and Labor). |

The task template and the related time reporting template determine which task elements and time reporting elements appear as columns in the grid for scheduling purposes.

Rotation Details

Use this group box to determine the rotating pattern of the schedule. You create multiple rotation IDs that share the same schedule, but start on different days.

| Field or Control | Description |
|-------------------------|--|
| Rotation ID | Enter an ID for each rotation. |
| Relative Day | Enter the day that the rotation starts in relation to the first day of the schedule. For example, if you enter 8 in this field, the associated rotation begins 7 days after the first day. Note: You may not enter 0 or a number greater than the total number of days in the schedule |
| Add Rotations | Click to insert a new rotation. The system prompts you to enter the number of days between rotations to determine the relative day of the new rotation. |

Schedule Shifts Page

Use the Schedule Shifts page (SCH_DEFINITION_2) to define shifts for schedule definitions.

Navigation:

Set Up HCM > Product Related > Global Payroll & Absence Mgmt > Schedules > Definitions > Schedule Shifts

This example illustrates the fields and controls on the Schedule Shifts page: Shift Time tab.

Definition | **Schedule Shifts**

Set ID AUS01 Setid for AUS01 BU
Schedule ID KA8HRELAPSED

Schedule Details | 1 of 1 | View All

Effective Date 01/01/1980 Status Active
Description 8 hour Elapsed Total Hours 40.00
Taskgroup Show Calendar

Shift Details | 1-7 of 7 | View All

Shift Time | Configurable Totals |

| Select | Day | Workday ID | Shift ID | Off Shift | Sched Hrs | More |
|--------------------------|-----|------------|------------|-------------------------------------|-----------|------|
| <input type="checkbox"/> | 1 | KA8HRDAY | KA8ELAPSED | <input type="checkbox"/> | 8.00 | More |
| <input type="checkbox"/> | 2 | KA8HRDAY | KA8ELAPSED | <input type="checkbox"/> | 8.00 | More |
| <input type="checkbox"/> | 3 | KA8HRDAY | KA8ELAPSED | <input type="checkbox"/> | 8.00 | More |
| <input type="checkbox"/> | 4 | KA8HRDAY | KA8ELAPSED | <input type="checkbox"/> | 8.00 | More |
| <input type="checkbox"/> | 5 | OFF | OFF | <input checked="" type="checkbox"/> | 0.00 | More |
| <input type="checkbox"/> | 6 | OFF | OFF | <input checked="" type="checkbox"/> | 0.00 | More |
| <input type="checkbox"/> | 7 | KA8HRDAY | KA8ELAPSED | <input type="checkbox"/> | 8.00 | More |

Working with Shift Details

Select All Deselect All Copy Paste Clear Shifts

Days in Schedule 7

[Instructions](#)

You can use this page to define shift information for schedules in two ways:

- Using predefined workdays and shifts.

Use the **Workday ID** and **Shift ID** columns to select predefined workday and shifts. The system populates the remaining columns based on the shift you enter.

- Manually (for flex and punch schedules).

The type of schedule that you are defining determines the columns that appear in the Shift Details grid. For punch schedules, the system displays the default punch pattern and labels defined on the Schedule Settings page. To see all available punch types, select *All Punches* in the **Punch Pattern** field. For flex schedules, the system includes fields for In, Out, and Sched Hrs (scheduled hours). For elapsed schedules, it includes fields for identifying an off shift and scheduled hours.

To specify an off shift, you can select a predefined off shift, or select the Off Shift check box and enter an in and out time. When selected the system will deactivate the **More** link. It allows you to add duration hours for off days.

Click the **Show Calendar** link to view the schedule calendar that the system derives from the schedule definition.

Click the **More** link to access the Shift page where you can view or enter details for a shift.

See [Schedule Settings Page](#).

Copying, Pasting, and Clearing Shifts

Select the check box in the **Select** column. This makes the **Copy**, **Paste**, and **Clear Shifts** links available so that you can quickly copy, insert, and delete rows of workday and shift information.

See [Shift Page](#).

Configurable Totals

Select the Configurable Totals tab.

This example illustrates the fields and controls on the Schedule Shifts page: Configurable Totals tab.

The screenshot displays the 'Configurable Totals' tab within the 'Schedule Shifts' page. At the top, it shows the 'Definition' tab and the 'Schedule Shifts' sub-tab. Below this, it lists the Set ID (AUS01), Setid for AUS01 BU, and Schedule ID (KA8HRELAPSED). The 'Schedule Details' section includes the Effective Date (01/01/1980), Description (8 hour Elapsed), Taskgroup, Status (Active), and Total Hours (40.00). A 'Show Calendar' link is also present. The 'Shift Details' section features a table with the following columns: Select, Day, Workday ID, Shift ID, Cfg 1, Cfg 2, Cfg 3, Cfg 4, Total 1, Total 2, Total 3, Total 4, and a '+' button. The table contains seven rows of data for days 1 through 7. Below the table, the 'Working with Shift Details' section includes a 'Select All' checkbox (checked), 'Deselect All', 'Copy', 'Paste', and 'Clear Shifts' buttons. It also shows 'Days in Schedule' as 7 and an 'Instructions' link.

| Select | Day | Workday ID | Shift ID | Cfg 1 | Cfg 2 | Cfg 3 | Cfg 4 | Total 1 | Total 2 | Total 3 | Total 4 | |
|--------------------------|-----|------------|------------|--------------------------|--------------------------|--------------------------|--------------------------|---------|---------|---------|---------|---|
| <input type="checkbox"/> | 1 | KA8HRDAY | KA8ELAPSED | <input type="checkbox"/> | <input type="checkbox"/> | <input type="checkbox"/> | <input type="checkbox"/> | | | | | + |
| <input type="checkbox"/> | 2 | KA8HRDAY | KA8ELAPSED | <input type="checkbox"/> | <input type="checkbox"/> | <input type="checkbox"/> | <input type="checkbox"/> | | | | | + |
| <input type="checkbox"/> | 3 | KA8HRDAY | KA8ELAPSED | <input type="checkbox"/> | <input type="checkbox"/> | <input type="checkbox"/> | <input type="checkbox"/> | | | | | + |
| <input type="checkbox"/> | 4 | KA8HRDAY | KA8ELAPSED | <input type="checkbox"/> | <input type="checkbox"/> | <input type="checkbox"/> | <input type="checkbox"/> | | | | | + |
| <input type="checkbox"/> | 5 | OFF | OFF | <input type="checkbox"/> | <input type="checkbox"/> | <input type="checkbox"/> | <input type="checkbox"/> | | | | | + |
| <input type="checkbox"/> | 6 | OFF | OFF | <input type="checkbox"/> | <input type="checkbox"/> | <input type="checkbox"/> | <input type="checkbox"/> | | | | | + |
| <input type="checkbox"/> | 7 | KA8HRDAY | KA8ELAPSED | <input type="checkbox"/> | <input type="checkbox"/> | <input type="checkbox"/> | <input type="checkbox"/> | | | | | + |

This tab displays the total hours that are associated with each configuration indicator. You can use the configuration totals in absence rules.

Schedule Calendar Page

Use the Schedule Calendar page (SCH_CLND_VW_SEC) to view the schedule calendar derived from a specific schedule definition.

Navigation:

Click the **Show Calendar** link on the Schedule Shifts page.

This example illustrates the fields and controls on the Schedule Calendar page.

The screenshot shows the 'Schedule Calendar' page with the following details:

- Set ID:** AUS01, **Setid for AUS01 BU:** KA8HRELAPSED
- Schedule ID:** KA8HRELAPSED, **8 hour Elapsed**
- From Date:** 01/01/1980
- Workgroup:** (empty search field)
- Buttons: Load Calendar, Previous Period, Next Period
- Schedule Calendar Table:**

| Day | Date | Day Nbr | Workday ID | Shift ID | Sched Hrs | More |
|-----------|------------|---------|------------|------------|-----------|----------------------|
| Tuesday | 01/01/1980 | 1 | KA8HRDAY | KA8ELAPSED | 8.00 | More |
| Wednesday | 01/02/1980 | 2 | KA8HRDAY | KA8ELAPSED | 8.00 | More |
| Thursday | 01/03/1980 | 3 | KA8HRDAY | KA8ELAPSED | 8.00 | More |
| Friday | 01/04/1980 | 4 | KA8HRDAY | KA8ELAPSED | 8.00 | More |
| Saturday | 01/05/1980 | 5 | OFF | OFF | | More |
| Sunday | 01/06/1980 | 6 | OFF | OFF | | More |
| Monday | 01/07/1980 | 7 | KA8HRDAY | KA8ELAPSED | 8.00 | More |

This page enables you to view the schedule calendar that the system derives from a specific schedule definition.

| Field or Control | Description |
|-------------------------|--|
| From Date | Enter the starting date of the schedule calendar you want to view. By default this page displays the schedule calendar starting with the effective date of the associated schedule definition. |
| Rotation ID | Select the rotation ID for which you want to view a schedule calendar. This field appears only if there are rotation IDs defined for the schedule calendar. |
| Workgroup | Enter the workgroup for which you want to view a schedule calendar. This field is available only if Time and Labor is installed. |

| Field or Control | Description |
|-------------------------|--|
| Load Calendar | Click to view the schedule calendar for the selected date and workgroup. |
| Previous Period | Click to view the schedule calendar for the previous period. |
| Next Period | Click to view the schedule calendar for the next period. |

Validating Work Schedules

For punch type schedules, when a change is made to a shift, the related schedule(s) may need to be re-validated.

Page Used to Validate Schedules

| Page Name | Definition Name | Usage |
|---------------------------------------|------------------------|---|
| <u>Schedules to be Validated Page</u> | SCH_CLND_REFRESH | Validate a schedule after making a change to a shift. |

Schedules to be Validated Page

Use the Schedules to be Validated page (SCH_CLND_REFRESH) to validate a schedule after making a change to a shift.

Navigation:

Set Up HCM > Product Related > Global Payroll & Absence Mgmt > Schedules > Schedules to be Validated

This page contains a list of schedules that need validating because a related shift was modified for punch type schedules. The system displays a schedule ID, description and status for each schedule that needs validating.

Click the **Validate** button to validate the schedule or click the **Show Schedule** link to access the Schedule Definition page.

Defining Holiday Schedules

When you run the Absence Take process, the system refers to the payee's holiday schedule to determine if a reported absence occurred on a holiday.

By default, a payee inherits the holiday schedule for the pay group. You can assign a different holiday schedule to a payee using the Job Data - Payroll page.

Page Used to Define Holiday Schedules

| <i>Page Name</i> | <i>Definition Name</i> | <i>Usage</i> |
|-----------------------|------------------------|---------------------------|
| Holiday Schedule Page | HOLIDAY_SCHED_TBL | Define holiday schedules. |

Assigning Work Schedules

Pages Used to Assign Work Schedules

| <i>Page Name</i> | <i>Definition Name</i> | <i>Usage</i> |
|---|------------------------|---|
| Pay Group Name Page | GP_PYGRP_NAME | Assign a schedule group and a schedule to a pay group. |
| <u>Assign Work Schedule Page</u> | SCH_ASSIGN | Assign payees' long-term schedules or alternate schedules. |
| <u>Personal Schedule Definition - Definition Page</u> | SCH_DEFINITION | Define schedule definition details for a specific payee. |
| Personal Schedule Definition - Schedule Shifts Page | SCH_DEFINITION_2 | Define shift details for a specific payee. |
| <u>Schedule Calendar Page</u> | SCH_CALENDAR | Compare selected rotations to see what the pattern rotations look like as of the effective date of the schedule assignment. |

Understanding Work Schedule Assignment

After you create work schedules, you assign a schedule group and a schedule ID to each pay group using the Pay Group Name page. By default, a payee inherits the schedule group and work schedule that are associated with the payee's pay group. (Pay groups are assigned to payees using the Payroll page of the Job Information component.)

You can explicitly assign a schedule to a payee other than the pay group default using the Assign Work Schedules component (GP_SCH_ASSIGN). You can also use this component to assign an alternate schedule to a payee and access the Personal Schedule Definition component (SCH_DEFN_ADHOC) where you can define a personal schedule for the payee.

When you assign a schedule to a payee, the system deletes any workday overrides for that payee that are of a different type than the schedule assignment (for example, *Elapsed* instead of *Punch*) and that have a date later than or equal to the new assignment.

Managers can use self-service pages to assign schedules to payees and to change schedule assignments.

Note: For schedule assignment, the Workforce_Sync Message must be active on the PERSON_DATA queue, which comes with the PeopleSoft Integration Broker feature.

Assign Work Schedule Page

Use the Assign Work Schedule page (SCH_ASSIGN) to assign payees' long-term schedules or alternate schedules.

Navigation:

Global Payroll & Absence Mgmt > Payee Data > Create Overrides > Assign Work Schedule > Assign Work Schedule

This example illustrates the fields and controls on the Assign Work Schedule page.

Assign Work Schedule

Helen Grimes
Clerk-Shipping

Employee ID KA3007
Employment Record 0

Assign Schedules ? Personalize | Find | View All | First 1 of 1 Last

Primary Schedule | Alternate Schedule

| *Effective Date | *Assignment Method | Schedule Group | Schedule ID | Description | Rotation ID | Show Schedule |
|-----------------|----------------------------|----------------|-------------|------------------------|-------------|---------------|
| 01/01/2000 | Select Predefined Schedule | KAAUS | KA4WKROT | 4 Week Rotating Roster | TEAM 3 | Show Schedule |

View history of Schedule Assignments, including default changes

Primary Schedule Tab

| Field or Control | Description |
|-------------------|--|
| Assignment Method | <p>Select from the following options:</p> <ul style="list-style-type: none"> <i>Create Personal Schedule:</i> Select to create an effective-dated schedule for this payee. When you select this option, the Create Schedule link appears. <i>Select Predefined Schedule:</i> Select a schedule group and schedule ID to associate with the payee. <i>Use Default Schedule:</i> Select to assign the default schedule for the payee's pay group. |

| Field or Control | Description |
|-------------------------|---|
| Schedule Group | <p>If the assignment method is <i>Select Predefined Schedule</i> or <i>Create Personal Schedule</i>, select the schedule group to assign to the payee. Each schedule group is associated with a SetID that determines which schedules you can associate with the payee (if you are assigning a predefined schedule) or which predefined workdays and shifts you can use (if you are creating a personal schedule).</p> <p>If the assignment method is <i>Use Default Schedule</i>, the system displays the schedule group that the payee inherits from the pay group.</p> |
| Schedule ID | <p>If the assignment method is <i>Select Predefined Schedule</i>, select the schedule to assign to the payee.</p> <p>If the assignment method is <i>Use Default Schedule</i>, the system displays the schedule ID that the payee inherits from the pay group.</p> <p>If the assignment method is <i>Create Personal Schedule</i>, the system populates this field with the payee's employee ID and five zeros. For example, if the payee's employee ID is KA3007, the schedule ID is KA300700000.</p> |
| Rotation ID | <p>This field appears if the selected schedule is a rotating schedule. It is used to determine the relative day in the schedule to which the payee should be assigned.</p> |
| Show Schedule | <p>This link appears if the assignment method is <i>Use Default Schedule</i> or <i>Select Predefined Schedule</i>. Click to access the Schedule Calendar page where you can view the schedule as of the effective date of the schedule assignment. For rotating schedules, you can click a link on the Schedule Calendar page to compare rotations.</p> |
| Create Schedule | <p>This link appears if the assignment method is <i>Create Personal Schedule</i>. Click to access the Personal Schedule Definition component where you can define a schedule for this payee.</p> |

Alternate Schedule Tab

Select the Alternate Details tab.

This example illustrates the fields and controls on the Assign Work Schedule page: Alternate Schedule tab.

Assign Work Schedule

Helen Grimes
Clerk-Shipping

Employee ID KA3007
Employment Record 0

Assign Schedules ? Personalize | Find | View All | [Print] [Refresh] First 1 of 1 Last

Primary Schedule | **Alternate Schedule** [Switch]

| *Effective Date | *Assignment Method | Alt Schedule Group | Alternate Schedule ID | Description | Show Schedule |
|-----------------|----------------------|--------------------|-----------------------|-------------|-----------------------|
| 01/01/2000 | Use Default Schedule | | | | Show Schedule [+] [-] |

View history of Schedule Assignments, including default changes Personalize | Find | [Print] [Refresh] First 1 of 1 Last

Primary Assignment History | Alternate Assignment History [Switch]

| Effective Date | Assignment Method | Schedule Group | Schedule ID | Description | Rotation ID |
|----------------|---------------------|----------------|-------------|------------------------|-------------|
| 01/01/2000 | Predefined Schedule | KAAUS | KA4WKROT | 4 Week Rotating Roster | TEAM 3 |

Use this tab to assign an alternate schedule to a payee. The fields on this tab are similar to the fields on the Primary Details tab.

Viewing the History of Schedule Assignments

When you click the link to expand the history section of the page, the system displays all of the schedule assignments, including any changes to the default schedule assigned to the payee's pay group.

Personal Schedule Definition - Definition Page

Use the Personal Schedule Definition - Definition page (SCH_DEFINITION) to define schedule definition details for a specific payee.

Navigation:

From the Assign Work Schedule page, click the **Create Schedule** link (which is only visible when the assignment method is Create Personal Schedule).

Define the payee's schedule in the same way that you create a schedule definition. Personal schedules, however, cannot be rotating schedules.

Related Links

[Schedules - Definition Page](#)

Schedule Calendar Page

Use the Schedule Calendar page (SCH_CALENDAR) to compare selected rotations to see what the pattern rotations look like as of the effective date of the schedule assignment.

Navigation:

From the Assign Work Schedule page, click the **Show Schedule** link for a rotating schedule to access the Schedule Calendar page. (The **Show Schedule** link appears when the assignment method is Use Default Schedule or Use Predefined Schedule.) Click the **Compare Rotations** link on the Schedule Calendar page.

This example illustrates the fields and controls on the Schedule Calendar page.

Schedule Calendar

Set ID AUS01 Setid for AUS01 BU
 Schedule ID KA8HRELAPSED 8 hour Elapsed

From Date
 Workgroup

Load Calendar
Previous Period
Next Period

Schedule Calendar Personalize | Find | | First 1-7 of 7 Last

Shift Time | Configurable Totals

| Day | Date | Day Nbr | Workday ID | Shift ID | Sched Hrs | More |
|-----------|------------|---------|------------|------------|-----------|----------------------|
| Tuesday | 01/01/1980 | 1 | KA8HRDAY | KA8ELAPSED | 8.00 | More |
| Wednesday | 01/02/1980 | 2 | KA8HRDAY | KA8ELAPSED | 8.00 | More |
| Thursday | 01/03/1980 | 3 | KA8HRDAY | KA8ELAPSED | 8.00 | More |
| Friday | 01/04/1980 | 4 | KA8HRDAY | KA8ELAPSED | 8.00 | More |
| Saturday | 01/05/1980 | 5 | OFF | OFF | | More |
| Sunday | 01/06/1980 | 6 | OFF | OFF | | More |
| Monday | 01/07/1980 | 7 | KA8HRDAY | KA8ELAPSED | 8.00 | More |

The displayed schedule pattern is the length of the actual schedule. For example, if the schedule is 28 days, that is the actual pattern that displays.

| <i>Field or Control</i> | <i>Description</i> |
|--------------------------|---|
| Compare Rotations | Click to select the rotations to compare. The system displays a list of the rotation IDs that are associated with the schedule. Select those that you want to compare and click the Load Rotations button. |

Using Self-Service Scheduling Features for Managers

Managers can use self-service pages in Absence Management to assign, view, change, and override work schedules. In addition to viewing coverage, assigned shifts, and total work hours, managers can find replacements, swap shifts, copy schedules, and make short- and long-term schedule changes.

Pages Used to Manage Schedules

| <i>Page Name</i> | <i>Definition Name</i> | <i>Usage</i> |
|------------------------------|---|--|
| <u>Weekly Schedules Page</u> | SCH_MNG_DAILY SCH_MNG_WEEKLY SCH_MNG_DRANGE | View a payees' schedule and access linked pages to update schedules. |

| Page Name | Definition Name | Usage |
|--|------------------------|---|
| <u>Schedule Detail for <Date> Page</u> | SCH_MNG_DAILY_DTL | View details for a given shift and override shift information. |
| <u>Manage Schedule Options Page</u> | SCH_MNG_OPTIONS | Define default settings for the Manage Schedules page. |
| Schedule Preferences Page | SCH_EE_PREF | View an employee's contact and schedule preferences. This page is used in additional ways. |
| <u>Find Replacements Page</u> | SCH_MNG_REPLACE | Find a replacement for an employee. |
| <u>Copy Schedules Page</u> | SCH_MNG_COPY | Copy an employee schedule to be used by another employee. |
| <u>Swap Schedules Page</u> | SCH_MNG_SWAP | Swap two employees' schedules. |
| <u>Assign Work Schedule Page</u> | SCH_ASSIGN | Assign payees' long-term schedules or alternate schedules. |

Weekly Schedules Page

Use the Weekly Schedules page (SCH_MNG_WEEKLY) to view a payees' schedule and access linked pages to update schedules.

Navigation:

Manager Self Service > Time Management > Manage Schedules > Manage Schedules > Weekly Schedules

This example illustrates the fields and controls on the Weekly Schedules page (1 of 3).

Weekly Schedules

Employee Selection

Employee Selection Criteria

| Description | Time Reporter Group |
|----------------------------|---------------------|
| Time Reporter Group | GXABS |
| Employee ID | |
| Empl Record | |
| Last Name | |
| First Name | |
| Business Unit | |
| Job Code | |
| Job Description | |
| Department | |
| Supervisor ID | |
| Reports To Position Number | |
| Location Code | |
| Company | |
| North American Pay Group | |
| Global Payroll Pay Group | |

This example illustrates the fields and controls on the Weekly Schedules page (2 of 3).

Instructions

Date and Schedule Selection

*View By: Week

Date: 12/15/2013

Schedule Group: *Schedule Type: Primary

Employees For Betty Locherty

Schedule Detail | Demographics

| Select | Last Name | First Name | Employee ID | Empl Record | Job Title | Sunday 12/15/13 | Monday 12/16/13 | Tuesday 12/17/13 | Wednesday 12/18/13 | Thursday 12/19/13 | Friday 12/20/13 | Saturday 12/21/13 |
|--------------------------|-----------|------------|-------------|-------------|-----------------|--|--|---------------------|-----------------------|----------------------|--------------------|--|
| <input type="checkbox"/> | Hicks | John | GXEEABS2 | | 0 GX JOB CODE 5 | 7 Hours GXSH7HRS 8:00 AM-4:00 PM | 7 Hours GXSH7HRS 8:00 AM-4:00 PM | 0 Hours OFF | 0 Hours OFF | 0 Hours OFF | 0 Hours OFF | 7 Hours GXSH7HRS 8:00 AM-4:00 PM |

This example illustrates the fields and controls on the Weekly Schedules page (3 of 3).

Schedule Actions

Legend

| | | | |
|-------------------|------------------------------|----------------------------|-----------------------------|
| Approved Training | Planned Absence | Holiday | Multiple Shifts |
| Crossover Shift | Scheduled OFF Day OFF | Replaced Employee R | Shift has changing elements |

Schedule Display Options

[Assign Work Schedules](#)
[Manager Self Service](#)
[Time Management](#)

When you access this page, the system displays either the Daily, Weekly, or Date Range Schedules pages, depending on the default set on the Manage Schedules View Options page.

Enter values in Employee Selection Criteria and click the **Get Employees** button to filter the list of payees that requires changes or review. Fields for Workgroup and Taskgroup apply only if Time and Labor is installed. The North American Pay Group field applies only if Payroll for North America is installed; the Global Payroll Pay Group field does not apply.

| Field or Control | Description |
|-------------------------|---|
| View By | Select <i>Day</i> , <i>Week</i> , or <i>Date Range</i> to view the listed payees and their schedules using the time period chosen. The value that you select here determines the labels that appear on various links and date fields. <ul style="list-style-type: none"> If you select <i>Day</i>, you can also enter the start time and end time. If you select <i>Date Range</i>, the maximum number of days the date range can span is 31. |
| Schedule Type | Values are <i>Primary</i> or <i>Alternate</i> . |
| Coverage | This field appears only if you view by day. Options are <i>Scheduled</i> and <i>Unscheduled</i> . |
| Refresh | Click to refresh the page after selecting viewing preferences. |

Employees for <Manager Name>

The system lists the payees that meet your selection criteria.

| Field or Control | Description |
|-------------------------|---|
| Select | This field works with the schedule action fields. |
| Last Name | Click the employee's last name to access the Schedule Preferences page where you can view the employee's schedule preferences before making scheduling changes. |
| <x Hours> | Click this link to access the Daily Details page for a given shift to view the shift details or override the shift. |

Schedule Actions

The schedule actions of Schedule Replacements, Swap Schedules, and Copy Schedules are audited.

| Field or Control | Description |
|------------------------------|--|
| Schedule Replacements | To find a replacement for this payee, select the payee and click the Replacements button. |
| Copy Schedules | To copy this payee's schedule, select the payee and click the Copy Schedules button. The Copy Schedules page opens so that you can specify which payees are to inherit the copied schedule. |
| Swap Schedules | To swap two payees' schedules, select the two payees and click the Swap Schedules button. |

Legend

Events such as approved training, planned absence, and holiday are denoted on the schedule with buttons. A crossover shift indicates a shift that continues past midnight. Approved training can be designated only if Time and Labor is installed.

If a day has multiple shifts, the first shift information appears along with the multiple shifts button. The second shift and its details appear on the Daily Details for <date> page.

Note: To have the system display buttons for approved training, planned absences, holidays, and no shows, you must select these options on the Manage Schedules View Options page.

Schedule Detail for <Date> Page

Use the Schedule Detail for <date> page (SCH_MNG_DAILY_DTL) to view details for a given shift and override shift information.

Navigation:

Click the <x> **Hours** link on the Manage Schedules page.

This example illustrates the fields and controls on the Schedule Detail for <date> page.

Schedule Detail for 12/15/2013

John Hicks Employee ID GXEEABS62
Employment Record Number 0

Job Title GX.JOB CODE 5

Instructions

Refresh Schedule

*Schedule Type *Punch Pattern Default Taskgroup

(Existing schedule will be cleared and refreshed based on the above selections.)

Primary Schedule

Schedule Detail

| Shift ID | Taskgroup | Off Shift | In | Meal | In | Out | Time Zone | Sched Hrs | More |
|----------|-----------|--------------------------|-----------|------------|-----------|-----------|-----------|-----------|------|
| GXSH7HRS | | <input type="checkbox"/> | 8:00:00AM | 12:00:00PM | 1:00:00PM | 4:00:00PM | | 7.00 | More |

Alternate Schedule

No schedule data for today

Training Details

No training data for today

Absence Details

No absence data for today

Holiday Details

No holiday data for today

[Return to Manage Schedules](#)

Manage Schedule Options Page

Use the Manage Schedule Options page (SCH_MNG_OPTIONS) to define default settings for the Manage Schedules page.

Navigation:

Manager Self Service > Time Management > Manage Schedules > Manage Schedules

Click the **Schedule Display Options** link at the bottom of the page.

This example illustrates the fields and controls on the Manage Schedules Options page.





Manage Schedule Options

Start Day for Weekly Grid

Default Display View

Maximum Rows Displayed

Schedule Categories

| Select | Symbol |
|---|---|
| <input checked="" type="checkbox"/> Approved Training |  |
| <input checked="" type="checkbox"/> Planned Absence |  |
| <input checked="" type="checkbox"/> Holiday |  |
| <input checked="" type="checkbox"/> No Show |  |

Weekly/Date Range Options

Select one option for display on Weekly and Date Range Pages

Task Data Task Element

Time Reporting Elements Time Element

Use this page to define default settings for the Manage Schedules page.

| Field or Control | Description |
|----------------------------------|---|
| Start day for Weekly Grid | Select the day of the week that is to appear first in the scheduling grid. |
| Default Display View | Select <i>Date Range</i> , <i>Day</i> , or <i>Week</i> to have the system display the daily, weekly, or date range pages when you access the Manage Schedules page. |
| Maximum Rows Displayed | Enter the maximum number of payees to display on each page. |

Schedule Categories

Select the types of events you want the system to mark on the schedule. The system displays the corresponding symbol on the relevant day.

Approved training applies only if Time and Labor is installed. In this case, the system can identify training days that are recorded in PeopleSoft Learning Management and HR: Manage Training.

Planned absences represent requested and approved absences (from the GP_ABS_EVENT table). If Time and Labor is installed, planned absences also include leaves of absence for Base Benefits customers.

No show information applies to payees with a punch schedule and can be reported only if Time and Labor is installed. The *No Shows* value only displays for the Daily Schedules page. *No Shows* information is stored, so any *No Shows* information from the past can be viewed.

Weekly/Date Range Options

If Time and Labor is installed, you can display one type of task data and one time reporting element on the weekly or date range pages.

Find Replacements Page

Access the Find Replacements page (SCH_MNG_REPLACE) to find a replacement for an employee.

Navigation:

Manager Self Service > Time Management > Manage Schedules

Select a payee and click the Find Replacements button.

This page lists all payees who are not scheduled for the shift or time range for which you need a replacement. It excludes payees for whom an absence has been entered. If Time and Labor is installed, it can also exclude payees who are scheduled for training.

Using the replacement feature is appropriate when you want to replace an absent payee with another payee who is not already scheduled to work during that time period.

Select the employee who will act as a replacement and click the **Replace** button. The system displays an *R* next to the replaced employee in the daily cell on the Manage Schedules pages (day, week or date range).

The person who is replacing the employee inherits the schedule. The replaced employee retains the original schedule for appropriate payment if the employee reports an absence for that day.

If you need to undo the replacement, click the View Daily Details link in the cell for the replaced employee (the cell that displays the *R*). Click the **Undo Replacement** button and then click OK.

Copy Schedules Page

Use the Copy Schedules page (SCH_MNG_COPY) to copy an employee schedule to be used by another employee.

Navigation:

Manager Self Service > Time Management > Manage Schedules

Select a payee and click the **Copy Schedules** button.

Select one or more employees who are to receive the copied schedule and click the **Copy** button. The whole day is copied for the date or range of dates defined.

Note: If you selected *Day* as the View By option on the Manage Schedules page, the **Date** field is display only.

Swap Schedules Page

Use the Swap Schedules page (SCH_MNG_SWAP) to swap two employees' schedules.

Navigation:

Manager Self Service > Time Management > Manage Schedules

Select a payee and click the **Swap Schedules** button.

Change the start date and end date if required and click the **Swap** button. The whole day's schedule is swapped between the two employees, or all the days listed if it is a range of dates.

Important! Avoid using the swap feature to replace an absent payee. If you use the swap feature, and the payee reports an absence, the payee may not be correctly compensated for the absence. This is because the absence process refers to the swapped schedule (which might be for an off shift or different shift), rather than the payee's actual schedule, to determine the amount of time off.

Note: If you selected the *Day View By* option, the **Date** field on this page is display only.

Assign Work Schedule Page

Use the Assign Work Schedule page (SCH_ASSIGN) assign long-term schedules or alternate schedules.

Navigation:

Global Payroll & Absence Mgmt > Payee Data > Create Overrides > Assign Work Schedule > Assign Work Schedule

You can use this page to assign work schedules to a payee and to access pages for viewing assigned schedules and for creating a schedule for a particular payee. These pages are the same as the pages that administrators use to assign schedules and create personal schedules.

Related Links

[Assigning Work Schedules](#)

Using Self-Service Scheduling Features for Employees

Employees can use self-service pages in Absence Management to enter their schedule preferences, such as preferred contact information for schedule updates, willingness to work a compressed work week, and daily shift preferences. When a manager wants to replace, swap, or copy a schedule, the employee preferences can be viewed to determine the best available replacement or schedule.

Pages Used to Enter Scheduling Preferences and View Schedules

| <i>Page Name</i> | <i>Definition Name</i> | <i>Usage</i> |
|---|------------------------|--|
| Schedule Preferences Page | SCH_EE_PREF | Enables employees to view and update their schedule related preferences. |

| Page Name | Definition Name | Usage |
|---------------------------|-------------------------------|--|
| Personal Information Page | HR_EE_PERS_INFO | View contact information and access pages where you can update it. |
| Monthly Schedule Page | SCH_EE_MONTHLY SCH_EE_PREF | Enables employees to view their schedules. |

Schedule Preferences Page

Use the Schedule Preferences page (SCH_EE_PREF) to enables employees to view and update their schedule related preferences.

Navigation:

Self Service > Time Reporting > User Preferences > Schedule Preferences

Contact Preference

The employee's preferred phone number and email address appear. If PeopleSoft eProfile is installed, you can click a link to access the Personal Information page, where you can update the contact information.

Schedule Preferences

For each day of the week, enter the shift or start and end times you prefer to work.

| Field or Control | Description |
|--|--|
| Willing to work a compressed work week | Define whether or not you will work a compressed work week. |
| Shift | <p>Enter the shift you prefer to work. This field is populated based on the employee ID. If the current user has a schedule assigned, the only shifts available in the drop-down list box are those shifts that correspond to the user's schedule ID and the SetID determined by the user's schedule group. If the user has no schedule assigned, the Shift ID field is hidden.</p> <hr/> <p>Note: There is no validation between start and end times and shifts. No logic exists to verify that the times entered fall within the shift, if one is entered.</p> <hr/> |
| Start Time, End Time | Enter the start and end times you prefer to work. |
| Willing to work overtime | Enter whether you will work overtime. |

| <i>Field or Control</i> | <i>Description</i> |
|--------------------------------|---|
| Willing to work double shifts | Enter whether you will work a double shift. |

Defining the Organizational Structure

Understanding the Organizational Structure

This diagram shows the components of the Absence Management organizational structure for absence processing.

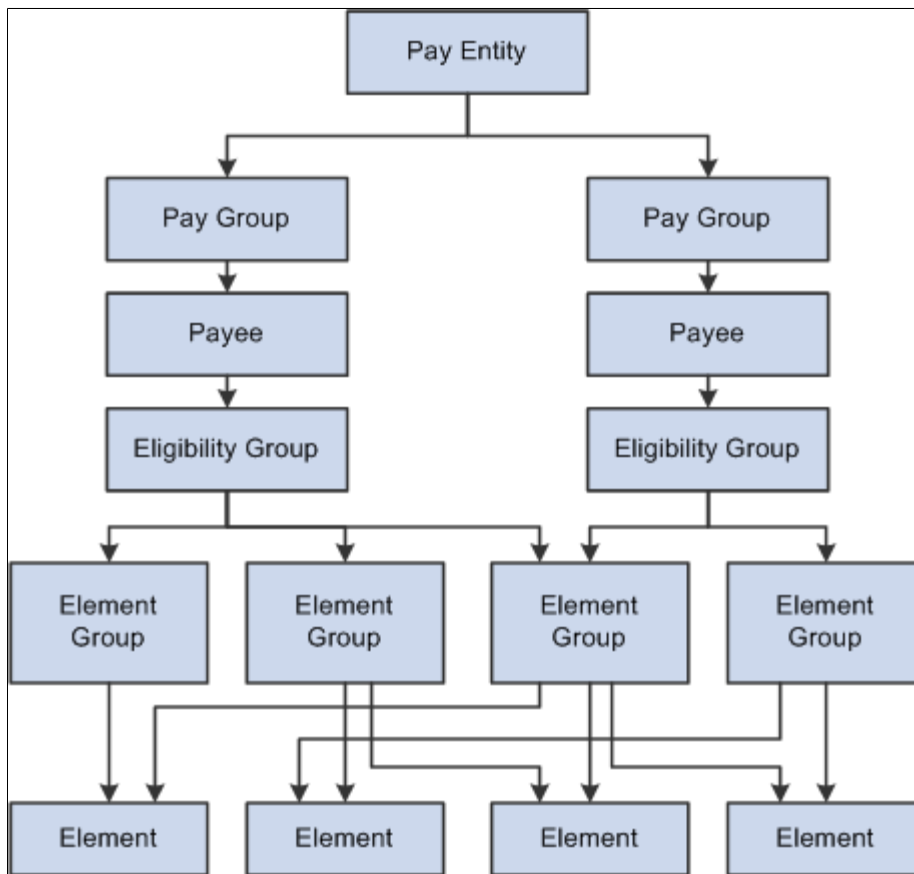

Elements are the basic building blocks of Absence Management. Element groups are used to communicate lists of elements to eligibility groups. Eligibility groups are associated with pay groups. Payees who share absence characteristics belong to pay groups. Multiple pay groups are linked to a single pay entity, the business organization that pays payees.

Eligibility groups and element groups are used to control which elements a payee receives. Element Groups contain individual elements such as , absence entitlements and absence takes. Eligibility Groups in turn contain Element Groups. This two-level approach allows for a more efficient set up; for example, you can assign each payee to an eligibility group, such as one for managers, and another for staff employees.

Defining Element Groups

Pages Used to Define Element Groups

| <i>Page Name</i> | <i>Definition Name</i> | <i>Usage</i> |
|--|------------------------|---|
| Element Group Name Page | GP_PIN | Name the element group and define its basic parameters. |
| Element Group Members Page | GP_ELEMENT_GROUP | Insert elements into element groups. |

Understanding Element Groups

To identify numerous elements you can define element groups, such as one for absence take elements, and another for absence entitlement elements. You can use element groups to:

- Assign the same set of elements to a group of payees.

For example, you might group absence entitlement elements into one element group, and absence take elements into another and use only those two element group names to specify absence elements.

- Create list sets.

A list set is a collection of elements and parameters that you can use in any process or report that requires a list of elements.

Related Links

[Understanding Off-Cycle Processing](#)

Element Group Name Page

Use the Element Group Name page (GP_PIN) to name the element group and define its basic parameters.

Navigation:

Set Up HCM > Product Related > Global Payroll & Absence Mgmt > Elements > Element Groups > Element Group Name

You name every element and define its basic parameters on an Element Name page. All element components within Absence Management share the same first Element Name page (GP_PIN).

Related Links

[Defining Element Names](#)

Element Group Members Page

Use the Element Group Members page (GP_ELEMENT_GROUP) to insert elements into element groups.

Navigation:

Set Up HCM > Product Related > Global Payroll & Absence Mgmt > Elements > Element Groups > Element Group Members

This example illustrates the fields and controls on the Element Group Members page.

Element Group Name
Element Group Members

Element Name K0WEG ABSENCE
Absence Element Group
Owner PS Non-Mnt

Definition Find | View All | First 1 of 1 Last

*Effective Date

*Status

*Element Group Use

Element Group Members Personalize | Find | View All | | | First 1-5 of 20 Last

| Element Type | Element Name | Description | Eligibility Assignment | Application Default Sort Seq | | |
|--------------|-------------------|-------------|------------------------|------------------------------|----------------------------------|----------------------------------|
| Abs Entitl | K0WAE SICK | Sick | By Eligibility Group | 1 | <input type="button" value="+"/> | <input type="button" value="-"/> |
| Abs Take | K0WAT BEREAV TAKE | Bereavement | By Eligibility Group | 2 | <input type="button" value="+"/> | <input type="button" value="-"/> |
| Abs Take | K0WAT SICK TAKE | Sick Take | By Eligibility Group | 3 | <input type="button" value="+"/> | <input type="button" value="-"/> |
| Abs Take | K0WAT JURY TAKE | Jury | By Eligibility Group | 4 | <input type="button" value="+"/> | <input type="button" value="-"/> |
| Abs Take | K0WAT TL-PTO | TL_PTO | By Eligibility Group | 5 | <input type="button" value="+"/> | <input type="button" value="-"/> |

Version

Use caution when making changes to element groups that are referenced by list sets. Changes to element groups affect related list sets. For more information about list sets, their use, and their relationship to element groups, see [Understanding Applications and List Sets](#).

| Field or Control | Description |
|--------------------------|--|
| Element Group Use | <p>Define the way that this element group will be used. This field limits the entry types available in the Element Group Members group box. Values are:</p> <ul style="list-style-type: none"> • <i>All-purpose</i>: Select if this element group can be used for eligibility processing, to define a process set for off-cycle processing, or with list set functionality. • <i>Eligibility</i>: This is the default value. Select if this element group is to be used only for eligibility processing. • <i>Process Set</i>: Select if this element group identifies a limited set of elements to be processed for a given segment. This type of element group is available for off-cycle processing. The inclusion of an element in this group does not waive eligibility requirements; payees must still be eligible for these elements for the elements to be resolved. • <i>Application</i>: Select to use this element group specifically with the list set functionality. Selecting this value will avail the Applications - Static/Dynamic group box and the Application Default Sort Order field. <hr/> <p>Note: The system requires that the Element Group Use field value be the same for <i>multiple</i> effective-dated rows. Therefore, if you add a second effective-dated row to this page, the system populates the new effective-dated row's Element Group Use field by default to the value on the original or earliest effective-dated row, and makes the Element Group Use fields unavailable for entry on all effective-dated rows. So, as long as there's only one row, you can edit the Element Group Use field value. When you insert more than one row, all rows will have the same Element Group Use field value (the value of the original or earliest effective-dated row) and all rows will have the Element Group Use field unavailable for entry.</p> |

Applications - Static/Dynamic

Select whether the element group is a static or dynamic list of elements. Static element groups include a list of elements in the Element Group Members group box. Dynamic element groups include only a SQL Where clause - **Dynamic Selection Criteria** field - that dynamically determines which elements are included in the group every time the element group is called. The Where clause can also contain an Order By clause to sort the selected elements. This option is only available when **Element Group Use** is *Application*.

Element Group Members

| <i>Field or Control</i> | <i>Description</i> |
|---------------------------------------|---|
| Element Type | <p>Select the type of element that you're adding to the element group. Values are <i>Absence Entitlement</i>, <i>Absence Take</i>, <i>Deduction</i>, <i>Earnings</i>, and <i>Element Group</i>.</p> <hr/> <p>Note: When nesting element groups (that is, including element groups within element groups), the member groups must have the same use option as the parent group.</p> <hr/> |
| Element Name | Select the element name that corresponds to the entry type selected. |
| Description | Click to open the element's definition component in a separate browser window. |
| Eligibility Assignment | <p>Select the method for assigning the selected element to a payee. This field enables you to indicate whether a payee gets the element processed simply by inclusion in the eligibility group or whether you have to assign the element via the payee-level Earnings/Deductions Assignment page or enter positive input. This field is only available when Group Use Type is <i>Eligibility</i> or <i>All-Purpose</i>.</p> <p>Values are:</p> <p><i>By Eligibility Group:</i> For elements that apply to most or all payees who are associated with this element group via an eligibility group.</p> <p><i>By Payee:</i> For payee-level elements.</p> <p>This field is hidden when you select <i>Process Set</i> for the element group use. It is also hidden when the entry type is <i>Element Group</i>.</p> |
| Application Default Sort Order | Enter the sequence number used to sort the element. To display multiple elements on the same line, use the same sequence number. This field is only available when Group Use Type is <i>Application</i> or <i>All-Purpose</i> . |

Changing the Element Group Use Field

When needed, you can change the **Element Group Use** value after you have created the element group. When the field value is changed, the system conducts the following checks:

- If the field value is *Eligibility* or *Process Set* and the element group is being used in that specific area, the system will only allow a change to *All-purpose*.
- If the field value is *Eligibility* or *Process Set* and the element group is not being used in that specific area, the system will allow any change.
- If the field value is *All-purpose*, the system will only allow a change if it does not alter any current usage (that is, the system will not allow a change to *Eligibility* if the Element Group is used to define a process set).

Defining Eligibility Groups

Page Used to Define Eligibility Groups

| <i>Page Name</i> | <i>Definition Name</i> | <i>Usage</i> |
|--------------------------------|------------------------|--|
| <u>Eligibility Groups Page</u> | GP_ELIG_GROUP | Insert element groups into eligibility groups. |

Understanding Eligibility Groups

Eligibility groups indicate the specific elements for which a certain payee population may be eligible. Eligibility groups contain one or more element groups and are often used to differentiate types or levels of workers. For example, you can create an eligibility group of element groups pertaining to company executives.

You assign a default eligibility group to each pay group. Payees assigned to a pay group inherit the eligibility group from the pay group definition. You can override a pay group definition by payee by stating a different eligibility group at the payee level.

Eligibility Groups Page

Use the Eligibility Groups page (GP_ELIG_GROUP) to insert element groups into eligibility groups.

Navigation:

Set Up HCM > Product Related > Global Payroll & Absence Mgmt > Framework > Organizational > Eligibility Groups > Eligibility Groups

This example illustrates the fields and controls on the Eligibility Groups page.

The screenshot shows the 'Eligibility Groups' page for 'KOWEL ABS'. The 'Definition' section includes fields for '*Effective Date' (01/01/1990), '*Status' (Active), '*Description' (Absence Eligibility Group), and 'Short Description' (Absence). The 'Eligibility Group Members' section lists two members: 'KOWEG ABSENCE' (Absence Element Group) and 'KOWEG VACATIONS' (Vacations Element Group).

| <i>Field or Control</i> | <i>Description</i> |
|-------------------------|--|
| Element Name | Select the name of the element group to associate with this eligibility group. To select additional element groups, add more rows. |

Defining Pay Entities

Note: This topic discusses the first two pages of the Pay Entity component. The other pages in the Pay Entity component, including the Retro Limits page and the Supporting Elements Override page are discussed elsewhere in this documentation.

Pages Used to Define Pay Entities

| <i>Page Name</i> | <i>Definition Name</i> | <i>Usage</i> |
|---|------------------------|---|
| Pay Entity Address Page | GP_PYENT_NAME | Enter address information for a pay entity. |
| Processing Details Page | GP_PYENT_PRCES_DTL | Enter processing details for a pay entity. |

Related Links

[Setting Backward and Forward Retro Limits](#)

[Defining Pay Entity Overrides](#)

Understanding Pay Entities

A pay entity is the organization that is responsible for paying payees. You can also use a pay entity to define the type of currency for processing calculations. The pay entity is a legal definition of an organization from a absence and payroll perspective. In many cases, an organization and a pay entity are

identical. Absence Management doesn't define a relationship between an organization and a pay entity. If several organizations are held by the same holding organization, the holding organization can be the pay entity, or one organization can have several subsidiaries that are individual pay entities. The system defines most accumulators by pay entity.

Batch Processing

Batch processing uses the data on the Processing Details page to determine which elements to load. Only elements that are defined for *All Countries* (on the Element Name page) and those defined for *Specific Country*, where the country equals the pay entity country are loaded.

If any element with a different country has been referenced, the batch program logs an error. Depending on that element's importance, the process might cease. If it cannot continue, it issues the following message:

Element %1 (PIN %2) not loaded into UPINA. (N/A for country: %3).

If the process can continue, it issues one of these messages:

Element %1 (PIN %2) - and data for the element - not loaded into the process. (N/A for country: %3)

Element %1 of parent element %2 on Process List %3 is not found in %4. (PIN number %5)

Note: Reasons other than country assignment can prevent an element from being loaded.

Pay Entity Address Page

Use the Pay Entity Address page (GP_PYENT_NAME) to enter address information for a pay entity.

Navigation:

Set Up HCM > Product Related > Global Payroll & Absence Mgmt > Framework > Organizational > Pay Entities > Pay Entity Address

This example illustrates the fields and controls on the Pay Entity Address page.

The screenshot displays the 'Pay Entity Address' page with the following details:

- Pay Entity:** K0WPE ABS1
- *Description:** Absence Pay Entity
- Short Description:** Absence Pa
- Definition:** Find | View All | First | 1 of 1 | Last
- *Effective Date:** 01/01/1990
- *Status:** Active
- Country:** CYM (Cayman Islands)
- Address:** (Field is empty)
- Buttons:** Edit Address

| Field or Control | Description |
|-------------------------|--|
| Country | Select the country where your pay entity is located. |
| Address | Click the Edit Address link to enter the pay entity address. The system displays the appropriate address fields for the selected country. Address information fields aren't required; therefore, you can enter only the information that applies to your organization's pay entity. Leave other fields blank. |

Processing Details Page

Use the Processing Details page (GP_PYENT_PRCS_DTL) to enter processing details for a pay entity.

Navigation:

Set Up HCM > Product Related > Global Payroll & Absence Mgmt > Framework > Organizational > Pay Entities > Processing Details

This example illustrates the fields and controls on the Processing Details page.

The screenshot displays the 'Processing Details' page for a pay entity named 'K0WPE ABS1 Absence Pay Entity'. The page is organized into several sections:

- Period Definition:** Includes fields for *Calendar Yearly Start Month (January), *Calendar Yearly Start Day (1), *Fiscal Yearly Start Month (January), and *Fiscal Yearly Start Day (1).
- Payment & Information:** Includes fields for Payment Key 1, 2, 3, and 4, and *Source Bank ID (K0SBBK1) with a search icon and label 'Banking - Source Bank 1'.
- Processing Assignment:** Shows Effective Date (01/01/1990) and Status (Active). It includes a 'Find | View All' search bar and pagination (First 1 of 1 Last).
- Processing Currency:** Includes *Currency Code (USD) with a search icon and label 'US Dollar'. It also has radio buttons for 'No Rounding' (selected) and 'Use Specified Rounding', with a 'Rounding Rule Element' field below.

At the bottom of the page, there is a checkbox labeled 'Allow Eligibility Override Using Positive Input'.

Warning! Do not modify fields above the effective-dated area of the page after implementation. Doing so can destroy the integrity of retroactive and accumulator calculations.

| <i>Field or Control</i> | <i>Description</i> |
|-------------------------|--|
| Country | Select the processing country for this pay entity. |

Period Definition

| <i>Field or Control</i> | <i>Description</i> |
|--|--|
| Calendar Yearly Start Month and Calendar Yearly Start Day | Enter the start date for the pay entity's calendar year. This date becomes the default start date for accumulators that are based on calendar year, unless you specify otherwise in the accumulator definition. |
| Fiscal Yearly Start Month and Fiscal Yearly Start Day | If your pay entity operates on a fiscal year that's different from the calendar year, enter the start date of the fiscal year. This date is used as the default start date for accumulators that are based on fiscal year, unless you specify otherwise in the accumulator definition. |

Payment Information

| <i>Field or Control</i> | <i>Description</i> |
|-------------------------|--|
| Payment Key 1–4 | The Payment Key fields are not applicable to Absence Management. |
| Source Bank ID | This field is required. You must create a "dummy" Source Bank ID and enter it in this field. |

See “Understanding Bank and Bank Branch Setup” (Application Fundamentals).

Processing Currency

The processing currency defined at the pay entity level is the unit to which other currencies are converted before calculations are made.

| <i>Field or Control</i> | <i>Description</i> |
|-------------------------------|--|
| Currency Code | Select the default processing currency, which the system uses for calculations and reports and as the default for any element without an associated currency. Note: If the effective date changes during a pay period, the system uses the currency that's effective at the end of that pay period. Any change of currency should coincide with the beginning of a pay period. |
| No Rounding | Select to prevent rounding in currency conversion. |
| Use Specified Rounding | Select to have the system run a rounding rule for currency conversion, regardless of the value's source (for example, positive input, accumulators, or historical rules). |
| Rounding Rule Element | If you selected Use Specified Rounding , enter the rounding rule element that you want to use for rounding. |

Eligibility Override allowed via

| <i>Field or Control</i> | <i>Description</i> |
|-------------------------|---|
| Positive Input | This check box does not apply to Absence Management. The default setting for this check box is cleared. |

Related Links

[Understanding Retroactive Processing](#)

[Understanding the Core Application Architecture](#)

[Understanding Overrides](#)

Defining Pay Groups

Note: This topic discusses the first two pages of the Pay Group component. The other page in the Pay Group component is the Supporting Elements Override page which is discussed elsewhere in this documentation.

Pages Used to Define Pay Groups

| <i>Page Name</i> | <i>Definition Name</i> | <i>Usage</i> |
|----------------------------|------------------------|---|
| <u>Pay Group Name Page</u> | GP_PYGRP_NAME | Define pay group parameters. |
| <u>Defaults Page</u> | GP_PYGRP_DFLT | Define default rounding, proration, and frequency conditions for a pay group. |

Related Links

[Understanding Overrides](#)

Understanding Pay Groups

A pay group is a logical grouping of qualifying individuals for absence management and contains payees who share pay characteristics. All payees in a pay group must have the same absence calculation process and belong to the same pay entity.

Understanding Overrides of Pay Group Defaults

When you set up a pay group, you define a number of default settings, such as eligibility group and work schedules, that apply to payees associated with the pay group.

However, you can set up pay group rule overrides for absence elements, which is useful when certain rules don't apply to specific groups of payees.

Group together payees who typically receive the same type of absence elements. This enables you to define elements that apply to most members of a pay group. You can create any exceptions via payee-level overrides or override the default pay group.

Pay Group Name Page

Use the Pay Group Name page (GP_PYGRP_NAME) to define pay group parameters.

Navigation:

Set Up HCM > Product Related > Global Payroll & Absence Mgmt > Framework > Organizational > Pay Groups > Pay Group Name

This example illustrates the fields and controls on the Pay Group Name page.

Pay Group Name
Defaults
Supporting Element Overrides

Pay Group K0WPG P11

*Description Absence Management to PI Short Description AM PG-PI

*Pay Entity K0WPE ABS1 Absence Pay Entity Country Cayman Islands

Definition
Find | View All
First 1 of 1 Last

*Effective Date 01/01/1990 *Status Active

Payee Job Data Defaults

*Eligibility Group K0WEL ABS Absence Eligibility Group

*Exchange Rate Type OFFIC Official Rate

*Use Exchange Rate As Of Pay Period End Date

Payee Schedule Defaults

*Schedule Group K0CYM GP Core Schedule Group

*Schedule ID K0WRKSCH K0WRKSCH

Alternate Schedule Group

Alternate Schedule ID

*Holiday Schedule ID KU01 US Holiday Schedule

| Field or Control | Description |
|-------------------------|---|
| Pay Entity | Select the pay entity to associate with this pay group. You can link each pay group with only one pay entity. |

Warning! Once you've processed absences, never change the pay entity. Doing so can corrupt your data.

Payee Job Data Defaults

In this group box, you can define numerous default settings for a pay group. The effective date applies to the entire group box; therefore, you can change these options simultaneously if you have schedule, business process, or rule changes.

Note: Not every payee in a pay group has the same eligibility group, exchange rate type, or holiday schedule. You can override any default for an individual on the Job Data - Payroll page. Defaults can be overridden for certain periods of time through effective-dating. On the Job Data - Payroll page, the **Absence Management** group box that includes eligibility group and exchange rate type appears only if you set the Absence System field to *Absence Management*.

See [Understanding Overrides](#).

See “Understanding Job Data” (PeopleSoft Human Resources Administer Workforce).

| Field or Control | Description |
|--------------------------|---|
| Eligibility Group | <p>Select the default eligibility group to associate with this pay group.</p> <p>Apply elements to payees in pay groups via eligibility groups. An eligibility group must be associated with a pay group. A payee is assigned to an eligibility group through the default defined at the pay group level. This default value can be overridden at the payee level.</p> <hr/> <p>Note: Payees in an eligibility group are eligible for elements at the payee level, but if a payee isn't in an eligibility group for which an element is valid, that payee cannot be eligible for that element.</p> <hr/> |

| Field or Control | Description |
|---------------------------|---|
| Exchange Rate Type | Select the default exchange rate type that's used for currency conversions for this pay group during processing. You can specify an element in a currency other than the processing currency. During processing, it is converted to the processing currency, using this exchange rate information. Define exchange rate types on the Market Rate Type page. |
| Use Rate As Of | Select the effective date for use in retrieving the exchange rate. The options correspond to the dates that you associate with this pay group. Values are <i>Pay Period Begin Date</i> , <i>Pay Period End Date</i> , and <i>Payment Date</i> . |

Payee Schedule Defaults

Define scheduling defaults for a pay group. Payees can be assigned a work schedule and an alternate work schedule based on the scheduling defaults defined for the payee's pay group.

| Field or Control | Description |
|-------------------------|--|
| Schedule Group | Select the schedule group for the pay group. Schedule groups allow you to categorize schedules into specific groups. |
| Schedule ID | Select the schedule ID for the pay group. |

| Field or Control | Description |
|---------------------------------|--|
| Rotation ID | <p>Select the rotation ID for the selected the schedule ID. Rotation IDs are used with rotating schedules. Rotating schedules can be assigned to several payees with different schedule begin days.</p> <hr/> <p>Note: The Rotation ID field only appears if you select a rotating schedule.</p> |
| Alternate Schedule Group | (Optional) Select an alternate schedule group for the pay group. |
| Alternate Work Schedule | (Optional) Select an alternate work schedule. A payee can be associated with an alternate work schedule for some absences. |
| Alternate Rotation ID | <p>(Optional) Select an alternate rotation ID for the pay group.</p> <hr/> <p>Note: The Alternate Rotation ID field only appears if you select a rotating schedule.</p> |
| Holiday Schedule | Select the holiday schedule for the pay group. The pay group's holiday schedule is used in processing if you do not select a different holiday schedule for the payee on the Job Data - Payroll page. However, the pay group holiday schedule is not entered as a default on the payee's Job record. |

Related Links

[Defining Pay Entities](#)

[Proration and Segmentation](#)

[Defining Proration Rules](#)

[Understanding Work Schedules](#)

“Understanding Currency” (Application Fundamentals)

Defaults Page

Use the Defaults page (GP_PYGRP_DFLT) to define default rounding, proration, and frequency conditions for a pay group.

Navigation:

Set Up HCM > Product Related > Global Payroll & Absence Mgmt > Framework > Organizational > Pay Groups > Defaults

This example illustrates the fields and controls on the Defaults page.

Period Information

Define dates for your pay group's fiscal year.

| Field or Control | Description |
|---|--|
| Fiscal Year Start | Define the start date of your organization's fiscal year for this pay group. Values are: <i>Use Paying Entity Defaults:</i> The next two fields become unavailable. <i>Use Specified Start Date:</i> Complete the next two fields. |
| Start Month and Start Day | Enter the first month and the first day of the start month in your organization's fiscal year. |

Component Rounding Defaults

Specify default rounding rules for absence elements at the pay group level. You can specify rounding for individual absence elements when those elements are defined or direct the system to follow the pay group default settings.

| Field or Control | Description |
|---|--|
| Rounding Option - Base, Rounding Option - Unit, Rounding Option - Rate, Rounding Option - Percent and Rounding Option - Amount | <p>Select an option to determine whether these components of an entitlement element can be rounded before calculation. Values are:</p> <p><i>No Rounding:</i> Prevents rounding of the component.</p> <p><i>Use Specified Rounding:</i> Enter a rounding rule in the corresponding field on the right.</p> |
| Resolved Amount | <p>Select the rounding rule to apply to the resolved amount for absence elements.</p> <p>Rounding occurs after the system resolves the element's calculation rule. Values are:</p> <p><i>No Rounding:</i> Prevents rounding of the amount.</p> <p><i>Use Specified Rounding:</i> Enter a rounding rule in the field on the right.</p> |
| Proration Option | Select either <i>No Proration</i> or <i>Use Specific Proration</i> . |
| Proration Rule | If you selected <i>Use Specific Proration</i> in the Proration Option field, enter the proration rule that is to be used as the default proration rule for elements being used to process this pay group. In defining an earning or deduction element, you can have the system use the pay group default value or have it specify a unique rule for a certain earning or deduction element. |

Frequency Defaults

Use this group box to define the frequency defaults used in multiple absence calculation components.

Note: The system calculates the daily and monthly pay rates that appear on the Job Data - Compensation page based on the frequency factors associated with the pay group assigned to each payee (on the Job Data - Payroll page). As a result, if you use these corresponding daily and monthly rate system elements directly within your Absence Management rules, you will need to ensure that the frequency factors associated with the pay group coincide with the values to which you expect these values to resolve. Otherwise, rates may not be in sync (because the system retrieves daily and monthly rates directly from Job Data.)

Related Links

“Defining a Frequency ID and Country-Specific Defaults” (Application Fundamentals)

[Defining Rounding Rule Elements](#)

[Defining Proration Rules](#)

Defining Rate Code Elements

“Understanding Frequency IDs” (Application Fundamentals)

Chapter 14

Using Calendars

Understanding Calendars

This section lists common elements and discusses:

- Calendar process flow.
- Creating calendars.

Common Elements Used for Calendars

| <i>Field or Control</i> | <i>Description</i> |
|-------------------------|--|
| Calendar | Identifies which payees to process and the run type and absence period. It can include instructions for generation control, excluding certain elements from processing, overriding supporting elements, and providing other information. |
| Calendar Group | <p>When you start an absence process, you must enter the calendar group ID that identifies the calendar or set of calendars to process, or in the case of off-cycle runs, the set of off-cycle groups to process.</p> <p>You can process multiple calendars or off-cycle groups simultaneously. Calendar groups are keyed by country, so you can include multiple calendars or off-cycle groups for the same country in a single calendar group.</p> |
| Period | <p>Defines the absence period and frequency for your processing run.</p> <p>You attach an absence period to an absence run by linking it to a calendar. Like run types, absence periods are reusable.</p> |

| Field or Control | Description |
|-------------------------|--|
| Run Type | <p>A user-defined method of identifying an absence run. The run type identifies the process list to use, whether to process retroactive triggers. It's also used in generation control, historical rules, and retroactive matching processes.</p> <p>You attach a run type to an absence run process by linking it to a calendar. Because you define the run type information outside the calendar, you can link the same run type to multiple calendars. For example, if a weekly and a monthly pay group use the same process list, you might set up one run type and link it to multiple calendars. The effective date enables you to switch process lists or retroactive trigger processing actions and yet reproduce a retroactive calculation with old settings.</p> |

Related Links

[Understanding Segmentation Setup](#)

[Defining Generation Control Elements](#)

[Defining Historical Rule Elements](#)

[Understanding Retroactive Processing](#)

Calendar Process Flow

When processing an absence run, the system must determine which payees to process; what earnings, deductions, and other elements to process for selected payees; and what time period to process.

For on-cycle processing, calendars unify this information. Calendars link the components that tell the system whom and what to process for which absence period.

Note: With off-cycle processing, off-cycle groups, rather than calendars, identify which payees to process, the elements to process, and the time period.

This diagram illustrates how components interact to produce an on-cycle absence batch processing run.

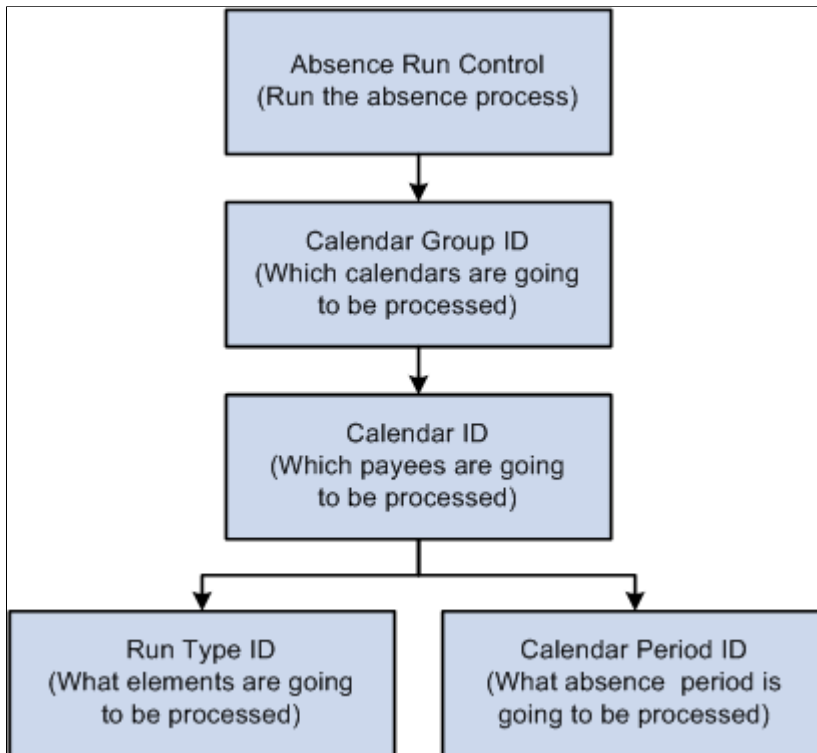

Related Links

[Understanding Off-Cycle Processing](#)

Creating Calendars

To create calendars, use the Calendars (GP_CALENDAR) component or the Automatic Calendar Creation (GP_AUTO_CAL) component. You can use the CI_GP_CALENDAR component interface to load data into the table for the GP_CALENDAR component.

Calendars bring payees in a selected pay group together with the rules and processes for calculating an absence run. You can define calendars by:

- Defining a single calendar with the Calendars component.
When you define a calendar with this feature, you can enter instructions for generation control, overrides, or elements to exclude from processing.
- Using the Automatic Calendar Creation component to define multiple calendars simultaneously.

You can use the Calendars component to edit an automatically generated calendar.

Note: Before you create calendars you must define the run type and period ID associated with the calendar.

See [Prerequisites](#).

Defining Run Types

Page Used to Define Run Types

| Page Name | Definition Name | Usage |
|----------------|-----------------|--|
| Run Types Page | GP_RUN_TYPE | Specify the process list to be used, whether to process retroactive triggers, and other processing parameters. |

Run Types Page

Use the Run Types page (GP_RUN_TYPE) to specify the process list to be used, whether to process retroactive triggers, and other processing parameters.

Navigation:

Set Up HCM > Product Related > Global Payroll & Absence Mgmt > Framework > Processing > Run Types > Run Types

This example illustrates the fields and controls on the Run Types page.

Run Types

Run Type Name: K0WRYABS

*Description: Absence Management Run Type

Short Description: AM RunType

*Calculation Type: Absence Calculation

Allow Duplicates

Retro Adjustment Sources Personalize | Find | View All | First 1 of 1 Last

| Run Type Name | Description |
|---------------|-------------|
| | |

Definition Find | View All | First 1 of 1 Last

Effective Date: 01/01/1990

*Status: Active

Process Name: K0WPR ABSENCE Absence Management

Process Retro Triggers

Time & Labor TRCs Personalize | Find | View All | First 1 of 1 Last

| Time Reporting Code | Description |
|---------------------|-------------|
| | |

Variable Compensation Awards Personalize | Find | View All | First 1 of 1 Last

| *Earnings | Description |
|-----------|-------------|
| | |

Note: After processing begins, you cannot edit fields on the Run Types page. To make changes, cancel the absence run.

| Field or Control | Description |
|-------------------------|---|
| Calculation Type | Select or <i>Absence Calculation</i> . <i>Payroll Calculation</i> is not applicable to Absence Management. |
| Allow Duplicates | <p>Select to allow duplicate segments.</p> <p>If you don't select this check box, then while the payee selection process creates the segment status records, the system determines whether other segment stat records exist with the same employee ID, employee record, pay group, run type, period ID, segment from dates and segment to dates (both must match), and a segment status of <i>Active</i>.</p> <p>The system creates a new segment stat record if a matching one doesn't exist.</p> <p>This check box ensures that duplicates are or aren't made in certain situations. For example, you might create a calendar to calculate off-cycle payments but need to avoid paying the payees again during the regular payroll cycle. If the check box isn't selected, the system notes those occurrences and doesn't double-pay. If you're creating a calendar to process bonus or commission payroll runs, you might have multiple calendar IDs defined and the same payee is allowed to be paid in more than one calendar. If the check box is selected, the appropriate payees are paid twice.</p> <hr/> <p>Note: Regardless of setting, the system never creates overlapping segments for the same payee within a calendar. If you have processed a partial period with payee calendar overrides or an off-cycle advance, on subsequent processing of the same calendar the system will only process remaining portions of the period, thus avoiding processing overlaps.</p> <hr/> |

Retro Adjustment Sources

| Field or Control | Description |
|-------------------------|--|
| Run Type Name | Enter additional run types for which the system includes retroactive adjustments during the pay run. For example, you can select a bonus run type as an additional retroactive adjustment source for your regular payroll run type. This enables you to automatically forward retroactive deltas for payee bonuses during your regular payroll run so that your payees don't have to wait for the more infrequent and irregular bonus pay runs to receive their retroactive bonus adjustments. |

Definition

| <i>Field or Control</i> | <i>Description</i> |
|-------------------------------|--|
| Process Name | Enter the process list, selecting from absence process lists, depending on your selection in the Calculation Type field. |
| Process Retro Triggers | <p>Select this check box to process retroactive triggers. You might ignore retroactive triggers when running a bonus entitlement run but include processing of retroactive triggers with all regular absence runs.</p> <p>Retroactive triggers are processed for any payee who's identified in any calendar ID with this check box selected.</p> <p>You can override this field at the calendar and calendar group ID level.</p> |

Time & Labor TRCs

| <i>Field or Control</i> | <i>Description</i> |
|----------------------------|---|
| Time Reporting Code | This field is not applicable to Absence Management. |

Variable Compensation Awards

| <i>Field or Control</i> | <i>Description</i> |
|-------------------------|---|
| Earnings | This field is not applicable to Absence Management. |

Creating Periods

To process an absence run, specify the time period to calculate by using a period ID, which identifies the begin date, end date, and frequency of an absence period.

To create periods, use the Periods (GP_CALENDAR_PERIOD) component or the Automatic Period Creation (GP_AUTO_PRD) component. You can use the CI_GP_CALENDAR_PERIOD component interface to load data into the table for the GP_CALENDAR_PERIOD component.

Pages Used to Create Periods

| <i>Page Name</i> | <i>Definition Name</i> | <i>Usage</i> |
|--|------------------------|----------------------------------|
| <u>Periods Page</u> | GP_CALENDAR_PERIOD | Define a single absence period. |
| <u>Periods - Automated Creation Page</u> Automatic Period Creation Page | GP_AUTO_PRD | Define multiple absence periods. |

Periods Page

Use the Periods page (GP_CALENDAR_PERIOD) to define a single absence period.

Navigation:

- **Global Payroll & Absence Mgmt > Absence and Payroll Processing > Define Calendars > Periods > Periods**
- **Set Up HCM > Product Related > Global Payroll & Absence Mgmt > Framework > Calendars > Periods > Periods**

This example illustrates the fields and controls on the Periods page.

Periods

Period ID K0WCA05M04

*Description

Short Description

*Period Begin Date 

*Period End Date 

*Frequency  Monthly

Frequency Factor 12.0000000

Note: After processing begins, you cannot edit fields on the Periods page. To make changes, cancel the absence run.

| <i>Field or Control</i> | <i>Description</i> |
|---|---|
| Period Begin Date and Period End Date | Enter the dates for the period being calculated. Because multiple calendars that use the same absence period can have different payment dates, you specify the payment date on the Calendar Definition page. |

| <i>Field or Control</i> | <i>Description</i> |
|-------------------------|--|
| Frequency | <p>Enter the frequency. The system uses this to deannualize an entitlement element that's defined without generation control frequency. When generation control frequency is defined for an element, the following occurs:</p> <ul style="list-style-type: none"> • If there's a match between the element generation control and the calendar ID generation control, the generation control frequency is used for the deannualization factor. • If there's no match between the element generation control and the calendar ID generation control, the element isn't resolved, with a couple of exceptions. <hr/> <p>Note: Entitlement elements have two generation control fields, one for the primary element and one for adjustment processing.</p> <hr/> |

| <i>Field or Control</i> | <i>Description</i> |
|-------------------------|--|
| Frequency Factor | Displays the factor for annualization and deannualization. |

Examples of the Time and Frequency Data That a Period ID Can Define

This table lists examples of how you can define different periods by varying the end date and frequency:

| <i>Begin Date</i> | <i>End Date</i> | <i>Frequency</i> |
|-------------------|-----------------|------------------|
| June 1 | June 7 | Weekly |
| June 1 | June 30 | Monthly |
| June 1 | June 15 | Semimonthly |
| June 1 | August 31 | Quarterly |

Frequency Examples

Assume that there are four elements, each element begins with a gross amount of 1200. This table lists the effect of combining various frequency options (the value of each element after frequency option application appears in the last row of the table):

| Frequency | Element 1 | Element 2 | Element 3 | Element 4 |
|---|--|--|------------------|--|
| Amount | 1200 | 1200 | 1200 | 1200 |
| Frequency (Element Definition) | Monthly (12) | Monthly (12) | Monthly (12) | Monthly (12) |
| Generation Control Frequency | None | Monthly (12) | Monthly (12) | Annual (1) |
| Absence Period Frequency | Semimonthly (24) | Semimonthly (24) | Semimonthly (24) | Semimonthly (24) |
| Calendar Generation Control Frequency | None | Monthly (12) | None | Semimonthly (24) |
| Calculated Amount | 600 | 1200 | Not resolved | 24 000 |
| (Amount * Annualization factor/ deannualization factor) | (Amount * Frequency/ Absence Period Frequency) | (Amount * Frequency/ Generation Control Frequency) | | (Amount * Frequency/ Generation Control Frequency) |

Related Links

[Defining Generation Control Elements](#)

Periods - Automated Creation Page

Use the Periods - Automated Creation page (GP_AUTO_PRD) to define multiple absence periods.

Note: When accessed from the Global Payroll & Absence Mgmt menu, the page name is *Periods - Automated Creation*. When accessed from the Set Up HCM menu, the page name is *Automatic Period Creation*. Other than the title, the pages are the same.

Navigation:

- **Global Payroll & Absence Mgmt > Absence and Payroll Processing > Define Calendars > Periods - Automated Creation**
- **Set Up HCM > Product Related > Global Payroll & Absence Mgmt > Framework > Calendars > Automatic Period Creation**

This example illustrates the fields and controls on the Periods - Automated Creation page.

Periods - Automated Creation

Run Control ID 1
Report Manager
Process Monitor
Run

Period Creation Parameters

*Frequency ID

*Unit of Measure Number of Days

*Begin Date 12/15/2013

*End Date 12/15/2013

*Period ID Prefix

Period Frequency Suffix

*Sequence Number 1

*Units in Period

Resulting Period IDs (max is 99) 01 - nn

Enter the period creation parameters and click the **Run** button.

| Field or Control | Description |
|---------------------------------------|---|
| Frequency ID | <p>Enter the calendar period frequency. This field is also used to generate the period description.</p> <hr/> <p>Note: The system doesn't edit your entry to ensure it's consistent with the values in the Unit of Measure and Units in Period fields.</p> <hr/> <p>See Periods Page.</p> |
| Unit of Measure | <p>Select the unit of measure for the periods.</p> <p>The <i>Number of Days</i> and <i>Number of Months</i> values, used in conjunction with the Units in Period field determine the number of days or months in a period.</p> <p>The <i>Semimonthly</i> value represents 15 days. The first semimonthly period always includes days 1 to 15. The second period includes days 16 to 28, 29, 30, or 31, depending on the month. When you select this value, the Units in Period becomes unavailable.</p> |
| Units in Period | <p>Enter the number of units in each generated period.</p> |
| Begin Date and End Date | <p>Enter the first day of the first period being generated and the last date through which the system should generate periods.</p> <p>The system generates all periods for which the end date is before or equal to the end date that you enter.</p> |

| Field or Control | Description |
|---|--|
| Period ID Prefix | Enter a prefix of up to seven alphanumeric characters. The system creates a unique period ID for each period it creates, by adding the period frequency suffix and a consecutive sequence number to the prefix. |
| Period Frequency Suffix | Enter the period frequency suffix that's added to the period ID. The default is the first letter of the selected frequency ID. |
| Sequence Number | <p>Enter for the first period. The system assigns a sequential number to each following period that you create.</p> <p>This is useful when you create periods for the same year in separate runs. Suppose that you want to generate six periods for a monthly payroll. You enter <i>1</i> in this field, and the process creates periods 1 to 6. Later, when you generate periods for the remaining months, you enter <i>7</i> here.</p> |
| Resulting Period IDs (max is 99) | This field combines the period ID prefix, period frequency suffix, and sequence number to show you what periods the process will create. For example, if you enter a period ID prefix of <i>PAY2001</i> , a period frequency suffix of <i>M</i> , and a sequence number of <i>1</i> , the periods generated are <i>PAY2001M01</i> - <i>PAY2001Mnn</i> where <i>nn</i> represents the number of the last period created. |

Examples: Unit of Measure and Units in Period Combinations

This table gives examples of periods defined using different combinations of unit of measure and units in period:

| Unit of Measure | Units in Period | Result |
|------------------------|------------------------|---|
| Day | 7 | Each period represents seven days (for a weekly payroll). |
| Day | 14 | Each period represents 14 days (for a biweekly payroll). |
| Semimonth | Not applicable. | Each period represents 15 days (for a semimonthly payroll), but the periods go from 1 to 15 and from 16 to the last day of the month. |
| Month | 1 | Each period represents a month (for a monthly payroll). |

| <i>Unit of Measure</i> | <i>Units in Period</i> | <i>Result</i> |
|------------------------|------------------------|--|
| Month | 3 | Each period represents three months (for a quarterly payroll). |

Creating Single Calendars

Note: After processing begins, you cannot edit the fields on the Calendars component, other than to add payees to the list of payees to be processed. To modify these pages, cancel the process.

Pages Used to Create Single Calendars

| <i>Page Name</i> | <i>Definition Name</i> | <i>Usage</i> |
|---|------------------------|---|
| Calendars - Definition Page | GP_CALENDAR1 | Link together the pay group, period ID, run type ID, target calendar ID, and payee selection criteria associated with a calendar. |
| Calendars - Generation Control Page | GP_CALENDAR3 | Override generation control frequencies for a calendar. |
| Calendars - Supporting Element Overrides Page | GP_CALENDAR2 | Override the value of a bracket, date, duration, formula, or variable element associated with a calendar. |
| Calendars - Excluded Elements Page | GP_CALENDAR4 | Exclude earnings, deductions, take, or entitlement elements from a calendar. |

Prerequisites

Before creating a calendar, define the run type and period ID associated with the calendar.

Note: Calendars are associated with a single pay group. If you change a payee's pay group assignment, period segmentation results. For example, if a payee changes from pay group PGA to PGB on June 15, days 1–14 are processed with the PGA calendar and days 15–30 with the PGB calendar.

Related Links

[Defining Run Types](#)

[Creating Periods](#)

Calendars - Definition Page

Use the Calendars - Definition page (GP_CALENDAR1) to link together the pay group, period ID, run type ID, target calendar ID, and payee selection criteria associated with a calendar.

Navigation:

- **Global Payroll & Absence Mgmt > Absence and Payroll Processing > Define Calendars > Calendars > Definition**
- **Set Up HCM > Product Related > Global Payroll & Absence Mgmt > Framework > Calendars > Calendars > Definition**

This example illustrates the fields and controls on the Calendars - Definition page.

| Definition | Generation Control | Supporting Element Overrides | Excluded Elements | |
|-----------------|---|------------------------------|-------------------|----------|
| Pay Group | K0WPG KU2 | US Biweekly Hourly | Calendar ID | KU KUB26 |
| Pay Entity | K0WPE PNA | Pay Entity PNA | Country | USA |
| *Period ID | <input type="text" value="KUB26"/> | 12/16/2004 - 12/29/2004 | | |
| *Payment Date | <input type="text" value="12/29/2004"/> | | | |
| *Run Type | <input type="text" value="K0WRYABS"/> | Absence Management Run Type | | |
| Target Calendar | <input type="text"/> | | | |

| Payee Selection | Additional Criteria |
|--|--|
| <input checked="" type="radio"/> Active Payees Only <input type="radio"/> Active Payees with... <input type="radio"/> Active PLUS Payees with... <input type="radio"/> All Payees with... <input type="radio"/> Listed Payees Only | Additional Criteria apply to "Active Payees with...", "Active PLUS Payees with..." or "All Payees with..." as additional requirements for selection <input type="checkbox"/> Positive Input <input type="checkbox"/> Pending Retroactive Changes |

| Field or Control | Description |
|------------------------|--|
| Period ID | Enter the absence period the calendar represents. The corresponding dates appear in the Begin Date and End Date fields. |
| Payment Date | Enter the date when payees are paid. In certain countries, this date is important for tax calculations. |
| Run Type | Enter the run type that identifies the process list to be used for this calendar run. (The run type also identifies whether retroactive triggers are to be processed.) |
| <run type description> | Click to access the Run Types page, where you can specify the process list to be used, whether to process retroactive triggers, and other processing parameters. See Run Types Page . |

| Field or Control | Description |
|-------------------------|---|
| Target Calendar | Enter a target calendar ID if you're defining an absence processing run or any processing run that generates positive input. Identifies the target calendar for the daily data or positive input being generated. Absences cannot be targeted back in time, so the target calendar end date cannot be earlier than the end date of the current period ID. Target calendar is only required when using Absence Management as a stand alone application or along with Global Payroll. If your generated positive input is to be sent to Payroll for North America or to a third-party payroll application, then you don't need to define a target calendar. |

Payee Selection

Identify which payees in the selected pay group to include in the calendar that you're defining. You can have the system identify the payees, or you can list the payees manually. Active payees are those who were active in the pay group for at least one day during the absence period.

The information that you enter here gives the system basic information about which payees to process for a particular calendar.

Note: A calendar created for active payees must be unique based on the combination of pay group, period ID, and run type, reducing the possibility of duplicate calculations.

| Field or Control | Description |
|-----------------------------------|--|
| Active Payees Only | Select to include all active payees with no other qualifying criteria. Active payees are those who were active in the pay group for at least one day during the absence period. |
| Active Payees with... | Select to include only those active payees who have pending retroactive triggers. If you select this option, you must select the Pending Retroactive Changes check box. |
| Active PLUS Payees with... | Select to include all active payees and payees who were ever active in the pay group, but only if they have pending retroactive triggers. . If you select this option, you must select the Pending Retroactive Changes check box. |
| All Payees with... | Select to include only those payees who have pending retroactive triggers. If you select this option, you must select the Pending Retroactive Changes check box. |

| Field or Control | Description |
|------------------------------------|---|
| Listed Payees Only | <p>Select to list payees for processing, rather than have the system identify them automatically. The Payee List group box becomes available.</p> <p>You can use this option to pay one payee or a small group of payees.</p> |
| Positive Input | This check box is not applicable to Absence Management. |
| Pending Retroactive Changes | <p>Becomes available if you select Active Payees with..., Active PLUS Payees with...., or All Payees with.</p> <p>If you select this check box and Active Payees with..., the calendar processes active payees who have pending retroactive triggers.</p> <p>If you select this check box and Active PLUS Payees with... .., the calendar processes active payees or payees who have pending retroactive changes.</p> <p>This check box enables you to include inactive payees in an active-only run based on the occurrence of a retroactive change that affected the inactive payee.</p> |

Payee List

The system displays this group box if you select the **Listed Payees Only** option.

| Field or Control | Description |
|----------------------------|--|
| EmplID | Enter the payees that the calendar processes. Anyone on the payee list must be a current or previous member of the pay group associated with this calendar. While the calendar remains open, you can add to the payee list. |
| Calculate Thru Date | The default value for this field is the last day of the period selected in the Period ID field. If you want to perform the calculation of a payee for part of a absence period, you can enter an earlier date. The system calculates only segments that end on or before the date that you enter. |

Calendars - Generation Control Page

Use the Calendars - Generation Control page (GP_CALENDAR3) to override generation control frequencies for a calendar.

Navigation:

- **Global Payroll & Absence Mgmt > Absence and Payroll Processing > Define Calendars > Calendars > Generation Control**
- **Set Up HCM > Product Related > Global Payroll & Absence Mgmt > Framework > Calendars > Calendars > Generation Control**

This example illustrates the fields and controls on the Calendars - Generation Control page.

To have a frequency compared with generation control frequencies entered at the element level—for eligibility and deannualization purposes—enter those frequencies here.

| Field or Control | Description |
|---------------------------------------|--|
| Frequency Tag | Enter the frequency ID to be overridden. |
| Frequency Annualization Factor | Displays the frequency factor associated with the selected frequency ID. |

Eligibility Example

Suppose that you have a weekly pay group and absence period. This pay group has an entitlement that's processed only during the first absence period of every month. You create a generation control frequency called *Ist of Month* (with a factor of 12), which you assign to the entitlement, and attach the frequency *Ist of Month* to the first calendar of each month.

When the system processes the entitlement, it compares the element's generation control frequency with the calendar values. If they match, the entitlement passes eligibility. If not, the entitlement fails eligibility and isn't processed. If the generation control and calendar have multiple frequency values and there's a match on more than one frequency but the factors aren't the same, the system sets the payees in error.

Related Links

[Generation Control](#)

Calendars - Supporting Element Overrides Page

Use the Calendars - Supporting Element Overrides page (GP_CALENDAR2) to override the value of a bracket, date, duration, formula, or variable element associated with a calendar.

Navigation:

- **Global Payroll & Absence Mgmt > Absence and Payroll Processing > Define Calendars > Calendars > Supporting Element Overrides**
- **Set Up HCM > Product Related > Global Payroll & Absence Mgmt > Framework > Calendars > Calendars > Supporting Element Overrides**

This example illustrates the fields and controls on the Calendars - Supporting Element Overrides page.

Calendar Supporting Element Overrides

| <i>Field or Control</i> | <i>Description</i> |
|-------------------------|--|
| Element Type | Select the element type. Values are: <i>Bracket</i> , <i>Date</i> , <i>Duration</i> , <i>Formula</i> , and <i>Variable</i> . |
| Element Name | Select the particular element to override. |
| Numeric Value | Enter an override value. When the system encounters the specified element on the process list, it applies the override value that you defined in this field. The override value can itself be overridden by positive input instructions, payee overrides, and so on. |

Related Links

[Understanding Overrides](#)

Calendars - Excluded Elements Page







Use the Calendars - Excluded Elements page (GP_CALENDAR4) to exclude earnings, deductions, take, or entitlement elements from a calendar.

Navigation:

- **Global Payroll & Absence Mgmt > Absence and Payroll Processing > Define Calendars > Calendars > Excluded Elements**

- **Set Up HCM > Product Related > Global Payroll & Absence Mgmt > Framework > Calendars > Calendars > Excluded Elements**

This example illustrates the fields and controls on the Calendars - Excluded Elements page.

| | | | | | | | |
|--|----------------------|---|--|---|--|---|--|
| Definition | | Generation Control | | Supporting Element Overrides | | Excluded Elements | |
| Pay Group K0WPG KU2 US Biweekly Hourly | | | | Calendar ID KU KUB26 | | | |
| Pay Entity K0WPE PNA Pay Entity PNA | | | | Country USA | | | |
| Elements to be Excluded | | Personalize Find View All   | | First  1 of 1  Last | | | |
| *Element Type | Element Name | Description | | | | | |
| <input type="text"/> | <input type="text"/> | | | | |   | |

| Field or Control | Description |
|------------------|--|
| Element Type | Select the element type. Values are: <i>Absence Entitlement</i> and <i>Absence Take</i> , or <i>Deduction</i> and <i>Earnings</i> , depending on the type of calendar. |
| Element Name | Enter the element to be excluded from processing. The element is not processed. |

Note: To exclude an element from processing, the element must be defined to enable calendar overrides.

Related Links

[Understanding Overrides](#)

Creating a Set of Calendars

Page Used to Create a Set of Calendars

| Page Name | Definition Name | Usage |
|---|-----------------|---|
| Calendars - Automated Creation Page Automatic Calendar Creation Page | GP_AUTO_CAL1 | Run the Automatic Calendar Creation process to create a set of calendars. |

Prerequisites

Before creating a series of calendars, define the run type and periods associated with the calendars. Use the automatic period creation feature to create periods automatically.

Note: Calendars are associated with a single pay group. If you change a payee's pay group assignment, period segmentation results.

Related Links

[Defining Run Types](#)

[Creating Periods](#)

Calendars - Automated Creation Page

Use the Calendars - Automated Creation page (GP_AUTO_CAL1) to run the Automatic Calendar Creation process to create a set of calendars.

Note: When accessed from the Global Payroll & Absence Mgmt menu, the page name is *Calendars - Automated Creation*. When accessed from the Set Up HCM menu, the page name is *Automatic Calendar Creation*. Other than the title, the pages are the same.

Navigation:

- **Global Payroll & Absence Mgmt > Absence and Payroll Processing > Define Calendars > Calendars - Automated Creation > Automatic Calendar Creation**
- **Set Up HCM > Product Related > Global Payroll & Absence Mgmt > Framework > Calendars > Automatic Calendar Creation > Automatic Calendar Creation**

This example illustrates the fields and controls on the Calendars - Automated Creation page.

Calendars - Automated Creation
Run Control ID PS Report Manager
Process Monitor Run

Calendar Parameters

*Calendar ID Prefix

*Pay Group Absence Management to GP 1

*Run Type Absence Management Run Type

*Frequency Monthly

*First Period ID K0WCA05M01 Monthly (2005-01-01 Thru 2005-01-31)

First Target Calendar

Resulting Calendar IDs (max. "nn" value is 99) K0W1 K0WCA05M01 - K0W1 K0WCA05Mnn

Setting Payment Date

Days From Period End Date

Specific Day of the Week

Number of Days

Use a negative number to set the Payment Dates before the Period End Dates.

If Payment Date is a holiday

Payment Date is the day before

Payment Date does not change

Payment Date is the day after

Payee Selection

Active Payees Only

Active Payees with...

Active PLUS Payees with...

All Payees with...

Additional Criteria

Additional Criteria apply to "Active Payees with...", "Active PLUS Payees with..." or "All Payees with..." as additional requirements for selection

Positive Input

Pending Retroactive Changes

| Field or Control | Description |
|------------------------------|---|
| Calendar ID Prefix | <p>Enter a prefix of up to seven alphanumeric characters. The system creates a unique calendar ID for each calendar it creates, by adding this prefix to the period ID associated with the calendar and the number of the calendar.</p> <p>For example, if the first period ID is PAY2001M01 and you enter a prefix of REGULAR, the calendar ID for the first generated calendar becomes REGULAR PAY2001M01.</p> |
| Pay Group | Enter the pay group for which the calendars are being built. |
| Run Type | Enter the run type to which the calendars are associated. |
| Frequency | Enter the frequency for creating the calendars. |
| First Period ID | <p>Enter the first period that the system uses to build calendars. The period IDs from which you select are based on the frequency ID.</p> <p>The system generates calendars for the number of consecutive periods that you defined when creating the periods.</p> |
| First Target Calendar | <p>If you're defining calendars for an absence run that generates positive input for a different calendar, enter the target calendar ID for the first calendar being created. This field is optional.</p> <p>Based on this ID, the system determines the sequential target calendars to use for auto created calendars.</p> <hr/> <p>Note: For the system to determine sequential target calendars, the calendar entered in the First Target Calendar field must follow a standard naming convention that ends with two digits to describe the month or any other period that the calendar represents. For example, you can select a first target calendar of <i>GXCI CPY2000M01</i>, because the system can use the last two digits to determine the appropriate sequential target calendars. If you select a nonstandard first target calendar, such as <i>GW10204P</i>, you receive an error message if you click Save or Run.</p> <p>This process enables you to create up to 99 calendars, but each one must be based on an existing target calendar. For example, if you try to generate calendars ABS001 through ABS099, but the only target calendars that exist are PAY001 through PAY050, the system cannot create calendars ABS051 through ABS099.</p> <hr/> |

Setting Payment Date

| <i>Field or Control</i> | <i>Description</i> |
|---|--|
| Days From Period End Date and Number of Days | This option is not applicable to Absence Management. |
| Specific Day of the Week | This option is not applicable to Absence Management. |

If Payment Date is a Holiday

The options that are available in the group box do not apply to Absence Management.

Payee Selection

This group box is identical to the **Payee Selection** group box on the Calendars - Definition page except that **Listed Payees Only** is not an option.

Related Links

[Calendars - Definition Page](#)

Defining Calendar Groups

Page Used to Create Calendar Groups

| <i>Page Name</i> | <i>Definition Name</i> | <i>Usage</i> |
|---|------------------------|---|
| Calendar Groups Page Off Cycle Calendar Group Page | GP_CALENDAR_RUN | Define a group of calendars to process together. Calendars are processed in the order listed. |

Understanding Calendar Groups

To set up calendar groups, use the Calendar Groups (GP_CALENDAR_RUN) component. You can use the CI_GP_CALENDAR_RUN component interface to load data into the table for the Calendar Groups component.

A calendar group identifies calendars to process together for an on-cycle run or the off-cycle groups to process for an off-cycle run. When creating a calendar group, consider that:

- The processing phases defined on the run control page are performed across all members of the calendar group; therefore, group together calendars that require identical calculations.
- Elements from different countries cannot be processed simultaneously.

Don't include calendars that represent pay entities from different countries—based on the calendar's pay group—in the same calendar group.

- A calendar's order in the calendar group ID determines the calculation processing sequence.

Processing Sequence

Run calendars in absence period date order, because many absence processes are based on the order in which calendars are run and thus finalized. Running calendars non sequentially can affect how accumulators and retroactive limit dates are handled—inserting a calendar that isn't for the next sequential absence period can create unexpected results.

Calendars that are run out of absence period order experience these accumulators issues:

- Accumulators are included in calendar processing by determining which finalized absence calendar (for the country being processed) is the most recent.
- Accumulator values are stored for each calendar based on the accumulator from and to dates, not the absence period begin and end dates.

If the accumulator from and to dates include any day in the absence period, the accumulator is written to the results tables.

- An accumulator might not be written to the results tables and therefore wouldn't be included in the next calendar, preventing referencing or updating of the accumulator values.
- Accumulator balances might be inaccurate.

Suppose that you run a March calendar before a February calendar. The accumulator balances that are included as starting balances for the February calendar would include the results from the March calendar.

Calendars that are run out of absence period order experience these retroactive limit date issues:

- Retroactive limit dates are determined based on the first calendar that's encountered—for a payee—within a calendar group ID.

Although other calendars might be encountered later that have earlier absence period dates, the retroactive limit date is determined by the first calendar's dates.

- When processing retroactive situations, the system determines which calendars to rerun by looking for the earliest calendar finalize time stamp where the calendar period end date is greater than the trigger effective date.

Suppose that you run and finalize calendars in this order: January (Calendar 1), February (Calendar 2), another January (Calendar 3), and March (Calendar 4). If you have retroactive data for February 15, then Calendar 2, Calendar 3, and Calendar 4 run again.

Related Links

[Understanding Off-Cycle Processing](#)

Calendar Groups Page

Use the Calendar Groups page (GP_CALENDAR_RUN) to define a group of calendars to process together.

Note: When accessed from the Global Payroll & Absence Mgmt, Absence and Payroll Processing, Define Calendars menu, the page name is *Calendar Groups*. When accessed from the Global Payroll & Absence Mgmt, Absence and Payroll Processing, Off Cycle menu, the page name is *Off Cycle Calendar Group*. Other than the title, the pages are the same.

Calendars are processed in the order listed.

Navigation:

Global Payroll & Absence Mgmt > Absence and Payroll Processing > Define Calendars > Calendar Groups > Calendar Group

Global Payroll & Absence Mgmt > Absence and Payroll Processing > Off Cycle > Off Cycle Calendar Group > Calendar Group

This example illustrates the fields and controls on the Calendar Groups page.

Calendar Groups

Calendar Group ID: G1_GRP_DEC08_BO1

*Description: G1_GRP_DEC08_BO1 Short Description: G1_GRP_DEC

*Country: USA United States

Use as template Process by stream Processing initiated

Off Cycle Process retro triggers Processing finalized

Calendar List Personalize | Find | View All | First 1 of 1 Last

| *Sequence | *Pay Group | *Calendar ID |
|-----------|------------|------------------|
| 1 | K1GPGO | G1_CAL_DEC08_BO1 |

Note: After processing begins for an on-cycle run, you should not edit the fields on the Calendar Groups page. To modify this page, cancel the absence run.

| Field or Control | Description |
|--------------------------|---|
| Use as template | Select to use this calendar group to run the online Absence Forecasting or Balance Inquiry process. This option is not available for off-cycle processing. See Absence Management Overview . |
| Process by stream | Select to use stream processing for this calendar group. This feature is typically not used for off-cycle processing. |
| Off cycle | Select if this calendar group is to be used for off-cycle processing. |

| Field or Control | Description |
|-------------------------------|--|
| Process retro triggers | <p>Select to process retroactive triggers for this calendar group.</p> <p>For on-cycle processing, the default value is based on the Process Retro Triggers field on the Run Types page. If any run type indicates that retroactive triggers should be processed, the default is to select this option.</p> <p>For off-cycle processing, you must select this check box if any of the off-cycle groups that you add to this calendar group include correction transactions.</p> |

Calendar List

List the calendars to process together. The number that you enter in the **Sequence** field determines the calendar processing order. This grid is hidden when you select the **Off cycle** check box.

List off-cycle groups in processing order

The following grid appears only when you select the **Off cycle** check box. List the off-cycle groups to process. An off-cycle group identifies the off-cycle transactions to be processed for a specific pay group and period.

This example illustrates the fields and controls on the Calendar Groups page when entering values for off-cycle groups.

Calendar Groups

Calendar Group ID Short Description

*Description *Country United States

Use as template Process by stream Processing initiated
 Off Cycle Process retro triggers Processing finalized

List Off Cycle Groups in processing order Personalize | Find | View All | | First 1 of 1 Last

| *Sequence | *Pay Group | *Period ID | *Off Cycle Group |
|----------------------|----------------------|----------------------|----------------------|
| <input type="text"/> | <input type="text"/> | <input type="text"/> | <input type="text"/> |

Related Links

[Absence Management Overview](#)

Entering Calendar Override Instructions for a Payee

Pages Used for Entering Calendar Override Instructions for a Payee

| <i>Page Name</i> | <i>Definition Name</i> | <i>Usage</i> |
|-----------------------------------|------------------------|--|
| <u>Payee Calendar Groups Page</u> | GP_PYE_RUN | Select the calendars for which to enter special processing instructions for a payee. |
| <u>Segment Details Page</u> | GP_PYE_RUN_SEC | Create period segments for a payee and identify which segments to process. |

Understanding Calendar Overrides

You can create additional segments for a payee and calendar and enter processing instructions for a specific segment.

Suppose that in March, you issue advance pay to someone who's taking vacation from April 1 to 15. Because the payee is to receive half of April's pay in March, you're paying only the salary for April 16–30 in April. You can use the Payee Calendar Groups page to accomplish this.

You create a calendar group that includes March and April. To issue the absence advance pay in March, you use the Payee Calendar Groups page for March to indicate that the payee is to be paid for both the March calendar and April 1–15. For April, you use the April calendar group but this time indicate that the payee is being paid for April 16–30 only.

You can specify which effective-dated rules the system applies when processing a calendar segment and which period's accumulators it updates. For example, when paying the April amount in March, you can instruct the system to apply the earning rules that are in effect in March and update the accumulators for March. Or you can instruct the system to use the rules that will be in effect in April.

Note: As an alternative to using calendar overrides to process an absence advance payment, you can enter instructions for an advance using the Off Cycle On Demand component (GP_ONDEMAND) and run an off-cycle payroll.

Payee Calendar Groups Page

Use the Payee Calendar Groups page (GP_PYE_RUN) to select the calendars for which to enter special processing instructions for a payee.

Navigation:

Global Payroll & Absence Mgmt > Payee Data > Create Overrides > Payee Calendar Groups > Payee Calendar Groups

This example illustrates the fields and controls on the Payee Calendar Groups page.

Payee Calendar Groups

Employee ID GRFE01 Empl Record 0 Name Georgy Penha

Calendar Group ID GR LHF M01

Processing Details

*Processing Begin Date 01/01/2002

*Processing End Date 01/31/2002 **Override Entire Calendar Run**

*Payment Date 01/31/2002

| Calendars to Process | | | | | Personalize Find View All | First 1-6 of 6 Last |
|----------------------|-----------------------------|----------------------|--------------------------|-----------------|----------------------------------|----------------------------------|
| *Sequence | *Pay Group | *Calendar ID | *Process Option | Segment Details | | |
| 41 | GR LHF <input type="text"/> | <input type="text"/> | After Standard Calendars | Segment Details | <input type="button" value="+"/> | <input type="button" value="-"/> |
| 43 | GR LHF <input type="text"/> | <input type="text"/> | After Standard Calendars | Segment Details | <input type="button" value="+"/> | <input type="button" value="-"/> |
| 45 | GR LHF <input type="text"/> | <input type="text"/> | After Standard Calendars | Segment Details | <input type="button" value="+"/> | <input type="button" value="-"/> |
| 42 | GR LHF <input type="text"/> | <input type="text"/> | After Standard Calendars | Segment Details | <input type="button" value="+"/> | <input type="button" value="-"/> |
| 44 | GR LHF <input type="text"/> | <input type="text"/> | After Standard Calendars | Segment Details | <input type="button" value="+"/> | <input type="button" value="-"/> |
| 46 | GR LHF <input type="text"/> | <input type="text"/> | After Standard Calendars | Segment Details | <input type="button" value="+"/> | <input type="button" value="-"/> |

| Field or Control | Description |
|--|---|
| <p>Processing Begin Date, Processing End Date, and Payment Date</p> | <p>Enter processing begin and end dates, and a payment date. These fields apply to processing effective-dated elements whose definition as of date (defined on the Element Name page) is set to <i>Process Begin Date</i>, <i>Process End Date</i>, or <i>Payment Date</i>.</p> <p>The dates determine which effective-dated rules (element definitions) to use for these elements and which period's accumulators to update for the elements.</p> <p>Say that the definition as of date for an entitlement element is set to <i>Process End Date</i>. When the system encounters the element during the batch process, it retrieves the element definition that was in effect on the date entered in the Processing End Date field.</p> <p>The system also updates the accumulators for the period in which the processing begin date or the processing end date falls.</p> |
| <p>Override Entire Calendar Run</p> | <p>Select to have the system process only calendars or segments that you designate for processing in the Calendars to Process group box or on the Segment Details page.</p> <p>If you do not select this check box, the system processes the calendars that you want to override (those listed in the Calendars to Process group box), plus any other calendars that are included in the calendar group.</p> |

Calendars to Process

In this group box, select the calendars for which you want to specify special processing instructions for the payee.

| Field or Control | Description |
|-------------------------|--|
| Sequence | Enter a number that determines the calendar processing order. |
| Pay Group | Enter the pay group that's associated with the calendar to be overridden. |
| Calendar ID | Enter the calendar to override. |
| Process Option | Applies only if the Override Entire Calendar Run check box is not selected (that is, you are overriding selected calendars only). Select the process option to determine whether the system is to process the calendars that have override instructions before or after all other calendars in the calendar group. Values are: <i>Before Standard Calendars</i> , <i>After Standard Calendars</i> , and <i>Not Applicable</i> . |
| Segment Details | Click this link to access the Segment Details page. |

Segment Details Page

Use the Segment Details page (GP_PYE_RUN_SEC) to create period segments for a payee and identify which segments to process.

Navigation:

Click the **Segment Details** link on the Payee Calendar Groups page.

| Field or Control | Description |
|---|---|
| Segment Begin Date and Segment End Date | Enter the dates to process in the calendar period and the dates not to process. Provide instructions for the entire calendar period. |

Note: To have the system calculate absence for part of a calendar period, you must create one or more period segmentation triggers for the payee. The trigger effective date must correspond to the dates that you enter on the Segment Details page. For example, to process absence for February 1 to 9, but not for the rest of the month, define a segmentation trigger for February 10.

Related Links

[Trigger Table Data](#)

Chapter 15

Configuring and Managing the Calendar Framework

Setup for Absence Calendar

This section explains the configuration of events in the calendar framework.

Organizations have the ability to configure custom events, like absences, general events, schedules, holidays, work anniversaries and birthdays.

Managers can view the availability of the direct and indirect reports in their team by using this calendar.

The configuration of the Calendar is discussed in this topic:

Common Elements Used for Calendars

| <i>Field or Control</i> | <i>Description</i> |
|-------------------------|--|
| Week | Defaults the Calendar to open in a weekly view. |
| Bi-Weekly | Defaults the Calendar to open in a bi-weekly view. |

Note: These settings apply to all form factors except smartphones. Using Smartphone, you can switch between daily and weekly views only.

Configure Calendar Page

The administrator can add custom events and manage general event using the Configure Calendar page.

Use the Configure Calendar page (HCSC_CAL_SETUP_FL) to add and manage events.

Navigation:

Set up HCM > Common Definitions > Calendar Framework > Configure Calendar

This example illustrates the fields and controls on the Configure Calendar page.

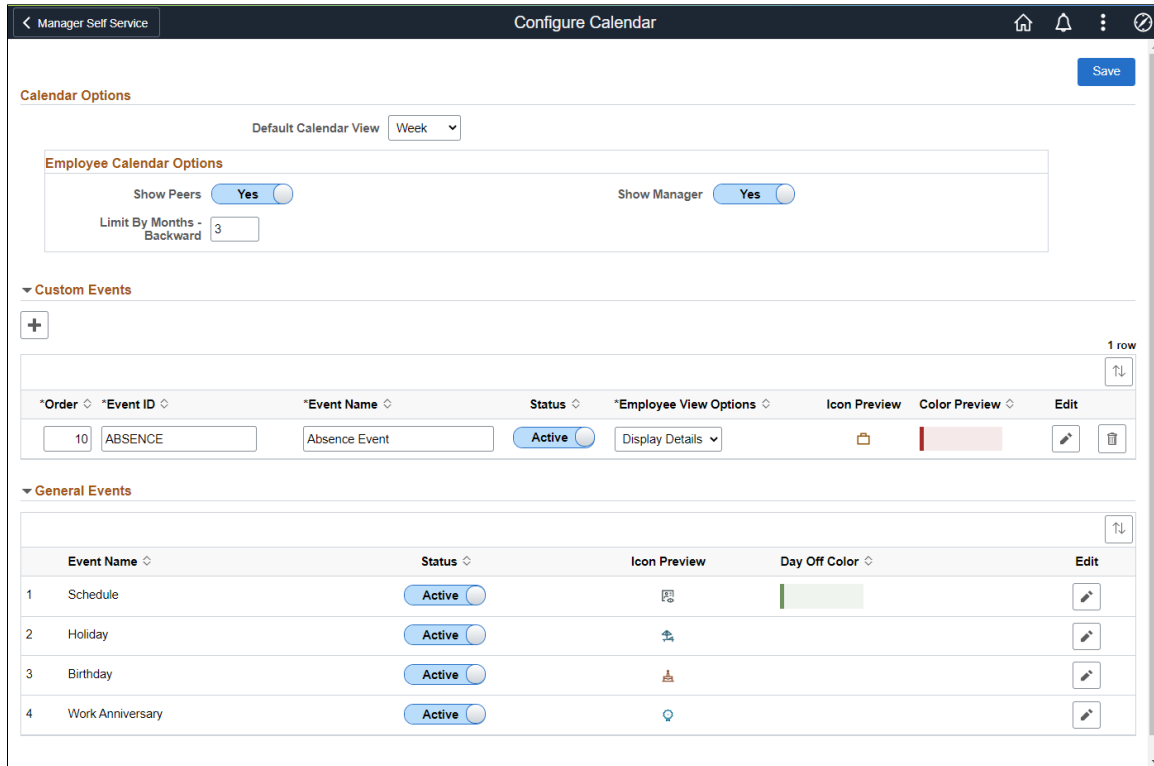

Note: The default calendar view is **Week** whereas the administrator can select the **Bi-Week** view from the drop-down list.

Employee Calendar Options

Employee Calendar Options are for employee calendar view setup.

| Field or Control | Description |
|-----------------------------------|--|
| Show Peers | Select Yes or No to show or hide peer information in the employee calendar. Note: This information comes from the direct reports set-up. |
| Show Manager | Select Yes or No to show or hide manager information in the employee calendar. |
| Limit By Months - Backward | Enter the number of months limit backwards that the employee can view. Note: 0 means no history. 0 means no history. Even after this set-up, grace days outside this limit show on the calendar depending on the view. |

Custom Events

Custom Events are events that can be added to the Team Calendar through the use Application Packages. The order, icon, and color can be specified by an organization.

| Field or Control | Description |
|------------------------------|---|
| Order | Controls the order in which the custom events are displayed on the Team Calendar page. The custom events are displayed on the calendar and the corresponding day details modal. |
| Event ID | The ID defined for an event. |
| Event Name | Define the name for an event. This name appears as section names in the day detail modal of the Team Calendar page. This name helps the managers and employees to manage the events on the User Preferences page. |
| Status | Set the status of the defined event. The status can either be active or inactive. The status controls if the event is made available for managers and employees to view and configure the event details, such as color. If you select the status as active, it shows on the calendar page. |
| Employee View Options | There are three options available: <ul style="list-style-type: none"> • Display Details: Select to show the details of the employee and event in the Employee Calendar. Event details derive from the app class definition. • Don't Display: Hide the event from the calendar. • Hide Details: Hide details will abstract the event name from showing up. For example, sick or vacation leave displays as just absence or event name specified for this row. |
| Icon Preview | Previews the uploaded icons. You can customize the icon by uploading a new icon on the Edit page. |
| Color Preview | Shows a preview of the color chosen for the event. The color can be changed on the Edit page. |
| Edit | Select to edit the custom event on the Calendar Configuration Page . |

| <i>Field or Control</i> | <i>Description</i> |
|--------------------------------|------------------------------------|
| Delete | Select to delete the custom event. |

General Events

General Events are delivered events by PeopleSoft. These are the default events, such as Schedule, Holiday, Birthday and Work Anniversary.

Note: If your organization needs to make changes to general events, then it's recommended to disable the delivered general event and create a new custom event.

General events are displayed in-line on the day boxes. Hence they do not have any colored background. Thus, there is no color configuration in the schedule, the Day Off color can be specified.

Calendar Configuration Page

Use the Calendar Configuration Page (HCSC_CAL_SETUP_SCF)

Select the **Edit** icon from the Custom Events section of the Configure Calendar page.

This example illustrates the Fields or controls and description for the Calendar Configuration modal page.

Cancel
Calendar Configuration
Done

Event Name Absence Event

▼ **Override Options**

Allow Color Override Yes

Allow Hiding Yes

▼ **Color Settings**

Choose a Color to be displayed for the event chosen. Color code option should start with # and 6 character hexadecimal value.

*Theme Solid Color ▼ Color Red ▼

▼ **Icon Settings**

*Icon PS_CAL_ABS_EVT_S_FL 🔍 📁

▼ **Data Source**

*Application Class Path HGA_CALENDAR_FL: 🔍

*Application Class ID AbsMgrCalendar 🔍

▼ **Security**

| | *Role Name ◇ | Description ◇ | |
|---|--------------------------|------------------------|-----|
| 1 | Absence Employee Fluid 🔍 | Absence Employee Fluid | + - |

| <i>Field or Control</i> | <i>Description</i> |
|--------------------------------|---|
| Allow Color Override | Select Yes or No to show or hide color override in the employee calendar. Set the Allow color Override to Yes to allow the managers and employees to select the Preferences from the Team Calendar page and change the color using the Calendar Preferences page . |
| Allow Hiding | Select Yes or No to show or hide override options in the employee calendar. |
| Theme | Select Color Code or Solid Code to select the solid color or enter the hexadecimal code as required. |

| Field or Control | Description |
|-------------------------------|--|
| Hexadecimal/ Color | <p>Color allows you to select the color from the drop down list.</p> <p>Hexadecimal to enter a hexadecimal code which start with # and 6 character hexadecimal value. This is used if Color code is selected as the Theme.</p> |
| Preview | Previews the color selected. |
| Application Class Path | <p>The data source is given as an application class path and ID, that specifies what has to be displayed on the Team Calendar grids.</p> <hr/> <p>Note: Refer to the Configuration and Implementation of Custom Events in Team Calendar technical brief (Doc ID 2837207.1) on My Oracle Support for more details on creating the application path and ID.</p> <hr/> |
| Application Class ID | Select the application Class ID that is connected with the Application Class Path. |
| Role Name | Defines which roles will have access to see the event on the calendar. |

Calendar Preferences page

Managers and Employees can use the Calendar Preferences to set up their calendar preferences (HCSC_CAL_USPREF_FL).

This example illustrates the fields and controls on the Calendar Preferences page.

Calendar Preferences Save

Event Configurations

Choose a Color to be displayed for the event chosen. Color code option should start with # and 6 character hexadecimal value. 2 rows

| | Event Name | Theme | Color | Hexadecimal | Color Preview | Show in Calendar |
|---|---------------|-------------|-------|-------------|---------------|-------------------------------------|
| 1 | Absence Event | Solid Color | Brown | | | <input checked="" type="checkbox"/> |
| 2 | Day Off | Color Code | | #6F915D | | <input type="checkbox"/> |

General Events

Show Schedule

Show Holiday

Show Birthday

Show Work Anniversary

| Field or Control | Description |
|-------------------------|---|
| Event Name | The event name displayed in the Day Detail modal page. |
| Theme | Select Solid Color or Color Code to define the color of the event. |
| Color | If Solid Color is selected, the Color field displays and the desired color can be selected from the drop-down. |
| Hexadecimal | If Color Code is selected, the hexadecimal field displays and the hexadecimal code must be entered to define the desired color. |
| Color Preview | Previews the color selected in the previous fields. |
| Show in Calendar | Select the slider to Yes or No to show it in the calendar. |

Administrators can use the Team Selection Parameters section to choose the fields to display on the Select Team page for the Administrator Calendar view.

This example illustrates the fields and controls on the Team Selection Parameters on the Calendar Preferences page for administrators.

Team Selection Parameters

Choose the fields to Display on the Change Team page .

Business Unit Display

Department Display

Job Code Display

Location Display

Reports To Hide

Supervisor ID Display

Direct Reports Configuration Page

The Direct Reports Configuration determines who appears in a manager's Team Calendar and who appears as a peer on an employee's calendar.

For the direct reports configuration of Team Calendar, fetch the manager's organization based on the **Access Type** defined in the direct reports configuration for the calendar component.

Navigation:

Set Up HCM > Common Definitions > Direct Reports for Managers > Direct Reports Interface > Direct Reports Configuration

This example illustrates direct reports configuration based on access type.

| Direct Reports Configuration | | | | |
|------------------------------|----------------------|--------------------------------|---------------------------|---|
| Manager Desktop Transactions | | | | |
| *Component Name | Transaction Name | *Description | | |
| HCSC_CALENDAR_FLU | <input type="text"/> | Calendar Fluid | Configure | — |
| HCTS_COMP_HIST_FL | <input type="text"/> | View Compensation History | Configure | — |
| HCTS_JOBCOMPDTL_FL | <input type="text"/> | View Job Competencies | Configure | — |
| HCTS_JOB_DTLS_FL | <input type="text"/> | View Job Details | Configure | — |
| HCTS_PERF_HIST_FL | <input type="text"/> | View Performance History | Configure | — |
| HCTS_REDIRECT_CMP | <input type="text"/> | Talent Summary | Configure | — |
| HCTS_REDIRECT_CMP2 | <input type="text"/> | Talent Summary Redirect | Configure | — |
| HCTS_START_PAGE_FL | <input type="text"/> | Employee Snapshot ActivityGuid | Configure | — |
| HGA_SS_BAL_FLU | <input type="text"/> | Absence Balance | Configure | — |
| HGA_SS_REQCAN_FLU | <input type="text"/> | Cancel Absences | Configure | — |
| HGA_SS_REQHIST_FLU | <input type="text"/> | View Absences | Configure | — |

Select **Configure** to access “Direct Reports Transaction Configuration Page” (Application Fundamentals). Add the component HCSC_CALENDAR_FLU to configure fluid calendar.

Note: The default **Access Type** as delivered is **By Part Posn Mgmt Supervisor**.

For more information, refer “Direct Reports Configuration Page” (Application Fundamentals).

Using Fluid Manager Calendar View

The Team Calendar for managers is a one-stop view for all the team direct reports calendars. The managers can perform necessary related actions when required very easily from here. The manager's direct and indirect reporters absence information is available at one glance in a day box format for both weekly and bi-weekly periods. The Team Calendar is available in smartphones for daily and weekly period views.

Page Used to View Manager Calendar

| <i>Page Name</i> | <i>Definition Name</i> | <i>Usage</i> |
|------------------------------|--|--|
| <u>Team Calendar Tile</u> | HC_HCSC_CALENDAR_FLU (this is the cref for the tile) | Access the Team Calendar page to view and manage the calendar for direct and indirect reporters. |
| <u>Team Calendar Views</u> | HCSC_CALENDAR_FLU | View the calendar for a week period |
| Team Calendar Bi-Weekly View | HCSC_CALENDAR_FLU | Select the tab to view biweekly calendar. |

Team Calendar Tile

Use the Team Calendar Tile to navigate to the Team Calendar page to view and manage the calendar and schedule for direct and indirect reporters.

Navigation

As a manager, you can add the tile, through personalization, to a system-delivered home page or a home page that you create.

This example illustrates the Team Calendar tile.

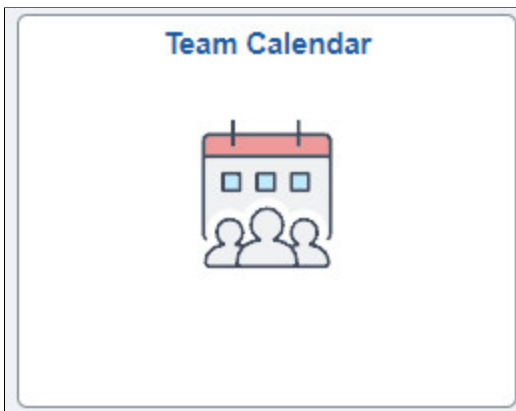

The role that needs to be assigned for administrators is **HCSC Calendar Admin** and for managers is **HCSC Calendar Manager**.

This example illustrates the Team Calendar tile in smartphone.

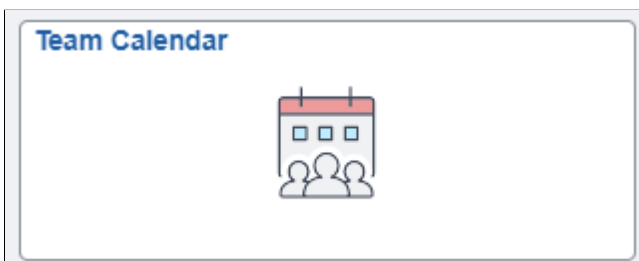

While using a smartphone, you can view the Team Calendars in Daily and Weekly mode and not in Weekly and Bi-Weekly mode as in other devices.

Video: [Image Highlights, PeopleSoft HCM Update Image 28: Manager Self Service Fluid Timesheet](#)

Team Calendar Views

The managers can use the Team Calendar page to view the direct and indirect reports all at once.

By default, the Team Calendar page displays week view. Toggle between the tabs to view the biweekly reports period.

This example illustrates the fields and controls of Team Calendar page weekly view with include indirects.

| Team | Starred | Filters | 8 November Monday | 9 Tuesday | 10 Wednesday | 11 Thursday | 12 Friday | 13 Saturday | 14 Sunday |
|--------------------------|---------------------------|---------|----------------------|----------------------|------------------|------------------|-----------------|----------------|--------------|
| ☆ Rosanna Channing (...) | Senior Accounting Mana... | 66 | 8 Hours | Vacation 8.00 Hrs | Sick 8.00 Hrs | Sick 8.00 Hrs | 8 Hours | Off Day | Off Day |
| ☆ Christelle Stevenson | Manager-Accounting | 14/14 | 8 Hours | 8 Hours | 8 Hours | 8 Hours | 8 Hours | Off Day | Off Day |
| ☆ Daryl Reese | Financial Analyst | | Jury 8.00 Hrs | 8 Hours | 8 Hours | 8 Hours | 8 Hours | Off Day | Off Day |
| ☆ David Ho | Senior Financial Analyst | | | | | | | | |
| ☆ Edmund Donahue | Manager-Accounting | 13/13 | 8:00 AM-5:00 PM | 8:00 AM-5:00 PM | 8:00 AM-5:00 PM | 8:00 AM-5:00 PM | 8:00 AM-5:00 PM | Off Day | Off Day |
| ☆ John Patterson | Manager-Revenue | 20/20 | 8 Hours | 8 Hours | 8 Hours | 8 Hours | 8 Hours | Off Day | Off Day |
| ☆ Mei Lee | Accountant | 11/11 | 8:00 AM-5:00 PM | Sick 2.00 Hrs | 8:00 AM-5:00 PM | 8:00 AM-5:00 PM | 8:00 AM-5:00 PM | Off Day | Off Day |
| ☆ Shawn Quilligan | Financial Analyst | | 8 Hours | 8 Hours | 8 Hours | 8 Hours | 8 Hours | Off Day | Off Day |
| ☆ Vicki Zinn | Accountant | | 8 Hours | 8 Hours | 8 Hours | 8 Hours | 8 Hours | Off Day | Off Day |

Include Indirects

This example illustrates the fields and controls of Team Calendar page weekly view.

The screenshot shows a 'Team Calendar' interface with a weekly view for February 21-27. The interface includes a search bar, navigation controls, and a table of employee schedules. The table columns represent days of the week, and rows represent individual team members. Each cell in the table shows the employee's name, job title, and scheduled hours. Some cells indicate 'Day Off' or 'Sick' status.

| Team | 21 February Today | 22 Tuesday | 23 Wednesday | 24 Thursday | 25 Friday | 26 Saturday | 27 Sunday |
|---|-------------------|-----------------|-----------------|-----------------|-----------------|-------------|-----------|
| John Patterson (You) Manager-Revenue | 8 Hours | 8 Hours | 8 Hours | 8 Hours | 8 Hours | Day Off | Day Off |
| Abagail Smith Billing Specialist | 8 Hours | 8 Hours | 8 Hours | 8 Hours | 8 Hours | Day Off | Day Off |
| Alex Duncan Accountant | | | | | | | |
| Allan Brand Analyst-HR/Payroll | | | | | | | |
| Brendan Sullivan Financial Analyst | 8:00 AM-5:00 PM | 8:00 AM-5:00 PM | 8:00 AM-5:00 PM | 8:00 AM-5:00 PM | 8:00 AM-5:00 PM | Day Off | Day Off |
| Christina Goodwill Accountant | | | | | | | |
| Cindy Bryson Billing Specialist | 8:00 AM-5:00 PM | 8:00 AM-5:00 PM | 8:00 AM-5:00 PM | 8:00 AM-5:00 PM | 8:00 AM-5:00 PM | Day Off | Day Off |
| Colin Davidson Financial Analyst | Sick 8:00 Hrs | 8 Hours | 8 Hours | 8 Hours | 8 Hours | Day Off | Day Off |
| Dan Atwood Financial Analyst | 8:00 AM-5:00 PM | 8:00 AM-5:00 PM | 8:00 AM-5:00 PM | 8:00 AM-5:00 PM | 8:00 AM-5:00 PM | Day Off | Day Off |
| David Stanfield Billing Specialist | 8:00 AM-5:00 PM | 8:00 AM-5:00 PM | 8:00 AM-5:00 PM | 8:00 AM-5:00 PM | 8:00 AM-5:00 PM | Day Off | Day Off |
| Frieda Johnson Accountant | | | | | | | |
| Janice Worthington Financial Analyst | 8:00 AM-5:00 PM | 8:00 AM-5:00 PM | 8:00 AM-5:00 PM | 8:00 AM-5:00 PM | 8:00 AM-5:00 PM | Day Off | Day Off |
| John Russak Financial Analyst | 8:00 AM-5:00 PM | 8:00 AM-5:00 PM | 8:00 AM-5:00 PM | 8:00 AM-5:00 PM | 8:00 AM-5:00 PM | Day Off | Day Off |
| Kai MacKenzie Billing Specialist | 8:00 AM-5:00 PM | 8:00 AM-5:00 PM | 8:00 AM-5:00 PM | 8:00 AM-5:00 PM | 8:00 AM-5:00 PM | Day Off | Day Off |
| J. Iam, (P)au | | | | | | Day Off | Day Off |

This example illustrates the daily view of Team Calendar page in smartphone.

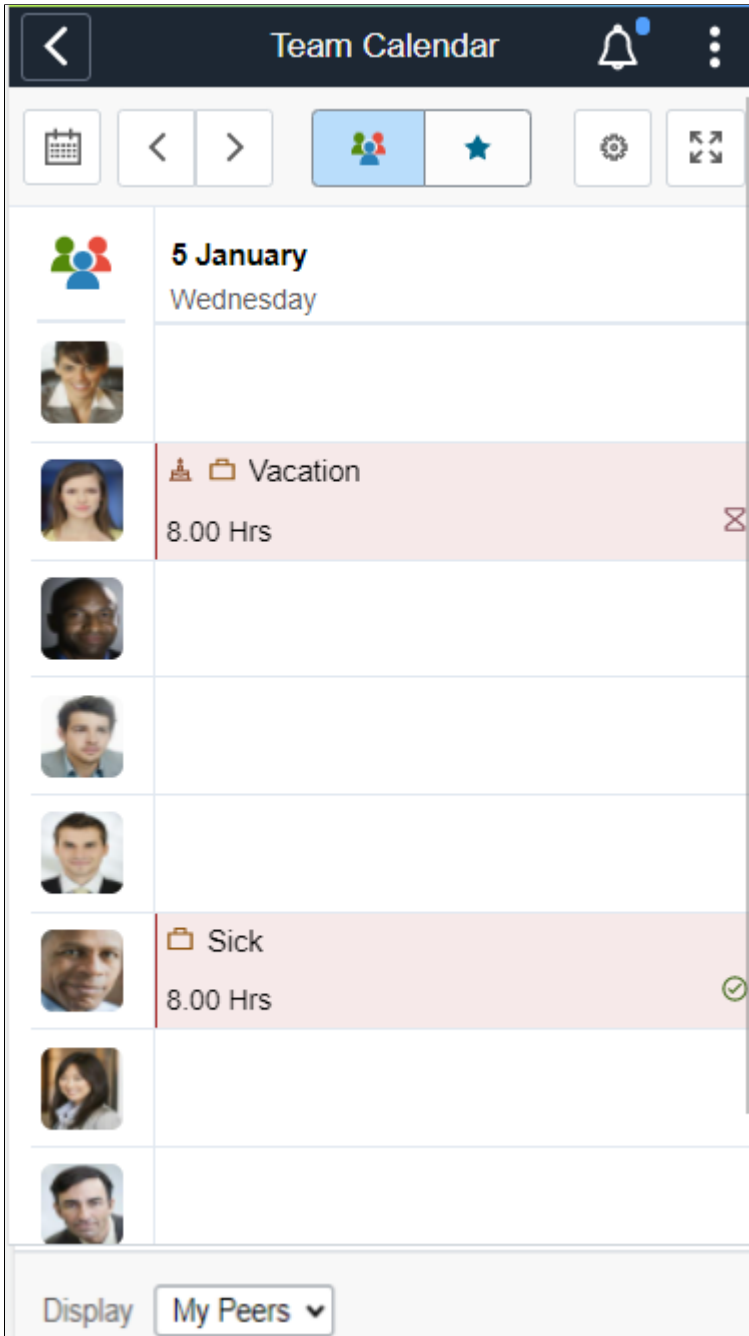

The smartphone supports only Daily and Weekly modes.

Select the Bi-Weekly tab to view the calendar for two weeks.

This example illustrates the fields and controls of Team Calendar page Bi Weekly page with include indirects.

| Team | 8 Nov | 9 | 10 | 11 | 12 | 13 | 14 | 15 | 16 | 17 | 18 | 19 | 20 | 21 |
|------------------------|-----------------|-------------------|-----------------|-----------------|-----------------|---------|---------|-----------------|-----------------|-----------------|-----------------|-----------------|---------|---------|
| Rosanna Channing (You) | 8 Hours | Vacation 8.00 Hrs | Sick 8.00 Hrs | Sick 8.00 Hrs | 8 Hours | Off Day | Off Day | 8 Hours | 8 Hours | 8 Hours | 8 Hours | 8 Hours | Off Day | Off Day |
| Abigail Smith | 8 Hours | 8 Hours | 8 Hours | 8 Hours | 8 Hours | Off Day | Off Day | 8 Hours | 8 Hours | 8 Hours | 8 Hours | 8 Hours | Off Day | Off Day |
| Alan Carr | 8:00 AM-5:00 PM | 8:00 AM-5:00 PM | 8:00 AM-5:00 PM | 8:00 AM-5:00 PM | 8:00 AM-5:00 PM | Off Day | Off Day | 8:00 AM-5:00 PM | 8:00 AM-5:00 PM | 8:00 AM-5:00 PM | 8:00 AM-5:00 PM | 8:00 AM-5:00 PM | Off Day | Off Day |
| Alex Duncan | | | | | | | | | | | | | | |
| Allan Brand | | | | | | | | | | | | | | |
| April Brown | 8:00 AM-5:00 PM | 8:00 AM-5:00 PM | 8:00 AM-5:00 PM | 8:00 AM-5:00 PM | 8:00 AM-5:00 PM | Off Day | Off Day | 8:00 AM-5:00 PM | 8:00 AM-5:00 PM | 8:00 AM-5:00 PM | 8:00 AM-5:00 PM | 8:00 AM-5:00 PM | Off Day | Off Day |
| Branda Abad | 8:00 AM-5:00 PM | 8:00 AM-5:00 PM | 8:00 AM-5:00 PM | 8:00 AM-5:00 PM | 8:00 AM-5:00 PM | Off Day | Off Day | 8:00 AM-5:00 PM | 8:00 AM-5:00 PM | 8:00 AM-5:00 PM | 8:00 AM-5:00 PM | 8:00 AM-5:00 PM | Off Day | Off Day |
| Brendan Sullivan | 8:00 AM-5:00 PM | 8:00 AM-5:00 PM | 8:00 AM-5:00 PM | 8:00 AM-5:00 PM | 8:00 AM-5:00 PM | Off Day | Off Day | 8:00 AM-5:00 PM | 8:00 AM-5:00 PM | 8:00 AM-5:00 PM | 8:00 AM-5:00 PM | 8:00 AM-5:00 PM | Off Day | Off Day |
| Brenton Francisco | 7:00 AM-6:00 PM | 7:00 AM-6:00 PM | 7:00 AM-6:00 PM | 7:00 AM-6:00 PM | 7:00 AM-6:00 PM | Off Day | Off Day | 7:00 AM-6:00 PM | 7:00 AM-6:00 PM | 7:00 AM-6:00 PM | 7:00 AM-6:00 PM | 7:00 AM-6:00 PM | Off Day | Off Day |
| Cecil Greens | 8:00 AM-5:00 PM | 8:00 AM-5:00 PM | 8:00 AM-5:00 PM | 8:00 AM-5:00 PM | 8:00 AM-5:00 PM | Off Day | Off Day | 8:00 AM-5:00 PM | 8:00 AM-5:00 PM | 8:00 AM-5:00 PM | 8:00 AM-5:00 PM | 8:00 AM-5:00 PM | Off Day | Off Day |
| Chase Calder | 8 Hours | 8 Hours | 8 Hours | 8 Hours | 8 Hours | Off Day | Off Day | 8 Hours | 8 Hours | 8 Hours | 8 Hours | 8 Hours | Off Day | Off Day |
| Chris Cameron | 8 Hours | 8 Hours | 8 Hours | 8 Hours | 8 Hours | Off Day | Off Day | 8 Hours | 8 Hours | 8 Hours | 8 Hours | 8 Hours | Off Day | Off Day |
| Christelle Stevenson | 8 Hours | 8 Hours | 8 Hours | 8 Hours | 8 Hours | Off Day | Off Day | 8 Hours | 8 Hours | 8 Hours | 8 Hours | 8 Hours | Off Day | Off Day |
| Christina Goodwill | | | | | | | | | | | | | | |
| Cindy Bains | 8:00 AM-5:00 PM | 8:00 AM-5:00 PM | 8:00 AM-5:00 PM | 8:00 AM-5:00 PM | 8:00 AM-5:00 PM | Off Day | Off Day | 8:00 AM-5:00 PM | 8:00 AM-5:00 PM | 8:00 AM-5:00 PM | 8:00 AM-5:00 PM | 8:00 AM-5:00 PM | Off Day | Off Day |
| Cindy Bryson | 8:00 AM-5:00 PM | 8:00 AM-5:00 PM | 8:00 AM-5:00 PM | 8:00 AM-5:00 PM | 8:00 AM-5:00 PM | Off Day | Off Day | 8:00 AM-5:00 PM | 8:00 AM-5:00 PM | 8:00 AM-5:00 PM | 8:00 AM-5:00 PM | 8:00 AM-5:00 PM | Off Day | Off Day |







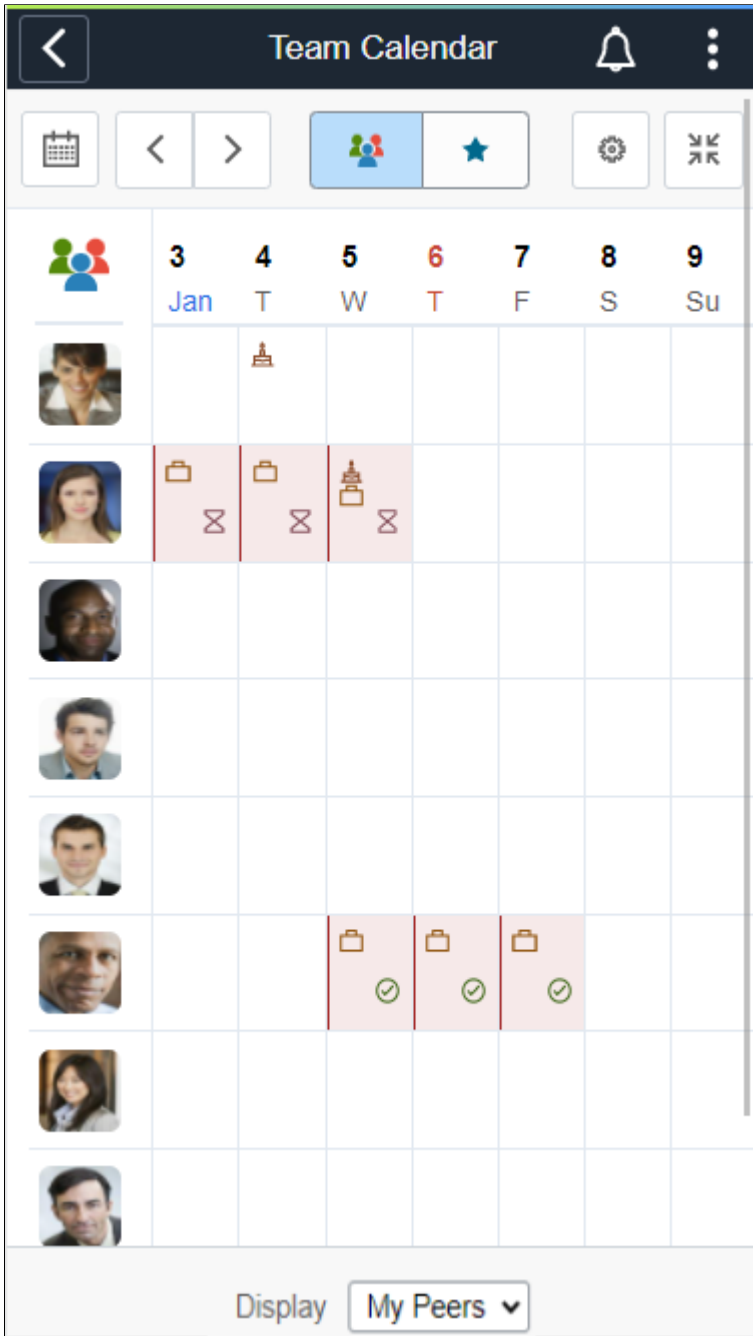

This example illustrates the fields and controls of Team Calendar page Bi Weekly page.

| Team | 8 Nov | 9 | 10 | 11 | 12 | 13 | 14 | 15 | 16 | 17 | 18 | 19 | 20 | 21 |
|------------------------|---------------|-------------------|---------------|---------------|--------------|---------|---------|--------------|--------------|---------------|---------------|--------------|---------|---------|
| Rosanna Channing (...) | 8 Hours | Vacation 8.00 Hrs | Sick 8.00 Hrs | Sick 8.00 Hrs | 8 Hours | Off Day | Off Day | 8 Hours | 8 Hours | 8 Hours | 8 Hours | 8 Hours | Off Day | Off Day |
| Christelle Stevenson | 8 Hours | 8 Hours | 8 Hours | 8 Hours | 8 Hours | Off Day | Off Day | 8 Hours | 8 Hours | 8 Hours | 8 Hours | 8 Hours | Off Day | Off Day |
| Daryl Reese | Jury 8.00 Hrs | 8 Hours | 8 Hours | 8 Hours | 8 Hours | Off Day | Off Day | 8 Hours | 8 Hours | 8 Hours | 8 Hours | 8 Hours | Off Day | Off Day |
| David Ho | | | | | | | | | | | | | | |
| Edmund Donahue | 8:00 AM-5:00 | 8:00 AM-5:00 | 8:00 AM-5:00 | 8:00 AM-5:00 | 8:00 AM-5:00 | Off Day | Off Day | 8:00 AM-5:00 | 8:00 AM-5:00 | 8:00 AM-5:00 | 8:00 AM-5:00 | 8:00 AM-5:00 | Off Day | Off Day |
| John Patterson | 8 Hours | 8 Hours | 8 Hours | 8 Hours | 8 Hours | Off Day | Off Day | 8 Hours | 8 Hours | Sick 8.00 Hrs | Sick 8.00 Hrs | 8 Hours | Off Day | Off Day |
| Mei Lee | 8:00 AM-5:00 | Sick 2.00 Hrs | 8:00 AM-5:00 | 8:00 AM-5:00 | 8:00 AM-5:00 | Off Day | Off Day | 8:00 AM-5:00 | 8:00 AM-5:00 | 8:00 AM-5:00 | 8:00 AM-5:00 | 8:00 AM-5:00 | Off Day | Off Day |
| Shawn Quilligan | 8 Hours | 8 Hours | 8 Hours | 8 Hours | 8 Hours | Off Day | Off Day | 8 Hours | 8 Hours | 8 Hours | 8 Hours | 8 Hours | Off Day | Off Day |
| Vicki Zinn | 8 Hours | 8 Hours | 8 Hours | 8 Hours | 8 Hours | Off Day | Off Day | 8 Hours | 8 Hours | 8 Hours | 8 Hours | 8 Hours | Off Day | Off Day |

This example illustrates the fields and controls of Team Calendar page Weekly page in smartphone.

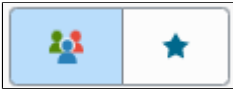

| Field or Control | Description |
|---|---------------------------------------|
| Search Name or Job Title | Field to search by name or job title. |
|  | Show legends and their description. |

| Field or Control | Description |
|---|--|
|  | Select to open a modal page from where you can select to display in Calendar and Preferences. |
|  | Slide to include indirect reporters. |
|  | Select My Team or My Peer from the drop-down list. |
|  | Select to star an employee for comparison. This icon highlights when the starred employee is selected. |
|  | Select to view calendar. You can select a date from here. |
|  | Select to navigate to previous or next day in calendar. |
|  | Toggle between team and star view while using smartphone. |
|  | Toggle between daily and weekly view in smartphone. |
|  | Main menu to go to Team Calendar page with team and starred view. |

Note: While using a smartphone, you can view the Team Calendars in Daily and Weekly mode and not in Weekly and Bi-Weekly mode as in other devices.

This example illustrates the fields and controls of Team Calendar page includes indirect reports.

| Team | Starred | Filters | 1 November | 2 | 3 | 4 | 5 | 6 | 7 |
|------|---------|---------------------------|----------------------------|----------------------------|-----------------|-----------------|-----------------|----------|---------|
| | | | Monday | Tuesday | Wednesday | Thursday | Friday | Saturday | Sunday |
| ☆ | | Senior Accounting Manager | 8 Hours | 8 Hours | 8 Hours | 8 Hours | 8 Hours | Off Day | Off Day |
| ☆ | | Billing Specialist | 8 Hours | 8 Hours | 8 Hours | 8 Hours | 8 Hours | Off Day | Off Day |
| ☆ | | Finance Specialist | 8:00 AM-5:00 PM | 8:00 AM-5:00 PM | 8:00 AM-5:00 PM | 8:00 AM-5:00 PM | 8:00 AM-5:00 PM | Off Day | Off Day |
| ☆ | | Accountant | | | | | | | |
| ☆ | | Analyst-HR/Payroll | | | | | | | |
| ☆ | | Data Entry Operator | 8:00 AM-5:00 PM | 8:00 AM-5:00 PM | 8:00 AM-5:00 PM | 8:00 AM-5:00 PM | 8:00 AM-5:00 PM | Off Day | Off Day |
| ☆ | | Data Entry Operator | 8:00 AM-5:00 PM | 8:00 AM-5:00 PM | 8:00 AM-5:00 PM | 8:00 AM-5:00 PM | 8:00 AM-5:00 PM | Off Day | Off Day |
| ☆ | | Financial Analyst | 8:00 AM-5:00 PM | 8:00 AM-5:00 PM | 8:00 AM-5:00 PM | 8:00 AM-5:00 PM | 8:00 AM-5:00 PM | Off Day | Off Day |
| ☆ | | Finance Specialist | 7:00 AM-6:00 PM | 7:00 AM-6:00 PM | 7:00 AM-6:00 PM | 7:00 AM-6:00 PM | Off Day | Off Day | Off Day |
| ☆ | | File Clerk | 8:00 AM-5:00 PM | 8:00 AM-5:00 PM | 8:00 AM-5:00 PM | 8:00 AM-5:00 PM | 8:00 AM-5:00 PM | Off Day | Off Day |
| ☆ | | General Ledger Specialist | 8 Hours | 8 Hours | 8 Hours | 8 Hours | 8 Hours | Off Day | Off Day |
| ☆ | | Finance Specialist | 8 Hours | 8 Hours | 8 Hours | 8 Hours | 8 Hours | Off Day | Off Day |
| ☆ | | Manager-Accounting | UI Design Training 4:00 | UI Design Training 4:00 | 8 Hours | 8 Hours | 8 Hours | Off Day | Off Day |
| ☆ | | Accountant | | | | | | | |
| ☆ | | | | | | | | Off Day | Off Day |
| ☆ | | Billing Specialist | 8:00 AM-5:00 PM | 8:00 AM-5:00 PM | 8:00 AM-5:00 PM | 8:00 AM-5:00 PM | 8:00 AM-5:00 PM | Off Day | Off Day |
| ☆ | | Financial Analyst | 8 Hours | 8 Hours | 8 Hours | 8 Hours | 8 Hours | Off Day | Off Day |
| ☆ | | | | | | | | Off Day | Off Day |

This example illustrates the Team Calendar Page_Include Indirect in smartphone

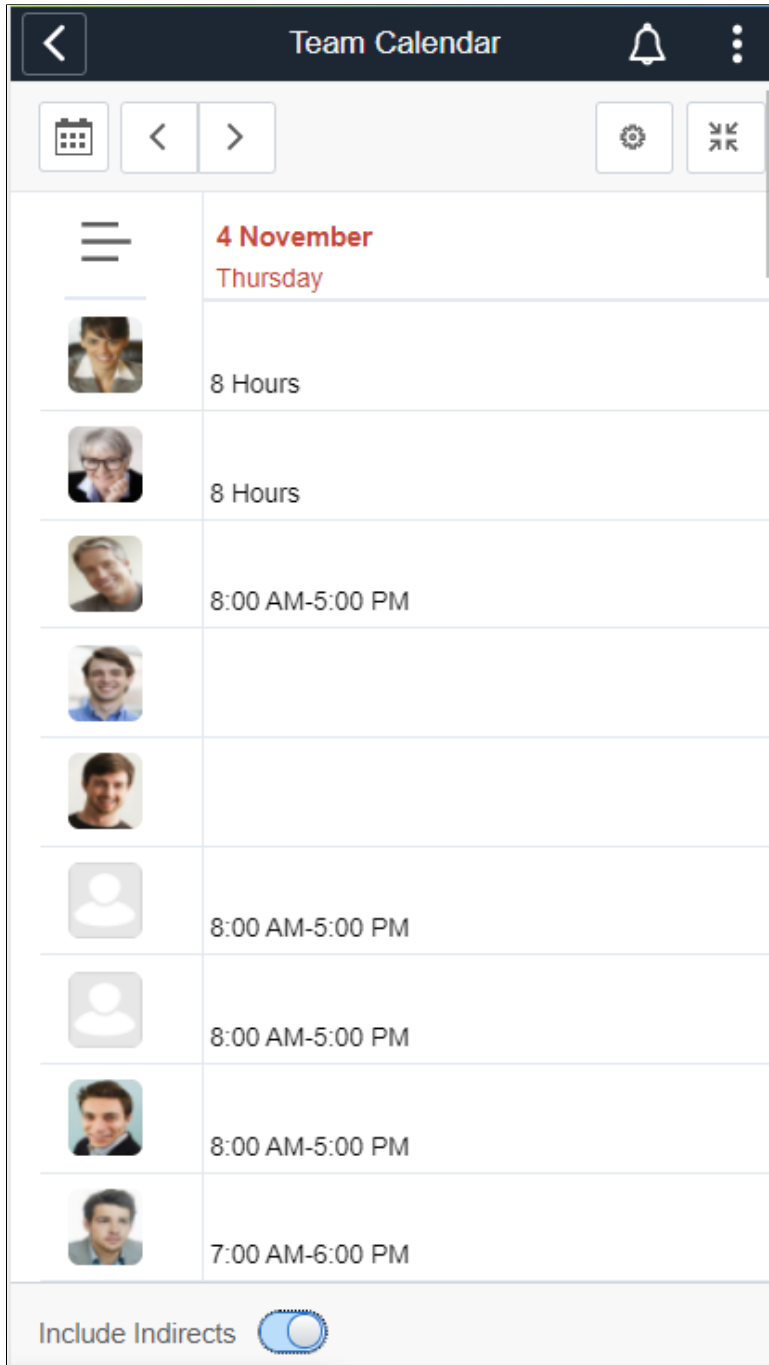

This example illustrates the Team Calendar page includes My Peers in smartphone.

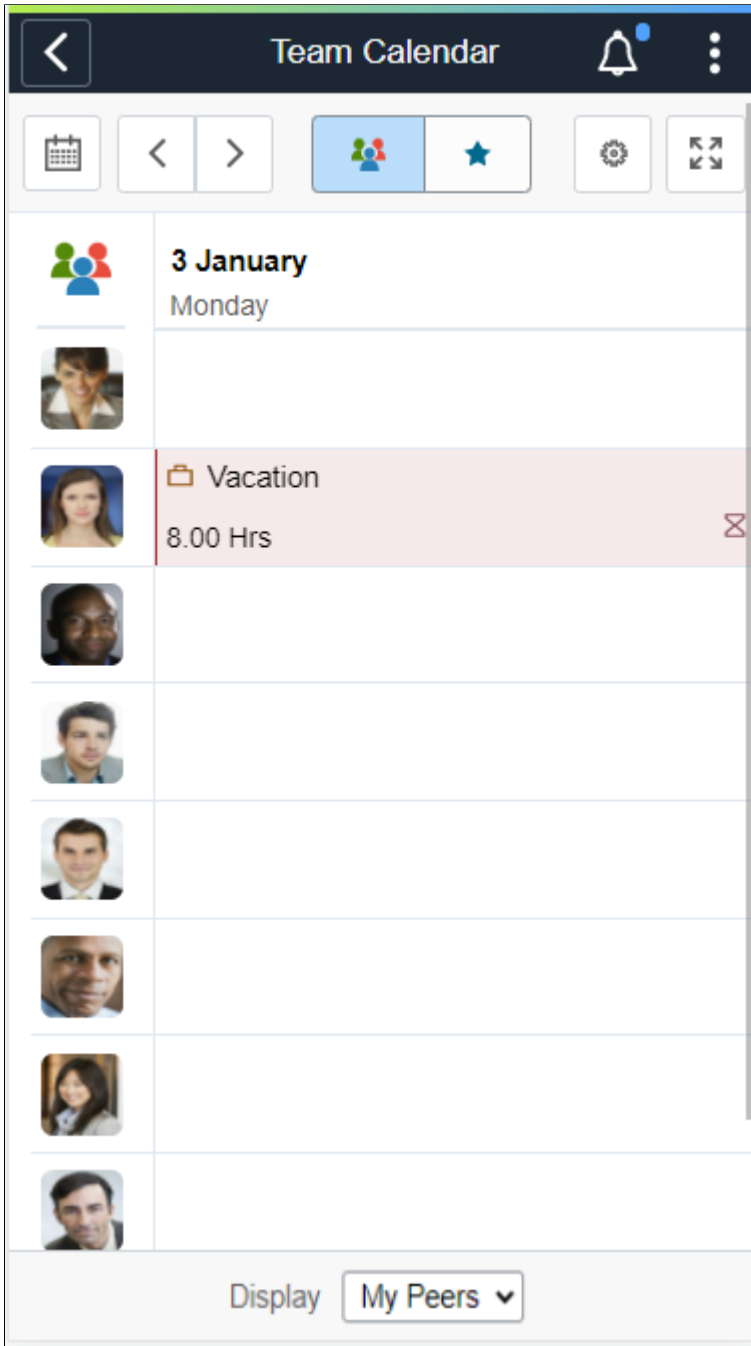

Select the **Include Indirects** from the footer to view the flattened list of the team reporting or colleagues of the logged in manager.

Select the day box for an employee to view the **Details** modal, from where the manager can select the related actions and do the necessary operations.

While using a smartphone, to view the team and starred employees in a single page, select the menu icon.



This example illustrates the files and controls of Team Calendar starred comparison view in smartphone.

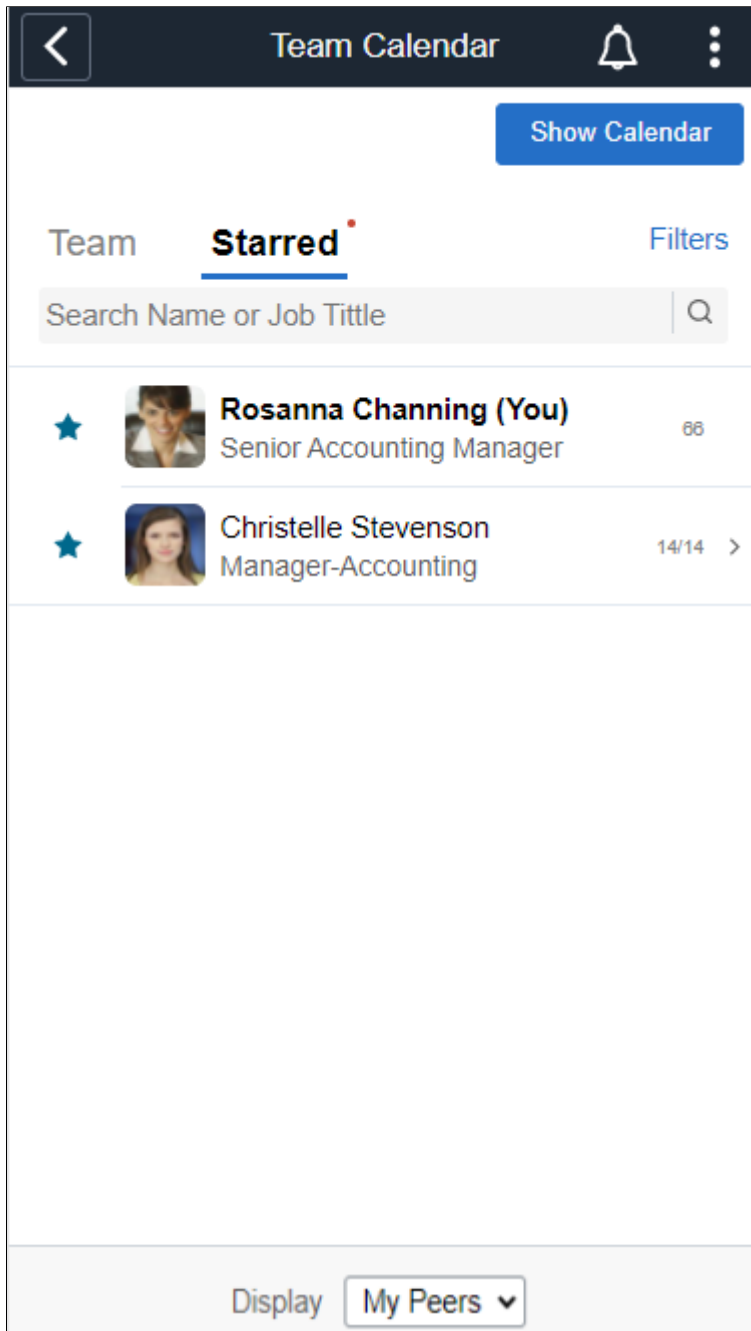

Select the  button to view calendar for selected option. You can view the report in

daily or weekly view by selecting the  button.

This example illustrates the Team comparison weekly view using smartphone.

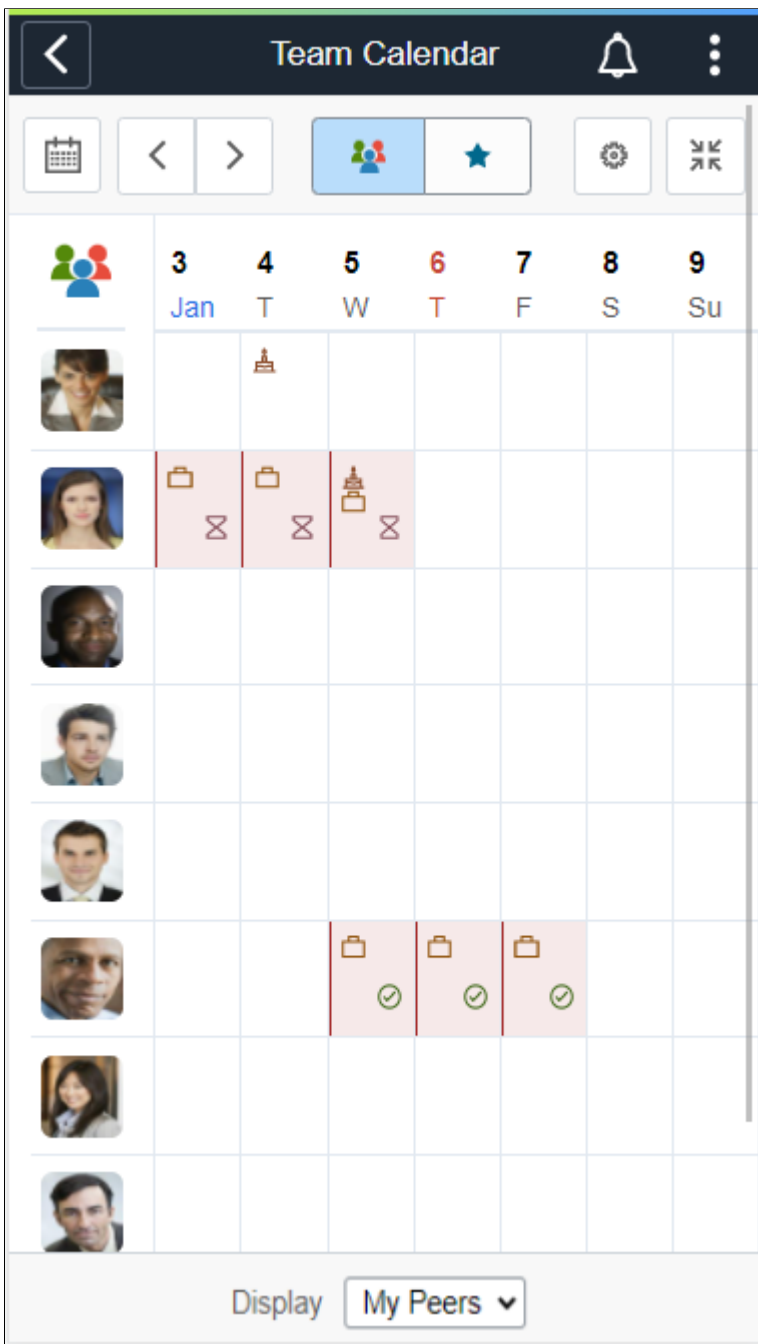

This example illustrates the starred employees comparison view in smartphone.

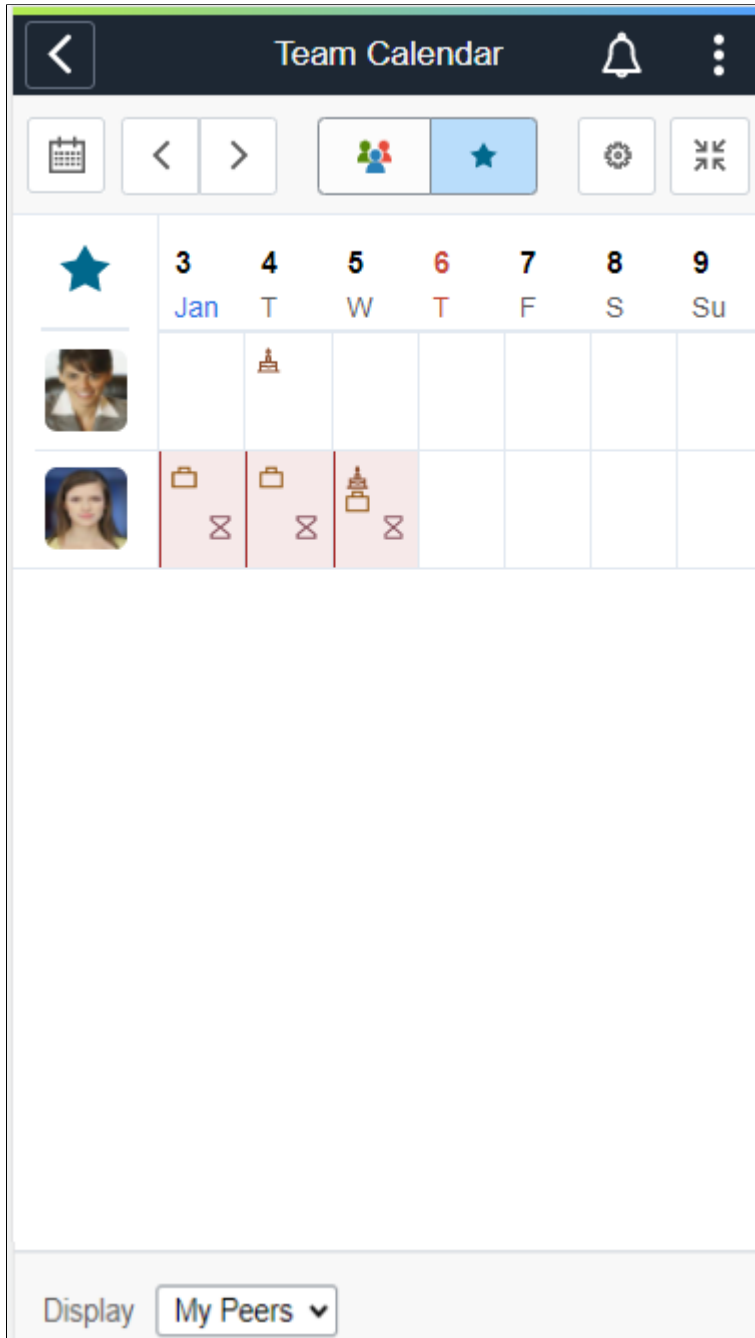

This example illustrates the fields and controls of Team Calendar with details.

The screenshot displays the 'Team Calendar' interface. At the top, there's a navigation bar with 'Manager Self Service' and 'Team Calendar' labels, along with home, search, and notification icons. Below this, a search bar is labeled 'Search Name or Job Title'. The main area is a calendar grid for the week of February 21-27, 2022. The grid lists team members and their work hours. A 'Details' modal is open over Colin Davidson's 'Sick' event on Feb 21. The modal contains the following information:

- Date: 21 Feb 2022, Monday
- Team Member: Colin Davidson, Financial Analyst
- Absence Event: Sick - 8.00 Hours, Period - 2/1/22/2022, Status - Submitted
- Schedule: Elapsed - 8 Hours, Shift - KUELPSHF1 - 8 Hour Elapsed Shift

| Team Member | 21 February Today | 22 Tuesday | 23 Wednesday | 24 Thursday | 25 Friday | 26 Saturday | 27 Sunday |
|--------------------------------------|-------------------|-----------------|-----------------|-----------------|-----------------|-------------|-----------|
| John Patterson (You) Manager-Revenue | 8 Hours | 8 Hours | 8 Hours | 8 Hours | 8 Hours | Day Off | Day Off |
| Abagail Smith Billing Specialist | 8 Hours | 8 Hours | | | | Day Off | Day Off |
| Alex Duncan Accountant | | | | | | | |
| Allan Brand Analyst-HR/Payroll | | | | | | | |
| Brendan Sullivan Financial Analyst | 8:00 AM-5:00 PM | 8:00 AM-5:00 PM | | | 8:00 AM-5:00 PM | Day Off | Day Off |
| Christina Goodwill Accountant | | | | | | | |
| Cindy Bryson Billing Specialist | 8:00 AM-5:00 PM | 8:00 AM-5:00 PM | | | 8:00 AM-5:00 PM | Day Off | Day Off |
| Colin Davidson Financial Analyst | Sick - 8.00 Hrs | 8 Hours | | | 8:00 AM-5:00 PM | Day Off | Day Off |
| Dan Atwood Financial Analyst | 8:00 AM-5:00 PM | 8:00 AM-5:00 PM | | | 8:00 AM-5:00 PM | Day Off | Day Off |
| David Stanfield Billing Specialist | 8:00 AM-5:00 PM | 8:00 AM-5:00 PM | | | 8:00 AM-5:00 PM | Day Off | Day Off |
| Frieda Johnson Accountant | | | | | | | |
| Jahice Worthington Financial Analyst | 8:00 AM-5:00 PM | 8:00 AM-5:00 PM | 8:00 AM-5:00 PM | 8:00 AM-5:00 PM | 8:00 AM-5:00 PM | Day Off | Day Off |
| John Russak Financial Analyst | 8:00 AM-5:00 PM | 8:00 AM-5:00 PM | 8:00 AM-5:00 PM | 8:00 AM-5:00 PM | 8:00 AM-5:00 PM | Day Off | Day Off |
| Kai MacKenzie Billing Specialist | 8:00 AM-5:00 PM | 8:00 AM-5:00 PM | 8:00 AM-5:00 PM | 8:00 AM-5:00 PM | 8:00 AM-5:00 PM | Day Off | Day Off |
| Liam Gray | | | | | | Day Off | Day Off |

This example illustrates the Team Calendar with details in smartphone.

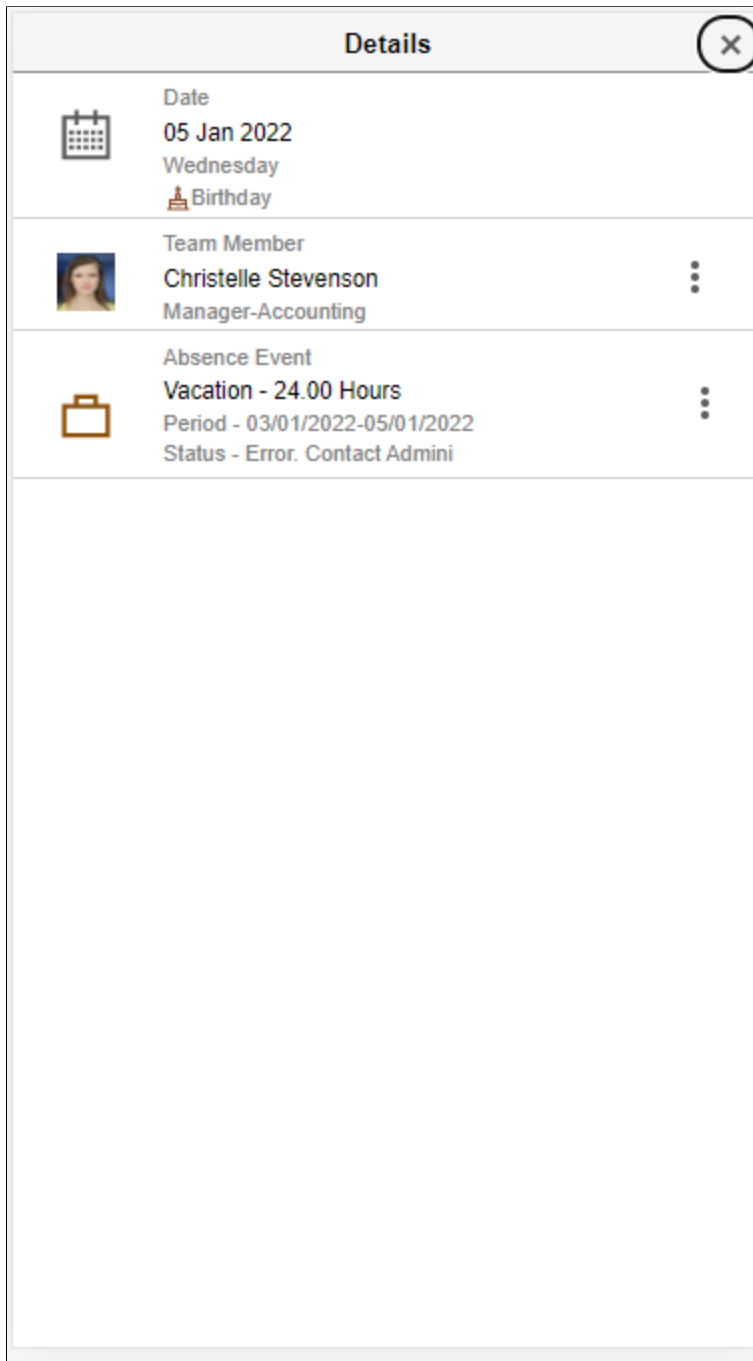

Select  on the **Details** modal to open the related actions. From here, the managers can perform the actions.

This example illustrates the fields and controls of Team Calendar with related actions.

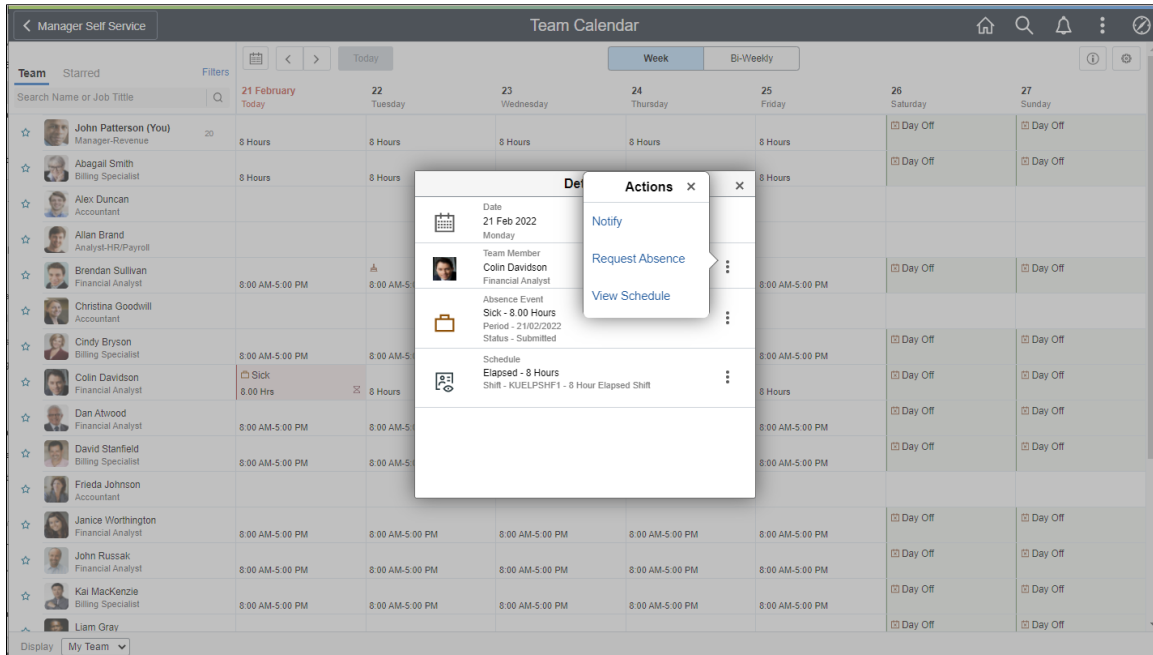

This example illustrates the related actions in smartphone.

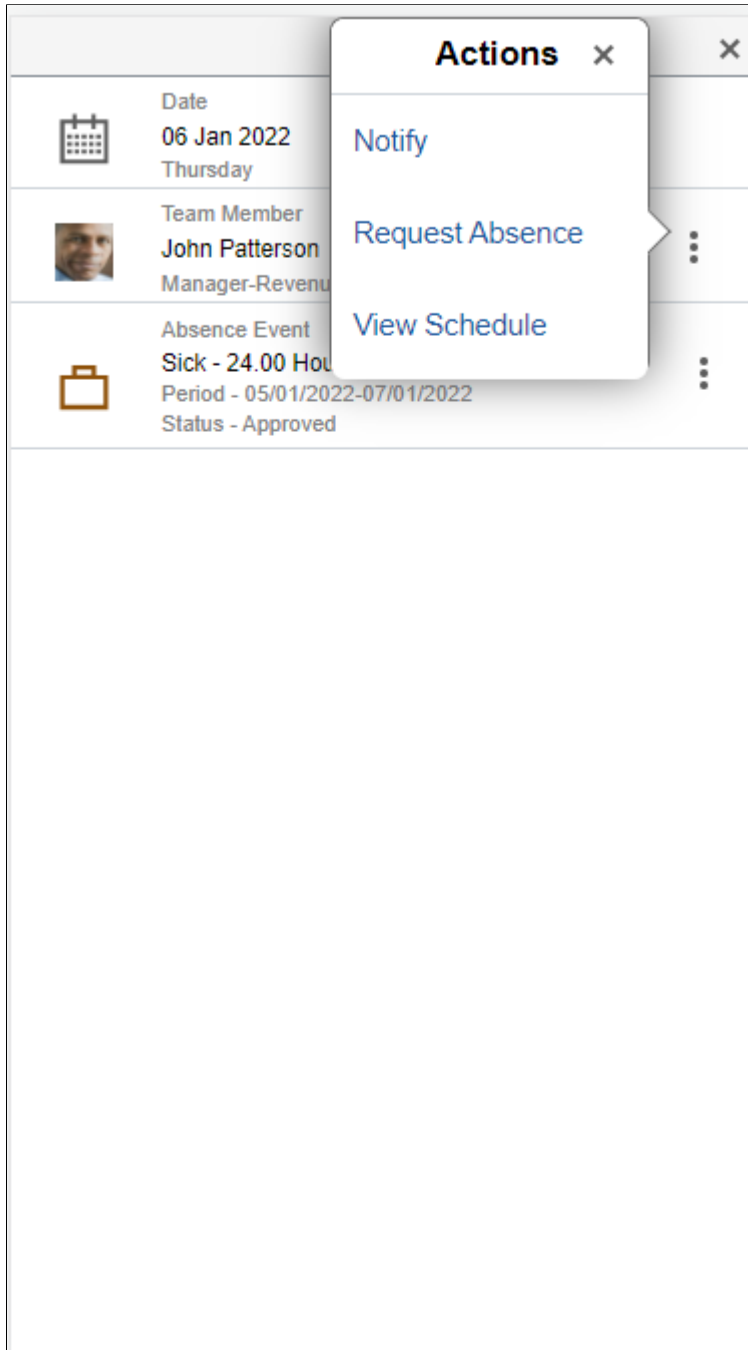

Note: The organizations can configure which related actions to show.

By selecting the star next to select employees you can do a quick comparison of them.

This example illustrates the fields and controls of Team Calendar with starred employees.

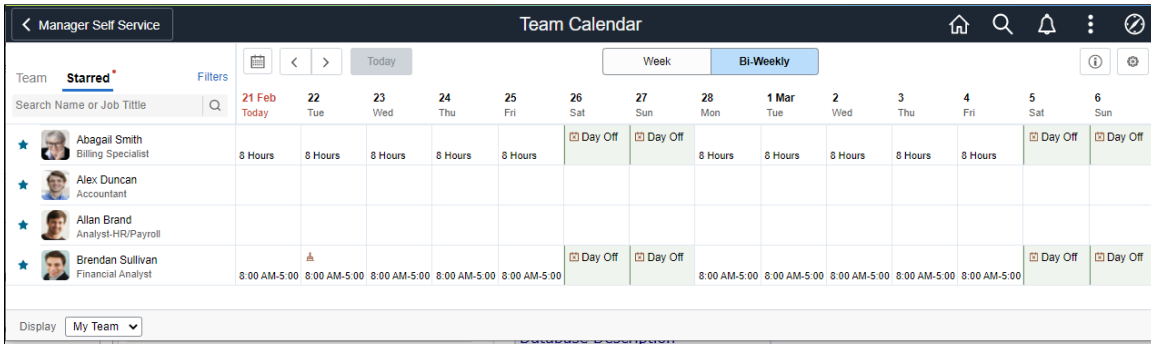

This example illustrates the fields and controls of the Display in Calendar modal.

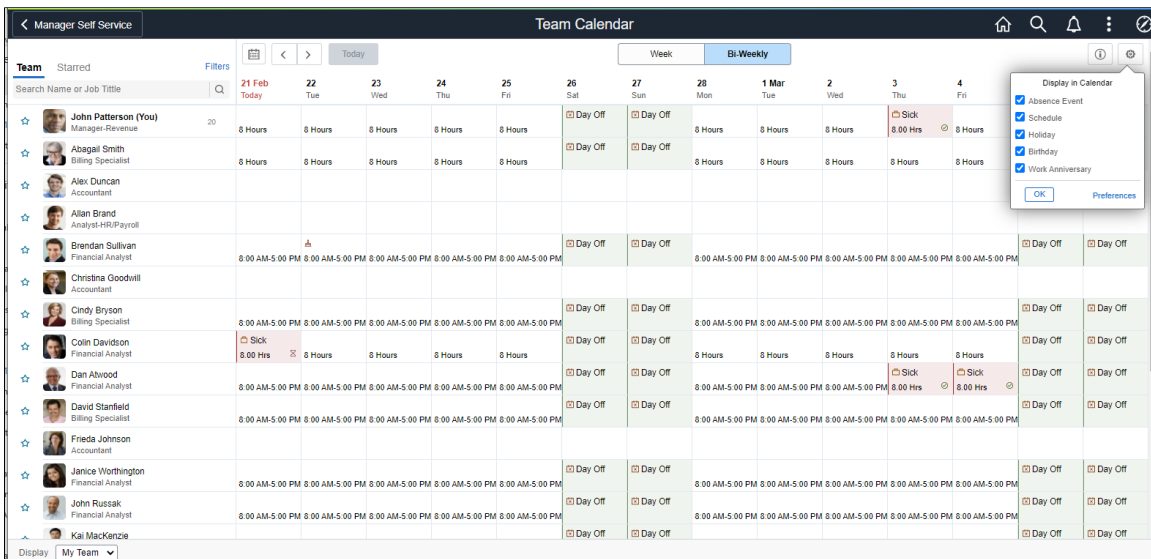

This example illustrates the legends and Display in Calendar in smartphone

Calendar Preference ×

▼ **Display in Calendar**

Absence Event

Holiday

Birthday

Work Anniversary

▼ **Legend**

 Absence Event

Team Calendar is enabled for delegation as an initiating transaction. Delegates will be allowed to see all the events for the employees from whom the request was delegated.

This example illustrates the calendar view of a delegated employee.

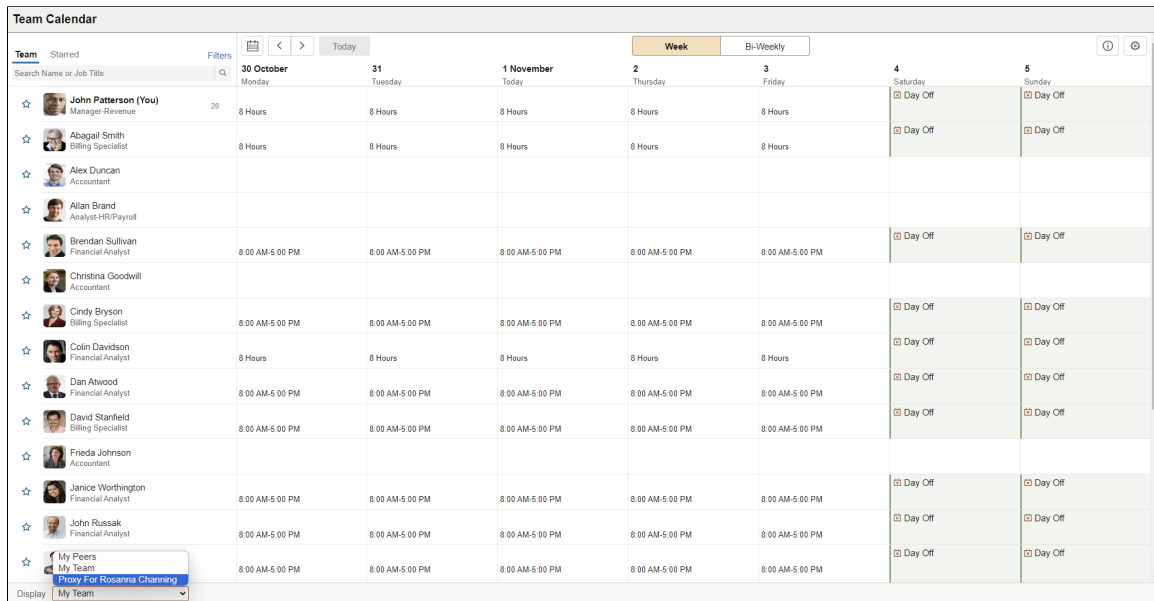

Using Fluid Administrator Calendar View

The Administrator Calendar is a one-stop view for all the team direct reports calendars.

The administrators can select the required team calendar to perform necessary related actions when required very easily from here. The direct and indirect reporters absence information is available at one glance in a day box format for both weekly and bi-weekly periods. The Administrator Calendar is available in smartphones for daily and weekly period views.

Pages Used to View Administrator Calendar

| Page Name | Definition Name | Usage |
|---|---|---|
| Administrator Calendar Tile | HCSC_CAL_ADM_FL (this is the cref for the tile) | Access the Administrator Calendar page to view and manage different team calendars for direct and indirect reporters. |
| Select Team page | HCSC_CAL_ADM_FL | Use the search fields to open the required team calendar. |
| Team Calendar Views | HCSC_CALENDAR_FLU | View the calendar for a week period. |

Administrator Calendar Tile

Use the Administrator Calendar Tile to navigate to the Select Team page where the admins can select the required team to view the Team calendar and schedule for direct and indirect reporters.

Navigation:

As an administrator, you can add the tile, through personalization, to a system-delivered home page or a home page that you create.

This example illustrates the Administrator Calendar tile.



Select Team page

Use the Select Team page (HCSC_CAL_ADM_FL) to navigate to the required Team calendar view.

Navigation:

Select the [Administrator Calendar Tile](#).

Search fields on the Select Team page can be modified using the calendar preferences page. For more information, see the [Calendar Preferences page](#) topic.

The Select Team page is in place to prevent listing the entire employees on the Team Calendar page. In addition, the list of employees are limited to 300 entries on the Team Calendar page. The user must further refine the search, if the search criteria results in more than 300.

This example illustrates the Select Team page.

 A screenshot of a web application window titled "Select Team". The window has a "Cancel" button on the top left and a "Done" button on the top right. The main area contains six search fields, each with a magnifying glass icon on the right: "SetID", "Business Unit", "Department ID", "Location Code", "Supervisor ID", and "Job Code". Below these fields is a "Reset" button.

Team Calendar Views

The administrators can use the Team Calendar page (HCSC_CALENDAR_FLU) to view the direct and indirect reports of the selected team.

By default, the Team Calendar page displays week view. Toggle between the tabs to view the biweekly reports period.

This example illustrates the fields and controls of Team Calendar page weekly view.

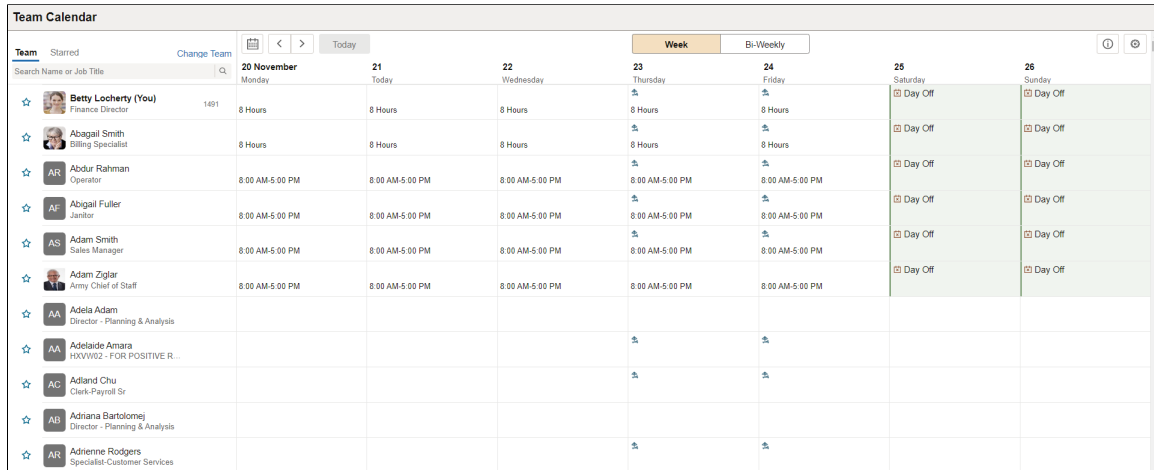



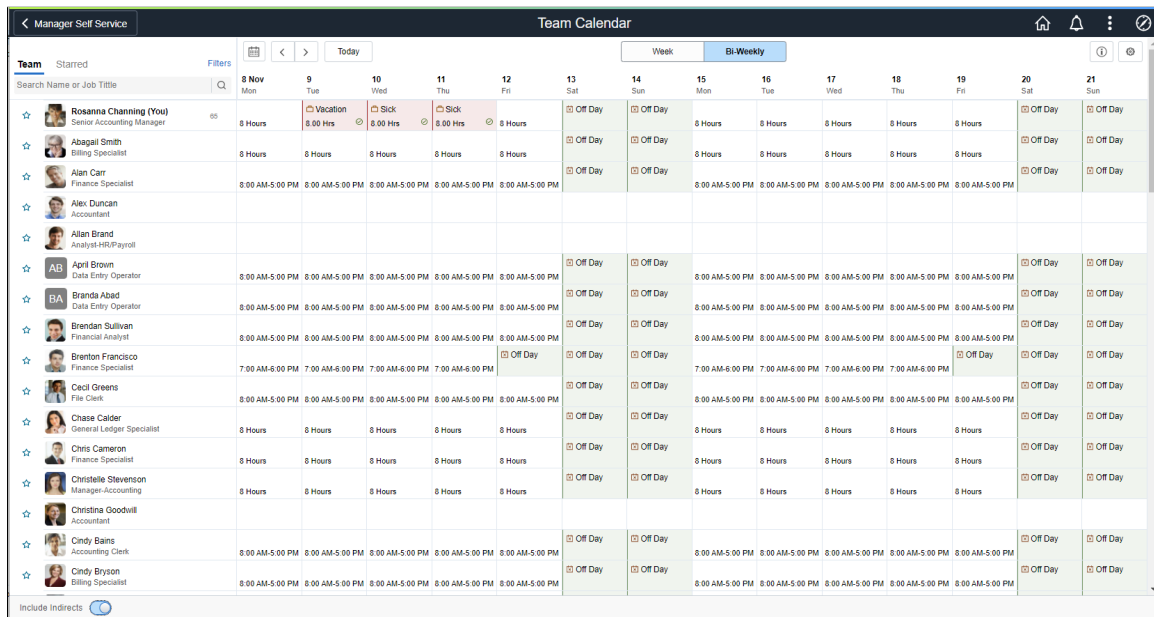

The smartphone supports only Daily and Weekly modes.

Select the Bi-Weekly tab to view the calendar for two weeks.

This example illustrates the fields and controls of Team Calendar page Bi Weekly page.



| Field or Control | Description |
|---|---------------------------------------|
| Search Name or Job Title | Field to search by name or job title. |
|  | Show legends and their description. |

| Field or Control | Description |
|---|--|
|  | Select to open a modal page from where you can select to display in Calendar and Preferences. |
|  | Select to star an employee for comparison. This icon highlights when the starred employee is selected. |
|  | Select to view calendar. You can select a date from here. |
|  | Select to navigate to previous or next day in calendar. |

Select the **Change Team** link to open the ChangeTeam modal which allows the user to view a different Team Calendar or modify the search criteria.

This example illustrates the fields and controls of the ChangeTeam modal.

Cancel
Change Team
Done

*SetID

Business Unit

Department ID

Location Code

Supervisor ID

Job Code

Note: While using a smartphone, you can view the Team Calendars in Daily and Weekly mode and not in Weekly and Bi-Weekly mode as in other devices.

Select the day box for an employee to view the **Details** modal, from where the manager can select the related actions and do the necessary operations.

This example illustrates the fields and controls of Team Calendar with details.

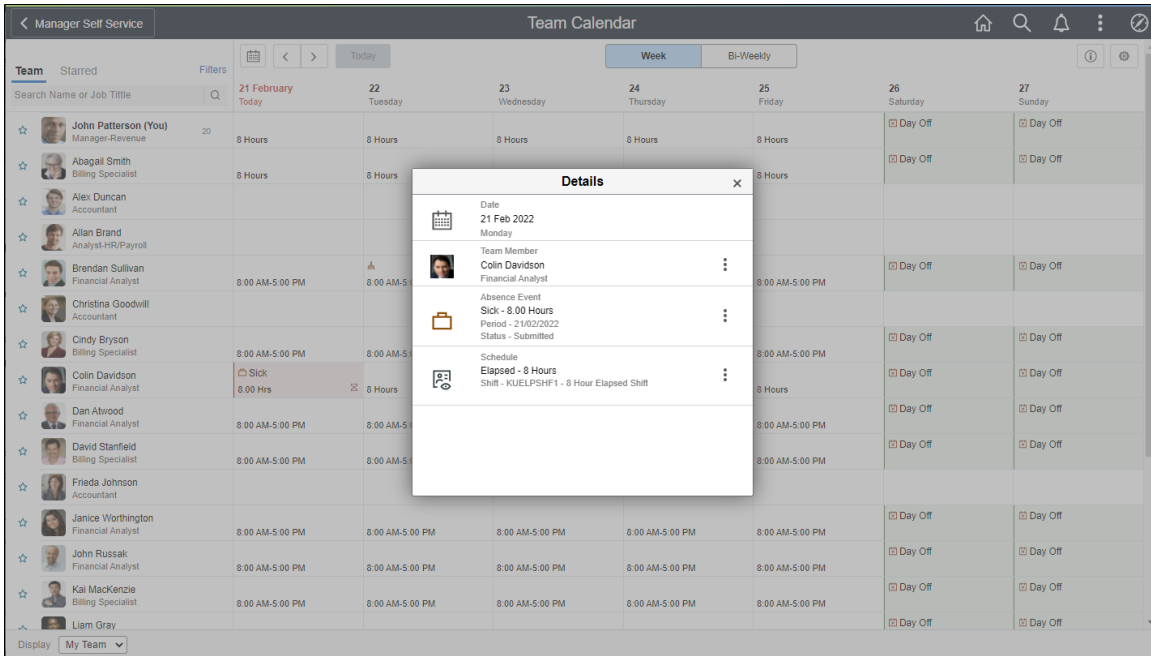

Select  on the **Details** modal to open the related actions. From here, the managers can perform the actions.

This example illustrates the fields and controls of Team Calendar with related actions.

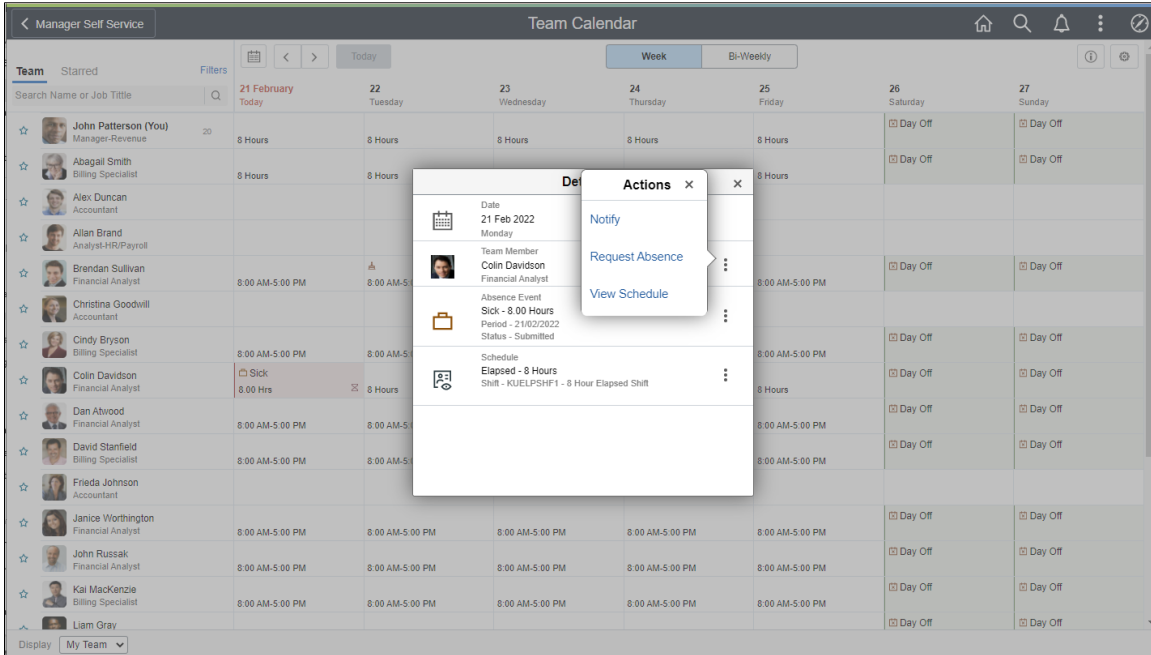

Note: The organizations can configure which related actions to show.

By selecting the star next to select employees you can do a quick comparison of them.

This example illustrates the fields and controls of Team Calendar with starred employees.

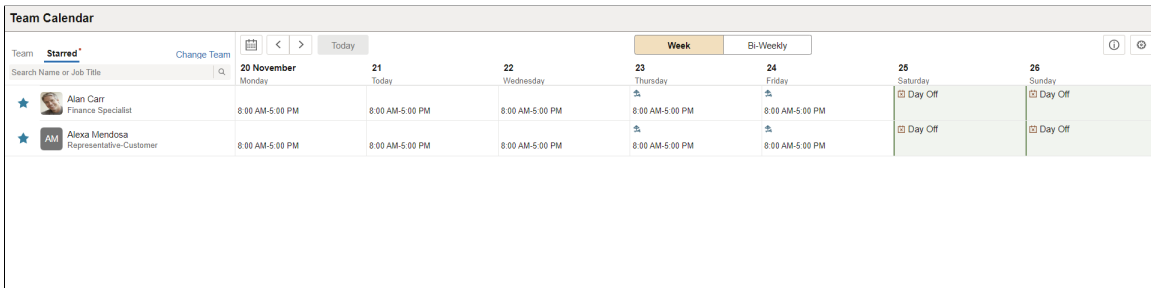

This example illustrates the fields and controls of the Display in Calendar modal.

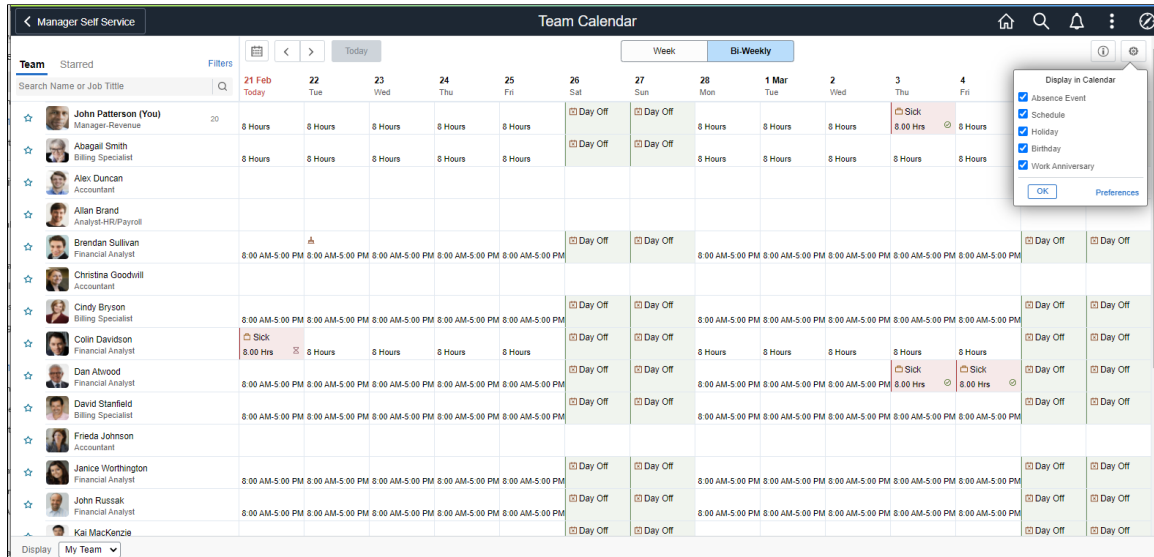

Using Fluid Matrix Calendar View

The Matrix Calendar is a one-stop for the matrix team managers to view for all the team direct reports calendars.

The managers can perform necessary related actions when required very easily from here. The manager's direct and indirect reporters absence information is available at one glance in a day box format for both weekly and bi-weekly periods. The Matrix Calendar is available in smartphones for daily and weekly period views.

Pages Used to View Manager Calendar

| Page Name | Definition Name | Usage |
|--------------------------------------|--|--|
| Matrix Calendar Tile | HC_HCSC_CALENDAR_FLU (this is the cref for the tile) | Access the Matrix Calendar page to view and manage the calendar for direct and indirect reporters. |
| Team Calendar Views | HCSC_CALENDAR_FLU | View the calendar for a week period |

Matrix Calendar Tile

Use the Matrix Calendar Tile to navigate to the Team Calendar page to view and manage the calendar and schedule for direct and indirect reporters.

Navigation

As a manager, you can add the tile, through personalization, to a system-delivered home page or a home page that you create.

This example illustrates the Matrix Calendar tile.



Team Calendar Views

The managers can use the Team Calendar page to view the direct and indirect reports all at once.

By default, the Team Calendar page displays week view. Toggle between the tabs to view the biweekly reports period.

This example illustrates the fields and controls of Team Calendar page weekly view, including indirects.

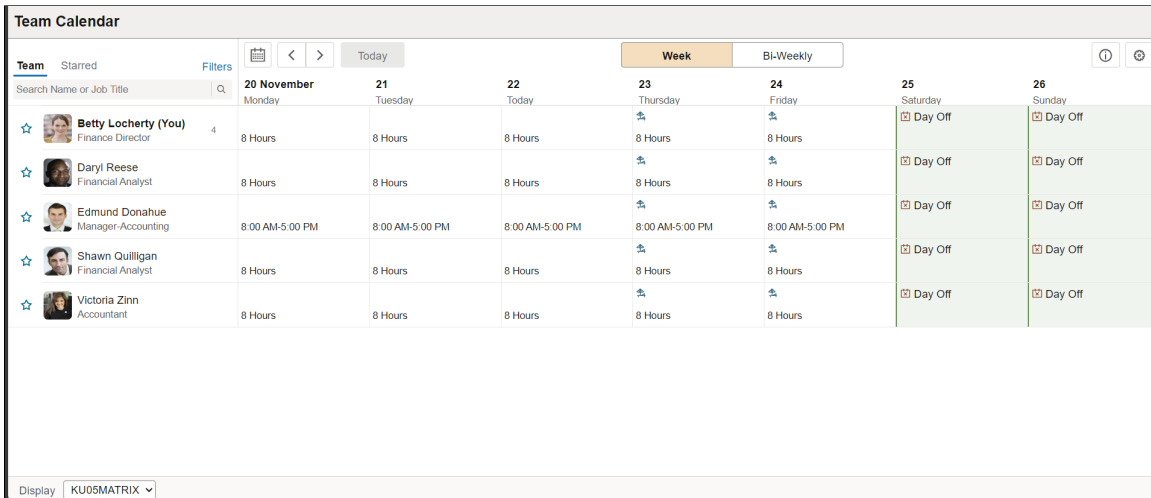

The screenshot shows the "Team Calendar" interface. At the top, there are tabs for "Team" (selected) and "Starrd", along with "Filters" and navigation arrows. Below this is a search bar for "Name or Job Title". The main area displays a weekly view for the week of November 20-26. The days of the week are listed as columns: 20 November (Monday), 21 (Tuesday), 22 (Today, Wednesday), 23 (Thursday), 24 (Friday), 25 (Saturday), and 26 (Sunday). The team members are listed as rows. Betty Locherty (You), Finance Director, has 8 hours on all days. Daryl Reese, Financial Analyst, has 8 hours on all days. Edmund Donahue, Manager-Accounting, has 8:00 AM-5:00 PM on all days. Shawn Oulligan, Financial Analyst, has 8 hours on all days. Victoria Zinn, Accountant, has 8 hours on all days. The weekend days (25 and 26) are shaded green and labeled "Day Off". At the bottom, there is a "Display" dropdown menu set to "KU05MATRIX".

| Team | 20 November | 21 | 22 | 23 | 24 | 25 | 26 |
|--|-----------------|-----------------|-----------------|-----------------|-----------------|----------|---------|
| | Monday | Tuesday | Today | Thursday | Friday | Saturday | Sunday |
| Betty Locherty (You) Finance Director | 8 Hours | 8 Hours | 8 Hours | 8 Hours | 8 Hours | Day Off | Day Off |
| Daryl Reese Financial Analyst | 8 Hours | 8 Hours | 8 Hours | 8 Hours | 8 Hours | Day Off | Day Off |
| Edmund Donahue Manager-Accounting | 8:00 AM-5:00 PM | 8:00 AM-5:00 PM | 8:00 AM-5:00 PM | 8:00 AM-5:00 PM | 8:00 AM-5:00 PM | Day Off | Day Off |
| Shawn Oulligan Financial Analyst | 8 Hours | 8 Hours | 8 Hours | 8 Hours | 8 Hours | Day Off | Day Off |
| Victoria Zinn Accountant | 8 Hours | 8 Hours | 8 Hours | 8 Hours | 8 Hours | Day Off | Day Off |



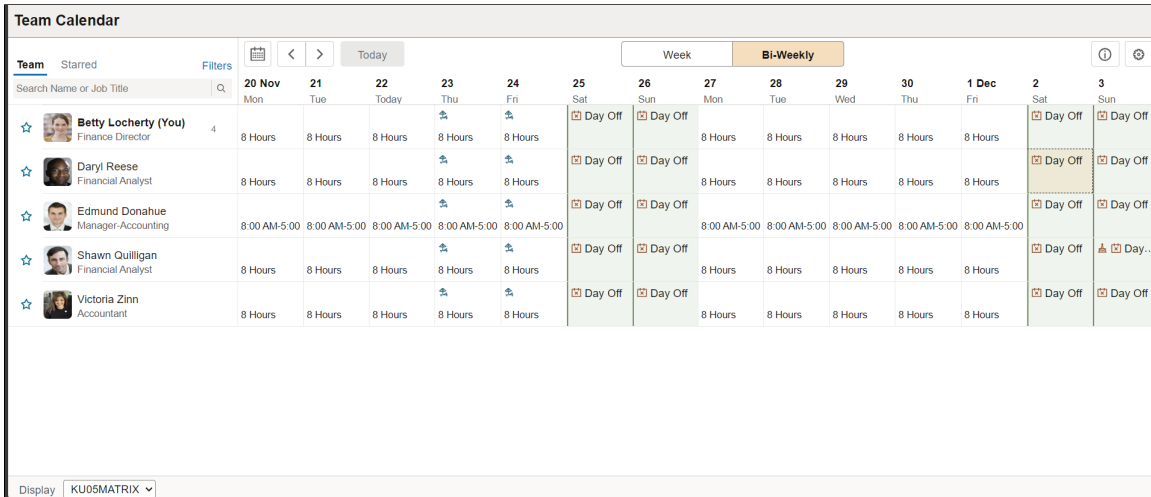

Select the Bi-Weekly tab to view the calendar for two weeks.

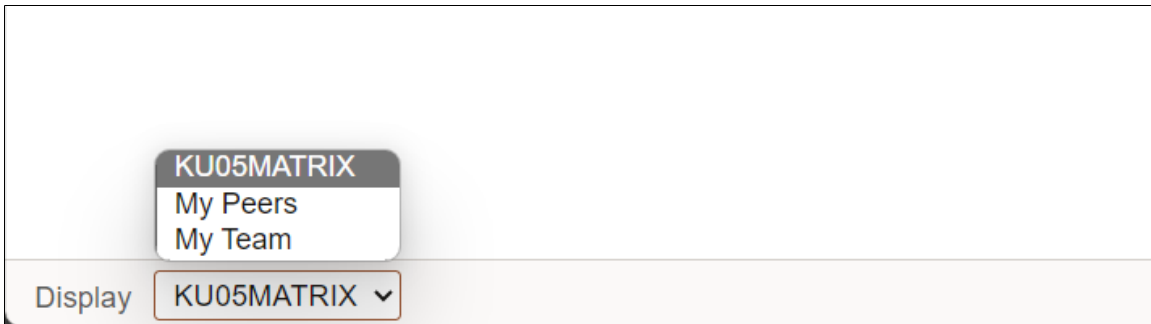

This example illustrates the fields and controls of Team Calendar page Bi Weekly page.

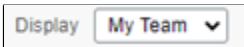

This example illustrates the fields and controls of Team Calendar page footer.



| Field or Control | Description |
|---|--|
| Search Name or Job Title | Field to search by name or job title. |
|  | Show legends and their description. |
|  | Select to open a modal page from where you can select to display in Calendar and Preferences. |
|  | Select My Team , My Peer , or Matrix from the drop-down list. |
|  | Select to star an employee for comparison. This icon highlights when the starred employee is selected. |

| Field or Control | Description |
|---|---|
|  | Select to view calendar. You can select a date from here. |
|  | Select to navigate to previous or next day in calendar. |

Select the **Filters** to modify the list of employees displayed.

This example illustrates the fields and controls of the ChangeTeam modal.

Cancel
Filters
Done

First Name

Last Name

Position Number

Payroll Status

Job Code

Department ID

Location Code

Note: While using a smartphone, you can view the Team Calendars in Daily and Weekly mode and not in Weekly and Bi-Weekly mode as in other devices.

Select the **Include Indirects** from the footer to view the flattened list of the team reporting or colleagues of the logged in manager.

Select the day box for an employee to view the **Details** modal, from where the manager can select the related actions and do the necessary operations.

This example illustrates the fields and controls of Team Calendar with details.

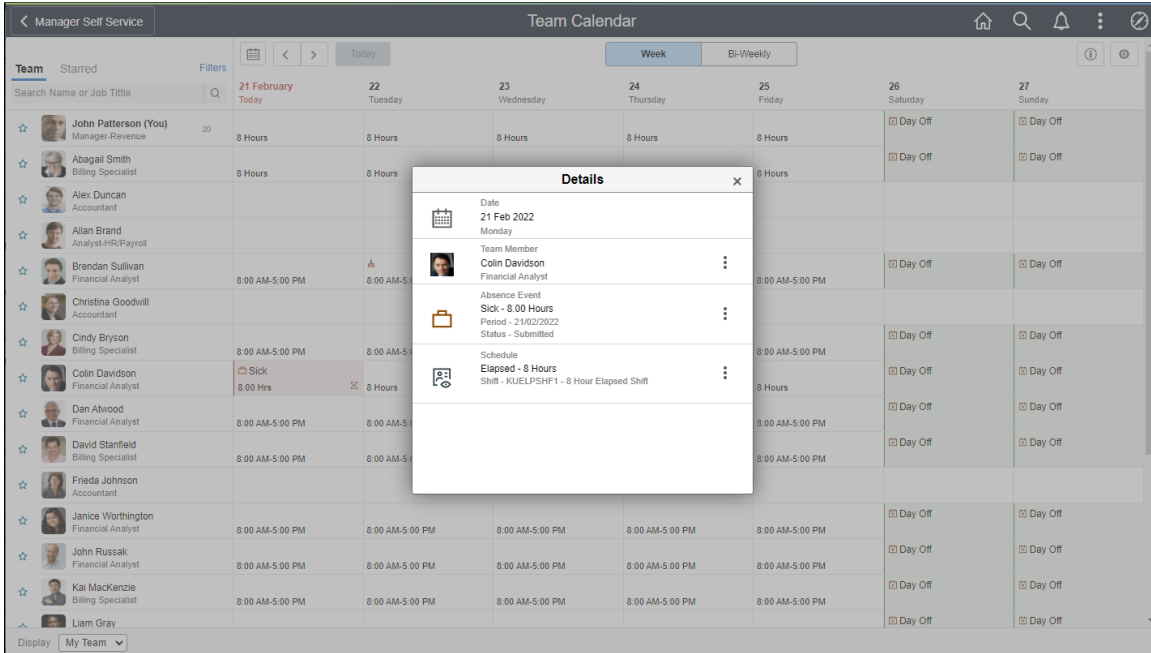

Select  on the **Details** modal to open the related actions. From here, the managers can perform the actions.

This example illustrates the fields and controls of Team Calendar with related actions.

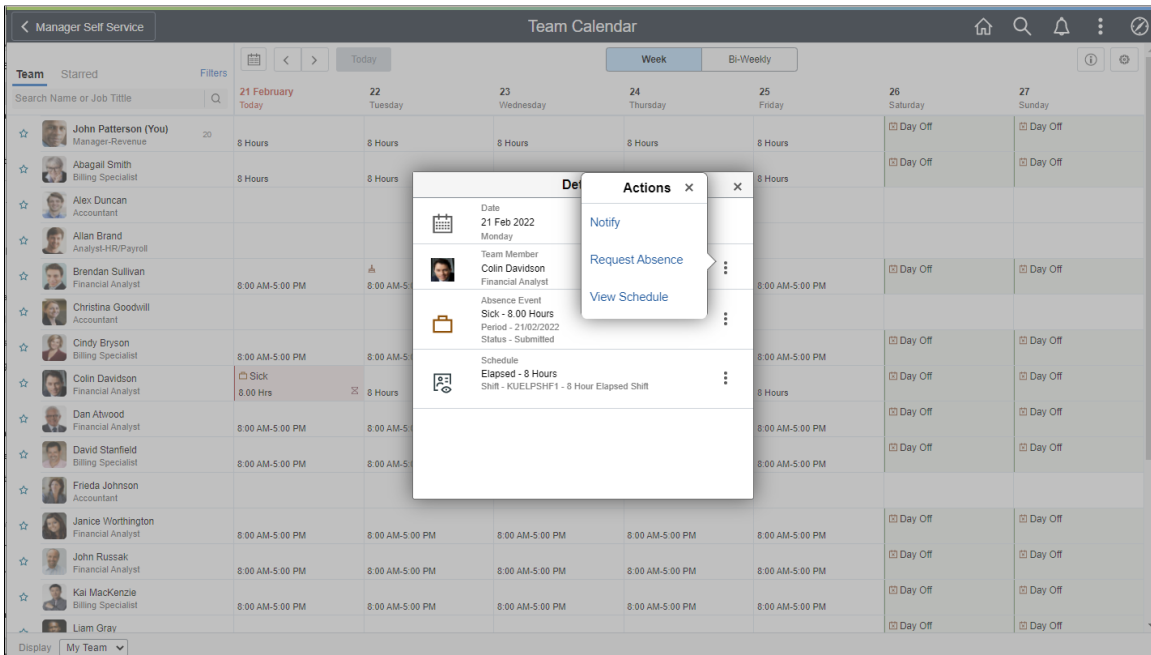

Note: The organizations can configure which related actions to show.

By selecting the star next to select employees you can do a quick comparison of them.

This example illustrates the fields and controls of Team Calendar with starred employees.

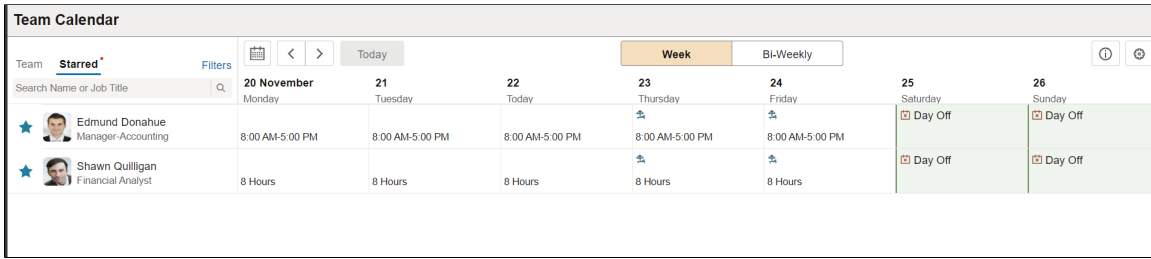

This example illustrates the fields and controls of the Display in Calendar modal.

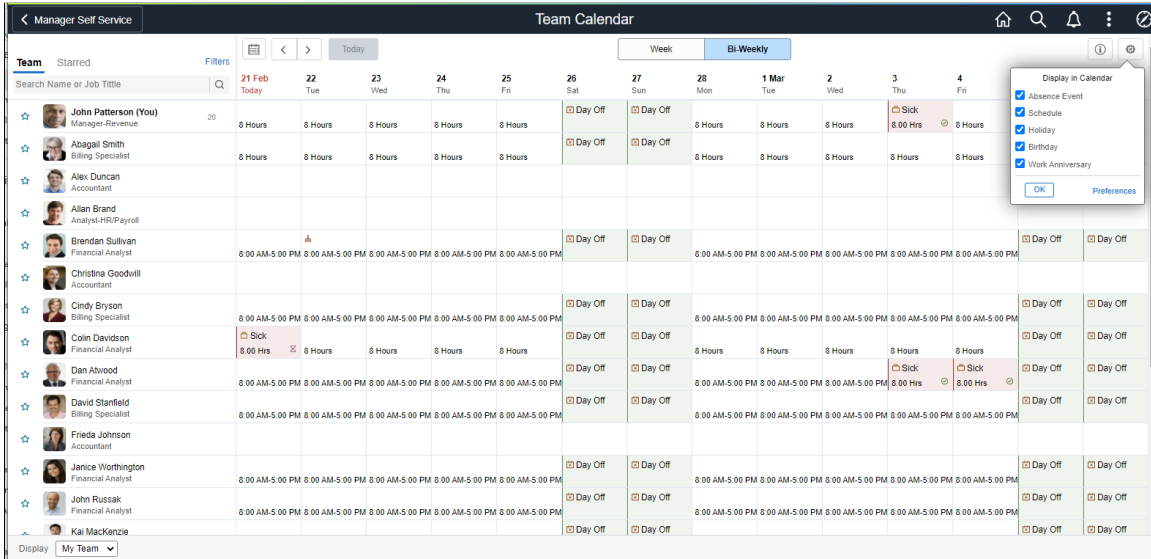

Using Fluid Employee Calendar View

The Employee Self Service Team Calendar helps employees to view peer events like leave and schedule details. The ESS Employee Calendar feature enables employees to view events for Absence, Schedule, Training, Holidays, Work Anniversaries and Birthdays out of the box. The framework enables administrators to set up and manage custom events along with options to fine tune the level of access and preferences. Organizations can add their own events by creating application classes and adding the configuration to the framework.

Page Used to for Employee Calendar View

| Page Name | Definition Name | Usage |
|---|---|--|
| Employee Calendar Tile | HC_HCSC_CAL_EMP_FLU (this is the cref for the tile) | Access the Employee Calendar page to view peer events. |
| Employee Calendar Views | HCSC_CAL_EMP_FL | View peer events at one place. |

| Page Name | Definition Name | Usage |
|------------------------------|------------------------|--|
| Team Calendar Bi-Weekly View | HCSC_CALENDAR_FLU | Select the tab to view biweekly employee calendar. |

Employee Calendar Tile

Use the Employee Calendar Tile to navigate to the Employee Team Calendar page to view peer events.

Navigation

As an employee, you can add the tile, through personalization, to a system-delivered home page or a home page that you create.

This example illustrates the Employee Calendar tile.



The role that needs to be assigned for employees is **HCSC Calendar Employee**.

This example illustrates the Team Calendar tile in smartphone.

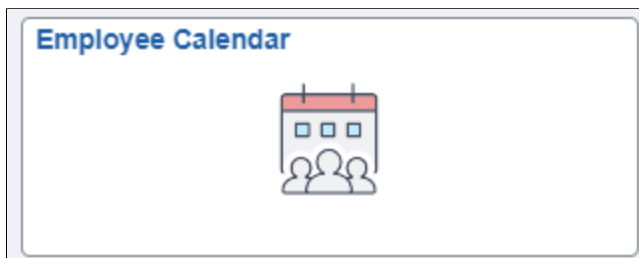

While using a smartphone, you can view the Employee Team Calendars in Daily and Weekly mode and not in Weekly and Bi-Weekly mode as in other devices.

Employee Calendar Views

The employee can use the Team Calendar page to view peer events at one place.

By default, the Team Calendar page displays week view. Toggle between the tabs to view the biweekly reports period.

This example illustrates the fields and controls of Team Calendar page weekly view.

The screenshot shows a 'Team Calendar' interface with a weekly view. The top navigation bar includes 'Manager Self Service', 'Team Calendar', and utility icons. Below the navigation, there are controls for 'Today', 'Week', and 'Bi-Weekly' views. A search bar is present for finding team members by name or job title. The main area displays a grid of team members and their work hours for each day of the week (Feb 21-27). Team members listed include Christelle Stevenson, Rosanna Channing, Daryl Reese, David Ho, Edmund Donahue, John Patterson, Mei Lee, Shawn Quilligan, and Vicki Zinn. Most team members have 8-hour workdays, while Edmund Donahue has a specific 8:00 AM-5:00 PM schedule. Saturdays and Sundays are marked as 'Day Off' for all team members.

| Team | 21 February Today | 22 Tuesday | 23 Wednesday | 24 Thursday | 25 Friday | 26 Saturday | 27 Sunday |
|--|-------------------|-----------------|-----------------|-----------------|-----------------|-------------|-----------|
| Christelle Stevenson (You) Manager-Accounting | 8 Hours | 8 Hours | 8 Hours | 8 Hours | 8 Hours | Day Off | Day Off |
| Rosanna Channing Senior Accounting Manager | 8 Hours | 8 Hours | 8 Hours | 8 Hours | 8 Hours | Day Off | Day Off |
| Daryl Reese Financial Analyst | 8 Hours | 8 Hours | 8 Hours | 8 Hours | 8 Hours | Day Off | Day Off |
| David Ho Senior Financial Analyst | | | | | | | |
| Edmund Donahue Manager-Accounting | 8:00 AM-5:00 PM | 8:00 AM-5:00 PM | 8:00 AM-5:00 PM | 8:00 AM-5:00 PM | 8:00 AM-5:00 PM | Day Off | Day Off |
| John Patterson Manager-Revenue | 8 Hours | 8 Hours | 8 Hours | 8 Hours | 8 Hours | Day Off | Day Off |
| Mei Lee Accountant | 8:00 AM-5:00 PM | 8:00 AM-5:00 PM | 8:00 AM-5:00 PM | 8:00 AM-5:00 PM | 8:00 AM-5:00 PM | Day Off | Day Off |
| Shawn Quilligan Financial Analyst | 8 Hours | 8 Hours | 8 Hours | 8 Hours | 8 Hours | Day Off | Day Off |
| Vicki Zinn Accountant | 8 Hours | 8 Hours | 8 Hours | 8 Hours | 8 Hours | Day Off | Day Off |

This example illustrates the daily view of Team Calendar page in smartphone.

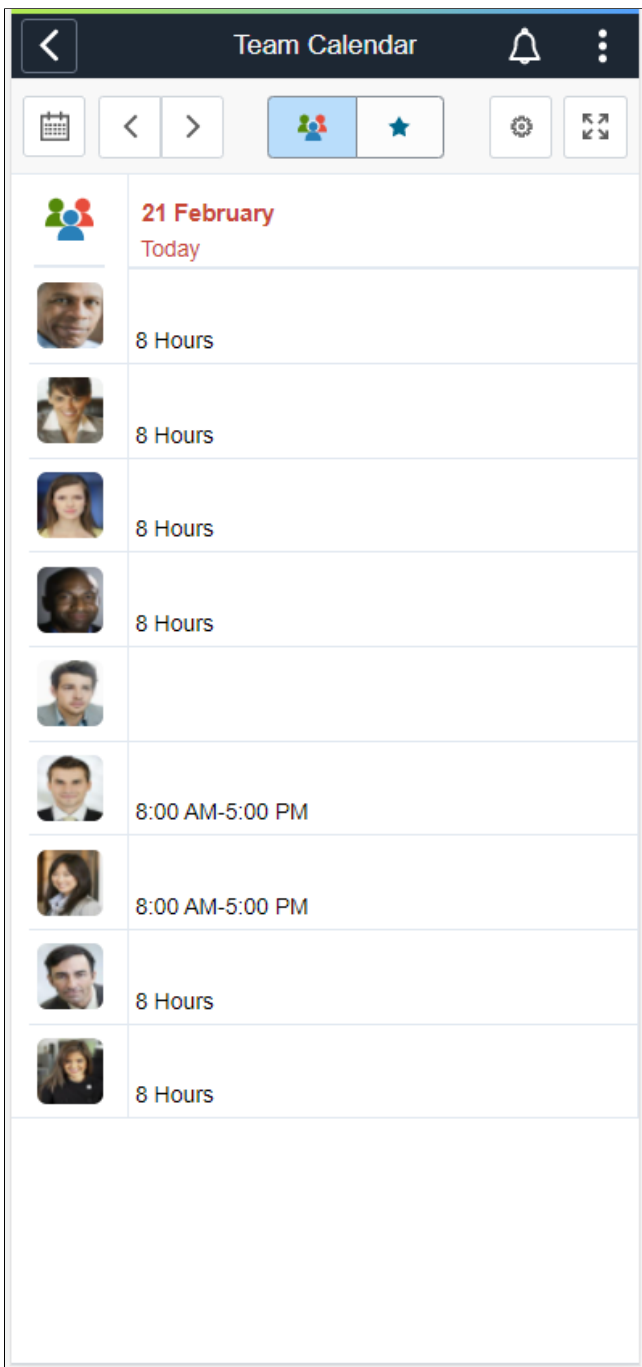

The smartphone supports only Daily and Weekly modes.

Select the Bi-Weekly tab to view the calendar for two weeks.

This example illustrates the fields and controls of Team Calendar page Bi Weekly page.





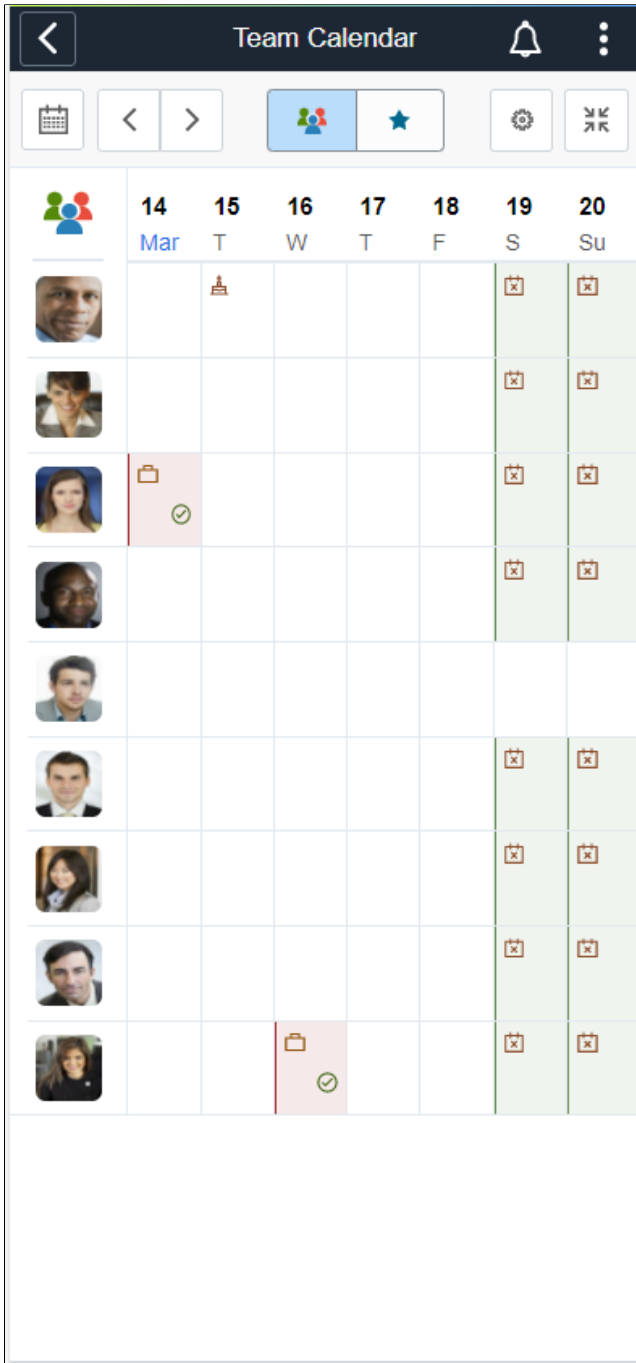

The screenshot displays the 'Team Calendar' interface in 'Bi-Weekly' view. The header includes navigation options like 'Employee Self Service', 'Team Calendar', and icons for home, notifications, and settings. Below the header, there are controls for switching between 'Week' and 'Bi-Weekly' views, and a search bar for 'Search Name or Job Title'. The main area is a grid with columns for each day from Monday (7 Feb) to Sunday (20 Feb). Each row represents an employee, with their name, job title, and profile picture. The grid cells show work hours (e.g., '8 Hours') or specific events like 'Vacation' and 'Day Off'. For example, Rosanna Channing has vacation on Feb 8 and Feb 11, and is a day off on Feb 12 and 13. Diane Palmer has specific work hours listed for each day of the week.

| Team | 7 Feb Mon | 8 Tue | 9 Wed | 10 Today Thu | 11 Fri | 12 Sat | 13 Sun | 14 Mon | 15 Tue | 16 Wed | 17 Thu | 18 Fri | 19 Sat | 20 Sun |
|---|----------------|----------------------|----------------|----------------|----------------------|----------------|---------|----------------|----------------|----------------|----------------|----------------|----------------|----------------|
| Rosanna Channing (You) Senior Accounting Manager | 8 Hours | Vacation 8.00 Hrs | 8 Hours | 8 Hours | Vacation 8.00 Hrs | Day Off | Day Off | 8 Hours | 8 Hours | 8 Hours | 8 Hours | 8 Hours | Day Off | Day Off |
| Betty Locherty Finance Director | 8 Hours | 8 Hours | 8 Hours | 8 Hours | 8 Hours | Day Off | Day Off | 8 Hours | 8 Hours | 8 Hours | 8 Hours | 8 Hours | Day Off | Day Off |
| Amelia Lucas QA Analyst | | | | | | | | 8 Hours | 8 Hours | 8 Hours | 8 Hours | 8 Hours | | |
| CDERosanna Channing Senior Accounting Manager | | | | | | | | 8 Hours | 8 Hours | 8 Hours | 8 Hours | 8 Hours | | |
| Cynthia Adams Corporate Controller | 8 Hours | 8 Hours | 8 Hours | 8 Hours | 8 Hours | Day Off | Day Off | 8 Hours | 8 Hours | 8 Hours | 8 Hours | 8 Hours | Day Off | Day Off |
| Diane Palmer Administrative Assistant | 8:00 AM-5:00 P | 8:00 AM-5:00 P | 8:00 AM-5:00 P | 8:00 AM-5:00 P | 8:00 AM-5:00 P | 8:00 AM-5:00 P | | 8:00 AM-5:00 P | 8:00 AM-5:00 P | 8:00 AM-5:00 P | 8:00 AM-5:00 P | 8:00 AM-5:00 P | 8:00 AM-5:00 P | 8:00 AM-5:00 P |
| Franklin Ron QA Analyst | | | | | | | | 8 Hours | 8 Hours | 8 Hours | 8 Hours | 8 Hours | | |
| Jill Chancellor Payroll Manager | | | | | | | | 8 Hours | 8 Hours | 8 Hours | 8 Hours | 8 Hours | | |
| Netty Owyang Manager-Accounting | 8:00 AM-5:00 P | 8:00 AM-5:00 P | 8:00 AM-5:00 P | 8:00 AM-5:00 P | 8:00 AM-5:00 P | Day Off | Day Off | 8:00 AM-5:00 P | 8:00 AM-5:00 P | 8:00 AM-5:00 P | 8:00 AM-5:00 P | 8:00 AM-5:00 P | Day Off | Day Off |
| Paul Jackson HR-System Test Job Code | | | | | | | | 8 Hours | 8 Hours | 8 Hours | 8 Hours | 8 Hours | | |

This example illustrates the fields and controls of Team Calendar page Weekly page in smartphone.



| Field or Control | Description |
|---|---------------------------------------|
| Search Name or Job Title | Field to search by name or job title. |
|  | Show legends and their description. |

| Field or Control | Description |
|---|--|
|  | Select to open a modal page from where you can select to display in Calendar and Preferences. |
|  | Select to star an employee for comparison. This icon highlights when the starred employee is selected. |
|  | Select to view calendar. You can select a date from here. |
|  | Select to navigate to previous or next day in calendar. |
|  | Toggle between team and star view while using smartphone. |
|  | Toggle between daily and weekly view in smartphone. |
|  | Main menu to go to Team Calendar page with team and starred view. |

Note: While using a smartphone, you can view the Team Calendars in Daily and Weekly mode and not in Weekly and Bi-Weekly mode as in other devices.

Select the day box for an employee to view the **Details** modal, from where the manager can select the related actions and do the necessary operations.



While using a smartphone, to view the team and starred employees in a single page, select the menu icon.

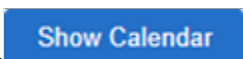

Select the **Show Calendar** button to view the comparison report. You can view the report in daily or



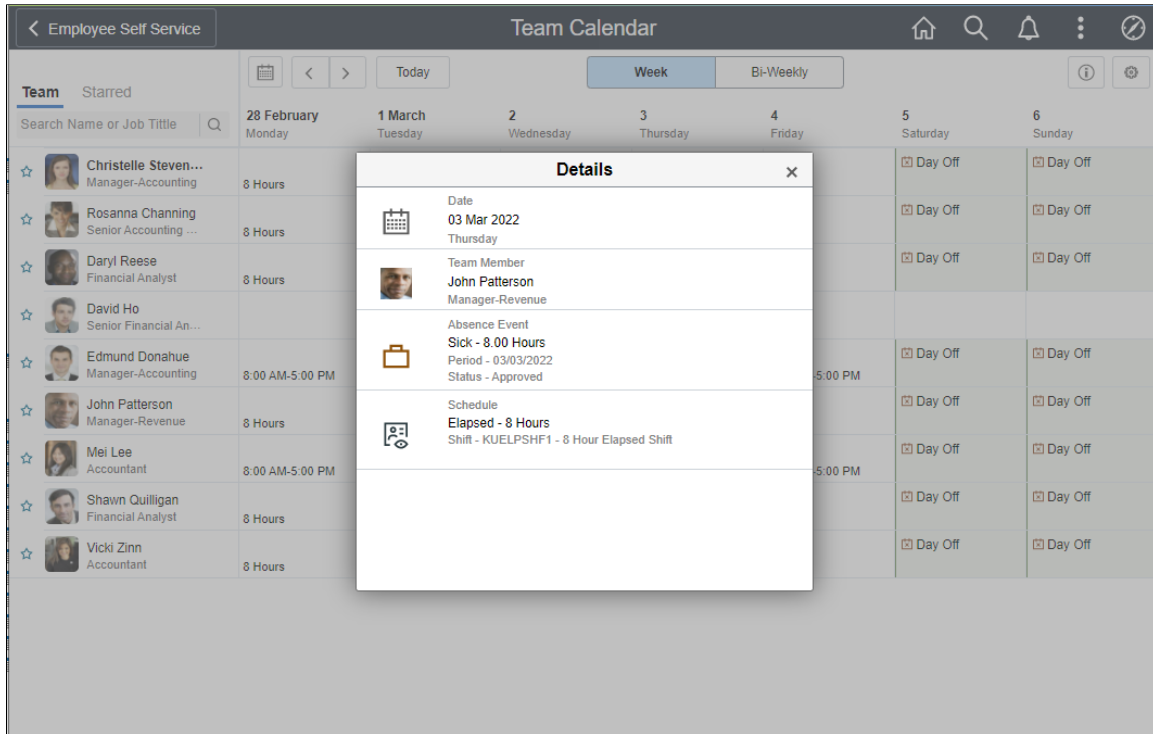

weekly view by selecting the the button.

This example illustrates the fields and controls of Team Calendar with details.

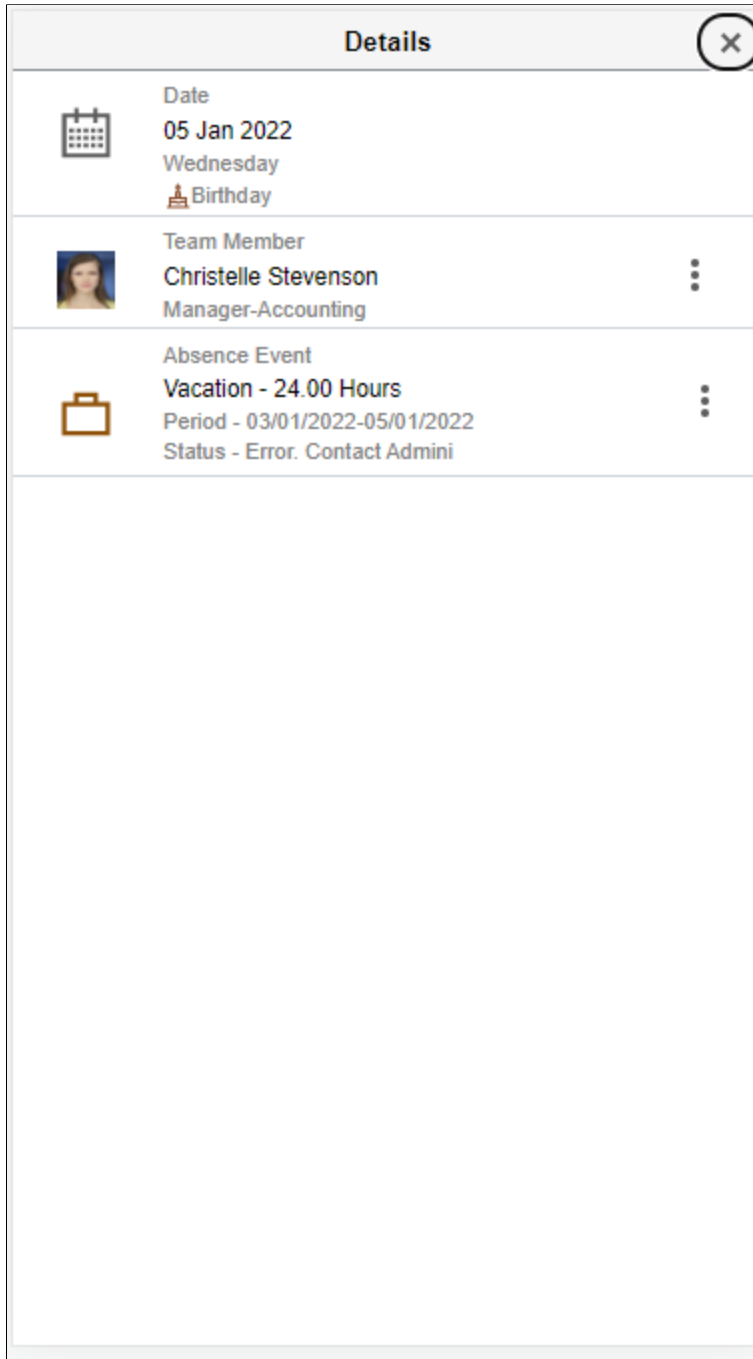

This example illustrates the Team Calendar with details in smartphone.



Select  on the **Details** modal to open the related actions. From here, the employees can perform the actions. The Related Actions are derived from App Class definition for the event.

The Request Absence option will open up [Manage Absences Page](#) to provide absence details for the chosen date.

This example illustrates the fields and controls of Team Calendar with related actions.

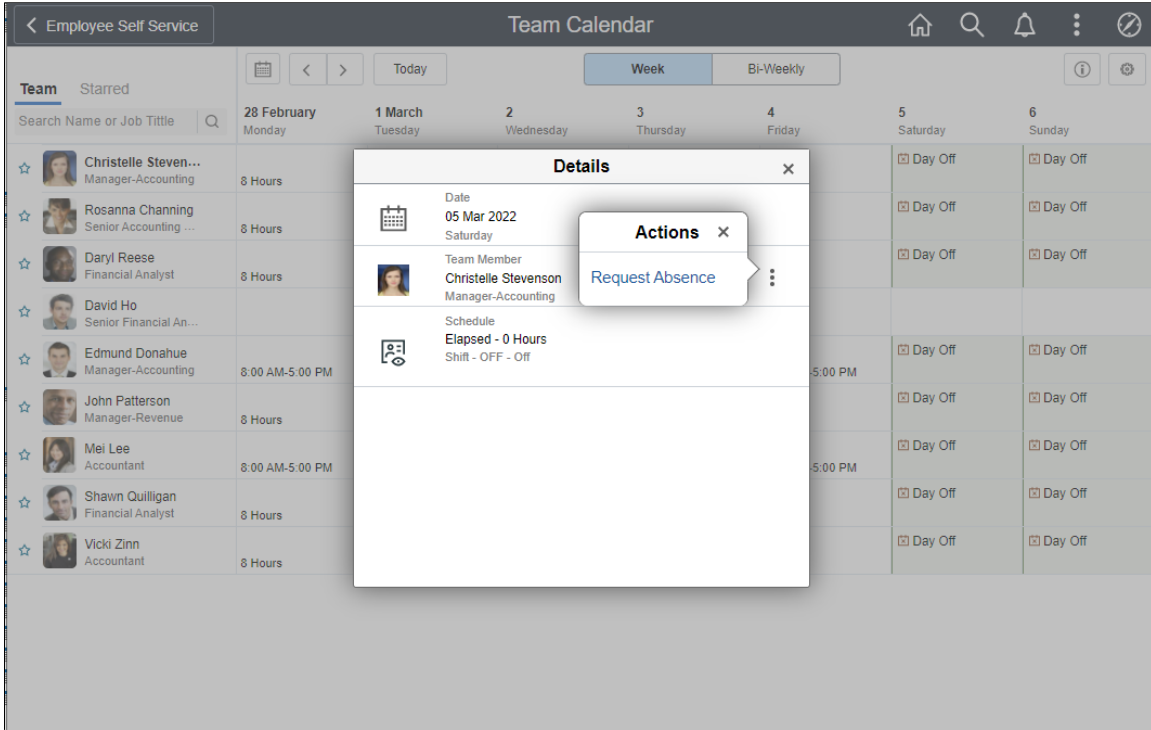

This example illustrates the related actions in smartphone.

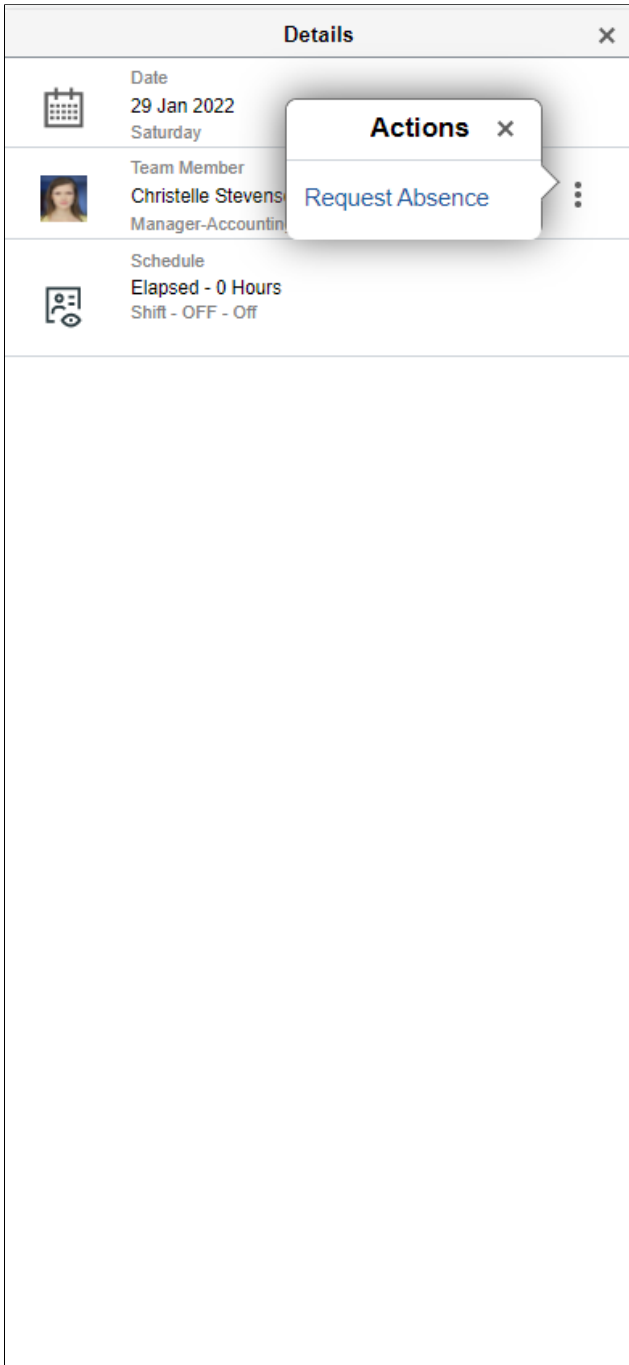

The employees who has access to schedule change request in ESS, will have related actions to give up or trade shift displayed in the calendar. Selecting any of these options will open up the “Give up your Shift Page” (PeopleSoft Time and Labor) or “Trade your Shift Page” (PeopleSoft Time and Labor) to provide the details for the chosen date.

This example illustrates the related actions for Give up, Trade and View Shift details.

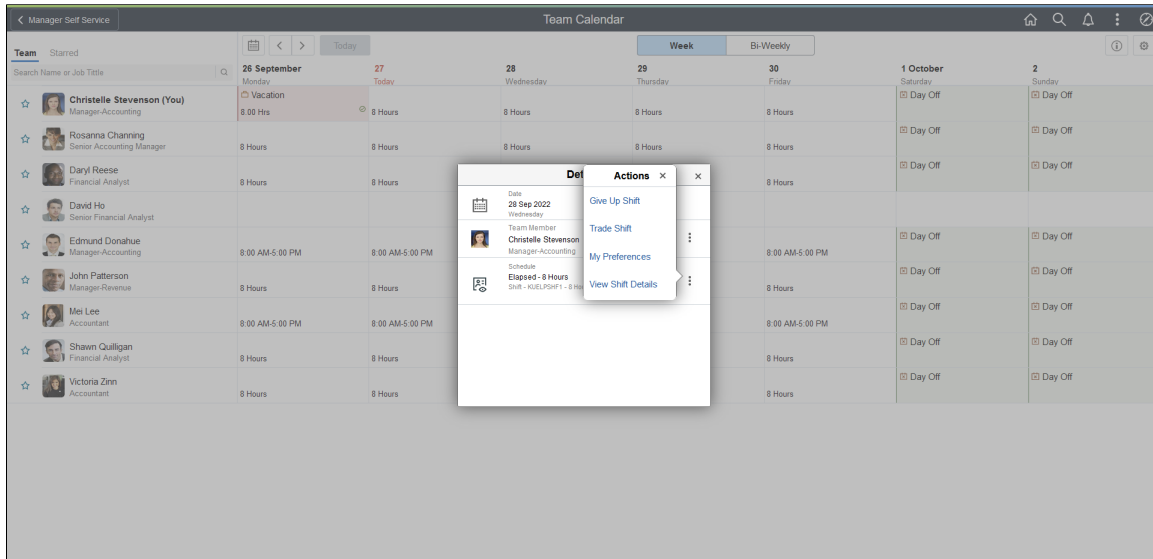

Note: The organizations can configure which related actions to show.

By selecting the star next to select employees you can do a quick comparison of them.

This example illustrates the fields and controls of Team Calendar with starred employees.

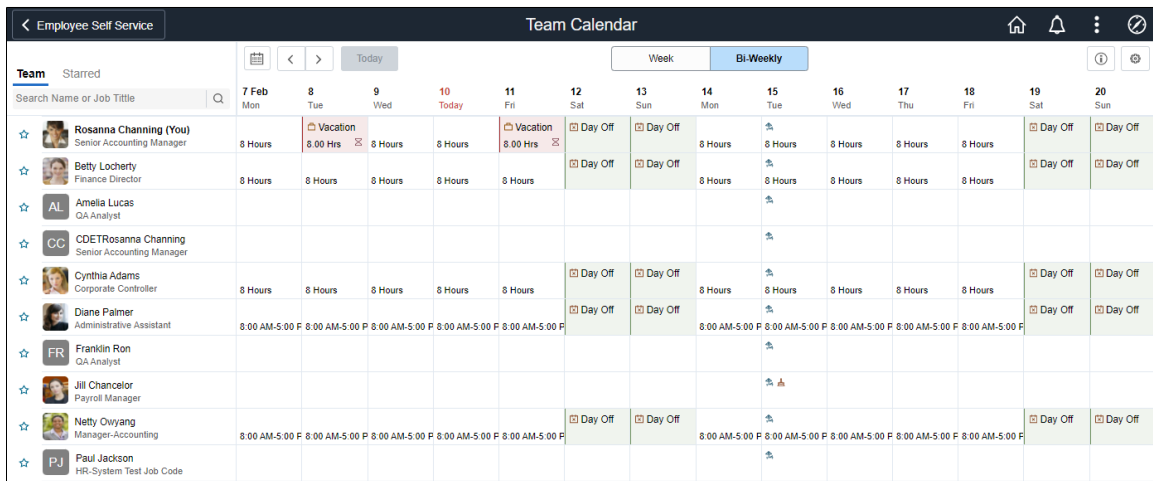

This example illustrates the fields and controls of the Display in Calendar modal.

The screenshot displays the 'Team Calendar' interface. At the top, it shows navigation icons, a search bar, and a 'Today' button. Below this is a header with 'Team' and 'Starred' tabs, and a search bar for 'Search Name or Job Title'. The main area is a calendar grid for the week of Feb 21 to Mar 4. Team members are listed on the left, including Christelle Stevenson, Rosanna Channing, Daryl Reese, David Ho, Edmund Donahue, John Patterson, Mei Lee, Shawn Quilligan, and Vicki Zinn. Each member's schedule is shown in the grid, with '8 Hours' or 'Day Off' indicated. A 'Sick' event is shown for John Patterson on Mar 3. A modal titled 'Display in Calendar' is open, showing checkboxes for 'Absence Event', 'Schedule', 'Holiday', 'Birthday', and 'Work Anniversary', along with 'OK' and 'Preferences' buttons.

| Team Member | 21 Feb | 22 | 23 | 24 | 25 | 26 | 27 | 28 | 1 Mar | 2 | 3 | 4 |
|----------------------------|-----------------|-----------------|-----------------|-----------------|-----------------|---------|---------|-----------------|-----------------|-----------------|-----------------|-----------------|
| Christelle Stevenson (You) | 8 Hours | 8 Hours | 8 Hours | 8 Hours | 8 Hours | Day Off | Day Off | 8 Hours | 8 Hours | 8 Hours | 8 Hours | 8 Hours |
| Rosanna Channing | 8 Hours | 8 Hours | 8 Hours | 8 Hours | 8 Hours | Day Off | Day Off | 8 Hours | 8 Hours | 8 Hours | 8 Hours | 8 Hours |
| Daryl Reese | 8 Hours | 8 Hours | 8 Hours | 8 Hours | 8 Hours | Day Off | Day Off | 8 Hours | 8 Hours | 8 Hours | 8 Hours | 8 Hours |
| David Ho | | | | | | | | | | | | |
| Edmund Donahue | 8:00 AM-5:00 PM | 8:00 AM-5:00 PM | 8:00 AM-5:00 PM | 8:00 AM-5:00 PM | 8:00 AM-5:00 PM | Day Off | Day Off | 8:00 AM-5:00 PM | 8:00 AM-5:00 PM | 8:00 AM-5:00 PM | 8:00 AM-5:00 PM | 8:00 AM-5:00 PM |
| John Patterson | 8 Hours | 8 Hours | 8 Hours | 8 Hours | 8 Hours | Day Off | Day Off | 8 Hours | 8 Hours | 8 Hours | Sick 8:00 Hrs | 8 Hours |
| Mei Lee | 8:00 AM-5:00 PM | 8:00 AM-5:00 PM | 8:00 AM-5:00 PM | 8:00 AM-5:00 PM | 8:00 AM-5:00 PM | Day Off | Day Off | 8:00 AM-5:00 PM | 8:00 AM-5:00 PM | 8:00 AM-5:00 PM | 8:00 AM-5:00 PM | 8:00 AM-5:00 PM |
| Shawn Quilligan | 8 Hours | 8 Hours | 8 Hours | 8 Hours | 8 Hours | Day Off | Day Off | 8 Hours | 8 Hours | 8 Hours | 8 Hours | 8 Hours |
| Vicki Zinn | 8 Hours | 8 Hours | 8 Hours | 8 Hours | 8 Hours | Day Off | Day Off | 8 Hours | 8 Hours | 8 Hours | 8 Hours | 8 Hours |

This example illustrates the legends and Display in Calendar in smartphone

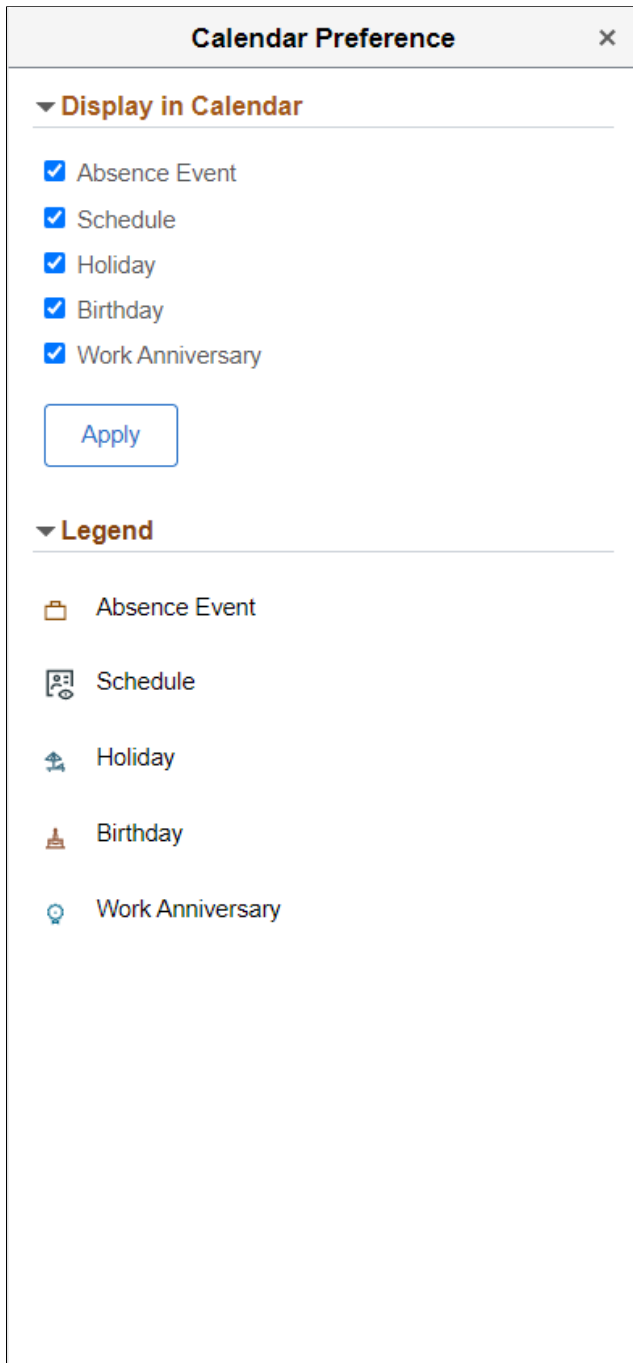

Entering and Approving Absences

Understanding Absence Entry

When a payee is absent from work at a normally scheduled work time, you record the absence take, the begin and end dates, and other details that you want to track, which is termed as Absence Entry.

Enter, Maintain and Approve Absence

Important! It is recommended that administrators use [Create and Maintain Absence Requests Page](#) as their primary location for updating and approving absences.

If the administrator is taking action on an event which is initiated in Employee or Manager Self Service, use *Create and Maintain Absence Requests page* to maintain the integrity of Approval Workflow.

Using [Absence Event Entry Page](#), the Payroll administrators can create, maintain, and approve events for single payees.

Payees and managers can use self service pages to enter requests for absences; managers can also approve requests through the self service pages.

If you are using PeopleSoft Time and Labor with your Absence Management, you can access the Absence Management Self-Service pages through the Time and Labors' Timesheet page.

Absence Event Entry Steps for the Create and Maintain Absence Request Page

1. Access the Create and Maintain Absence Request page.
2. Select the employee ID of the payee for whom you want to enter an absence event.
3. Enter the begin and end dates of the absence event.
4. Select the absence name and reason.
5. If applicable, enter the partial hours that the payee was absent and the original begin date of the absence.
6. If applicable, enter any user field or override information for the absence event.
7. Repeat steps 2 through 6 for any additional payees.
8. If the Forecasting process is required for the takes that you entered, select the applicable entries and click the Forecast button.

Absence Event Entry Steps for the Absence Event Entry Page

Following are the steps for entering an absence event:

1. Access the Absence Event Entry page for the payee.
2. Select the absence take element and enter the begin and end dates of the absence.
3. If applicable, enter the partial hours that the payee was absent and the original begin date of the absence.
4. Click the Details link to access the Absence Event Input Detail page, where you can enter other details that are related to the absence, if applicable.
5. If the Forecasting process is required for the take that you entered, return to the Absence Event Entry page and follow the procedures for forecasting entitlement during absence entry. You receive a warning message if you try to save absence entries for the take without first running the Forecasting process.

See [Forecasting Absence Entitlement Balance During Absence Entry](#).

Entering Maintaining and Approving Absence Events

Pages Used to Enter, Maintain, and Approve Absence Events

| <i>Page Name</i> | <i>Definition Name</i> | <i>Usage</i> |
|---|------------------------|---|
| Create and Maintain Absence Requests Page | HGA_MANAGE | Create, maintain, and approve absences for one or more payees. |
| Maintain Attachments Page | HR_ATT_DD_HDR | Maintain absence attachments. |
| Absence Details Page | GP_ABS_SS_REQUEST | Enter and update details for an absence request. |
| Approve Absence Requests Page | HGA_MANAGE | Approve multiple absence requests. |
| Absence Event Entry Page | GP_ABS_EVENT | Enter, update, and void absences. Start the Absence Forecasting process. |
| Absence Event Input Detail Page | GP_ABS_EVENT_SEC | Enter detailed information for an absence, including the reason, processing action, manager approval, user-defined data, entitlement adjustment, and partial hours. |

Create and Maintain Absence Requests Page

Use the Create and Maintain Absence Requests page (HGA_MANAGE) to create, maintain, and approve absences for one or more payees.

Video: [Creating and Maintaining Absences](#)

Navigation:

Global Payroll & Absence Mgmt > Payee Data > Maintain Absences > Create and Maintain Absences

This example illustrates the fields and controls on the Create and Maintain Absence Requests page.

The screenshot shows the 'Create and Maintain Absence Requests' page with various search filters. The filters include:

- Work Flow Status: [Dropdown]
- From Date: 02/17/2021
- Through Date: 08/16/2021
- Employee ID: KU0131 (John Patterson)
- Employee Record: 0 (Manager-Revenue)
- Absence Name: [Search]
- Approver Operator ID: [Search]
- Department: [Search]
- Pay Group: [Search]
- HR Status: [Dropdown]
- From Employee ID: [Text]
- Through Employee ID: [Text]
- From Last Name: [Text]
- Through Last Name: [Text]

Below the filters is an 'Action Date' table:

| Action | From Date | Through Date |
|-------------|---------------|---------------|
| Submitted | [Date Picker] | [Date Picker] |
| Approved | [Date Picker] | [Date Picker] |
| Pushed Back | [Date Picker] | [Date Picker] |
| Denied | [Date Picker] | [Date Picker] |
| Canceled | [Date Picker] | [Date Picker] |
| Voided | [Date Picker] | [Date Picker] |

Buttons at the bottom include Search, Clear Search, and Save Search.

This example illustrates the fields and controls on the Create and Maintain Absence Requests page.

The screenshot shows the 'Absence Requests' table with the following columns:

| Select | *Employee ID | Name | Empl Record | Job Title | *Start Date | *End Date | *Absence Name | Reason | Duration | Attachment | Balance |
|--------------------------|--------------|----------------|-------------|-----------------|-------------|------------|---------------|----------|----------|------------|---------------|
| <input type="checkbox"/> | KU0131 | John Patterson | 0 | Manager-Revenue | 06/07/2021 | 06/07/2021 | Sick | Sickness | 8 Hours | View/Add | Not Available |
| <input type="checkbox"/> | KU0131 | John Patterson | 0 | Manager-Revenue | 05/27/2021 | 05/28/2021 | Sick | Food Poi | 16 Hours | View/Add | Not Available |
| <input type="checkbox"/> | KU0131 | John Patterson | 0 | Manager-Revenue | 04/20/2021 | 04/20/2021 | Sick | Sickness | 8 Hours | View/Add | Not Available |
| <input type="checkbox"/> | KU0131 | John Patterson | 0 | Manager-Revenue | 03/10/2021 | 03/10/2021 | Sick | Flu | 8 Hours | View/Add | Not Available |
| <input type="checkbox"/> | KU0131 | John Patterson | 0 | Manager-Revenue | 02/22/2021 | 02/22/2021 | Sick | Sickness | 8 Hours | View/Add | Not Available |

Below the table are controls for 'Absence Requests' including 'Cancel Absence Requests', 'Absence Detail' tabs, and buttons for 'Copy Absence', 'Delete', and 'Comments'. At the bottom, there are 'Submission Options' buttons: 'Submit', 'Save for Later', and 'Forecast'.

This example illustrates the fields and controls on the Create and Maintain Absence Requests page (3 of 3). You can find definitions for the fields and controls later on this page.

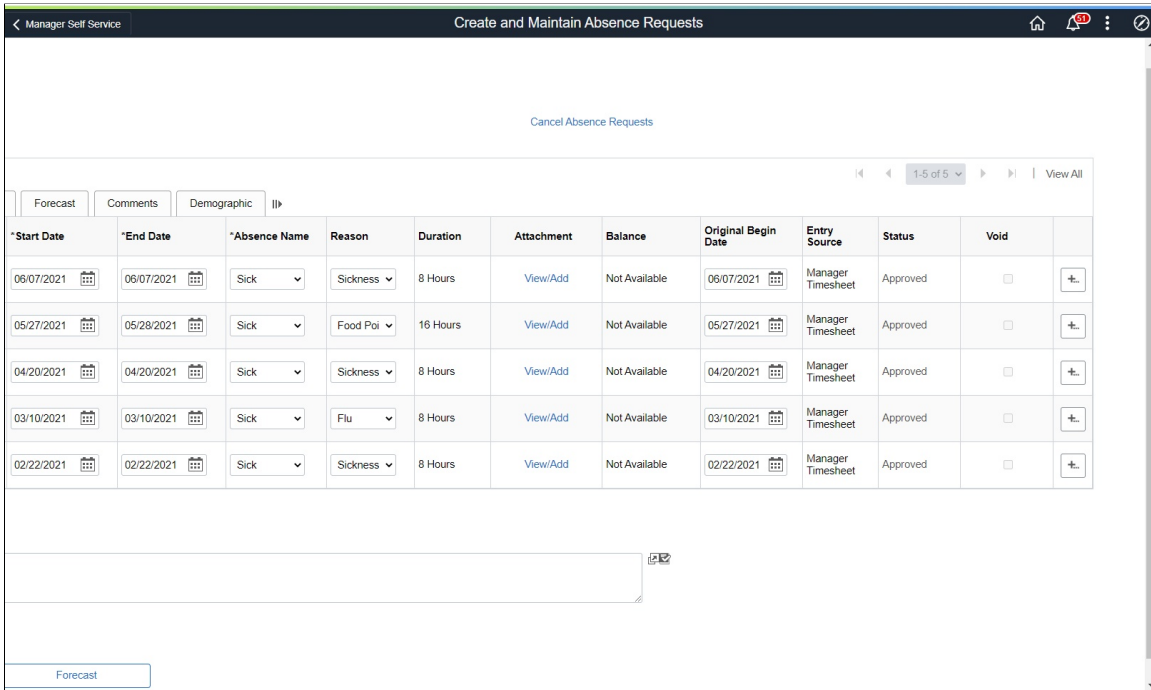

Search

Use this group box to search for absence requests based on specific criteria.

| Field or Control | Description |
|-----------------------------------|---|
| Work Flow Status | <p>Enter a value to search for absence requests with a specific work flow status. Values are: <i>Saved, Submitted, Approved, Denied, Push Back, Cancelled, and Voided.</i></p> <p>Leave this field blank to search for absence requests of all statuses.</p> |
| From Date and Through Date | <p>Enter a date range for which you want to search for absence requests. The system returns absence requests with start dates and end dates that fall within the date range that you enter.</p> <p>You can leave either field blank to create an open ended date range. For example, if you leave the From Date field blank and enter <i>12/31/2014</i> in the Through Date field, the system searches for all absences requested on or before 12/31/2014.</p> <p>The default dates are based on the values entered in the Days Before Current Date and Days After Current Date fields on the Installation Settings Page.</p> |

| Field or Control | Description |
|---|---|
| Employee ID and Employee Record | Enter values in these fields to search for absence requests for specific employee IDs and employee record numbers. |
| Absence Name | Enter a value to search for absence requests associated with a specific absence name. |
| Approver's Operator ID | Enter a value to search for absence requests associated with a specific approver. |
| Department | Enter a value to search for absence requests associated with a specific department. |
| Pay Group | Enter a value to search for absence requests associated with a specific pay group. |
| HR Status | Enter a value to search for absence requests associated with a specific HR status. |
| From Employee ID and Through Employee ID | Enter values in these fields to search for absence requests associated with a range of employee IDs. |
| From Last Name and To Last Name | Enter values in these fields to search for absence requests associated with a range of last names. |
| Action Date | Use the fields in this group box to search for absence requests using a combination of absence action and date range. For example, if you enter a From Date of 01/01/2013 and a Through Date of 12/31/2013 for the Submitted action, the system searches for all absence requests that were submitted between 01/01/2013 and 12/31/2013. |

Absence Detail Tab

Use this tab to enter or update basic details for an absence request.

| Field or Control | Description |
|-------------------------|--|
| Employee ID | Enter the ID of the employee for which you are adding an absence request. You can use the prompt to search for the employee. |

| Field or Control | Description |
|--------------------------------|--|
| Name | <p>The system displays the name of the employee you select in the Employee ID field.</p> <p>Once you fill all of the required fields for the absence request, the Name field becomes a link. Click the link to access the Absence Details Page, where you can enter additional details for the absence request.</p> |
| Empl Record | Enter the employee record for the employee. |
| Start Date and End Date | Enter the date range for the absence request. |
| Absence Name | Select the type of absence being requested. Only absence types for which the selected employee is eligible are available for selection. |
| Absence Reason | Select a reason for the absence request. The values available for selection depend on the value you select in the Absence Name field. |
| Duration | The system calculates and displays the duration depending on the values you enter in the Start Date and End Date fields. |
| Attachment | <p>Shows the View/Add link to open Maintain Attachments Page.</p> <p>The following video provides an overview of Attachment Uptake for Administrators.</p> <p>Video: Image Highlights, PeopleSoft HCM Update Image 29: Absence Request - Attachment Uptake for Administrators</p> |
| Balance | The system calculates and displays the balance depending on the values you enter in the Start Date and End Date fields. |
| Original Begin Date | <p>Enter a date in this field if your absence take rules allow you to link this absence to a previous absence that was taken for the same reason. (The Link Absence and By Original Begin Date options are selected on the take element's Period page.)</p> <p>If this absence is related to another absence, enter the begin date of the original absence.</p> <p>Example: A payee is out sick for the following periods of time:</p> |

| Absence Type | Reason (not entered online) | Absence Begin Date | Absence End Date | Original Begin Date |
|---------------------|------------------------------------|---------------------------|-------------------------|----------------------------|
| Sick | Sprained wrist | May 15 | May 16 | May 15 |
| Sick | Flu | June 1 | June 5 | June 1 |
| Sick | Wrist didn't heal properly | June 10 | June 10 | May 15 |

Entering the same original begin date for the first and third absence events tells the system that the absences are related. If you defined the take element to link absences, the system checks to see if the current absence occurred within the time frame allowed for linking. If it did, the two events are linked.

The default value for **Original Begin Date** is the begin date. Changing the begin date here does not update the original begin date.

| Field or Control | Description |
|-------------------------|---|
| Status | Displays the current status of the absence request. Click to view the Approval Monitor where you can view additional details regarding the approval of the request, and add additional approvers. |
| Void | <p>Select to void the absence request. When this check box is selected and you click Save for Later for the absence request, the system changes its Status to <i>Voided</i>. In addition, the system generates an email notification informing the employee that the absence request has been withdrawn.</p> <p>Deselect to remove the <i>Voided</i> status from the absence request. When this check box is deselected and you click Save for Later for the absence request, the system changes its Status to <i>Saved</i>. In addition, the system generates an email notification informing the employee that the absence request has been reinstated.</p> <p>Both notifications include a link to the Absence Request History Page where the employee can view the status of the request.</p> <hr/> <p>Note: If the specific absence take is setup (on the Country Take page) such that it may be cancelled via self service, then the void box is not usable/editable. This means that if there are cancellation rules and approval definitions setup on the Country Take, the void check box will be greyed out.</p> |

| Field or Control | Description |
|-------------------------|--|
| Copy Absence | Select an absence request and click this button to insert one or more absence requests with identical information. When you click this button, the system prompts you to enter the number of copies you want to insert. |
| Delete | <p>Select one or more absence requests and click this button to delete them from the grid.</p> <hr/> <p>Note: If Generate Absence Payable Time is enabled for your system and you delete an absence request for which payable time has been loaded into Payroll for North America, you receive a warning message. If you confirm the deletion, the next time the TL_GENPT PS Job runs, the Time Administration process deletes the generated payable time associated with the deleted absence request. For more information, see “Generate Absence Payable Time Page” (PeopleSoft Time and Labor)</p> <hr/> |
| Comments | Any comments you enter in this field are added to the selected absence requests when you click the Submit or Save for Later buttons. |

Submission Options

| Field or Control | Description |
|--------------------------------------|---|
| Override Forecast Eligibility | Select to make the system ignore forecasting requirements when you submit absence requests. |

| Field or Control | Description |
|-------------------------|---|
| Submit Option | <p>Specify how the system uses the Approval Framework to route the approval of the absence requests that you submit. Values are:</p> <ul style="list-style-type: none"> <p><i>Approve Automatically</i>: Select to approve submitted absence requests automatically.</p> <hr/> <p>Note: If the user accessing this page has a role that was entered in the Role not allowed Approve Automatically field on the Installation Settings page, this value is not available for the user to select.</p> <hr/> <p><i>Route to An Operator ID</i>: Select to route submitted absence requests to a specific approver that you enter in the Operator Id field.</p> <hr/> <p>Note: If the user accessing this page has a role that was entered in the Role not allowed Approve Automatically field on the Installation Settings page, the user cannot select her own operator ID.</p> <hr/> <p><i>Route To A Role</i>: Select to route submitted absence requests to a specific role that you enter in the Role Name field.</p> <hr/> <p>Note: If the user accessing this page has a role that was entered in the Role not allowed Approve Automatically field on the Installation Settings page, the user cannot select her own role.</p> <hr/> <p><i>Use Absence Name Default</i>: Select to route submitted absence requests according to the Approval Process ID and Approval Definition ID defined for the absence take on the Configure Country Take Setup - Absences Page.</p> |
| Submit | <p>Click to submit the absence requests that you select in the grid. The system submits the absences for approval according to the Submit Option you selected.</p> |
| Save for Later | <p>Click to save and validate all of the absence requests that you select in the grid without submitting them for approval.</p> <hr/> <p>Note: If you select the Hide Save For Later Button check box on the Installation Settings page, this field does not appear.</p> <hr/> |

| Field or Control | Description |
|-------------------------|---|
| Forecast | <p>Click to execute the forecasting process for the absence requests that you select in the grid.</p> <hr/> <p>Note: If you select the Hide Forecast Button check box on the Installation Settings page, this field does not appear.</p> <hr/> |

Partial Days Tab

Use this tab to enter partial day information for an absence request.

Note: The fields that are available on this tab for an absence request depend on the selections you make for the Allow Partial Days and Partial Days Option fields on the Country Take - Absences page for the associated absence take.

| Field or Control | Description |
|-------------------------|--|
| All Days | Select to indicate that all of the days in the date range of the absence request are partial days. Enter the number of partial day hours in the Start Day Hours field, or select the Start Half Day check box to indicate that all of the days were half days. |
| Start Day Hours | Enter the number of hours of the partial day absence for the first day in the date range for the absence request. When you enter a value in this field, the Start Half Day field becomes unavailable. |
| Start Half Day | Select to indicate that the first day of the date range of the absence request is a half day. When you select this check box, the Start Day Hours field becomes unavailable. |
| End Day Hours | Enter the number of hours of the partial day absence for the last day in the date range for the absence request. When you enter a value in this field, the End Half Day field becomes unavailable. |
| End Half Day | Select to indicate that the last day of the date range of the absence request is a half day. When you select this check box, the End Day Hours field becomes unavailable. |

This example illustrates the fields and controls on the Create and Maintain Absence Requests page: Partial Days tab.

| Absence Requests | | | | | | | | | | | | | |
|--|--------------|----------------|-------------|-----------------|-------------|------------|---------------|----------|--------------------------|-----------------|--------------------------|---------------|--------------------------|
| Personalize Find View All 1-5 of 7 Last | | | | | | | | | | | | | |
| Absence Detail Partial Days Additional Information Override Process Forecast Comments Demographic | | | | | | | | | | | | | |
| Select | *Employee ID | Name | Empl Record | Job Title | *Start Date | *End Date | *Absence Name | Duration | All Days | Start Day Hours | Start Half Day | End Day Hours | End Half Day |
| <input type="checkbox"/> | KU0131 | John Patterson | 0 | Manager-Revenue | 10/24/2016 | 10/24/2016 | Jury | 1 Days | <input type="checkbox"/> | | <input type="checkbox"/> | | <input type="checkbox"/> |
| <input type="checkbox"/> | KU0131 | John Patterson | 0 | Manager-Revenue | 10/18/2016 | 10/18/2016 | Sick | 8 Hours | <input type="checkbox"/> | | <input type="checkbox"/> | | <input type="checkbox"/> |
| <input type="checkbox"/> | KU0131 | John Patterson | 0 | Manager-Revenue | 09/20/2016 | 09/20/2016 | Vacation | 8 Hours | <input type="checkbox"/> | | <input type="checkbox"/> | | <input type="checkbox"/> |
| <input type="checkbox"/> | KU0131 | John Patterson | 0 | Manager-Revenue | 08/18/2016 | 08/18/2016 | Vacation | 8 Hours | <input type="checkbox"/> | | <input type="checkbox"/> | | <input type="checkbox"/> |
| <input type="checkbox"/> | KU0131 | John Patterson | 0 | Manager-Revenue | 08/16/2016 | 08/17/2016 | Sick | 16 Hours | <input type="checkbox"/> | | <input type="checkbox"/> | | <input type="checkbox"/> |

Additional Information Tab

Use this tab to enter user field data for absence requests.

Note: You can also enter this information using the [Absence Details Page](#), where the additional fields are labeled according to the setup on the [Configure Country Take Setup - User Fields Page](#).

This example illustrates the fields and controls on the Create and Maintain Absence Requests page: Additional Information tab.

| Absence Requests | | | | | | | | | | | | | | | | | | | |
|--|--------------|----------------|-------------|-----------------|-------------|------------|---------------|--------------------|--------------------|--------------------|--------------------|---------------|---------------|---------------|---------------|------------------|------------------|------------------|------------------|
| Personalize Find View All 1-5 of 7 Last | | | | | | | | | | | | | | | | | | | |
| Absence Detail Partial Days Additional Information Override Process Forecast Comments Demographic | | | | | | | | | | | | | | | | | | | |
| Select | *Employee ID | Name | Empl Record | Job Title | *Start Date | *End Date | *Absence Name | Config Character 1 | Config Character 2 | Config Character 3 | Config Character 4 | Config Date 1 | Config Date 2 | Config Date 3 | Config Date 4 | Config Decimal 1 | Config Decimal 2 | Config Decimal 3 | Config Decimal 4 |
| <input type="checkbox"/> | KU0131 | John Patterson | 0 | Manager-Revenue | 10/24/2016 | 10/24/2016 | Jury | | | | | | | | | | | | |
| <input type="checkbox"/> | KU0131 | John Patterson | 0 | Manager-Revenue | 10/18/2016 | 10/18/2016 | Sick | | | | | | | | | | | | |
| <input type="checkbox"/> | KU0131 | John Patterson | 0 | Manager-Revenue | 09/20/2016 | 09/20/2016 | Vacation | | | | | | | | | | | | |
| <input type="checkbox"/> | KU0131 | John Patterson | 0 | Manager-Revenue | 08/18/2016 | 08/18/2016 | Vacation | | | | | | | | | | | | |
| <input type="checkbox"/> | KU0131 | John Patterson | 0 | Manager-Revenue | 08/16/2016 | 08/17/2016 | Sick | | | | | | | | | | | | |

Override Tab

Use the tab to override the entitlement or adjustment amounts of absence requests.

You can also enter this information using the [Absence Details Page](#).

This example illustrates the fields and controls on the Create and Maintain Absence Requests page: Override tab.

| Absence Requests | | | | | | | | | | | | | |
|--|--------------|----------------|-------------|-----------------|-------------|------------|---------------|-----------------------------|----------------------------|--|--|--|--|
| Personalize Find View All 1-5 of 7 Last | | | | | | | | | | | | | |
| Absence Detail Partial Days Additional Information Override Process Forecast Comments Demographic | | | | | | | | | | | | | |
| Select | *Employee ID | Name | Empl Record | Job Title | *Start Date | *End Date | *Absence Name | Override Entitlement Amount | Override Adjustment Amount | | | | |
| <input type="checkbox"/> | KU0131 | John Patterson | 0 | Manager-Revenue | 10/24/2016 | 10/24/2016 | Jury | | | | | | |
| <input type="checkbox"/> | KU0131 | John Patterson | 0 | Manager-Revenue | 10/18/2016 | 10/18/2016 | Sick | | | | | | |
| <input type="checkbox"/> | KU0131 | John Patterson | 0 | Manager-Revenue | 09/20/2016 | 09/20/2016 | Vacation | | | | | | |
| <input type="checkbox"/> | KU0131 | John Patterson | 0 | Manager-Revenue | 08/18/2016 | 08/18/2016 | Vacation | | | | | | |
| <input type="checkbox"/> | KU0131 | John Patterson | 0 | Manager-Revenue | 08/16/2016 | 08/17/2016 | Sick | | | | | | |

Process Tab

Use this tab to view processing data for absence requests.

| Field or Control | Description |
|-----------------------------|--|
| Process Status | Displays the status of the absence event as it relates to processing in payroll. Valid values are <i>Not Processed</i> , <i>Processed</i> , and <i>Partially Processed</i> . The processing status is displayed by default for administrators. |
| Calendar Group ID | Displays the calendar group for which the absence take was processed. |
| Process Date | This field displays the most recent processing date for this absence event. |
| First Processed Date | The value in this field represents the original processing date for the absence event. The Process Date and First Processed Date fields show different processing dates, in the case of retroactive processing. |

This example illustrates the fields and controls on the Create and Maintain Absence Requests page: Process tab.

| Select | *Employee ID | Name | Empl Record | Job Title | *Start Date | *End Date | *Absence Name | Process Status | Calendar Group ID | Payee Run Number | Date of last update | Process Date | First Processed Date |
|--------------------------|--------------|----------------|-------------|-----------------|-------------|------------|---------------|----------------|--------------------|------------------|---------------------|--------------|----------------------|
| <input type="checkbox"/> | KU0131 | John Patterson | 0 | Manager-Revenue | 10/24/2016 | 10/24/2016 | Jury | Not Processed | | | 06/03/2016 | | |
| <input type="checkbox"/> | KU0131 | John Patterson | 0 | Manager-Revenue | 10/18/2016 | 10/18/2016 | Sick | Not Processed | | | 06/03/2016 | | |
| <input type="checkbox"/> | KU0131 | John Patterson | 0 | Manager-Revenue | 10/10/2016 | 10/10/2016 | Vacation | Processed | K3C9K0CAK0PNA16821 | | 10/05/2016 | 10/06/2016 | 10/06/2016 |
| <input type="checkbox"/> | KU0131 | John Patterson | 0 | Manager-Revenue | 09/20/2016 | 09/20/2016 | Vacation | Processed | K3C9K0CAK0PNA16820 | | 07/15/2016 | 10/06/2016 | 10/06/2016 |
| <input type="checkbox"/> | KU0131 | John Patterson | 0 | Manager-Revenue | 08/18/2016 | 08/18/2016 | Vacation | Not Processed | | | 06/03/2016 | | |

Use the **Processed** hyperlink to view the complete processing details.

This example illustrates the fields and controls on the Processing Details Modal.

| Processing Details | |
|---------------------------|-------------------------|
| Status | Processed |
| Paid | 8 Hours |
| Unpaid | 0 Hours |
| Period | 06/01/2021 - 06/30/2021 |

Forecast Tab

Use this tab to view forecasting data.

This example illustrates the fields and controls on the Create and Maintain Absence Requests page: Forecast tab.

| Absence Requests | | | | | | | | | | | | Personalize | Find | View All | First | 1-5 of 7 | Last | | | | | | |
|--------------------------|--------------|----------------|-------------|-----------------|-------------|------------|---------------|---------------|----------------|--------------------|------------------|--------------|------------------------|----------|---------|----------|----------|-------------|--|--|--|--|--|
| Absence Detail | | | | | | | | | | | | Partial Days | Additional Information | Override | Process | Forecast | Comments | Demographic | | | | | |
| Select | *Employee ID | Name | Empl Record | Job Title | *Start Date | *End Date | *Absence Name | Balance | Forecast Value | Forecast Date Time | Forecast Message | | | | | | | | | | | | |
| <input type="checkbox"/> | KU0131 | John Patterson | 0 | Manager-Revenue | 10/24/2016 | 10/24/2016 | Jury | Not Available | | | | | | | | | | | | | | | |
| <input type="checkbox"/> | KU0131 | John Patterson | 0 | Manager-Revenue | 10/18/2016 | 10/18/2016 | Sick | 55.38 Hours | | | | | | | | | | | | | | | |
| <input type="checkbox"/> | KU0131 | John Patterson | 0 | Manager-Revenue | 09/20/2016 | 09/20/2016 | Vacation | 429.23 Hours | | | | | | | | | | | | | | | |
| <input type="checkbox"/> | KU0131 | John Patterson | 0 | Manager-Revenue | 08/18/2016 | 08/18/2016 | Vacation | 429.23 Hours | | | | | | | | | | | | | | | |
| <input type="checkbox"/> | KU0131 | John Patterson | 0 | Manager-Revenue | 08/16/2016 | 08/17/2016 | Sick | 55.38 Hours | | | | | | | | | | | | | | | |

Comments Tab

Use the Comments tab to enter comments for absence requests. When you enter a comment, it applies only to the absence request on the same row.

This example illustrates the fields and controls on the Create and Maintain Absence Requests page: Comments tab.

| Absence Requests | | | | | | | | | | | | Personalize | Find | View All | First | 1-5 of 7 | Last | | | | | | |
|--------------------------|--------------|----------------|-------------|-----------------|-------------|------------|---------------|---------|--|--|--|--------------|------------------------|----------|---------|----------|----------|-------------|--|--|--|--|--|
| Absence Detail | | | | | | | | | | | | Partial Days | Additional Information | Override | Process | Forecast | Comments | Demographic | | | | | |
| Select | *Employee ID | Name | Empl Record | Job Title | *Start Date | *End Date | *Absence Name | Comment | | | | | | | | | | | | | | | |
| <input type="checkbox"/> | KU0131 | John Patterson | 0 | Manager-Revenue | 10/24/2016 | 10/24/2016 | Jury | | | | | | | | | | | | | | | | |
| <input type="checkbox"/> | KU0131 | John Patterson | 0 | Manager-Revenue | 10/18/2016 | 10/18/2016 | Sick | | | | | | | | | | | | | | | | |
| <input type="checkbox"/> | KU0131 | John Patterson | 0 | Manager-Revenue | 09/20/2016 | 09/20/2016 | Vacation | | | | | | | | | | | | | | | | |
| <input type="checkbox"/> | KU0131 | John Patterson | 0 | Manager-Revenue | 08/18/2016 | 08/18/2016 | Vacation | | | | | | | | | | | | | | | | |
| <input type="checkbox"/> | KU0131 | John Patterson | 0 | Manager-Revenue | 08/16/2016 | 08/17/2016 | Sick | | | | | | | | | | | | | | | | |

Demographic Tab

Use the Demographic tab to view demographic data for absence requests.

This example illustrates the fields and controls on the Create and Maintain Absence Requests page: Demographic tab.

| Absence Requests | | | | | | | | | | | | Personalize | Find | View All | First | 1-5 of 7 | Last | | | | | | |
|--------------------------|--------------|----------------|-------------|-----------------|-------------|------------|---------------|----------|------------|---------------|-----------|---------------|------------------------|---------------|------------|----------|--------------------------|-------------|--|--|--|--|--|
| Absence Detail | | | | | | | | | | | | Partial Days | Additional Information | Override | Process | Forecast | Comments | Demographic | | | | | |
| Select | *Employee ID | Name | Empl Record | Job Title | *Start Date | *End Date | *Absence Name | Job Code | Department | Business Unit | HR Status | Location Code | Position Number | Supervisor ID | Reports To | Company | Global Payroll Pay Group | Pay Group | | | | | |
| <input type="checkbox"/> | KU0131 | John Patterson | 0 | Manager-Revenue | 10/24/2016 | 10/24/2016 | Jury | 600155 | 13140 | GBIBU | Active | KUKS00 | | KU0046 | | GBI | K0WPG KU2 | KU2 | | | | | |
| <input type="checkbox"/> | KU0131 | John Patterson | 0 | Manager-Revenue | 10/18/2016 | 10/18/2016 | Sick | 600155 | 13140 | GBIBU | Active | KUKS00 | | KU0046 | | GBI | K0WPG KU2 | KU2 | | | | | |
| <input type="checkbox"/> | KU0131 | John Patterson | 0 | Manager-Revenue | 09/20/2016 | 09/20/2016 | Vacation | 600155 | 13140 | GBIBU | Active | KUKS00 | | KU0046 | | GBI | K0WPG KU2 | KU2 | | | | | |
| <input type="checkbox"/> | KU0131 | John Patterson | 0 | Manager-Revenue | 08/18/2016 | 08/18/2016 | Vacation | 600155 | 13140 | GBIBU | Active | KUKS00 | | KU0046 | | GBI | K0WPG KU2 | KU2 | | | | | |
| <input type="checkbox"/> | KU0131 | John Patterson | 0 | Manager-Revenue | 08/16/2016 | 08/17/2016 | Sick | 600155 | 13140 | GBIBU | Active | KUKS00 | | KU0046 | | GBI | K0WPG KU2 | KU2 | | | | | |

Canceling Absences

| Field or Control | Description |
|--------------------------------|---|
| Cancel Absence Requests | Click to replace the Absence Requests grid with the Absence Requests for Cancellation grid. This grid displays the same list of absences, but includes fields that enable you to cancel them. |

This example illustrates the fields and controls for the Absence Requests for Cancellation grid.

| Field or Control | Description |
|--------------------------------|---|
| Cancel Reason | Select a reason for canceling the absence request. |
| Submit for Cancellation | Click to submit the cancellation of the absence requests that you select in the grid. The system submits the cancellations for approval according to the Submit Option you selected. |

Maintain Attachments Page

This page is used to maintain absence documents.

Navigation:

Select **View/Add** link under Attachment in Create and Maintain Absence Requests Page

This example illustrates the Maintain Attachments Modal.

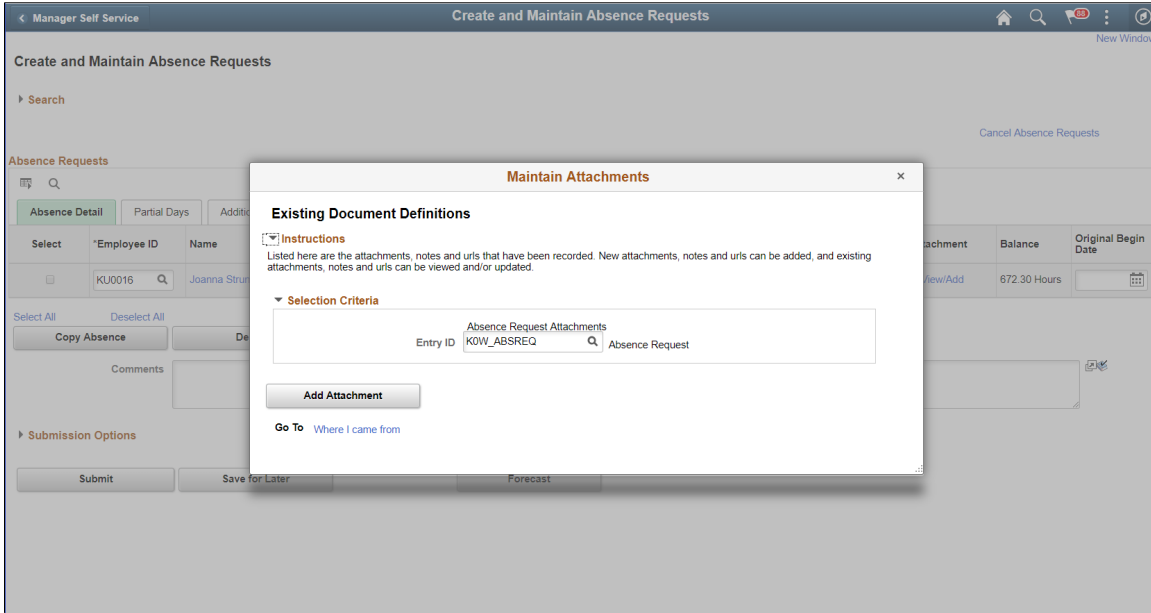

Click **Add Attachment** button.

This example illustrates the fields and controls of Maintain Attachments Modal.

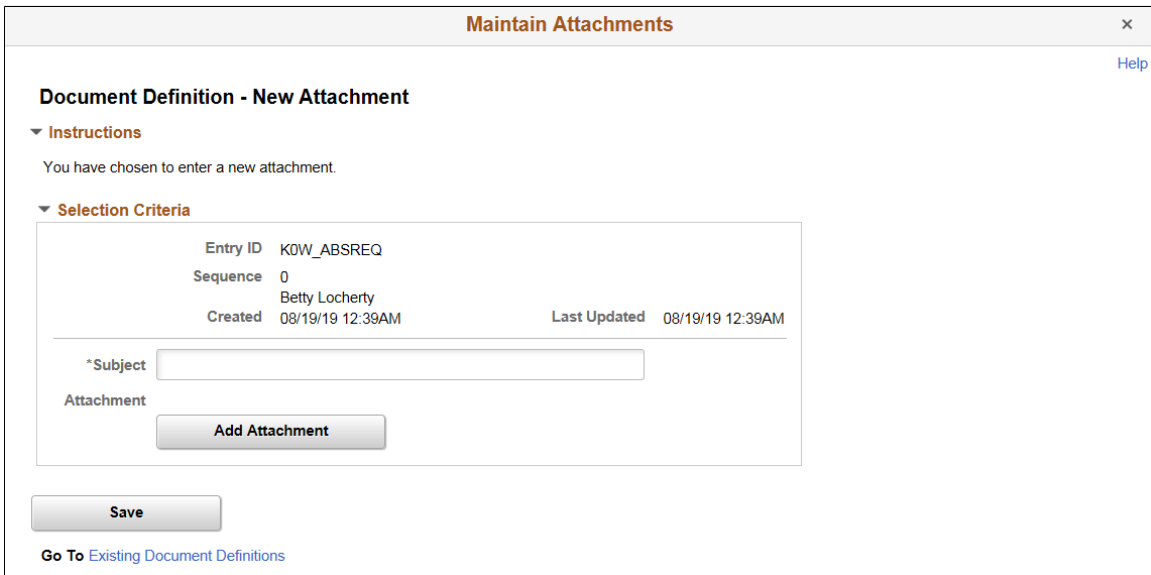

| Field or Control | Description |
|-------------------------|---|
| Subject | Enter a subject name before adding the attachment. |
| Add Attachment | Click the Add Attachment button to browse and upload the required file. |

Absence Details Page

Use the Absence Details page (GP_ABS_SS_REQUEST) to enter and update details for an absence request.

Navigation:

Click the **Name** link on the Create and Maintain Absence Requests page.

This example illustrates the fields and controls on the Absence Details page.

Absence Details

Owen Wills
Bus Person

Instructions

Enter Start Date, End Date, and Absence Name. Then complete the rest of the required fields before returning to the Extended Absence Request page

Details ?

*Start Date [i]

End Date [i]

Filter by Type v

*Absence Name v

*Reason v

Duration Days

Calculate End Date or Duration

[View Monthly Calendar](#)

Override

Entitlement

Adjustment

Workflow

Status Submitted

Comments

Requestor Comments

Request History [Personalize](#) | [i] First [v]

| Status | Name | Date | Comments |
|-----------|------------|------------|----------|
| Submitted | Owen Wills | 08/21/2012 | |

OK
Cancel

Absence Detail

| Field or Control | Description |
|----------------------------|--|
| Start Date | Select the first day of the absence event. The field option defaults to the current date. If there's a break in the absence, enter each event separately. For example, if you're out sick for two days, return to work for three days, and are out sick again, enter two absence events. If the absence includes a weekend (say, Thursday to Monday), enter one absence event. |
| End Date | Select the last day of the absence event. If you leave this field empty and the Calculate End Date option on the Configure Country Take Setup - Date Rules Page is selected, the system automatically determines the end date based on the begin date, duration, and partial days options. |
| Original Start Date | <p>Select the original start date of the absence event. Enter a date if the absence has legal or payment implications based on the original start date of the absence.</p> <p>This field is visible when Display Original Begin Date is selected on the Configure Country Take Setup - Absences Page.</p> <p>For example, an employee has a leg injury. He reports an absence from January 3, 2005 to January 7, 2005. The employee starts to feel better and returns to work. Later, he has a relapse and has to take two more days of absence starting on January 17, 2005 to January 18, 2005. The original begin date for the second absence should be January 3, 2005. The system can link the two events and treat the event as a single one in terms of eligibility or a minimum waiting period.</p> <hr/> <p>Note: Careful consideration is needed when enabling this field in self-service. Incorrect data entered in this field might lead to incorrect eligibility calculations and payment for one or more events.</p> <hr/> |
| Filter by Type | Select the absence type. The selection you make in this field will limit or filter the selections available in the Absence Name field. |

| Field or Control | Description |
|-------------------------|--|
| Absence Name | <p>Select the absence name from the available options. The options available depend on the selection in the Filter by Type field, the absence takes that are enabled in the Country Take setup, and the elements for which the employee is eligible.</p> <p>After you select entries in the above fields, the system refreshes the page with additional fields.</p> <hr/> <p>Note: If you decide to change the Absence Name previously selected, the system will display a warning that all your existing absence data will be lost.</p> <hr/> <p>See Element EligibilityElement Resolution.</p> |
| Reason | <p>Select a reason from the available options. The reasons available depend on your selections in the previous fields. Absence reasons are linked to the Absence Name (Take) through the Absence Take Type.</p> <p>See Defining Absence Types and Reasons.</p> |

| Field or Control | Description |
|-------------------------|---|
| Partial Days | <p>Specify which days of the absence event are partial days.</p> <p>If the Calculate End Date or Duration option is enabled on the Absence (setup) page, and the Unit Type is <i>Hours</i>, the system does consider any partial hours or half-day entries that are entered in this group box when it calculates the end date or duration.</p> <p>For example, an employee has a work schedule of 8 hours per day from Monday through Friday. The employee reports an absence from Monday, January 8, 2007 through Wednesday, January 10, 2007. Then employee takes a half day off on Monday and full days off for the rest of the absence.</p> <p>Example 1: The Country Take set up is defined as follows:</p> <ul style="list-style-type: none"> • Unit Type = <i>Hours</i>. • Allow Partial Days = Selected. • Partial Days = <i>Partial Hours</i>. <p>With these settings, to correctly enter the absence data the employee should report:</p> <ul style="list-style-type: none"> • Start Date = <i>January 8, 2007</i>. • End Date = <i>January 10, 2007</i>. • Partial Days = <i>Start Day Only</i>. • Start Day Hours = <i>4</i>. <p>Example 2: The Country Take set up is defined as follows:</p> <ul style="list-style-type: none"> • Unit Type = <i>Hours</i>. • Allow Partial Days = Selected. • Partial Days = <i>Half Days</i>. <p>With these settings, to correctly enter the absence data the employee should report:</p> <ul style="list-style-type: none"> • Start Date = <i>January 8, 2007</i>. • End Date = <i>January 10, 2007</i>. • Partial Days = <i>Start Day Only</i>. • Start Day is Half Day = Selected. |

| Field or Control | Description |
|---|---|
| | <p>Note: Data that you enter in the following fields is used in the absence calculation process only if the data is referenced by your absence formulas.</p> <hr/> <p>The available options in the Partial Days field when the absence is calculated in days include:</p> <ul style="list-style-type: none"> • <i>All Days</i> • <i>End Day Only</i> • <i>None</i> • <i>Start Day Only</i> • <i>Start and End Days</i> |
| Start Day Hours, End Day Hours, and All Day Hours | <p>Enter the number of hours the payee was absent for the first day of the absence, the last day of the absence, or all days of the absence, respectively.</p> |
| All Days are Half Days, Start Day is Half Day, and End Day is Half Day | <p>Select to specify which days of the absence event are half days.</p> <hr/> <p>Important! These fields are not available unless the Country Take enables you to specify partial days on the Request Absence page.</p> <hr/> |
| Duration | <p>Enter Duration by days or hours. You do not have to enter Duration if the Calculate Duration is enabled on the Absence (setup) page). The system calculates the duration of the absence in hours or days when you click the Calculate Duration button.</p> <p>The behavior of this field depends on the settings on the Absence (setup) page. The value is automatically calculated if the Calculate End Date option is selected.</p> <ul style="list-style-type: none"> • If the absence is measured in days or hours, the system automatically calculates the duration when you enter the begin date and end date. • If you want to calculate the end date based on a duration, then the system calculates the end date when you enter the begin date and duration and you click the Calculate End Date button. |

| Field or Control | Description |
|---------------------------------------|---|
| Calculate End Date or Duration | <p>Click this button to have the system calculate the end date of an absence event based on the entries in the Start Date and Duration fields, or to calculate the Duration based on entries in the Start Date and End Date fields.</p> <hr/> <p>Note: If you selected to calculate end date and duration in the Country Take - Date Rules page, then you had to indicate which field to recalculate when both fields contain values. Hence if the user entered values for duration and end date and clicks Calculate End Date or Duration button, one of the fields will be recalculated.</p> <hr/> |
| Forecast Balance | <p>Click this button to run the online absence forecasting process for the type of absence take selected for this absence request. This button will appear only for those absence names that require forecasting. After the forecasting process is completed, the page will display the <i>Forecast Returned Value</i> and <i>Status</i> and a link View Forecast Details to access the list of the forecast balance details.</p> <hr/> <p>Note: The system does not automatically save your absence request before initiating the Forecasting process. Although the system prompts you to save before leaving the page, it is not necessary to save your forecast information before or after the Forecasting process.</p> <hr/> |
| Save for Later | <p>This option allows the employee to save the absence event information for later review and editing, and does not generate workflow for the approvals process.</p> |
| Submit | <p>This option saves the information and generates the workflow approval process that routes the request to one or more managers whose roles are defined in workflow to enable them to approve, deny, or push back the absence request to the previous approval level with comments. The push back is often used by approvers to suggest absence request revision or to obtain additional information.</p> |
| Cancel | <p>This option is available only for requests that have been saved for later or that were pushed back from the approver. Depending on the Country Take setup, when you click Cancel the application either physically deletes the request from request and workflow records, or sets the status of the request to cancelled.</p> |

Additional Information

Use these fields to enter user field data for the absence request. The fields that appear in this group box depend on how Absence Management is configured during the implementation process.

Override

Use these fields override the entitlement or adjustment amounts for the absence request.

Workflow

This group box displays the current approval status of the absence request.

Comments

The **Requestor Comments** field enables the employee to enter free form text related to the absence request that becomes part of the record and is visible throughout the approval process. Comments display on the Absence Details page.

Request History

This group box displays the history of all actions taken for the absence request.

Approve Absence Requests Page

Use the Approve Absence Requests page (HGA_MANAGE) to approve multiple absence requests.

Navigation:

Global Payroll & Absence Mgmt > Payee Data > Maintain Absences > Approve Absence Requests

Search

The search criteria for this page are identical to the criteria that you use for the [Create and Maintain Absence Requests Page](#), with one exception: **Work Flow Status**.

| Field or Control | Description |
|-------------------------|---|
| Work Flow Status | <p>Enter a value to search for absence requests based on work flow status. Values are:</p> <ul style="list-style-type: none"> • <i>Approved</i>: Select to search for absence requests that you approved. • <i>Denied</i>: Select to search for absence requests that you denied. • <i>My Pending</i>s: Select to search for absence requests that are pending your approval. • <i>Pushed Back</i>: Select to search for absence requests that you pushed back. |

Absence Requests

The tabs in this section of the page display the same information as the tabs in the Absence Request section of the [Create and Maintain Absence Requests Page](#), but you cannot edit the fields.

| Field or Control | Description |
|--------------------------|--|
| Approver Comments | Any comments you enter in this field are added to the selected absence requests when you click the Approve , Deny , or Push Back buttons. |

Approval Options

| Field or Control | Description |
|--------------------------------------|--|
| Override Forecast Eligibility | Select to make the system ignore forecasting requirements when you approve, deny, or push back absence requests. |
| Approve | Click to approve the selected absence requests. |
| Deny | Click to deny the selected absence requests. |
| Push Back | Click to push back the selected absence requests. |
| Forecast | Click to initiate the forecasting process for the selected absence requests. |

Note: As an administrator, you can view any document uploaded along with an Absence Request in the *Approve Absence Requests* page.

Absence Event Entry Page

Use the Absence Event Entry page (GP_ABS_EVENT) to enter, update, and void absences.

Start the Absence Forecasting process.

Navigation:

Global Payroll & Absence Mgmt > Payee Data > Maintain Absences > Absence Event > Absence Event Entry

This example illustrates the fields and controls on the Absence Event Entry page.

The screenshot shows the 'Absence Event Entry' page for employee 'Rebekah Jones' (Employee ID: K05001). The page includes a 'Forecast' button and a table of 'Absence Events'. The table has columns for Absence Take, Description, Begin Date, End Date, Partial Hours, Process Action, Voided, Original Begin Date, Details, Attachment, Entry Source, and Workflow Status. Two rows are visible, both for 'Paid Time Off' (PTO) on 06/06/2019 and 08/01/2019.

| Absence Take | Description | Begin Date | End Date | Partial Hours | Process Action | Voided | Original Begin Date | Details | Attachment | Entry Source | Workflow Status |
|--------------|---------------|------------|------------|---------------|----------------|--------------------------|---------------------|---------|------------|-----------------------------|-----------------|
| K0AT PTO | Paid Time Off | 06/06/2019 | 06/10/2019 | | Normal | <input type="checkbox"/> | 06/06/2019 | Details | View/Add | Administrator Absence Event | Needs Approval |
| K0AT PTO | Paid Time Off | 08/01/2019 | 08/02/2019 | | Normal | <input type="checkbox"/> | 08/01/2019 | Details | View/Add | Administrator Absence Event | Needs Approval |

To enter a new absence, insert a row and complete the fields described below. To make changes to a row, delete the row and add a new one.

Note: If you enter absences with overlapping dates, and your absence rules do not allow you to enter more than one absence for the same day, an error message appears when you try to save the events. If you've elected to use the automatic priority processing feature and have assigned a priority number to your absence take elements, the system determines which take element has priority for the date in question and offers the option of executing priority processing. You define absence priority rules on the Absence Take - Priority page.

Absence Take

| Field or Control | Description |
|---------------------------------------|--|
| From and Through | <p>The user can display absence request that fall within a specified date range by entering dates in the From: and Through: fields. If the From, Through or both dates is left blank, the system will initialize the search based on the default dates.</p> <p>The From and Through date range is determined by the Default History Date Range values entered on the History Grid page of the Country component. If the Default History Date Range has not been set up the system uses the current date minus 90 days for the From field and the current date plus 90 days for the Through field.</p> <p>See Defining Self Service Absence Rules by Country.</p> |
| Refresh | <p>Click the Refresh button after entering, changing, or removing dates in the From: and Through: fields.</p> <hr/> <p>Note: If you do not click Refresh after changing the From or Through fields you will get an error message that tells you that you must click the Refresh button. You are able to proceed with absence entries once the Refresh button has been clicked.</p> <hr/> |
| Absence Take Element | <p>Select the Absence Take element that corresponds to the payee’s absence. (You can select from all absence take elements that are defined by your organization, not just those for which the payee is eligible.)</p> |
| Begin Date and End Date | <p>Enter the begin and end dates of the absence. If there's a break in the absence, enter each event separately. For example, if a payee is out sick for two days, returns to work for three days, and then is out sick again, enter two absence events. If the absence includes a weekend (say, Thursday to Monday), enter one absence event.</p> <p>The system uses the Take definition that is in effect on the begin date that you specify.</p> |

| Field or Control | Description |
|----------------------------|---|
| Partial Hours | <p>For absences of less than a full day, enter the number of hours that the payee was absent.</p> <p>If the payee was absent for more than one day (the begin and end dates are different), the system assumes that the partial hours apply only to the first day of the absence. To specify otherwise, click the Details link to access the Absence Event Input Detail page.</p> |
| Process Action | <p>For a new absence event, the default is <i>Normal</i>.</p> <p>Select <i>Void</i> to void an absence that has already gone through the Take process. The event is not processed in subsequent runs. Instead, the Process Action is reset to <i>Normal</i> and the Voided check box is automatically selected during the next Take process.</p> <p>During retroactive processing, a new version of the results is calculated without the voided event. Positive input is not generated from the voided event, and the results for earning/ deduction have deltas.</p> |
| Voided | <p>Selected if you voided the event and ran the take process.</p> <p>This field can also be selected if you're using the automatic priority processing feature and have assigned a priority number to your absence take elements. If you save absence entries with overlapping dates, the system voids the event with the lower priority and creates a new event for the days that do not overlap.</p> |
| Original Begin Date | <p>Enter a date in this field if your absence take rules allow you to link this absence to a previous absence that was taken for the same reason. (The Link Absence and By Original Begin Date options are selected on the take element's Period page.)</p> <p>If this absence is related to another absence, enter the begin date of the original absence.</p> <p>Example: A payee is out sick for the following periods of time:</p> |

| Absence Type | Reason (not entered online) | Absence Begin Date | Absence End Date | Original Begin Date |
|---------------------|------------------------------------|---------------------------|-------------------------|----------------------------|
| Sick | Sprained wrist | May 15 | May 16 | May 15 |

| Absence Type | Reason (not entered online) | Absence Begin Date | Absence End Date | Original Begin Date |
|---------------------|------------------------------------|---------------------------|-------------------------|----------------------------|
| Sick | Flu | June 1 | June 5 | June 1 |
| Sick | Wrist didn't heal properly | June 10 | June 10 | May 15 |

| Field or Control | Description |
|-------------------------|--|
| | <p>Entering the same original begin date for the first and third absence events tells the system that the absences are related. If you defined the take element to link absences, the system checks to see if the current absence occurred within the time frame allowed for linking. If it did, the two events are linked.</p> <p>The default value for Original Begin Date is the begin date. Changing the begin date here does not update the original begin date.</p> |
| Details | Click to display the Absence Event Input Detail page, where you can enter additional information about the absence. |
| Attachment | <p>Shows the View/Add link to open Maintain Attachments Page.</p> <p>The following video provides an overview of Attachment Uptake for Administrators.</p> <p>Video: Image Highlights, PeopleSoft HCM Update Image 29: Absence Request - Attachment Uptake for Administrators</p> |
| Entry Source | Displays the origin of absence event. The values are: <i>Administrator, Time & Labor, Third Party, Employee Self Service, Manager Self Service, Employee Timesheet, and Manager Timesheet.</i> |
| Work Flow Status | Displays the current workflow status of the employee extended absence, manager extended absence, administrator extended absence, and absence event. The values are: <i>Saved, Needs Approval, Pushed Back, Denied, Approved, and Cancelled.</i> |
| Forecast | After entering absence events, click this button to start the Forecasting process. To use this button, absence forecasting must be enabled for one or more take elements. |

Process Status

Select the Process Status tab.

This tab displays information on the status of the absence event process and is meant for use by administrators.

This example illustrates the fields and controls on the Absence Event Entry page - Process Status tab.

| Absence Take | Description | *Begin Date | End Date | Status | Calendar Group ID | Process Date |
|--------------|---------------|-------------|------------|---------------|-------------------|--------------|
| K0AT PTO | Paid Time Off | 02/05/2003 | 02/05/2003 | Not Processed | | |
| K0AT PTO | Paid Time Off | 01/04/2003 | 01/08/2003 | Not Processed | | |

| Field or Control | Description |
|------------------|---|
| Status | <p>Displays the status of the absence event as it relates to processing in payroll. Valid values are <i>Not Proc.</i> (Not Processed), <i>Processed</i>, and <i>Finalized</i>.</p> <hr/> <p>Note: Absence events with a status of <i>Finalized</i> will be set to <i>Processed</i> if the absence event has been retroactively processed during an on cycle or off cycle calculation</p> |

Forecast Value

Select the Forecast Value tab.

This example illustrates the fields and controls on the Absence Event Entry page - Forecast Value tab.

| Absence Take | Description | *Begin Date | End Date | Forecast Value | Forecast Date Time | Forecast Details |
|--------------|---------------|-------------|------------|----------------|--------------------|------------------|
| K0AT PTO | Paid Time Off | 02/05/2003 | 02/05/2003 | | | Forecast Details |
| K0AT PTO | Paid Time Off | 01/04/2003 | 01/08/2003 | | | Forecast Details |

| Field or Control | Description |
|-------------------------|---|
| Forecast Value | The alphanumeric value resolved by the forecasting element. You associate a forecasting formula with a take element on the Take – Forecasting page. (For example, your forecast element might return a value of <i>Eligible</i> or <i>Not Eligible</i> .) |
| Forecast Date Time | The last date and time that the Forecasting process was run for the take element. |
| Forecast Details | Select the link to display the Absence Forecast Results page. |

Deleting Absence Event Rows

The Delete row button will be available or grayed out based on the **Payroll Status** and the **Delete Option** selected on the Event Entry page. When the **Delete Option** selected is *All Events Except Processed* the Delete row button is disabled on all processed rows and finalized rows. When the **Delete Option** selected is *All Event Except Finalized* the Delete row button is disabled on all finalized rows.

A warning is issued when you select to delete an absence event and you have selected the Delete Option of All Events Except Finalized. The warning message states, "Are you sure you want to delete the Event %1 Begin Date %2 End Date %3?" The explanation attached to this message states, "This absence event has already been processed. If you delete this event you might have to reprocess the absence to correct the results."

See [Defining Self Service Absence Rules by Country](#).

Note: If Generate Absence Payable Time is enabled for your system and you delete an absence event for which payable time has been loaded into Payroll for North America, you receive a warning message. If you confirm the deletion, the next time the TL_GENPT PS Job runs, the Time Administration process deletes the generated payable time associated with the deleted absence event.

For more information, see "Generate Absence Payable Time Page" (PeopleSoft Time and Labor)

Absence Event Input Detail Page

Use the Absence Event Input Detail page (GP_ABS_EVENT_SEC) to enter detailed information for an absence, including the reason, processing action, manager approval, user-defined data, entitlement adjustment, and partial hours.

Navigation:

Click the **Details** link on the Absence Event Entry page.

This example illustrates the fields and controls on the Absence Event Input Detail page (1 of 2).

Absence Event Input Detail

Absence Event

Absence Event Input Detail

| | |
|--|--|
| <p>Absence Take <input type="text" value="KOAT PTO"/></p> <p>Absence Reason <input type="text"/></p> <p>Entry Source Administrator Absence Event</p> <p>Workflow Status Approved</p> <p>*Process Action <input type="text" value="Normal"/></p> <p><input type="checkbox"/> Voided Indicator</p> <p><input checked="" type="checkbox"/> Manager Approved</p> | <p>Absence Type Vacations</p> <p>Event Priority 10</p> <p>Last Updated 10/21/2002</p> <p>Process Status Not Processed</p> <p>Calendar Group ID</p> <p>Process Date</p> <p>First Processed Date</p> |
|--|--|

Absence Begin / End Data

| |
|---|
| *Begin Date <input type="text" value="02/05/2003"/> |
| End Date <input type="text" value="02/05/2003"/> |
| Original Begin Date <input type="text" value="02/05/2003"/> |
| Partial Days <input type="text" value="None"/> |

This example illustrates the fields and controls on the Absence Event Input Detail page (2 of 2).

User Defined Fields

| | |
|--|---|
| <p>User Defined Fields 1</p> <p>Date 1 <input type="text"/></p> <p>Character 1 <input type="text"/></p> <p>Monetary 1 <input type="text"/></p> <p>Decimal 1 <input type="text"/></p> <p>Currency 1 <input type="text"/></p> | <p>User Defined Fields 2</p> <p>Date 2 <input type="text"/></p> <p>Character 2 <input type="text"/></p> <p>Monetary 2 <input type="text"/></p> <p>Decimal 2 <input type="text"/></p> |
| <p>User Defined Fields 3</p> <p>Date 3 <input type="text"/></p> <p>Character 3 <input type="text"/></p> <p>Monetary 3 <input type="text"/></p> <p>Decimal 3 <input type="text"/></p> <p>Currency 3 <input type="text"/></p> | <p>User Defined Fields 4</p> <p>Date 4 <input type="text"/></p> <p>Character 4 <input type="text"/></p> <p>Monetary 4 <input type="text"/></p> <p>Decimal 4 <input type="text"/></p> |

Override

| | |
|----------------------------------|---------------------------------|
| Entitlement <input type="text"/> | Adjustment <input type="text"/> |
|----------------------------------|---------------------------------|

[Comments](#)

| Field or Control | Description |
|-------------------------|---|
| Absence Take | Displays the take element that you selected on the Absence Event Entry page. |
| Absence Type | The absence type for the Take element is displayed. |
| Absence Reason | You can select an absence reason from those that were in effect as of the absence begin date. You define absence reasons on the Absence Types page and link an absence type to a take element on the Take - Calculation page. |

| Field or Control | Description |
|--------------------------|---|
| Event Priority | <p>Displays the priority number of the take element if one was assigned on the Absence Take - Priority page.</p> <p>If you enter more than one absence for the same date, you can use the automatic priority processing feature when you save your entries. The system compares the priority numbers of the overlapping absences to determine which take rule to apply for the date in conflict. The lower the number, the higher the priority.</p> |
| Entry Source | <p>Identifies the source of the absence, employee extended absence, manager extended absence, and administrator extended absence data. Values are:</p> <p><i>Admin:</i> The absence event entry was created using the Absence Event Entry page. This is the default for new entries using the Absence Event Entry page.</p> <p><i>Third Party Time and Labor:</i> The absence event entry was created using a third-party interface.</p> <p><i>Employee Self Service:</i> The absence event entry was created using the Absence Self Service Employee request page.</p> <p><i>Manager Self Service:</i> The absence event entry was created using the Absence Self Service Manager request page.</p> <p><i>Employee Timesheet:</i> The absence event entry was created using Employee Timesheet page</p> <p><i>Manager Timesheet:</i> The absence event entry was created using Manager Timesheet page.</p> |
| Manager Approved | <p>Select to have the absence processed when you run the take process. This check box is selected, by default, if you defined the absence take element (on the Absence Take - Calculation page) as not requiring manager approval.</p> |
| Last Updated | <p>This date appears after you save your entry.</p> |
| Workflow Status | <p>Displays the current workflow status of the absence take.</p> |
| Process Status | <p>Displays the status of the absence event as it relates to processing in payroll. Valid values are <i>Not Processed</i>, <i>Processed</i>, and <i>Finalized</i>.</p> |
| Calendar Group ID | <p>Displays the calendar group for which the absence take was processed.</p> |
| Process Date | <p>This field displays the most recent processing date for this absence event.</p> |

| <i>Field or Control</i> | <i>Description</i> |
|--------------------------------|---|
| First Processed Date | The value in this field represents the original processing date for the absence event. The Process Date and First Processed Date fields show different processing dates, in the case of retroactive processing. |

Absence Begin / End Data

| <i>Field or Control</i> | <i>Description</i> |
|--|--|
| Begin Date, End Date, and Original Begin Date | These fields display the dates that you entered for the absence event on the main page. Any changes that you make here update the main page. |

Data that you enter in the following fields is used in absence calculations only if the data is referenced by your absence formulas.

| Field or Control | Description |
|-------------------------|---|
| Partial Days | <p>Specify which days of the absence event are partial days.</p> <p>If the Calculate End Date or Duration option is enabled on the Absence (setup) page, and the Unit Type is <i>Hours</i>, the system does consider any partial hours or half-day entries that are entered in this group box when it calculates the end date or duration.</p> <p>For example, an employee has a work schedule of 8 hours per day from Monday through Friday. The employee reports an absence from Monday, January 8, 2007 through Wednesday, January 10, 2007. Then employee takes a half day off on Monday and full days off for the rest of the absence.</p> <p>Example 1: The Country Take set up is defined as follows:</p> <ul style="list-style-type: none"> • Unit Type = <i>Hours</i>. • Allow Partial Days = Selected. • Partial Days = <i>Partial Hours</i>. <p>With these settings, to correctly enter the absence data the employee should report:</p> <ul style="list-style-type: none"> • Start Date = <i>January 8, 2007</i>. • End Date = <i>January 10, 2007</i>. • Partial Days = <i>Start Day Only</i>. • Start Day Hours = <i>4</i>. <p>Example 2: The Country Take set up is defined as follows:</p> <ul style="list-style-type: none"> • Unit Type = <i>Hours</i>. • Allow Partial Days = Selected. • Partial Days = <i>Half Days</i>. <p>With these settings, to correctly enter the absence data the employee should report:</p> <ul style="list-style-type: none"> • Start Date = <i>January 8, 2007</i>. • End Date = <i>January 10, 2007</i>. • Partial Days = <i>Start Day Only</i>. • Start Day is Half Day = Selected. |

| Field or Control | Description |
|---|---|
| | <p>Warning! If the absence unit type is defined in days in the Country Take setup, we do not recommend using partial days options.</p> <hr/> <p>Note: Data that you enter in the following fields is used in the absence calculation process only if the data is referenced by your absence formulas.</p> <hr/> <p>The available options in the Partial Days field when the absence is calculated in days include:</p> <ul style="list-style-type: none"> • <i>All Days</i> • <i>End Day Only</i> • <i>None</i> • <i>Start Day Only</i> • <i>Start and End Days</i> |
| Start Day Hours, End Day Hours, and All Day Hours | Enter the number of hours the payee was absent for the first day of the absence, the last day of the absence, or all days of the absence, respectively. |
| Start Day is Half Day, End Day is Half Day, and All Days are Half Days | Select if the payee was absent exactly half a day. |

User Defined Fields

You can enter data in up to 16 user-defined fields. When you run the Take process, the system writes the data to the daily records, so that it's available to the count formulas.

A system element in the GP_ABS_EVENT record corresponds to each user-defined field. The naming conventions are:

- EVT CONFIG1(2, 3, 4) DT for date values.
- EVT CONFIG1(2, 3, 4) DC for decimal values.
- EVT CONFIG1(2, 3, 4) CH for character values.
- EVT CONFIG1(2, 3, 4) MN for monetary values.

Definition of abbreviations: Event configurable 1(2,3,4) date/decimal/character/monetary

For example, employees take 100 percent or 80 percent pay for sick time. If they take 100 percent, they lose a day of vacation for each set of five sick days that they take. You enter *100* or *80* in one of the decimal fields to specify the employee's choice and use a formula that counts the number of vacation days that the employee loses in each case.

Note: Values entered in the user defined fields can be overwritten during the Take process, depending on your take rules.

Note: The user-defined fields on this page are not related to the user-defined fields that appear on the Absence Take - Calculation page.

Override

If the absence take element is associated with a per-absence entitlement element, use this group box to override the standard entitlement amount or adjust the payee's entitlement balance. To override the entitlement amount or adjust the entitlement balance for a frequency-based entitlement, use the Absence Adjustment page.

Important! Use the same type of units as those that are used to define the entitlement element.

| <i>Field or Control</i> | <i>Description</i> |
|-------------------------|--|
| Entitlement | To override the entitlement for this event, enter the number of units in this field. If the take is linked to more than one entitlement element, the number overrides the entitlement for the first linked element only. |
| Adjustment | To adjust the entitlement balance, enter the number of units in this field. (That number populates the automatically assigned adjustment element.) Enter a negative number to reduce the entitlement balance. |

Related Links

[Defining Absence Take Elements](#)

[Absence Takes - User Defined Result Fields Page](#)

Forecasting Absence Entitlement Balance During Absence Entry

Pages Used to Forecast Absence Entitlement Balances

| <i>Page Name</i> | <i>Definition Name</i> | <i>Usage</i> |
|---|------------------------|---|
| Absence Forecast Results Page | GP_ABS_EVT_FCS_SEC | Review the results of the Forecasting process for a specific absence event and any take elements that are mapped to it. |
| Forecast Messages Page | GP_ABS_FCST_MSG | Review the messages that are generated during the Forecasting process. |

| <i>Page Name</i> | <i>Definition Name</i> | <i>Usage</i> |
|------------------------------|------------------------|---|
| Forecast Message Detail Page | GP_ABS_FCS_MSG_SEC | Review the text of a selected error or warning message. |

Understanding Absence Entitlement Balance Forecasting

Use the Absence Forecasting process to evaluate the impact of an absence event. To use this feature, you must have defined the forecasting rules that are applicable to your organization and enabled the absence forecasting feature.

Absence Forecasting Steps

Following are the steps for using absence forecasting:

1. Enter a payee’s actual or anticipated absence events on the Absence Event Entry page.
2. Click the **Forecast** button to start the process.

The system does not automatically save your absence request before initiating the Forecasting process. Although the system prompts you to save before leaving the page, it is not necessary to save your forecast information before or after the Forecasting process.

3. If applicable, check the Forecast Messages page to see if errors or warnings were generated during the process.
4. Correct errors and rerun the process.

Each time you run the Forecasting process, the system overwrites the previous forecast data.

5. View the results by clicking the **Forecast Details** link on the Absence Event Entry page.

Forecasting and Retroactivity

In absence forecasting the forecasting period includes those calendars that should be reprocessed due to the presence of an unprocessed retro trigger. The absence event change must create a retro trigger in order for the forecasting period to include a finalized calendar whose period includes the effective date of the trigger.

Example of Absence Forecasting with Retro

An employee has an absence entitlement balance of 16 hours once the September run is finalized. During October’s run the employee is absent for 24 hours, October 17 – October 19. Because there is not enough entitlement to cover this absence, a portion of the absence will go unpaid. The rules as defined for this absence mark this event as Ineligible.

If the end date is changed to October 18, there is enough entitlement and the event is marked as Eligible. The change to the event creates a retro trigger and therefore the October calendar is processed again during forecasting.

Note: The absence event change must create a retro trigger in order for the forecasting period to include a finalized calendar whose period includes the effective date of the trigger. In addition, the earliest retro trigger (not limited to retro triggers from the absence event) that satisfies the retro limit is selected to determine which template calendar is the starting point for retro processing. The calendar period end date must be greater than or equal to the minimum effective date of the retro triggers that are greater than or equal to the retro limit date.

Related Links

[Absence Entry, Approval, and Self Service Features](#)

Absence Forecast Results Page

Use the Absence Forecast Results page (GP_ABS_EVT_FCS_SEC) to review the results of the Forecasting process for a specific absence event and any take elements that are mapped to it.

Navigation:

Global Payroll & Absence Mgmt > Payee Data > Maintain Absences > Absence Event > Absence Event Entry

Click the **Forecast Details** link on the Forecast Value tab on the Absence Event Entry page.

This example illustrates the fields and controls on the Absence Forecast Results page.

[Absence Forecast Results](#)

[Absence Event](#)

Absence Forecast Results

Absence Take Element K0WAT SICK TAKE **Begin Date** 05/05/2012
Absence Type Sickness **End Date** 05/08/2012
Forecast Value ELIGIBLE **Forecast Date Time** 08/21/2012 3:44PM

Absence Forecast Result Details Personalize | Find | View All | [?] [] First 1-6 of 6 Last

| Forecast Results | Accumulator Results | User Keys 1-3 | User Keys 4-6 | | |
|-------------------|---------------------|---------------|---------------|-----------------|------------|
| Secondary Element | Forecast Element | Type | Numeric Value | Character Value | Date Value |
| K0WAT SICK TAKE | K0WAE SICK_ENT | Accumulatr | 40.000000 | | |
| K0WAT SICK TAKE | K0WAE SICK_TAKE | Accumulatr | 16.000000 | | |
| K0WAT SICK TAKE | K0WAE SICK_BAL | Accumulatr | 24.000000 | | |
| K0WAT SICK TAKE | K0WAE VAC_TAKE | Accumulatr | 0.000000 | | |
| K0WAT SICK TAKE | K0WAE VAC_BAL | Accumulatr | 607.999984 | | |
| K0WAT SICK TAKE | K0WFM GEN FCST | Formula | 0.000000 | ELIGIBLE | |

[Return](#)

Forecast Results

This tab displays the forecasted value for each element that appears on the Absence Take - Forecasting page, along with related take elements.

| Field or Control | Description |
|-------------------------------|--|
| Secondary Element | <p>Displays the name of the take element that the results pertain to. This can be the take element listed on the Absence Take - Forecasting page, a redirected take element, or a “mapped to” take element that’s associated with that take.</p> <hr/> <p>Note: You identify redirected take elements on the Take - Negative Balance page and “mapped to” elements on the Absence Take - Day Formula page. Redirected take element can be redirected to other take elements. For example, if A redirects to B, which redirects to C, then C can appear in this field.</p> |
| Forecast Element, Type | <p>Displays the name of the element for which a value has been forecast, followed by its type.</p> <p>A value displays for each element listed on the Take - Balance Inquiry page.</p> |

Reviewing Accumulator Results

Select the Accumulator Results tab.

This example illustrates the fields and controls on the Absence Forecast Results page: Accumulator Results tab.

Absence Forecast Results

Absence Event

Absence Forecast Results

Absence Take Element K0WAT SICK TAKE **Begin Date** 05/05/2012
Absence Type Sickness **End Date** 05/08/2012
Forecast Value ELIGIBLE **Forecast Date Time** 08/21/2012 3:44PM

Absence Forecast Result Details Personalize | Find | View All | | | First 1-6 of 6 Last

Forecast Results | **Accumulator Results** | User Keys 1-3 | User Keys 4-6

| Secondary Element | Forecast Element | From | Through |
|-------------------|------------------|------------|------------|
| K0WAT SICK TAKE | K0WAE SICK_ENT | 01/01/2012 | 12/31/2012 |
| K0WAT SICK TAKE | K0WAE SICK_TAKE | 01/01/2012 | 12/31/2012 |
| K0WAT SICK TAKE | K0WAE SICK_BAL | 01/01/2012 | 12/31/2012 |
| K0WAT SICK TAKE | K0WAE VAC_TAKE | 01/01/2012 | 12/31/2012 |
| K0WAT SICK TAKE | K0WAE VAC_BAL | 01/01/2012 | 12/31/2012 |
| K0WAT SICK TAKE | K0WFM GEN FCST | | |

[Return](#)

The begin and end dates of the accumulation period are displayed for any accumulators that are included in the Forecasting Results Element List on the Absence Take - Forecasting page.

Reviewing User Keys

Select the User Keys tab.

This example illustrates the fields and controls on the Absence Forecast Results page: User Keys tab.

Absence Forecast Results

Absence Event

Absence Forecast Results

Absence Take Element KOWAT SICK TAKE **Begin Date** 05/05/2012
Absence Type Sickness **End Date** 05/08/2012
Forecast Value ELIGIBLE **Forecast Date Time** 08/21/2012 3:44PM

Absence Forecast Result Details Personalize | Find | View All | | First 1-6 of 6 Last

Forecast Results | Accumulator Results | **User Keys 1-3** | User Keys 4-6 |

| Secondary Element | Forecast Element | User Key 1 | User Key 2 | User Key 3 |
|-------------------|------------------|------------|------------|------------|
| KOWAT SICK TAKE | K0WAE SICK_ENT | GBI | K0WPE ABS1 | K0WPG PNA1 |
| KOWAT SICK TAKE | K0WAE SICK_TAKE | GBI | K0WPE ABS1 | K0WPG PNA1 |
| KOWAT SICK TAKE | K0WAE SICK_BAL | GBI | K0WPE ABS1 | K0WPG PNA1 |
| KOWAT SICK TAKE | K0WAE VAC_TAKE | GBI | K0WPE ABS1 | K0WPG PNA1 |
| KOWAT SICK TAKE | K0WAE VAC_BAL | GBI | K0WPE ABS1 | K0WPG PNA1 |
| KOWAT SICK TAKE | K0WFM GEN FCST | | | |

[Return](#)

The values of the accumulator's user keys are displayed for any accumulators that are included in the Forecasting Results Element List on the Absence Take - Forecasting page.

Forecast Messages Page

Use the Forecast Messages page (GP_ABS_FCST_MSG) to review the messages that are generated during the Forecasting process.

Navigation:

Global Payroll & Absence Mgmt > Payee Data > Maintain Absences > Absence Event > Forecast Messages

This example illustrates the fields and controls on the Forecast Messages page.

[Absence Event Entry](#) | **Forecast Messages**

Employee ID K0W002 **Empl Record** 0 **Name** Danilo Travantti

Forecast Messages Personalize | Find | View 100 | | First 1-2 of 121 Last

| Calculation Status | Message Text | Message Set Number | Number | |
|------------------------|---|--------------------|--------|-------------------------|
| Calculation Successful | No data found for EmplID: K0W002 Empl. Rcd: 001 in the CONTRACT_DATA / WKF_CNT_TYPE table As Of: 2008-08-31 | 17005 | 956 | Details |
| Calculation Successful | No data found for EmplID: K0W002 Empl. Rcd: 001 in the CONTRACT_DATA / WKF_CNT_TYPE table As Of: 2006-04-30 | 17005 | 956 | Details |

| Field or Control | Description |
|---------------------------|---|
| Calculation Status | Identifies the phase of processing during which the error or warning occurred. |
| Message Text | Displays the abbreviated text of the message and other information about the message. |

Related Links

[Status Codes and Process Indicators](#)

[Reviewing System Generated Forecasting Error Status Messages](#)

Viewing Current Absence Entitlement Balances and Running the Absence Entitlement Balance Inquiry Process

Use the Balance Inquiry feature to view a payee’s current entitlement balance for a take. You can also run the Balance Inquiry process to return the values of the elements that are specified on the Absence Take - Balance Inquiry page. Typically, one of these elements returns the absence balance for the take. Values are displayed as of the date that you specify.

Video: [Image Highlights, PeopleSoft HCM Update Image 43: Absence Balance and Forecast Enhancements](#)

Pages Used to Start the Balance Inquiry Process and View Balances

| Page Name | Definition Name | Usage |
|---------------------------------------|------------------------|--|
| Current Balance Page | GP_ABS_CUR_BAL | View a payee’s current entitlement balances. |
| Forecast Balance Page | GP_ABS_FCST_BAL | Starts the Balance Inquiry process and view the results. |

Related Links

[Status Codes and Process Indicators](#)

Current Balance Page

Use the Current Balance page (GP_ABS_CUR_BAL) to view a payee’s current entitlement balances.

Navigation:

Global Payroll & Absence Mgmt > Payee Data > Maintain Absences > Review Absence Balances > Current Balance

This example illustrates the fields and controls on the Current Balance page - Accumulator Balance tab.

| Current Balance | | | | | |
|-------------------------------------|---------------------|------------------|---|---------------------------|------------|
| Employee ID K0G001 | | Empl Record 0 | | Name Rebekah Jones | |
| Absence Entitlement Current Balance | | | Personalize Find View All [Print] [Refresh] First 1-10 of 20 Last | | |
| Accumulator Balance | | | | | |
| User Keys [Filter] | | | | | |
| Accumulator Period | Entitlement Element | Element Name | Amount | From | Through |
| Year to Date | K0AE PTO | K0AE PTO_BAL | 70.000000 | 01/01/2012 | 12/31/2012 |
| Year to Date | K0AE FHOL | K0AE FHOL_BAL | 112.000000 | 01/01/2012 | 12/31/2012 |
| Year to Date | K0WAE SICK | K0WAE SICK_BAL | 8.000000 | 01/01/2012 | 12/31/2012 |
| Year to Date | K0WAE VAC | K0WAE VAC_BAL | -22.000000 | 01/01/2012 | 12/31/2012 |
| Year to Date | K0WLD SCK | K0WLD SCK_BAL | 0.000000 | 01/01/2012 | 12/31/2012 |
| Year to Date | K0WLD VAC | K0WLD VAC_BAL | 0.000000 | 01/01/2012 | 12/31/2012 |
| Year to Date | K0WLD SCKDON | K0WLD SCKDON_BAL | 0.000000 | 01/01/2012 | 12/31/2012 |
| Year to Date | K0WLD SCKRCV | K0WLD SCKRCV_BAL | 0.000000 | 01/01/2012 | 12/31/2012 |
| Year to Date | K0WLD SCKRET | K0WLD SCKRET_BAL | 0.000000 | 01/01/2012 | 12/31/2012 |
| Year to Date | K0WLD VACDON | K0WLD VACDON_BAL | 0.000000 | 01/01/2012 | 12/31/2012 |

Accumulator Balance Tab

For the period of time defined by the **From** and **Through** dates this tab displays the payee’s entitlement balances as of the most recent run of the Entitlement process for the payee.

User Keys Tab

This tab displays the value that was entered for each user key defined on the Entitlement Accumulators page.

Related Links

[Absence Entitlements - Auto Generated Accumulators Page](#)

Forecast Balance Page

Use the Forecast Balance page (GP_ABS_FCST_BAL) to starts the Balance Inquiry process and view the results.

Navigation:

Global Payroll & Absence Mgmt > Payee Data > Maintain Absences > Review Absence Balances > Forecast Balance

This example illustrates the fields and controls on the Forecast Balance page: Forecast Results tab.

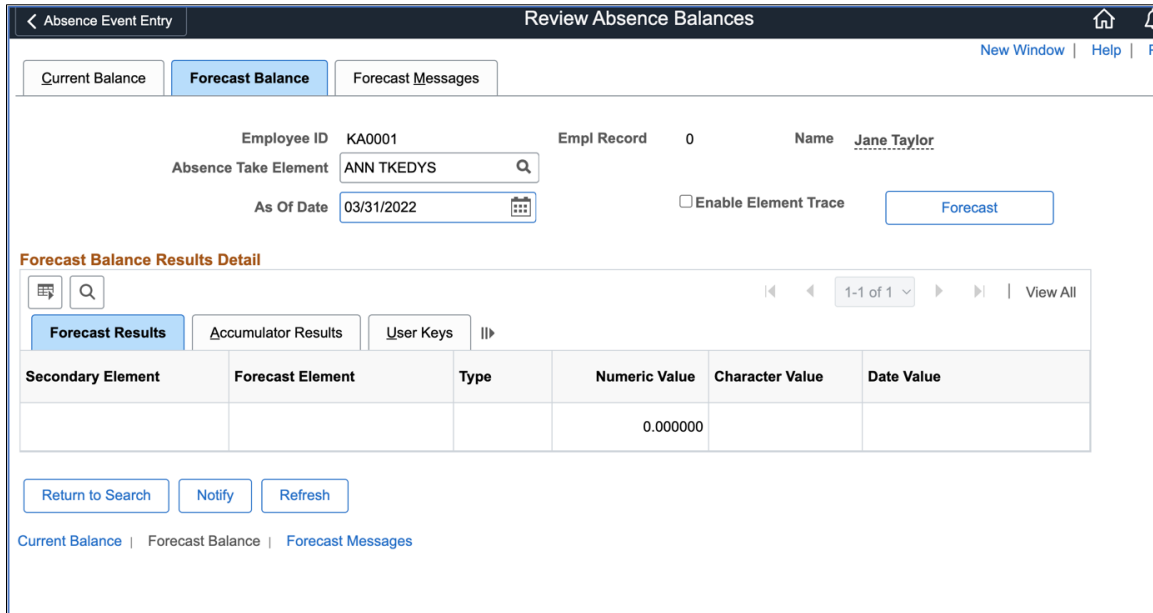

Following are the steps for running the Balance Inquiry process:

1. Select the take element and the **As of Date** for which you want to display forecasted results.
2. Select the **Enable Element Trace** checkbox to generate the element resolution chain for forecasting. The resolution chain helps you to debug forecasting inaccuracies by looking at how they are calculated and resolved.
3. Click the **Forecast** button.
4. View the results in the Forecast Balance Results Detail group box.

The tabs in this group box are identical to the tabs on the Absence Forecast Results page.

See [Absence Forecast Results Page](#).

Adjusting and Overriding Entitlement Balances

You can adjust or override a payee's entitlement balance in several ways.

Pages Used to Adjust Entitlements

| <i>Page Name</i> | <i>Definition Name</i> | <i>Usage</i> |
|---|------------------------|---|
| Adjust Balances - Absences Page | GP_PI_MNL_AE | Adjust a payee's frequency-based entitlement for a single calendar period. Before you can enter an adjustment, you must set up the corresponding absence calendar. |

| Page Name | Definition Name | Usage |
|---|------------------------|---|
| <u>Adjust Balance Comments Modal</u> | GP_ADJ_COMABS_SCF | Enter the comments for the balance adjustments. You can manage multiple comments according to the need. |
| <u>Assign Entitlements and Takes Page</u> | GP_ABS_OVRD | Redefine a frequency-based entitlement rule for a payee for a specified period of time. Specify whether a take or frequency-based entitlement element is processed for a payee. |
| <u>Assign Entitlements and Takes Comments Modal</u> | GP_ADJ_COMAET_SCF | Enter the comments for the element override list. You can manage multiple comments according to the need. |

Adjust Balances - Absences Page

Use the Adjust Balances - Absences page (GP_PI_MNL_AE) to adjust a payee's frequency-based entitlement for a single calendar period.

Before you can enter an adjustment, you must set up the corresponding absence calendar.

Navigation:

Global Payroll & Absence Mgmt > Payee Data > Adjust Balances > Absences > Adjust Absence Balances

This example illustrates the fields and controls on the Adjust Balances - Absences page.

The screenshot shows the 'Absences' page with the following details:

- Employee ID: 00012
- Name: Malay Sia
- Empl Record: 0
- Pay Group: GMSMTX
- Description: Salaried/Semi-Monthly for GM1
- Pay Entity: GM1
- Calendar ID: GMSMA GMSM15S01
- Begin Date: 01/01/2015
- End Date: 01/15/2015

Below the details is a section for 'Balance Adjustments' with a table:

| *Element Name | Description | Balance Adjustment | Begin Date | End Date | Comments | | |
|----------------------|----------------------|----------------------|----------------------|----------------------|----------------------|----------------------|----------------------|
| <input type="text"/> | <input type="text"/> | <input type="text"/> | <input type="text"/> | <input type="text"/> | <input type="text"/> | <input type="text"/> | <input type="text"/> |

The Absence Entitlement process follows the instructions you enter on this page.

Note: You can also enter one time adjustments to a per-absence entitlement when entering an absence event.

Note: You cannot adjust or delete entitlement elements inserted through the Leave Donations process on this page. Use the Adjust Leave Program Balances page to adjust leave donation balances.

Balance Adjustments

Enter each adjustment that applies to this payee for the selected absence calendar. You cannot enter more than one adjustment for the same element.

| <i>Field or Control</i> | <i>Description</i> |
|---|--|
| Element Name | Select the entitlement element for which you want to enter an adjustment. The prompt table displays only frequency-based entitlement elements that are defined for positive input overrides on the Element Name page. |
| Balance Adjustment | Enter the adjustment units. You can enter a positive or negative number. The amount is added to or subtracted from the beginning entitlement balance when you run the Entitlement process. Generation control for the adjustment is ignored. |
| Begin Date and End Date | <p>These dates determine in which segment the adjustment is made, if the calendar period is segmented.</p> <ul style="list-style-type: none"> • If you leave the Begin Date field blank, the system assumes that the date is the same as the Begin Date on the Calendar - Definition page. The system does not use the begin date for processing. • If the End Date differs from the Calendar End Date, and the calendar period is segmented, the end date determines the segment or slice to which the adjustment is assigned. |
|  | Select to open the Adjust Balance Comments Modal . |

See [Absence Event Entry Page](#).

Related Links

[Adjust Leave Program Balances Page](#)

Adjust Balance Comments Modal

Use the Adjust Balance Comments Modal (GP_ADJ_COMABS_SCF) to enter the comments for the balance adjustments. You can manage multiple comments according to the need.

The following video provides more information on comments added to Balance Adjustments:

Video: [Image Highlights, PeopleSoft HCM Update Image 36: Comments to Balance Adjustments](#).

This example illustrates the fields and controls on the Adjust Balance Comments Modal.

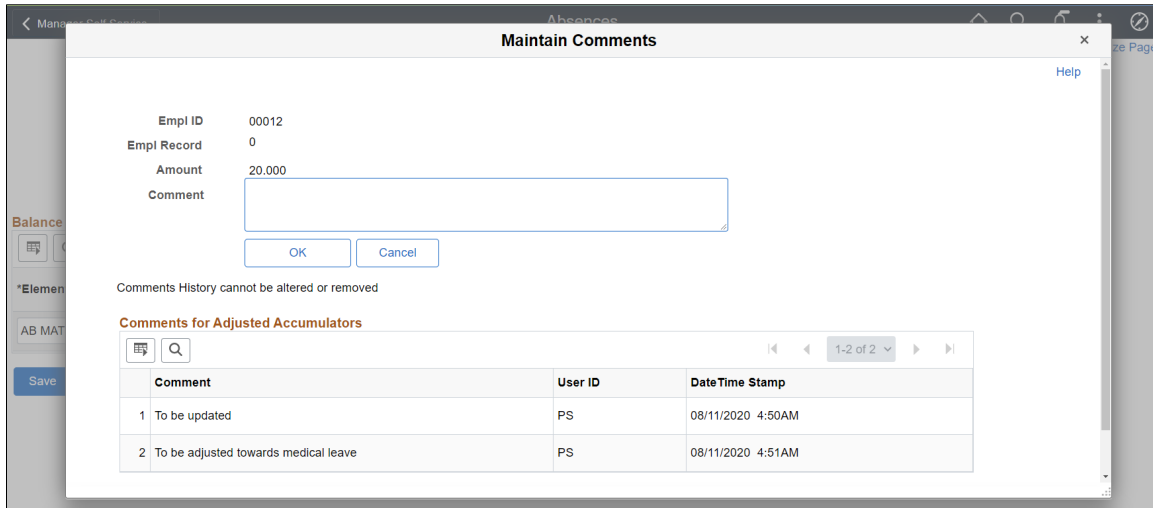

Note: You can edit comments until you save the Adjust Balances - Absences page. The comments gets saved only after saving the Adjust Balances - Absences page.

After entering comments and saving the page, the comments icon denotes that there is an existing comment.

This example illustrates the fields and controls on the Comments Modal with inputs.

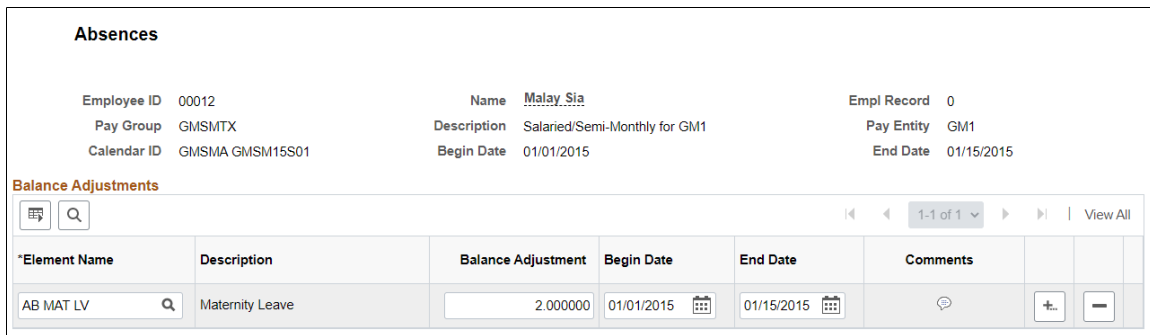

| Field or Control | Description |
|---|---|
|  | This icon denotes that there exist a saved comment for the particular balance adjustment. |

Assign Entitlements and Takes Page

Use the Assign Entitlements and Takes page (GP_ABS_OVRD) to redefine a frequency-based entitlement rule for a payee for a specified period of time.

Specify whether a take or frequency-based entitlement element is processed for a payee.

Navigation:

Global Payroll & Absence Mgmt > Payee Data > Maintain Absences > Assign Entitlements and Takes > Assign Entitlements and Takes

This example illustrates the fields and controls on the Assign Entitlements and Takes page.

To override a per-absence entitlement rule, use the Absence Event Entry page.

Note: To override an entitlement or take element, the Payee override option must be selected on the Element Name (GP_PIN) page.

Elements

| Field or Control | Description |
|---|---|
| Element Type | Specify the type of element to override: <i>Absence Entitlement</i> or <i>Absence Take</i> . |
| Element Name | Select the name of the element to override. Only elements that allow payee overrides are listed; the system does not check payee eligibility. If you selected <i>Absence Entitlement</i> as the entry type, you can select a frequency-based entitlement element only. |
| Active | Selected by default. Clear if you don't want the system to resolve this absence element for the payee. |
| Begin Date and End Date | Enter the date that the override instructions become effective and the last date to which the override instructions apply. |
|  | Select to open Assign Entitlements and Takes Comments Modal |

Unit Element

| <i>Field or Control</i> | <i>Description</i> |
|-----------------------------------|--|
| Unit Element Type | <p>To change the supporting element that is used to calculate the entitlement units, select <i>Accumulator</i>, <i>Bracket</i>, <i>Formula</i>, <i>Numeric</i>, <i>Payee Level</i>, <i>System Element</i>, or <i>Variable</i>.</p> <p>If you select <i>Numeric</i>, enter the value in the Entitlement Unit field.</p> <p>For all other element types, select the element name in the <i>Element Name - Unit</i> field.</p> |
| Frequency and Frequency ID | <p>Specify the frequency for the system to apply when granting the entitlement. Values are <i>Pay Period</i> and <i>Other</i>.</p> <p>If you select <i>Other</i>, select the frequency in the Frequency ID field; for example, <i>Monthly</i>.</p> |

Generation Control

| <i>Field or Control</i> | <i>Description</i> |
|----------------------------------|---|
| Generation Control Option | <p>You can override the generation control condition that is defined for the take or entitlement element on the Element Name page. You can enter instructions here even if you didn't specify generation control details at the element level. Values are:</p> <p><i>None</i>: System ignores the generation controls that you originally defined at the calculation rule level.</p> <p><i>Specify</i>: Enter a generation control value in the field to the right.</p> <p><i>Element</i> (the default): System uses the generation control that was defined when the element was set up.</p> |

Assign Entitlements and Takes Comments Modal

Use the Assign Entitlements and Takes Comments Modal (GP_ADJ_COMAET_SCF) to enter the comments for the element override list. You can manage multiple comments according to the need.

This example illustrates the fields and controls on the Assign Entitlements and Takes Comments Modal.

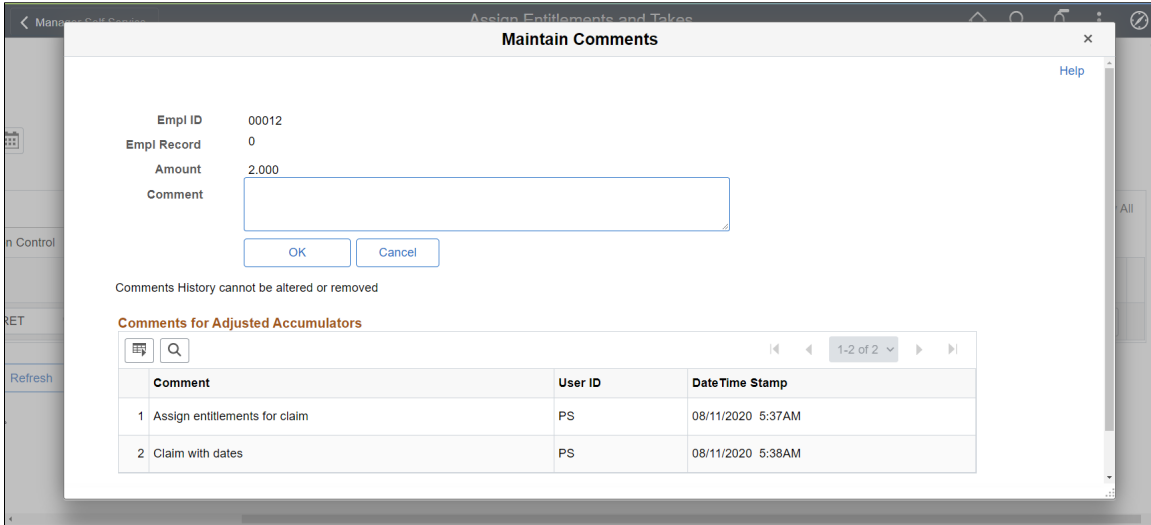

Reviewing Daily Absence Records

The following table lists the pages that display the results of a batch absence process:

| Process | Tables Populated | Inquiry Pages and Display |
|----------------|----------------------------------|---|
| Take | GP_RSLT_ABS (Daily absence rows) | Absence Data pages. Daily data that is generated by the Take process. |
| | GP_RSLT_ACUM | Accumulators page. Updated entitlement balances. |
| | GP_RSLT_PI_DATA | Results by Calendar: Positive Input - Absence page. Balances adjustments made to frequency based entitlement elements that are processed for the absence calendar. |
| | GP_RSLT_ABS | Results by Calendar - Calendar Results: Absence Data. Also Results by Calendar Group - Calendar Results: Absence Data. The absence type, reason, and forecast value. |
| | GP_GEN_PI_DATA | Generated positive input from the take process is stored in this table. (Note: This is the principal table that Absence Management uses to provide information to the payroll system.) |

| <i>Process</i> | <i>Tables Populated</i> | <i>Inquiry Pages and Display</i> |
|-----------------------|--------------------------------|---|
| Entitlement | GP_RSLT_ACUM | Accumulators page. Updated entitlement balances. |
| | GP_RSLT_PIN | Supporting Elements page. Entitlement units with supporting elements. |

Related Links

[Viewing Positive Input Results](#)

[Viewing Daily Results of the Absence Take Process](#)

Managing Extended Absences

Understanding Extended Absences

This topic provides an overview of:

- Attachments in extended absences
- Configurable sections in extended absences

The Absence Management self service framework supports extended leave requests, such as FMLA (Family Medical Leave Act) and Canadian Leave requests, as well as other extended absences such as Statutory Sick Pay and Statutory Maternity Pay, and so on. The framework for extended absences contains elements that enable you to attach supporting documents and notes to extended absence requests. In addition, the framework provides a mechanism to enable you to implement eligibility validation rules at different levels, for example country, state, customer, and so on, without having to customize PeopleSoft components.

Understanding Attachments in Extended Absences

The attachment feature enables you to attach files to a PeopleSoft application. An administrator can add URLs or common files to a component or page. Attachments include PDF files, spreadsheet files, document files, URLs, and so on. You can also define the types of attachments that users can add to a specific row of application data, such as medical or adoption certificates, fitness for duty forms, and so on.

Although the types of attachments you can add to a page are essentially unlimited, attachments are categorized as one of the following:

- Attachments are any previously created electronic file that the administrator wants users to be able to download.
- URLs are links to dynamic files or web sites.
- Notes are free-form text that the user can enter through the attachment framework page in the PeopleSoft application.

Note: Only attachments and URLs are defined on the Define Attachments page. Notes are created by the user through the attachment pages of the PeopleSoft application.

Note: The Define Attachments page enables an administrator to create document definitions, as well as attachments and URLs. Document definitions are types of files that users can upload to the system. For example various medical certificates or evidence of class completion.

Adding Attachments to Extended Absences Process Flow

Here are the steps for defining attachments within the attachment framework for PeopleSoft Absence Management:

- Define Authorization ID

These IDs provide users with security authorizations for accessing attachments, such as the ability to create, update and delete attachments.

- Define Authorization Entry ID

The Authorization Entry IDs enable you to attach Authorization IDs to planned attachments, notes, or URLs.

Note: The description you enter in for an Authorization Entry ID defines the name of the link as it appears to users on the Extended Absence Request page.

- Define Configuration ID

The Configuration ID links Authorization Entry IDs and defines whether an attachment is a downloadable file, a document the user uploads, or a link to a URL.

- Define Object Owner ID

Object Owner IDs define where links appear on the Extended Absence component. For extended absences, use the *HGA* Object Owner ID for Absence Management, and associate your Configuration ID's with the *Absence Element* Context Key.

This graphic shows the process flow for adding attachments to extended absences.

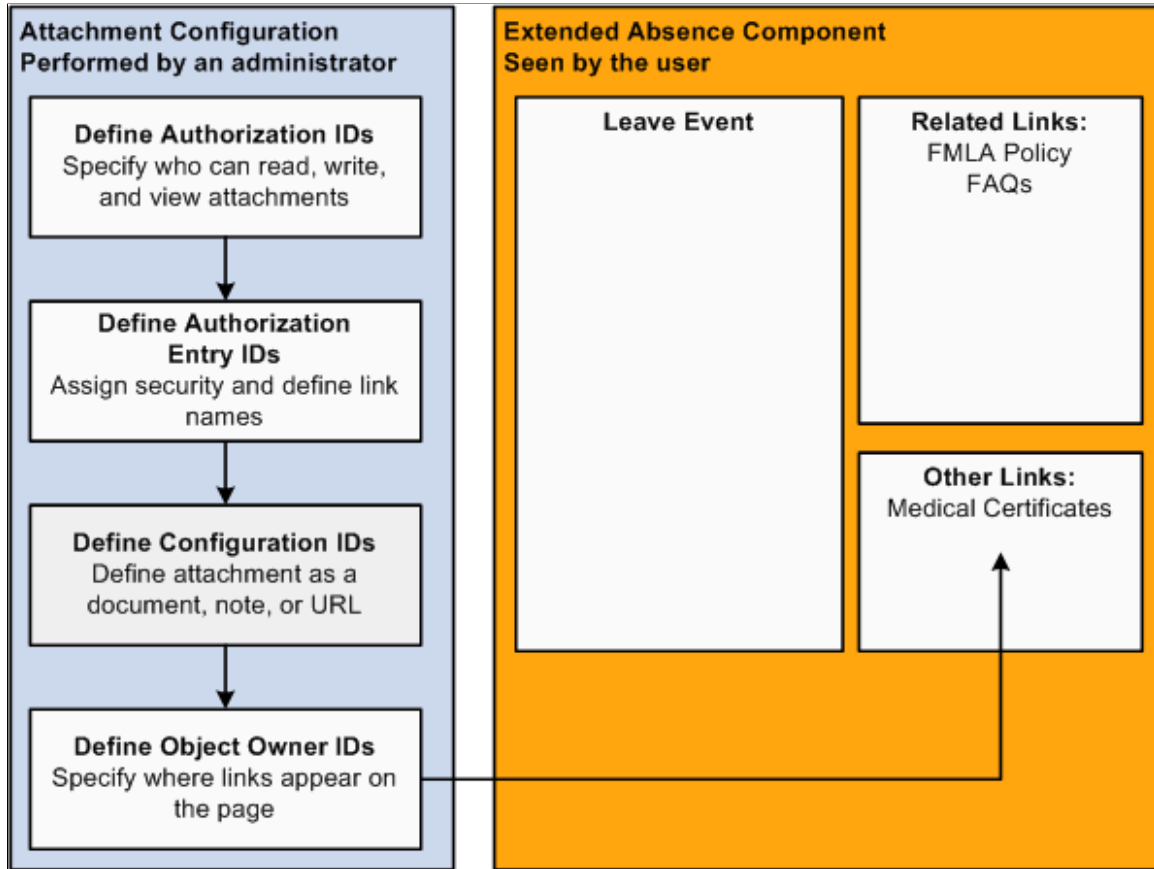

Example: Defining Authorization IDs

Use the Authorization ID to provide a variety of security authorizations to users regarding the ability to read, write, or view attachments.

For example, the authorization ID *KOW_EDITALL* has the **Edit Attachments**, **Edit Notes**, and **Edit URLs** check boxes selected. This means that roles with the *KOW_EDITALL* authorization ID can edit all attachments, notes, and URLs.

The following graphic displays the Define Authorization page (**Set Up HCM > Common Definitions > Attachments > Define Authorization > Define Authorization**) with the *KOW_EDITALL* Authorization ID.

This example illustrates the fields and controls on the Define Authorization page - displaying the KOW_EDITALL Authorization ID.

Define Authorization

Authorization ID KOW_EDITALL

Authorization Details

*Description

Short Description

Comments

Authorization Options

| | | |
|--|--|-----------------------|
| <input checked="" type="checkbox"/> Edit Attachments | <input checked="" type="checkbox"/> View Attachments | Delete Options |
| <input checked="" type="checkbox"/> Edit Notes | <input checked="" type="checkbox"/> View Notes | |
| <input checked="" type="checkbox"/> Edit URLs | <input checked="" type="checkbox"/> View URLs | |

Mark as deleted

Delete from database

See “Define Authorization Page” (Application Fundamentals).

Example: Defining Authorization Entry IDs

Use the Authorization Entry IDs to attach Authorization IDs to each of the planned types of attachments, notes, and URLs.

For example, in the following graphic, the *KOW_MEDCERT* Entry ID on the Define Authorization Entries page (**Set Up HCM > Common Definitions > Attachments > Define Authorization Entries > Define Authorization Entries**) is associated with two or more roles in the *Medical Certificate* Authorization Entry ID. This allows the manager to view attachments or notes, and the AM EA Administrator and the employee can add, edit, or delete attachments or notes related to the medical certificate.

This example illustrates the fields and controls on the Define Authorization Entries page - displaying the K0W_MEDCERT Entry ID associated with two or more roles.

Define Authorization Entries
Entry ID K0W_MEDCERT

Entry Definitions Find | View All First 1 of 1 Last

*Effective Date 01/01/1990
 *Description Medical Certificate
 Short Description Med Cert
 Comments Medical Certificate will be posted

Entry Control
 Attachments Notes URLs

Define Authorization Personalize | Find | View All First 1-3 of 3 Last

| | *Role Name | Description | *Authorization ID | Description |
|---|---------------------|---------------------|-------------------|--------------|
| 1 | AM EA Administrator | AM EA Administrator | K0W_EDITALL | K0W_EDITALL |
| 2 | Employee | [WF] Employee | K0W_EDITALL | K0W_EDITALL |
| 3 | Manager | Manager | K0W_VIEWNOTE | K0W_VIEWNOTE |

See “Define Authorization Entries Page” (Application Fundamentals).

Example: Defining Configuration IDs

The Configuration ID defines whether an attachment is a downloadable file, a document the user uploads, or a link to a URL.

For example, in the following example of the, Define Attachments page (**Set Up HCM > Common Definitions > Attachments > Define Attachments > Define Attachments**), the *K0W_CERT_LNK* Configuration ID describes the Medical Certificate attachment. This attachment uses the Document Definition attachment type, which enables the user to upload word processing documents, PDF files, spreadsheets, and so on.

This example illustrates the fields and controls on the Define Attachments page - displaying the Document Definition attachment type for the selected attachment.

Define Attachments
Configuration ID K0W_CERT_LNK

Attachment Configuration Details Find | View All First 1 of 1 Last

*Effective Date 01/01/1990 *Effective Status Active
 *Description Certificates Short Description Certificat
 Comments Adoption and Birth certificates will be posted here
 *Attachment Type Document Definition

Document Definitions Personalize | Find | View All First 1-2 of 2 Last

| | *Entry ID | Description |
|---|---------------|-------------------|
| 1 | K0W_ADOPTCERT | Adopt Certificate |
| 2 | K0W_BIRTH | Birth Certificate |

Last Upd User SAMPLE Updated on 04/10/09 5:21:36AM

Note: The contents of the **Description** field define the title of the link that appears in the Extended Absence component.

See “Define Attachments Page” (Application Fundamentals).

Example: Defining Object Owner IDs

The Maintain Definitions page (**Set Up HCM > Common Definitions > Attachments > Maintain Definitions > Maintain Definitions**) defines where the links to attachments appear in the Extended Absence component. In the following graphic, the Attachments region of the page indicates that the *KOW_MEDCERT_LNK* Configuration ID is set up to appear in the Other Links region of the Extended Absence component.

This example illustrates the fields and controls on the Maintain Definitions page - displaying the location of the attachment link in the Extended Absence component.

The screenshot shows the 'Maintain Definitions' interface. At the top, it displays 'Object Owner ID HGA' and 'Sub Id AMEA'. Below this are three main sections:

- Definition:** Includes fields for '*Effective Date' (01/01/1990) and '*Status' (Active).
- Context:** Includes a '*Sequence Number' field set to 1.
- Context Keys:** A table with columns: Key Field, Key Value, Key Date, Key Number, and All values.

| Key Field | Key Value | Key Date | Key Number | All values |
|-------------------|-----------|----------|------------|-------------------------------------|
| 1 Country | CYM | | | <input type="checkbox"/> |
| 2 Absence Element | | | | <input checked="" type="checkbox"/> |
- Attachments:** A table with columns: *Configuration ID, *Sequence, and *Group Box.

| *Configuration ID | *Sequence | *Group Box |
|-------------------|-----------|---------------|
| 1 KOW_FAQ_LNK | 1 | Related Links |

See “Maintain Definitions Page” (Application Fundamentals).

Example: Reviewing Extended Absence History

The Extended Absence Request Details page (click the link in **Absence Name** field on the Extended Absence Request History page) shows the user details about an extended absence request. Any defined attachments appear in the **Related Links** or the **Other Documents** regions. The bottom of the **Extended Absence Request Details** region displays any links to configurable sections.

This example illustrates the fields and controls on the Extended Absence Request Details page (1 of 2).

[Extended Absence Request History](#)

Extended Absence Request Details

Danilo Travantti
Sales Manager

[View Request Status and Approval Details](#)

| Extended Absence Request Details | Related Links |
|---|--|
| <p>Request 504</p> <p>Request Date 12/30/2013</p> <p>Start Date 09/14/2014</p> <p>Expected Return Date 10/19/2014</p> <p>Actual Return Date</p> <p>Absence Name FMLA Medical</p> <p>Absence Reason</p> <p>Current Balance 0.00 **</p> <p>Status Submitted</p> <p>FMLA Eligibility</p> | <p>FAQ</p> <hr/> <p>Other Documents</p> <ul style="list-style-type: none"> Certificates (0) Medical Certificate (0) |

Absence Requests

[Absence Request](#) [Personalize](#) | [Find](#) | [View All](#) | [Print](#) | [Calendar](#)

First 1 of 1 Last

| Absence Requests | Status | Start Date | End Date | Duration | Source |
|------------------|--------|------------|----------|----------|--------|
| | | | | | |

This example illustrates the fields and controls on the Extended Absence Request Details page (2 of 2).

Request History [Personalize](#) | [Print](#)

| Status | Name | Date | Comments |
|-----------|------------------|------------|----------|
| Submitted | Danilo Travantti | 12/30/2013 | |

Extended Abs Process for FMLA

Absence Management: Pending

Extended Abs Process for FMLA

Pending

- [Multiple Approvers](#)
- [Extended Absence Administrator](#)

[Return to Extended Absence Request History](#)

See [Managing Extended Absences](#).

See the product documentation for *PeopleTools: PeopleCode Developer's Guide* and *PeopleTools: PeopleCode API Reference*.

Related Links

“Configuring and Working With Attachments” (Application Fundamentals)

Understanding Configurable Sections in Extended Absences

The configurable sections functionality in extended absences is a template-based process. The templates are created and configured by a template administrator. The template administrator determines the sections, or logical groupings of fields, that are included in the template and the sequence of sections and fields within sections. The administrator also sets default values for fields, determine which fields can be edited, and which fields are hidden or display-only.

A configurable section is a set of additional fields and controls that enables you to customize data tracking. You can create your own customized pages and link those pages to the core self service pages. You can create your own customized code using the Absence Management Event Handler technology. Configurable Sections enable you to associate user defined records to an extended absence.

For extended family leave absences, using effective dated rows enables you to track legislative rule changes for both federal and state agencies. In addition, you can keep track of medical certification progress. During an extended absence, your employee or the extended absence administrator may have to make multiple medical certification entries for the same day in order to track multiple medical conditions, or other necessary documentation pertaining to an extended leave request.

Note: The record should have the same key-structure as the main record GP_ABS_EA having EMPLID, EMPL_RCD and TRANSACTION_NBR as key.

Process Flow for Setting up Configurable Sections

Setting up configurable sections in extended absences consists of the following steps:

1. (Optional) Create rules using Global Payroll to store elements that involve extended absence eligibility.

For example, brackets store information for Federal and State rules, such as the number of weeks allowed for FMLA, or a rollover transaction method versus a fixed transaction method.

2. (Optional) Create an application class.

The application class must contain the necessary PeopleCode, SQL, and so on, to check for extended absence eligibility. For example, balance and availability is calculated using SQL.

3. Set up the record definition.

Record definitions identify the necessary records and fields.

4. Set up the section definition.

The identified records and fields are combined into a section.

5. Define the template.

The template combines each of the previously defined components into the configurable section seen by the user.

Important! The sample rules, the configurable sections setup, and the processing logic for the Validate Sections button (application class GP_ABS_FMLA) that PeopleSoft Absence Management delivers for extended absences should be used as a model only. Customers need to create new rules, configurable section data, and validation logic of their own to meet their individual business needs.

This graphic illustrates the process flow for setting up configurable sections in extended absences.

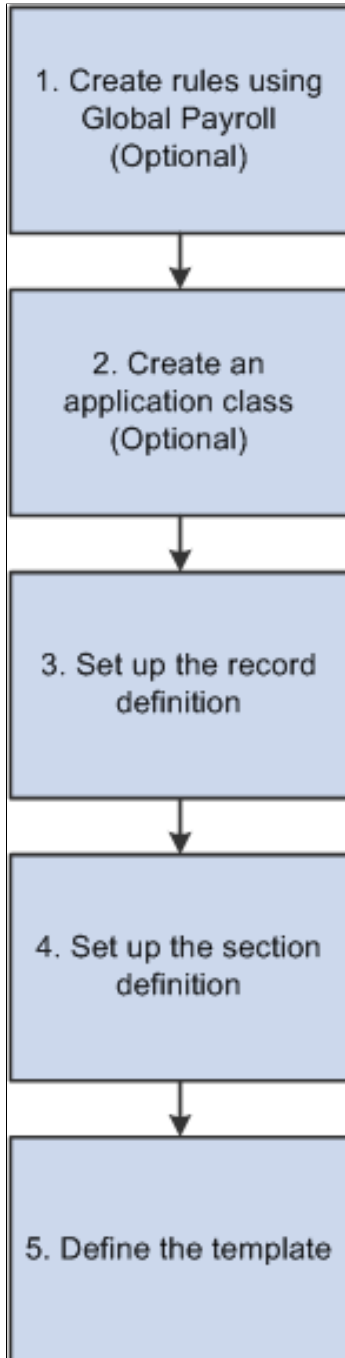

Example: Setting Up a Record Definition

The following examples guide you through the process of setting up a configurable section. The examples demonstrate the set up using the delivered FMLA eligibility configurable section.

The configurable section in this example is based on the GP_ABS_FMLA_ELG Setup Record Definition. The Setup Record Definition page enables you to specify the necessary record and fields in your configurable section.

This example illustrates the fields and controls on the Setup Record Definition page.

Setup Record Definition

Record

Record Name: GP_ABS_FMLA_ELG Description: FMLA Eligibility CS

Instance Find | View All First 1 of 1 Last

Record Instance: 1 *Status: Active +

*Record Alias: GP_ABS_FMLA_ELG

Field Personalize | Find | First 1-30 of 30 Last

| *Field Name | Field Label | Key Field | Required | |
|--------------------|--------------------------------|-------------------------------------|-------------------------------------|---|
| EFFDT | Effective Date | <input checked="" type="checkbox"/> | <input checked="" type="checkbox"/> | - |
| EFFSEQ | Effective Sequence | <input checked="" type="checkbox"/> | <input checked="" type="checkbox"/> | - |
| EMPLID | Empl ID | <input checked="" type="checkbox"/> | <input checked="" type="checkbox"/> | - |
| EMPL_RCD | Empl Record | <input checked="" type="checkbox"/> | <input checked="" type="checkbox"/> | - |
| TRANSACTION_NBR | Transaction Number | <input checked="" type="checkbox"/> | <input checked="" type="checkbox"/> | - |
| GP_ABS_FMLA_ELG | FMLA Eligible | <input type="checkbox"/> | <input checked="" type="checkbox"/> | - |
| GP_ABS_FMLA_ENTITL | Entitlement | <input type="checkbox"/> | <input checked="" type="checkbox"/> | - |
| GP_ABS_FMLA_FD_EES | Federal Minimum Employees Elig | <input type="checkbox"/> | <input checked="" type="checkbox"/> | - |
| GP_ABS_FMLA_FD_HRS | Federal Earned Hours Elig | <input type="checkbox"/> | <input checked="" type="checkbox"/> | - |
| GP_ABS_FMLA_FD_SVC | Federal Service Weeks Elig | <input type="checkbox"/> | <input checked="" type="checkbox"/> | - |
| GP_ABS_FMLA_HRS_FD | Earned Hours | <input type="checkbox"/> | <input checked="" type="checkbox"/> | - |
| GP_ABS_FMLA_HRS_ST | Earned Hours | <input type="checkbox"/> | <input checked="" type="checkbox"/> | - |
| GP_ABS_FMLA_LV_AVL | Leave Available | <input type="checkbox"/> | <input checked="" type="checkbox"/> | - |
| GP_ABS_FMLA_LV_RQT | Leave Requested | <input type="checkbox"/> | <input checked="" type="checkbox"/> | - |
| GP_ABS_FMLA_LV_TKN | Leave Taken | <input type="checkbox"/> | <input checked="" type="checkbox"/> | - |

Add Field
Add All Fields

Example: Setting Up Section Definitions

Records and fields are combined into the section using Setup Section Definition page.

Note: In order for the application class code to work, the value in the Method Name field must be *checkEligibility*

This example illustrates the fields and controls on the Setup Section Definition page.

Setup Section Definition

Country CYM Cayman Islands

Section Identification

Template Section ID GP_ABS_FMLA_MED

*Description

*Short Description

Comments

Section Configuration

Sequence Number

Effective Date Definition

Effective Date Enabled Edit Row Enabled

Add Row Enabled Copy Previous Row

Section Validation App Class

Application Class Path

App Class ID

Method Name

Section Fields Personalize | Find | | First 1-12 of 12 Last

| Seq Nbr | Record Alias | *Field | Field Label | Field Configuration |
|--------------------------------|--|--|--------------------------|--|
| <input type="text" value="1"/> | <input type="text" value="GP_ABS_MED_CERT"/> | <input type="text" value="GP_ABS_MDCRT_ODU"/> | Original Due Date | Field Configuration <input type="button" value="-"/> |
| <input type="text" value="2"/> | <input type="text" value="GP_ABS_MED_CERT"/> | <input type="text" value="GP_ABS_MDCRT_EDU"/> | Extended Due Date | Field Configuration <input type="button" value="-"/> |
| <input type="text" value="3"/> | <input type="text" value="GP_ABS_MED_CERT"/> | <input type="text" value="GP_ABS_MDCRT_IRCV"/> | Incomplete Received Date | Field Configuration <input type="button" value="-"/> |
| <input type="text" value="4"/> | <input type="text" value="GP_ABS_MED_CERT"/> | <input type="text" value="GP_ABS_MDCRT_CRC"/> | Complete Received Date | Field Configuration <input type="button" value="-"/> |

This example illustrates the fields and controls on the Setup Section Definition page.

| | | | | |
|---------------------------------|--|--|-------------------------|--|
| <input type="text" value="5"/> | <input type="text" value="GP_ABS_MED_CERT"/> | <input type="text" value="GP_ABS_MDCRT_CMP"/> | Certification Completed | Field Configuration <input type="button" value="-"/> |
| <input type="text" value="6"/> | <input type="text" value="GP_ABS_MED_CERT"/> | <input type="text" value="GP_ABS_MDCRT_CHR"/> | Chronic Condition | Field Configuration <input type="button" value="-"/> |
| <input type="text" value="7"/> | <input type="text" value="GP_ABS_MED_CERT"/> | <input type="text" value="GP_ABS_MDCRT_FRE"/> | Frequency | Field Configuration <input type="button" value="-"/> |
| <input type="text" value="8"/> | <input type="text" value="GP_ABS_MED_CERT"/> | <input type="text" value="GP_ABS_MDCRT_DUR"/> | Duration | Field Configuration <input type="button" value="-"/> |
| <input type="text" value="9"/> | <input type="text" value="GP_ABS_MED_CERT"/> | <input type="text" value="GP_ABS_MDCRT_MISC"/> | Miscellaneous | Field Configuration <input type="button" value="-"/> |
| <input type="text" value="10"/> | <input type="text" value="GP_ABS_MED_CERT"/> | <input type="text" value="GP_ABS_MDCRT_PHYS"/> | Physician Name | Field Configuration <input type="button" value="-"/> |
| <input type="text" value="11"/> | <input type="text" value="GP_ABS_MED_CERT"/> | <input type="text" value="GP_ABS_MDCRT_DTFM"/> | Certification Date From | Field Configuration <input type="button" value="-"/> |
| <input type="text" value="12"/> | <input type="text" value="GP_ABS_MED_CERT"/> | <input type="text" value="GP_ABS_MDCRT_DTTC"/> | Certification Date To | Field Configuration <input type="button" value="-"/> |

Example: Defining the Template

The template combines each of the previously defined components into the configurable section seen by the user.

This example illustrates the fields and controls on the Configurable Section Setup - Template page.

The Configurable Section Setup - Sections page enables you to combine the defined sections into an application page that users can access.

Warning! Clicking the **Load/Reload Sections** button after the section has already been loaded wipes out any existing section fields. You must then manually reenter the section field information.

This example illustrates the fields and controls on the Configurable Section Setup - Sections page.

| Select | Seq Nbr | Section Country | Template Section ID | Section Name | Section Configuration |
|--------------------------|---------|-----------------|---------------------|-----------------------------|-----------------------|
| <input type="checkbox"/> | 1 | CYM | GP_ABS_FMLA_ELG | FMLA Eligibility (Employee) | Section Configuration |
| <input type="checkbox"/> | 2 | CYM | GP_ABS_FMLA_MED | Medical Certification | Section Configuration |

The Template Section Configuration page enables you to specify the section label, the alignment of field labels, and the default value of each field in the configurable section.

This example illustrates the fields and controls on the Template Section Configuration page (partial page only).

Country CYM
Effective Date 01/01/1990

Template GP_ABS_FMLA_ELG
Description FMLA Eligibility

Section Country CYM
Section Name FMLA Eligibility (Employee)

Section ID GP_ABS_FMLA_ELG

Section Label Type

Use Section Description

Use Message Catalog

Use Text Catalog

Use Static Text

Hide Entire Section

Section Label

Message Set Number

Message Number

Sub ID

Text ID

Label

Section Fields Personalize | Find | First 1-17 of 17 Last

| Section Country | Seq Nbr | Field | *Alignment | Field Label | Default Value | Required | Override | Hide | Edit |
|-----------------|---------|--------------------|------------|---|---------------|-------------------------------------|-------------------------------------|--------------------------|------|
| CYM | 1 | GP_ABS_FMLA_SPOUSE | Left | Employee's Spouse works for the same company | N - No | <input checked="" type="checkbox"/> | <input checked="" type="checkbox"/> | <input type="checkbox"/> | Edit |
| CYM | 2 | GP_ABS_FMLA_SPS_ID | Auto | What is the Spouse's employee number? | | <input type="checkbox"/> | <input checked="" type="checkbox"/> | <input type="checkbox"/> | Edit |
| CYM | 3 | GP_ABS_FMLA_FD_ELG | Left | Federal Eligibility | | <input type="checkbox"/> | <input type="checkbox"/> | <input type="checkbox"/> | Edit |
| CYM | 4 | GP_ABS_FMLA_FD_SVC | Left | The employee has been employed for at least 12 months | N - No | <input checked="" type="checkbox"/> | <input type="checkbox"/> | <input type="checkbox"/> | Edit |
| CYM | 5 | GP_ABS_FMLA_SVC_FD | Right | Current Months | | <input type="checkbox"/> | <input type="checkbox"/> | <input type="checkbox"/> | Edit |
| CYM | 6 | GP_ABS_FMLA_FD_HRS | Left | The employee has worked for at least 1250 hours in the past | N - No | <input checked="" type="checkbox"/> | <input type="checkbox"/> | <input type="checkbox"/> | Edit |

Example: Viewing the Configurable Section

Access the Request Extended Absence page and locate the link to the configurable section, which is labeled as **FMLA Eligibility** in the following example.

This example illustrates the fields and controls on the Request Extended Absence page.

Request Extended Absence

Antonio Smith
Administrator

To create your request, complete the information in the Extended Absence Request Details section and select save for later or submit the request for approval. Additional information may be managed or viewed at a later time.

| Extended Absence Request Details ? | Related Links ? |
|--|--|
| <p>*Start Date <input type="text" value="07/01/2013"/> ?</p> <p>*Expected Return Date <input type="text" value="08/03/2013"/> ?</p> <p>Actual Return Date <input type="text"/> ?</p> <p>Absence Type <input type="text" value="Family and Medical Leave Act"/> ▼</p> <p>*Absence Name <input type="text" value="FMLA Medical"/> ▼</p> <p>Absence Reason <input type="text" value="FMLA Medical"/> ▼</p> <p>Current Balance 0.00 **</p> <p>FMLA Eligibility</p> | <p> FAQ</p> |

Absence Requests

| Absence Request ? | | | | | |
|---|--------|------------|----------|----------|--------|
| Personalize Find View All | | | | | |
| First ◀ 1 of 1 ▶ Last | | | | | |
| Absence Requests | Status | Start Date | End Date | Duration | Source |
| | | | | | |

Requestor Comments

The configurable section page displays the fields and information specified on the pages specified in the configurable section set up process flow.

This example illustrates the fields and controls on the Request Extended Absence FMLA Eligibility page (example of configurable section page).

The screenshot shows a web interface for 'Administer Extended Absence'. The main heading is 'FMLA Eligibility (FMLA Administrator)'. Below this, there is a sub-section 'Medical Certification'. A note states: 'The information in this section is to be completed by your FMLA Administrator and will not be shared with Management or any other party.' An 'Add' button is present. The form contains several fields: 'Date Change Will Take Effect' (05/25/2012), 'Sequence' (1), 'Status' (Active), 'Original Due Date' (05/25/2012), 'Extended Due Date' (05/25/2012), 'Incomplete Received Date' (05/25/2012), 'Complete Received Date' (05/25/2012), 'Certification Completed', 'Chronic Condition', 'Frequency' (dropdown), 'Duration', 'Miscellaneous', 'Physician Name', 'Certification Date From' (05/25/2012), and 'Certification Date To' (05/25/2012). At the bottom, there is a 'Comments' section with a text area and a 'Validate Sections' button. A link 'Return to Extended Absence Request' is also visible.

Related Links

[Requesting Extended Absences](#)

Setting Up Configurable Sections for Extended Absences

Pages Used to Set Up Configurable Sections

| Page Name | Definition Name | Usage |
|--|------------------------|---|
| Setup Record Definition Page | GP_ABS_RECDEFN | Identify the records and fields used in the extended absence template. |
| Setting Up Section Definition Page | GP_ABS_SECDEFN | Combine records and fields into sections for use in the extended absence template. Select the fields and the order in which fields appear in a section. |
| Template Section Field Configuration Page | GP_ABS_SECDTL | Define the display and edit options per field. |
| Configurable Section Setup - Template Page | GP_ABS_TEMPL_DEF | Enter template identification information. |
| Configurable Section Setup - Sections Page | GP_ABS_TEMPL_DEF | Combine sections into a page in the extended absence feature. |

| Page Name | Definition Name | Usage |
|--|------------------------|--|
| <u>Template Section Configuration Page</u> | GP_ABS_TMPL_FLDS | Define the section field properties. Specify whether certain fields are required, display-only or hidden. You can also enter default values. |
| <u>Section Field Default Value Page</u> | GP_ABS_TMPL_FLDC | Specify the default value of record fields in a section. |

Setup Record Definition Page

Use the Setup Record Definition page (GP_ABS_RECDEFN) to identify the records and fields used in the extended absence template.

Navigation:

Set Up HCM > Product Related > Global Payroll & Absence Management > Absence Management > Setup Sections - Record Defn > Setup Record Definition

This example illustrates the fields and controls on the Setup Record Definition page.

Setup Record Definition

Record

Record Name GP_ABS_FMLA_ELG Description FMLA Eligibility CS

Instance Find | View All First 1 of 1 Last

Record Instance 1 *Status Active +

*Record Alias GP_ABS_FMLA_ELG

| Field Personalize Find <input type="text"/> <input type="button" value="Grid"/> | | | | First 1-30 of 30 Last |
|--|--------------------------------|-------------------------------------|-------------------------------------|-----------------------|
| *Field Name | Field Label | Key Field | Required | |
| EFFDT | Effective Date | <input checked="" type="checkbox"/> | <input checked="" type="checkbox"/> | - |
| EFFSEQ | Effective Sequence | <input checked="" type="checkbox"/> | <input checked="" type="checkbox"/> | - |
| EMPLID | Empl ID | <input checked="" type="checkbox"/> | <input checked="" type="checkbox"/> | - |
| EMPL_RCD | Empl Record | <input checked="" type="checkbox"/> | <input checked="" type="checkbox"/> | - |
| TRANSACTION_NBR | Transaction Number | <input checked="" type="checkbox"/> | <input checked="" type="checkbox"/> | - |
| GP_ABS_FMLA_ELIG | FMLA Eligible | <input type="checkbox"/> | <input checked="" type="checkbox"/> | - |
| GP_ABS_FMLA_ENTITL | Entitlement | <input type="checkbox"/> | <input checked="" type="checkbox"/> | - |
| GP_ABS_FMLA_FD_EES | Federal Minimum Employees Elig | <input type="checkbox"/> | <input checked="" type="checkbox"/> | - |
| GP_ABS_FMLA_FD_HRS | Federal Earned Hours Elig | <input type="checkbox"/> | <input checked="" type="checkbox"/> | - |
| GP_ABS_FMLA_FD_SVC | Federal Service Weeks Elig | <input type="checkbox"/> | <input checked="" type="checkbox"/> | - |
| GP_ABS_FMLA_HRS_FD | Earned Hours | <input type="checkbox"/> | <input checked="" type="checkbox"/> | - |
| GP_ABS_FMLA_HRS_ST | Earned Hours | <input type="checkbox"/> | <input checked="" type="checkbox"/> | - |
| GP_ABS_FMLA_LV_AVL | Leave Available | <input type="checkbox"/> | <input checked="" type="checkbox"/> | - |
| GP_ABS_FMLA_LV_RQT | Leave Requested | <input type="checkbox"/> | <input checked="" type="checkbox"/> | - |
| GP_ABS_FMLA_LV_TKN | Leave Taken | <input type="checkbox"/> | <input checked="" type="checkbox"/> | - |

| Field or Control | Description |
|-------------------------|--|
| Record Alias | Enter an alternate name for the table, the default value is the record name. Using an alternate name enables you to differentiate between different instances of the same record. |
| Key Field | This field displays the status of the selected field as a key field at the system level. |
| Required | Select to indicate that the selected field is required for your business process. You cannot change the setting here for fields that are defined as required fields at the system level. |
| Add Field | Click to add a new row to the group box. You can only select fields that are valid for the specified record. |

| Field or Control | Description |
|-------------------------|---|
| Add All Fields | Click to add all of the available fields from the specified record. |

Setting Up Section Definition Page

Use the Setup Section Definition page (GP_ABS_SECDEFN) to combine records and fields into sections for use in the extended absence template.

Select the fields and the order in which fields appear in a section.

Navigation:

Set Up HCM > Product Related > Global Payroll & Absence Management > Absence Management > Setup Configurable Sections > Setup Section Definition

This example illustrates the fields and controls on the Setup Section Definition page.

Setup Section Definition

Country CYM Cayman Islands

Section Identification

Template Section ID GP_ABS_FMLA_MED

*Description

*Short Description

Comments

Section Configuration

Sequence Number

Effective Date Definition

Effective Date Enabled Edit Row Enabled

Add Row Enabled Copy Previous Row

Section Validation App Class

Application Class Path

App Class ID

Method Name

Section Fields Personalize | Find | | First 1-12 of 12 Last

| Seq Nbr | Record Alias | *Field | Field Label | Field Configuration |
|---------|-----------------|-------------------|--------------------------|---------------------|
| 1 | GP_ABS_MED_CERT | GP_ABS_MDCRT_ODU | Original Due Date | Field Configuration |
| 2 | GP_ABS_MED_CERT | GP_ABS_MDCRT_EDU | Extended Due Date | Field Configuration |
| 3 | GP_ABS_MED_CERT | GP_ABS_MDCRT_IRCV | Incomplete Received Date | Field Configuration |
| 4 | GP_ABS_MED_CERT | GP_ABS_MDCRT_CRC | Complete Received Date | Field Configuration |

This example illustrates the fields and controls on the Setup Section Definition page.

| | | | | | |
|----|-----------------|-------------------|-------------------------|---------------------|---|
| 5 | GP_ABS_MED_CERT | GP_ABS_MDCRT_CMPL | Certification Completed | Field Configuration | - |
| 6 | GP_ABS_MED_CERT | GP_ABS_MDCRT_CHRI | Chronic Condition | Field Configuration | - |
| 7 | GP_ABS_MED_CERT | GP_ABS_MDCRT_FREQ | Frequency | Field Configuration | - |
| 8 | GP_ABS_MED_CERT | GP_ABS_MDCRT_DUR | Duration | Field Configuration | - |
| 9 | GP_ABS_MED_CERT | GP_ABS_MDCRT_MISC | Miscellaneous | Field Configuration | - |
| 10 | GP_ABS_MED_CERT | GP_ABS_MDCRT_PHYS | Physician Name | Field Configuration | - |
| 11 | GP_ABS_MED_CERT | GP_ABS_MDCRT_DTFM | Certification Date From | Field Configuration | - |
| 12 | GP_ABS_MED_CERT | GP_ABS_MDCRT_DTTC | Certification Date To | Field Configuration | - |

Add Field

| Field or Control | Description |
|---|--|
| Sequence Number | Enter a number to determine the order of sections on the data entry page |
| Effective Date Enabled | Select to add effective dated functionality to this section. You cannot select any of the other fields in the Effective Data Definition region until this field is selected. |
| Edit Row Enabled | Select to enable users to edit the section, unless the transaction is in display-only mode. |
| Add Row Enabled | Select to enable users to add new rows to the section, by clicking the Add button in the section. |
| Copy Previous Row | Select to copy the information from the previous row when a user adds a new row to the section. The sequence number and effective date are not copied from the previous row. Deselecting this field causes new rows to appear without any data from the previous row. The fields in the new row are empty and ready for input. |
| Application Class Path | Select an Application Class Path based on the Application Packages defined within the Application Designer. |
| App Class ID(Application Class ID) | Select an Application Class from the selected Application Class Path. |
| Method Name | Enter the executable method defined in the Application Class to trigger the validation of the configurable section. |

Section Fields

| Field or Control | Description |
|----------------------------|---|
| Record Alias | This refers to the field defined in the Record Definition. An alternate name for the table, the default value is the record name. |
| Field | The Record Field included on the page as part of the section. |
| Field Configuration | Click to access the Template Section Field Configuration page |

Template Section Field Configuration Page

Use the Template Section Field Configuration page (GP_ABS_SECDTL`) to define the display and edit options per field.

Navigation:

Click the **Field Configuration** link on the Setup Section Definition page.

This example illustrates the fields and controls on the Template Section Field Configuration page.

Template Section Field Configuration

Section Field

| | |
|------------------------------|--|
| Record Alias GP_ABS_MED_CERT | Record Instance 1 |
| Record Name GP_ABS_MED_CERT | Record Description FMLA Medical Certification CS |
| Field Name GP_ABS_MDCRT_ODUE | Field Label Original Due Date |

Section Field Configuration

*Display Type ▾

Prompt Table

Prompt Field

[Template Section](#)

| Field or Control | Description |
|-------------------------|---|
| Display Type | Select to choose the display type of the field. Values are: <i>Short Edit Box, Long Edit Box, Long DropDown, Short DropDown, Short Prompt, Long Prompt, CheckBox, Date.</i> |
| Prompt Table | Displays the name of the prompt table or substitution variable from the PeopleTools Record Definition table. This value can be modified. |
| Prompt Field | Enter the field used on the prompt table to select the value. |

Configurable Section Setup - Template Page

Use the Configurable Section Setup - Template page (GP_ABS_TEMPL_DEF) to enter template identification information.

Navigation:

Set Up HCM > Product Related > Global Payroll & Absence Management > Absence Management > Configurable Section Setup > Template

This example illustrates the fields and controls on the Configurable Section Setup - Template page.

| <i>Field or Control</i> | <i>Description</i> |
|-----------------------------------|---|
| Show Comments On All Pages | Select to show the comments as additional information on the Configurable Sections page within an extended absence. |

Configurable Section Setup - Sections Page

Use the Configurable Section Setup - Sections page (GP_ABS_TEMPL_DEF) to combine sections into a page in the extended absence feature.

Navigation:

Set Up HCM > Product Related > Global Payroll & Absence Management > Absence Management > Configurable Section Setup > Sections

This example illustrates the fields and controls on the Configurable Section Setup - Sections page.

| Template | | Sections | | | |
|---|---------|---------------------------|---------------------|-----------------------------|--|
| Country CYM | | Effective Date 01/01/1990 | | | |
| Template GP_ABS_FMLA_ELG | | Status Active | | | |
| Template Sections Personalize Find First 1-2 of 2 Last | | | | | |
| Select | Seq Nbr | Section Country | Template Section ID | Section Name | Section Configuration |
| <input type="checkbox"/> | 1 | CYM | GP_ABS_FMLA_ELG | FMLA Eligibility (Employee) | Section Configuration + - |
| <input type="checkbox"/> | 2 | CYM | GP_ABS_FMLA_MED | Medical Certification | Section Configuration + - |
| Load/Reload Sections | | | | | |

| Field or Control | Description |
|------------------------------|--|
| Section Configuration | Click to access the Template Section Configuration page for the specified section. |
| Load/Reload Sections | Click to load the template sections from the template section setup table. |

Template Section Configuration Page

Use the Template Section Configuration page (GP_ABS_TMPL_FLDS) to define the section field properties.

Specify whether certain fields are required, display-only or hidden. You can also enter default values.

Navigation:

Click the **Section Configuration** link on the Configurable Section Setup - Sections page.

This example illustrates the fields and controls on the Template Section Configuration page (1 of 2).

Country CYM
Template GP_ABS_FMLA_ELG
Effective Date 01/01/1990
Description FMLA Eligibility

Section Country CYM
Section ID GP_ABS_FMLA_ELG
Section Name FMLA Eligibility (Employee)

Section Label Type

Use Section Description

Use Message Catalog

Use Text Catalog

Use Static Text

Hide Entire Section

Section Label

Message Set Number

Message Number

Sub ID

Text ID

Label

Section Fields Personalize | Find | | First 1-17 of 17 Last

| Section Country | Seq Nbr | Field | *Alignment | Field Label | Default Value | Required | Override | Hide | Edit |
|-----------------|---------|--------------------|------------|---|---------------|-------------------------------------|-------------------------------------|--------------------------|-------------------------------------|
| CYM | 1 | GP_ABS_FMLA_SPOUSE | Left | Employee's Spouse works for the same company | N - No | <input checked="" type="checkbox"/> | <input checked="" type="checkbox"/> | <input type="checkbox"/> | <input type="button" value="Edit"/> |
| CYM | 2 | GP_ABS_FMLA_SPS_ID | Auto | What is the Spouse's employee number? | | <input type="checkbox"/> | <input checked="" type="checkbox"/> | <input type="checkbox"/> | <input type="button" value="Edit"/> |
| CYM | 3 | GP_ABS_FMLA_FD_ELG | Left | Federal Eligibility | | <input type="checkbox"/> | <input type="checkbox"/> | <input type="checkbox"/> | <input type="button" value="Edit"/> |
| CYM | 4 | GP_ABS_FMLA_FD_SVC | Left | The employee has been employed for at least 12 months | N - No | <input checked="" type="checkbox"/> | <input type="checkbox"/> | <input type="checkbox"/> | <input type="button" value="Edit"/> |
| CYM | 5 | GP_ABS_FMLA_SVC_FD | Right | Current Months | | <input type="checkbox"/> | <input type="checkbox"/> | <input type="checkbox"/> | <input type="button" value="Edit"/> |
| CYM | 6 | GP_ABS_FMLA_FD_HRS | Left | The employee has worked for at least 1250 hours in the past | N - No | <input checked="" type="checkbox"/> | <input type="checkbox"/> | <input type="checkbox"/> | <input type="button" value="Edit"/> |

This example illustrates the fields and controls on the Template Section Configuration page (2 of 2).

| | | | | | | | | | |
|-----|----|--------------------|-------|---|--------|-------------------------------------|--------------------------|--------------------------|-------------------------------------|
| CYM | 7 | GP_ABS_FMLA_HRS_FD | Right | Current Hours | | <input type="checkbox"/> | <input type="checkbox"/> | <input type="checkbox"/> | <input type="button" value="Edit"/> |
| CYM | 8 | GP_ABS_FMLA_FD_EES | Left | At least 50 Employees are employed by the employer within a 75 miles radius | N - No | <input checked="" type="checkbox"/> | <input type="checkbox"/> | <input type="checkbox"/> | <input type="button" value="Edit"/> |
| CYM | 9 | GP_ABS_FMLA_ST_ELG | Left | State Eligibility | | <input type="checkbox"/> | <input type="checkbox"/> | <input type="checkbox"/> | <input type="button" value="Edit"/> |
| CYM | 10 | GP_ABS_FMLA_ST_SVC | Left | The employee has been employed for at least 12 months | N - No | <input checked="" type="checkbox"/> | <input type="checkbox"/> | <input type="checkbox"/> | <input type="button" value="Edit"/> |
| CYM | 11 | GP_ABS_FMLA_SVC_ST | Right | Current Months | | <input type="checkbox"/> | <input type="checkbox"/> | <input type="checkbox"/> | <input type="button" value="Edit"/> |
| CYM | 12 | GP_ABS_FMLA_ST_HRS | Left | The employee has worked for at least 1250 hours in the past 12 months | N - No | <input checked="" type="checkbox"/> | <input type="checkbox"/> | <input type="checkbox"/> | <input type="button" value="Edit"/> |
| CYM | 13 | GP_ABS_FMLA_HRS_ST | Right | Current Hours | | <input type="checkbox"/> | <input type="checkbox"/> | <input type="checkbox"/> | <input type="button" value="Edit"/> |
| CYM | 14 | GP_ABS_FMLA_ST_EES | Left | At least 50 Employees are employed by the employer within a 75 miles radius | N - No | <input checked="" type="checkbox"/> | <input type="checkbox"/> | <input type="checkbox"/> | <input type="button" value="Edit"/> |
| CYM | 15 | GP_ABS_FMLA_BAL | Left | FMLA Balances | | <input type="checkbox"/> | <input type="checkbox"/> | <input type="checkbox"/> | <input type="button" value="Edit"/> |
| CYM | 16 | GP_ABS_FMLA_LV_AVL | Left | Leave Available | | <input type="checkbox"/> | <input type="checkbox"/> | <input type="checkbox"/> | <input type="button" value="Edit"/> |
| CYM | 17 | GP_ABS_FMLA_LV_TKN | Left | Leave Taken | | <input type="checkbox"/> | <input type="checkbox"/> | <input type="checkbox"/> | <input type="button" value="Edit"/> |

| Field or Control | Description |
|--|--|
| Section Label Type | <p>Select the method used to choose the content of the section label in the specified template. Different fields in the Section Label region are available for entry depending upon the chosen Label Type. The following list describes the effect of choosing each Label Type on the Section Label region:</p> <ul style="list-style-type: none"> • Selecting Use Section Description causes the system to use the description defined in the Section as the section heading on the extended absence configurable page. The user is not required to enter a label. • Selecting Use Message Catalog enables you to enter a Message Set Number and a Message Number. • Selecting Use Text Catalog enables you to enter a Sub ID and a Text ID. • Selecting Use Static Text enables you to enter text in the Label field. |
| Message Set Number and Message Number | <p>Message sets and number settings come from the PeopleTools message set catalog. Select the message set and message number that you want to appear as the section label. You can select from the messages defined in the database. These fields are only available if you select the Use Message Catalog option in the Section Label Type region.</p> |
| Sub ID and Text ID | <p>Select the Text ID and Sub ID for the text catalog message you want to display as the section label. These fields are only available if you select the Use Text Catalog option in the Section Label Type region.</p> |
| Label | <p>Enter the text you want to appear as the section label. This field is only available if you select the Use Static Text option in the Section Label Type region.</p> |
| Hide Entire Section | <p>Select to specify that this section is hidden from the user.</p> <p>For example, if certain information needs to be loaded into the buffer to support the validation, but does not need to be displayed.</p> |
| Field | <p>The Record Field selected in the section.</p> |
| Alignment | <p>Select the desired location of the field on the extended absence pages. You can specify that the field appears on the left or right side of the page, or indicate that the system should select the location, based on the available space. Values are: <i>Left</i>, <i>Right</i>, and <i>Auto</i>.</p> |
| Field Label | <p>Displays the field label used on the configurable page.</p> |

| Field or Control | Description |
|-------------------------|---|
| Default Value | The value that initially populates the record field. |
| Required | Defaulted from the Template Section Field Setup Table; can be overridden by the Template Administrator, but only if the default is No. A field required by definition of PeopleTools must remain required. However, a field that is not required by definition, can be made required on the template. |
| Override | Select to specify that the end user can enter or override the value of the specified field. |
| Hide | Select this field to hide the specified field from the end user. |
| Edit | Click to access the Section Field Default Value page. |

Section Field Default Value Page

Use the Section Field Default Value page (GP_ABS_TMPL_FLDC) to specify the default value of record fields in a section.

Navigation:

Click the **Edit** button on the Template Section Configuration page.

This example illustrates the fields and controls on the Section Field Default Value page.

[Section Field Default Value](#)

Field Name GP_ABS_FMLA_SPOUSE
Field Label Spouse works for company

Section Field

Sub ID

Text ID

Field Label Override Employee's Spouse works for the same company

Section Field

Default Value

[Maintain Text Catalog](#)

| Field or Control | Description |
|-------------------------|--|
| Default Value | Enter the value that initially populates the record field. |

Setting Up Extended Absences

This topic provides an overview of the high-level setup tasks for self service extended absence transactions.

Setup Tasks for Extended Absences

The setup tasks for extended absences are as follows:

1. Specify that the absence take is allowed as an extended absence in the Country Take (GP_ABS_BAL_SS_DEF) component.

See [Defining Self Service Absence Rules by Take Element](#).

2. Link an attachment configuration to an extended absence on the Maintain Definitions page.

On the Maintain Definitions page, you specify the attachment configuration associated with the extended absence element.

See “Configuring and Working With Attachments” (Application Fundamentals).

See [Understanding Extended Absences](#).

3. Link any configurable section templates to each of the extended absence components you are using. Then specify the desired type of user access to the displayed configurable section page.

See [Defining Self Service Absence Rules by Take Element](#).

4. Register the approval transaction in the Approval Framework through the Register Transactions page.

Note: The Approval Transaction Registry is already populated for the PeopleSoft delivered AM_Extended_Abs approval process ID.

See “Understanding Approvals” (Application Fundamentals).

Requesting Extended Absences

Pages Used to Request Extended Absences

| <i>Page Name</i> | <i>Definition Name</i> | <i>Usage</i> |
|---|------------------------|---|
| Request Extended Absence Page | GP_ABS_EA_REQ | Request an extended absence using the defined extended absence types. Review the status of an extended leave |
| Request Extended Absence (Configurable Sections) Page | GP_ABS_DATA | View and complete the additional fields and controls created for the configurable sections for this type of extended absence. |

| Page Name | Definition Name | Usage |
|---------------------------------------|------------------------|--|
| Extended Absence Request Details Page | GP_ABS_EA_REQ | View the details of the current extended absence request |

Note: Pages for requesting extended absences have been replaced by equivalent pages in Fluid. For more information, see [Using the PeopleSoft Fluid User Interface to Work with Absences as an Employee](#).

Request Extended Absence Page

Use the Request Extended Absence page (GP_ABS_EA_REQ) to request an extended absence using the defined extended absence types.

Review the status of an extended leave

Navigation:

- **Self Service > Time Reporting > Report Time > Extended Absence Request**
- **Global Payroll & Absence Mgmt > Payee Data > Maintain Absences > Request Extended Absence**

This example illustrates the fields and controls on the Request Extended Absence page.

Request Extended Absence

Antonio Smith
Administrator

To create your request, complete the information in the Extended Absence Request Details section and select save for later or submit the request for approval. Additional information may be managed or viewed at a later time.

| Extended Absence Request Details ? | Related Links ? |
|--|--|
| <p>*Start Date <input style="width: 80px;" type="text" value="07/01/2013"/> ?</p> <p>*Expected Return Date <input style="width: 80px;" type="text" value="08/03/2013"/> ?</p> <p>Actual Return Date <input style="width: 80px;" type="text"/> ?</p> <p>Absence Type <input style="width: 100%;" type="text" value="Family and Medical Leave Act"/> ▼</p> <p>*Absence Name <input style="width: 100%;" type="text" value="FMLA Medical"/> ▼</p> <p>Absence Reason <input style="width: 100%;" type="text" value="FMLA Medical"/> ▼</p> <p>Current Balance 0.00 **</p> <p>FMLA Eligibility</p> | <p> FAQ</p> |

Absence Requests

| Absence Request ? | | | | | |
|--|--------|------------|----------|----------|--------|
| Personalize Find View All | | | | | |
| First 1 of 1 Last | | | | | |
| Absence Requests | Status | Start Date | End Date | Duration | Source |
| | | | | | |

Requestor Comments

The system does not display the entire page until the user enters values for the **Start Date**, **Expected Returned Date**, and **Absence Take**.

| <i>Field or Control</i> | <i>Description</i> |
|--------------------------------|--|
| Start Date | Select the first day of the extended absence event. The field option defaults to the current date. |
| End Date | Enter the expected return date. |
| Absence Type | Select the absence type. The selection you make in this field will limit or filter the selections available in the Absence Name field. |

| Field or Control | Description |
|-------------------------|--|
| Absence Name | Select the absence name from the available options. The options available depend on the selection in the Absence Type field, the extended absence takes that are enabled in the Country Take setup, and the elements for which the employee is eligible. After you select entries in the above fields, the system refreshes the page with additional fields. |
| Absence Reason | Select the absence reason from the available options. The options available depend on the selection in the Absence Type field. |

Request Extended Absence (Configurable Sections) Page

Use the Request Extended Absence Configurable Sections page (GP_ABS_DATA) to view and complete the additional fields and controls created for the configurable sections for this type of extended absence.

Navigation:

Click the link on the Request Extended Absence page in the Extended Absence Request Details region. The name of this link changes depending upon how configurable sections have been set up for this type of extended absence.

This example illustrates the fields and controls on the Request Extended Absence (Configurable Sections) page (shown as the FMLA Eligibility page).

The screenshot shows a web form titled "Administer Extended Absence" with a sub-section "FMLA Eligibility (FMLA Administrator)". Below this is a "Medical Certification" section. A note states: "The information in this section is to be completed by your FMLA Administrator and will not be shared with Management or any other party." There is an "Add" button. The form contains several input fields and dropdown menus:

- Date Change Will Take Effect: 05/25/2012
- Sequence: 1
- Status: Active
- Original Due Date: 05/25/2012
- Extended Due Date: 05/25/2012
- Incomplete Received Date: 05/25/2012
- Complete Received Date: 05/25/2012
- Certification Completed: [empty]
- Chronic Condition: [empty]
- Frequency: [dropdown]
- Duration: [empty]
- Miscellaneous: [empty]
- Physician Name: [empty]
- Certification Date From: 05/25/2012
- Certification Date To: 05/25/2012

At the bottom, there is a "Comments" section with a text area and a "Validate Sections" button. A "Return to Extended Absence Request" link is also present.

| Field or Control | Description |
|-------------------------------------|---|
| Add | Click to add a new effective-dated row this configurable section. This button is only available when you are editing an extended absence and the Effective Date Enable and Add Row Enabled options have been selected on the Setup Section Definition page. |
| Delete | Click to delete the current effective-dated row from this configurable section. This button is only available for new rows that have not been saved. |
| Date Change Will Take Effect | Enter the date on which the information in a configurable section becomes active. |
| Previous and Next | Click to navigate through effective-dated rows of data in the configurable section. These buttons only appear as they are required for navigation. For example, a configurable section with only one effective-dated row will not display these buttons. |
| Sequence | <p>Displays the sequence number for this row. This field cannot be edited through the employee Request Extended Absence page, even when editing an extended absence request. You can only edit this field through the Administer Extended Absence component.</p> <p>This field enables you to determine the proper sequencing if you need to enter multiple sets of information on the same date. For example, assume that within a single day the user, or requestor, takes his or her spouse to a doctor for diagnosis in the morning. The doctor recommends that the patient be transferred to an emergency room for immediate treatment. Later, the patient is moved to intensive care within the hospital. By manually entering the sequence number for each of these events, the administrator can facilitate tracking the information related to these different events.</p> |
| Validated on | Displays the date on which this effective-dated row of the configurable section was validated. |
| Validate Sections | <p>Click to validate all of the current effective-date sections on the page.</p> <hr/> <p>Important! The processing logic for the Validate Sections button (application class GP_ABS_FMLA) that PeopleSoft Absence Management delivers for extended absences should be used as a model only. Customers need to create validation logic of their own to meet their individual business needs.</p> <hr/> <p>Note: The system only displays the first error encountered for any invalid sections. You must correct the error situation and then click the Validate Sections button again to see any subsequent validation error messages.</p> <hr/> |

Managing Extended Absences

Pages Used to Manage Extended Absences

| <i>Page Name</i> | <i>Definition Name</i> | <i>Usage</i> |
|--|------------------------|--|
| <u>Extended Absence Request History Page</u> | GP_ABS_EA_EEHIST | View the history of extended absence requests for a specific time period. Review the approval status, and edit existing requests. A link for each extended absence request accesses the Extended Absence Request Details page for the specified request. |
| Extended Absence Request Details | GP_ABS_EA_REQ | View details for an extended absence request. |
| <u>Administer Extended Absence Page</u> | GP_ABS_EA_ADM | Edit or approve extended leave requests. The extended absence administrator can also use this page to check the extended absence history and view details for an extended absence. |
| Approve Extended Absence Page | GP_ABS_EA_REQ | Approve, deny, or push back an extended absence |

Extended Absence Request History Page

Use the Extended Absence Request History page (GP_ABS_EA_EEHIST) to view the history of extended absence requests for a specific time period.

Review the approval status, and edit existing requests. A link for each extended absence request accesses the Extended Absence Request Details page for the specified request.

Navigation:

Self Service > Time Reporting > View Time > Extended Absence History

This example illustrates the fields and controls on the Extended Absence Request History page.

Extended Absence Request History

Danilo Travantti
Sales Manager

Specify the date range of interest. To retrieve a complete history, leave From and Through dates blank and use the Refresh push button. Select the absence name link to view request details. Select edit button to modify or delete the request.

From Through

| Extended Absence Request History | | | | | | Personalize Find View All First 1 of 1 Last |
|----------------------------------|-----------|------------|----------------------|---------------------------|-------------------------------------|---|
| Absence Name | Status | Start Date | Expected Return Date | Source | Edit | |
| FMLA Medical | Submitted | 09/14/2014 | 10/19/2014 | Employee Extended Absence | <input type="button" value="Edit"/> | |

[Return to Job List](#)

| Field or Control | Description |
|------------------|--|
| Absence Name | Click the link in this field to access the Extended Absence Request Details page for the specified extended absence. |
| Edit | Click to access the Extended Absence Request page. |

Administer Extended Absence Page

Use the Administer Extended Absence page (GP_ABS_EA_ADM) to the extended absence administrator can edit, approve, deny or push back extended leave requests.

The extended absence administrator can also check the extended absence history and view details for an extended absence.

Navigation:

Global Payroll & Absence Mgmt > Payee Data > Maintain Absences > Administer Extended Absence

This example illustrates the fields and controls on the Administer Extended Absence page.

Administer Extended Absence

Search Criteria

*Show Requests by Status

Approver

Employee ID

Absence Name

From Last Name Through Last Name

From Date Through Date

| Extended Absence Requests | | | | | | | | | | Personalize Find View All First 1 of 1 Last |
|-------------------------------------|---------|-------------|----------------|------------|----------------------|-----------|----------------|------------------------|-------------------------------------|---|
| Name | Empl ID | Empl Record | Absence Name | Start Date | Expected Return Date | Status | Date Submitted | Absence Request Exists | Edit | Approve |
| Sabine D'Hardcastle | K0W131 | | 0 FMLA Medical | 11/01/2009 | 03/01/2010 | Submitted | 10/17/2011 | N | <input type="button" value="Edit"/> | <input type="button" value="Approve"/> |

When an extended absence has been approved, individual absence requests can be submitted within that extended absence.

Note: After an extended absence request has been saved, the user can upload attachments.

| Field or Control | Description |
|--------------------------------|---|
| Show Requests by Status | Select the status the system uses to filter the results displayed in the Extended Absence Requests region. Values are: <i>All, Approved, Denied, Pending, and Pushback</i> . |
| Search | Click to populate the Extended Absence Requests region based on the selections made in the Search Criteria region. |
| Name | Click the employee name to view the Extended Absence Requests Details page. |
| Absence Request Exists | Indicates the presence of one or more absence events beneath the extended absence request. |
| Edit | Click to edit the information on the Extended Absence Request page for this extended absence. |
| Approve | Click to view the Approve Extended Absence page, and approve, deny, or pushback the extended absence request |

Setting Up Self Service Absence Transactions

Understanding Self Service Setup Tasks

Payees and managers can use web-based browser pages, referred to as self service pages, to enter online requests for absences, view current and future absence balances, and run the Absence Forecasting process. Managers and administrators can also use self service pages to approve, deny, or push back absence requests.

Requests that are entered through the self service pages are treated as actual absences once they are approved, and are included in the Absence Take process.

This section lists prerequisites and common elements and provides an overview of the high-level setup tasks for self service absence transactions.

Prerequisite for Self-Service Setup Tasks

Before you can define take rules for self service absence transactions, you must specify which absence take types are eligible for self service use. On the Absence Take Types page for a given absence type, select the Allow Request in Self Service check box. This enables you to define self service rules for any take element with that absence type.

See [Defining Absence Types and Reasons](#).

Common Elements Used for Self-Service Setup Tasks

| <i>Field or Control</i> | <i>Description</i> |
|-------------------------|---|
| Status | When you create a new country-specific or Take-specific rule for absence self service, the rule's default status is Active. Changing the status of a rule to Inactive can impact absence requests that have been entered but not yet approved. Before changing the status of a rule to Inactive, consider how this action will affect already submitted requests. |

Setup Tasks for Self Service Absence Transactions

The setup tasks for absence self service are as follows:

1. Define self service rules for each country.

Country-specific rules apply to all take elements for a given country. They control some of the field displays on the self service pages, and determine who can use the online Forecasting and Balance Inquiry processes. You can define a different set of self service rules for each country.

2. Define self service rules for each take element.

For each take element that you want to make available to self service users, you define an additional set of rules. These rules specify whether partial-day absences are allowed, approval requirements for absence requests, how to display forecasting results, and other usage rules.

3. Select the entitlement balances to display in the forecasting results.

If you enable self service users to run the online Forecasting process or Absence Inquiry process, specify which entitlement balances to display to self service users.

4. (Optional) Modify fields labels and page text, as needed.

The Text Catalog stores the text that appears on the self service pages, including field labels, button names, links, page instructions, and warnings. You can modify this text by editing entries in the Text Catalog.

Note: The sequence of steps 2 and 3 can be reversed.

Defining Self Service Absence Rules by Country

To define country-specific rules for using the absence self service pages, use the Country Configuration (GP_ABS_SS_CNTRY) component.

Video: [Image Highlights, PeopleSoft HCM Update Image 43: Absence Balance and Forecast Enhancements](#)

Pages Used to Define Self Service Absence Rules by Country

| <i>Page Name</i> | <i>Definition Name</i> | <i>Usage</i> |
|---------------------------------------|------------------------|---|
| Entitlement Grid Page | GP_ABS_SS_CNTRY1 | Select the entitlement fields that appear on the View Absence Balances page. |
| History Grid Page | GP_ABS_SS_CNTRY2 | Select the history fields that appear on the View Absence Requests page. |
| Forecasting Grid Page | GP_ABS_SS_CNTRY3 | Select forecasting options and fields to display on the View Forecasting Details page. |
| Balances Page | GP_BAL_ELIG_SS | Enter balance elements and select display options on the View Absence Entitlement Balance page. |

| Page Name | Definition Name | Usage |
|----------------------------------|------------------------|--|
| Event Entry Page | GP_ABS_EVT_ENTRY | Select deletion options to allow absent entries to be deleted on the Absence Event Entry page. |

Entitlement Grid Page

Use the Entitlement Grid page (GP_ABS_SS_CNTRY1) to select the entitlement fields that appear on the View Absence Balances page.

Navigation:

Set Up HCM > Product Related > Global Payroll & Absence Mgmt > Absence Management > Country Setup for Absence Take > Entitlement Grid

This example illustrates the fields and controls on the Entitlement Grid page.

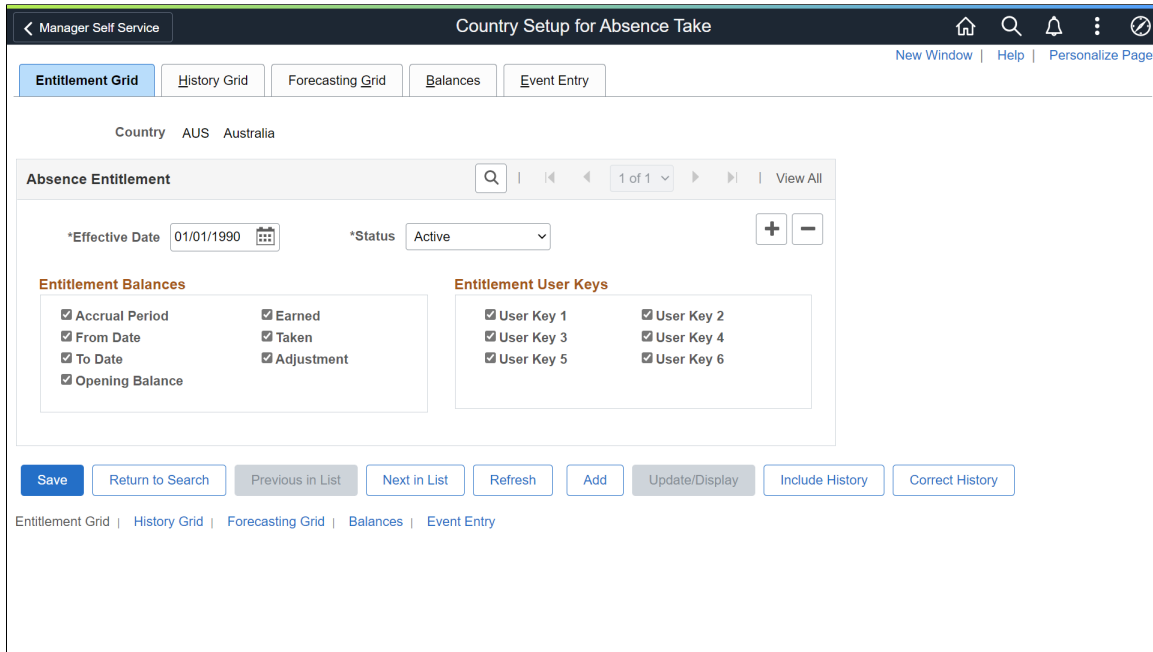

The fields on this page control what appears on the View Absence Balances page.

| Field or Control | Description |
|------------------------------|---|
| Accrual Period | Select to have the system display the accumulator period for each entitlement balance, for example, <i>year-to-date</i> or <i>month-to-date</i> . (Define the period for an entitlement accumulator on the Accumulator Periods for Element <element name> page. Select the entitlement accumulators on the Balances page.) |
| From Date and To Date | Select to display the begin and end dates of the accrual period. |

| Field or Control | Description |
|-------------------------|--|
| Opening Balance | Select to display the balance details such as opening, accrued, taken, adjustment and closing balances. |
| Earned | |
| Taken | |
| Adjustment | |
| User Key 1...6 | Select to display the values of up to six user keys that are associated with the entitlement accumulator. (Define user key values on an entitlement element's Auto Generated Accumulators page.) |

History Grid Page

Use the History Grid page (GP_ABS_SS_CNTRY2) to select the history fields that appear on the View Absence Requests page.

Navigation:

Set Up HCM > Product Related > Global Payroll & Absence Mgmt > Absence Management > Country Setup for Absence Take > History Grid

This example illustrates the fields and controls on the History Grid page.

The fields on this page control what appears on the View Absence Requests page.

| Field or Control | Description |
|--|---|
| Default History Date Range | Select to define the default date range for displaying historical absence events. When you select this check box, the system displays 90 days before the current date and 90 days after the current date. Note: Users can select dates outside of this date range by editing the From and Through fields on the View Absence Requests page. |
| Days Before Current Date and Days After Current Date | Use these fields to modify the default date range for displaying historical absence events. |
| Requested By | Select to display a column that identifies who (which role) submitted each request: the employer, administrator, or manager. Names are not displayed. This field is selected by default. |
| Duration | Select to display the duration of the absence event. This field is selected by default. |

Forecasting Grid Page

Use the Forecasting Grid page (GP_ABS_SS_CNTRY3) to select forecasting options and fields to display on the View Forecasting Details page.

Navigation:

Set Up HCM > Product Related > Global Payroll & Absence Mgmt > Absence Management > Country Setup for Absence Take > Forecasting Grid

This example illustrates the fields and controls on the Forecasting Grid page.

All check boxes on this page are selected by default.

| Field or Control | Description |
|---------------------------------|--|
| Forecast Request Enabled | <p>Select to enable self service users to run the online Absence Forecasting process. This causes a Forecast Balance button to appear on the Employee - Request Absence page and Manager - Request Absence page.</p> <p>For self service users to run the forecasting process for a given absence take element, the country take rule for that take element must also allow forecasting. (The Allow Forecasting check box must be selected on the take element's Forecasting Messages page.)</p> |

| Field or Control | Description |
|---------------------------------|--|
| Forecast Balance Enabled | Select to enable self service users to run the online Balance Inquiry process. This causes a View Forecast Balances link to appear on the Request Absence pages and the View Absence Balances pages. |
| From Date and To Date | Select to have the forecasting results display the From Date and the To Date for the forecasted period. |
| User Key 1...6 | Select to display the values of the user keys that are defined for the forecasted entitlement element's accumulator. |

Balances Page

Use the Balances page (GP_BAL_ELIG_SS) to enter balance elements and select display options on the View Absence Entitlement Balance page.

Navigation:

Set Up HCM > Product Related > Global Payroll & Absence Mgmt > Absence Management > Country Setup for Absence Take > Balances

This example illustrates the fields and controls on the Balances page.

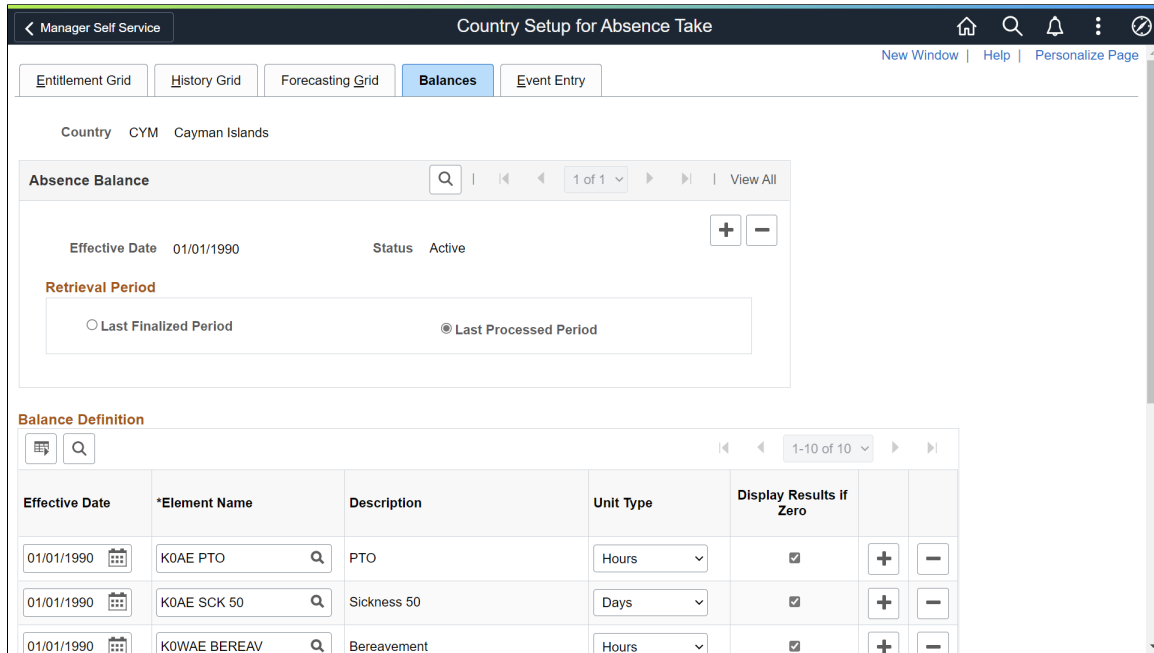

The fields on this page control what appears on the View Absence Entitlement Balances page in the Self Service component.

| Field or Control | Description |
|--------------------------------|---|
| Last Finalized Period | Select this field to show the balances as of your last finalized calendar. |
| Last Processed Period | Select this field to show the balances as of your last processed or calculated calendar. |
| Effective Date | The date that the balance accumulator will appear on the View Absence Entitlement Balances page. |
| Element Name | Select the accumulator element for the entitlement balance you want to display. |
| Unit Type | Select <i>Days</i> or <i>Hours</i> as the units to display on the self service pages. These are units that users see when viewing absence entitlement balances. Note: The selected unit type should match the unit type defined for the take element. |
| Display Results if Zero | Select to display the element on the View Absence Entitlement Balances page when there is no balance for that accumulator. The system displays the balances as of the most recent run of the Entitlement process for the employee. |

Event Entry Page

Use the Event Entry page (GP_ABS_EVT_ENTRY) to select deletion options to allow absent entries to be deleted on the Absence Event Entry page.

Navigation:

Set Up HCM > Product Related > Global Payroll & Absence Mgmt > Absence Management > Country Setup for Absence Take > Event Entry

This example illustrates the fields and controls on the Event Entry page.

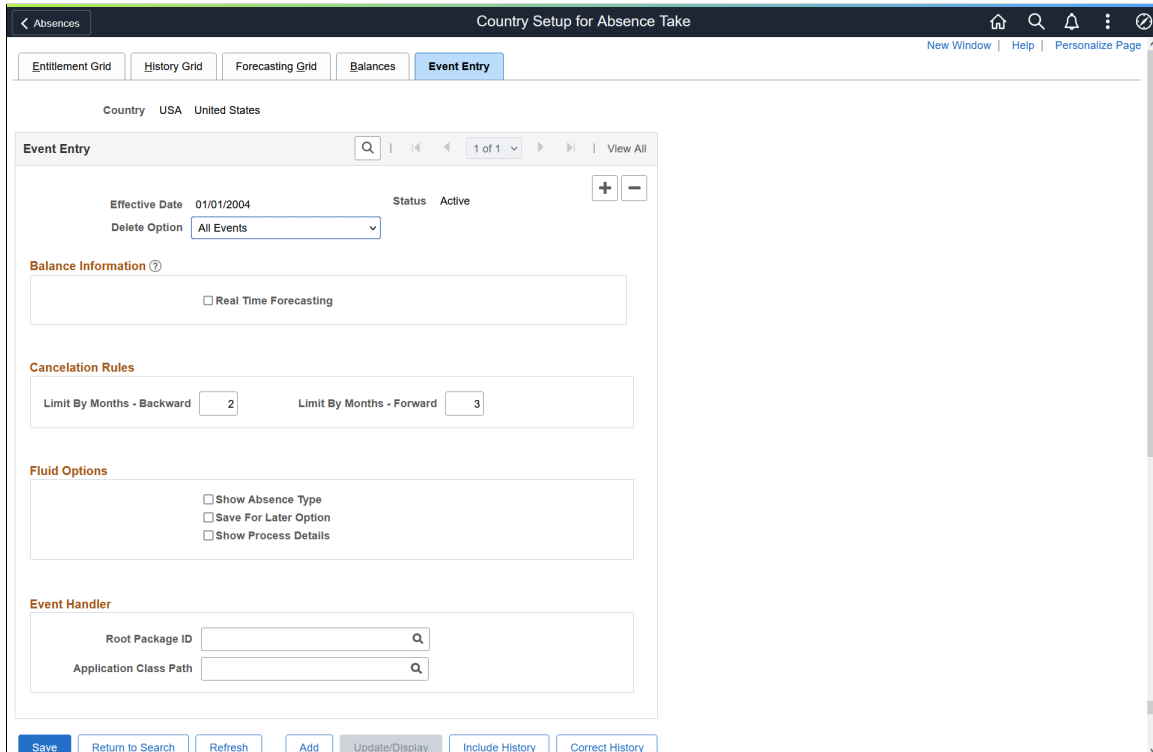

The fields on this page control real time balance calculation, deletion, cancellation, and Fluid options for absence requests.

| Field or Control | Description |
|-------------------------|--|
| Delete Option | Select a value to determine which absence events can be deleted on the Absence Event Entry page. Valid values are <i>All Events</i> , <i>All Events Except Finalized</i> , and <i>All Events Except Processed</i> . The delete button is disabled on the Absence Event Entry page for all rows that do not meet the criteria indicated by the Delete Option . |

Balance Information

| <i>Field or Control</i> | <i>Description</i> |
|------------------------------|--|
| Real Time Forecasting | Select this option to enable real time calculation of balances as of today. When you request a leave of absence, the system calculates your current balance as of today and recalculates it based on the number of hours or days you are requesting. |

Cancelation Rules

| <i>Field or Control</i> | <i>Description</i> |
|---|--|
| Limit By Months - Backward and Limit By Months - Forward | Define the range of months before and after the current date in which submitted absence requests must fall to be eligible for cancellation. For example, let us say that the Limit By Months - Backward is set to 2 and the Limit by Months - Forward is set to 3. In this case, on March 18 users would be able to cancel absence requests submitted for January 1 through June 30. |

Fluid Options

| <i>Field or Control</i> | <i>Description</i> |
|------------------------------|--|
| Show Absence Type | Select to display the type of absence for absence requests submitted using the PeopleSoft Fluid user interface. |
| Save for Later Option | Select to provide a Save for Later button for users submitting absence requests using the PeopleSoft Fluid user interface. |
| Show Process Details | Select to allow the employees to view the absence process details in the View Request Page from Self Service. <hr/> Note: By default, this option is not enabled. <hr/> |

Event Handler

While approving or cancelling absences, you can define an app package and class and execute any country specific logic using these options. The context of the absence event is set by absence code while calling the country extension event handler.

| Field or Control | Description |
|-------------------------------|--|
| Root Package ID | Search and select root package ID, for approving or canceling absence. |
| Application Class Path | Search and select the application class path. |

Note: The Country Specific app class needs to extend the core app class *HGA_COUNTRY_SPECIFIC:CountrySpecific* and implement the method *ExecuteCECode()* in their app class.

The record object for *GP_ABS_SS_DAT* and Action are passed as context and will be available for the country extension event handler app class.

This helps country extension code to identify the absence event and execute any country specific logic.

Related Links

[Entering Maintaining and Approving Absence Events](#)

Defining Self Service Absence Rules by Take Element

To define Take-specific self service absence rules, use the Configure Country Take Setup (GP_ABS_BAL_SS_DEF) component.

Pages Used to Define Self Service Absence Rules by Take Element

| Page Name | Definition Name | Usage |
|---|------------------------|--|
| Configure Country Take Setup - Absences Page | GP_ABS_ELIG_SS | For a given Take element and country, define absence units (days or hours), who can submit and approve requests, what happens to cancelled requests, and whether to allow partial-day absences. You can also specify whether to display the absence reason and entitlement balances. |
| Configure Country Take Setup - Date Rules Page | GP_ABS_ELIG2_SS | Define rules for entering absence dates, such as whether absences can begin or end on a holiday or off-day and whether to have the system calculate an absence's end date or duration. |
| Configure Country Take Setup - User Fields Page | GP_ABS_ELIG3_SS | Define user fields. |

| Page Name | Definition Name | Usage |
|---|------------------------|--|
| <u>Configure Country Take Setup - Forecasting Messages Page</u> | GP_ABS_ELIG4_SS | Define forecasting rules. |
| View Messages Page | GP_ABS_ELIG42_SEC | View the default messages that are returned by the online forecasting process. |
| <u>Customize Messages Page</u> | GP_ABS_ELIG4_SEC | Customize the messages that are returned by the online forecasting process. |
| <u>Configure Country Take Setup - Configurations Page</u> | GP_ABS_ELIG5_SS | Link configurable section templates to extended absence components and define access to the templates. |

Understanding PeopleSoft Delivered Approval Process IDs and Approval Framework Events

Approval Process IDs determine how absence request submissions, approvals, denials, and requests for rework are routed among approvers, requesters, and absence administrators. Self service absence transactions that require action by a user appear in both user worklists and emails. The content of the email message is defined using the Generic Template pages in the PeopleTools Workflow Notifications component. Which email template is used depends on the user's role (approver, requester, or administrator), and the approval framework event.

PeopleSoft Absence Management delivers the following Approval Process IDs:

- AbsenceManagement
- AM_Extended_Abs

Email Notification Templates for Absence Management Self Service Transactions

The following table lists the email template names that are used for each role based on the approval framework event:

| Approval Framework Event | Requester Templates | Approver Templates | Administrator Templates | Absence Request Action Button |
|---------------------------------|----------------------------|---------------------------|--------------------------------|--------------------------------------|
| Launch | GP_ABS_SS_SUB | | | Submit |
| Approve | | GP_ABS_SS_APPR_READY | | Submit |
| OnApprove | GP_ABS_SS_APPR | GP_ABS_SS_APPR | | Approve |

| Approval Framework Event | Requester Templates | Approver Templates | Administrator Templates | Absence Request Action Button |
|---------------------------------|----------------------------|---------------------------|--------------------------------|---|
| OnDeny | GP_ABS_SS_DNY | GP_ABS_SS_DNY | | Deny |
| Back | | GP_ABS_SS_WRK | | Needs Rework (Used when there are multiple levels of approval. For example, when Approver 2 pushes back to Approver 1.) |
| Terminate | GP_ABS_SS_WRK | | | Needs Rework |
| Error | | | GP_ABS_SS_ERR | NONE |

Note: Oracle PeopleSoft delivers Notification Composer Framework to manage the setup and administration of all notifications in one central location. Once you have adopted the Notification Composer feature, you must use it to create new notifications and manage your existing notifications. Notifications delivered with HCM Image 47 or later must use Notification Composer. For more information about Notification Composer Framework, see “Understanding Notification Composer” (Enterprise Components).

See the product documentation for *PeopleTools: Workflow Technology*.

Understanding Absence Duration and End Date Calculations

Depending on the rules that you define, the system can automatically calculate the duration of an absence event or its end date when a user enters an absence request. Calculation occurs when the user clicks a button on the Request Absence page.

The following factors can affect the calculation of an absence duration or end date:

- Partial-day absences.
Users can indicate whether partial-day absences apply to the first day of the absence event, all days, the last day, or the first day and the last day.
- Absence Take formulas.
If the formulas that your organization has defined for absence Take processing do not recognize partial hours, users can enter partial-day absences, but they are not used in calculations.
- Holidays and off days.
Specify to allow absence to start or end on a holiday or off day. Also, determine the calculation rule on the end date and/or duration.

- Unit type.

If the unit type defined for the absence (in the Unit Type field on the Absence page) is days, partial hours recorded for an absence event are ignored by the duration and end date calculations.

Calculations for Absences with a Unit Type of Hours

When the unit type defined for the absence is hours, the system calculates the end date and duration of an absence event as follows:

- End Date

To calculate the end date, the system applies the hours entered in the **Duration** field to the scheduled hours, day by day, starting with the begin date. Partial hours and half-days are taken into account. If there's a negative balance when the end date is reached (that is, scheduled hours for the end date exceed any remaining duration hours) the partial hours for the end date are adjusted to reflect the difference of hours.

An error is generated if the **Apply to All Days** check box is selected and the duration hours cannot be evenly divided by the partial hours or is not a sum of all scheduled hours divided by two, if half day is selected.

- Duration

The system adds the scheduled hours for the requested absence dates and adjusts the sum for partial or 1/2 day absences.

Example 1: Calculating End Date

Assume an employee works eight hours each day from Monday to Friday. Saturday and Sunday are off days (zero hour). The employee entered an absence request with a begin date of Wed, January 07 and a duration of 24 hours. The absence take is defined in hours. The following table shows the system-calculated duration for various scenarios:

| Start Date | Duration | Start Date Partial Hours | 1/2 Day Begin Date | All Days | End Date Partial Hours | 1/2 Day End Date | End Date | Comments |
|-------------------|-----------------|---|-----------------------------------|-----------------|---------------------------------------|-----------------------------|-----------------|---|
| 01/07/2004 | 24 | 0 | N | N | 0 | N | 01/09/2004 | 8 hrs/ Wed, Thu, Fri |
| 01/07/2004 | 24 | 3 | N | N | 5 | N | 01/12/2004 | 3 hrs/ Wed (bgn day); 8hrs/2days; 0 hr/ Sat, Sun; 5hrs/ Mon (end day) |

| Start Date | Duration | Start Date Partial Hours | 1/2 Day Begin Date | All Days | End Date Partial Hours | 1/2 Day End Date | End Date | Comments |
|-------------------|-----------------|---|-----------------------------------|---------------------------|---------------------------------------|-----------------------------|-----------------|---|
| 01/07/2004 | 24 | 0 | Y | N | 4 | N | 01/12/2004 | 4 hrs/Wed (bgn day); 8hrs/2days; 0 hr/Sat, Sun; 4hrs/ Mon (end day) |
| 01/07/2004 | 24 | 0 | N | Y / All Days Hrs: 4 Hrs | 0 | N | 01/14/2004 | 4 hrs/Wed, Thu, Fri; 0 hr/Sat, Sun, 4hrs/Mon, Tue, Wed |
| 01/07/2004 | 24 | 0 | N | Y/ All Days are Half Days | 0 | N | 01/14/2004 | 4 hrs/ Wed, Thu, Fri; 0 hr/ Sat, Sun, 4hrs/ Mon, Tue, Wed |
| 01/07/2004 | 24 | 0 | N | Y / All Days Hrs: 5 Hrs | 0 | N | Error | 24 not divisible by 5 |
| 01/07/2004 | 5 | 5 | N | N | 0 | N | 01/07/2004 | 24 not divisible by 5 |

Example 2: Calculating Duration

Assume an employee works eight hours each day from Monday to Friday. Saturday and Sunday are off days (zero hour). The employee enters an absence request and provides the begin date and the end date. The absence take is defined in hours. The following table shows the system-calculated duration for various scenarios.

| Start Date | End Date | State Date Partial Hours | 1/2 Day Begin Date | All Days | End Date Partial Hours | 1/2 Day End Date | Duration | Comments |
|-------------------|-----------------|---|-----------------------------------|-----------------|---------------------------------------|-----------------------------|-----------------|---------------------------|
| 01/05/2004 | 01/08/2004 | 0 | N | N | 0 | N | 32 | 8 hrs/ Mon, Tue, Wed, Thu |

| Start Date | End Date | State Date Partial Hours | 1/2 Day Begin Date | All Days | End Date Partial Hours | 1/2 Day End Date | Duration | Comments |
|-------------------|-----------------|---|-----------------------------------|--------------------------------|---------------------------------------|-----------------------------|-----------------|--|
| 01/05/2004 | 01/08/2004 | 3 | N | N | 0 | N | 27 | 3 hrs/ Mon; 8hrs/ Tue, Wed, Thu |
| 01/05/2004 | 01/08/2004 | 0 | N | N | 3 | N | 27 | 8hrs/ Mon, Tue, Wed; 3hrs/ Thu |
| 01/05/2004 | 01/08/2004 | 3 | N | N | 3 | N | 22 | 3 hrs/ Mon; 8hrs/ Tue, Wed; 3hrs/ Thu |
| 01/05/2004 | 01/08/2004 | 0 | N | Y/All Days Hrs: 3 Hrs | 0 | N | 12 | 3 hrs/ Mon, Tue, Wed, Thu |
| 01/05/2004 | 01/08/2004 | 0 | Y | N | 0 | N | 28 | 4 hrs/ Mon; 8hrs/ Tue, Wed, Thu |
| 01/05/2004 | 01/08/2004 | 0 | N | N | 0 | Y | 28 | 8hrs/ Mon, Tue, Wed; 4 hrs/ Thu |
| 01/05/2004 | 01/08/2004 | 0 | Y | N | 0 | Y | 24 | 4 hrs/ Mon; 8hrs/ Tue, Wed; 4 hrs/ Thu |
| 01/05/2004 | 01/08/2004 | 0 | N | Y/All Days are Half Days | 0 | N | 16 | 4 hrs/ Mon, Tue, Wed, Thu |
| 01/05/2004 | 01/10/2004 | 0 | N | N | 0 | Y | 40 | 8hrs/ Mon, Tue, Wed, Thu, Fri; 0hr/ Sat |

| <i>Start Date</i> | <i>End Date</i> | <i>State Date Partial Hours</i> | <i>1/2 Day Begin Date</i> | <i>All Days</i> | <i>End Date Partial Hours</i> | <i>1/2 Day End Date</i> | <i>Duration</i> | <i>Comments</i> |
|-------------------|-----------------|---|-----------------------------------|--------------------------------|---------------------------------------|-----------------------------|-----------------|---|
| 01/04/2004 | 01/08/2004 | 0 | Y | N | 0 | N | 32 | 0hrs/ Sun; 8hrs/ Mon, Tue, Wed, Thu |
| 01/04/2004 | 01/10/2004 | 0 | N | Y/All Days are Half Days | 0 | N | 20 | 0hrs/ Sun; 4hrs/ Mon, Tue, Wed, Thu; 0hr/ Sat |

Understanding Forecasting Messages

If you enable self service users to run the online Forecasting process, you can define the message to display at the end of that process. Use the Text Catalog to define the text for up to three messages: a success message, a warning message, and an error message. The entitlement element's forecasting formula specifies the conditions for issuing each message. You will map the value that's returned for each condition to the corresponding message that you define in the Text Catalog.

To define forecasting messages:

1. Use the Text Catalog to define a status message, a description, or both for each possible Forecasting outcome: success, warning, and error.
2. Use the Customize Messages page to map each message type (success, warning, error) to the value returned by the forecasting formula and to specify which text to display from the text catalog.

See [Viewing or Modifying Text on Self Service Absence Pages](#).

Configure Country Take Setup - Absences Page

Use the Configure Country Take Setup - Absences page (GP_ABS_ELIG_SS) to for a given Take element and country, define absence units (days or hours), who can submit and approve requests, what happens to cancelled requests, and whether to allow partial-day absences.

You can also specify whether to display the absence reason and entitlement balances.

Navigation:

Set Up HCM > Product Related > Global Payroll & Absence Mgmt > Absence Management > Configure Country Take Setup > Absences

This example illustrates the fields and controls on the Configure Country Take Setup - Absences page.

Configure Country Take Setup

Absences
Date Rules
User Fields
Forecasting Messages
Configurations

Country USA
 Absence Take KOWAT VAC TAKE

United States
 Vacation

Self Service Rules ?
Q | < < 1 of 1 > > | View All

*Effective Date 01/01/1990 📅
 Unit Type Hours ▼

*Status Active ▼
+ -

Administrative Rules ?

*Allow Request By Employee and Manager ▼
 Override Request As
 Approval Process ID AbsenceManagement Q
 Allow Entry in Time and Labor
 Allow in Desktop Integration

*Request As Employee ▼
 Cancellation Method Change Status on Record ▼
 Approval Definition ID AbsenceMgmtByPosnSupervisor Q
 Allow Entry as Extended Absence

Cancellation Rules

*Cancellation Option All Events ▼
 *Cancel As Employee ▼
 Approval Process ID AbsenceCancellation Q
 Display Cancel Reason
 Approvals for Pending Requests

*Cancel Allowed By Employee and Manager ▼
 Override Cancel As
 Approval Definition ID By_SupervisorMulti Q
 Cancel Reason Required

Administrator Options

Employee Authorization
 Override Authorization

Page Display Rules ?

Display Reason
 Display Current Balance
 Balance Display Option Summarized ▼
 Allow Partial Days

Reason Required
 Current Balance Accumulator KOWAE VAC_BAL Q
 Display Original Begin Date
 *Partial Days Option Partial Hours and Half Days ▼
 Allow Begin and End Time

Self Service Rules

| <i>Field or Control</i> | <i>Description</i> |
|-------------------------|--|
| Unit Type | Select <i>Days</i> or <i>Hours</i> as the units to display on the self service pages. These are units that users enter when requesting time off. <hr/> Note: The selected unit type should match the unit type defined for the Take element. |

Copyright © 1988, 2024, Oracle and/or its affiliates.

549

Administrative Rules

| Field or Control | Description |
|-------------------------------|--|
| Allow Request By | Specify who can request absences for this Take element through the self service pages. Values are: <i>Employee</i> , <i>Employee and Manager</i> (default), and <i>Manager</i> . |
| Request As | Specify whether this Take element can be requested as an Employee, Manager, or is Not Applicable in the manager self service page. |
| Override Request As | Specify whether the Request As option selected can be overridden on the manager self service page. |
| Approval Process ID | <p>Select the approval Process ID to use for the Country and absence take element. Approval Process ID refers to the technical definitions that control the execution of the approval process and its integration with the Approval Workflow Engine. In addition notifications (emails and worklist) are defined within Approval Process ID.</p> <p>See “Understanding the Approval Process” (PeopleSoft Global Payroll).</p> |
| Approval Definition ID | <p>Select the ID that corresponds to this type of approval, based on how you set up the approval framework. PeopleSoft delivers one approval Definition ID that is used for six delivered Process IDs. The selection of Definition ID for the self service Take elements at the country level depends on how the company has set up Direct Reports.</p> <p>This field is optional. You can also set up Administrative Rules without entering a value in this field. If you define an absence Take without a Definition ID, the system does not use the approval framework when employees or managers select this Take element on absence self service pages.</p> <p>See “Understanding the Approval Process” (PeopleSoft Global Payroll).</p> <hr/> <p>Note: If your absence request does not require approval, then leave Approval Process ID and Approval Definition ID blank. The absence request will be automatically approved once the user submits it.</p> <hr/> |

| Field or Control | Description |
|--|--|
| Cancellation Option | <p>Specify what happens when an absence request is cancelled. Options are:</p> <p><i>Change Status on Record:</i> (Default) Select to have the system change the status of the request to Cancelled. When a request's status is set to Canceled, you can no longer access the request.</p> <p><i>Delete from Database:</i> Select to have the system delete the request from the database.</p> |
| Allow Entry in Time and Labor | Select to allow absence event entry on the Timesheets page in PeopleSoft Time and Labor. You cannot select both the Allow Entry in Time and Labor field and the Allow Entry as Extended Absence field. |
| Allow Entry as Extended Absence | Select to enable users to choose this absence take as an extended absence. You cannot select both the Allow Entry in Time and Labor field and the Allow Entry as Extended Absence field. |
| Allow in Desktop Integration | This option is no longer supported. |

Cancellation Rules

| Field or Control | Description |
|--------------------------------|--|
| Cancellation Option | <p>Specify which type of absence events can be canceled. Options are:</p> <ul style="list-style-type: none"> • <i>All Events</i> • <i>All Events Except Finalized</i> • <i>All Events Except Processed</i> • <i>Not Used</i> |
| Cancellation Allowed by | <p>Specify who can request absence cancellations for this take element through self-service pages. Options are:</p> <ul style="list-style-type: none"> • <i>Employee</i> • <i>Employee and Manager:</i> This is the default value for the field. • <i>Manager</i> |

| Field or Control | Description |
|-------------------------------|--|
| Cancel As | <p>For absence cancellation requests submitted using manager self-service pages, define who this take can be requested as. Values are:</p> <ul style="list-style-type: none"> • Employee • Manager • Not Applicable |
| Override Cancel As | <p>Select whether the Cancel As value can be overridden on manager self-service pages.</p> |
| Approval Process ID | <p>Select the approval Process ID to use for the Country and absence take element. Approval Process ID refers to the technical definitions that control the execution of the approval process and its integration with the Approval Workflow Engine. In addition notifications (emails and worklist) are defined within Approval Process ID.</p> <p>See “Understanding the Approval Process” (PeopleSoft Global Payroll).</p> |
| Approval Definition ID | <p>Select the ID that corresponds to this type of approval, based on how you set up the approval framework. PeopleSoft delivers one approval Definition ID that is used for six delivered Process IDs. The selection of Definition ID for the self service Take elements at the country level depends on how the company has set up Direct Reports.</p> <p>This field is optional. You can also set up Administrative Rules without entering a value in this field. If you define an absence Take without a Definition ID, the system does not use the approval framework when employees or managers select this Take element on absence self service pages.</p> <p>See “Understanding the Approval Process” (PeopleSoft Global Payroll).</p> <hr/> <p>Note: If your absence request does not require approval, then leave Approval Process ID and Approval Definition ID blank. The absence request will be automatically approved once the user submits it.</p> <hr/> |

| Field or Control | Description |
|---------------------------------------|--|
| Display Cancel Reason | Select to display the Cancel Reason field on the self-service pages. You define cancel reasons for specific absence take types. If you select this check box, the Cancel Reason Required check box becomes available. |
| Cancel Reason Required | Select this check box to make it mandatory for users to select a cancel reason when canceling absence requests that use this take. |
| Approvals for Pending Requests | With this check box deselected, employees do not need approval when they cancel pending absence requests. If you select this check box, requests to cancel pending absence requests require manager approval. |

Administration Options

| Field or Control | Description |
|-------------------------|--|
| Employee Authorization | Enabled if employee approval is required for these absences when admin submits the cancellation request. |
| Override Authorization | Enabled if administrator needs to override employee authorization while cancellation. |

Page Display Rules

| Field or Control | Description |
|--------------------------------|---|
| Display Reason | Select to enable self service users to specify the reason for the absence. This check box is selected by default. |
| Reason Required | Select to require that users enter the reason for the absence. |
| Display Current Balance | Select to display the balance for the absence entitlement element, as of the last finalized absence run on the Request Absence page. The balance will not reflect the number of units that the user is requesting. This check box is not selected by default. |

| Field or Control | Description |
|------------------------------------|---|
| Current Balance Accumulator | If you selected the Display Current Balance check box, select the accumulator element that stores the current balance for this absence Take element. |
| Balance Display Option | <p>Indicate which value you want the system to display as the current balance, when there are multiple instances of the accumulator with different user keys.</p> <p>Select one of the following options:</p> <p><i>Not Summarized</i> (default). Consider using this option when your rules for displaying the current balance are very complex. Create an accumulator that summarizes the value of the element contributors. The system will display the value of the most current instance of the accumulator.</p> <p><i>Summarized</i>. Select this option to have the system display the sum of the values of the multiple instances.</p> |
| Display Original Begin Date | Select to display the Original Start Date field on the Request Absence page. |
| Allow Partial Days | <p>This check box works with the Partial Days Option field. Select it to indicate whether partial day absences are allowed.</p> <p>Do not select the check box if partial days or hours are not allowed.</p> |
| Partial Days Option | <p>This field becomes available when you select the Allow Partial Days check box. Options are:</p> <ul style="list-style-type: none"> • <i>Half Days</i>: With this option, users can select a check box to enter a request for a half-day absence. The system determines the number of hours absent by looking at the user's schedule. • <i>Partial Hours</i>: With this option, users can request a partial-day absence by entering the number of absent hours. This is the default option. • <i>Partial Hours and Half Days</i>: With this option, users can request a partial-day absence by selecting a check box for a half-day absence or by entering the number of hours. • <i>None</i> is the default value when the Allow Partial Days check box is not selected. |

| Field or Control | Description |
|---------------------------------|--|
| Allow Begin and End Time | Select to display the absence begin time and end time on the Manage Absences page for the selected absence take. This field is enabled only if the Partial Days Option is <i>Half Days</i> , <i>Partial Hours</i> , or <i>Partial Hours and Half Days</i> . This check box is not selected by default. See Manage Absences Page . |

In the following example, the Summarized option would return a value of 20 for the KOAE PTO accumulator.

| Accumulator | From | To | User Key 1 | User Key 2 | Value |
|--------------------|-----------------|-------------------|-------------------|-------------------|--------------|
| KOAE PTO | January 1, 2000 | December 31, 2000 | CIA A | Pay group A | 5 |
| KOAE PTO | January 1, 2001 | December 31, 2001 | CIA A | Pay group A | 8 |
| KOAE PTO | January 1, 2002 | July 31, 2002 | CIA B | Pay group B | 4 |
| KOAE PTO | August 1, 2002 | December 31, 2002 | CIA B | Pay group B | 2 |
| KOAE PTO | January 1, 2003 | December 31, 2003 | CIA B | Pay group XYZ | 1 |

Related Links

“Target Information Page” (Application Fundamentals)

Configure Country Take Setup - Date Rules Page

Use the Configure Country Take Setup - Date Rules page (GP_ABS_ELIG2_SS) to define rules for entering absence dates, such as whether absences can begin or end on a holiday or off-day and whether to have the system calculate an absence's end date or duration.

Navigation:

Set Up HCM > Product Related > Global Payroll & Absence Mgmt > Absence Management > Configure Country Take Setup > Date Rules

This example illustrates the fields and controls on the Configure Country Take Setup - Date Rules page.

Configure Country Take Setup

Absences
Date Rules
User Fields
Forecasting Messages
Configurations

Country USA United States

Absence Take KOWAT VAC TAKE Vacation

Self Service Rules Q | < < 1 of 1 > > | View All

Effective Date 01/01/1990 Status Active

Start and End Date Rules ?

Allow Start or End on Holiday

Allow Start or End on Off-day

Calculation Rules ?

End Date and Duration Rules

Calculate End Date

Calculate Duration

If both entered recalculate Not Applicable

Exclusion Rules

Exclude Holidays

Exclude Off Day

Start and End Date Rules

| <i>Field or Control</i> | <i>Description</i> |
|--------------------------------------|--|
| Allow Start or End on Holiday | Select if the start or end date of the request can fall on a holiday. This field is selected by default. |
| Allow Start or End on Off-day | Select if the start or end date of the request can fall on a day the employee is not scheduled to work. This field is selected by default. |

Calculation Rules

The option that you select here causes a Calculate End Date button, a Calculate Duration button, or a Calculate End Date or Duration button to appear on the Request Absence page.

See [Understanding Absence Duration and End Date Calculations](#).

| Field or Control | Description |
|------------------------------------|---|
| Calculate End Date | Select to have the Calculate End Date button appear. When entering an absence request, the user must enter the absence begin date and duration. Clicking the Calculate End Date button causes the system to calculate and display the end date. This is the default selection. |
| Calculate Duration | Select to have the Calculate Duration button appear. When entering an absence request, the user must enter the absence begin and end dates. Clicking the Calculate Duration button causes the system to calculate and display the duration. |
| If both entered recalculate | This field controls what happens when a user enters a value in both the End Date and Duration fields while entering an absence request. <ul style="list-style-type: none"> • If you select <i>End Date</i> this field will be recalculated. • If you select <i>Duration</i>, this field will be recalculated. |
| Exclude Holidays | Select to exclude holidays from the end date and duration calculation for requested absence events. |
| Exclude Off Day | Select to exclude non-worked days (based on the employee's schedule) from the end date and duration calculation for requested absence events. |

Configure Country Take Setup - User Fields Page

Use the Configure Country Take Setup - User Fields page (GP_ABS_ELIG3_SS) to define user fields.

Navigation:

Set Up HCM > Product Related > Global Payroll & Absence Mgmt > Absence Management > Configure Country Take Setup > User Fields

This example illustrates the fields and controls on the Configure Country Take Setup - User Fields page.

Configure Country Take Setup

Absences
Date Rules
User Fields
Forecasting Messages
Configurations

Country USA
United States

Absence Take KOWAT VAC TAKE
Vacation

Self Service Rules
 | < | > | 1 of 1 | > | > | View All

Effective Date 01/01/1990
Status Active

Display User Fields

User Fields

| | | | | |
|-------------------|---|----------------|--------------------------------|--|
| Character 1 Label | <input type="text" value="Emergency Contact"/> | Char 1 Seq Nbr | <input type="text" value="1"/> | <input type="checkbox"/> Field 1 Required |
| Character 2 Label | <input type="text" value="Phone Number"/> | Char 2 Seq Nbr | <input type="text" value="2"/> | <input type="checkbox"/> Field 2 Required |
| Character 3 Label | <input type="text"/> | Char 3 Seq Nbr | <input type="text"/> | <input type="checkbox"/> Field 3 Required |
| Character 4 Label | <input type="text"/> | Char 4 Seq Nbr | <input type="text"/> | <input type="checkbox"/> Field 4 Required |
| Date 1 Label | <input type="text"/> | Date 1 Seq Nbr | <input type="text"/> | <input type="checkbox"/> Field 5 Required |
| Date 2 Label | <input type="text"/> | Date 2 Seq Nbr | <input type="text"/> | <input type="checkbox"/> Field 6 Required |
| Date 3 Label | <input type="text" value="Earliest Return Date"/> | Date 3 Seq Nbr | <input type="text" value="3"/> | <input type="checkbox"/> Field 7 Required |
| Date 4 Label | <input type="text"/> | Date 4 Seq Nbr | <input type="text"/> | <input type="checkbox"/> Field 8 Required |
| Monetary 1 Label | <input type="text"/> | Mon 1 Seq Nbr | <input type="text"/> | <input type="checkbox"/> Field 9 Required |
| Monetary 2 Label | <input type="text"/> | Mon 2 Seq Nbr | <input type="text"/> | <input type="checkbox"/> Field 10 Required |
| Monetary 3 Label | <input type="text"/> | Mon 3 Seq Nbr | <input type="text"/> | <input type="checkbox"/> Field 11 Required |
| Monetary 4 Label | <input type="text"/> | Mon 4 Seq Nbr | <input type="text"/> | <input type="checkbox"/> Field 12 Required |
| Decimal 1 Label | <input type="text"/> | Dec 1 Seq Nbr | <input type="text"/> | <input type="checkbox"/> Field 13 Required |
| Decimal 2 Label | <input type="text"/> | Dec 2 Seq Nbr | <input type="text"/> | <input type="checkbox"/> Field 14 Required |
| Decimal 3 Label | <input type="text"/> | Dec 3 Seq Nbr | <input type="text"/> | <input type="checkbox"/> Field 15 Required |
| Decimal 4 Label | <input type="text"/> | Dec 4 Seq Nbr | <input type="text"/> | <input type="checkbox"/> Field 16 Required |

| Field or Control | Description |
|----------------------------|---|
| Display User Fields | Select to have up to four user-defined fields appear on the Request Absence page. |

User Fields

Define up to four fields to appear on the Request Absence page. These fields enable you to collect additional data that you may need for absence tracking. You can use these fields as system elements and embed them in rules to perform a specific task with the information that users enter.

For each field you define, specify the format, the field label, and whether users are required to complete the field.

| Field or Control | Description |
|--------------------------------------|---|
| Field <number> Format | Options are <i>Character</i> , <i>Date</i> , <i>Decimal</i> , and <i>Monetary</i> . |
| Label <number> | Enter up to 30 alphanumeric characters for the field name. To appear on the Absence Detail page, the field must have a label. |
| Field <number> Required | Select if users are required to complete the field. |

Configure Country Take Setup - Forecasting Messages Page

Use the Configure Country Take Setup - Forecasting Messages page (GP_ABS_ELIG4_SS) to define forecasting rules.

Navigation:

Set Up HCM > Product Related > Global Payroll & Absence Mgmt > Absence Management > Configure Country Take Setup > Forecasting Messages

This example illustrates the fields and controls on the Configure Country Take Setup - Forecasting Messages page.

Configure Country Take Setup

Absences
Date Rules
User Fields
Forecasting Messages
Configurations

Country USA United States

Absence Take KOWAT VAC TAKE Vacation

Self Service Rules 🔍 | < | > | 1 of 1 | View All

Effective Date 01/01/1990 Status Active

Forecasting Rules ?

Allow Forecasting

Submission Role Employee and Manager Forecasting Reqd to Submit

Approval Role Manager Forecasting Reqd to Approve

Forecasting Messages ?

Default Message [View Messages](#)

Customized Message

Allow Warning Submit/Approve Warning Not Applicable

Allow Errors Submit/Approve Error Not Applicable

Forecasting Rules

| Field or Control | Description |
|--|---|
| Allow Forecasting | <p>Select to enable self service users to run the online forecasting process. A Forecast Balance button will appear on the Request Absence page. This check box is not selected by default.</p> <hr/> <p>Note: For self service users to run the forecasting process, the country rules for that Take element must also allow forecasting. (The Forecast Request Enabled check box must be selected on the Forecasting Grid page.)</p> <hr/> |
| Submission Role | <p>If forecasting is required before submitting an absence request, specify who must run the process. Options are: <i>Employee, Manager, Employee and Manager,</i> and <i>Not Applicable</i>(default).</p> <p>This field works in conjunction with the Forecasting Reqd to Submit check box. If you select the Forecasting Reqd to Submit check box, then you must specify a role in this field.</p> |
| Forecasting Reqd to Submit (forecasting required to submit) | <p>Select to require that the Forecasting process be run before submitting an absence request. This check box is not selected by default. Depending on your rules, the results of the forecasting process may determine whether or not the request can be submitted.</p> <p>Users receive an error message when they click Submit on the Absence Request page without first forecasting the absence entitlement balance.</p> |
| Approval Role | <p>If forecasting is required, specify who can run the forecasting process. Options are: <i>Manager</i> and <i>Not Applicable</i>.</p> |
| Forecasting Reqd to Approve (forecasting required to approve) | <p>Select to require that the online forecasting process be run before approving an absence request.</p> |

Forecasting Messages

The system can display the message, “Forecasting Completed Successfully” at the end of the forecasting process, or it can display customized messages that you create. You can have a different message display when the forecasting process is successful, generates a warning, or results in an error. You define the criteria for issuing a success, warning, or error message.

| Field or Control | Description |
|--|--|
| Default Message and View Messages | Select to have the system display the default message after a user runs the forecasting process. Click the View Messages link to access the View Messages page to see the default message. There is a default message for successful forecasting and one for system error. |
| Customized Message | Select to have a customized message display after a user runs the online forecasting process. |
| Allow Warning and Submit/Approve Warning | Select to enable users to submit absence requests when the forecasting process results in a warning. In the Submit Warning field, specify who can submit requests with warnings. Options are: <i>Employee, Manager, Employee and Manager</i> (default), and <i>Not Applicable</i> . |
| Allow Errors and Submit/Approve Error | Select to enable users to submit absence requests when the forecasting process results in an error. In the Submit Error field, specify who can submit requests with errors. Options are: <i>Employee, Manager, Employee and Manager</i> (default), and <i>Not Applicable</i> . |

Customize Messages Page

Use the Customize Messages page (GP_ABS_ELIG4_SEC) to customize the messages that are returned by the online forecasting process.

Navigation:

Click the **Customize Messages** link on the Forecasting Messages page.

This example illustrates the fields and controls on the Customize Messages page.

The screenshot shows the 'Customize Messages' interface. At the top, it displays 'Country USA United States', 'Element Name KOWAT VAC TAKE', and 'Effective Date 01/01/1990'. Below this is a 'Customize Messages Grid' with the following columns: '*Message Type', '*Forecasting Value', 'Display Option', 'Status Text ID', and 'Description Text ID'. Each column contains a search input field. To the right of the grid are '+' and '-' buttons. At the bottom of the grid area are 'OK' and 'Cancel' buttons. The page also includes a 'Help' link in the top right corner.

| Field or Control | Description |
|----------------------------|--|
| Message Type | Select the type of message to define: <i>Error</i> , <i>Success</i> , or <i>Warning</i> . |
| Forecasting Value | Enter the value that the Forecasting process (the forecasting formula) will return to trigger the display of this message. You can enter up to 20 alphanumeric characters in this field (the maximum field length for a character element in Absence Management). |
| Display Option | Specify the type of information in the Text Catalog that is to display after forecasting is complete. Options are: <i>Status</i> , <i>Description</i> and <i>Both</i> (default). |
| Status Text ID | If you selected <i>Display Status</i> or <i>Both</i> in the Display Option field, enter the text ID from the HR Text Catalog for the status message. |
| Description Text ID | If you selected <i>Display Description</i> or <i>Both</i> in the Display Option field, enter the text ID from the HR Text Catalog for the description. |

Configure Country Take Setup - Configurations Page

Use the Configure Country Take Setup - Configurations page (GP_ABS_ELIG5_SS) to link configurable section templates to extended absence components and define access to the templates.

Navigation:

Set Up HCM > Product Related > Global Payroll & Absence Mgmt > Absence Management > Configure Country Take Setup > Configurations

This example illustrates the fields and controls on the Configure Country Take Setup - Configurations page.

Configure Country Take Setup

Absences
Date Rules
User Fields
Forecasting Messages
Configurations

Country USA

Absence Take KOWAT VAC TAKE

United States

Vacation

Self Service Rules 1 of 1

Effective Date 01/01/1990 Status Active

Configurable Sections 1-1 of 1

| *Component Name | *Template | *Authorization |
|-----------------|-----------|----------------|
| | | |

| Field or Control | Description |
|-------------------------|---|
| Component Name | Select an extended absence component that will link to a configurable section page to link to the configurable section template. |
| Template | Select a defined configurable section template. |
| Authorization | Select the access mode used by the extended absence request to access the configurable section template. The values are <i>Full Edit</i> and <i>Display</i> . |

In order to display configurable section information for user self-service, link the configurable section templates you created to each of the extended absence components you are using. Then specify the desired type of user access to the displayed configurable section page.

For example, using the information shown in the Configurations page graphic, when a user accesses the GP_ABS_EA_EEREQ extended absence component, using the Cayman Islands FMLA maternity absence take, the GP_ABS_FMLA_ELG template specifies the composition of the displayed configurable section page. The users accessing the configurable section page have full edit access on the displayed page.

Defining Forecasting Rules for Self Service Absence Requests

To define rules for using the self service Forecasting and Balance Inquiry processes, use the Forecasting (GP_ABS_SS_FCST) component.

Pages Used to Define Self Service Forecasting Rules

| Page Name | Definition Name | Usage |
|-----------------------------|------------------------|---|
| <u>Forecasting Page</u> | GP_ABS_TAKE6 | Specify which forecasting result elements to display in the Forecasting Results grid. Also specify whether to display a customized label from the HR Text Catalog as the description or the element description as defined on the Element Name page (GP_PIN). |
| <u>Balance Inquiry Page</u> | GP_ABS_TAKE7 | Specify which entitlement balances the Balance Inquiry process is to display and whether to display a customized label from the HR Text Catalog as the description or the element description as defined on the Element Name page (GP_PIN). |

Forecasting Page

Use the Forecasting page (GP_ABS_TAKE6) to specify which forecasting result elements to display in the Forecasting Results grid.

Also specify whether to display a customized label from the HR Text Catalog as the description or the element description as defined on the Element Name page (GP_PIN).

Navigation:

Set Up HCM > Product Related > Global Payroll & Absence Mgmt > Absence Management > Configure Absence Forecasting > Forecasting

This example illustrates the fields and controls on the Forecasting page.

This page displays the forecasting rules defined for a Take element on the Absence Take - Forecasting page. The Forecast Element field at the top of the page shows the formula that the system resolves during the Forecasting process. The Forecasting Results Element List grid shows what appears on the Absence Forecast Results page (in the Absence Event Entry component) after you run the Forecasting process. You can have all or a subset of these results display to self service users after they run the forecasting process.

Note: To enter information on this page, the Allow Forecasting check box must be selected on the Forecasting Messages page, as well as the Forecasting Used check box on the Absence Take definition page.

| Field or Control | Description |
|-------------------------|--|
| Self Service | Select to have the forecasting results for this element display to self service users. |
| Label | Specify the label for the Forecast element that displays in self service. If no label is specified, it will display the element's description. |

Related Links

[Configure Country Take Setup - Forecasting Messages Page](#)

Balance Inquiry Page

Use the Balance Inquiry page (GP_ABS_TAKE7) to specify which entitlement balances the Balance Inquiry process is to display and whether to display a customized label from the HR Text Catalog as the description or the element description as defined on the Element Name page (GP_PIN).

Navigation:

Set Up HCM > Product Related > Global Payroll & Absence Mgmt > Absence Management > Configure Absence Forecasting > Balance Inquiry

This example illustrates the fields and controls on the Balance Inquiry page.

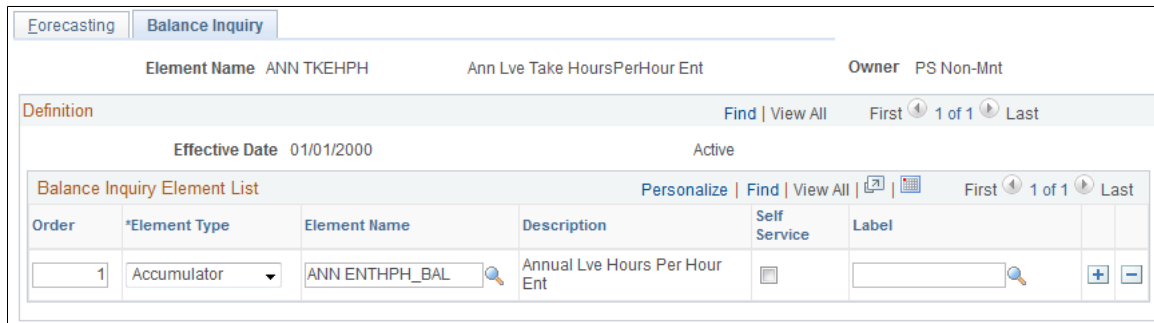

This page is similar in function to the Forecasting page but applies to rules for the Balance Inquiry process.

Reviewing System Generated Forecasting Error Status Messages

The following table provides a list of system generated error messages that appear when the Forecast Balance process ends in error. Absence and system administrators use this information to manage the absence forecasting functionality when message errors appear.

Note: These messages are formatted differently depending on the component where they appear, either Absence Administrator pages or Absence Self Service pages. Use Absence Administrator pages (Absence Event Entry and Review Absence Balances) if you need additional information to resolve any of these error messages.

| Message ID | Functional | Technical |
|-------------------------|--|--|
| 471 - MSGID-NO-TXN-DATA | No Forecast Transaction Row (GP_TXN_DATA). This row is inserted by push button PeopleCode. | Transaction record is missing. Select on PS_GP_TXN_DATA matching on TXN_ID, TXN_NUM returns no rows. This would be due to a problem in the PeopleCode or with the data input if running GPPOLRUN manually either from DOS or from Animator. Not likely to occur online unless bug in PeopleCode. |

| Message ID | Functional | Technical |
|------------------------------|---|---|
| 472 - MSGID-INVALID-TXN-DATA | Invalid data on the forecast transaction row (GP_TXN_DATA). One or more of the following fields are missing from this record: OPRID, BATCH_RUN_ID, CAL_RUN_ID, EMPLID, or COUNTRY. | Transaction record data is invalid. A row exists on PS_GP_TXN_DATA matching TXN_ID, TXN_NUM but one or more of the other fields is blank (OPRID, BATCH_RUN_ID, CAL_RUN_ID, EMPLID, COUNTRY). Not likely to occur online unless bug in PeopleCode. |
| 473 - NO-TXN | No Forecast Transaction Definition (GP_TXN). Please add a Transaction Definition for the TXN_ID and COUNTRY listed. Main Menu > Set Up HCM > Product Related > Global Payroll & Absence Mgmt > Elements > Absence Forecast Transactions. Transaction ID = 100 for Absence Forecasting and 110 for Balance Forecasting. | Transaction definition is missing. Select on PS_GP_TXN matching TXN_ID returns no rows. This is a data set up issue. Not likely to occur as the definition is required for the online transaction. |
| 474 - INVALID-TXN | Invalid Forecast Transaction Definition Data (GP_TXN). The Calendar Group ID (the forecast calendar template) is missing. When adding a new Absence Forecast Transaction, please make sure that you are associating the correct Calendar Template. Also make sure the template contains all the calendars and dates that you want to forecast for all the employee/pay groups that you want to make forecasting available to. | Transaction definition is invalid. A row exists on PS_GP_TXN matching TXN_ID but CAL-RUN-ID-TMPLT is blank. This is a data setup issue. It is also unlikely to occur. |
| 475 - OL-RUNCTL-MISSING | Run Control Missing for Forecast Process (GP_RUNCTL). This is inserted by the push button PeopleCode. | Run Control is missing. Select on PS_GP_RUNCTL matching on OPRID and RUN_CNTL_ID returns no rows. This would be due to a problem in the PeopleCode or with the data input if running GPPOLRUN manually either from DOS or from Animator. Not likely to occur online unless bug in PeopleCode. |
| 476 - INVALID-RUNCTL | Invalid Run Control (GP_RUNCTL). The Calendar Group ID is missing. The Run Control was inserted by push button PeopleCode. | Run Control data is invalid. A row exists on PS_GP_RUNCTL matching OPRID and RUN_CNTL_ID but CAL_RUN_ID is blank. Not likely to occur online unless bug in PeopleCode. |

| Message ID | Functional | Technical |
|----------------------|---|--|
| 477 - NO-EVENT | No Absence Events exist to forecast for this employee. This error is not likely to happen in self service because at least one event will exist when forecasting from absence self service. | There are no absence events for this employee. This is indicated if no rows are returned for a SELECT against GP_ABS_EVENT looking for the min (bgn_dt) and max (end_dt) (for non voided events only). This could happen if forecasting and only voided events exist. It wouldn't happen if you forecast after creating or modifying an event. |
| 478 - SQL-ERROR | SQL Error During Absence Forecasting. This type of error is not likely to happen unless there is a conflict in the database. Please contact your system or database administrator. | For each call to PTPSQLRT, there is the potential that an SQL-ERROR could occur for either the Select or the Fetch. This is set in the ZZ000-SQL-ERROR section. This requires system administrator intervention. |
| 479 - NO-PAYEE-ERROR | Forecasting Completed Successfully! No Errors were found. | Forecasting Completed Successfully! The forecasting process ended with no errors. In self service a 479 message/status is also used when you decide to display customized messages instead of the default "Success" message (Country Take setup). |
| 480 - PAYEE-ERROR | Forecasting Completed With Errors! This type of error requires checking for more details in the Forecast Messages tab in Absence Event Entry. There are different possible causes for this error, and therefore you need to verify the detail of each message produced by the error handling modules. | Indicates somewhere in one of the called COBOL modules a payee error was encountered. Select on PS_GPXPYE_SEG_STAT record where CALC_ACTION='C' and PYE_CALC_STAT in ('00','02','03','04','05'). This requires system administrator intervention. |

| Message ID | Functional | Technical |
|----------------------------|--|---|
| 481 - NO-CAL-RUN-DTL | <p>The Calendar Group ID (Template) does not cover the forecasting period. As a result, there are no calendars to process. Please add calendars to your Calendar Group ID (that is the template) to cover the forecast period.</p> | <p>The online transaction record and run control record are created via the online Peoplecode. Once they are selected and validated, GPPOLRUN determines the forecast period and creates a GPXCAL_RUN_DTL for each calendar to be processed in forecasting. In order to control which calendars to run, only those unfinalized calendars for the employee's pay group from the template whose period begin and end dates fall within the FCST period begin and end date are inserted into GPXCAL_RUN_DTL selecting data from the corresponding "real" GP_CAL_RUN_DTL for that matching CAL_ID and GP_PAYGROUP.</p> <p>If on a subsequent select of that GPXCAL_RUN_DTL matching on CAL_RUN_ID, no records are selected, then Message #481 - NO CAL RUN DTL is generated. If none are present, that means the template for the employee's pay group does not match up with the forecast period. This could occur if the template includes calendars for several pay groups but the necessary calendar for the pay group of the employee to process this event is missing. For example Pay Group A has Jan-Dec 04 calendars. Pay Group B has Mar-Dec 04 calendars. Employee from pay group B has event in February only. This error would be generated.</p> |
| 482 - INVALID-TXN-DATA-BAL | <p>Invalid data on the forecast transaction row (GP_TXN_DATA). One or more of the following fields are missing from this record, the forecast as of date (FCST_ASOF_DT), or the take element (PIN_FCST_TAKE_NUM).</p> | <p>Balance Inquiry only. A row exists on PS_GP_TXN_DATA matching TXN_ID, TXN_NUM but either FCST_ASOF_DT is spaces or PIN_FCST_TAKE_NUM is zero. Not likely to occur online unless bug in PeopleCode.</p> |
| 483 - NO-EVENTS-TO-FCST | <p>No Events to Forecast. The Forecast End Date is <= Period End Date of the last finalized absence calendar. The forecast end date is for absence forecasting equal to the maximum event end date. For absence balance forecasting the forecast end date is equal to the "as of date."</p> | <p>Consider all events are processed versus one or more new events entered retroactively. If FCST-END-DT < PRD-END-DT, this could occur if the end date of all the employee's absence events are within a finalized calendar, if an absence event is entered for a calendar period that has already finalized, or if the As of Date of Balance Inquiry is within a finalized calendar. The employee should look at the list of their current balances instead.</p> |

| Message ID | Functional | Technical |
|-------------------------------|---|---|
| 484 - ASOF-DT-BEFORE-TEMPLATE | The Calendar Group ID (Template) does not cover the forecasting period. The As of Date must be greater than or equal to the earliest Begin Date of the calendar periods associated with the Calendar Group used as the template for Forecasting. Using the Calendar Group ID component, please add calendars to your template for the period in which you want to forecast. | This could occur if the As of Date of Balance Inquiry is greater than the period end date of the last finalized calendar and is less than the min (period begin date) of the calendars on the template: EVENT-BGN-DT > PRD-END-DT and EVENT-BGN-DT < TMPLT-BGN-DT. This could also occur if the As of Date of Balance Inquiry is less than the min (period begin date) of the calendars on the template: EVENT-BGN-DT < TMPLT-BGN-DT. |
| 485 - NO-TMPLT-CALENDARS | No Calendars were found for the template. Using the Calendar Group ID component, please add calendars to your template for the period in which you want to forecast. | The calendar detail corresponding to the calendars on the template are missing or the dates are missing. This is indicated by a SELECT on a join of GP_CALENDAR, GP_CAL_DTL and GP_CAL_PRD for the CAL_RUN_ID from the run control. This is a data setup issue that requires system administrator intervention. |
| 486 - INVALID-ASOF-DT | Balance Forecast As Of Date falls within an Absence Begin and End Date. Please select an As Of Date Before or After the Absence Event Begin/End Date. | Forecast Balance only. The Forecast Balance As of Date falls in the middle of an existing absence event. The reason this is an issue is that the design for Balance Inquiry includes creating a temporary “dummy” event for begin data/end date = As of Date. This causes issues with the rule that there cannot be two events for the same take on the same day and therefore the current Absence architecture and coding do not support that. A specific SQL against GP_ABS_EVENT looking for this situation is issued in GPPOLRUN. |
| 487 - EVENTS-BEFORE-TEMPLATE | The Calendar Group ID (Template) does not cover the forecasting period. The event begin date must be greater than or equal to the earliest Begin Date of the calendar periods associated with the Calendar Group used as the template for Forecasting. Using the Calendar Group ID component, please add calendars to your template for the period in which you want to forecast. | This could occur if the min (bgn_dt) of all the employee’s absence events is greater than the period end date of the last finalized calendar and is less than the min (period begin date) of the calendars on the template: EVENT-BGN-DT > PRD-END-DT and EVENT-BGN-DT < TMPLT-BGN-DT. This could also occur if there are NO finalized calendars on the template and the min (bgn_dt) of all the employee’s absence events is less than the min (period begin date) of the calendars on the template: EVENT-BGN-DT < TMPLT-BGN-DT. |

| Message ID | Functional | Technical |
|------------------------------|---|---|
| 488 - ASOF-DT-AFTER-TEMPLATE | The Calendar Group ID (Template) does not cover the forecasting period. The As of Date must be less than or equal to the maximum End Date of the calendar periods associated with the Calendar Group used as the template for Forecasting. Using the Calendar Group ID component, please add calendars to your template for the period in which you want to forecast. | This could occur if the As of Date of Balance Inquiry is greater than the max (period end date) of the calendars on the template: FCST-END-DT > TMPLT-END-DT. This could also occur if there are NO finalized calendars on the template and if the As of Date of Balance Inquiry is greater than the max (period end date) of the calendars on the template: EVENT-END-DT > TMPLT-END-DT. |
| 489 - EVENTS-AFTER-TEMPLATE | The Calendar Group ID (Template) does not cover the forecasting period. The event end date must be less than or equal to the maximum End Date of the calendar periods associated with the Calendar Group used as the template for Forecasting. Using the Calendar Group ID component, please add calendars to your template for the period in which you want to forecast. | This could occur if the max (end_dt) of all the employee's absence events is greater than the max (period end date) of the calendars on the template: FCST-END-DT > TMPLT-END-DT. This could also occur if there are NO finalized calendars on the template and the max (end_dt) of all the employee's absence events is greater than the max (period end date) of the calendars on the template: EVENT-END-DT > TMPLT-END-DT. |
| 490 - EVENT-NOT-FCSTD | No events were forecasted. One possible cause is that the Calendar Group ID (Template) does not cover the forecasting period. As a result, there are no calendars to process. Review and add calendars to your Calendar Group ID (the template) to cover the forecast period. Another possible cause is that the date range entered for forecasting cover periods already processed and finalized. Forecasting only processes from last finalized period going forward. | The conditions detected in GPPOLRUN are "generic" in nature. It can't detect everything without knowing more about the processing that will occur during batch. Therefore it's possible that an event is entered and passes the GPPOLRUN checks and then goes on to batch processing. If for example there are calendars for pay group A for all of 2004 but calendars only for Feb-Dec of 2004 for pay group B, then an event entered for an employee in pay group B for January won't get caught by the GPPOLRUN edits but that event won't get processed because pay group B January calendar was not processed. This is one example where the error #490 comes into play – No events were forecasted. This is different than 477 – No events. |

Viewing or Modifying Text on Self Service Absence Pages

You can use the Text Catalog feature to modify field labels, button text, and text that appears elsewhere on the self service absence pages.

Related Links

[Viewing Daily Results of the Absence Take Process](#)

“Configuring the Text Catalog” (Application Fundamentals)

Delivered Text Catalog Entries for Absence Management

The step to view delivered text catalog entries for Absence Management are:

- Navigate to the Maintain Text Catalog page. (**Set Up HCM > Common Definitions > Text Catalog and Notepad > Maintain Text Catalog**)
- Enter *HGA* in the Object owner identifier field.
- Click Search to view the list of text catalogs for Absence Management.

See “Configuring the Text Catalog” (Application Fundamentals).

Entering and Approving Self Service Absence Requests

Understanding the Absence Request Transactions

Using self service transactions, employees and managers can submit absence requests, forecast absence entitlement balances, and carry out other common tasks using the Self Service pages in Absence Management.

Self service options differ for employees and managers.

| <i>Role</i> | <i>Absence Self Service Options</i> |
|-------------|---|
| Employee | <ul style="list-style-type: none"> • Add, edit, forecast, submit, save for later and cancel absence request. <hr/> <p>Note: You can only edit, forecast, and cancel absence requests entered using absence self-service.</p> <hr/> <ul style="list-style-type: none"> • View absence requests details, with their approval status. • View absence events entered by the Absence Administrator. • View absence events entered in Timesheets. • View absence entitlement balances for the current period. • View absence entitlement balances as of a future date. • View the employee's monthly schedule for past and future months. |
| Manager | <ul style="list-style-type: none"> • Perform all employee self service absence functions on behalf of direct reports. • View a list of absence requests for direct reports. • Forecast an absence request in order to approve it (optional). • Approve, deny, or push back absence requests submitted by direct reports. • View a monthly calendar for direct reports. |

Related Links

[Entering Maintaining and Approving Absence Events](#)

Managing Employee Self Service Pages

Self Service Pages Used by Employees to Manage Absence Requests

| <i>Page Name</i> | <i>Definition Name</i> | <i>Usage</i> |
|--|------------------------|---|
| Request Absence Page | GP_ABS_SS_REQUEST | Request absence based on the start date of the absence event. |
| Monthly Schedule Page | SCH_EE_MONTHLY | Employees view their schedule for a one month period for any past or future month. |
| View Absence Balances Page | GP_ABS_SS_BALANCES | This page includes links to pages to request absence, view absence requests, view monthly schedule, and forecast balances. |
| Absence Request History Page | GP_ABS_SS_REQHIST | View processed or pending absence events based on the specified date range. |
| Request Details Page | GP_ABS_SS_REQSTAT | View details for a specific absence request. |
| Cancel Absence Page | GP_ABS_SS_REQUEST | Submit a request for an absence cancelation. |
| Forecast Balance Page | GP_ABS_SS_FCST_BAL | Run the online forecasting process for future absence entitlement balances based on date, absence type and absence name. |
| Select Job Page | HCM_JOB_SELECT | Employees with multiple jobs use this page to select the job for which they want to enter or review a self service absence transaction. |

Request Absence Page

Use the Request Absence page (GP_ABS_SS_REQUEST) to request absence based on the start date of the absence event.

Navigation:

Self Service > Time Reporting > Report Time > Absence Request > Request Absence

This example illustrates the fields and controls on the Request Absence page.

Request Absence

Danilo Travanti
Bus Person

Instructions

Enter Start Date and Absence Name. Then complete the rest of the required fields before submitting or save for later your request.

Absence Detail ?

* Start Date [x]

End Date [x]

Filter by Type

* Absence Name

* Reason

Partial Days

Duration Hours

[View Monthly Schedule](#)

Current Balance 32.00 Hours**

Calculate End Date or Duration
Forecast Balance

Additional Information

Health Care Provider

Copayment

PCP

Comments

Requestor Comments

Go To [View Absence Request History](#)

[View Absence Balances](#)

[Return to Job List](#)

Note: When you access this page and you have multiple jobs, the system displays the Select Job page so you can select the job for which you are requesting absence.

The Request Absence page consists of three group boxes: Absence Detail, Additional Information, and Comments. The available fields in the Additional Information group box depend on how your organization sets up self service for Absence Management.

Absence Detail

| <i>Field or Control</i> | <i>Description</i> |
|-------------------------|--|
| Start Date | Select the first day of the absence event. The field option defaults to the current date. If there's a break in the absence, enter each event separately. For example, if you're out sick for two days, return to work for three days, and are out sick again, enter two absence events. If the absence includes a weekend (say, Thursday to Monday), enter one absence event. |

| Field or Control | Description |
|----------------------------|--|
| End Date | <p>Select the last day of the absence event. If you leave this field empty and the Calculate End Date option on the Configure Country Take Setup - Date Rules Page is selected, the system automatically determines the end date based on the begin date, duration, and partial days options.</p> |
| Original Start Date | <p>Select the original start date of the absence event. Enter a date if the absence has legal or payment implications based on the original start date of the absence.</p> <p>This field is visible when Display Original Begin Date is selected on the Configure Country Take Setup - Absences Page.</p> <p>For example, an employee has a leg injury. He reports an absence from January 3, 2005 to January 7, 2005. The employee starts to feel better and returns to work. Later, he has a relapse and has to take two more days of absence starting on January 17, 2005 to January 18, 2005. The original begin date for the second absence should be January 3, 2005. The system can link the two events and treat the event as a single one in terms of eligibility or a minimum waiting period.</p> <hr/> <p>Note: Careful consideration is needed when enabling this field in self-service. Incorrect data entered in this field might lead to incorrect eligibility calculations and payment for one or more events.</p> <hr/> |
| Filter by Type | <p>Select the absence type. The selection you make in this field will limit or filter the selections available in the Absence Name field.</p> |
| Absence Name | <p>Select the absence name from the available options. The options available depend on the selection in the Filter by Type field, the absence takes that are enabled in the Country Take setup, and the elements for which the employee is eligible.</p> <p>After you select entries in the above fields, the system refreshes the page with additional fields.</p> <hr/> <p>Note: If you decide to change the Absence Name previously selected, the system will display a warning that all your existing absence data will be lost.</p> <hr/> <p>See Element EligibilityElement Resolution.</p> |

| <i>Field or Control</i> | <i>Description</i> |
|--------------------------------|---|
| Reason | <p>Select a reason from the available options. The reasons available depend on your selections in the previous fields.</p> <p>Absence reasons are linked to the Absence Name (Take) through the Absence Take Type.</p> <p>See Defining Absence Types and Reasons.</p> |

| Field or Control | Description |
|-------------------------|---|
| Partial Days | <p>Specify which days of the absence event are partial days.</p> <p>If the Calculate End Date or Duration option is enabled on the Absence (setup) page, and the Unit Type is <i>Hours</i>, the system does consider any partial hours or half-day entries that are entered in this group box when it calculates the end date or duration.</p> <p>For example, an employee has a work schedule of 8 hours per day from Monday through Friday. The employee reports an absence from Monday, January 8, 2007 through Wednesday, January 10, 2007. Then employee takes a half day off on Monday and full days off for the rest of the absence.</p> <p>Example 1: The Country Take set up is defined as follows:</p> <ul style="list-style-type: none"> • Unit Type = <i>Hours</i>. • Allow Partial Days = Selected. • Partial Days = <i>Partial Hours</i>. <p>With these settings, to correctly enter the absence data the employee should report:</p> <ul style="list-style-type: none"> • Start Date = <i>January 8, 2007</i>. • End Date = <i>January 10, 2007</i>. • Partial Days = <i>Start Day Only</i>. • Start Day Hours = <i>4</i>. <p>Example 2: The Country Take set up is defined as follows:</p> <ul style="list-style-type: none"> • Unit Type = <i>Hours</i>. • Allow Partial Days = Selected. • Partial Days = <i>Half Days</i>. <p>With these settings, to correctly enter the absence data the employee should report:</p> <ul style="list-style-type: none"> • Start Date = <i>January 8, 2007</i>. • End Date = <i>January 10, 2007</i>. • Partial Days = <i>Start Day Only</i>. • Start Day is Half Day = Selected. |

| Field or Control | Description |
|---|---|
| | <p>Note: Data that you enter in the following fields is used in the absence calculation process only if the data is referenced by your absence formulas.</p> <hr/> <p>The available options in the Partial Days field when the absence is calculated in days include:</p> <ul style="list-style-type: none"> • <i>All Days</i> • <i>End Day Only</i> • <i>None</i> • <i>Start Day Only</i> • <i>Start and End Days</i> |
| Start Day Hours, End Day Hours, and All Day Hours | <p>Enter the number of hours the payee was absent for the first day of the absence, the last day of the absence, or all days of the absence, respectively.</p> |
| All Days are Half Days, Start Day is Half Day, and End Day is Half Day | <p>Select to specify which days of the absence event are half days.</p> <hr/> <p>Important! These fields are not available unless the Country Take enables you to specify partial days on the Request Absence page.</p> <hr/> |
| Duration | <p>Enter Duration by days or hours. You do not have to enter Duration if the Calculate Duration is enabled on the Absence (setup) page). The system calculates the duration of the absence in hours or days when you click the Calculate Duration button.</p> <p>The behavior of this field depends on the settings on the Absence (setup) page. The value is automatically calculated if the Calculate End Date option is selected.</p> <ul style="list-style-type: none"> • If the absence is measured in days or hours, the system automatically calculates the duration when you enter the begin date and end date. • If you want to calculate the end date based on a duration, then the system calculates the end date when you enter the begin date and duration and you click the Calculate End Date button. |

| Field or Control | Description |
|---------------------------------------|---|
| Calculate End Date or Duration | <p>Click this button to have the system calculate the end date of an absence event based on the entries in the Start Date and Duration fields, or to calculate the Duration based on entries in the Start Date and End Date fields.</p> <hr/> <p>Note: If you selected to calculate end date and duration in the Country Take — Date Rules page, then you had to indicate which field to recalculate when both fields contain values. Hence if the user entered values for duration and end date and clicks Calculate End Date or Duration button, one of the fields will be recalculated.</p> |
| Forecast Balance | <p>Click this button to run the online absence forecasting process for the type of absence take selected for this absence request. This button will appear only for those absence names that require forecasting. After the forecasting process is completed, the page will display the <i>Forecast Returned Value</i> and <i>Status</i> and a link View Forecast Details to access the list of the forecast balance details.</p> <hr/> <p>Note: The system does not automatically save your absence request before initiating the Forecasting process. Although the system prompts you to save before leaving the page, it is not necessary to save your forecast information before or after the Forecasting process.</p> |
| Save for Later | <p>This option allows the employee to save the absence event information for later review and editing, and does not generate workflow for the approvals process.</p> |
| Submit | <p>This option saves the information and generates the workflow approval process that routes the request to one or more managers whose roles are defined in workflow to enable them to approve, deny, or push back the absence request to the previous approval level with comments. The push back is often used by approvers to suggest absence request revision or to obtain additional information.</p> |
| Cancel | <p>This option is available only for requests that have been saved for later or that were pushed back from the approver. Depending on the Country Take setup, when you click Cancel the application either physically deletes the request from request and workflow records, or sets the status of the request to cancelled.</p> |

| Field or Control | Description |
|-------------------------------------|---|
| View Absence Request History | <p>Click to access a modal version of the Absence Request History Page.</p> <hr/> <p>Note: You cannot edit absences through the modal version of the Absence Request History page. To edit an absence from the Absence History page, you must navigate to it directly (Self Service > Time Reporting > View Time > Absence History).</p> <hr/> |
| View Absence Balances | Click to access a modal version of the View Absence Balances Page . |
| Return to Job List | Click to go back to the Select Job page so you can enter an absence request for a different job. |

Additional Information

The fields that appear in this group box depend on how Absence Management is configured during the implementation process.

Comments

The **Requestor Comments** field enables the employee to enter free form text related to the absence request that becomes part of the record and is visible throughout the approval process. Comments display on the Absence Details page.

Monthly Schedule Page

Use the Monthly Schedule page (SCH_EE_MONTHLY) to employees view their schedule for a one month period for any past or future month.

Navigation:

Click the **View Monthly Schedule** link on the Absence Request page.

This example illustrates the fields and controls on the Monthly Schedule page.

My Schedule

Monthly Schedule

Danilo Travanti Employee ID K0W002

Job Title

Previous Month 2016 Next Month

| Sunday | Monday | Tuesday | Wednesday | Thursday | Friday | Saturday |
|--------|-----------------------------|-----------------------------|-----------------------------|-----------------------------|-----------------------------|----------|
| | K08HRS 1 8:00AM- 5:00PM | K08HRS 2 8:00AM- 5:00PM | K08HRS 3 8:00AM- 5:00PM | K08HRS 4 8:00AM- 5:00PM | K08HRS 5 8:00AM- 5:00PM | OFF 6 |
| OFF 7 | K08HRS 8 8:00AM- 5:00PM | K08HRS 9 8:00AM- 5:00PM | K08HRS 10 8:00AM- 5:00PM | K08HRS 11 8:00AM- 5:00PM | K08HRS 12 8:00AM- 5:00PM | OFF 13 |
| OFF 14 | K08HRS 15 8:00AM- 5:00PM | K08HRS 16 8:00AM- 5:00PM | K08HRS 17 8:00AM- 5:00PM | K08HRS 18 8:00AM- 5:00PM | K08HRS 19 8:00AM- 5:00PM | OFF 20 |
| OFF 21 | K08HRS 22 8:00AM- 5:00PM | K08HRS 23 8:00AM- 5:00PM | K08HRS 24 8:00AM- 5:00PM | K08HRS 25 8:00AM- 5:00PM | K08HRS 26 8:00AM- 5:00PM | OFF 27 |
| OFF 28 | K08HRS 29 8:00AM- 5:00PM | K08HRS 30 8:00AM- 5:00PM | K08HRS 31 8:00AM- 5:00PM | | | |

Legend

Approved Training Planned Absence Holiday OFF Scheduled OFF Day

Employees can view their schedule for one month in the future or past by using the available options in the month and year fields. Click the **Previous Month** and **Next Month** buttons to view previous or subsequent months, respectively.

For employees with multiple jobs, the **Select Job Title** field appears on this page.

See [Select Job Page](#).

View Absence Balances Page

Use the View Absence Balances page (GP_ABS_SS_BALANCES) to this page includes links to pages to request absence, view absence requests, view monthly schedule, and forecast balances.

Navigation:

Self Service > Time Reporting > View Time > Absence Balances > View Absence Balances

This example illustrates the fields and controls on the View Absence Balances page.

View Absence Balances

Danilo Travanti
Sales Manager

View current absence entitlement balances. Current balances do not reflect absence requests that have not been processed by payroll. For more details please contact your absence administrator.

| Absence Entitlement Balances Personalize | | | | |
|--|--------------------------|--------------------|------------|----------------|
| Current Balances | Entitlement Keys 1 | Entitlement Keys 2 | | |
| Entitlement Name | Balance as of 12/31/2004 | From | To | Accrual Period |
| Vacations Balance Hrs | 103.99 Hours | 01/01/2004 | 12/31/2004 | Year to Date |
| Sick Balance Hrs | 96.00 Hours | 01/01/2004 | 12/31/2004 | Year to Date |

Go To [Forecast Balance](#)
[Return to Job List](#)

This page contains the following links:

- [Forecast Balance.](#)

This is a link to the Forecast Balance page.

- [Return to Job List.](#)

This is a link to the Select Job page for employees with multiple jobs.

See [Select Job Page](#).

Note: If you are integrating with Time and Labor, absence entitlement balances can be viewed on the Timesheet page.

See “Reporting Time” (PeopleSoft Time and Labor).

Related Links

[Request Absence Page](#)

[Absence Request History Page](#)

[View Absence Balances Page](#)

Absence Request History Page

Use the Absence Request History page (GP_ABS_SS_REQHIST) to view processed or pending absence events based on the specified date range.

Navigation:

Self Service > Time Reporting > View Time > Absence History > Absence Request History

This example illustrates the fields and controls on the Absence Request History page.

Absence Request History

Danilo Travanti
Sales Manager

Instructions

Specify the date range of interest. To retrieve a complete history, leave From and Through dates blank and select the Refresh button. Select the absence name link to view request details. select edit button to modify or delete the text

From

Through

Refresh

| Absence Request History | | | | | | Personalize Find View All | First | 1-3 of 3 | Last |
|--------------------------|----------|------------|------------|----------|--------------------------|-------------------------------------|---------------------------------------|----------|------|
| Absence Name | Status | Start Date | End Date | Duration | Requested By | Edit | Cancel | | |
| Vacation | Approved | 09/05/2016 | 09/09/2016 | 40 Hours | Employee Absence Request | <input type="button" value="Edit"/> | <input type="button" value="Cancel"/> | | |
| Sick | Approved | 08/05/2016 | 08/05/2016 | 8 Hours | Employee Absence Request | <input type="button" value="Edit"/> | <input type="button" value="Cancel"/> | | |
| Jury | Approved | 06/13/2016 | 06/14/2016 | 2 Days | Employee Absence Request | <input type="button" value="Edit"/> | <input type="button" value="Cancel"/> | | |

[Return to Job List](#)

This page displays all absence requests for the employee. Absence requests entered by the employee contain a link in the Absence Name column. Absences that are entered by the Absence Administrator through the Absence Event Entry component do not have a link in the **Absence Name** column, nor a Status and Duration value. The employee can edit absences requests that are saved, but not yet submitted, by clicking the **Edit** button in the Edit column. The employee also can edit absence requests that have been, cancelled or denied by clicking the **Edit** button.

Absence requests or any absence entered or modified via Timesheets or by the Absence Administrator using the Absence Event Entry component can not be edited in Absence self-service.

Note: If the absence was requested by the manager as an employee, the Requested By column will display Manager.

| Field or Control | Description |
|-------------------------|---|
| From and Through | <p>The user can display absence request that fall within a specified date range by entering dates in the From: and Through: fields. If the employee enters a date in only the From field, the system displays absence requests that have a Start Date equal to or after the specified date. Alternatively, if the employee enters a date only in the Through: field, the system displays absence requests that have an End Date equal to or prior to the specified date. If no date is entered in either field, the system displays all absence requests for the employee.</p> <p>The From and Through date range is determined by the Default History Date Range values entered on the History Grid page of the Country component. If the Default History Date Range has not been set up, the system will use the defaults of current date – 90 days for the From date field and current date + 90 days for the Through date field.</p> |

See [Defining Self Service Absence Rules by Country](#).

| <i>Field or Control</i> | <i>Description</i> |
|-------------------------|--|
| Refresh | Click the Refresh button after entering, changing, or removing dates in the From: and Through: fields. |

| <i>Field or Control</i> | <i>Description</i> |
|-------------------------|---|
| Edit | <p>This button is available for absence requests with a status of saved, cancelled, or denied. When you click this button the Request Absence page is opened.</p> <hr/> <p>Note: This button is not available on the modal version of this page.</p> <hr/> |
| Cancel | Click to access the Cancel Absence page where you can submit an absence cancellation request. |

See [Request Absence Page](#).

The Absence Request History group box contains **Absence Name**, **Status**, **Start Date**, **End Date**, **Duration**, and **Requested by**. You can sort the rows by any of these criteria by clicking the column heading.

Note: The system calculates and stores duration values for absence requests entered through Absence self-service or Timesheets only. The system does not calculate or store absence duration for absences entered or modified through other online pages such as Absence Event Entry or through Component Interface.

Related Links

[Entering Maintaining and Approving Absence Events](#)

Request Details Page

Use the Request Details page (GP_ABS_SS_REQSTAT) to view details for a specific absence request.

Navigation:

Click the link for the absence in the **Absence Name** column on the Absence Request History page.

This example illustrates the fields and controls on the Request Details page.

The screenshot displays the 'View Request Detail' page. At the top, there is a breadcrumb 'View Request Detail' and a link for 'Absence Request History'. The main section is titled 'Request Details' and features a profile card for Danilo Travanti, Sales Manager. Below this is an 'Instructions' section with a dropdown arrow and the text 'View Request Status and Approval Details'. The 'Details' section contains the following information: Start Date 06/13/2016, End Date 06/14/2016, Absence Name Jury, Reason Jury Duty, Duration 2.00 Days, and Status Approved. An 'Additional Information' section shows fields for Regional Office, District, and County. The 'Request History' section includes a table with columns for Approval Process, Status, Name, Date, and Comments. Below the table is an 'Abs Mgmt By Supervisor Id' section showing an 'Approved' status with a green checkmark and details for Antonio Smith on 08/09/16 from 4:54 PM. A 'Personalize' button and a 'First' dropdown are also visible in the Request History section.

Request Details

Instructions
View Request Status and Approval Details

Details

Start Date 06/13/2016
End Date 06/14/2016
Absence Name Jury
Reason Jury Duty
Duration 2.00 Days
Status Approved

Additional Information

Regional Office
District
County

Request History

| Approval Process | Status | Name | Date | Comments |
|------------------|-----------|-----------------|------------|----------|
| Absence Request | Submitted | Danilo Travanti | 08/09/2016 | |
| Absence Request | Approved | Antonio Smith | 08/09/2016 | |

Abs Mgmt By Supervisor Id

Absence Management: Approved

Abs Mgmt By Supervisor Id

Approved
Antonio Smith
Absence By SupervisorId
08/09/16 - 4:54 PM

[Return to Absence Request History](#)

The page displays information about the selected absence.

Note: If the absence was requested by the manager as an employee, then in the Request History section the employee's name will be displayed in the Name field.

Note: The approval path map and details is only displayed in the Absence Self Service applications. This path and details are not displayed in Timesheets self-service.

Cancel Absence Page

Use the Cancel Absence page (GP_ABS_SS_REQUEST) to submit a request for an absence cancellation.

Navigation:

Click the Cancel button for an absence on the Absence Request History page.

This example illustrates the fields and controls on the Cancel Absence page.

| Field or Control | Description |
|-------------------------|---|
| Cancel Reason | Select a reason for canceling the absence request. |
| Comments | Enter any additional comments regarding the absence cancellation. |
| Cancel Absence | Click this button to submit the request to cancel the absence. You will receive a message confirming that you want to submit the request to cancel the absence. Click Yes to confirm the request submittal. The system changes the status of the absence request to <i>Cancel in Progress</i> and routes it to your manager for approval. |

Forecast Balance Page

Use the Forecast Balance page (GP_ABS_SS_FCST_BAL) to run the online forecasting process for future absence entitlement balances based on date, absence type and absence name.

Navigation:

Click the **Forecast Balance** link on the View Absence Balances page.

This example illustrates the fields and controls on the Forecast Balance page.

[View Absence Balances](#)

Forecast Balance

Danilo Travantti
Sales Manager
Enter As of Date and Absence Name. Then select the Forecast Balance button.

Forecast Balance

As of Date

Filter by Type

*Absence Name Current Balance 103.99 Hours**

Completed Successfully!

Forecast Balance Details [Personalize](#)

[Forecast Results](#) | [Accumulator Results](#) | [User Keys 1-3](#) | [User Keys 4-6](#)

| Absence Name | Forecast Element | Value |
|--------------|---------------------------|----------|
| Vacations | Vacations Balance Hrs | 831.99 |
| Vacations | Vacations Taken Hrs | 0.00 |
| Vacations | Vacations Entitlement Hrs | 168.00 |
| Vacations | Generic Forecast Formula | ELIGIBLE |

[Return to View Absence Balances](#)

* Required Field

**Disclaimer The current balance does not reflect absences that have not been processed.

This page enables the employee to run the online absence entitlement balance forecast process, and to view entitlement balances as of a future date, by absence type, and absence name.

| Field or Control | Description |
|-------------------------|--|
| As of Date | Enter a future date that the system will use to calculate the balance. |
| Filter by Type | Select the absence type. The selection you make in this field will limit or filter the selections available in the Absence Name field. |

| Field or Control | Description |
|-------------------------|--|
| Absence Name | Select the absence name from the available options in the field. <hr/> Note: The user must make an entry in this field in order for the system to display the Forecast Balance button. |
| Forecast Balance | Click to run the online absence balance forecasting process. When the process is completed, the forecasted absence entitlement balances appear in the Forecast Balance Details group box. <hr/> Note: The system does not automatically save your absence request before initiating the Forecasting process. Although the system prompts you to save before leaving the page, it is not necessary to save your forecast information before or after the Forecasting process. |

Select Job Page

Employees with multiple jobs must select the job for which they are entering or reviewing self service absence transactions. The following page is an example of an employee with multiple jobs that is entering an absence request. A similar page with a modified title appears whenever this employee initiates any absence self service transaction.

Employees with multiple jobs use the Select Job page (HCM_JOB_SELECT) to select the job for which they want to enter or review a self service absence transaction.

Navigation:

Self Service > Time Reporting > Report Time > Absence Request

This example illustrates the fields and controls on the Select Job page for an absence request.

Select Job

Danilo Travantti

Currently, you hold multiple jobs - Please select the job for this transaction.

| Multiple Jobs | | | |
|--|----------------------|-----------------|---------------------------|
| Job Title | Department | Supervisor Name | Company |
| <input checked="" type="radio"/> Sales Manager | Sales Administration | Antonio Smith | Global Business Institute |
| <input type="radio"/> Bus Person | Business Services | Paul Harvest | Global Business Institute |

After the employee selects the job title, the processes are identical to those discussed in the previous sections.

Managing Employee Absences Through Time and Labor Self Service

Employees are able to enter absences and view absence entitlement balances using self service pages in Absence Management. Absence management self service pages are discussed in detail in this documentation.

Note: Absences entered through Time and Labor Timesheets are referred to as Absences or Absence Events. Absences entered through Absence Management are referred to as Absences or Absence Requests.

If you are integrating with Time and Labor you can enter absence events through the Timesheet page. Also, on this page you can view absence entitlement balances to ensure you have enough entitlement balance prior to entering the absence.

The following steps, completed during implementation, enable employees to access the Timesheet page to enter absences or view entitlement balances:

1. Ensure that Absence Management and Time and Labor are selected on the Installation Table.
See “Setting Up Implementation Defaults” (Application Fundamentals).
2. On the Absences page of the Country Take component ensure you have allowed entry in Time and Labor for the absence take elements you want to enter on the Timesheet page.
See [Understanding Self Service Setup Tasks](#).
3. Complete the required framework setup in Time and Labor in order to access employees via Timesheet.
See “Understanding the Time Reporting Process” (PeopleSoft Time and Labor).

The following steps discuss how an employee enters absences and views entitlement balances on the Timesheet page:

1. Access the Timesheet page by navigating to **Self Service > Time Reporting > Report Time > Timesheet** . Select the Time reporting period to work with.
2. Click the **Absence Event - click to view** link to add, edit, forecast or submit an absence request. For example to add a absence follow these steps:
 - a. Click **Add Absence Event** to add a new event or Edit to modify an existing event. You can add or edit only one single event at a time
 - b. Enter the **Start Date** and End Date if End Date field has been enabled for the absence. If end date field is left blank and is not calculated using Calculate End Date functionality, then it will be defaulted to Start Date when saving or submitting the event.

See [Defining Self Service Absence Rules by Country](#).

- c. Select the **Absence Name** from the available options. Valid values are the ones previously defined in the Country Take configuration page and based on the eligibility of the employee as of Time Reporting Period Start Date.

See [Defining Self Service Absence Rules by Country](#), [Element Eligibility](#), and [Element Resolution](#).

- d. If during implementation you have selected to display a reason on the Absences page of the Country Take component, enter the reason for the absence (if required).
- e. Click the **Details** link to access the Absence Request Detail (GP_ABS_SS_REQUEST) page to enter absence details and other information that might be required. Once all details are entered click **OK** to return to the Timesheet page.

Note: If an absence requires more information than the fields available in the Timesheet Absence grid (Start Date, End Date, Absence Name and Reason) then the system will automatically open the Absence Event Details page.

See [Request Absence Page](#).

- f. Optionally, forecast an absence balance before saving and submitting.
 - g. Save the absence for later or submit the absence for approval. You are able to delete a new absence before it has been saved or submitted, or cancel it after the absence has been saved or submitted.
3. Click the **Balances - click to view** link to view absence entitlement balances.

Note: The balances reflect the balances as of the last absence run.

Related Links

“Reporting Time” (PeopleSoft Time and Labor)

Managing Manager Self Service Pages

Self Service Pages Used by Managers to Manage Absence Requests

| <i>Page Name</i> | <i>Definition Name</i> | <i>Usage</i> |
|--|------------------------|--|
| Request Absence Page | HR_DR_DIRECTREPORT | Enter a date to use to generate a list of direct reports in which to request absences. |
| Request Absence Page | GP_ABS_SS_REQUEST | View a list of direct reports, select an employee, and enter an absence request on behalf of the employee. |
| Absence Request History Page | HR_DR_DIRECTREPORT | Enter a date to use a list of direct reports in which to view absence history. |

| Page Name | Definition Name | Usage |
|---|------------------------|--|
| Absence Request History Page | GP_ABS_SS_REQHIST | Managers use this page to view absence request information for direct and indirect reports. |
| <u>View Absence Balances Page</u> | HR_DR_DIRECTREPORT | Enter a date to generate a list of direct reports in which to view absence balances. |
| View Absence Balances Page | GP_ABS_SS_BALANCES | View absence balances for direct reports. |
| Forecast Balance Page | GP_ABS_SS_FCST_BAL | View the results of the Absence Forecasting process. |
| <u>Absence Requests Page</u> | GP_SS_ABS_APPR | Select the absence request to approve or deny. |
| Approve Absence Requests - Request Details Page | GP_ABS_SS_REQUEST | Used by the manager to approve, deny, or push back an employee absence request to the previous approval level. |
| <u>Absence Request History Page</u> | GP_ABS_SS_REQHIST | Review the absence request history for an employee for a specified time range of dates. |
| <u>Cancel Absence Page</u> | GP_ABS_SS_REQUEST | Cancel an employee absence request. |
| <u>Multiple Absence Requests Page</u> | HGA_MANAGE | Approve, deny, or push back multiple absence requests. |

Request Absence Page

Use the Request Absence page (HR_DR_DIRECTREPORT) to enter a date to use to generate a list of direct reports in which to request absences.

Navigation:

Manager Self Service > Time Management > Report Time > Employee Absence Request > Request Absence > Request Absence

This example illustrates the fields and controls on the Request Absence page.

Request Absence

Employee Selection Criteria
 Select the employee you'll be working with. You can initiate transactions only for employees who reported to you as of the date you entered on this page.

As Of Date

[Find Employee](#)

| Antonio Smith's employees | | | | Personalize | First | 1-6 of 6 | Last |
|---------------------------------------|---|---------|-----|-------------|-----------|----------|------|
| Select | Name | Empl ID | Job | Empl Status | HR Status | Position | |
| <input type="button" value="Select"/> | <input type="checkbox"/> Danilo Travantti | K0W002 | 0 | Active | Active | | |
| <input type="button" value="Select"/> | <input type="checkbox"/> Jaime Taylor | K0W046 | 0 | Active | Active | | |
| <input type="button" value="Select"/> | Laura Jones | K0W005 | 0 | Active | Active | | |
| <input type="button" value="Select"/> | Owen Wills | K0W003 | 0 | Active | Active | | |
| <input type="button" value="Select"/> | <input type="checkbox"/> Paul Harvest | K0W006 | 0 | Active | Active | | |
| <input type="button" value="Select"/> | Will Smitherson | K0W004 | 0 | Active | Active | | |

The system displays the Request Absence page for a manager's direct report when the manager clicks the link with that person's name. The system displays a page that is similar to the employee self service Request Absence page.

Access the Request Absence page (click **Select** next to a direct report on the Request Absence (HR_DR_DIRECTREPORT) page).

This example illustrates the fields and controls on the Request Absence.

Request Absence

Danilo Travanti
Sales Manager

Instructions

Enter Start Date and Absence Name. Then complete the rest of the required fields before submitting or save for later your request.

Absence Detail ?

* Start Date BT

End Date BT

Filter by Type

* Absence Name

* Reason

Partial Days

Duration Hours

[View Monthly Calendar](#)

Current Balance 96.00 Hours**

Calculate End Date or Duration
Forecast Balance

Additional Information

Health Care Provider

PCP

Copayment

Workflow

Allow Request By

Request As

Comments

Requestor Comments

Go To [View Absence Request History](#) [View Absence Balances](#)

Submit
Save for Later
[Return to Direct Reports](#)

* Required Field

**Disclaimer The current balance does not reflect absences that have not been processed.

The system displays a page that is similar to the employee self service Request Absence Page, with the exception that it contains a **Workflow** section and a **Return to Direct Reports** link to return to the View Employee Absence Requests page.

Note: When you click on the **View Monthly Calendar** link, you may receive a Time and Labor calendar error if your installed Time and Labor template does not include the End Date value specified on the Request Absence page.

Workflow

| <i>Field or Control</i> | <i>Description</i> |
|-------------------------|--|
| Allow Request By | Indicates that the <i>Manager</i> or the <i>Employee and Manager</i> can enter the take. |

| Field or Control | Description |
|-------------------------|--|
| Request As | <p>Determines whether the request is entered as an <i>Employee</i> or as a <i>Manager</i>.</p> <p>When the manager requests absences for an employee they can request the time as the employee or the manager. If the manager selects to request the time as the <i>Employee</i> the request will be automatically approved, if there are no other approvers in the approval path. The manager will receive an approval confirmation page when clicking Submit. If the manager selects to request the time as the <i>Manager</i> the request will be sent to the manager’s next level of approval, and therefore the manager will receive a regular Submit confirmation page after clicking Submit.</p> <p>The Request As available options will be editable if the Country Take setup field Override Request As on the Absences page is selected. Otherwise this field will be grayed out and defaulted from the setup.</p> |

Related Links

[Request Absence Page](#)

Absence Request History Page

Use the Absence Request History page (HR_DR_DIRECTREPORT) to enter a date to use a list of direct reports in which to view absence history.

Navigation:

Manager Self Service > Time Management > View Time > Employee Absence History > Absence Request History

This example illustrates the fields and controls on the Absence Request History page.

Absence Request History

Employee Selection Criteria
 Select the employee you'll be working with. You can initiate transactions only for employees who reported to you as of the date you entered on this page.

As Of Date:

[Find Employee](#)

| Select | Name | Empl ID | Job | Empl Status | HR Status | Position |
|---------------------------------------|---|---------|-----|-------------|-----------|----------|
| <input type="button" value="Select"/> | <input type="checkbox"/> Danilo Travantti | K0W002 | 0 | Active | Active | |
| <input type="button" value="Select"/> | <input type="checkbox"/> Jaime Taylor | K0W046 | 0 | Active | Active | |
| <input type="button" value="Select"/> | <input type="checkbox"/> Laura Jones | K0W005 | 0 | Active | Active | |
| <input type="button" value="Select"/> | <input type="checkbox"/> Owen Wills | K0W003 | 0 | Active | Active | |
| <input type="button" value="Select"/> | <input type="checkbox"/> Paul Harvest | K0W006 | 0 | Active | Active | |
| <input type="button" value="Select"/> | <input type="checkbox"/> Will Smitherson | K0W004 | 0 | Active | Active | |

The direct reports for the manager are displayed on this page. Click the column titles for **Name**, **EmplID**, **Pay Status**, and **HR Status** to sort the list by these criteria. The last column may contain an

button that indicates the employee has direct reports. Click the button to display a list of individuals that report to that employee. These employees are referred to as the manager's indirect reports.

| Field or Control | Description |
|-------------------------|---|
| As Of: | The system displays the direct reports for the manager as of this date. |

The system displays the Absence Request History page for a manager's direct report when the manager selects the person's name. The system displays a page that is identical to the employee self service Absence Request History page, with the exception that it contains a **Direct Reports** link to return to the Absence Request History page.

Related Links

[Absence Request History Page](#)

View Absence Balances Page

Use the View Absence Balances page (HR_DR_DIRECTREPORT) to enter a date to generate a list of direct reports in which to view absence balances.

Navigation:

Manager Self Service > Time Management > View Time > Employee Absence Balances > View Absence Balances

This example illustrates the fields and controls on the View Absence Balances page.

View Absence Balances

Employee Selection Criteria
 Select the employee you'll be working with. You can initiate transactions only for employees who reported to you as of the date you entered on this page.

As Of Date:

[Find Employee](#)

| Antonio Smith's employees | | | | Personalize | First | 1-6 of 6 | Last |
|---------------------------------------|---|---------|-----|-------------|-----------|----------|------|
| Select | Name | Empl ID | Job | Empl Status | HR Status | Position | |
| <input type="button" value="Select"/> | <input type="checkbox"/> Danilo Travantri | K0W002 | 0 | Active | Active | | |
| <input type="button" value="Select"/> | <input type="checkbox"/> Jaime Taylor | K0W046 | 0 | Active | Active | | |
| <input type="button" value="Select"/> | <input type="checkbox"/> Laura Jones | K0W005 | 0 | Active | Active | | |
| <input type="button" value="Select"/> | <input type="checkbox"/> Owen Wills | K0W003 | 0 | Active | Active | | |
| <input type="button" value="Select"/> | <input type="checkbox"/> Paul Harvest | K0W006 | 0 | Active | Active | | |
| <input type="button" value="Select"/> | <input type="checkbox"/> Will Smitherson | K0W004 | 0 | Active | Active | | |

This page functions in the same manner as the Absence Request History page. From this page, when the manager clicks the Select button next to the employee name the system displays the View Absence Balances page for that employee. This page is identical to the employee self service View Absence Balances page, and includes the Forecast Balances link to enable the manager to forecast absence entitlement balances for a future date for direct reports. The one exception to the similarity of the employee self service page and the manager self service page is that the manager has a **Return to Direct Reports** link to return to the View Absence Balances - Select Employee page.

Related Links

[View Absence Balances Page](#)

Absence Requests Page

Use the Absence Requests page (GP_SS_ABS_APPR) to select the absence request to approve or deny.

Navigation:

Manager Self Service > Time Management > Approve Time and Exceptions > Employee Absence Approval > Absence Requests

This example illustrates the fields and controls on the Absence Requests page.

Absence Requests

Antonio Smith
Administrator

Select the requestor's name link to approve or deny the request. You can view the monthly calendar for your direct reports by selecting the View Monthly Calendar link. To view all requests or previously approved/denied requests, use the Show Requests by Status and select the Refresh button.

*Show Requests by Status Pending Refresh

| Absence Requests | | | | Personalize | Find | First | 1-21 of 21 | Last |
|---------------------------------|-------------|-------------------------|----------------------|--------------|------------|------------|------------|------------|
| Name | Employee ID | Job Title | Approval Process | Absence Name | Start Date | End Date | Status | Submitted |
| Danilo Travanti | K0W002 | Sales Manager | Absence Cancellation | Vacation | 09/05/2016 | 09/09/2016 | Approved | 08/09/2016 |
| Owen Wills | K0W003 | Bus Person | Absence Cancellation | Vacation | 09/12/2016 | 09/14/2016 | Approved | 08/03/2016 |
| Owen Wills | K0W003 | Bus Person | Absence Request | Vacation | 02/26/2016 | 02/26/2016 | Submitted | 08/03/2016 |
| Owen Wills | K0W003 | Bus Person | Absence Request | Vacation | 04/25/2016 | 04/27/2016 | Submitted | 08/03/2016 |
| Owen Wills | K0W003 | Bus Person | Absence Request | Vacation | 03/28/2016 | 03/28/2016 | Submitted | 08/03/2016 |
| Owen Wills | K0W003 | Bus Person | Absence Cancellation | Sick | 07/20/2016 | 07/20/2016 | Approved | 07/24/2016 |
| Owen Wills | K0W003 | Bus Person | Absence Request | Bereavement | 08/21/2013 | 08/21/2013 | Submitted | 08/21/2012 |
| Owen Wills | K0W003 | Bus Person | Absence Request | Vacation | 03/01/2013 | 03/05/2013 | Submitted | 08/21/2012 |
| Owen Wills | K0W003 | Bus Person | Absence Request | Bereavement | 06/01/2012 | 06/05/2012 | Submitted | 08/21/2012 |
| Will Smitherson | K0W004 | Sales Manager | Absence Request | Vacation | 08/21/2013 | 08/27/2013 | Submitted | 08/21/2012 |
| Laura Jones | K0W005 | Representative-Customer | Absence Request | Bereavement | 04/05/2012 | 04/06/2012 | Submitted | 08/21/2012 |
| Laura Jones | K0W005 | Representative-Customer | Absence Request | Vacation | 08/21/2013 | 08/27/2013 | Submitted | 08/21/2012 |
| Paul Harvest | K0W006 | Manager-Item Processing | Absence Request | Vacation | 05/06/2013 | 05/09/2013 | Submitted | 08/21/2012 |
| Paul Harvest | K0W006 | Manager-Item Processing | Absence Request | Vacation | 08/21/2012 | 08/24/2012 | Submitted | 08/21/2012 |
| Danilo Travanti | K0W002 | Sales Manager | Absence Request | Sick | 02/05/2007 | 02/05/2007 | Submitted | 09/19/2006 |
| Owen Wills | K0W003 | Bus Person | Absence Request | Jury | 01/26/2007 | 01/26/2007 | Submitted | 09/19/2006 |
| Owen Wills | K0W003 | Bus Person | Absence Request | Sick | 08/07/2005 | 08/08/2005 | Submitted | 09/21/2004 |
| Owen Wills | K0W003 | Bus Person | Absence Request | Vacation | 09/05/2005 | 09/05/2005 | Submitted | 09/21/2004 |
| Laura Jones | K0W005 | Representative-Customer | Absence Request | Sick | 04/04/2005 | 04/06/2005 | Submitted | 09/21/2004 |
| Paul Harvest | K0W006 | Manager-Item Processing | Absence Request | Jury | 01/03/2005 | 01/03/2005 | Submitted | 09/21/2004 |
| Rush Limbo | K0W007 | Operator | Absence Request | Sick | 03/21/2005 | 03/22/2005 | Submitted | 09/21/2004 |

Go To [View Monthly Calendar](#)

| Field or Control | Description |
|--------------------------------|--|
| Show Requests by Status | <p>The following options are available in this field:</p> <ul style="list-style-type: none"> • <i>Approved.</i> • <i>Denied</i>(Displays absence with status Denied and Push Back). • <i>Pending (default)</i> (Displays absence with status Pending and In Approval Process). |

After selecting the status, click the **Refresh** button to display all requests. Click the employee name link to work with the request. The Request Details page appears:

This example illustrates the fields and controls on the Approve Absence Requests - Request Details page.

[Approve Absence Request](#)

Request Details

Danilo Travantti
Sales Manager

Instructions

Review the details for this request and either approve, deny or push back for rework. You may also enter optional comments about each approval choice.

Absence Detail ?

| | | | |
|-----------------|------------------|-----------------|-------------|
| Start Date | 02/05/2007 | | |
| End Date | 02/05/2007 | | |
| Absence Name | Sick | Current Balance | 96.00 Hours |
| Reason | Flu | | |
| Partial Days | Start Day Only | | |
| Start Day Hours | 4.00 | | |
| Duration | 4.00 | Hours | |
| | Forecast Balance | | |

Additional Information

| | | | |
|----------------------|-----------|-----|------|
| Health Care Provider | UHC | PCP | DR Z |
| Copayment | 15.000000 | | |

Workflow

Status Submitted

Comments

Requestor Comments I was sick of flu

Approver Comments

Go To [View Absence Request History](#) [View Absence Balances](#) [View Monthly Calendar](#)

Approve
Deny
Push Back

[Return to Absence Requests](#)

The manager uses this page to approve, deny, or push back the request to the previous step in the approval process (by clicking the **Push Back** button). The approver can include suggested changes or other comments by entering information in the **Approver Comments** field.

After clicking one of these buttons, the approver must confirm the selection on a confirmation page:

This example illustrates the fields and controls on the Approval Confirmation page.

Request Details

Approval Confirmation

 Are you sure you want to Approve this Absence Request?

After clicking the **Yes** button the system re-displays the Absence Requests page so that the manager can continue to work with other absence requests. Clicking the **No** button displays the Request Details page.

If the manager clicks the **Push Back** button, the system displays the Push Back Confirmation page.

Absence Request History Page

Use the Absence Request History page (GP_ABS_SS_REQHIST) to review the absence request history for an employee for a specified time range of dates.

Navigation:

Manager Self Service > Time Management > View Time > Employee Absence History

Select the employee **Name** on the Absence Request History page.

This example illustrates the fields and controls on the Absence Request History page.

Absence Request History







Danilo Travanti
Sales Manager

Instructions

Specify the date range of interest. To retrieve a complete history, leave From and Through dates blank and select the Refresh button. Select the absence name link to view request details. select edit button to modify or delete the text

From Through

| Absence Request History | | | | | | | Personalize Find View All   | First  1-4 of 4  Last |
|-------------------------|--------------------|------------|------------|----------|--------------------------|-------------------------------------|---|---|
| Absence Name | Status | Start Date | End Date | Duration | Requested By | Edit | Cancel | |
| Vacation | Cancel In Progress | 09/05/2016 | 09/09/2016 | 40 Hours | Employee Absence Request | <input type="button" value="Edit"/> | <input type="button" value="Cancel"/> | |
| Sick | Approved | 08/19/2016 | 08/19/2016 | 8 Hours | Manager Absence Request | <input type="button" value="Edit"/> | <input type="button" value="Cancel"/> | |
| Sick | Approved | 08/05/2016 | 08/05/2016 | 8 Hours | Employee Absence Request | <input type="button" value="Edit"/> | <input type="button" value="Cancel"/> | |
| Jury | Approved | 06/13/2016 | 06/14/2016 | 2 Days | Employee Absence Request | <input type="button" value="Edit"/> | <input type="button" value="Cancel"/> | |

[Return to Direct Reports](#)

The system displays a page that is identical to the employee self service [Absence Request History Page](#), with the exception that it contains a **Return to Direct Reports** link to return to the [Absence Request History Page](#) where you can select a different direct report.

Clicking the link in the **Absence Name** column displays the Approval Details page. Links appear only for absence requests that the manager has worked with using the self service pages. Absence requests or any absence entered or modified via Timesheets or by the Absence Administrator using the Event Entry component can not be edited in Absence self-service.

Note: The system calculates and stores duration values for absence requests entered through self-service only. The system does not calculate or store absence duration for absences entered through other online pages such as Absence Event Entry or via Component Interface.

| Field or Control | Description |
|-------------------------|--|
| From and Through | The user can display absence request history that falls within a specified date range by entering dates in the From and Through fields. If the manager enters a date in only the From field, the system displays absence requests that have a Start Date equal to or after the specified date. Alternatively, if the manager enters a date only in the Through field, the system displays absence requests that have an End Date equal to or prior to the specified date. If no date is entered in either field, the system displays all absence requests for the employee. |
| Cancel | Click to access the Cancel Absence page where you can submit an absence cancellation request. |

Related Links

[Entering Maintaining and Approving Absence Events](#)

Cancel Absence Page

Use the Cancel Absence page (GP_ABS_SS_REQUEST) to cancel an employee absence request.

Navigation:

Click the Cancel button for an absence on the Absence Request History page.

This example illustrates the fields and controls on the Cancel Absence page.

Cancel Absence

Danilo Travanti
Sales Manager

Instructions
Enter Start Date and Absence Name. Then complete the rest of the required fields before submitting or save for later your request.

Absence Detail ?

| | |
|--------------------------|---------------------------------------|
| Start Date 08/05/2016 | View Monthly Calendar |
| End Date 08/05/2016 | |
| Filter by Type All | |
| Absence Name Sick | Current Balance 96.00 Hours** |
| Reason Flu | |
| Partial Days None | |
| Duration 8.00 Hours | |
| Status Approved | |

Cancel Details

*Cancel Reason

Request As

Comments

Go To [View Absence Request History](#)
[View Absence Balances](#)

[Return to Direct Reports](#)

* Required Field
**Disclaimer The current balance does not reflect absences that have not been processed.

| Field or Control | Description |
|-------------------------|--|
| Cancel Reason | Select a reason for canceling the absence request. |
| Request As | Determines whether the absence cancellation is entered as an <i>Employee</i> or as a <i>Manager</i> . If you select <i>Employee</i> , the system approves the absence request. If you select <i>Manager</i> , the system routes the request to next available manager. |
| Comments | Enter any additional comments regarding the absence cancellation. |
| Cancel Absence | <p>Click this button to cancel the absence. You will receive a message confirming that you want to cancel the absence. Click Yes to confirm the cancellation.</p> <p>The system changes the status of the absence request to <i>Cancelled</i>.</p> |

Multiple Absence Requests Page

Use the Multiple Absence Requests page (HGA_MANAGE) to approve, deny, or push back multiple absence requests.

Navigation:

Manager Self Service > Time Management > Approve Time and Exceptions > Multiple Absences Approval > Multiple Absence Requests

This example illustrates the fields and controls on the Multiple Absence Requests page.

The screenshot shows the 'Multiple Absence Requests' interface. At the top, there is a search section with a 'Search' button and filters for 'Work Flow Status' (set to 'My Pendencies') and date ranges ('From Date' 01/01/2013 and 'Through Date' 11/12/2014). Below this is a table of absence requests with columns for Select, Employee ID, Name, Job Title, Start Date, End Date, Absence Name, Reason, Duration, Balance, Entry Source, and Status. The table contains five rows of data. At the bottom, there are buttons for 'Approve', 'Deny', 'Push Back', and 'Forecast', along with a 'Forecast' button. There are also 'Select All' and 'Deselect All' options and an 'Approver Comments' field.

| Select | *Employee ID | Name | Job Title | *Start Date | *End Date | *Absence Name | Reason | Duration | Balance | Entry Source | Status |
|--------------------------|--------------|----------------|-------------------------|-------------|------------|---------------|-------------|----------|---------------|--------------------------|-----------|
| <input type="checkbox"/> | K0W003 | Owen Wills | Bus Person | 03/01/2013 | 03/05/2013 | Vacation | | 24 Hours | 103.99 Hours | Employee Absence Request | Submitted |
| <input type="checkbox"/> | K0W003 | Owen Wills | Bus Person | 08/21/2013 | 08/21/2013 | Bereavement | Bereavement | 1 Days | Not Available | Employee Absence Request | Submitted |
| <input type="checkbox"/> | K0W004 | Will Smitheron | Sales Manager | 08/21/2013 | 08/27/2013 | Vacation | | 40 Hours | 103.99 Hours | Employee Absence Request | Submitted |
| <input type="checkbox"/> | K0W005 | Laura Jones | Representative-Customer | 08/21/2013 | 08/27/2013 | Vacation | | 40 Hours | 103.99 Hours | Employee Absence Request | Submitted |
| <input type="checkbox"/> | K0W006 | Paul Harvest | Manager-Item Processing | 05/06/2013 | 05/09/2013 | Vacation | | 32 Hours | 192.00 Hours | Employee Absence Request | Submitted |

Search

| Field or Control | Description |
|-------------------------|--|
| Work Flow Status | <p>Enter a value to search for absence requests based on work flow status. Values are:</p> <ul style="list-style-type: none"> <i>Approved:</i> Select to search for absence requests that you approved. <i>Denied:</i> Select to search for absence requests that you denied. <i>My Pendencies:</i> Select to search for absence requests that are pending your approval. <i>Pushed Back:</i> Select to search for absence requests that you pushed back. <i><blank></i> Leave this field blank to search for absence requests of all statuses. |

Absence Requests

This section of the page enables you to review the absence details, forecasting information, and any comments associated with the absence requests that meet your search criteria.

| <i>Field or Control</i> | <i>Description</i> |
|--------------------------|--|
| Name | Click to access the Absence Details page where you can view additional details for the absence request. |
| Approver Comments | Any comments you enter in this field are added to the selected absence requests when you click the Approve , Deny , or Push Back buttons. |
| Approve | Click to approve the selected absence requests. |
| Deny | Click to deny the selected absence requests. |
| Push Back | Click to push back the selected absence requests. |
| Forecast | Click to initiate the forecasting process for the selected absence requests. |

Managing Manager Absences Through Time and Labor Self Service

Managers are able to enter absences and view absence entitlement balances for their employees using self service pages in Absence Management. Absence management manager self service pages are discussed in detail in this documentation.

If you are integrating with Time and Labor managers can enter absence requests for their employees through the Timesheet page. Also, on this page you can view absence entitlement balances to ensure the employee has enough entitlement balance prior to entering the absence.

The following steps, completed during implementation, enable managers to access the Timesheet page to enter absences or view entitlement balances:

1. Ensure that Absence Management and Time and Labor are selected on the Installation Table.

See “Setting Up Implementation Defaults” (Application Fundamentals).

2. On the Absences page of the Country Take component ensure you have allowed entry in Time and Labor for the absence take elements you want to enter on the Timesheet page.

See [Understanding Self Service Setup Tasks](#).

The following steps discuss how a manager enters absences and views entitlement balances on the Timesheet page:

1. Access the Timesheet page by navigating to **Manager Self Service > Time Management > Report Time > Timesheet** .
2. Click **Get Employees** to get a list of all the employees for the manager.
3. Click the employee name that the manager wants to enter absences. This will open the Timesheet page for the employee chosen.
4. Click the **Absence Event - click to view** link to add, edit, forecast or submit an absence request. For example to add a request:
 - a. Click **Add Absence Event**.
 - b. Enter the **Start Date** and **End Date** for the absence.
 - c. Select the **Absence Name** from the available options. Valid values are *Sick* and *Vacations*.
 - d. If during implementation you have selected to display a reason on the Absences page of the Country Take component, enter the reason for the absence.
 - e. Click the **Details** link to access the GP_ABS_SS_REQUEST page to enter absence details. Once all details are entered click **OK** to return to the Timesheet page.

Note: If an absence requires more information than the fields available in the Timesheet Absence grid (Start Date, End Date, Absence Name and Reason) then the system will automatically open the Absence Event Details page.

See [Request Absence Page](#).

5. Click the **Balances - click to view** link to view absence entitlement balances.

Note: The balances reflect the balances as of the last absence run.

Related Links

“Reporting Time” (PeopleSoft Time and Labor)

Using Approvals with Absence Management

Understanding the Approval Process

Many daily tasks are part of a larger process that involves several steps and people working together. The term workflow refers to this process, which could encompass, for example, the approval of a time-off request. To facilitate this type of multiuser process, PeopleSoft can automatically trigger workflow notifications to inform the next approver in the process of work waiting.

The Approval Framework is the engine that provides capabilities for creating, running, and managing the approval processes. The engine uses a series of database objects combined with application component configuration settings to determine how to process approvals using workflow.

The Approval Framework is a common component that is shared across multiple PeopleSoft applications both within HCM and other product families. Due to the widespread use of this engine, you'll find documentation pertaining to it in various locations:

- *Approval Framework* describes the Approval Framework and application setup in full detail.
It is the primary source of information for approval workflow.
- The *Application Fundamentals* documentation describes the setup steps and details for the Approval Framework that are specific to the HCM product line.
- Application-specific HCM documentation expands on all of the above texts by providing approval workflow details that relate to specific business processes.

Before implementing, you should read all relevant sources of information to gain a complete understanding of how the pieces fit together.

Related Links

“Understanding Approvals” (Application Fundamentals)

Approval Framework and Absence Management

PeopleSoft Absence Management delivers the AbsenceManagement Process ID. You can add multiple Approval Definition IDs to the Approval Process ID. You can link multiple approval scenarios. One may be self-approved; while another can be one, two or more levels of approvals using approvers in one or in multiple user lists to a single Approval Process ID. This functionality allows you to simplify your approval scenarios and reduce the maintenance to multiple Approval Process IDs.

Approvals for Self-Service and Extended Absence Requests

The system uses the following delivered Approval Definition IDs for self-service and extended absence requests:

- `AbsenceMgmtByDeptManager`
- `AbsenceMgmtByPosMgmt`
- `AbsenceMgmtByPosnDeptMgr`
- `AbsenceMgmtByPosnSupervisor`
- `AbsenceMgmtBySupervisorId`
- `AbsenceBySupervisorMulti`

When the originator of an absence event submits the request, the system checks to see if approvals are being used based on the Administrative Rules defined on the “Configure Country Take Setup - Absences Page” (PeopleSoft Absence Management). If no approvals are needed then the Approval Process ID and Approval Definition ID fields on the Absence page will be left blank, or you can setup your own Approval Definition ID to make your events self and auto-approved. If values are entered for these fields the approvals process is initiated.

The first step in the approval process is to identify the first person to approve the transaction. This person is based on the Approval Process definition. If the system identifies this person, the system sends a notification indicating that there is an absence awaiting for approval. The approver has the option to:

- Approve the absence. The system sends a notification to the next person in the approval process, if one is indicated.
- Deny the absence. The system terminates the approval process. The originator of the absence will receive notification indicating the absence has been denied.
- Push back the absence. The originator of the absence will receive a notification indicating the absence needs their attention.

Note: Push Back is a valid action for the approver before the absence has gone through the first approver in the approval path. Once the second or subsequent approver has pushed back the absence, the first approver should deny it instead of pushing back the absence. It is recommended for the first approver to always state the reason in the comment field when denying an absence.

If the system cannot identify the first approver, it moves to step two of the approval process.

A subsequent step in the approval process (if multiple levels of approvals were defined), is to identify the next person to approve the absence , if one is indicated. If the system identifies the next approver, the system sends a notification to the approver telling them there is an absence needing their approval. The next approver has the option of:

- Approving the absence . The system updates the status of the absence event to approve and ends the approval process.
- Denying the absence . The system ends the approval process. The originator of the absence event will receive notification indicating the absence event has been denied.

- Push back the absence . The system sends a notification to the first approver associated with the absence event and notifies that person that the absence event needs their attention.

If neither approval steps are met, the system automatically submits a notification to the approval administrator telling the administrator there is an absence event requiring their attention.

This diagram illustrates the approval process flow.

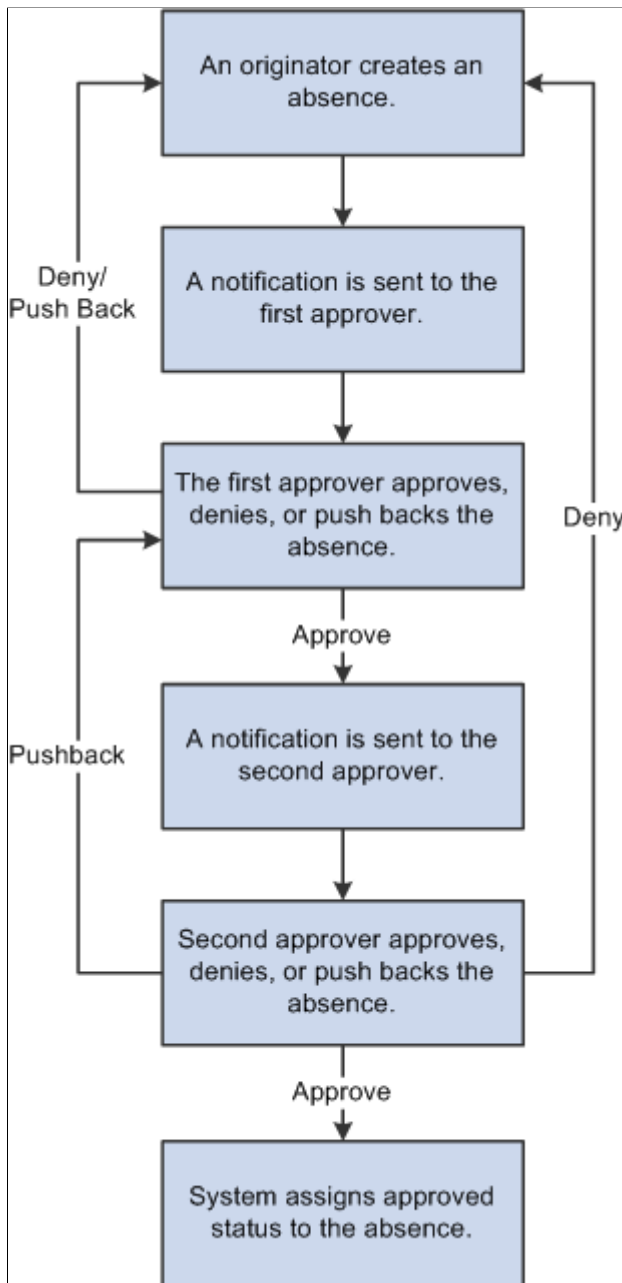

Note: The only delivered approval process with two levels of approval is the AbsenceManagement approval process ID. The others only have one level of approval. If the delivered approval processes do not meet your organizational needs you can create your own approval process ID, or add more steps to any of the approval definitions IDs that better fits your company policies.

Approvals for Absences Entered by Administrators

The system uses the following delivered Approval Definition IDs for approvals entered by Administrators using the “Create and Maintain Absence Requests Page” (PeopleSoft Absence Management):

- AbsenceMgmtByDeptManager
- AbsenceMgmtByPosMgmt
- AbsenceMgmtByPosnDeptMgr
- AbsenceMgmtByPosnSupervisor
- AbsenceMgmtBySupervisorId
- AbsenceBySupervisorMulti
- Administrator-AutoApprove
- Administrator_RouteTo

Administrators select one of four Submit Options when submitting absence requests:

- *Approve Automatically*: This option uses the Administrator-AutoApprove approval definition to approve submitted absence requests automatically.
- *Route to An Operator ID*: This option uses the Administrator_RouteTo approval definition to route submitted absence requests to a specific approver.
- *Route To A Role*: This option uses the Administrator_RouteTo approval definition to route submitted absence requests to a specific role.
- *Use Absence Name Default*: This option routes submitted absence requests according to the approval process and approval definition defined for the absence take on the “Configure Country Take Setup - Absences Page” (PeopleSoft Absence Management).

Configuring Approval Transactions

PeopleSoft delivers the following events and email notifications templates for configuring approval transactions for Absence Management:

| Event | Template Name |
|-------------------|----------------------|
| On Final Approval | GP_ABS_SS_APPR |
| Push Back | GP_ABS_SS_WRK |
| On Final Denial | GP_ABS_SS_DNY |
| On Error | GP_ABS_SS_ERR |
| On Process Launch | GP_ABS_SS_SUB |

| Event | Template Name |
|--------------------|----------------------|
| Route for Approver | GP_ABS_SS_APPR_READY |
| On Terminate | GP_ABS_SS_WRK |

Note: These templates are delivered. If modifications are needed refer to the Applications Fundamentals Documentation. The events delivered must not be modified to ensure the correct functioning of the Absence Self Service applications. You might be able to modify this setup if you have a thorough understanding of the Approval Framework, PeopleCode and Absence Self-service.

Related Links

“Configuring Approval Transactions” (Application Fundamentals)

Understanding the Approval Process Design

The approval process consists of stages, paths, steps, user lists, and criteria.

- Stages

Stages are the high level actions that the approval process executes in a specific order. Stages are made up of one or more paths.

AbsenceMgmtByDeptManager, AbsenceMgmtByPosMgmt, AbsenceMgmtByPosnDeptMgr, AbsenceMgmtByPosnSupervisor, AbsenceMgmtBySupervisorId, and AbsenceBySupervisorMulti use one stage.

- Criteria

Criteria defines the rules that are used by the approval process to determine if a stage or step is executed.

- Paths

A path is a sequence of steps.

AbsenceMgmtByDeptManager, AbsenceMgmtByPosMgmt, AbsenceMgmtByPosnDeptMgr, AbsenceMgmtByPosnSupervisor, AbsenceMgmtBySupervisorId, and AbsenceBySupervisorMulti use one path.

- Steps

A step represents one or more persons assigned to approve or review the absence event. Steps within a path execute in sequence with separate criteria for each step that determines whether or not that step executes.

- User Lists

User lists identify the people that are to act on an absence event. User lists can be roles, SQL definitions, queries, or application classes.

AbsenceManagement uses the AbsenceBySupervisorId user list.

Absence Mgmt ByDeptManager uses the AbsenceByDeptManager user list.

Absence Mgmt ByPosMgmt uses the AbsenceByPosMgmt user list.

Absence Mgmt By PosnDeptMgr uses the AbsenceByPosnDeptMgr user list.

Absence Mgmt ByPosnSupervisor uses the AbsenceByPosnSupervisor user list.

Absence Mgmt BySupervisorid uses the AbsenceBySupervisorId user list.

Administrator-AutoApprove uses the AM-AutoApprove user list.

Administrator_RouteTo uses the AM_Admin_RouteTo user list.

See “Defining Users for Approvals” (Application Fundamentals).

Note: To define the approval process, use the Setup Process Definitions (PTAF_PRC) and the Register Transactions (PTAF_TXN) components.

Working with Delegations in Absence Management

Understanding Delegation

Absence Management uses delegation to enable one person to authorize another to serve as his or her representative when working with absence transactions. A manager can delegate their tasks of approving time, entering employee time, or entering their own time to another person due to workload or their own absence from the office. An employee can delegate the entering of his or her time to another person while away from the office.

Delegation Terminology

The following terms are important to understanding the delegation feature:

- *Delegation*: The act of giving one's authority to another user.
- *Delegator*: A person that delegates authority to another user.
- *Proxy*: A person granted authority to act on behalf of another user.
- *Delegated Authority*: The rights and privileges that are given from the delegator to the proxy.
- *Delegation Request*: A request from the delegator to the proxy to take on delegated authority.
- *Delegation Period*: The time range in which the delegated authority is in effect.
- *Delegation Administrator*: The system administrator who is responsible for configuring, managing, and maintaining delegated authorities.
- *Revoke*: When a delegator withdraws delegated authority.

Delegation Framework

The delegation framework supports the following types of delegation:

- Downward delegation of authority to a direct report or another person lower down in the reporting hierarchy.
- Upward delegation of authority to a manager or another person higher up in the reporting hierarchy.
- Lateral delegation of authority to a peer either within the same division or in a different division within the reporting hierarchy.

Note: To prevent situations of cascading or circular delegation chains, once the delegation framework passes delegated authority over an absence transaction to a proxy, the proxy cannot delegate authority over that transaction to another user. The delegation framework only passes authority over transactions from initial delegator to initial proxy.

Related Links

“Understanding Delegation” (Enterprise Components)

Reviewing Delivered Absence Management Delegation Set Up

This topic provides an overview of delivered delegation set up for Absence Management and discusses how to:

- Review workflow transactions.
- Review permission lists and roles for delegation.
- Define installation settings.
- Review delegation transactions.

Delivered Delegation Set Up for Absence Management

The delegation framework for Absence Management is delivered with the system. To review this framework:

1. Review delegation transactions for workflow on the Register Workflow Transaction page.
2. Review delegation permission lists and roles through PeopleTools Security components.
3. Define installation settings for delegation on the Delegation Installation Settings page.
4. Review transactions for delegation on the Configure Delegation Transaction page.

Reviewing Workflow Transactions

The PeopleSoft system delivers several transactions that are pre-configured for the Absence Management delegation framework. This table lists the delivered delegation transactions:

Note: Refer to “Configuring Delegation Transactions” (Enterprise Components) for an updated list of delivered delegation transactions for Absence Management.

| <i>Transaction Name</i> | <i>Transaction Type</i> | <i>Description</i> |
|-------------------------|-------------------------|---|
| GP_ABS_EESS_BAL | Initiate | Delegate initiation of the employee view of absence balances. |

| Transaction Name | Transaction Type | Description |
|-------------------------|-------------------------|--|
| GP_ABS_EESS_HIST | Initiate | Delegate initiation of the employee view of absence history. |
| GP_ABS_EESS_REQ | Initiate | Delegate initiation of the employee request absence. |
| GP_ABS_MGRSS_BAL | Initiate | Delegate initiation of the manager view of absence balances. |
| GP_ABS_MGRSS_HIST | Initiate | Delegate initiation of the manager view of absence history. |
| GP_ABS_MGRSS_REQ | Initiate | Delegate initiation of manager request absence. |
| GP_SS_ABS_APPR_L | Approve | Delegate approval of manager approved absence request. |

Use the Approval Workflow Engine (AWE) and Delegation Transactions grid to register self-service transactions that use the AWE framework and delegation framework. The data that you enter into this grid links the transaction name and accompanying tables for HCM self-service transactions to the approval process IDs that you create for these transactions on the Register Transactions page.

Note: Ensure the **Approval Process ID** is set properly according to the Approval Process ID and Approval Process Definition defined in your Country Take setup. You can have multiple Approval Process IDs defined, yet you can only use one at a time. Associate the appropriate Approval Process ID for the **Transaction Name** *GP_SS_ABS_APPR_L* in order for delegations on Absence Requests to work correctly.

Multiple Approval Definition IDs can be added to an Approval Process ID. You can link multiple approval scenarios. One may be self-approved; while another can be one, two or more levels of approvals using approvers in one or in multiple user lists to a single Approval Process ID. This functionality allows you simplifying your approval scenarios and reduce the maintenance to multiple Approval Process IDs.

Related Links

“Linking Workflow Transactions” (Application Fundamentals)

“Setting Up Approval Process Definitions” (Application Fundamentals)

Reviewing Permission Lists and Roles for Delegation

PeopleSoft HR delivers as system data several permission lists that are required for use of the Delegation framework.

This table describes the delivered absence management roles for the delegation framework:

| Role Name | Attached Permission Lists | Description |
|--------------------------------|----------------------------------|---|
| Delegate Employee Absence Bal | HCCPAMSS09 | Enables users to access the component to view employee absence balances for another employee when it is delegated to the user. |
| Delegate Employee Absence Hist | HCCPAMSS10 | Enables users to access the components to view employee absence history and absence request details for another employee when they are delegated to the user. |
| Delegate Employee Absence Rqst | HCCPAMSS08 | Enables users to access the component to enter an employee absence request for another employee when it is delegated to the user. |
| Delegate Manager Absence Appr | HCCPAMSS04 | Enables users to access the components to approve absences for another managers direct reports when the pages are delegated to the user. |
| Delegate Manager Absence Bal | HCCPAMSS06 | Enables users to access the components to view absence balances for a managers direct reports when the pages are delegated to the user. |
| Delegate Manager Absence Hist | HCCPAMSS07 | Enables users to access the components to view absence history for a managers direct reports when the pages are delegated to the user. |
| Delegate Manager Absence Rqst | HCCPAMSS05 | Enables users to access the components to enter absence requests for a managers direct reports when the pages are delegated to the user. |

For more information on setting up permission lists and role security, see *PeopleTools: Security Administration*.

Related Links

“Setting Up Permission Lists and Roles for Delegation” (Enterprise Components)

Defining Installation Settings

When using delegations, ensure that your specified hierarchy is in sync with your direct reports access type setup. In addition, your approval process and definition IDs must be associated to your absence. An incorrect setup can lead to incorrect results. For example, if you use the direct report access type and delegation hierarchy by supervisor ID, then ensure that your absence approval process ID is set up by supervisor ID.

Related Links

“Defining Delegation Installation Settings” (Enterprise Components)

“Setting Up Access to Direct Reports Data” (Application Fundamentals)

Reviewing Delegation Transactions

This table lists the delegation transactions delivered for Absence Management:

Note: Refer to “Configuring Delegation Transactions” (Enterprise Components) for an updated list of delivered delegation transactions for Absence Management.

| <i>Transaction Name</i> | <i>Transaction Type</i> | <i>Role</i> |
|--------------------------|-------------------------|--------------------------------|
| Employee Absence Balance | Initiate | Delegate Employee Absence Bal |
| Employee Absence History | Initiate | Delegate Employee Absence Hist |
| Employee Absence Request | Initiate | Delegate Employee Absence Rqst |
| Manager Absence Balance | Initiate | Delegate Manager Absence Bal |
| Manager Absence History | Initiate | Delegate Manager Absence Hist |
| Manager Absence Request | Initiate | Delegate Manager Absence Rqst |
| Manager Absence Approve | Approve | Delegate Manager Absence Appr |

Adding Delegation Request Through Self Service

This topic provides an overview of delegation through self service and provides an example of delegation in Absence Management.

Steps to Set Up Delegation Through Self Service

A delegator follows these steps to delegate absence requests through self service:

1. Log in to the system.
2. Navigates to the Manage Delegation component (**Self Service > Manage Delegation > Manage Delegation**).
3. Click the **Create Delegation Request** hyperlink.
4. If the delegator has multiple jobs, they will have to select the job for which they are delegating the transaction.

Note: If the person has multiple jobs, they must be active in at least one job throughout the delegation period.

5. Enter **From Date** and **To Date** for the delegation request, then click the **Next** button.
6. Select the transactions to delegate authority, then click the **Next** button.
7. Review the list and select a proxy. To do this select a person to which authority will be delegated
8. Select the **Notify Delegator** check box, then click **Submit**.
9. Clicks **OK**, then log out.

Related Links

“Working with Self-Service Delegation” (Enterprise Components)

Example of Delegating Absence Authority

In this example the manager, Antonio Smith, is going on vacation from August 17, 2009 through August 23, 2009. During this time away from work, Antonio delegates all of his managerial absence authorities to another manager, Paul Harvest.

The following illustrations displays the steps taken by Antonio Smith to delegate his absence authority.

Managing Delegations

Antonio navigates to the Manage Delegation page (**Self Service > Manage Delegation > Manage Delegation**) to create the delegation request.

This example illustrates the fields and controls on the Delegate authority on the Manage Delegation page..

Manage Delegation

Antonio Smith

Some of your self-service transactions can be delegated so that others may act on your behalf to initiate and/or approve transactions for you and/or your employees. In addition, others may have delegated responsibility for their transactions to you.

[Learn More about Delegation](#)

Select *Create Delegation Request* to choose transactions to delegate and proxies to act on your behalf.

[Create Delegation Request](#)

For more information about accessing Fluid delegation transactions using the **Delegations** tile, see “Accessing Fluid Self-Service Delegations” (Enterprise Components).

Entering Dates for the Delegation Request

Antonio Smith enters the dates he wants to delegate his absence authorities during his time away from work.

This example illustrates the fields and controls on the Enter the dates for the delegation on the Create Delegation Request – Enter Dates page..

Create Delegation Request

Enter Dates

Antonio Smith

Administrator

Enter the dates for your delegation request. Enter a *From Date* that is today or later. Enter a *To Date* that is the same as or later than your *From Date*. For open-ended delegation requests, leave the *To Date* blank.

Delegation Dates

From Date 

To Date 

See “Create Delegation Request - Delegation Dates Page” (Enterprise Components).

Selecting Transactions for the Delegation Request

Antonio selects the types of absence transactions in which to delegate authority. He chooses to delegate all his managerial absence transactions, but not his employee absence transactions.

This example illustrates the fields and controls on the Transactions selected on the Create Delegation Request – Select Transactions page.

Create Delegation Request

Select Transactions

Linda Abbott
Administrator

Select the transactions that you want to delegate to a proxy. You can select one or many transactions.

Delegate Transactions

| Transaction |
|--|
| <input type="checkbox"/> Manage Approve Reported Time |
| <input type="checkbox"/> Manage Overtime Request |
| <input type="checkbox"/> Manage Reported Time |
| <input checked="" type="checkbox"/> Manager Abs Cancellation Fluid |
| <input type="checkbox"/> Manager Absence Approve |
| <input type="checkbox"/> Manager Absence Balance |
| <input checked="" type="checkbox"/> Manager Absence Balance Fluid |
| <input type="checkbox"/> Manager Absence History |
| <input checked="" type="checkbox"/> Manager Absence History Fluid |
| <input type="checkbox"/> Manager Absence Request |
| <input checked="" type="checkbox"/> Manager Absence Request Fluid |
| <input type="checkbox"/> Manager Career Plan |
| <input type="checkbox"/> Review Compensation Proposals |
| <input type="checkbox"/> Submit Compensation Proposals |
| <input type="checkbox"/> Template-Based Hire End-User |

[Select All](#) [Deselect All](#)

Previous
Next
Cancel

See “Create Delegation Request - Transactions Page” (Enterprise Components).

Selecting Proxy by Hierarchy

Antonio selects Paul Harvest as the person to delegate his absence transactions.

This example illustrates the fields and controls on the Select the person to delegate authority on the Create Delegation Request – Select Proxy by Hierarchy page..

Create Delegation Request

Select Proxy by Hierarchy

Antonio Smith
Administrator

This page displays persons within your hierarchy that you can select as proxies. Select the radio button next to the name to select that person as a proxy. You can also select the [Search by Name](#) hyperlink to search for proxies outside your hierarchy.

[Search by Name](#)

Choose Delegate

| Name | Empl ID | Organizational Relationship | Job Title | Department | Supervisor Name |
|---|---------|-----------------------------|-------------------------|----------------------------|-----------------|
| <input type="radio"/> Bruce Way | K0W021 | Employee | Sales Manager | Sales Administration | Dominick Osorio |
| <input type="radio"/> Danilo Travanti | K0W002 | Employee | Sales Manager | Sales Administration | Antonio Smith |
| <input type="radio"/> Jaime Taylor | K0W046 | Employee | Manager-Item Processing | Production Scheduling | Antonio Smith |
| <input type="radio"/> James Souza | K0W041 | Employee | Administrator | Finance and Administration | Bruce Way |
| <input type="radio"/> Laura Jones | K0W005 | Employee | Representative-Customer | Marketing | Antonio Smith |
| <input type="radio"/> Owen Wills | K0W003 | Employee | Bus Person | Business Services | Antonio Smith |
| <input checked="" type="radio"/> Paul Harvest | K0W006 | Employee | Manager-Item Processing | Production Scheduling | Antonio Smith |
| <input type="radio"/> Sandy Jonaz | K0W031 | Employee | Bus Person | Business Services | Bruce Way |
| <input type="radio"/> Will Smitherson | K0W004 | Employee | Sales Manager | Sales and Services | Antonio Smith |

See “Create Delegation Request - Transactions Page” (Enterprise Components).

Viewing Delegation Detail

Antonio can review the transactions he has selected to delegate to Paul. Depending on whether changes are needed he can submit or cancel the delegation request. If he submits it, the system automatically sends an email notification to the proxy, Paul Harvest, to review and either accept or reject the delegation.

This example illustrates the fields and controls on the View the delegation detail on the Create Delegation Request – Delegation Detail page..

Create Delegation Request

Delegation Detail

Antonio Smith

Administrator

Select the *Notify Delegator* checkbox to receive all the notifications that your proxy receives when acting on your behalf.

Proxy Paul Harvest

From Date 11/20/2013

To Date 11/27/2013

| Transactions |
|------------------------------|
| Manage Approve Payable Time |
| Manage Approve Reported Time |
| Manage Reported Time |
| Manager Absence Approve |
| Manager Absence Balance |
| Manager Absence History |
| Manager Absence Request |

Notify Delegator

Submit
Previous
Cancel

Viewing Proxies

Antonio can view all the proxies and request status for the delegation request. If needed he can revoke any of the transactions he has delegated at any time during the delegation period.

This example illustrates the fields and controls on the View transactions and proxies on the My Proxies page..

My Proxies

Antonio Smith
Administrator

This page allows you to view your proxies and the request status for each delegation request. Select a particular status and select *Refresh* to show the matching requests. Select the information icon to view request details. To revoke requests, select the request, then select *Revoke*.

Show Requests by Status: Submitted

Choose Delegate

| | Transaction | Name | Job Title | From Date | To Date | Request Status | Delegation Status | Details |
|--------------------------|------------------------------|--------------|-------------------------|------------|------------|----------------|-------------------|-------------------|
| <input type="checkbox"/> | Manager Absence Balance | Paul Harvest | Manager-Item Processing | 11/20/2013 | 11/27/2013 | Submitted | Inactive | i |
| <input type="checkbox"/> | Manager Absence History | Paul Harvest | Manager-Item Processing | 11/20/2013 | 11/27/2013 | Submitted | Inactive | i |
| <input type="checkbox"/> | Manager Absence Request | Paul Harvest | Manager-Item Processing | 11/20/2013 | 11/27/2013 | Submitted | Inactive | i |
| <input type="checkbox"/> | Manager Absence Approve | Paul Harvest | Manager-Item Processing | 11/20/2013 | 11/27/2013 | Submitted | Inactive | i |
| <input type="checkbox"/> | Manage Approve Reported Time | Paul Harvest | Manager-Item Processing | 11/20/2013 | 11/27/2013 | Submitted | Inactive | i |
| <input type="checkbox"/> | Manage Reported Time | Paul Harvest | Manager-Item Processing | 11/20/2013 | 11/27/2013 | Submitted | Inactive | i |
| <input type="checkbox"/> | Manage Approve Payable Time | Paul Harvest | Manager-Item Processing | 11/20/2013 | 11/27/2013 | Submitted | Inactive | i |

Select All Deselect All

[Return to Manage Delegation](#)

See “My Delegates Page” (Enterprise Components).

Viewing Delegation Authorities

Once Paul Harvest gets the email notifying him of the delegation request, he accesses the My Delegated Authorities page to accept or reject the request.

This example illustrates the fields and controls on the View, accept or reject delegated authorities on the My Delegated Authorities page..

My Delegated Authorities

Paul Harvest
Manager-Item Processing

This page allows you to view your delegated authorities. Select a particular status and select *Refresh* to show the matching requests. Select the information icon for request details.

Show Requests by Status: Submitted

Choose Delegate

| | Transaction | Name | Job Title | From Date | To Date | Request Status | Delegation Status | Details |
|--------------------------|-----------------------|---------------|---------------|------------|------------|----------------|-------------------|-------------------|
| <input type="checkbox"/> | Multiple Transactions | Antonio Smith | Administrator | 11/20/2013 | 11/27/2013 | Submitted | Inactive | i |

Select All Deselect All

[Return to Manage Delegation](#)

See “My Delegated Authorities Page” (Enterprise Components).

Viewing Details for Multiple Transactions

Prior to accepting or rejecting the delegation, Paul can review the transaction delegated to him.

This example illustrates the fields and controls on the View delegated transactions on the Multiple Transactions page..

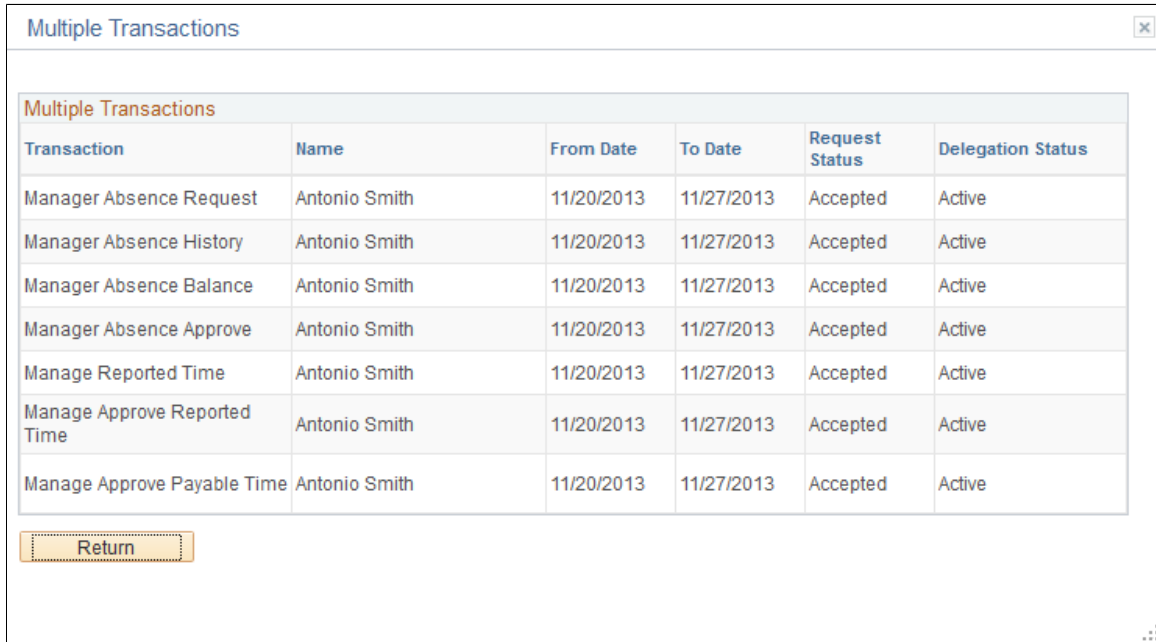

| Multiple Transactions | | | | | |
|------------------------------|---------------|------------|------------|----------------|-------------------|
| Transaction | Name | From Date | To Date | Request Status | Delegation Status |
| Manager Absence Request | Antonio Smith | 11/20/2013 | 11/27/2013 | Accepted | Active |
| Manager Absence History | Antonio Smith | 11/20/2013 | 11/27/2013 | Accepted | Active |
| Manager Absence Balance | Antonio Smith | 11/20/2013 | 11/27/2013 | Accepted | Active |
| Manager Absence Approve | Antonio Smith | 11/20/2013 | 11/27/2013 | Accepted | Active |
| Manage Reported Time | Antonio Smith | 11/20/2013 | 11/27/2013 | Accepted | Active |
| Manage Approve Reported Time | Antonio Smith | 11/20/2013 | 11/27/2013 | Accepted | Active |
| Manage Approve Payable Time | Antonio Smith | 11/20/2013 | 11/27/2013 | Accepted | Active |

Return

Delegated Absence Transaction

In this example, Laura Jones is an employee who reports to Antonio Smith. At the time of this absence Antonio Smith has delegated his approval authority to Paul Harvest. When a delegation is active the absence request details will display who is approving the absence request. The Request Details page displays the delegated authority for approval:

This example illustrates the fields and controls on the Request Details page.

Request Details

Laura Jones
Representative-Customer
[View Request Status and Approval Details](#)

Details ?

| | | | |
|--------------|------------|-----------------|---------------|
| Start Date | 11/21/2013 | | |
| End Date | 11/22/2013 | | |
| Absence Name | Sick Take | Current Balance | 96.00 Hours** |
| Reason | Sickness | | |
| Partial Days | None | | |
| Duration | 16.00 | Hours | |

Additional Information

| | |
|----------------------|-----|
| Health Care Provider | PCP |
| Copayment | |

Workflow

Status Submitted

Request History [Personalize](#) | [?](#) First

| Status | Name | Date | Comments |
|-----------|-------------|------------|----------|
| Submitted | Laura Jones | 11/20/2013 | |

Abs Mgmt By Supervisor Id

Absence Management: Pending

Abs Mgmt By Supervisor Id

Pending

⌚ Paul Harvest for Antonio Smith
Absence By Supervisorid

**Disclaimer The current balance does not reflect absences that have not been processed.

See [Request Absence Page](#).

Setting Up Overrides

Understanding Overrides

This section lists common elements used in this documentation and discusses:

- Override levels.
- Overrides available for primary elements.
- Overrides available for supporting elements.
- Begin and end date logic for overrides.
- Element overrides and segmentation.

Use overrides to control the values the system uses to resolve an element for a specified time period. When you run the absence process, the system retrieves the rule definition for the element and applies any override instructions that you've entered.

Common Elements Used for Overrides

| <i>Field or Control</i> | <i>Description</i> |
|---|---|
| Element definition override | Overrides the value of a bracket, date, duration, formula, or variable element that's used in the definition of a primary element (absence take or absence entitlement). |
| Pay calendar override | Can exclude specific absence elements from a calendar and override the values of associated bracket, date, duration, formula, and variable elements. |
| Pay entity override and Pay group override | Override the value of a bracket, date, duration, formula, or variable element whenever the element is resolved for a payee who's linked to a specified pay entity or pay group, respectively. |

| Field or Control | Description |
|------------------------------|---|
| Payee override | Refers to one of four types of payee-specific overrides: <ul style="list-style-type: none"> • Assigning or disabling absence element. • Overriding the definition of an absence element. • Overriding the value of a variable used by an absence element. • Overriding the value of a bracket, date, duration, formula, or variable element whenever it's resolved. |
| Via elements override | Controls whether an element's value can be updated by an array, bracket, date, or formula element. |

Override Levels

Before entering instructions to override an element, you must specify allowed types of overrides for that element by selecting the appropriate check boxes in the Override Levels group box on the Element Name page.

When you enable overrides for a supporting element, clear the **Always Recalculate** check box on the Element Name page. Otherwise the system uses the value of the element according to the element definition, not the override value.

Note: An additional level, payee calendar overrides, exist for supporting elements through the Off-Cycle Requests component. This level is available for off-cycle requests only and does not extend to on-cycle calendars. Before entering supporting element overrides on the Payee Calendar SOVR page, you must select the **Payee** and the **Calendar** check boxes in the Override Levels group box on the Element Name page for the supporting element.

Related Links

[Understanding Off-Cycle Processing](#)

Overrides Available for Primary Elements

Several override levels enable you to control the value of absence take, and absence entitlement elements, which the system applies in this order:

1. Payee overrides.
 - Assign or disable absence elements or override the definition of absence elements.
2. Pay calendar overrides.
3. Via element overrides.

Overrides Available for Supporting Elements

Absence Management offers seven override levels which enable you to control the values of brackets, dates, duration, formulas, and variables:

- Pay entity overrides.
- Pay group overrides.
- Payee overrides: Override the value of a bracket, date, duration, formula, or variable element whenever it's resolved for the payee.
- Payee/Element overrides. Overrides the value of a variable used by a specific entitlement or take assigned to a payee.
- Pay calendar overrides.
- Via element overrides.
- Element definition overrides.

This diagram illustrates the sequence in which the system applies overrides when it encounters multiple overrides for a supporting element. It begins with pay entity overrides.

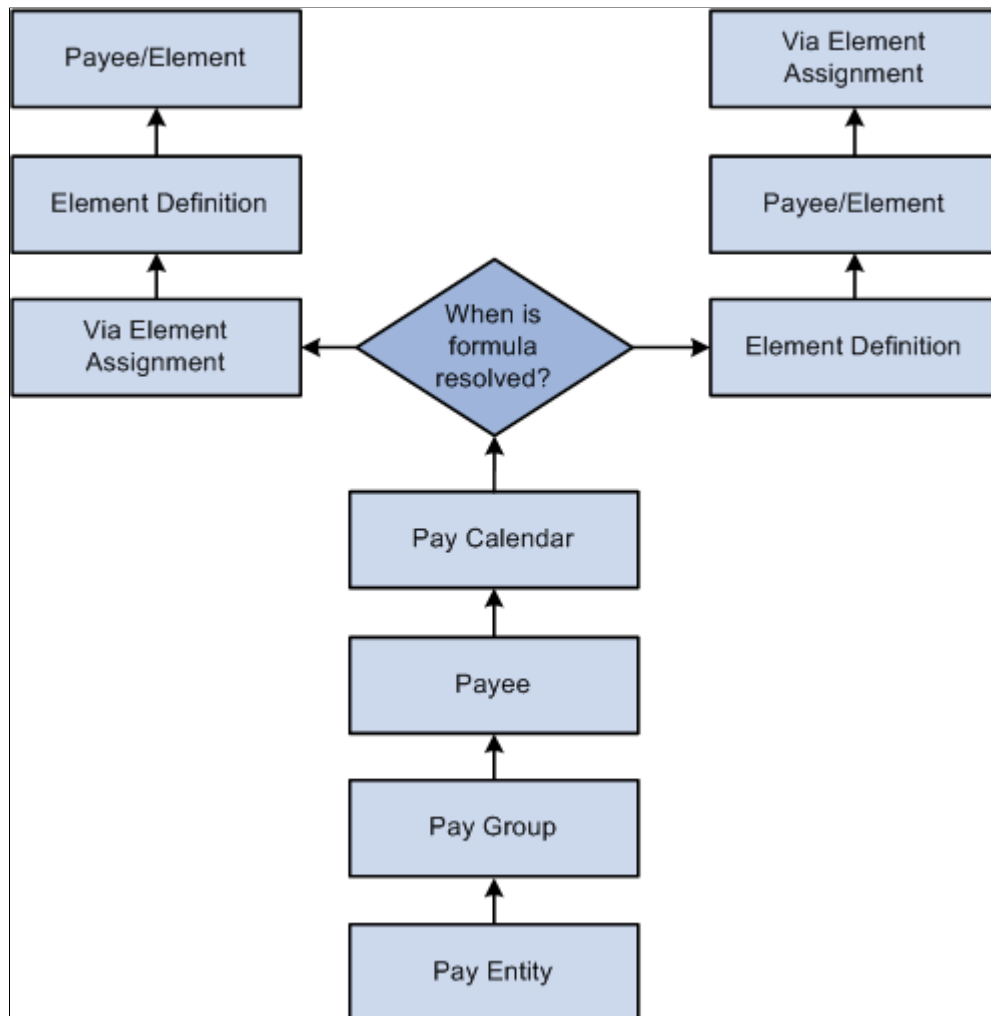

Note: A payee/element override refers to the override of a variable element that's associated with a particular entitlement or take for a payee. Enter such overrides on the Element Detail page, linked to the Payee Assignment By Element and Element Assignment By Payee pages. A payee override is the override of a bracket, date, duration, formula, or variable that's associated with a payee. Enter such overrides on the Payee Supporting Element Overrides page.

Example

VARIABLE1 has the following values:

- 30 according to the rule definition.
- 20 according to a pay entity override.
- 10 according to a pay group override.

In this case, VARIABLE1 resolves to 10, because pay group overrides take precedence over pay entity overrides.

Begin and End Date Logic for Overrides

When entering override instructions, you must specify a begin date.

The begin date tells the system when to start applying the override instructions. The current date is the default.

In most cases, end dates are optional. They specify when the override instructions become inactive. They are required only when you enter multiple rows of instructions for the same element.

The processing rules for begin and end dates vary, depending on the type of override being processed.

Payee Overrides and Segmentation

This topic discusses:

- Payee overrides and segmentation.
- Segmentation caused by payee overrides.
- Proration and segmentation in the case of payee overrides.

Payee Overrides and Segmentation

You can set up your Absence Management system to slice or segment absence periods due to changes in Human Resource or other data, including:

- Changes in job status or title that occur mid period.
- Departmental transfers that occur mid period.
- Changes in compensation rate that occur mid period.

If there is a payee override in a sliced or segmented period, the system applies the override to the different slices/segments based on the segment/slice end dates as well as the override's end date.

The system follows these rules to determine the slices or segments to which to apply an override:

- If an override is to apply to a segment, the end date of the override must equal or be greater (or blank) than the end date of the segment.
- An override can apply to more than one segment if the end date of the override is greater than one segment's end date and greater than or equal to the subsequent segment's end date (or blank).
- If the end date of the override is less than the end date of the segment, the override doesn't apply to that segment.
- Payee overrides must be active as of the segment end date.

Pay entity, pay group, and element definition overrides are unaffected by segmentation. The system retrieves the definition of the element and the override only once every period, regardless of period or element segmentation.

Note: For more information on the rules for applying overrides to slices/segments in a period, see [Segmentation and Payee Overrides](#).

Element Segmentation Caused by Payee Overrides

As noted previously, you can set up your Absence Management system to slice or segment pay periods due to changes in HR or other data. However, you can also configure the system to initiate segmentation and proration directly in response to an override—in the absence of an other data changes. That is, you can configure the system so that overrides are themselves treated as data changes that trigger segmentation. Then, when you assign or override the value of an element, the system slices the assigned element and any other elements included in the segmentation list set based on the begin and end dates of the override.

For example, assume that you set up the system to trigger segmentation when you assign or override entitlement element E1, and that you assign E1 to a payee on the Element Assignment by Payee (GP_ED_PYE) component with begin and end dates of 10 and 20 June respectively (assume a monthly pay period). Based on the assignment/override begin and end dates, the system will slice the element into three segments and process (and prorate) the element in the second slice:

| Element | Slice 1 June 1–10 | Slice 2 June 11–20 | Slice 3 June 21–30 |
|---|------------------------------------|---|-------------------------------------|
| Entitlement = E1 Entitlement Type = Numeric Entitlement Unit = 30 | Element not resolved in slice 1. | Resolved amount = 10 (proration factor = .333333333) | Element not resolved in slice 3. |

Note: The only type of segmentation that can be triggered by an element assignment or override is *element segmentation*.

To set up the system to trigger segmentation in response to an element assignment:

1. Select the *Active Anytime Within the Segment Period* option on the Countries (GP_COUNTRY) component .

When you do this, the system processes all element assignments/overrides that fall within a period—even those with end dates that are less than the pay period end date.

See [Countries Page](#).

2. If you want the element you are assigning to be prorated, associate the element with a proration rule on the entitlement definition pages.

See [Absence Entitlements - Rounding/Proration Page](#).

3. Set up segmentation triggers for the begin and end-dated entitlement and take assignment record (GP_ABS_OVRD), and list the entitlements and takes that should trigger element segmentation when the assignment *begin* date comes after the pay period begin date, and/or the assignment *end* date comes before the period end date.

Proration and Segmentation in the Case of Payee Level Overrides

Proration of payee level, primary element overrides occurs under the following conditions:

Note: Primary element overrides include entitlements and takes. Supporting element overrides include elements such as variables, formulas, arrays, and brackets.

- When period or element segmentation is triggered by data changes not directly related to an element override or assignment.
 - If there is *period segmentation* in the period to which an entitlement or take assignment applies (that is, all elements are segmented), the system prorates the assigned element based on the segment begin and end dates if the element is defined to be prorated. If not, the entire value of that element is applied to each of the targeted segments.
 - If there is *element segmentation* in the period to which an entitlement or take assignment applies, the assigned element is included in the list of elements to be sliced, and that element is defined to be prorated, the system prorates the element based on the slice dates. If not, the entire value of the element is applied to each of the targeted slices.
- When you configure your system so that primary element overrides or assignments directly trigger element segmentation.

In this case, the system slices the assigned element (and any elements associated with that element on the list set) based on the begin and end dates of the assignment as long as that element is defined to be prorated. There does not have to be slicing or segmentation for any other reason. If the element is not defined to be prorated, the full value of the element is processed within the slice defined by the assignment begin and end dates.

Note: You can set up the system to slice an element within a pay period based on the begin and end dates of the overrides assigned to a payee on the Element Assignment by Payee (GP_ED_PYE) and Payee Assignment by Element components (GP_ED_ELEM).

See [Trigger Generation](#).

Note: Primary element overrides are prorated if the element is defined to be prorated and there is either period segmentation (all elements are segmented), or there is element segmentation and the element being assigned is on the list of elements to be sliced.

In the case of supporting element overrides, the supporting element is prorated if it is a component of an element that is defined to be prorated and that element is segmented/sliced.

Defining Pay Entity Overrides

Page Used to Define Pay Entity Overrides

| <i>Page Name</i> | <i>Definition Name</i> | <i>Usage</i> |
|--|------------------------|---|
| <u>Supporting Element Overrides Page</u> | GP_PYENT_SOVR | Override the value of bracket, date, duration, formula, or variable elements that are associated with a specified pay entity. |

Understanding Processing Rules for Pay Entity Overrides

During processing, the system refers to the begin and end dates (if any) and the Definition as of Date that were defined for the element on the Element Name page.

For the override instructions to take effect:

- The begin date must be before or equal to element's Definition as of Date.
- The end date must be greater than or equal to the Definition as of Date.

Example

VARIABLE1 is defined as follows:

- Definition as of Date = Calendar Period Begin Date.
- Value = 100.
- Pay Period = January 01, 2004 – January 31, 2004.

The following pay entity override exists:

- Begin Date = January 16, 2004 (no End Date).
- Value = 200.

Payee 1 has segmentation on January 10, 2004. Payee 2 has no segmentation.

Both payees have the same value for VARIABLE1. Payee 1's segmentation doesn't alter the value of VARIABLE1.

In the diagram, the pay entity supporting element override is *not* applicable to either payee, because it wasn't applicable as of the VARIABLE1 Definition as of Date (Calendar Period Begin Date), resulting in a value of 100 for both payees.

If the Definition as of Date for VARIABLE1 is Pay Period End Date, both payees use the pay entity override value 200.

This graphic shows an example of the processing results for a pay entity override.

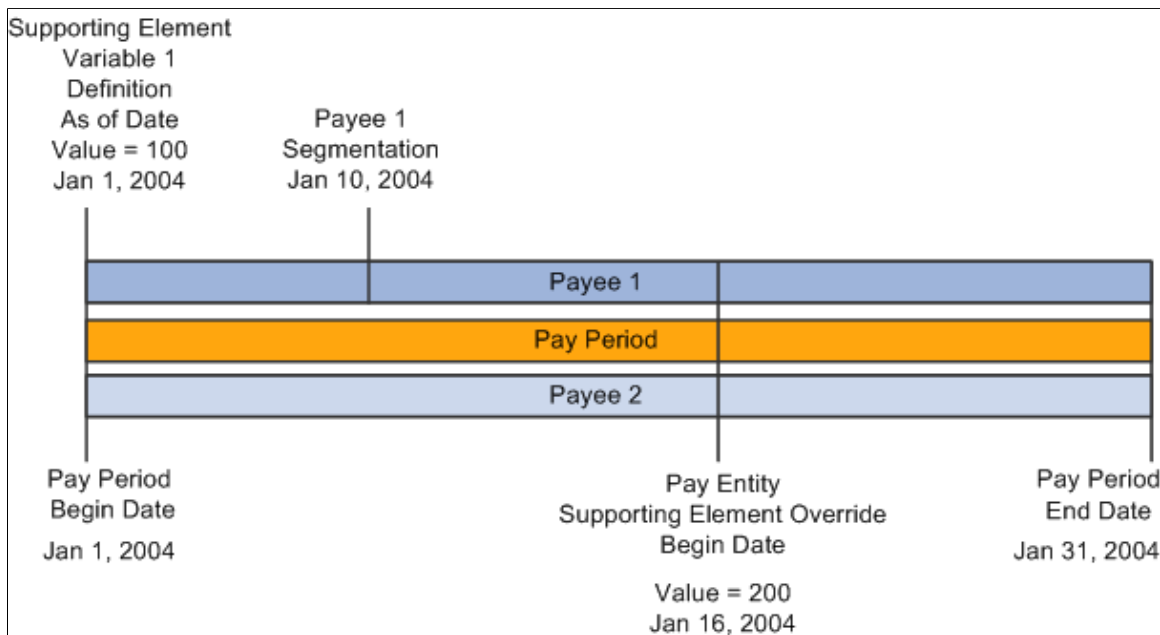

Supporting Element Overrides Page

Use the Supporting Element Overrides page (GP_PYENT_SOVR) to override the value of bracket, date, duration, formula, or variable elements that are associated with a specified pay entity.

Navigation:

Set Up HCM > Product Related > Global Payroll & Absence Mgmt > Framework > Organizational > Pay Entities > Supporting Element Overrides

This example illustrates the fields and controls on the Pay Entities - Supporting Element Overrides page.

The screenshot shows the 'Supporting Element Override List' page. The page title is 'Pay Entity K0WPE ABS1 Absence Pay Entity'. The table below shows the list of overrides:

| Element Type | Element Name | Description | *Begin Date | End Date |
|--------------|------------------|------------------|-------------|----------|
| Formula | K0WFM SICK ENTIT | Sick Entitlement | 12/30/2013 | |

To define a pay entity override on the Pay Entities - Supporting Element Overrides page:

1. Select the type and name of the supporting element for which you want to enter override instructions.

2. Enter the override begin and end dates.
3. Enter the override value on the Values tab.

Defining Pay Group Overrides

Page Used to Define Pay Group Overrides

| <i>Page Name</i> | <i>Definition Name</i> | <i>Usage</i> |
|-----------------------------------|------------------------|--|
| Supporting Element Overrides Page | GP_PYGRP_SOVR | Override the value of bracket, date, duration, formula, or variable elements that are associated with payees in a specified pay group. |

Understanding Pay Group Overrides

To override the value of supporting elements that are associated with payees in a specific pay group, you use the Pay Groups - Supporting Elements Override page. This page is similar to the [Supporting Element Overrides Page](#), as are the processing rules.

Defining Payee Overrides

Page Used to Define Payee Overrides

| <i>Page Name</i> | <i>Definition Name</i> | <i>Usage</i> |
|--|------------------------|---|
| Supporting Elements Page | GP_PAYEE_SOVR | Override the value of a bracket, date, duration, formula, or variable element that's associated with a payee. |

Understanding Payee Overrides

Payee overrides enable you to control how an entitlement or take element is resolved for a specific payee.

Using payee overrides, you can:

- Override variable elements used by a specific entitlement/take assigned to a payee.
- Override a variable for *all* elements that use the variable (not just one entitlement or take assigned to a payee).
- Override supporting elements associated with a payee.

Understanding Processing Rules for Payee Overrides

For payee overrides, the system looks at segment end dates (or period dates if there's no segmentation) for a payee to determine if a supporting element override is used. The end date must be greater than or equal to the segment end date in order for it to be processed. Unlike pay entity and pay group, the system doesn't look at the **Definition as of Date**.

Example: Segmentation and Payee Supporting Element Overrides

Two payees have the same override.

- Payee 1 has no segmentation.
- Payee 2 has segmentation. Segment 1 is January 1–15. Segment 2 is January 16–31.
- The pay period is January 1–31.
- VR1, a variable element, is defined as 50.
- VR1 has a payee-level override of 100 beginning on January 16.

For Payee 1, the value of VR1 is always 100, because there's no segmentation.

For Payee 2, the value of VR1 is 50 for Segment 1 and 100 for Segment 2.

Related Links

[Payee Overrides and Segmentation](#)

Supporting Elements Page

Use the Supporting Elements page (GP_PAYEE_SOVR) to override the value of a bracket, date, duration, formula, or variable element that's associated with a payee. Whenever the system resolves an element for the payee, it uses the override value that you select.

Navigation:

Global Payroll & Absence Mgmt > Payee Data > Create Overrides > Supporting Elements > Supporting Elements

The Supporting Elements page is similar to the Pay Entities - Supporting Elements Override page, but the processing rules differ.

Related Links

[Defining Pay Entity Overrides](#)

Defining Pay Calendar Overrides

When defining a calendar for an absence process, you can enter instructions for two types of overrides. You can:

- Specify any absence elements to exclude from processing for all payees.

Enter these instructions on the Calendar - Excluded Elements page.

- Override the value of brackets, dates, duration, formulas, and variable elements on the Calendar - Overrides page.

In this case, begin and end dates aren't used, on the assumption that the override applies to the calendar period.

Related Links

[Defining Pay Entity Overrides](#)

[Calendars - Supporting Element Overrides Page](#)

[Entering Calendar Override Instructions for a Payee](#)

Defining Overrides through Elements

The Update Via Element feature is used to control which elements can be updated by another element. You can update an element by means of another element in four places in the application:

- Arrays (through the Map Retrieved Fields to Variable Elements fields on the Array - Field Map and Keys page).
- Brackets (through the Return Column fields on the Bracket Search Keys/Return Columns page).
- Dates (through the Date Extract fields on the Date Extract page).
- Formulas (through the Assign To columns on the Formula - Field by Field Definition page).

Resolving Overrides in Batch Processing

This topic discusses overrides in batch processing.

The following table describes how overrides to supporting elements are resolved during batch processing.

| Program | Process |
|-------------------------|---|
| Payee Data Manager Page | Resolves hierarchy between pay entity, pay group, payee, and calendar supporting element overrides and loads the override with the highest priority into a supporting element override/value array. |

| Program | Process |
|-------------------------------|--|
| PIN Manager Page | <p>Checks to see if the supporting element is resolved.</p> <ul style="list-style-type: none"> • If the element isn't resolved, the Payee Data Manager looks for a supporting element override. <ul style="list-style-type: none"> • If a supporting element override exists, the override value is used. • If no supporting element override exists, the PIN resolution program is called. • If the element is resolved, the PIN manager checks the RECALC logic. <ul style="list-style-type: none"> • If RECALC = NO, the PIN manager returns the previously resolved value. • If RECALC = YES, the system looks for a supporting element override. If none exists, the PIN manager calls the PIN Resolution program to resolve the element. |
| Element Assignment Page | <p>An array, formula, bracket, or date extract can assign a value to another element. In this case, the element is considered resolved.</p> |
| Entitlement/Take program Page | <p>Applies primary element overrides, then payee/element overrides, as applicable, to a supporting element used by take or entitlement elements.</p> <p>For each type of override, the program saves and stores the current value of the supporting element before assigning the override value. Say a primary element override and a payee/element override exist for Variable A. The system stores the current value of Variable A (5), retrieves the primary override value (6), stores the current value of Variable 1 (6), retrieves the payee/element override value (3), and so on.</p> <p>When the override is no longer in force, the saved value of the supporting element is restored—in our example, 5.</p> |

Managing Element Eligibility and Resolution

Element Eligibility

This topic discusses how the system determines which elements are eligible for resolution.

The system determines which absence take, and frequency-based entitlement elements that it encounters on a process list are eligible for resolution, using the eligibility program, which applies eligibility tests.

- If the element passes, the system sets the eligibility switch to Yes and a process switch to Yes. The Process List Manager calls the PIN Manager to resolve the element.
- If the element is ineligible, the process switch is generally set to No and the element isn't resolved.

This diagram illustrates what the system checks to determine element eligibility.

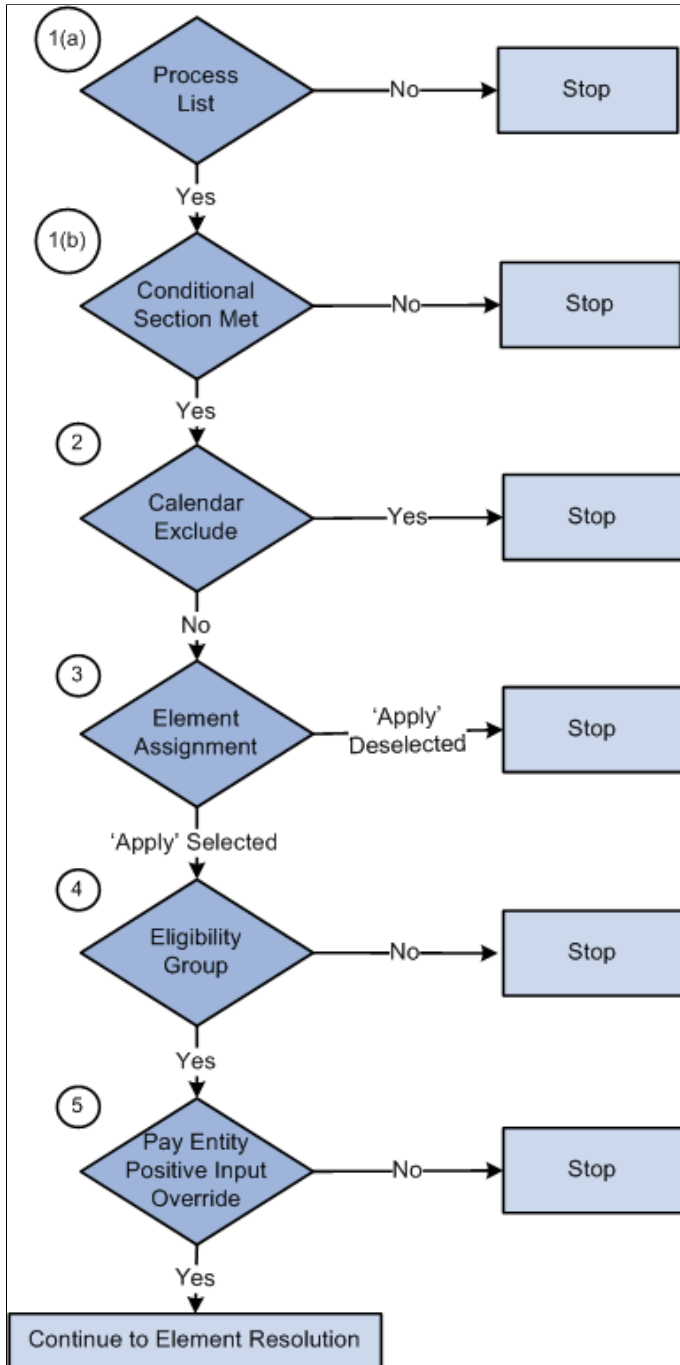

To determine element eligibility the system checks:

1. Process list.

The process list provides the first test of eligibility. With the exception of absence-based entitlement, the element must be in a section of the process to be eligible for resolution.

Process lists can specify conditions under which sections are resolved. If a section isn't resolved because the required conditions are not met, no further processing occurs for that section's elements.

2. Calendar exclude.

The eligibility program checks to see if you've entered instructions to exclude the element from the calendar that's currently being processed. If the element is excluded, the eligibility switch is set to No. The element is not resolved. (If you exclude an element, you can still assign it a value in a formula.)

3. Element Assignment.

There are two functions of an element assignment. The first is to assign an element to a payee. The second allows you to override the element definition for a payee.

The system checks for instructions that assign or override the element at the payee level; entered through the Entitlement/Take Assignment page.

If there is no element assignment the system checks the eligibility group for the element (see step 4).

If there is an element assignment with the **Apply** check box selected the system checks the eligibility group (see step 4).

If there is an element assignment with the **Apply** check box not selected for an element, the eligibility program sets the process switch to No. The element will fail eligibility even if the element is in the payee's eligibility group. In this way, the user may override the element's eligibility definition.

Note: When adding an element to an eligibility group, you can specify that the element will only pass eligibility if there is input at the payee level for that element. This applies to both positive input and element assignments. The lack of an element assignment in this case causes the element to fail eligibility (see step 4).

4. Eligibility group.

Elements are added to an eligibility group and designated as payee level or by eligibility group. (Absence-based entitlement elements do not need to be included in an eligibility group.) Elements designated at the payee level require input at the payee level for that element. This is accomplished through the use of element assignments (noted in step 3 above).

If there is an element assignment and the **Apply** check box is selected, and the element is in the payee's eligibility group, the system sets the process and eligibility switches to Yes.

If there is no element assignment, the system checks if the element is in the payee's eligibility group designated *By Eligibility Group* and sets the process and eligibility switch to Yes. If the element is not in the eligibility group, processing of the element stops.

5. Pay Entity override.

If you've enabled positive input overrides for the pay entity (on the Pay Entity - Processing Details page), the element is eligible for resolution even though it is not in the payee's eligibility group.

Related Links

[Calendars - Excluded Elements Page](#)

[Understanding Processing Elements](#)

Element Resolution

This topic provides an overview of element resolution and discusses:

- Definition as of date.
- Begin and end dates.
- Generation control.
- Overrides.
- Recalculate options.

Understanding Element Resolution

There are many factors that affect the resolution of an element that meets the eligibility criteria. In general, there's an element resolution program for each element type.

Definition as of Date

All effective-dated elements contain a **Definition As Of Date** field, which tells the system which effective-dated row to use when retrieving an element definition. You provide the **Definition As Of Date** information on the Element Name page. If, for example, you select *Calendar Period Begin Date*, the system retrieves the element definition that was in effect as of the calendar period's first day.

Related Links

[Understanding the Process of Selecting Definition As Of Dates](#)

Begin and End Dates

Begin and end dates are used with override instructions, specifying the period during which an override applies. Processing rules for begin and end dates vary, depending on the type of override that's being processed.

Related Links

[Begin and End Date Logic for Overrides](#)

Generation Control

Generation control enables you to further control whether an absence entitlement, or entitlement adjustment is processed for a payee. You define the criteria under which elements should be resolved. Criteria can be based on HR status, run type, segment status, and other parameters.

For each parameter, you select whether the entries exclude or include the element during batch processing. Each payee must pass all generation control conditions for the element to be processed.

Related Links

[Defining Generation Control Elements](#)

Overrides

You can override a value or an element definition at various levels. For example, you can override primary elements (entitlements and takes), at the payee level and exclude an element from the process list for all payees, by using the calendar exclude feature.

You can not allow payee level overrides for an element by clearing the Payee check box on the Element Name page, Override Levels group box.

If there are several levels of overrides for an element, the system follows a hierarchy during processing.

Related Links

[Understanding Overrides](#)

Recalculate Options

The **Always Recalculate** option on the Element Name page, and the **Recalculate** option on the section component determine the recalculation options.

If you select **Always Recalculate** on the Element Name page, the system recalculates the element whenever it encounters it in the calculation process. So when you're updating a formula and recalculating or resolving it, the system uses the previously resolved value of the element if this check box is cleared. **Always Recalculate** applies only to the period that's being resolved.

Note: The Recalculate setting on a section applies only to the element on that section, not to the entire element resolution chain. In other words, it does not apply to the elements used by the parent element.

PIN Manager Logic

When the PIN Manager is called to resolve an element, it:

1. Checks to see whether the element has already been resolved for the current time frame (segment or slice).
2. If the element isn't resolved, it calls the appropriate element resolution program to resolve it.
3. If the element is resolved, the system checks the recalculation logic.

Recalculation Logic

The recalculation logic is as follows:

1. The system reads the **Always Recalculate** check box on the Element Name page.

If the check box is selected, the appropriate element resolution program is called; if it isn't, the system takes the next step.

2. If the PIN Manager was called from the process list, the PIN Manager reads the **Recalculate** check box from the section of the current element.

If the check box is selected, the appropriate element resolution program is called. If the check box isn't selected, the PIN Manager returns the previously resolved value for the element. The element isn't recalculated.

Example 1

You assign a value of 10 to variable V1 in formula F1 and use V1 in a different formula, F2. If V1 has **Always Recalculate** selected, the following occurs:

When the formula program calls the PIN Manager to get the V1 value, it determines that V1 is resolved. Because **Always Recalculate** is selected, the PIN Manager calls the variable element resolution program to resolve the element. V1 is resolved to whatever the definition contains. The value assigned to V1 from F1 is lost.

If you clear the **Always Recalculate** check box for V1, the value assigned to V1 from the formula isn't lost. The PIN Manager, called from F2 to resolve V1, determines that V1 is resolved. Additionally, it determines that **Always Recalculate** isn't selected and returns the previously resolved value to the formula program.

Dates, arrays, and brackets can assign values to variables. For proper calculation, you must consider recalculation logic.

Example 2

In this example, the **Always Recalculate** check box must be selected. During resolution of a count element, daily processing occurs. The PIN Manager is called to resolve the formula, which isn't used elsewhere, once each day. The formula is resolved for the first day. On the second day, the first-day value is used, unless **Always Recalculate** is selected for the formula.

Related Links

[Understanding Retroactive Processing](#)

Processing Absences

Understanding Absence Processing

This topic discusses:

- The absence entitlement process.
- The absence take process.
- Absence processing features.
- Absences and segmentation.
- Absences and retroactive processing.
- Preparing to run the entitlement or take process.
- Absence processing preparations.
- Absence processing sequence.
- Absence processing phases and options.

The Absence Entitlement Process

This process updates frequency-based entitlements for payees and makes entitlement available. For example, if entitlement is granted monthly, you run the entitlement process once a month, even if you run weekly payrolls. You do not run this process for per-absence entitlements because they are updated by the Take process. You can run the entitlement process before or after the take process.

The Absence Take Process

During this process, the system looks at each daily record and determines the amount of time that should be paid or unpaid, according to your absence rules. It converts paid and unpaid units to positive input and adjusts entitlement balances. The take process creates daily data and uses system elements in daily data. These two aspects of the take process are discussed below:

Daily Data

When you run the take process, one of the first things the program does is *expand* each absence event in the process list that occurred for a payee during the absence processing period (or current segment, if the processing period is segmented). Expanding the event means that the system creates a detailed row of data for each day of the absence in the GP_RSLT_ABS record. We call these rows *daily data*.

The take process expands each event that includes a date in the current segment. It creates a row for each day of the absence event, including days that fall outside the processing period. The system also populates

the work schedule and holiday schedule system elements for the day before and after the absence, if the payee was not absent on those days. If the payee was absent the day before or the day after the reported absence, other absence-related system elements can be populated, depending on your rules.

For example, assume that the processing period is May 1 to 31, and there is no segmentation. If the payee is absent from May 5 to May 6 and again from May 29 to June 2, the take process creates two rows of daily data for the first absence and five rows for the second absence.

This graphic illustrates how daily data is created for each day of an absence event.

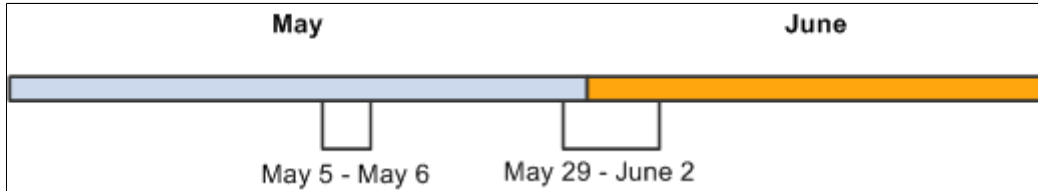

Even though the system creates a row of daily data for each day of an absence event, this does not mean that each day is processed. The entire event is expanded so that the system has all the information it needs to accurately evaluate each absent day. Only those days that occurred during the processing period are processed. Using the above example, the system would process the following absent days: May 5, 6, 29, 30, and 31.

Sources of Daily Data

Data that populates the daily data row initially comes from two sources:

- The payee's work and holiday schedules, which provide the day of the week, scheduled hours, and holiday type.
- The absence event, which provides the absence take, begin and end dates, partial days absent, if applicable, and other information.

The following graphic illustrates the sources of daily data.

| | | Daily Data | May 5 | May 6 |
|---------------------|---|--|----------|----------|
| Schedule | → | Scheduled Hours | 8 | 8 |
| | → | Day of week | Monday | Tuesday |
| | → | Holiday Type | Standard | Standard |
| Event | → | First day of absence | Y | N |
| | → | Last day of absence | N | Y |
| Take Process | → | Hours absent, if less than scheduled hours | 0 | 4 |
| | → | Beginning entitlement balance | 2 | 1 |
| Entitlement Process | ↑ | Day count | 1 | 1 |
| | ↑ | Units that should be paid | 1 | 1 |
| | ↑ | Units that satisfy the wait period | 0 | 0 |
| | ↑ | | | |

The take process also contributes to the daily data. When it applies the absence rules—defined by your absence elements—to the event and schedule data, it derives a set of results that populates the daily data. The results include the beginning entitlement balance, absent units, paid and unpaid units, ending balance, and other information.

The *day formula*, which you create and assign to your take rule, is what drives the results. This formula interprets each day of the absence and returns the number of units that the absent day represents; for example, four hours or one day. Once the system knows the absence *day count*, it can compare the count to the entitlement balance, determine whether a wait period or any other requirements for payment have been met and determine whether any part of the absent day should be paid. It can also calculate the ending entitlement balance.

The Role of System Elements in Daily Data

Much of the daily absence data is stored by system elements—a collection of predefined elements.

- Using System Elements in Formulas.

When you define a take element, you identify the day count formula that the system will use to calculate the number of units that the payee was absent for the day being processed. The formula makes use of any information that is stored in the daily data, including—in some cases—data from the day before or after the day that is being evaluated. For example, three system elements store a payee's scheduled hours:

- SCHED_HRS captures the number of hours that the payee was scheduled to work for the day that is being evaluated.
- SCHED_HRS_DB captures the number of hours that the payee was scheduled to work the day before.

- `SCHED_HRS_DA` captures the number of hours that the payee was scheduled to work the day after.

You might create a day count formula that uses the prior or next day's values in its calculations. Or you might create a day count formula that uses the value of the `SCHED_HRS` element to calculate the day count.

Depending on what absence features you want to use, you might need to create other formulas. Any of these formulas can make use of the daily data that is captured by the system elements.

- Using User-Defined Fields.

User-defined system elements enable you to capture and use absence data that is specific to your organization. Data that is entered into these fields is stored by system elements and added to the Daily Data records during the Take process. As is true of all system elements, the data captured by these elements can be used by any absence formula. Each of the following pages includes a set of user-defined fields:

- Absence Event Entry
- Take Calculation
- Shift

Absence Processing Features

This topic discusses:

- Process lists.
- Iterative processing for preliminary absence runs.
- Stream processing.
- Group lists.
- Troubleshooting tools.

Process Lists

Once you've finished setting up your absence system, you're ready to run an absence process. Whether you're running the process for absence take or absence entitlement, the steps are the same. Your process list and calendar definitions determine who and what gets processed. Useful features of process lists include:

- The absence period can be the same as or different from the pay period. For example, January absences can be paid in January or February. You specify the target calendar pay for each absence process.
- You can run the entitlement and take processes together or separately.
- More than one take process can target the same pay calendar. For example, vacations taken in January and sick time taken in February can be paid in February. To accomplish this, create two absence

process lists, one for vacations and another for sick time, and attach each process list to a separate absence calendar. On each absence calendar, select the pay calendar as the target calendar.

- The system can process absence takes according to their sequence on the process list or in chronological order. To process absences in chronological order, you include take elements in an absence take section of a process list.

Iterative Processing for Preliminary Absence Runs

Iterative processing enables you to process complex, preliminary absence runs quickly with minimal demands on system resources. You launch an Identify phase that flags each payee that meets the selection criteria for your absence run, then launch a Calculate phase that computes absence take or entitlement, as applicable, for all *identified* payees. After reviewing the results and making the necessary corrections, you rerun the Calculate phase for payees that have had changes since the last run.

Stream Processing

Stream processing is an optional feature that you can use to reduce processing time. You divide payees into subsets, based on their employee IDs, so that the system can perform calculations for multiple sets of payees at the same time.

Group Lists

Group lists are user-defined subsets of the payee population that are scheduled for processing. This feature enables absence administrators to work concurrently with different sets of payees in the same pay group.

Troubleshooting Tools

When you run absence calculations, you can generate an element resolution chain that shows, by payee, how and in what order each element was resolved. This chain also shows how long it took to resolve each element on the process list. Significant system resources are needed to produce an element resolution chain, so we recommend that you use this feature for problem solving only.

Related Links

[Creating Process Streams](#)

[Creating Group Lists](#)

[Viewing an Element Resolution Chain](#)

Absences and Segmentation

When you run the take process, the system assigns an instance number to each event, based on the following rules:

- If **Multiple Instances** is selected on the Absence Take - Calculation page, the system assigns a separate instance number to each like event that falls within the same absence period.
- If **Multiple Instances** is not selected, the system assigns the same instance number to all like events that fall within the same absence period.

When the absence element that is associated with the take element is segmented, the take process creates multiple instances, regardless of whether you selected **Multiple Instances**. Multiple instances are also created if the percent defined for the take element changes. (Percent is defined on the Generate Positive Input Member List on the Absence Take - Day Formula page.)

Example

Payee A is absent from January 10 to 17. The absence element is segmented as shown below. The event is divided into the two instances.

This graphic illustrates how the system divides an event into multiple instances due to segmentation.

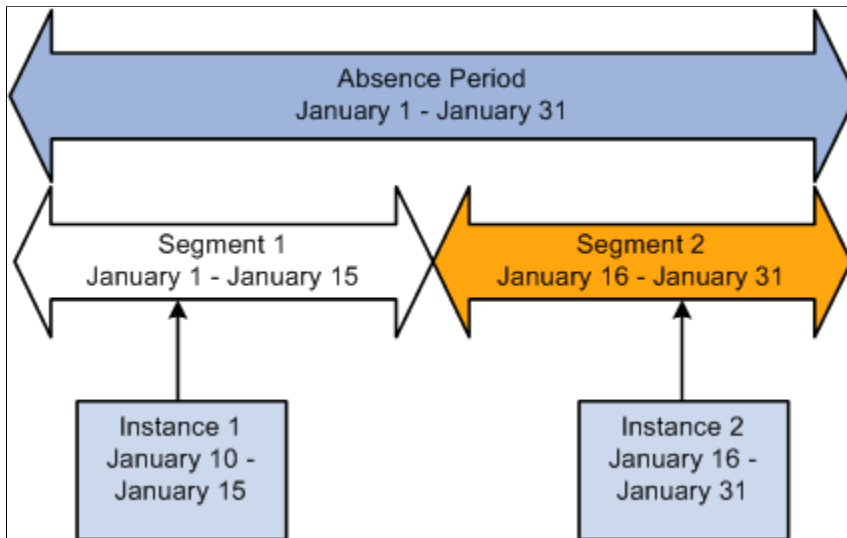

Absences and Retroactive Processing

This section describes how absences work with retroactive processing.

- Setting Up Triggers for Absence Events.

Triggers are the mechanism that Absence Management uses to detect changes to data that result in some type of system action. We recommend that you create retro and iterative triggers so that the system recognizes the online changes that users make to absence events through the Absence Event Entry page (the GP_ABS_EVENT record). Then iterative or retro processing is triggered whenever you add, delete, or update events.

- Retro Processing Method.

Retro processing of absence calendars is carried out using the corrective retro method. Retro processing creates a new version of the generated positive input results and new versions of the daily absence data (GP_RSLT_ABS). For example, if an absence event occurs from 1 to 5 January (when it was originally processed), the event is represented by five rows of data in the daily record, each named Version1. If you change the end date to 7 January, 7 rows appear in Version 2 of the results.

Preparing to Run the Entitlement or Take Process

Following are the steps to prepare for running the entitlement and take processes:

1. Create one or more absence process lists to define the absence take elements or frequency-based entitlement elements that are to be resolved during processing.
2. Associate the process list with a run type.
3. Create a calendar for the absence processing period.
4. Attach the calendar to a calendar group ID.

This diagram illustrates the steps to prepare for running the entitlement and take processes.

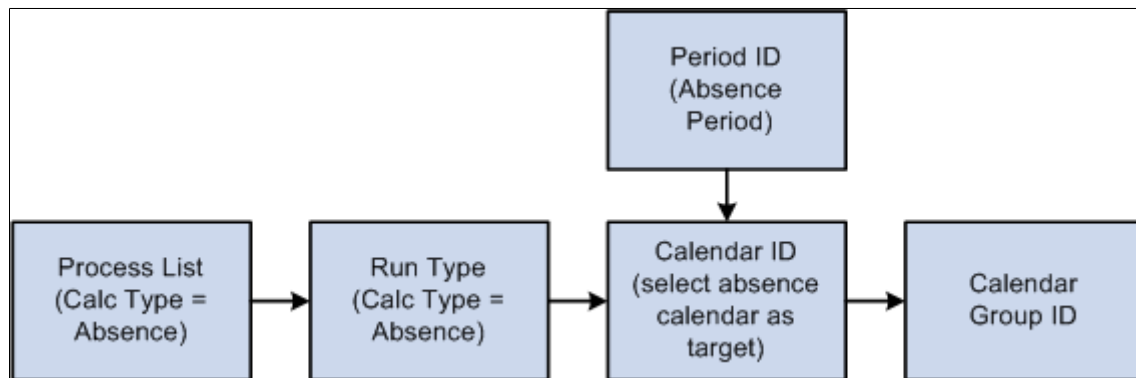

Typically, you create process lists and attach them to run types when you implement Absence Management. Then perform the remaining tasks on a regular basis.

After defining the Calendar Run ID, you're ready to start the process. Complete the Run Control page and use PeopleSoft Process Scheduler to start the process.

Absence Processing Preparations

This illustration shows the steps to prepare for absence processing.

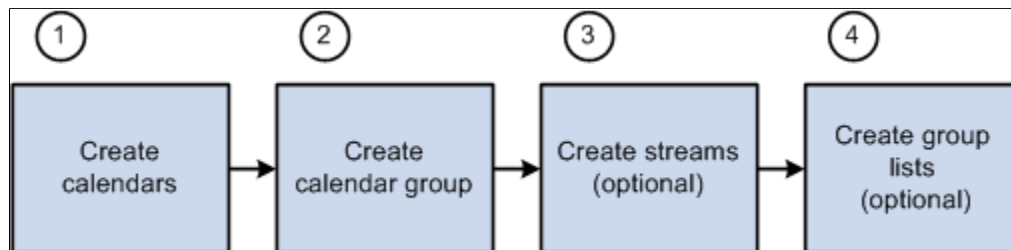

Here are the steps to prepare for absence processing:

1. (Required) Create calendars.

Calendars tell the system which pay group, run type, process list, and calendar period to process. You define pay groups, run types, and process lists during system implementation. You can define calendar periods during implementation or when you set up your calendars.

Important! You should not edit fields on the Calendar Period, Calendar, or Calendar Group ID pages after you initiate processing (other than to add payees to the Calendar, if you selected the **Listed Payees** option). To make changes to those pages, you must cancel the absence run.

2. (Required) Create the calendar group ID.

The calendar group ID identifies the set of calendars to run together and the sequence in which to process the calendars. If you want to use stream processing, you must indicate that when setting up the calendar group ID.

3. (Optional) Create streams.

To use stream processing, identify the range of employee IDs for each stream. Stream set up is a one time process that may require the assistance of a database administrator.

4. (Optional) Create group lists.

To use the group list feature, clerks who run the absence process select the payees for each group list. (Group lists are tied to user IDs.)

Absence Processing Sequence

This illustration shows the absence processing steps.

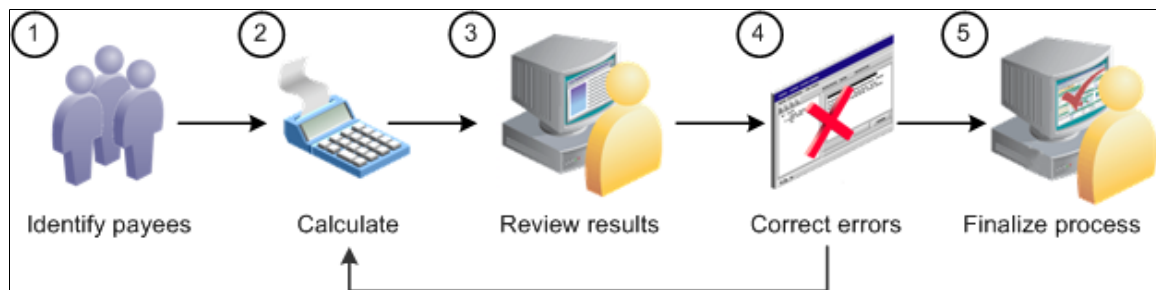

Here are the steps for processing absences (use the Payroll/Absence Run Control page for steps 1, 2, and 5):

1. Identify payees (Identify phase).

The absence cycle begins when you run a process that identifies all payees that are to be processed.

2. Perform calculations (Calculate phase).

This phase computes each payee's absence take or entitlement units for an absence run.

3. Review results.

If the system encounters problems during the Calculate phase—for example, invalid element definitions or payee eligibility problems—it places the payee in error. You can use various pages to review summary results, errors, and warning messages.

4. Correct any errors and recalculate.

To correct errors, you may need to update the Positive Input pages or make changes to the data in other applications that are integrated with Absence Management, such as HR or Time and Labor. You can then run the Calculate phase again to process only the payees that need to be recalculated.

5. Finalize the run.

When you're satisfied with the processing results, run the Finalize phase to close the calendar group ID.

Absence Processing Phases and Options

This section explains in detail some of the steps in absence processing.

Identifying Payees

You begin an absence run by selecting the Identify phase on the Payroll/Absence Run Control page. The Identify phase loops through each calendar that is linked to the calendar group ID and finds all the payees that belong to the pay group that you identified when setting up the calendars. It then identifies the subset of payees that meet the payee selection criteria on the calendars.

You run the Identify phase once per calendar group ID (or once for each stream, if you're using stream processing). Later, if you add new hires, remove terminated payees, enter positive input, or make other changes that affect payee eligibility, the system detects the changes by looking for iterative triggers when you run the Calculate phase. (You must define iterative triggers for the types of changes to the Job record that you want the system to detect.)

For example, after running the Identify phase, you add five new hires to the pay group. As each new hire is added, the system creates a trigger. When you run the Calculate phase, the system sees the triggers for the new hires and includes them in the population of payees to be processed.

A calendar group ID is considered *open* from the time that you launch the Identify phase until you run the Finalize phase.

Calculating Payees

Once you identify payees, you can perform absence take or entitlement calculations. The system calculates one payee at a time, calendar by calendar. If a calendar that is associated with a payee is segmented, the system calculates absences each segment before calculating the payee's absences in the next calendar. After the system has calculated a payee's absences across all calendars, it continues to the next payee.

Usually you run the Calculate phase several times for the same calendar group ID, first for the entire population of payees that you selected during the Identify phase and then for payees with changes or errors. With each iteration, you identify which payees you want to calculate by selecting one of these options:

- Calculate

This is the Calculate option that you'll select most often. It instructs the system to identify all payees with iterative triggers, including new hires and transfers, payees placed in error during a previous calculation, and those for whom you've manually entered processing instructions using the process indicator.

- Recalculate All

Occasionally, you might need to recalculate every payee that is associated with a calendar group ID, stream, or group list. The **Recalculate All** option instructs the system to delete existing calculations

and calculate each payee again without identifying the payees; that is, without trying to determine whether each payee still meets the payee selection criteria.

Freezing and Unfreezing Calculations

If your organization is like most, you have a short window of time between the day that you start running the absence process and your cutoff date. At some point, you might want to stop processing payees with iterative triggers (for example, those with salary adjustments) and concentrate on correcting errors so that you can finalize your absence run. To do this, you instruct the system to freeze calculations for the population that you specify. The Calculate phase ignores any subsequent online changes that you make to payees during the pay run and any positive input that you enter later for these payees. (The system keeps the triggers in case the payee is unfrozen later.) However, if you run the **Recalculate All** option after payees are frozen, the payees are recalculated.

You can freeze or unfreeze all payees that are in the current process stream, group list, or calendar group ID by selecting the **Freeze** option on the Payroll/Absence Run Control page or you can freeze selected payees on the Payee Status page.

To freeze calculations for a payee, the following conditions must be met:

- Each absence that is associated with the payee (for all segments of all calendars) must have a calculation status of *Payment Calculated*. If you freeze or unfreeze one segment for a payee, all of the payee's segments for the calendar become frozen or unfrozen.
- The selection status cannot be *Suspended by User*, *Suspended by System*, or *Cancelled*.

Suspending Active Payees

When submitting processing instructions, you have the option to automatically suspend all active payees under certain circumstances so that you can process a special run, such as a one time adjustment for a small group of payees. The Suspend Active option on the run control page controls this feature. For on-cycle processing, this option is available when you run the Identify or Calculate phase (including Recalculate All). For off-cycle processing, this option is selected automatically and cannot be changed.

When the Suspend Active option is activated, the system does the following when it processes each payee:

- Checks to see if the payee is associated with another open *on-cycle* calendar group.

When this condition is true, the system checks the payee's calculation status in that calendar group:

- If the status is Identified, the system suspends the payee from that run, so that the payee can be immediately identified and calculated in the new run.
 - If the calculation status is Frozen, the system suspends the payee in the new run that you're submitting.
- Checks to see if the payee is associated with another open *off-cycle* calendar group.

When this condition is true, the system suspends the payee in the calendar group that you just submitted.

Related Links

[Status Codes and Process Indicators](#)

Status Codes and Process Indicators

Status codes and process indicators play an important role in absence processing. Status codes help you monitor and interpret the processing results; process indicators enable you to manually enter processing instructions for specific payees. This section focuses on how the codes are created and how to interpret them.

Status Codes

The system creates two sets of status codes as it identifies each payee for processing:

- One *selection status* code for each payee for each calendar, which it stores on the Process Stat (process status) record. During the first run of the Identify phase, each payee's selection status is set to Active or Inactive to explain why the payee was identified for processing. With each iteration of the Calculate phase, the system updates the status to explain why the payee was included in or excluded from processing.

The system keeps a record of excluded payees only if they were *suspended* or *canceled*. If the payee simply no longer qualifies for selection (for example, the payee is assigned to a different pay group), the system does not record this, and the payee's process and status records are deleted.

- One *calculation status* code for each payee, per calendar segment, which is stored on the Segment Stat record. If a calendar has no period segmentation, a payee has one calculation status. Calculation status tells you the most recent action that has been completed for the segment, for example, identified, calculated, or frozen. Before you run the Calculate phase for the first time, the status code for each identified payee is *Identified*.

This diagram illustrates the status codes created by the system when payees are identified for processing.

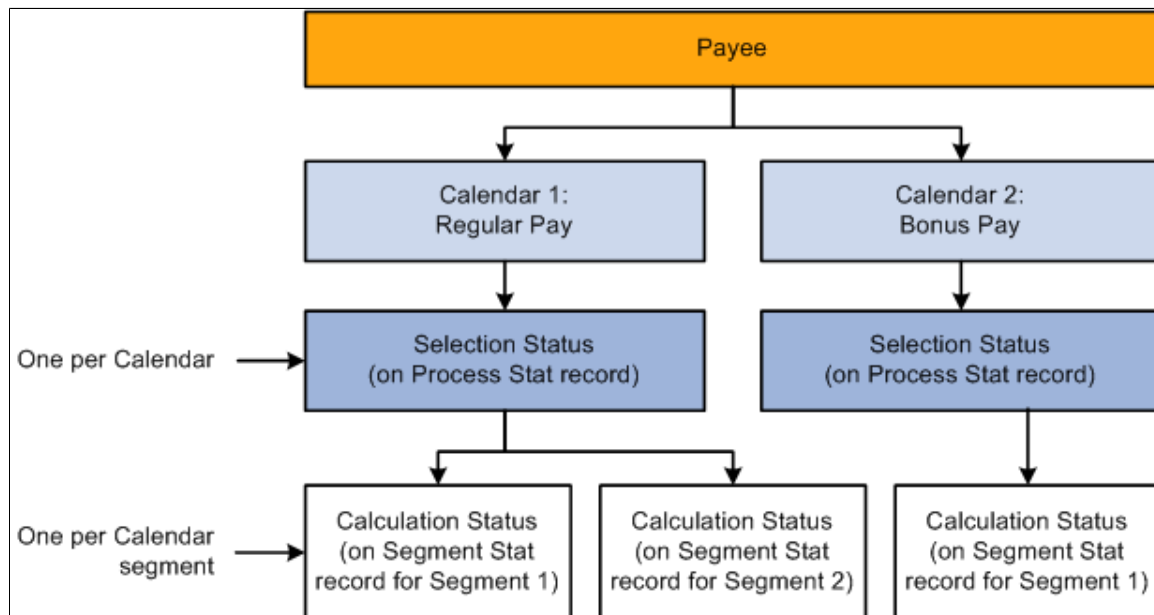

Process Indicators

Sometimes you might need to cancel a payee from an absence run; temporarily suspend a payee from processing; freeze, unfreeze a payee; or take some other action at the payee level. You do this by entering a process indicator that tells the system what action to take during the next iteration of processing. For example, if the selection status for payee A is *Active*, and you need to cancel that payee from the absence run, set the payee's process indicator to *Cancel*. The next time you run the Calculate phase, the system deletes all calculation results for payee A and changes payee A's selection status to *Cancelled*. You update the process indicator on the Payee Status component.

Important! Changing a process indicator updates all of a payee's segments that are in the same calendar group ID.

Status Code and Process Indicator Definitions

The tables below list the status codes and process indicators. Selection status (one per payee per calendar) and calculation status (one per calendar segment) are system-maintained; the process indicator is user-maintained.

| <i>Selection Status</i> | <i>Definition</i> |
|--------------------------------|--|
| Active | Payee was active for at least one day within the calendar. |
| Inactive | Payee was not active within the calendar, but was selected because of positive input, a retroactive trigger, or a forwarded adjustment. |
| Cancelled | You manually canceled the payee from the calendar run. The system doesn't reselect the payee for the current calendar run or a retroactive run. |
| Suspended by User | You manually suspended the payee from the calendar run. The next time you run Calculate, the system tries to reidentify the payee and recalculate the net pay. |
| Suspended by System | The payee is linked to another open calendar group ID. (A payee can be selected for only one unfinalized calendar group ID at a time.) |

| <i>Calculation Status</i> | <i>Definition</i> |
|----------------------------------|--|
| Identified | Segment has been identified for calculation but has not been calculated. |
| Calculation Successful | Segment has been calculated. |

| Calculation Status | Definition |
|------------------------------|---|
| Frozen For Further Calc | Segment is not subject to further calculations unless you unfreeze it or run the Recalculate All phase. |
| Finalized | The calendar run has been finalized. You can no longer make changes. |
| Calculation Error | An error occurred during calculation. |
| Calculation Error — Bypassed | The system did not attempt to calculate the payee because of an error. |
| Calculation Error — By Rule | An error was produced because of a condition that you defined through a message element. |
| Deleted by Process | Segment has been deleted by the process. |
| Has No Payment | Note: This calculation status is not applicable to Absence Management. |

| Process Indicator | Definition |
|--------------------------|---|
| Normal | This initial setting appears after each calculation. It indicates that there are no special processing instructions for this payee. |
| Cancel | The payee will be canceled from the absence process during the next iteration of the Calculate phase. The selection status will be changed to Canceled. The payee will not be identified again unless you change the indicator to Uncancel before finalizing the absence run. |
| Recalculate | All calculations that are associated with the payee's jobs (employee ID and employee record number combination) will be rerun the next time you run the Calculate phase. This is similar to the Recalculate All option on the Payroll/Absence Run Control page, but it applies only to payees that you select. |

| Process Indicator | Definition |
|--------------------------|---|
| Suspend | The payee will be withheld from processing the next time you run the Calculate phase. The selection status will be changed to <i>Suspended by</i> , and all calculation results will be deleted. During subsequent calculations, the system will try to reidentify and recalculate the payee (until it succeeds or you cancel the payee). You do not need to take any action. |
| Uncancel | The system will change the selection status from <i>Canceled</i> to <i>Active</i> , <i>Inactive</i> , or whichever selection status is appropriate and will try to reidentify and recalculate the payee the next time the Calculate phase runs. |
| Freeze | The payee is not subject to recalculation unless you select Recalculate All or Un-freeze on the Payroll/Absence Run Control page or the Payee Status page. |
| Unfreeze | Reverses a payee's freeze status. |

Related Links

[Viewing Payee Status and Updating a Payee's Processing Instructions](#)

Entering Processing Instructions

Pages Used to Enter Processing Instructions and Define Run Control Parameters

| Page Name | Definition Name | Usage |
|--|------------------------|---|
| Calculate Absence and Payroll Page | GP_RUNCTL | Enter processing instructions for a payroll process, an absence take process, or an absence entitlement process. This page is used to run both on-cycle and off-cycle payrolls. |
| Restart Information Page | GP_RUNCTL_SEC | View information about an aborted run, including where the system resumes processing after you fix the problem and resubmit the process. |

| Page Name | Definition Name | Usage |
|--------------------------------------|------------------------|---|
| <u>Debug and Tuning Options Page</u> | GP_RUNCTL_DEBUG_SEC | Generate statistics to improve the performance of the pay run, determine whether the absence and payroll calculation process updates the data in the Processing Monitor, and define COBOL trace parameters. |

See the product documentation for

PeopleTools: Process Scheduler

Understanding Processing Instructions

When you're ready to begin a payroll or absence run, create a run control ID and enter your processing instructions:

1. Access the Payroll/Absence Run Control page.
2. Indicate which payees you want to process (options vary by processing phase).
3. Select the phase of processing to execute (always select the Identify phase the first time). To initiate processing for a calendar group, the calendar group must first be identified.
4. To produce an element resolution chain or generate performance statistics, select the appropriate option.
5. Select the language to use for the Log File.
6. Click the **Run** button to initiate the GP_PAYE PSJob.

GP_PAYE consists of the following processes:

- **GP_PAYBEFORE:** This Application Engine process is intended to perform any desired pre-payroll processing. It includes sections to add country-specific processing logic.
- **GPPDPRUN:** This COBOL SQL process performs the main Global Payroll and Absence Management calculations.
- **GP_PAYAFTER:** This Application Engine process is intended to perform any desired post-absence processing. At the end of GP_PAYAFTER (which runs as part of GP_PAYE), a process request is triggered for TL_ABS_GENPT dynamically. It also included sections to add country-specific processing logic. In addition, this program:
 - Checks to see if the payroll process had been finalized successfully, and if so, calls the program that launches the Report Data process. The Report Data process populates the Global Payroll "EPM" tables with earning, deduction, and accumulator information for all processed payees.
 - Calls a section to extract processing monitor data if the Enable Positive Input Search check box is selected on the Installation Settings Page.
 - Calls a section to extract absence analytics data if the Enable Pivot Grid Analytics check is selected on the Installation Settings Page.

- Calls the TL_ABS_GENPT process, which generates absence payable time for employees that are part of the calendar group. This process is generated as a separate process instance, not as part of the GP_PAYE job. Additionally, this process runs only when the Generate Absence Payable Time feature is enabled on the TL_INSTALLATION page. For more information on the TL_ABS_GENPT process, see the documentation for the “Generate Absence Payable Time Page” (PeopleSoft Time and Labor)

Note: The Description and Process Name (as they appear on the Process Scheduler page) are GP & AM Payroll Job, GP_PAYE. The same name applies to absence and pay runs.

Because processing is iterative, you return to the Payroll/Absence Run Control page several times throughout the calendar group processing cycle to update your instructions. For example, after the Calculate phase runs, you'll want to check the results, make corrections, access the Payroll/Absence Run Control page again (using the same run control ID), and enter instructions for the next phase of processing. Repeat this process as often as necessary until you're ready to finalize the run. The system deletes the run control record each time a processing phase is completed.

If a pay run is aborted, you can correct the problem, use the **Restart Information** link on the run control page to view the restart information, and resume where processing left off. You don't have to start the pay run at the beginning. It is very important to continue using the same run control that was used when the process was aborted. The information needed for the system to start up where it left off is stored on the run control. A new run control should *not* be used.

Calculate Absence and Payroll Page

Use the Calculate Absence and Payroll page (GP_RUNCTL) to enter processing instructions for a payroll process, an absence take process, or an absence entitlement process.

This page is used to run both on-cycle and off-cycle payrolls.

Navigation:

Global Payroll & Absence Mgmt > Absence and Payroll Processing > Calculate Absence and Payroll > Calculate Absence and Payroll

This example illustrates the fields and controls on the Calculate Absence and Payroll page.

Calculate Absence and Payroll

Run Control ID Gp_payroll Report Manager Process Monitor Run

Payroll / Absence Run Open

*Calendar Group ID Q

Stream Number Process Number

Group List ID Language English v

Processing Phases and Options

Identify Calculate Freeze Finalize

Suspend Active Recalculate All Un-freeze Suspend Cancel

Identified Final Calculation

Restart Information Debug and Tuning Options

Save
Return to Search
Previous in List
Next in List
Notify
Add
Update/Display

Payroll/Absence Run

| <i>Field or Control</i> | <i>Description</i> |
|--------------------------|---|
| Calendar Group ID | Select the ID for the set of calendars to process. (The prompt table excludes calendar group IDs that have been finalized.) |
| Open | This is an attribute of the calendar group. The field is stored on the calendar group table. When the calendar group is initially identified, it is considered open, and the check box is selected. Once it is finalized, it will no longer be open, and the check box will be deselected. |
| Stream Number | If you selected the stream processing option on the Calendar Group ID page, the Stream Number field is available. The following conditions apply: <ul style="list-style-type: none"> • If you select Identify (as the processing phase), you must enter the stream number to process. • If you select Calculate, Un-freeze, or Freeze, enter the stream number here or complete the Group List ID field (if you have run the Identify phase for all streams). |
| Group List ID | To calculate, freeze, or unfreeze only payees in a particular group list, enter the group list ID. You can process only group lists that you created with your user ID. |

| Field or Control | Description |
|-------------------------|---|
| Language | Select the language the system uses to display the Log File (which helps the system administrator determine whether a run completes successfully). The default is the Preference Language that is defined for the user. |

See [Creating Process Streams](#).

Processing Phases and Options

Select the processing phase to run. You can run some phases together, such as Identify and Calculate. Sometimes selecting one option makes other options unavailable.

| Field or Control | Description |
|-------------------------|---|
| Identify | <p>Select the first time you run the process. It instructs the system to identify all payees (associated with the calendar group ID, or selected stream, if applicable) that meet the payee selection criteria that is defined on the calendar pages that are linked to the calendar group ID. Otherwise, you can run the Identify phase with the Calculate phase.</p> <p>Once you run the Identify phase, you cannot select this check box again for the same calendar group ID or stream, unless you cancel the entire run. With iterative processing, the system adds and removes payees based on changes that you make to the data, so you don't have to run the Identify process more than once. This is accomplished by the use of iterative triggers. Payees with iterative triggers are reidentified and recalculated when you run the calculate phase.</p> |

| Field or Control | Description |
|--------------------------|--|
| Calculate | <p>Select when you are ready to calculate the payroll or absence units for an absence run. You can run the Calculate phase after or at the same time as the Identify phase. The first time you run Calculate, the system calculates every payee that is flagged by the Identify phase.</p> <p>For each subsequent run of the Calculate phase, you define the subset of payees that you want to process or reprocess by selecting the appropriate check boxes:</p> <p>Select the Calculate check box to reidentify payees and recalculate:</p> <ul style="list-style-type: none"> • Payees that were placed in error during a previous calculation. • Payees that were placed in suspend status. • Payees for whom you manually set the process indicator to <i>Recalculate</i> or <i>Uncancel</i>. • Payees with iterative triggers, unless they are frozen. <p>Select both Calculate and Recalculate All to recalculate the entire population of payees that have already been calculated, including frozen payees. The system reidentifies only payees with iterative triggers.</p> |
| Final Calculation | <p>Select this checkbox if you are running the final calculation prior to finalizing the payroll. This will allow HCM Component Lockdown Framework to lock components and users based on a Process Event Lockdown definition using the Global Payroll or Absence Management process for the "final calculation" phase. For more information about setting up component lockdown, see the "Configuring HCM Lockdown Framework" (Application Fundamentals) topic.</p> <p>This checkbox is enabled only when the Calculate or Recalculate All options are selected.</p> |
| Freeze | <p>Select to freeze payees that have been calculated. (Payees with <i>Identified</i> status are not frozen.) The system freezes all calculations for the selected population. When you run the Calculate phase for this payee again, the system ignores iterative triggers and positive input that were added while the payee was frozen. (If you select the Recalculate All option, however, the system processes the triggers and positive input.)</p> |

| Field or Control | Description |
|-------------------------|--|
| Finalize | <p>Select to close the payroll or absence cycle for the entire calendar group ID. Once you finalize the run, no more calculations are possible.</p> <p>The Finalize phase must be run by itself.</p> |
| Un-freeze | <p>Select to lift the freeze for payees that were frozen. During the batch process, the system resets the calculation status to <i>Calculated</i>. In subsequent runs of the Calculate phase, the system again performs calculations for these payees as needed (the system does not automatically perform calculations for these payees again unless there is a reason, such as a recalculation instruction or an iterative trigger.)</p> |
| Suspend | <p>Select to pull payees from an open payroll run. Suspended payees are given an iterative trigger with a status of unprocessed. You can then include these payees in another run, like an off-cycle or bonus run, before finalizing the open payroll run. Once you return to the open pay run, the system reidentifies and recalculates the suspended payees. Suspended payees do not lose their associated retroactivity.</p> |
| Cancel | <p>Select to invalidate the entire pay run (as if the calendar group had never been run). The system deletes all calculations for payees, restores all data to prior values, and deletes all status indicators.</p> <p>Select this check box after you run the Identify or Calculate phase. If this check box is selected, no other options are available. You cannot cancel a run after payments are finalized.</p> <p>The Cancel phase must be run by itself.</p> |
| Suspend Active | <p>This check box specifies whether to suspend payees from other open calendar groups so that they can be processed in this run. (A payee can only be identified in one open calendar group ID at a time.)</p> <p>For on-cycle processing, the check box is available when you select the <i>Identify</i> or <i>Calculate</i> option. It is deselected, by default.</p> <p>For off-cycle processing, the check box is always selected and you cannot change the setting.</p> |

| Field or Control | Description |
|---------------------------------|--|
| Recalculate All | <p>If you select this check box, also select Calculate. The system deletes the calculation results for all payees from prior runs, including frozen payees, and sets the status indicators to their original values. It then recalculates (but does not reidentify) every payee that has already been calculated.</p> <p>This option is appropriate if you've modified records that are used during processing and that do not create iterative triggers—for example, if you've changed an element's definition.</p> <hr/> <p>Warning! Recalculating all payees can place a heavy load on system resources. We suggest that you select Recalculate All only when you suspect that calculations are wrong for a large number of payees because of bad data, an erroneous element definition, or some other problem with far-reaching consequences.</p> <hr/> |
| Identified | <p>Selected if the Identify phase has been run for all streams. Once all streams are identified, you can use group lists for other phases of processing.</p> |
| Restart Information | <p>If a fatal error, such as a database error, occurs during processing, the processing stops and an error message appears. Click to access the Restart Information page, where you can see where the process stopped and where it will resume after you address the problem. After correcting the error, restart the process. Usually you don't need to cancel the run.</p> |
| Debug and Tuning Options | <p>Click to access the Debug and Tuning Options Page, where you can request Elements or Cobol traces; or generate statistics to improve the performance of the pay run and determine whether the process updates the data in the Processing Monitor.</p> |

Related Links

[Creating Process Streams](#)

[Finalizing a Payroll or Absence Run](#)

[Canceling a Payroll or Absence Run](#)

[Viewing an Element Resolution Chain](#)

Restart Information Page

Use the Restart Information page (GP_RUNCTL_SEC) to view information about an aborted run, including where the system resumes processing after you fix the problem and resubmit the process.

Navigation:

Click the **Restart Information** link on the Calculate Absence and Payroll page.

This example illustrates the fields and controls on the Restart Information page.

GP Run Control Restart Info ×

[Calculate Absence and Payroll](#)

Restart Information

Run Control ID 11

Calendar Group ID GXRTUSA1 199912

Phase Initial

Identify Program Option

Step Run Phase Step Initial

Restart Program

Next Step 0

Restart Number

Restart Empl ID

| <i>Field or Control</i> | <i>Description</i> |
|---|---|
| Phase, Identify Program Option, and Step | These fields identify where processing stopped, if the program made a commit during processing. Run Phase displays <i>Initial, Iterative, Cancel, Identify, Calculate, Finalize, Complete</i> . |
| Restart Program, Next Step, and Restart Number | These fields contain information only if the process was aborted during the Identify phase. |
| Restart EmplID | <p>If the failure occurred during the Calculate phase, this field displays the employee ID number of the first payee that is to be calculated when you restart the process.</p> <hr/> <p>Note: When you restart the Calculate phase for a group list, the system uses the definition of the group list as of the restart time.</p> <hr/> |

Debug and Tuning Options Page

Use the Debug and Tuning Options page (GP_RUNCTL_DEBUG_SEC) to generate statistics to improve the performance of the pay run, determine whether the absence and payroll calculation process updates the data in the Processing Monitor, and define COBOL trace parameters.

Navigation:

Click the **Debug and Tuning Options** link on the Calculate Absence and Payroll page.

This example illustrates the fields and controls on the Debug and Tuning Options page (1 of 2).

x
Help

Calculate Absence and Payroll

Debug and Tuning Options

Run Control ID test
 Calendar Group ID KZ 2021M03

Performance Tuning ?

Update Statistics

Debugging ?

Suppress Bulk Insert
 Trace
 Log SQL Time
 Trace All Elements
 Trace Elements in Error

This example illustrates the fields and controls on the Debug and Tuning Options page (2 of 2)

Payee Selection ?

⌵ 🔍
⏪ < 1-1 of 1 > ⏩ | View All

| | Empl ID | Name | All Calendars | Calendar ID | Extract Trace | | |
|---|---------|------|--------------------------|-------------|--------------------------|---|---|
| 1 | 🔍 | | <input type="checkbox"/> | 🔍 | <input type="checkbox"/> | + | - |

OK
Cancel

Performance Tuning

| <i>Field or Control</i> | <i>Description</i> |
|--------------------------|---|
| Update Statistics | <p>The system leaves temporary tables populated until the end of calendar processing, either through finalization or cancellation, rather than emptying them during the batch payroll process as soon as they are used. This simplifies the process of obtaining accurate statistics from these tables, which in turn enhances performance. The optimum time to update statistics on these tables is when the system has calculated a calendar and that calendar remains open. Updating statistics when all calendars are closed is not recommended because the temporary tables are empty at that point in the process.</p> <p>The Update Statistics check box enables you to update some of the most important temporary tables during batch processing.</p> |

Debugging

| <i>Field or Control</i> | <i>Description</i> |
|-----------------------------|---|
| Suppress Bulk Insert | <p>Select to prevent the application from caching up data for insert into a number of tables. If you receive a SQL error (such as duplicate insert) while inserting duplicate results into a results table, select this check box and run the process again. Doing so enables the system to display the EEMPLID that is causing the error along with the SQL error message.</p> |

Several trace options are available during the Identify and Calculate phase. These options enable you to request an element resolution chain—a file with detailed results of the Identify and Calculate phase—for payees that will be identified and calculated during the next run.

Note: If you are calculating a large number of payees, selecting **Log SQL Time**, **Trace Elements in Error**, or **Trace All Elements** can degrade system performance. We recommend that you use these options for troubleshooting only. (These options require the same level of system resources.)

| <i>Field or Control</i> | <i>Description</i> |
|-------------------------|--|
| Trace | Select if you want to produce an element resolution chain or log SQL time. |

| <i>Field or Control</i> | <i>Description</i> |
|--------------------------------|---|
| Log SQL Time | Select to have the Log File report each time the Payee Data Manager program opens cursors (SELECT statements that return more than one row) for the Job table, Job Dates table, Person Organization table, and the Person Organization Instance table during batch processing. This information can be useful for performance tuning. |
| Trace Elements in Error | Select to produce an element resolution chain that includes only those payees in error. |
| Trace All Elements | Select to produce an element resolution chain that shows how all elements were resolved for the calculated payees. You can determine the intermediate value of every element and the order in which the elements were resolved. When you select the check box Trace, this option is selected by default. |

Processing Monitor

| <i>Field or Control</i> | <i>Description</i> |
|----------------------------------|--|
| Update Processing Monitor | <p>Select to update the data in the Processing Monitor during absence and payroll calculation batch processing.</p> <p>By default, this check box is selected. Deselect the check box to turn off the Processing Monitor update portion of the batch process if you want to disable the feature entirely, or just for a selected phase of the calculation process.</p> <p>For example, if you are running the Identify phase by itself, you don't need to update the Processing Monitor at the same time. Likewise, if you are performing an iterative calculation for a small subset of payees, it may not be necessary to update the Processing Monitor.</p> <hr/> <p>Note: You can also use the Update Processing Monitor Data page to update Processing Monitor data for a specific calendar group.</p> <hr/> |

Payee Selection

Use the Payee Selection block to produce an audit trail 'Resolution Chain' from the element resolution for the specified payees.

This group box appears if:

- Enable Advanced Trace Options is selected on the Configuration Settings page.
- Trace Elements in Error or Trace all Elements are selected.
- Identification phase has been run for the selected Calendar Group ID.

To produce the audit trail even when payroll fails, it will be required that you specify a payee selection.

| Field or Control | Description |
|-------------------------|---|
| Empl ID | Select the employee for whom the resolution chain should be created. If no value is selected in this field, then the resolution chain will be generated for all the employees being calculated. |
| All Calendars | Select this option if you want to generate the resolution chain for all the calendars being executed for the selected employee. |
| Calendar ID | Select the calendar for which the resolution chain should be created. |
| Extract Trace | When this checkbox is selected, the trace content (GP_AUDIT_TBL) along with the setup of the elements executed during the calculation will be generated in a zip file. This zip file will be available from the View Log/Trace page for GP_PAYAFTER process. Elements included in the Elements Masking Setup, will be masked during the extraction process. |

Cobol Log Level

This group box appears if:

1. Enable Cobol Tracing is selected on the [Configuration Settings Page](#).
2. The Identify, Calculate or Recalculate All processing options are selected for the calendar group ID.

| Field or Control | Description |
|-------------------------|---|
| No Cobol Trace | Select to disable the Cobol trace for the calendar group. This option is selected by default. |

| Field or Control | Description |
|-------------------------|---|
| Summary | <p>Select to generate a log of all payees processed in the pay run. The log includes calendar, group list, and stream number details. Use this option to isolate a payee causing a payroll abend. This field is not displayed if only Identify phase is selected.</p> <hr/> <p>Note: Summary trace is applicable only for the Calculate phase. If the Identify and Calculate phases are selected, the Summary field is available. However, if the radio button corresponding to the Summary field is selected, only the summary for the Calculate phase is generated, because summary is not applicable to the Identify phase.</p> <hr/> |
| Detail | <p>Select to generate a comprehensive trace of selected programs for specific payees identified in the summary run. When you select this option, the Trace Pin Number, Trace Program Selection, and Payee Selection group boxes become available.</p> |

This example illustrates the additional trace parameters that are available when you select the **Detail** Cobol log level for Calculate phase.

Cobol Trace Parameters ?

Cobol Log Level

No Cobol Trace
 Summary
 Detail

Trace Pin Number

🔍
1-1 of 1
View All

| | PIN Number | Element Name | Element Type | | |
|---|-------------------------------------|--------------|--------------|---|---|
| 1 | <input type="text" value="999999"/> | | | + | - |

Trace Program Selection

Trace All Available Programs

Select Programs

🔍
1-10 of 41
View All

| | Select Program | Program Name | Description |
|----|--------------------------|--------------|---|
| 1 | <input type="checkbox"/> | GPPUERND | Earning-Deduction Program |
| 2 | <input type="checkbox"/> | GPPUACCM | Accumulator resolution program |
| 3 | <input type="checkbox"/> | GPPUTAKE | Absence Take resolution |
| 4 | <input type="checkbox"/> | GPPUSCHD | Schedule Tracking Program |
| 5 | <input type="checkbox"/> | GPPUENTL | Absence Entitlement resolution |
| 6 | <input type="checkbox"/> | GPPDPDM1 | Load HR data |
| 7 | <input type="checkbox"/> | GPPDPDM2 | Load Historical value and balance accumulator |
| 8 | <input type="checkbox"/> | GPPDPDM3 | Load deltas segment by segment |
| 9 | <input type="checkbox"/> | GPPDPDM4 | Load payee processing sections, partial segmentation triggers, accumulator percents |
| 10 | <input type="checkbox"/> | GPPDPDM5 | Load all payee level input |

Payee Selection

🔍
1-1 of 1
View All

| | Empl ID | Name | All Calendars | Calendar ID | | |
|---|----------------------|------|--------------------------|----------------------|---|---|
| 1 | <input type="text"/> | | <input type="checkbox"/> | <input type="text"/> | + | - |

This example illustrates the additional trace parameters that are available when you select the **Detail** Cobol log level for Identify phase.

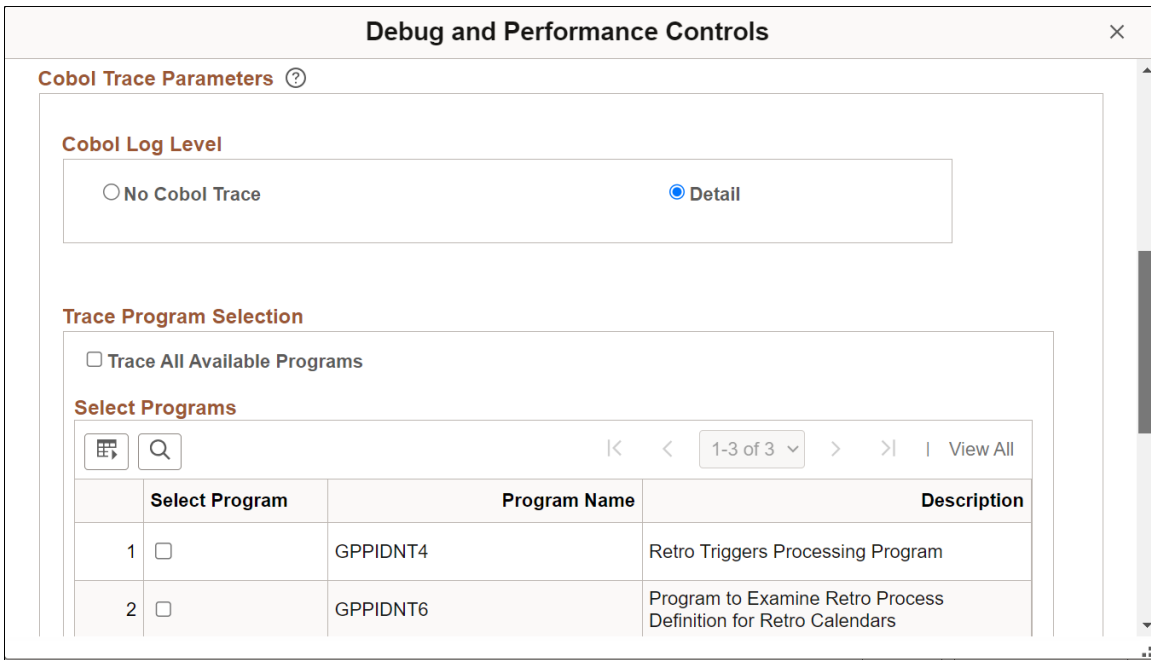

This example illustrates the additional trace parameters that are available when you select the **Detail** Cobol log level for Identify phase.

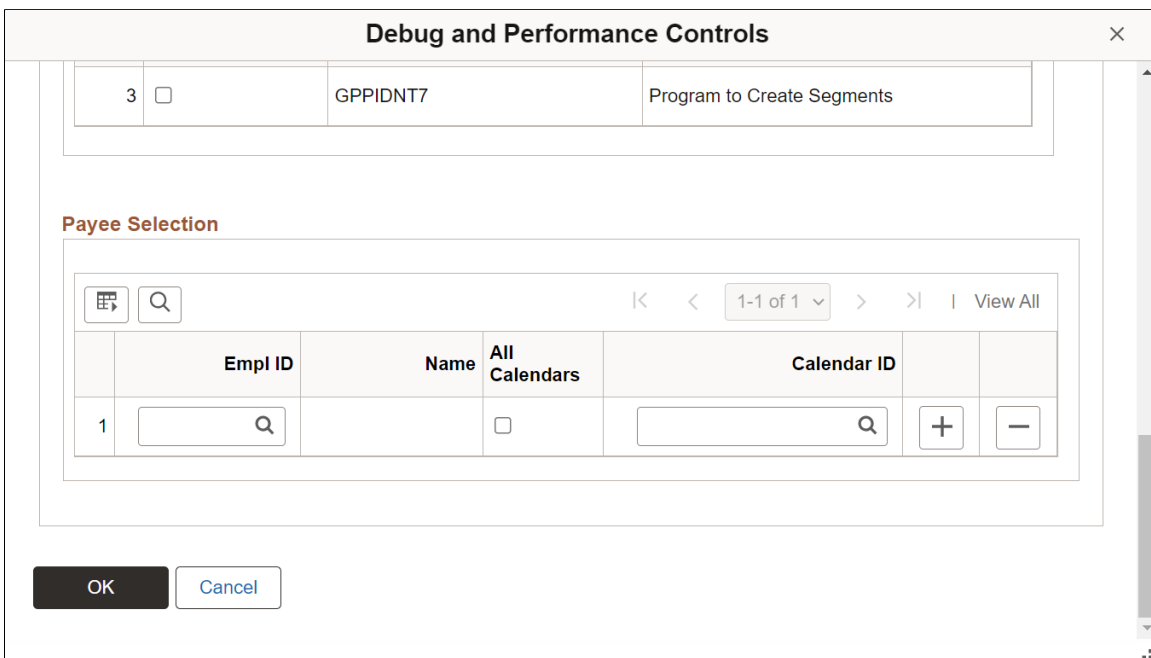

Trace Pin Number

Enter the specific PINs you want to trace.

Note: If Calculate is run individually or in conjunction with Identify, the Trace PIN Number grid will appear. If Identify is run alone, it will not appear.

Note: It is recommend that you limit your trace to 10 PINs or less. Otherwise, the trace file could become too large to analyze effectively.

Trace Program Selection

Select the specific programs that you want to trace.

| Field or Control | Description |
|-------------------------------------|---|
| Trace All Available Programs | Select to trace all of the programs corresponding to Identify or Calculate phase. |
| Select Programs | If both the Identify and Calculate phases are checked, this grid lists all the programs corresponding to both phases. If only the Calculate phase is selected, the programs corresponding to only the Calculate phase are listed. If only the Identify phase is selected, the programs corresponding to only the Identify phase are listed. |

Note: You cannot select PINs and Programs for tracing at the same time. Choose either PINs or Programs for tracing.

Payee Selection

Enter the specific payees that you want to trace.

When either Identify or both Identify and Calculate phases are selected, the Employee ID field lists all employees from the Job who belong to all the Paygroups that are part of the calendar group ID chosen in the Run Control page.

When Calculate phase is only selected, the Employee ID field lists all employees who are already identified.

If the Identify checkbox is checked, the Calendar ID prompt displays all calendars that are part of the specified Calendar Group ID. When the Identify and Calculate checkbox is checked, the calendar ID prompt displays all calendars that belong to the calendar group ID. When only the Calculate checkbox is checked, it indicates that the calendar group has already been identified. In this case, only the relevant calendar IDs that have been identified for that payee will be displayed.

Note: It is recommend that you limit your trace to five payees or less. Otherwise, the trace file could become too large to analyze effectively.

Analyzing the Trace File

When COBOL trace is enabled, the payroll process generates GPCBLDBG.trc trace log file. The best way to analyze the file is with the COBOL Log Viewer, which enables you to search and filter the trace log.

This is an example of the COBOL Log Viewer.

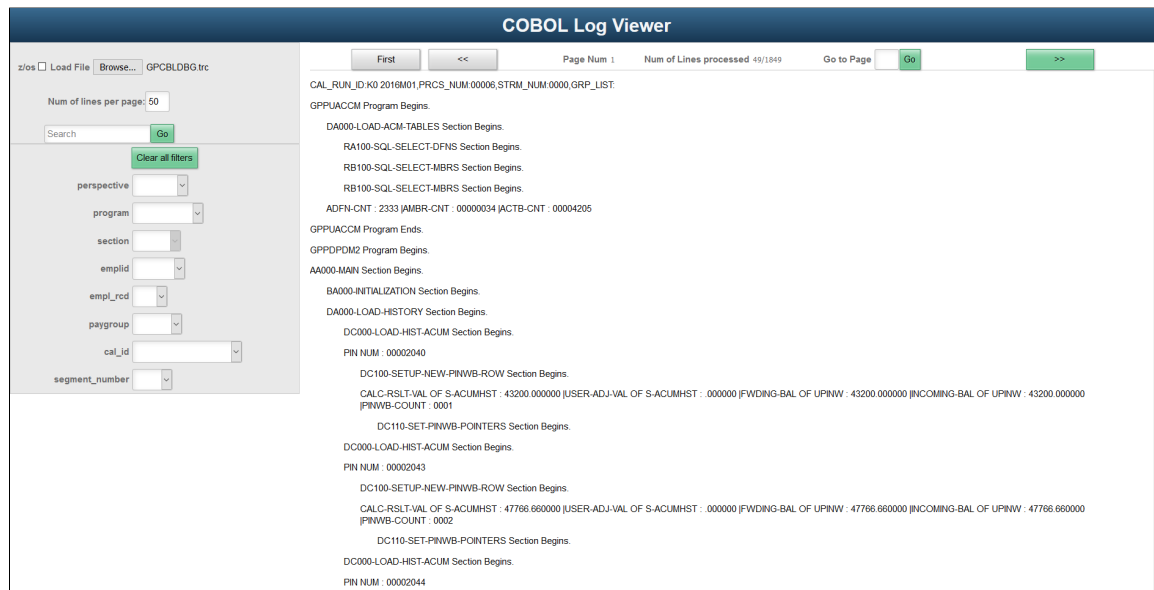

You can download the COBOL Log Viewer (TracingTool.html) from [My Oracle Support](#).

Related Links

[Configuring the Processing Monitor](#)

[Update Processing Monitor Data page](#)

Creating Group Lists

A group list defines a subset of payees that you can process at the same time. Group lists are linked to user IDs. You can process any group list that you create. You can use group lists with the Calculate, Freeze, and Unfreeze phases of processing after you run the Identify phase for the calendar group. Groups lists and streams are mutually exclusive: if you select a group list for processing, you cannot also select a stream number, and vice versa.

Following are some key characteristics of group membership:

- You can update the members of a group list at any time. The system uses the current definition of the group list.
- The system ignores payees in a group list that are not associated with the absence calendars that are being processed.
- You can include a payee in more than one group list; however, we recommend that you do not.

If users start concurrent processes for the same calendar group, but with different group lists that include the same members, the second process stops soon after it begins. This enables the user to remove duplicate payees from the group list.

Warning! If you run the Calculate phase by group list only, the system doesn't detect changes to the payees that are added or removed from a calendar after the initial Identify phase. To process overlooked payees, run the Calculate phase for the entire population (without group lists) before finalizing the run.

Page Used to Create a Group List

| <i>Page Name</i> | <i>Definition Name</i> | <i>Usage</i> |
|------------------|------------------------|--|
| Group Lists Page | GP_GRP_LIST | Create, edit, and view subsets of payees that you can process during an absence run. |

Group Lists Page

Use the Group Lists page (GP_GRP_LIST) to create, edit, and view subsets of payees that you can process during an absence run.

Navigation:

Set Up HCM > Product Related > Global Payroll & Absence Mgmt > Payee Groups > Group Lists > Group Lists

This example illustrates the fields and controls on the Group Lists page.

| <i>Field or Control</i> | <i>Description</i> |
|-------------------------|--|
| EmplID | Select the EmplID for each person to include in the group. |

Note: You can view or edit only groups that are created with your user ID.

Creating Process Streams

Page Used to Create Streams

| <i>Page Name</i> | <i>Definition Name</i> | <i>Usage</i> |
|------------------------------|------------------------|---|
| Streams Page | GP_STREAM | Set up a processing stream. Before you can use stream processing, you must partition tables in the database. |

Understanding Stream Processing

Stream processing is an optional feature that provides added flexibility to absence processing. You can divide payees into subsets, or *streams*, based on employee ID, and run calculations for either of the following:

- Only those payees in the stream that you select.
- Two or more streams at the same time.

By starting more than one stream at a time, you shorten the processing time significantly—the system processes the streams simultaneously, rather than going through a single, extended run. Using streams can also help control the sequence of each run and establish break points, to commit the results of your absence run to the database.

You must process each stream before you can finalize the calendar group ID. The Cancel and Finalize phases are not stream-oriented because they affect all payees that are processed with the same calendar group ID.

Prerequisites

Stream processing requires preliminary steps. Perform steps 1 and 2 once. Perform steps 3 and 4 each time that you use stream processing while running absences.

To prepare for stream processing:

1. Create the streams.
2. Partition tables in the database.

A database administrator needs to partition tables, using employee ID as the key.

3. When creating calendars, select the **Stream Processing** check box on the Calendar Group ID page.
4. Select the streams to process through the Calculate Absence and Payroll page.

To process several streams at once:

- a. Select the processing options for the first stream.

- b. Using a different Run Control ID, enter the instructions for the next stream.
- c. Repeat step (4b) for each stream.

You can run the streams all at once or at different times.

Streams Page

Use the Streams page (GP_STREAM) to set up a processing stream.

Before you can use stream processing, you must partition tables in the database.

Navigation:

Set Up HCM > Product Related > Global Payroll & Absence Mgmt > Payee Groups > Streams > Streams

This example illustrates the fields and controls on the Streams page.

| Streams | | | | | |
|--------------------|---------------|-------------|-------------------------------|---|---------------------|
| Stream Information | | | Personalize Find View All | | First 1-6 of 6 Last |
| *Stream Number | *Empl ID From | *Empl ID To | | | |
| 1 | GXTLEE01 | GXTLEE10 | + | - | |
| 2 | GXTLEE11 | GXTLEE25 | + | - | |
| 3 | GA0501 | GA0506 | + | - | |
| 4 | GA0508 | GA0515 | + | - | |
| 5 | G1EE0030 | G1EE0035 | + | - | |
| 6 | GXEEAM2GP01 | GXEEAM2GP05 | + | - | |

Enter a stream number and the EmplIDs of the first and last payees to include in the stream.

Note: You cannot include the same EmplID in more than one stream.

Chapter 25

Absence Assistant

Understanding Absence Assistant

A chatbot is a computer program that maintains a conversation with a user in natural language, understands the intent of the user, and sends a response based on business rules and data of the organization.

The Absence Assistant is a chatbot for Absence Management designed to assist the employee with absence related services using a conversational interface. Absence data and functionality from PeopleSoft is leveraged by the assistant, using a conversational format, and, an employee can ask absence related questions, or direct the assistant to perform self service transactions.

The Absence Assistant supports the employees in the following scenarios:

- Request Absence
- View Absences
- Current Balances
- Future Balances
- Cancel Absence

On selecting Absence Assistant tile, a chat window appears on the homepage for assistance. The employee can enter a welcome or introductory message or can request for the service or assistance in a conversational way.

The Absence Assistant is available for both desktop and mobile users.

Working with Absence Assistant Chatbot using ODA

The Absence management users can use the Absence Assistant tile to access the Absence Assistant Chatbot for quick answers to queries and to perform simple transactions related to absences using Oracle Digital Assistant (ODA), Oracle chatbot technology platform. Oracle Digital Assistant is a platform that allows enterprises to create and deploy digital assistants for their users. With Oracle Digital Assistant, you create:

- **Digital assistants**, which are AI-driven interfaces that help users accomplish a variety of tasks in natural language conversations. For each digital assistant, you assemble one or more skills.
- **Skills** (formerly known as chatbots), which are individual bots that are focused on specific types of tasks, such as tracking inventory, submitting time cards, and creating expense reports.

You can add skills to digital assistants or deploy them to a channel on their own. Intents allow your skill to understand what the user wants it to do. An intent categorizes typical user requests by the tasks and actions that your skill performs.

For more details, refer to [Oracle Digital Assistants and Skills](#).

Video: [Absence Management Chatbot Video Feature Overview](#).

Note: Import Absence skill using **Import Skill** option from Oracle Cloud Website. The Absence skill location is `PS_APP_HOME/setup/chatbot/PS_SKILL_TMPL(1.0).zip`.

For more information, refer to the Red Paper on Chatbot Integration Framework <https://support.oracle.com/epmos/faces/DocumentDisplay?id=2558379.1> and [Chatbot Install Guide](#)

For Absence Management Chatbot, the Absence Assistant skill consists of the following Intents:

- EntryGreeting
- AbsenceBalance
- CancelAbsence
- FutureBalance
- RequestAbsence
- ViewAbsenceRequest
- ExitGreeting

The entities associated with each intent are defined within the skill.

| Entities | Associated Intents |
|-----------------|---------------------------|
| AbsenceBalance | Absence Name |
| | DATE |
| CancelAbsence | Absence Name |
| | DATE |
| | InputStatus |
| FutureBalance | Absence Name |
| | DATE |
| RequestAbsence | Absence Name |

| Entities | Associated Intents |
|-----------------|---------------------------|
| | DATE |
| RequestAbsence | Absence Name |
| | DATE |
| | InputStatus |

The services can be used to call relevant application functionality as part of a transaction or query. The Chatbot Integration Framework delivers some services that can be used to help the chatbot carry out various tasks that these services allow to perform. To integrate the chatbot with the application services, you need to create a proxy user. This proxy user is used for the chatbot to communicate with the application services.

The dialog flow definition is the model for the conversation itself, one that lets you choreograph the interaction between a skill and its users.

The Services used in Absence Assistant are:

- HCM.absence.GetCnclAbsenceRequests
- HCM.absence.GetCancelReason
- HCM.absence.CancelAbsence
- HCM.absence.GetEmpAbsenceRequests
- HCM.absence.ValidateAbsenceName
- HCM.absence.GetEmpAbsTakesPrompt
- HCM.absence.GetEmpAbsenceBalances
- HCM.absence.ValidateFestDate
- HCM.absence.ForecastBalance
- HCM.absence.CalcAbsDuration
- HCM.absence.CheckEligibility
- HCM.absence.GetAbsenceReasons
- HCM.absence.CreateAbsenceRequest
- HCM.absence.GetEmployeeJobs
- HCM.absence.GetUserFields
- HCM.absence.GetUserProfile

- `HCM.absence.GetAbsRequestUrl`

If users need to create new service, then they can use the Application Service Framework to create custom services.

For more information please refer to the documentation on Application Service Framework <https://support.oracle.com/epmos/faces/DocumentDisplay?id=2557046.1>

For more details, refer to [Configure a Component Service](#) and “Understanding Application Service for Chatbot Integration Framework” (Enterprise Components).

PeopleSoft Employee Digital Assistant

PeopleSoft Intelligent Chatbot Assistant from Oracle (PeopleSoft PICASO) is a consolidated, single-point access chatbot where your employees can ask questions spanning multiple PeopleSoft applications like Absence, Benefits, Employee Directory, Expenses, North American Payroll, and more. For information on PeopleSoft PICASO, see “Understanding PeopleSoft PICASO” (Enterprise Components).

With Tools 8.59, the chatbot skill services (such as Absence, Employee Directory, and so forth) are REST API enabled to manage the Oracle Digital Assistant instances. For information on REST API, see “Understanding REST API Endpoints for PeopleSoft” (Enterprise Components) and “Understanding REST API Endpoints for PeopleSoft Absence Management Application Services (absence)” (Enterprise Components).

Absence Assistant Interface

This section explains the Absence Assistant interface.

The Absence Assistant helps employees to view absence-related information such as Absence balances and Absence requests as well as perform simple absence-related tasks like requesting or cancelling Absences.

Note: To enable the Absence Assistant tile to Employees homepage, associate the corresponding chatbot service role types. The Absence Chatbot ESS Services permission list ID is HCCPAMCB01. There are corresponding Chatbot administrator and client user lists.

Roles and permission lists are part of standard PeopleTools security administration, used to grant access to components and pages. Roles and permission lists are discussed in the PeopleTools: Security Administration documentation.

Request Absence Transactions

The Absence Assistant can apply absence on behalf of the employee with inputs from employee. If approvals are not configured, absence gets created without approval. The Absence Assistant requests for entities and the inputs are validated by PeopleSoft. The chatbot asks for absence begin and end date. In case of attachments or partial days information required, the employee will be navigated to Request Absence page.

The chatbot supports all the configurations selected for an absence. It prompts for up to four user fields that are marked required. The user is transferred to the Request Absence page if he/she wishes to provide partial days and attachments

If request approval is required, it triggers an approval process. The user is transferred to the Request Absence page if he/she wishes to provide partial days and attachments. The chatbot prompts for up to four user fields that are marked required.

View Absences Query

The Absence Assistant, on selecting **View Absences** responds with the list of matching requests in descending order of request start date in the form of a card layout. The information includes absence name, status, dates and date range.

The **View Details** shows the absence details.

From the set of absence requests results, based on the cancel configurations selected for the absence, you can select **Cancel** link to directly cancel the absence. Using **View More** button, you can scroll horizontally through the listed absence. The **More Requests** avails you the next set of absence requests matching the user requirement.

Note: The **What can I do next** button is the global support that displays at the end of every interaction.

Current Balances Query

The Absence Assistant displays absence balance for the employee for a specific absence or for a particular absence name or for all users absences, if the user does not provide an absence name. It displays the Absence Names to select for viewing more details. The chatbot displays Balance information in the units configured for the logged in employee.

Future Balances Query

The Absence Assistant retrieves accrued balances as of a specific date. You have to configure forecasting to enable this entity. The employee can request for forecasted balance, then the assistant requests for entity values and provides the forecast values.

When user provides a date before last calendar run for future balance information, the chatbot responds that it does not support past dates and provides the absence balance as of last calendar run.

Cancel Absence Transaction

The Absence Assistant can cancel absence on employee request. The Assistant requests for entities and the inputs are validated by PeopleSoft. If request approval is required, approval process is triggered. If request approval is not required, absence is cancelled and confirmation message displays.

The chatbot displays one or more matching requests for user input. You can have a quick look at the absence and select the cancel option. You can select **Cancel Absence** link which asks for reason for cancelling the absence. The Absence Assistant displays one or more matching requests for user input.

Note: Alternately, you can provide **Begin Date** or **End Date** with the **Absence Name** for canceling a specific Absence Request.

Setting Up Absence Assistant

This topic discusses how to configure Absence Assistant chatbot for absence management.

Pages Used to Work with Absences as an Administrator Using the PeopleSoft Fluid User Interface

| <i>Page Name</i> | <i>Definition Name</i> | <i>Usage</i> |
|---|------------------------|---|
| <u>Bot Definition Page</u> | EOCB_BOTDEFN_FL | Access to view the existing chatbot configurations and newly define a chatbot. By default, the Absence Assistant tile is not enabled to personalize under Employee Self Service. The Administrator has to enable it by using the process mentioned in Enabling Absence Assistant . |
| “Maintain Bot Definition Page” (Enterprise Components) | EOCB_BRNDTMPL_FL | Use to define the template to brand the chatbot. |

Enabling Absence Assistant

Use the Fluid Attributes tab (PORTAL_GROUPLET) in Content Ref Administration (PORTAL_CREF_ADM) page to add the Absence Assistant tile to any homepage.

Navigation:

PeopleTools > Portal > Structure and Content.

Then select **Self Service > HR Fluid Components.**

Under Content References, select **Edit** for the label **Absence Assistant** and select **Fluid Attributes** tab.

This example illustrates the fields and controls on the Content Ref Administration page.

The screenshot shows the 'Content Ref Administration' page with the following details:

- Navigation:** Folders and CRefs, Content Ref Administration, Home, Search, 44 notifications, Help, Personalize Page.
- Tabs:** General (selected), Security, Fluid Attributes.
- Breadcrumbs:** Root > Self Service > HR Fluid Components >
- Content Ref Administration:**
 - Name: HC_HGA_CHAT_ASST_FLU
 - Parent Folder: HR Fluid Components
 - *Label: Absence Assistant
 - Long Description (254 Characters): Absence Assistant
 - Product: HC
 - Sequence number: 90
 - Owner ID: HGA (Absence Management)
 - Usage Type: Target
 - Storage Type: Remote by URL
 - CreatedBy: PS
 - *Valid from date: 01/01/1900
 - Valid to date: (empty)
 - Creation Date: 05/31/2019
 - Options: WSRP Producing, No Template, Fluid Mode, Display on Small Form Factor
- Actions:** Create Content Reference Link, Add Content Reference, Test Content Reference
- URL Information:**
 - Node Name: HRMS
 - URL Type: PeopleSoft Generic URL
 - *Portal URL: c/EOCB_MENU_FL.EOCB_CLIENT_FL.GBL?BOTID=HGA_CHAT_ASST
- Content Reference Attributes:**
 - Name: HOMEPAGE_TILE
 - Label: (empty)
 - Attribute value: true
 - Options: Hide from portal navigation, Hide from MSF navigation, IWC Message Events
- Links:** Personalize | Find | First 1 of 1 Last
- Table:**

| Portal Name | Label | Link Definition |
|-------------|-------------------|-----------------|
| EMPLOYEE | Absence Assistant | Link Definition |

Select the **Fluid Attributes** tab to open the **Tile Repository** section.

This example illustrates the fields and controls on the Fluid Attributes tab.

The screenshot displays the 'Structure and Content' interface with the 'Fluid Attributes' tab selected. The breadcrumb path is 'Root > Self Service > HR Fluid Components >'. The 'Tile Information' section contains the following fields and controls:

- Image Name:** PS_CHAT_CLIENT_M_FL
- Display In:** Modal
- Modal Parameters:** sStyle@frame-pt_chatclientpage;bAutoClose@0
- Height:** 1
- Width:** 1
- Refresh Timer:** 0
- Event Name:** (empty)
- Interactive:**
- Disable Main Hotspot:**
- Autosize:**
- Resizable:**

The 'Dynamic Tile Content' section has a **URL Type** dropdown set to 'None'.

The 'Tile Repository' section includes a **Folder** dropdown set to 'HC_SELF_SERVIC_FL_GBL' and a **Folder Label** of 'Employee Self Service'. Below the folder selection is a 'View Definition' link. To the right, the 'Include In Repository' panel has the following options:

- Homepage
- Dashboard
- NavBar

At the bottom of the form, there are 'Save' and 'Notify' buttons, and a breadcrumb path: 'General | Security | Fluid Attributes'.

Select the **Homepage** checkbox under **Include In Repository** to enable the **Absence Assistant** tile to the homepage.

Bot Definition Page

Use the Bot Definition (EOCB_BOTDEFN_FL) page to view the existing chatbot identifiers and newly define a chatbot.

Navigation:

Enterprise Components > Chatbot Configurations > Bot Definition

This example illustrates the fields and controls on the Bot Definition Page. You can find definitions for the fields and controls later on this page.

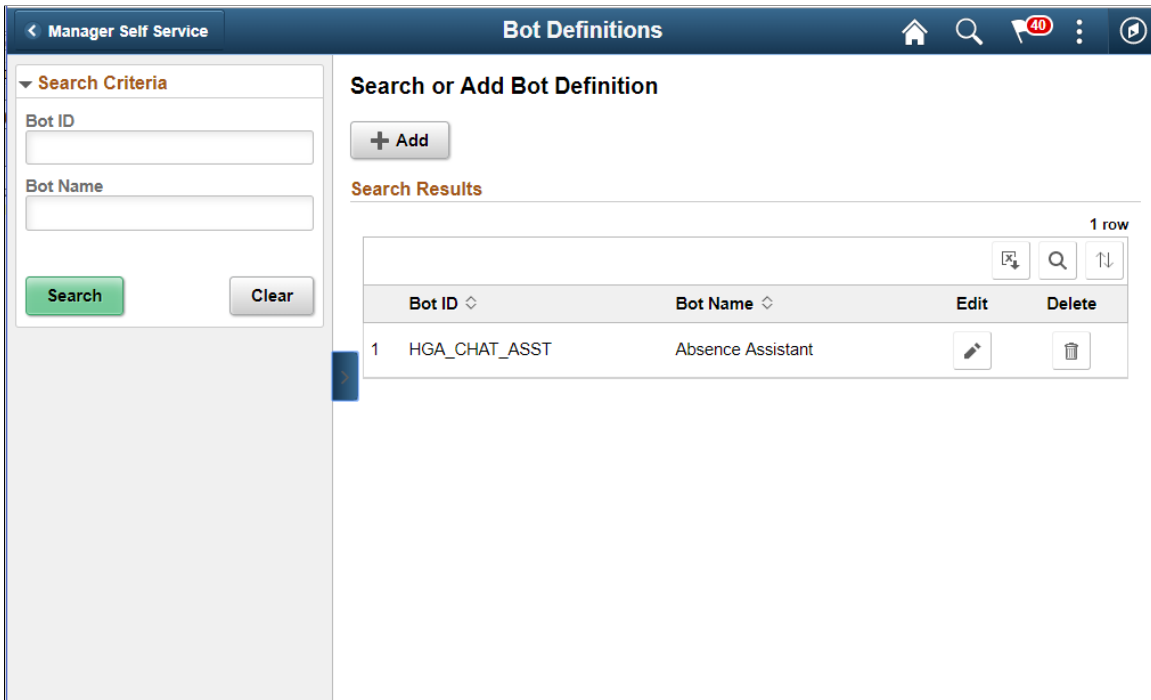

| <i>Field or Control</i> | <i>Description</i> |
|---|---|
|  | Select Add to open the intermediate page using which Bot definition is added. |

This example illustrates the fields and controls on the Add Bot Definition Page. You can find definitions for the fields and controls later on this page.

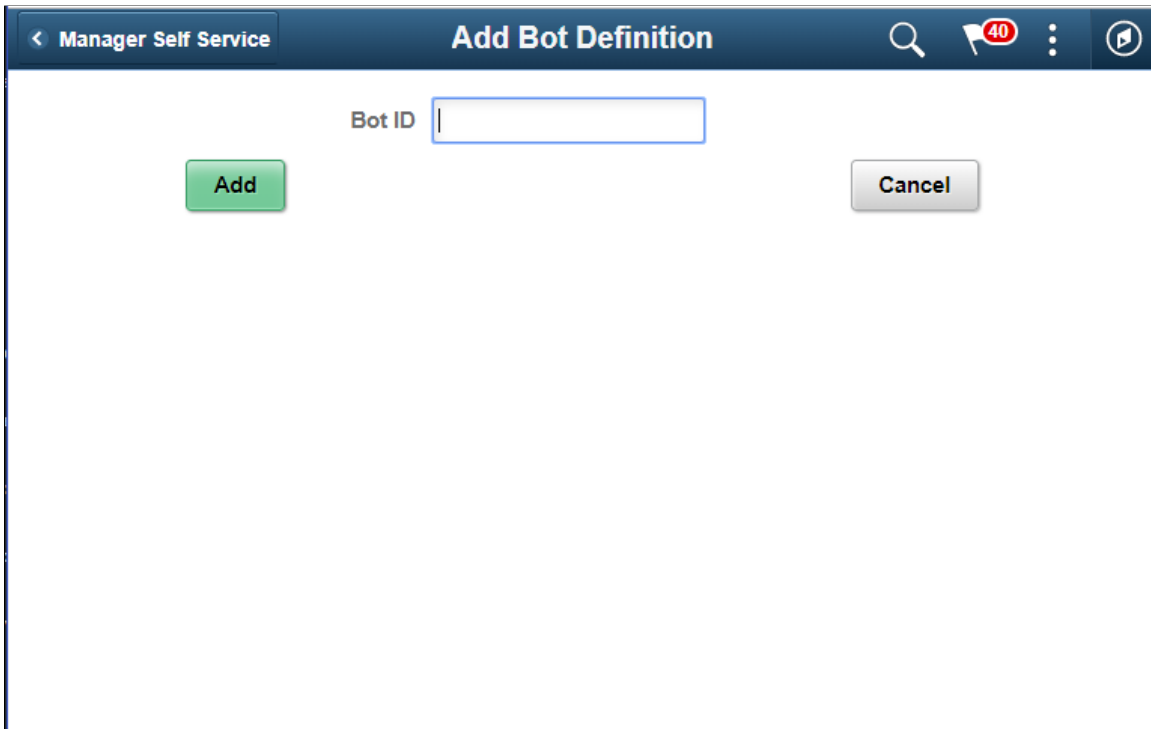

This example illustrates the fields and controls on the Bot definition page with definition. You can find definitions for the fields and controls later on this page.

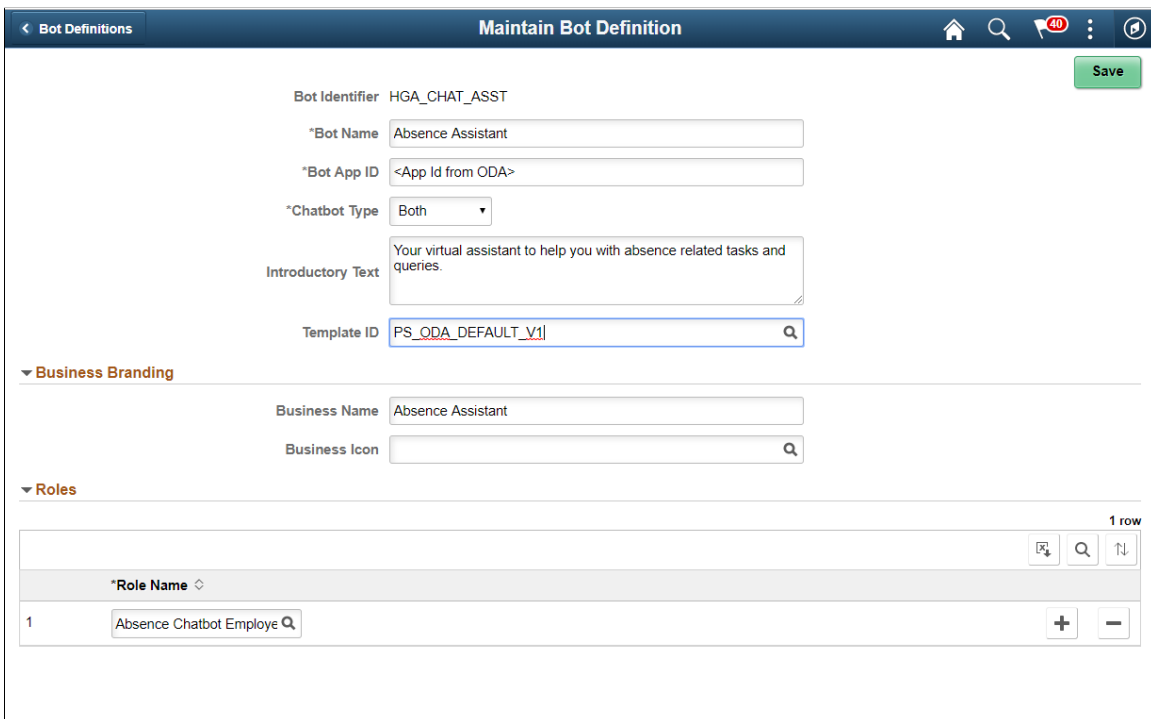

| Field or Control | Description |
|--------------------------|--|
| Bot Identifier | Root package ID defined in application server. |
| Bot Name | Name of the chatbot. |
| Bot App ID | Specify the app ID generated by the ODA Skill created for this chatbot. This links this chatbot with the skill in the ODA. |
| Chatbot Type | Choose whether to deploy the chatbot client as a tile or as a widget in a page or both. Chatbot types are embedded (for components) and widget (bottom right hand button). |
| Introductory Text | The descriptive text that appears in the header section (below Business name) of messaging area. |
| Business Name | Name of the chatbot as it will appear to the users. |
| Business Image | Bot icon as per business need. Refer, PeopleTools: Creating Image Definitions, for more information. |
| Component Name | Choose the Component Name that should be linked with. |
| Role Name | Choose the roles that should be given access to this chatbot. |

For more details, refer Enterprise Components Documentation “Understanding the Chatbot Architecture” (Enterprise Components).

Communicating with Absence Assistant

This topic discusses how an employee can interact with Absence Assistant to perform the enquiries and transactions in the following areas:

- Request Absence
- View Absences
- Current Balances
- Future Balances
- Cancel Absence

The following video provides an overview of the Absence Management Chatbot:

Video: [Absence Management Chatbot Video Feature Overview](#)

Video: [Image Highlights, PeopleSoft HCM Update Image 31: Absence Management Chatbot](#)

Pages Used to communicate with Absence Assistant

| Page Name | Definition Name | Usage |
|------------------------|--|--|
| Absence Assistant Tile | HC_HGA_CHAT_ASST_FLU (cref for the tile) | <p>Access Absence Assistant window</p> <p>By default, Absence Assistant tile is not enabled to personalize under Employee Self Service. The Administrator has to enable it by using the process mentioned in Enabling Absence Assistant.</p> <p>For more details, refer the topic mentioned under PeopleTools: Administering Content References documentation.</p> |

Absence Assistant Tile

Employee uses the Absence Assistant tile to access the Absence Assistant Chatbot for quick answers to queries and to perform simple transactions with inputs from employee.

Navigation:

From the Employee Self Service page, Select Absence Assistance Tile to access Absence Assistant Chatbot.

This example illustrates the Absence Assistant tile.



Click the Absence Assistant tile to access the Absence Assistant Page. The Absence Assistant page is a virtual assistant for an employee to help him/ her for absence related tasks and queries.

Note: Assign the *Absence Chatbot ESS Services* Role the employee to get access to Absence Assistant tile.

You can add the Absence Assistant tile through the Personalize Homepage, Employee Self Service menu navigation when personalizing homepage to access it easily.

This example illustrates the fields and controls of the Absence Assistant page when the tile is configured to homepage.

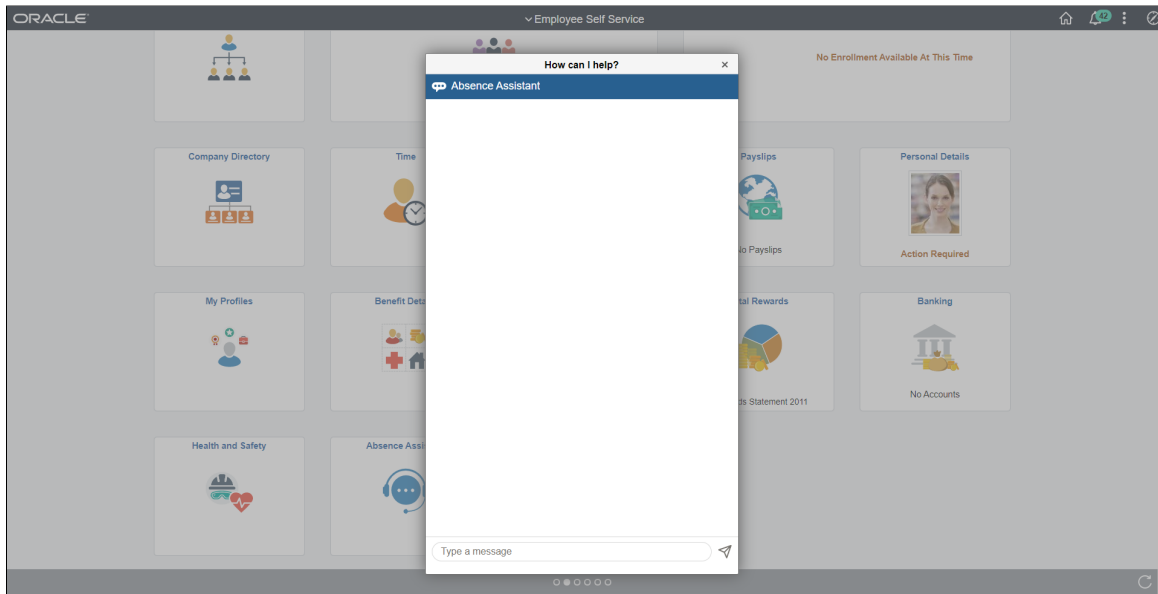

This example illustrates the fields and controls of the Absence Assistant page when using smartphone.



For guided assistance, you can start with a salutation in general. The Absence Assistant displays the areas of support by default.

This example illustrates the fields and controls on the Absence Assistance page with Guided Assistance. You can find definitions for the fields and controls later on this page.

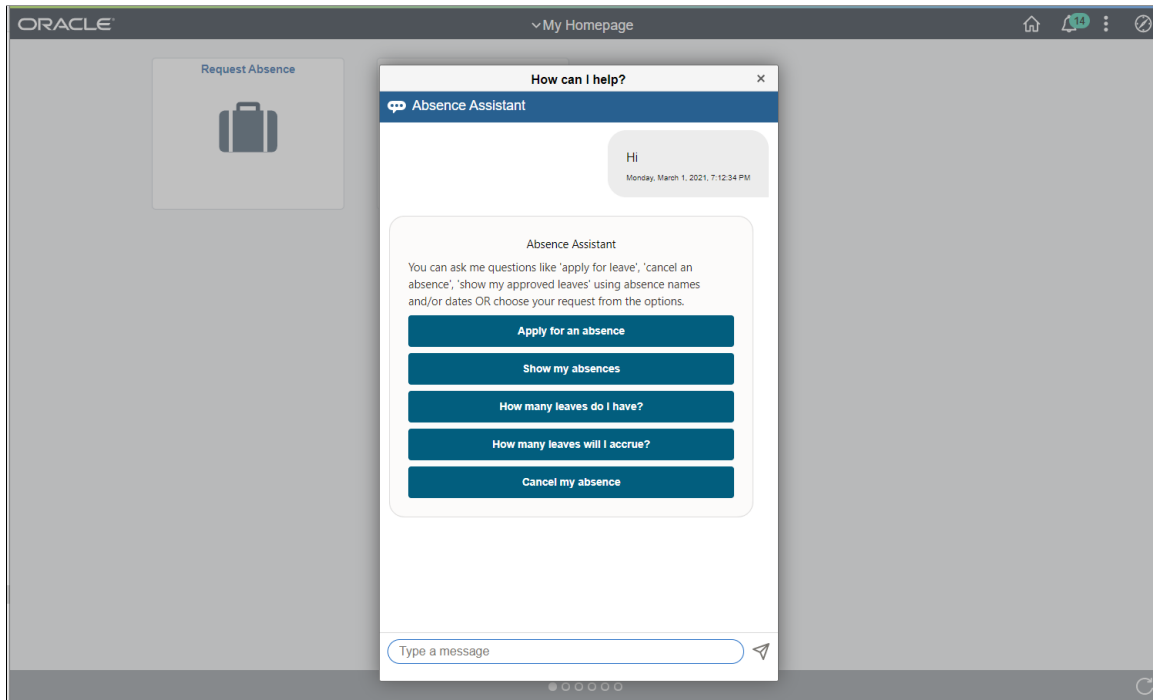

The Chatbot welcome message lists the supported action to guide the users.

Note: You can also enter a complete message for responses. For example, I want to take a vacation leave for tomorrow.

This example illustrates the fields and controls on the Vacation Request Response.

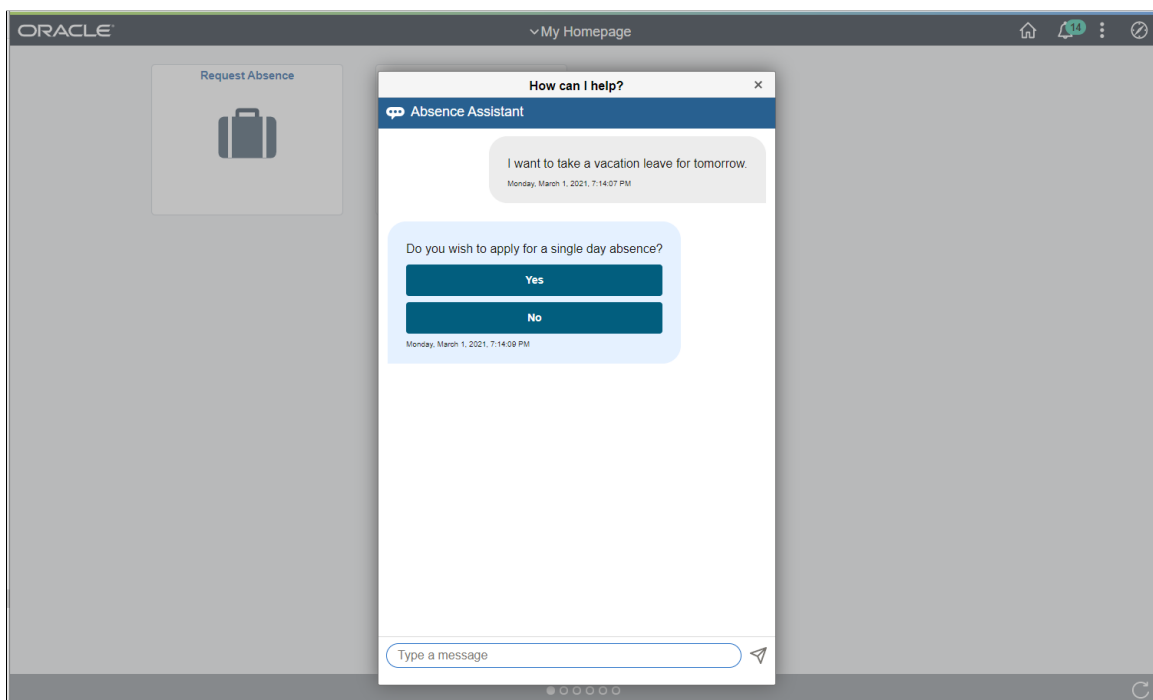

Requesting Absence

Employees can request absence with the help of Absence Assistant. On selecting **Request Absence**, the Absence Assistant Chatbot asks for Begin Date, End Date and Absence Name based on the configurations selected for absence name. The bot prompts for further information before submitting the absence request on employees behalf.

This example illustrates the fields and controls on the Absence Assistant with Request Absence Date Query.

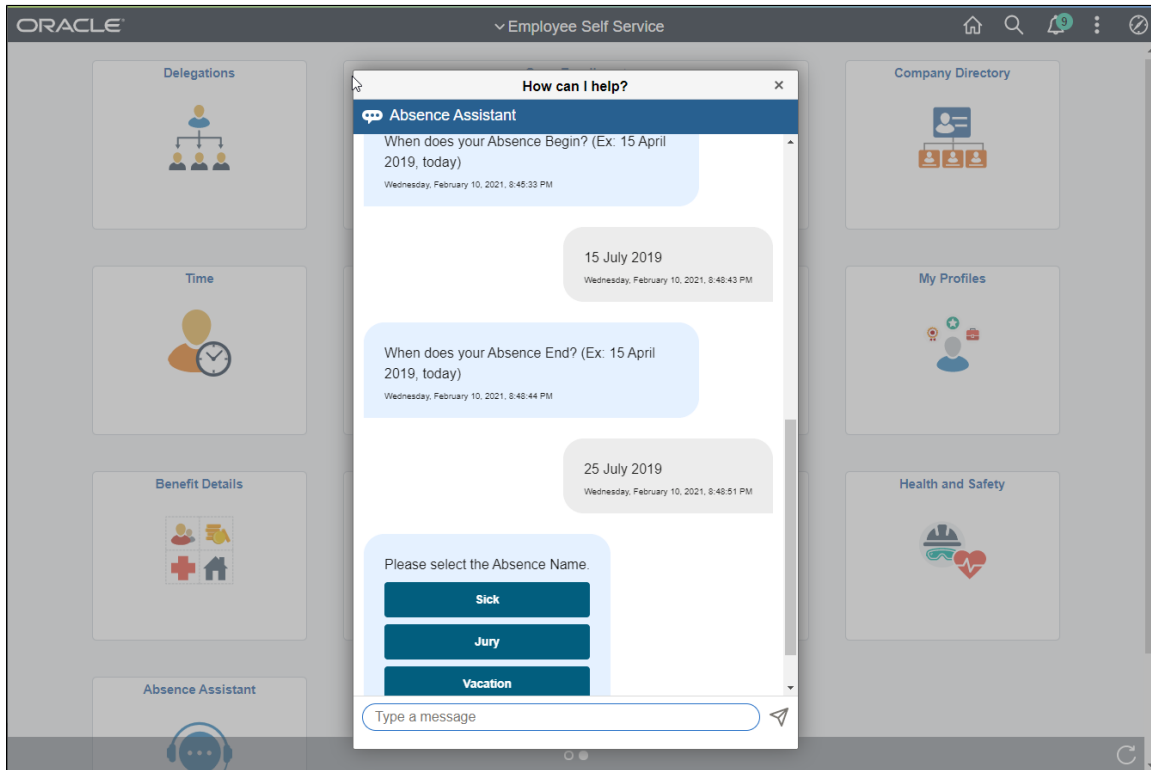

You can select Absence Name from the options or type in Apply Absence.

The Absence Assistant asks if you wish to provide partial day details or attachments for the absence request. If the answer is **Yes** then, then You will be navigated to a separate window of Absence Request page for entering those details.

It logically concludes the transaction within the chat window and the user is free to continue chat with Absence Assistant for other requirements.

This example illustrates the fields and controls on the Absence Assistant with Attachments and Partial Days Query.

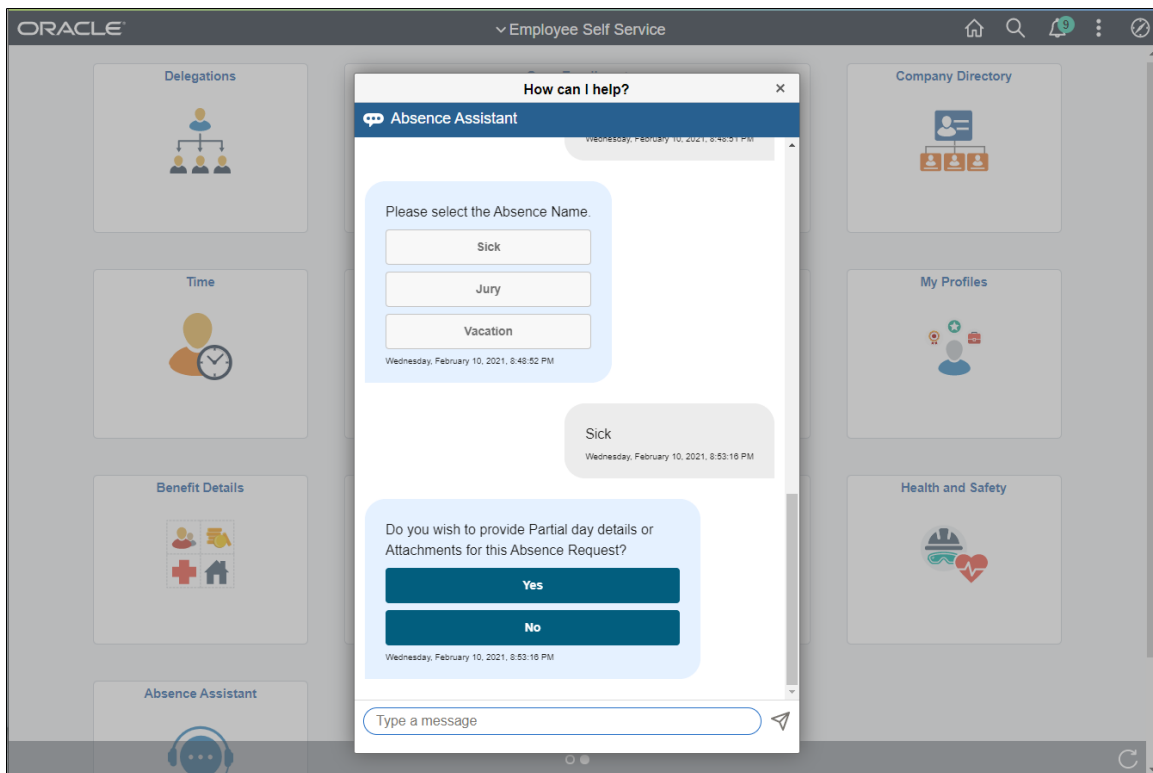

Note: Absence Assistant have queries related to eligibility checks and approvals. The fields are configured using [Configure Country Take Setup - User Fields Page](#).

This example illustrates the fields and controls on the Absence Assistant with Absence Reason.

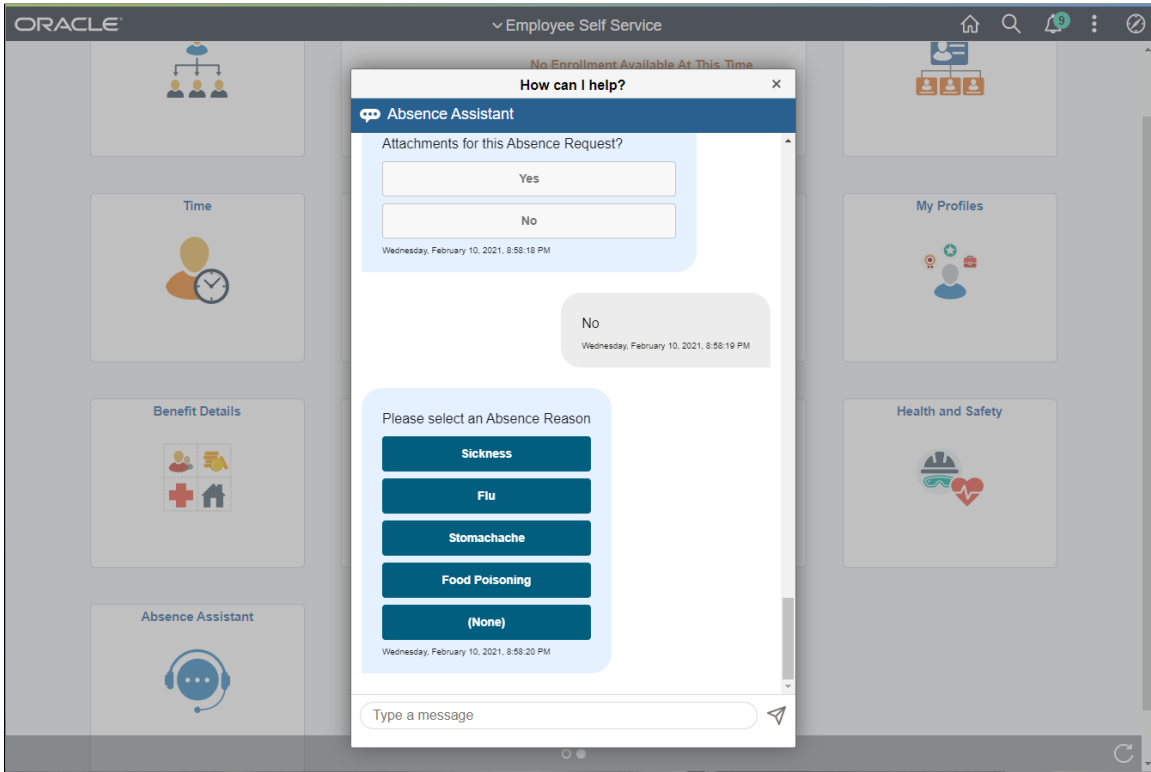

Absence Assistant asks for comments, in the case where **No** comments, will be navigated to proceed with confirmation.

This example illustrates the fields and controls on the Absence Assistant Page with Comments and Confirmation.

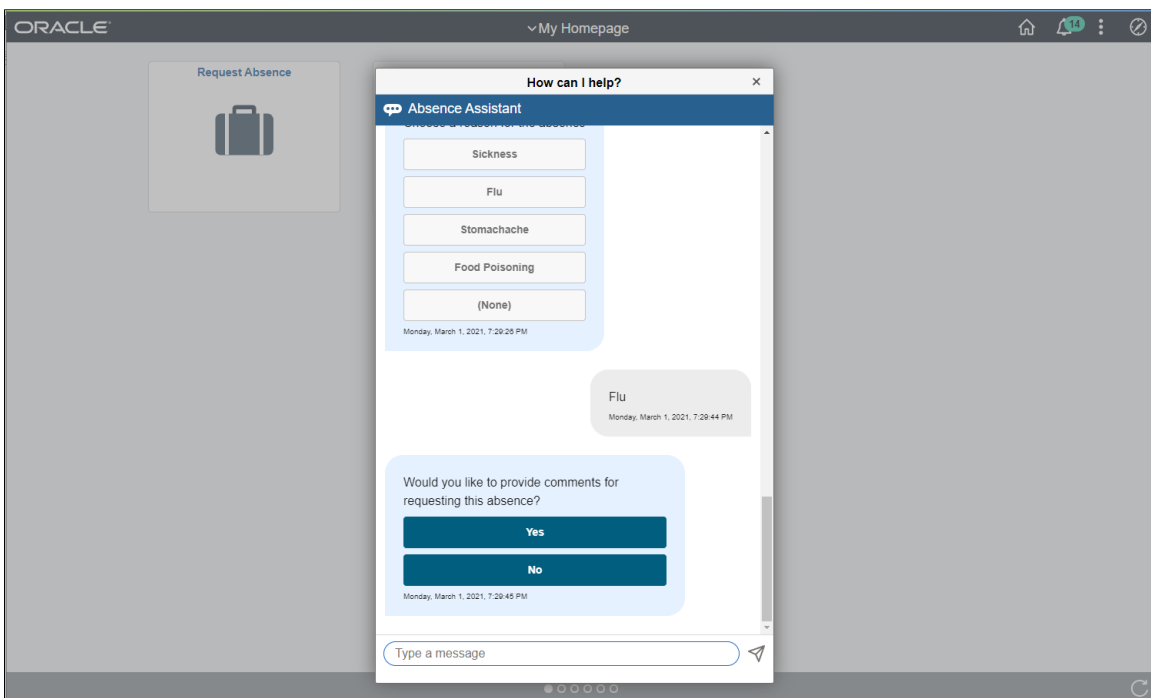



Viewing Absences

On selecting **View Absences**, Absence Assistant displays the latest Absence Requests. You can view the specific requests by providing Date, Date range, status and absence name.

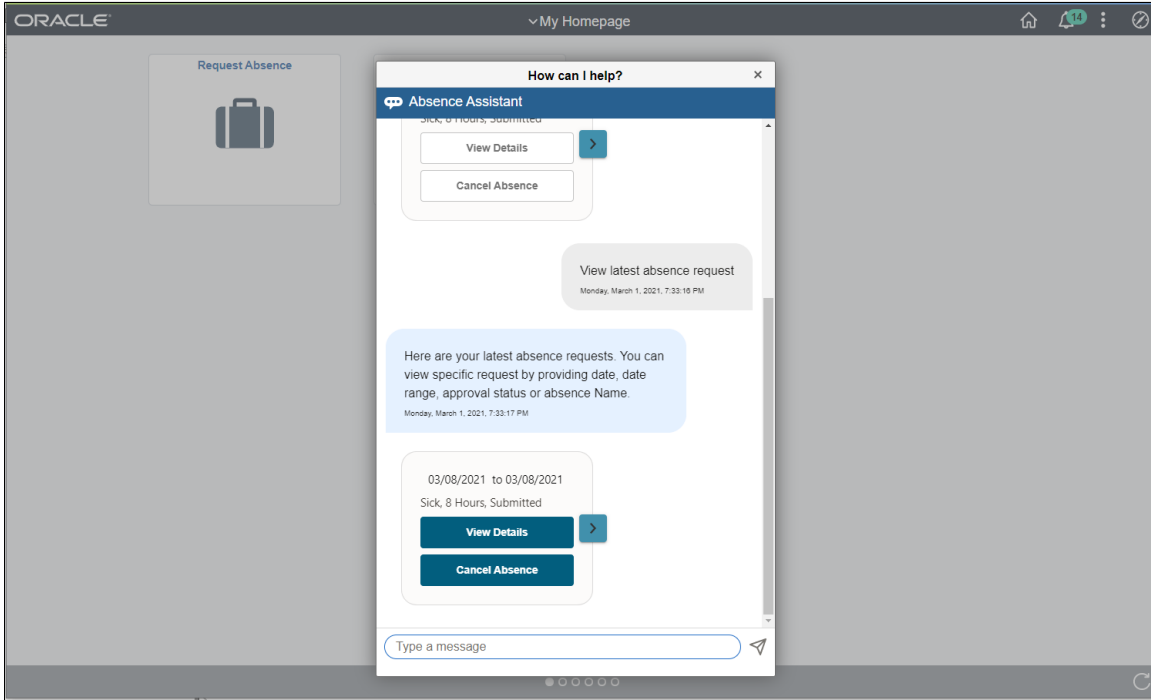
This example illustrates the fields and controls on the Absence Assistant View Latest Absence Request.



| Field or Control | Description |
|---|--|
|  | Select the link to view the details of a particular absence. |
|  | Select to cancel a listed absence. |

Select View Details link to get the information of the balance you select.

This example illustrates the fields and controls on the Absence Assistant with View Details.

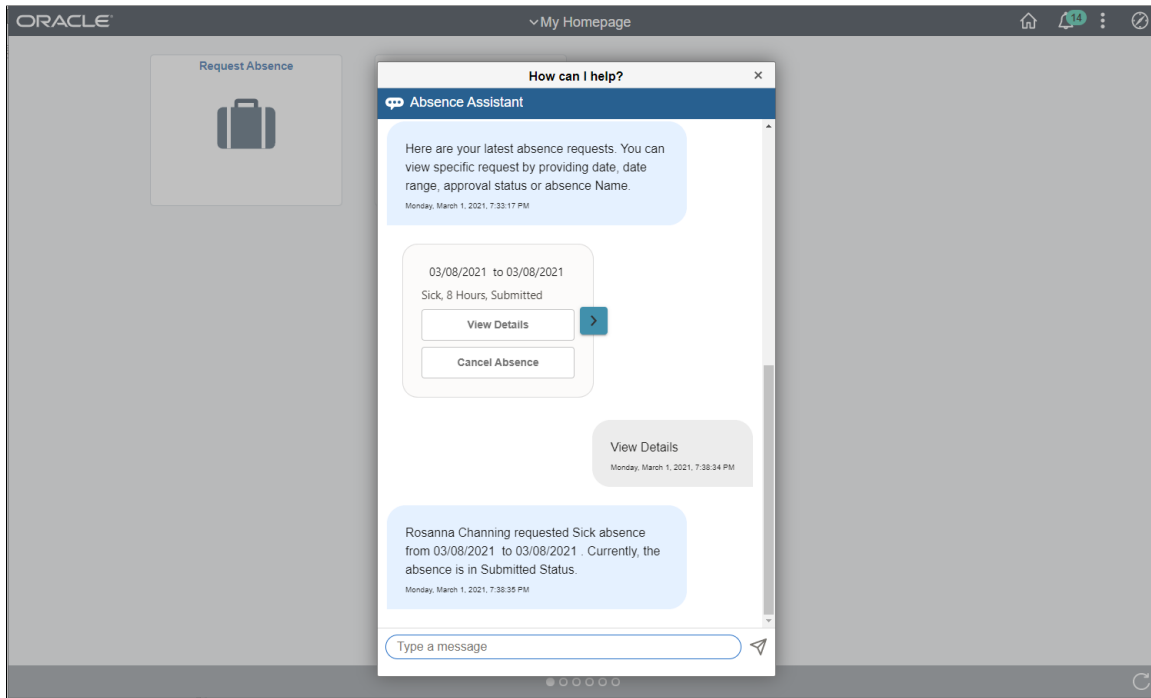

This example illustrates the fields and controls on the Absence Assistant with Cancel Absence. You can find definitions for the fields and controls later on this page.

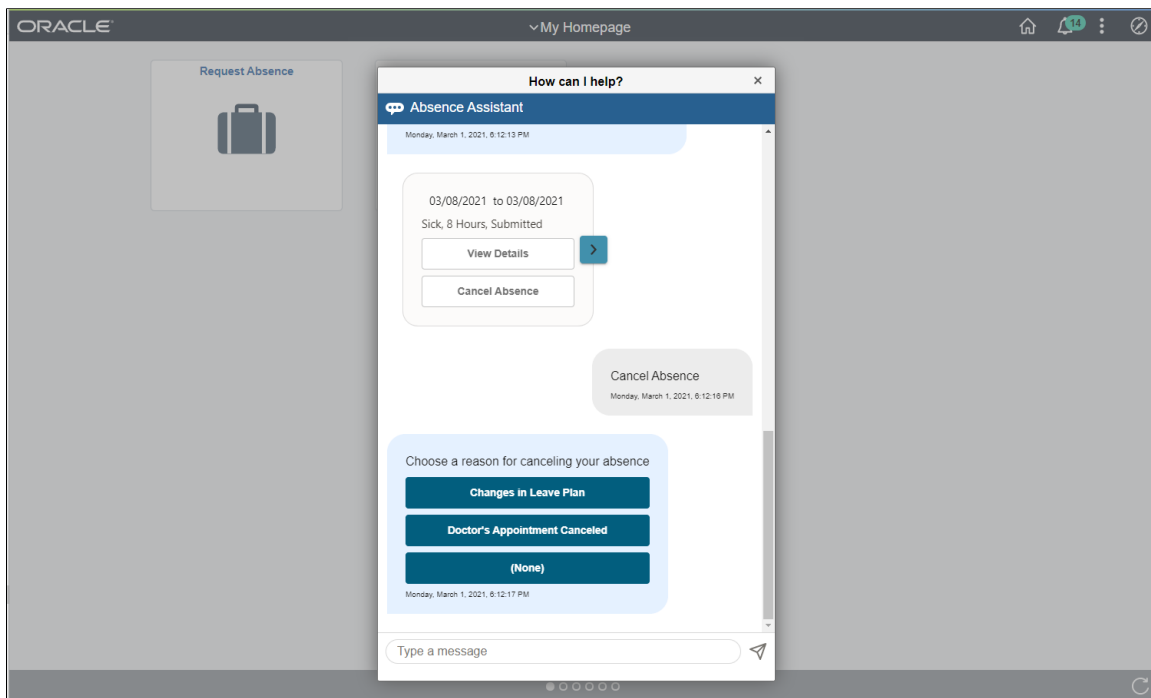

The Employee can select the reason for cancelling the absence and proceed as instructed by Absence Assistant.

This example illustrates the fields and controls on the Absence Assistant with Comments and Cancellation Requests.

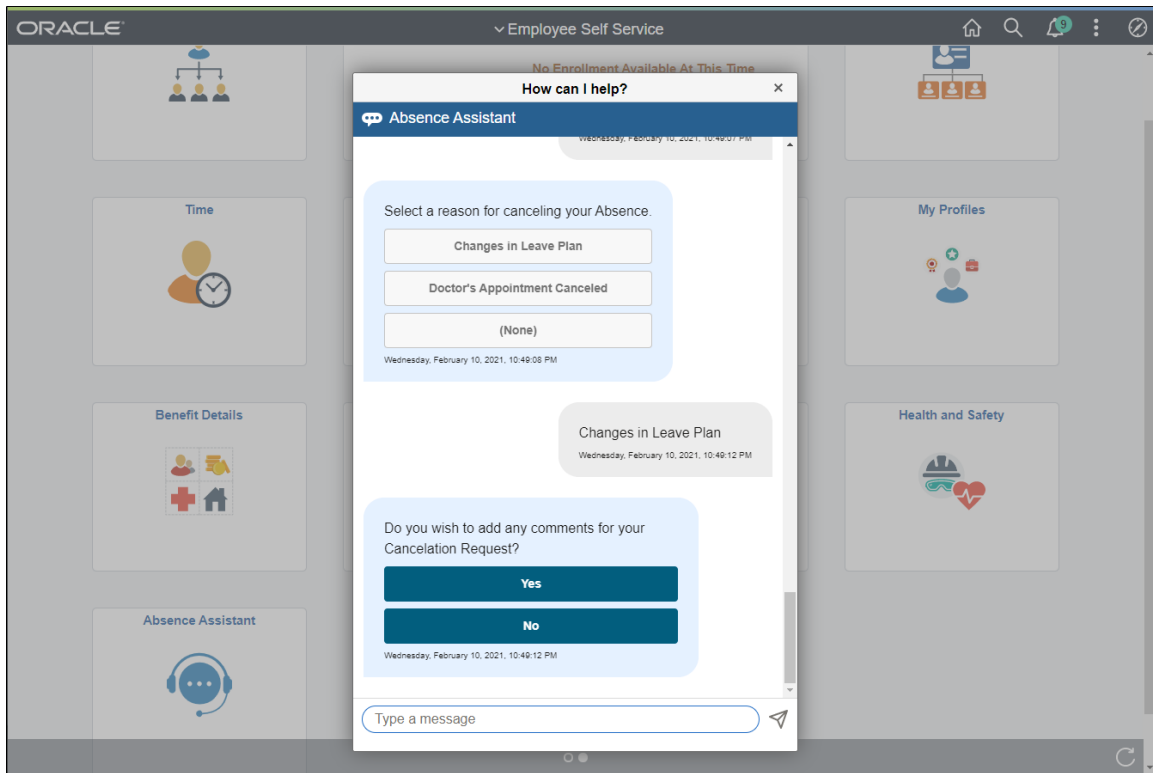

On selecting the required information, Absence Assistant will guide you to further steps which are self explanatory.

Viewing Current Balances

Employee can view **Current Balances**, Absence Assistant displays the Absence Names:

This example illustrates the Absence Assistant with Absence Names.

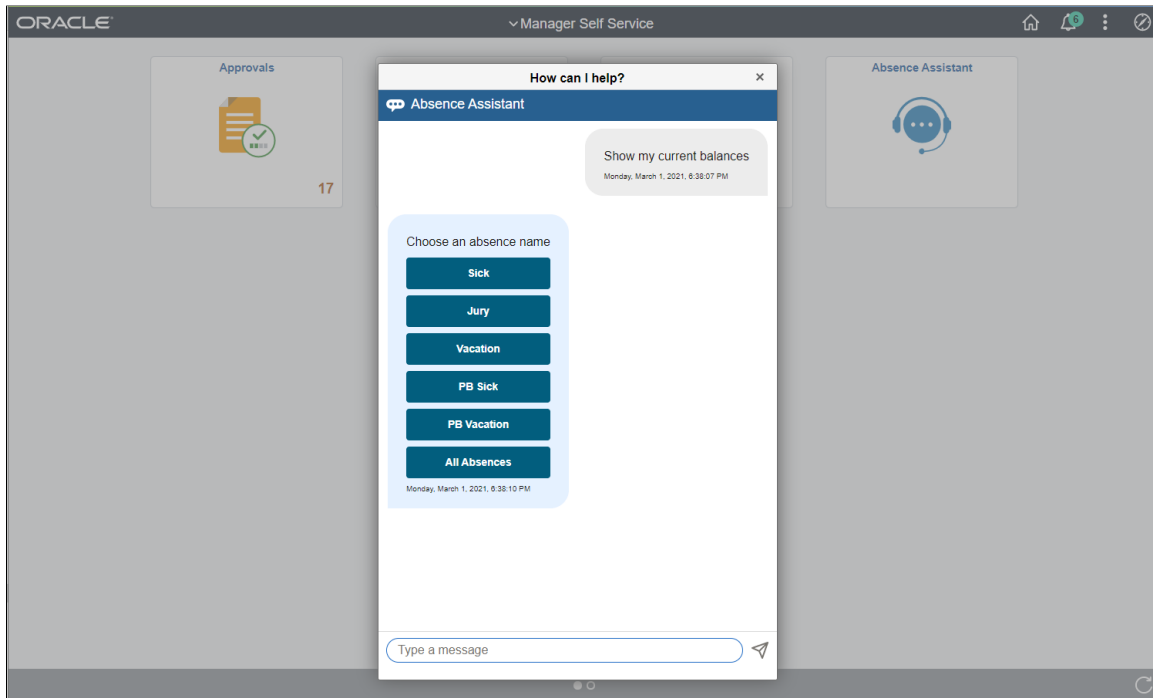

This example illustrates the Absence Assistant with Absence Names when using a smartphone.

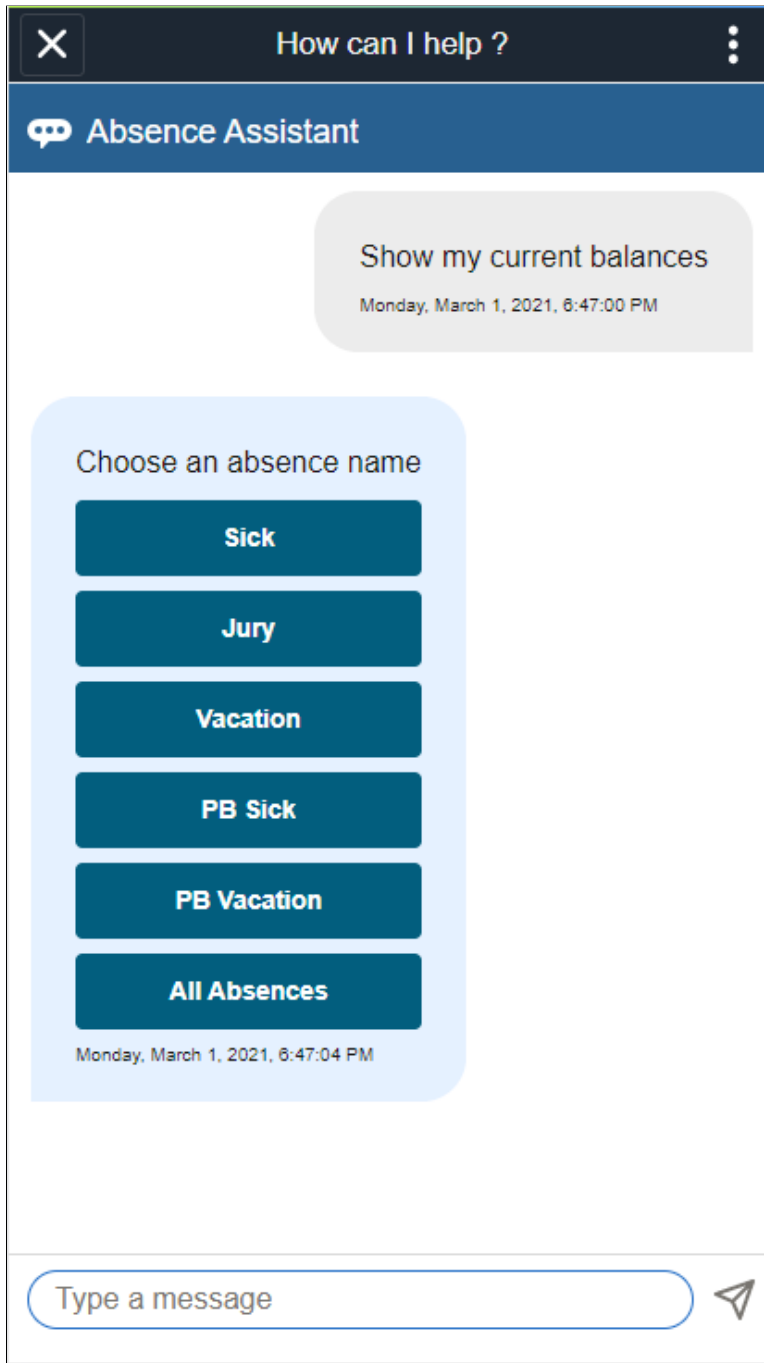

On selecting Absence Name for which you want to view balance, Absence Assistant displays the Current Balances of that absence type.

This example illustrates the fields and controls on the Absence Assistant with Vacation Balance information.

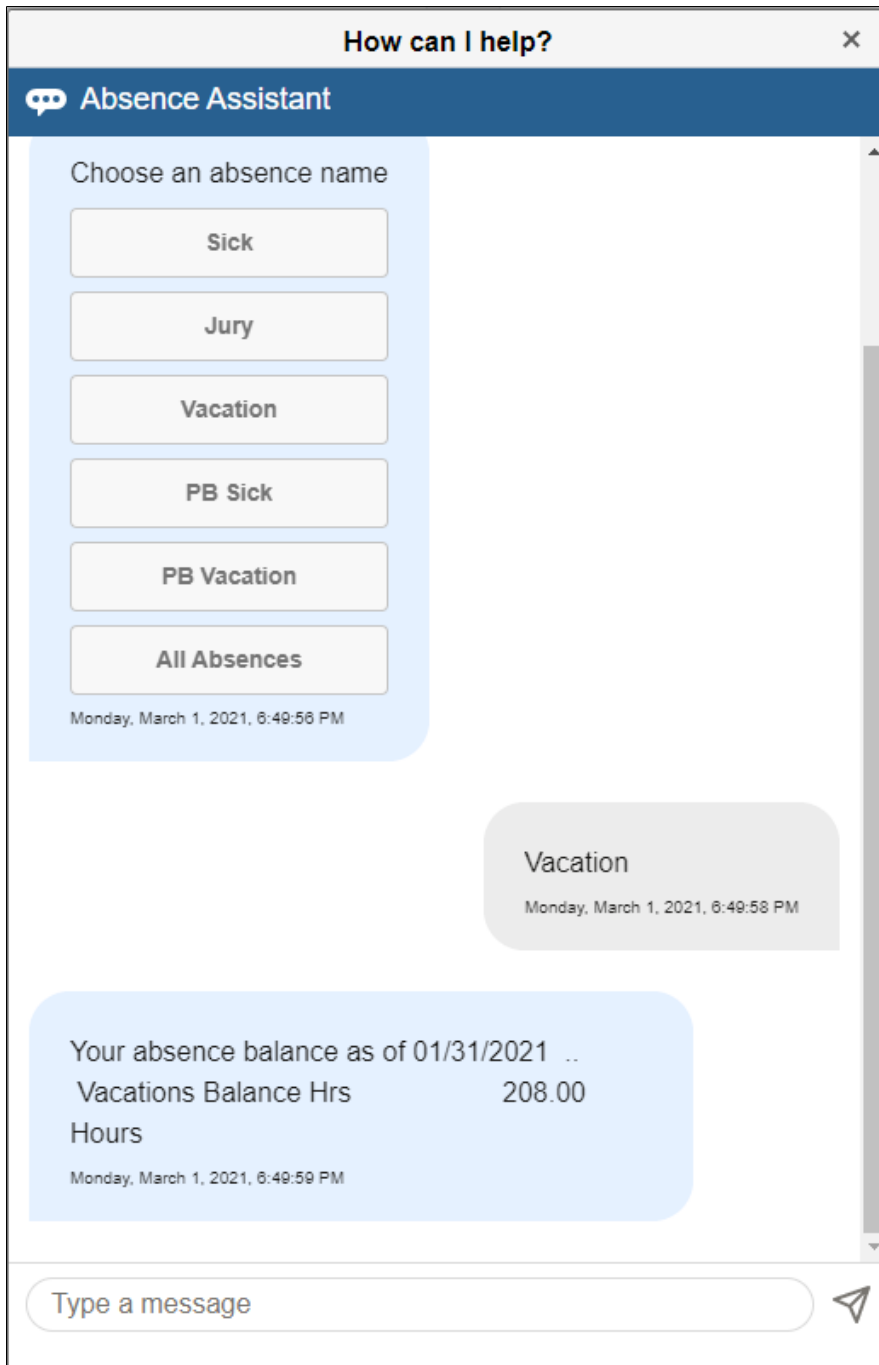

Select **All Balances** button to view all balance information.

This example illustrates the fields and controls on the Absence Assistant with All Absences.

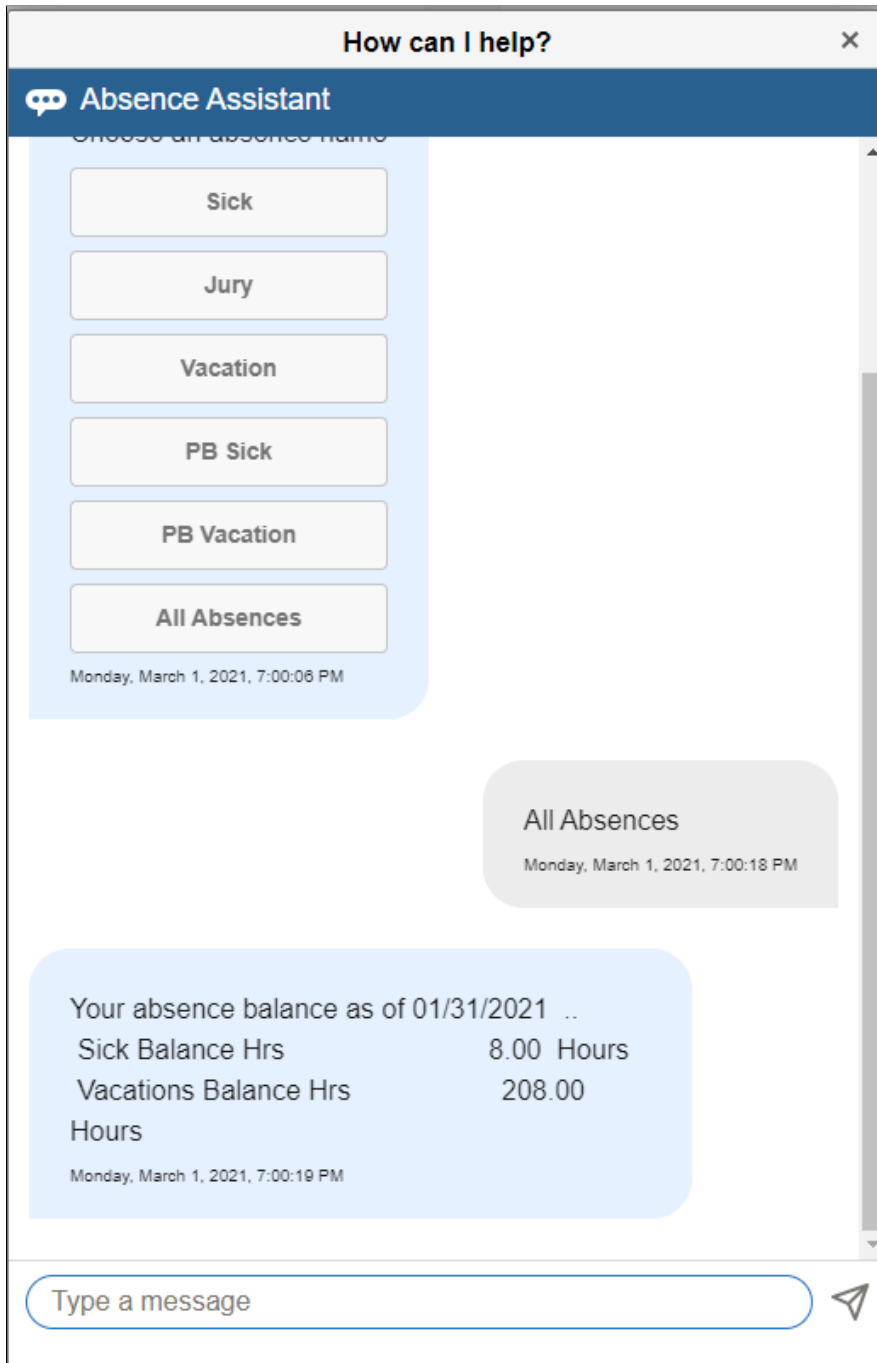

Viewing Future Balances

Select **Future Balances** option to view the balances for future.

This example illustrates the fields and controls on the Absence Assistant with Future Date Entry.

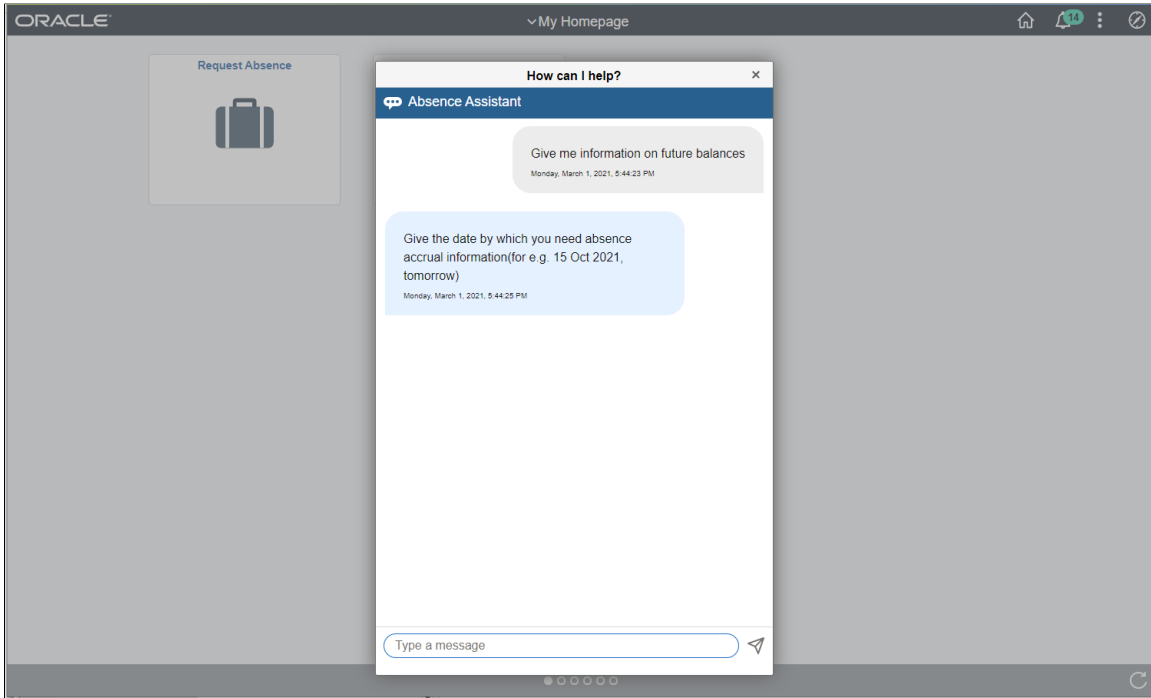

Enter the future Dates to view the balance details for future.

Select an absence name to view the balances.

This example illustrates the fields and controls on the Absence Assistant with Absence Name Entry.

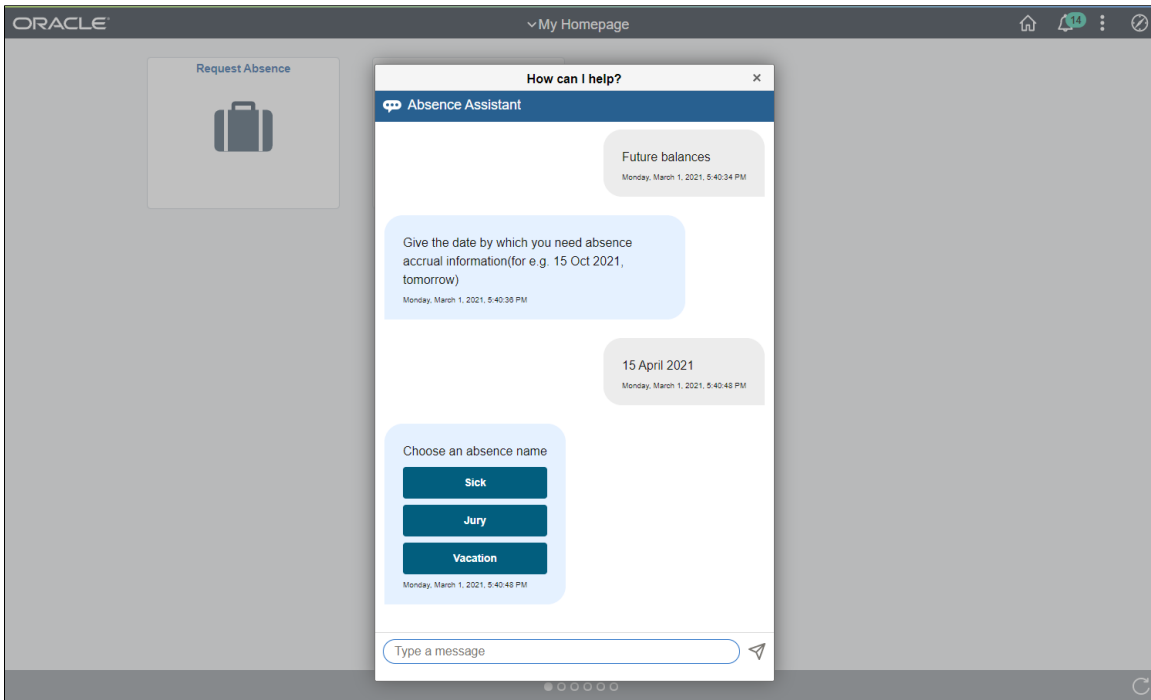

Canceling an Absence

On selecting **Cancel Absence**, the Absence Assistant asks for the absence request you wish to cancel. Alternately, you can provide Begin or End Date with the Absence Name for canceling a specific Absence Request.

This example illustrates the fields and controls on the Absence Assistant with Cancel Absence Information.

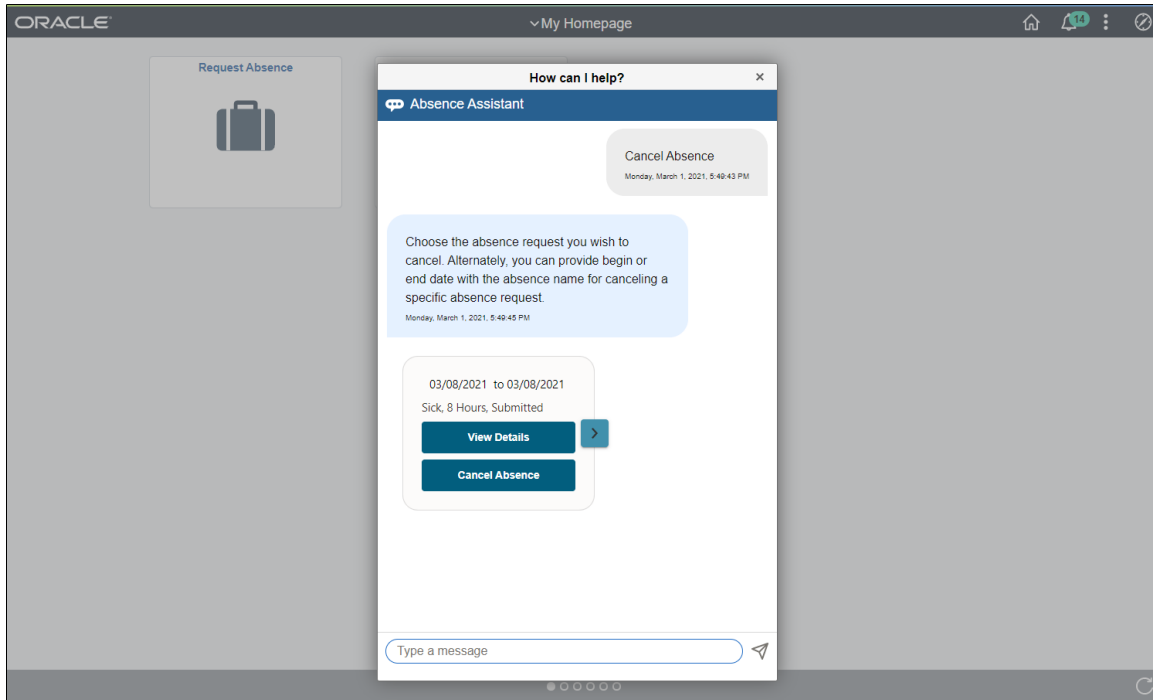

The employee can select absence request to be cancelled and view the details, if needed.

This example illustrates the fields and controls on the Absence Assistant with Cancel Absence View Details.

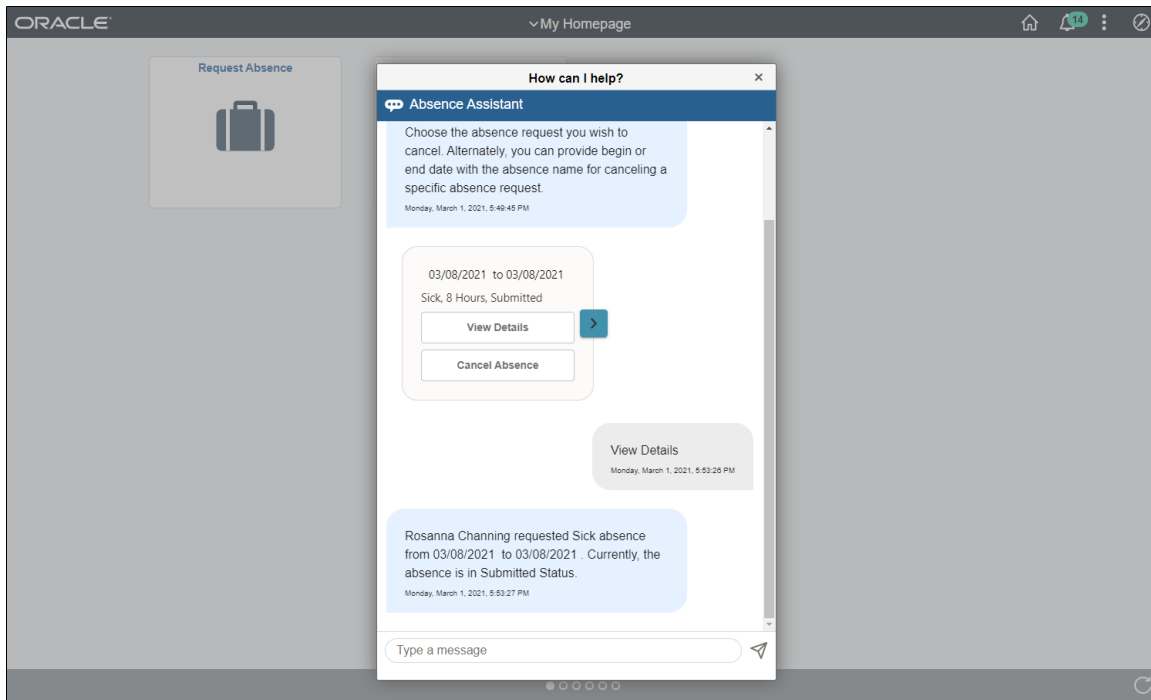

After selecting the details, Select the reason for cancelling the absence.

This example illustrates the fields and controls on the Absence Assistant with Cancel Absence Details.

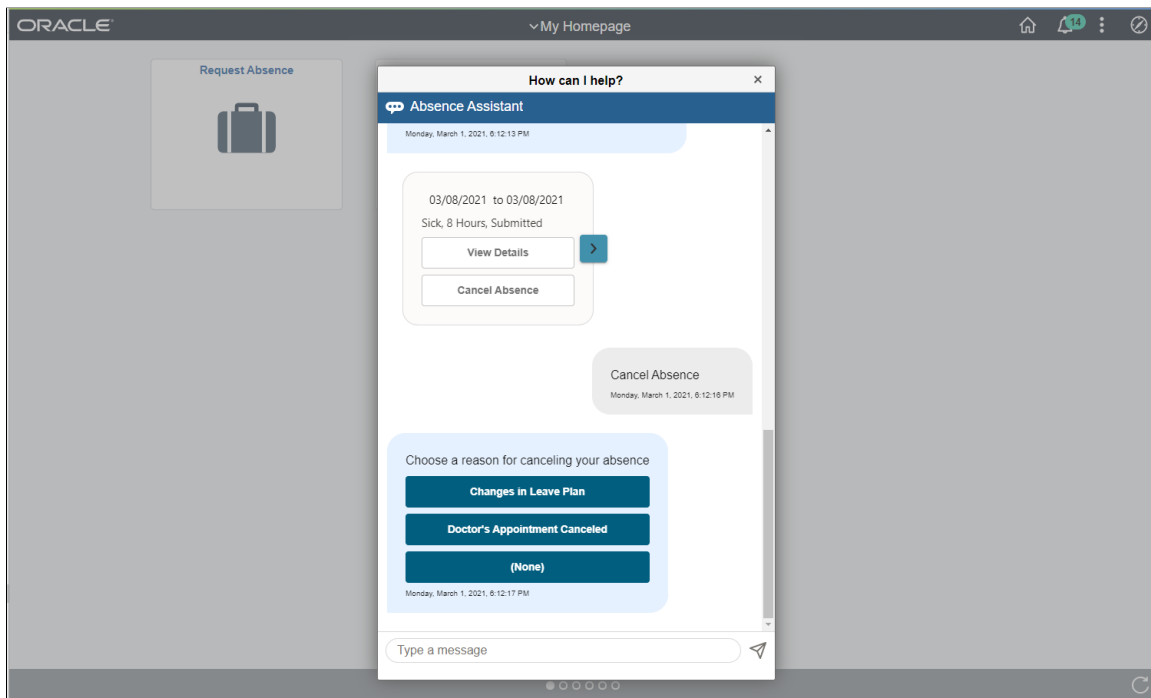

Apart from the guided assistance, you can type in the task to perform, for example, I want to cancel absence on 24 September 2019.

This example illustrates the fields and controls on the Absence Assistant with transaction information.

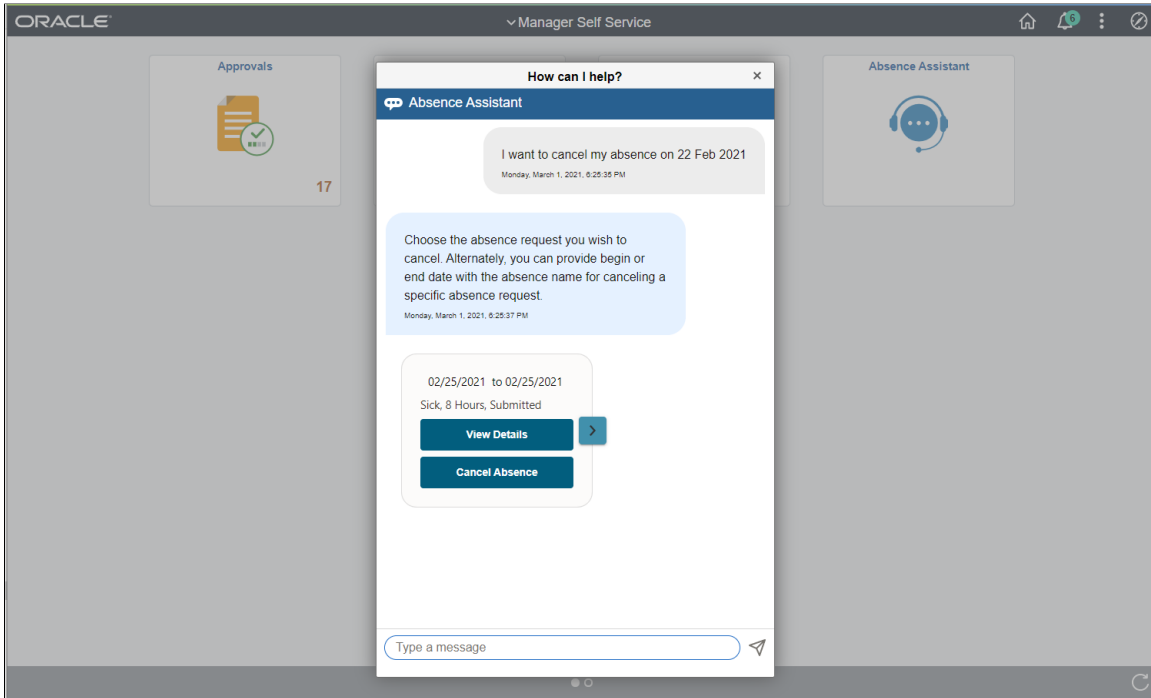

This example illustrates the fields and controls on the Transaction Details.

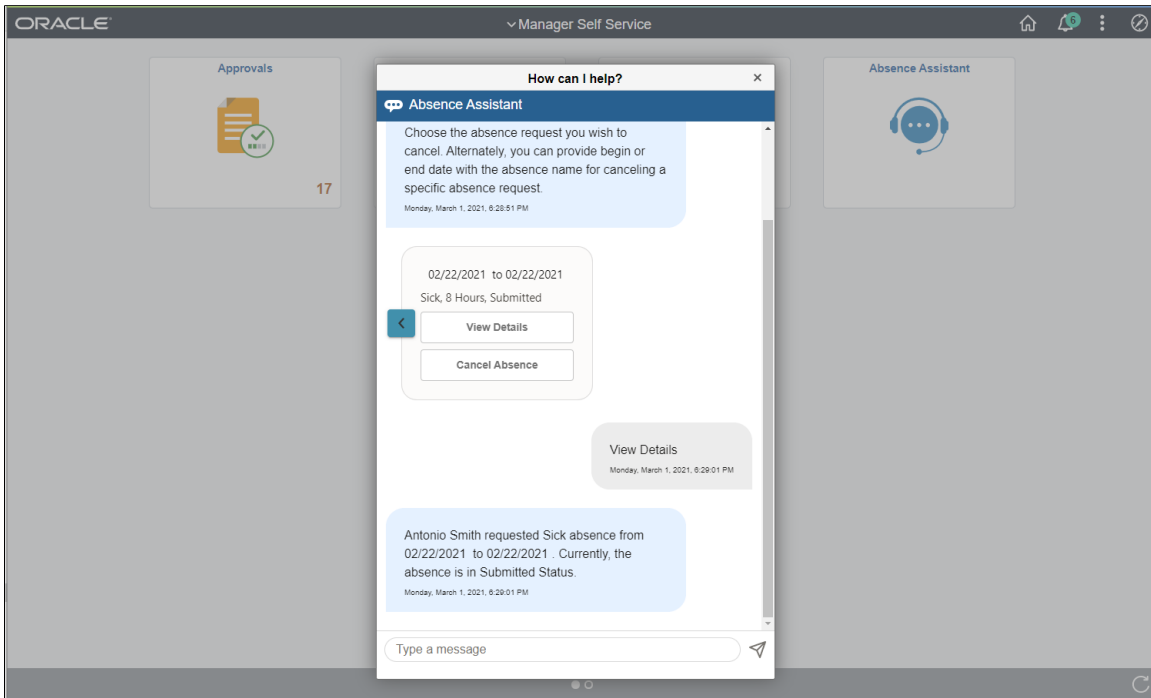

Viewing and Finalizing Absence Results

Common Elements Used to View and Finalize Absence Results

| <i>Field or Control</i> | <i>Description</i> |
|---|--|
| Calculate Action | <p>The following values appear in this field:</p> <p><i>Calculate:</i> The segment has been calculated.</p> <p><i>Calculate and Replace:</i> The segment was originally calculated and later an off-cycle correction, with a correction type of replacement, is selected.</p> <p><i>Reverse:</i> The segment was calculated originally, but during the recalculation period, the payee was no longer eligible for selection, and the segment was reversed. For example, assume that a payee was originally in Pay Group A but moved to Pay Group B. A retroactive change is made to switch the payee to Pay Group B. <i>Reversal</i> segments are created for the Pay Group A calendar during the retroactivity, to <i>reverse</i> the previous calculation.</p> |
| EmplID From (employee ID from) and EmplID To (employee ID to) | Enter the employee IDs of the first and last payees in the range (on inquiry pages) or to be included in the processing stream. |
| Paid and Unpaid | The portions of the day count that are paid and unpaid. |
| Revision Number and Version Number | <p>Together, these fields indicate whether an amount was recalculated due to retroactivity and (if so) which retroactive method was applied:</p> <p>When the retro method is corrective, the version number increments by 1; the Revision Number stays at 1.</p> <p>The original set of output results for a calendar calculation is Version 1, Revision 1.</p> |
| Segment Number | The number that is associated with the segment. The value <i>1</i> appears if the calendar is not segmented. |

Viewing Absence Processing Results

After running the Calculate phase, you can view the results. Processing results appear on the components listed below. We suggest that you view the pages in the order shown.

| Results Pages | Purpose |
|------------------------------|---|
| Log File | Enables the system administrator to determine whether the COBOL process was executed successfully. |
| Processing Statistics | Provides processing statistics for the run, including the number of payees that are in error. View by calendar or calendar group. |
| Payee Iterative List | Lists those payees for whom the system has performed interactive calculations. |
| Payee Messages | Shows error messages and warnings. |
| Payee Status | Enables you to view the calculation status of payees and to enter processing instructions for individual payees. |
| Results by Calendar Group ID | Shows a payee's calculated absence results, accumulators, and supporting elements for each calendar that is associated with the calendar group ID that you select. You also see calculations by calendar segments, positive input, and retroactive calculations. |
| Results by Calendar | These pages display the same information as the Results by Calendar Group pages, but only for the calendar that you select. You can view the results of a calendar that has been used in different Calendar Groups. For example, if retroactivity causes a calendar to be run more than once, you can access the results of the original run, plus the results of each retroactive run. |
| Element Resolution Chain | Shows how each element was resolved. |

These pages can also be a helpful resource after the Finalize phase. All information remains available after you finalize a run except for Payee Messages and Iterative Triggers. Canceling an entire absence run deletes all results.

Viewing the Log File

This topic discusses viewing the Log File generated by an absence process.

The Log File gives the system administrator basic information about the run and whether it was completed successfully. The language in which this file is produced is determined by the user ID of the person who enters the processing instructions on the Calculate Absence and Payroll page.

Example 1: Log File for Successfully Completed Run

The database name and the processing options that you selected on the Calculate Absence and Payroll page appear at the top of the file:

```

Process started           :                13:27:09

Connecting to Database           GP830DVL
  with User ID                 :                PSGP
  and Batch Run ID              :                1

Calendar Group ID           K0CRUSA 199910
  Stream Number                :                00
  Group List ID                 :
  Identify Option               :                No
  Calculation Option            :                Y
  - Trace Option                :                A
  - Recalculate All             :                N
  Unfreeze Option               :                N
  Freeze Option                 :                N
  Finalize Option               :                N
  Cancel Option                 :                N

```

The Checkpoint Interval and Progress Interval that you selected on the Installation Settings page appear in the next section of the Log File.

```

Checkpoint / Restart

  CheckPoint Interval          :                1000
  Progress Interval            :                0500

```

Information about the run phase follows. You can see some of the same information when you select the **Restart Information** link on the Payroll/Absence Run Control page.

```
Run Phase           :                1
  Cancel Pgm Option :
  Identify Pgm Option :
  Next Program       :
  Next Step          :                0000
  Next Number        :                00
  Next Employee ID   :
```

Processing Payee Range

```
  First Employee ID :                B-BARET100
  Last Employee ID  :                ZP007
```

A timestamp message appears at the beginning and end of each processing phase. The timestamps represent application server machine time, not database time.

```

Initial Phase started      :                13:27:12

    Looking for T&L feed
    COMMIT TAKEN

Initial Phase ended       :                13:27:12

Iterative Phase started:                13:27:12

    COMMIT TAKEN

Iterative Phase ended    :                13:27:12

Cancel   Phase started:                13:27:12

    Canceling Selectively for Recalculation
    Total number of Segments processed   :                0
    COMMIT TAKEN

Cancel   Phase ended     :                13:27:14

Identify Phase started:                13:27:14

    Iterative screening for new Payees

    Total number of Payees identified    :                10
    Total number of Segments identified  :                20
    COMMIT TAKEN

Identify Phase ended     :                13:27:17

Calculate Phase started:                13:27:18

    Looking for T&L feed
    COMMIT TAKEN

    Total number of Payees processed     :                10
    Total number of Segments processed   :                20
    Total number of Payees in error      :                0
    Total number of Segments in error    :                0

Calculate Phase ended    :                13:27:45

```

Example 2: Log File for Run That Is Terminated by an Error

The database name and the processing options that you selected on the Payroll/Absence Run Control page appear at the top of the file:

```

Process started          :                11:06:34

Connecting to Database          GP830TS1
  with User ID                :                PS
  and Batch Run ID            :                GGTEST

Calendar Group ID          GXHCRUSA 199910
  Stream Number              :                00
  Group List ID              :
  Identify Option            :                N
  Calculation Option         :                Y
  - Trace Option             :                N
  - Recalculate All          :                Y
  Unfreeze Option           :                N
  Freeze Option              :                N
  Finalize Option           :                N
  Cancel Option              :                N

Checkpoint / Restart

  CheckPoint Interval       :                1000
  Progress Interval        :                0500
  Run Phase                 :                1
  Cancel Pgm Option        :
  Identify Pgm Option      :
  Next Program              :
  Next Step                 :                0000
  Next Number               :                00
  Next Employee ID         :

Processing Payee Range

  First Employee ID        :                B-BARET100
  Last Employee ID         :                Z9060

Initial Phase started     :                11:06:38

```

```

  Looking for T&L feed

```

```

  COMMIT TAKEN

```

```

Initial Phase ended      :                11:06:38

```

The actual error message appears on the next line.

```
Error Message      : [Microsoft][ODBC SQL Server Driver]String data, right truncation⇒
(SQLSTATE 01004) 0

Application Program Failed

In Pgm Section    : GPPDPDM1: RD000

Application Program Failed

In Pgm Section    : GPPDPDM0: XA000-GET-NEXT-SEGMENT

Application Program Failed

In Pgm Section    : GPPSERVC: XP000-CALL-PMT-DATA-MGR

Application Program Failed

In Pgm Section    : GPPDPRUN: JA000-CALL-SERVICE

Process ended      :                               11:06:48

The process terminated with ERRORS.
```

Related Links

[Understanding Batch Processing Errors](#)

Viewing Processing Statistics

The Processing Statistics component displays high-level processing results:

- The number of payees that are identified, in error, calculated, or finalized.
- The number of active, inactive, canceled, and suspended payees.

Pages Used to View Processing Statistics

| <i>Page Name</i> | <i>Definition Name</i> | <i>Usage</i> |
|--|------------------------|---|
| By Calendar Group Page | GP_CALRUN_STAT1 | View processing statistics for the absence run by calendar group. First, run the Identify phase. |
| By Calendar Page | GP_CALRUN_STAT2 | View processing statistics for the absence run by calendar. |

By Calendar Group Page

Use the By Calendar Group page (GP_CALRUN_STAT1) to view processing statistics for the absence run by calendar group.

First, run the Identify phase.

Navigation:

Global Payroll & Absence Mgmt > Absence and Payroll Processing > Review Absence/Payroll Info > Processing Statistics > By Calendar Group

This example illustrates the fields and controls on the Processing Statistics - By Calendar Group page.

| By Calendar Group | | By Calendar | |
|------------------------------------|-----------|------------------------------|-------------------------------|
| Calendar Group ID | | K0WCR PION04M01 | Absence Mgmt-PI OnCycle 04M01 |
| by Selection Status ? | | | |
| Active | 10 | Active Percentage | 100.00 % |
| Inactive | 0 | Inactive Percentage | 0.00 % |
| Canceled | 0 | Canceled Percentage | 0.00 % |
| Suspended by User | 0 | Percentage by User | 0.00 % |
| Suspended by System | 0 | Percentage by System | 0.00 % |
| Total by Selection Status | 10 | | |
| by Calculation Status ? | | | |
| Identified | 0 | Percentage Identified | 0.00 % |
| In Error | 0 | Percentage in Error | 0.00 % |
| Calculated | 0 | Percentage Calculated | 0.00 % |
| Frozen | 0 | Percentage Frozen | 0.00 % |
| Finalized | 10 | Percentage Finalized | 100.00 % |
| Total by Calculation Status | 10 | | |
| by Segment Status ? | | | |
| Active in Calendar | 10 | Percent Active in Calendar | 100.00 % |
| Inactive Post-Termination | 0 | Percent Inactive - Post Term | 0.00 % |
| Total by Segment Status | 10 | | |

by Selection Status

| <i>Field or Control</i> | <i>Description</i> |
|-------------------------|---|
| Active | Payees that were identified for processing because they were active for at least one day within the calendar period. Excludes payees with the selection status <i>Cancelled</i> or <i>Suspended</i> . |
| Inactive | Payees that were identified for processing because they were inactive but had positive input, a retroactive trigger, or forwarded adjustment. |

| <i>Field or Control</i> | <i>Description</i> |
|--------------------------------|--|
| Cancelled | Payees that you manually cancelled from the calendar group ID on the Payee Status page. |
| Suspended by User | Payees that you manually suspended from the calendar group ID through the Payee Status page or the Calculate Absence and Payroll page. |
| Suspended by System | Payees that the system suspended because the payee was also identified in another open calendar group ID. |

by Calculation Status

This group box displays the number of payees with calculation statuses, followed by the percentage that each number represents.

by Segment Status

This group box displays the number of active and inactive payees, followed by the percentage that each number represents.

| <i>Field or Control</i> | <i>Description</i> |
|----------------------------------|--|
| Active in Calendar | Payees that were identified because they were active for at least one day within the calendar period. |
| Inactive Post-Termination | Payees that are being paid for a period of time when they were inactive (such as a sales commission paid to a person that has left the company) or for a forwarding retro situation where there is a mismatch on the payment keys. |

Related Links

[Understanding Retroactive Processing](#)

By Calendar Page

Use the By Calendar page (GP_CALRUN_STAT2) to view processing statistics for the absence run by calendar.

Navigation:

Global Payroll & Absence Mgmt > Absence and Payroll Processing > Review Absence/Payroll Info > Processing Statistics > By Calendar

The fields on the By Calendar page are the same as those on the By Calendar Group page, but they reflect the results for an individual calendar.

To view statistics for the next or previous calendar that is associated with this calendar group ID, click the scroll arrows on the Calendar Statistics title bar.

Related Links

[Understanding Batch Processing Errors](#)

Viewing Payee Iterative Lists

The payee iterative list provides an inquiry page that enables users to see who was processed during the last iterative calculation and why. Users can define whom the list includes: a single payee, payees that were recalculated, or an entire calendar group. Each batch process automatically creates a payee iterative list of those payees affected by the batch run.

The Payee Iterative List is deleted when you run the Finalize process.

Page Used to View Payee Iterative Lists

| <i>Page Name</i> | <i>Definition Name</i> | <i>Usage</i> |
|---|------------------------|--|
| Payee Iterative List Page | GP_PYE_ITER_LST | View a list of employees that were processed in any manner during a batch process. |

Payee Iterative List Page

Use the Payee Iterative List page (GP_PYE_ITER_LST) to view a list of employees that were processed in any manner during a batch process.

Navigation:

Global Payroll & Absence Mgmt > Absence and Payroll Processing > Review Absence/Payroll Info > Payee Iterative List

This example illustrates the fields and controls on the Payee Iterative List page.

Payee Iterative List

Calendar Group ID K0WCR PION05M01 Absence Mgmt-PI OnCycle 05M01 Country CYM

Selection Criteria

Empl ID From

Empl ID To

Process Number

Most Current Iteration

Process Action

Process Reason

| Payees | | | | | | | | | |
|---------|------|----------------|----------------|----------------|--------------------------|---------|----------|--------|-----------|
| Empl ID | Name | Process Number | Process Action | Process Reason | Current | Results | Messages | Status | Timestamp |
| | | 0 | | | <input type="checkbox"/> | Results | Messages | Status | |

Personalize | Find | View All | First 1 of 1 Last

| Field or Control | Description |
|-------------------------------|---|
| Calendar Group ID | This list is available until the process is finalized for the Calendar Group, at which time the payee iterative list is deleted. |
| Process Number | The process number has an associated operator ID, run control, timestamp, and group list ID. |
| Most Current Iteration | Select to return only the payees processed in the last calendar group run. |
| Process Action | The process action represents the high level reason for inclusion. They are <i>Added</i> , <i>Calculated</i> , <i>Status Change</i> , <i>Not Calculated</i> , and <i>Removed</i> |
| Process Reason | Select a Process Reason to limit your search. Available options are: <i>Cancelled – By User</i> , <i>Error in Processing</i> , <i>Frozen – Run Control</i> , <i>Initial Calculation</i> , <i>Initial Identify</i> , <i>Iterative Trigger</i> , <i>Previously in Error</i> , <i>ReCalc – By User</i> , <i>ReCalc All – Run Control</i> , <i>Suspended – By User</i> , <i>Suspended – By System</i> , <i>Time and Labor Feed</i> , <i>Uncancelled – By User</i> , <i>Unfrozen – By Run</i> , and <i>Unuspended – By System</i> . Note: If you run the <i>Initial Identify</i> and a calculation at the same time, the Action/Reason displayed is <i>Calculated/Initial Identify</i> . |
| Select Payees | Runs the search according to the specifications that you selected in the Selection Criteria group box. |
| Name | Displays the resulting EmplIDs. |
| Current | The system displays a <i>Y</i> if the viewed entry is the most current. |
| Results | Select to launch the Results by Calendar Group in a new browser window. |
| Messages | Select to launch the Payee Message page in a new browser window. |
| Status | Select to launch the Payee Status page in a new browser window. |
| Timestamp | Displays when the run control was saved. |

Viewing Payee Messages

Payee messages report errors and warnings that are generated during the Calculate phase. The system displays messages that are defined by PeopleSoft in the Message Catalog and any unique messages that you created using formula elements. You specify the population of payees for whom you want to review messages.

The message log is erased when you run the Finalize process.

Important! Error messages require resolution; you cannot finalize an absence run with errors.

Pages Used to View Payee Messages

| <i>Page Name</i> | <i>Definition Name</i> | <i>Usage</i> |
|-------------------------------------|------------------------|--|
| Payee Messages Page | GP_MESSAGE_LOG | View errors and warnings generated for the calendar group ID during the Identify or Calculate phase. |
| Batch Message Details Page | GP_MESSAGE_SP | View detailed information for a selected message. |

Payee Messages Page

Use the Payee Messages page (GP_MESSAGE_LOG) to view errors and warnings generated for the calendar group ID during the Identify or Calculate phase.

Navigation:

Global Payroll & Absence Mgmt > Absence and Payroll Processing > Review Absence/Payroll Info > Payee Messages > Payee Messages

This example illustrates the fields and controls on the Payee Messages page.

To view payee messages:

1. Enter the criteria for screening messages in the Selection Criteria group box. (optional)

If you select a group list ID, messages for payees that currently belong to the group display. If you enter no selection criteria, messages for all payees in the calendar group display.

2. Click **Select Matching Messages** to display the results of your search.

Message

| <i>Field or Control</i> | <i>Description</i> |
|-------------------------|--|
| Message | Messages appear in the language that is associated with the user's language preference. Messages that have not been translated appear in the base language that is defined for Absence Management. |
| Set and Number | Associated set number and message number from the Message Catalog. (Message Set 17005 is the core batch message set; each country has a separate set number for messages from their country-specific batch processes.) If the message number is less than 300, the text only appears in the Cobol log file. Those with numbers greater than 300 appear online. |
| Details | Click to access the Batch Message Detail page to see the full text of the message, an explanation, and the name of the Absence Management program and program section that generated the message. |

Payment Data

This tab displays the calendar ID, pay group, and segment associated with the warning or error message.

Related Links

[Status Codes and Process Indicators](#)

Viewing Payee Status and Updating a Payee's Processing Instructions

Important! Changing a process indicator updates the process indicator for *every* calendar that is associated with the payee for a particular calendar group ID.

Page Used to View Payee Status and Update a Payee's Processing Instructions

| Page Name | Definition Name | Usage |
|-----------------------------------|------------------------|--|
| Payee Status Page | GP_PAYEE_STATUS | View payees by process indicator, calculation status, or other criteria and specify the action that the system is to take. |

Related Links

[Status Codes and Process Indicators](#)

Payee Status Page

Use the Payee Status page (GP_PAYEE_STATUS) to view payees by process indicator, calculation status, or other criteria and specify the action that the system is to take.

Navigation:

Global Payroll & Absence Mgmt > Absence and Payroll Processing > Review Absence/Payroll Info > Payee Status > Payee Status

This example illustrates the fields and controls on the Payee Status page.

The screenshot shows the 'Payee Status' page with the following details:

- Calendar Group:** K0WCR PION05M01
- Absence Mgmt-PI OnCycle:** 05M01
- Country:** CYM
- Selection Criteria:**
 - Empl ID From: [Text Box]
 - Empl ID To: [Text Box]
 - Pay Group: [Text Box]
 - Calendar ID: [Text Box]
 - Group List ID: [Text Box]
 - Calculation Status: [Dropdown]
 - Process Indicator: [Dropdown]
 - Buttons: Select with Matching Criteria, Clear
- Payees Table:**

| Empl ID | Name | Record | *Process Indicator | Calculation Status | Select Status | Calculation Timestamp | Results | Messages |
|---------|------|--------|--------------------|--------------------|---------------|-----------------------|-------------------------|--------------------------|
| | | 0 | [Dropdown] | | | | Results | Messages |

To review payee status:

1. In the Selection Criteria group box, specify which payees to review (optional).

For example, to see all payees that will be suspended from the next run, select *Suspend* in the **Process Indicator** field.

2. Click the **Select with Matching Criteria** button to display the results of your search.

To enter processing instructions for a payee:

1. In the Selection Criteria group box, specify the payees for which you want to enter instructions.
2. On the Payee Status tab, select the applicable process indicator.

Payee Status

The system displays the results of your search. Each segment, including retroactive segments, is listed on a separate line.

| Field or Control | Description |
|--------------------------|---|
| Process Indicator | <p>Select the action for the system to take. Some actions take effect instantly; others take effect the next time you run the batch process for the population that the payee is in. The selection status that's associated with the payee and the absence calculation status determine what actions you can select. (You cannot change process indicators after a run is finalized.)</p> <p>All process indicators apply to all absences for a payee. You can see a payee's list of absences in the Results by Calendar component. If a payee has two process indicators because of two jobs, and you change the value of one process indicator to <i>Cancel</i>, the second process indicator is also set to <i>Cancel</i>, and the payee isn't paid. Options are:</p> <p><i>Cancel</i>: The next time you run Calculate, the payee's results (and segment status record) are deleted. The selection status is <i>Cancel</i>. The payee remains in <i>Cancel</i> status, unless you later change the status to <i>Uncancel</i>.</p> <p><i>Freeze</i>: Allowed only when the calculation status is <i>Payment Calculated</i>. Immediately updates the status to <i>Frozen</i> and causes future runs of the Calculate phase to ignore unprocessed positive input or other changes that have been entered since the payee was last calculated (for this calendar period). Applies to all segments for the payee.</p> <p><i>Normal</i>.</p> <p><i>Re-Calc</i> (recalculate): Use only when the calculation status is <i>Payment Calculated</i> or <i>Frozen</i>. The next time you run Calculate, the payee will be recalculated.</p> <p><i>Suspend</i>: The next time you run the batch process, the payee's results (and segment status record) are deleted. The selection status is set to <i>Suspended by User</i>. The payee is reidentified for inclusion in the absence run.</p> <p><i>Uncancel</i>: Use only if the selection status is <i>Cancelled</i>.</p> <p><i>Unfreeze</i>: Allowed only when the calculation status is <i>Frozen</i>. This action immediately changes the calculation status to <i>Payment Calculated</i>. The next time the Calculate phase is run for this payee, the system processes unprocessed changes (iterative triggers). Applies to all segments for the payee.</p> |

| Field or Control | Description |
|-------------------------|--|
| Results | Click to access the Results by Calendar Group page to view segmentation , accumulator, and supporting element information. |
| Messages | Click to access the Payee Messages page to view errors and warnings generated for the calendar group ID. |

Calendar Data

This tab identifies the segment for which the absence was generated, the pay entity associated with the calendar, and the run type (absence).

Viewing Results by Calendar

Each time you run the Calculate phase, you can use the Results by Calendar pages to display payee information.

You can review the results of a calendar each time it's run. For example, if retroactivity causes the February 2000 calendar to be recalculated in March, April, and May, you can quickly view the results for each calendar run on the Results by Calendar page. Click the scroll arrows to view each set of results for the calendar.

Pages Used to View Results by Calendar

| Page Name | Definition Name | Usage |
|--|------------------------|---|
| Calendar Results Page | GP_RSLT_CAL_SEG | View segmentation information for a payee. Page includes links to other pages that display positive input, absence, and retroactive results. |
| Results by Calendar - Result Segment Detail Page | GP_RSLT_SEG_SP | View more information about a segment's process and segment statuses. |
| Earnings and Deductions Page | GP_RSLT_CAL_ED | This page is not applicable to Absence Management. No information appears on this page. This page will display only if Global Payroll Core is selected on the Installation Table. |
| Results by Calendar - Accumulators Page | GP_RSLT_CAL_ACUM | View accumulator amounts. |

| Page Name | Definition Name | Usage |
|--|------------------------|---|
| Results by Calendar - Supporting Elements Page | GP_RSLT_CAL_PIN | View information for each supporting element that was used to calculate absence results. |
| Retro Calculation Deltas Page | GP_RSLT_CAL_DLTA | This page is not applicable to Absence Management. No information will appear on this page. |

Related Links

[Viewing Results by Calendar Group](#)

Calendar Results Page

Use the Results by Calendar - Calendar Results page (GP_RSLT_CAL_SEG) to view segmentation information for a payee.

Page includes links to other pages that display positive input, absence, and retroactive results.

Navigation:

Global Payroll & Absence Mgmt > Absence and Payroll Processing > Review Absence/Payroll Info > Results by Calendar > Calendar Results

This example illustrates the fields and controls on the Calendar Results page.

The screenshot shows the 'Calendar Results' page for employee Lionel Blitz. It includes tabs for 'Calendar Results', 'Earnings and Deductions', 'Accumulators', and 'Supporting Elements'. Employee details include: Employee Name: Lionel Blitz, Employee ID: K0W101, Empl Record: 0, Calendar ID: K0WCA PION04M12, Pay Group: K0WPG PI1, and Absence Management to PI. A table titled 'Segment Information by Calendar Group' contains one row with the following data:

| Calendar Group ID | Segment Begin Date | Segment End Date | Calculate Action | Segment Number | Version Number | Revision Number | Segment Detail |
|-------------------|--------------------|------------------|------------------|----------------|----------------|-----------------|--------------------------------|
| K0WCR PION04M12 | 12/01/2004 | 12/31/2004 | Calculate | 1 | 1 | 1 | Segment Detail |

Below the table, there are 'Additional Result Pages' with links for: Positive Input - Absence, Absence Data, Positive Input - Payroll, Retro Calculation Deltas, and Generated Positive Input.

| Field or Control | Description |
|-------------------------|--|
| Segment Detail | Click to display the Result Segment Detail page. |

Results by Calendar - Result Segment Detail Page

Use the Results by Calendar - Result Segment Detail page (GP_RSLT_SEG_SP) to view more information about a segment’s process and segment statuses.

Navigation:

Click the Segment Detail link on the Results by Calendar page.

This example illustrates the fields and controls on the Results by Calendar - Result Segment Detail page.

| | | |
|--|-------------------------------|--------------------------------------|
| Result Segment Detail | | |
| Results by Calendar | | |
| Result Segment Detail for K0W101 (Lionel Blitz) | | |
| Employee | Person ID K0W101 | Record 0 |
| Period Information | | |
| Calendar Group ID K0WCR PION04M12 | Absence Mgmt-PI OnCycle 04M12 | <input type="checkbox"/> Off Cycle |
| Pay Group K0WPG P11 | Calendar ID K0WCA PION04M12 | Pay Entity K0WPE ABS1 |
| Period ID K0CA04M12 | Target Calendar ID | Country CYM |
| Begin Date 12/01/2004 | Calc Time 09/28/2004 10:59PM | Run Type K0WRYABS |
| End Date 12/31/2004 | Selection Status Active | Calculation Type Absence Calculation |
| Payment Date 12/31/2004 | | |
| Segment Information | | |
| Begin Date 12/01/2004 | Segment Number 1 | Revision Number 1 |
| End Date 12/31/2004 | Calculate Action Calculate | Version Number 1 |
| Gross Result 0.00 | Net Result 0.00 | Currency USD |
| Rate Type OFFIC | Calculation Status Finalized | |
| Payment Keys | | |
| Payment Key Nbr1 | | |
| Payment Key Nbr2 | | |
| Payment Key Nbr3 | | |
| Payment Key Nbr4 | | |

Period Information

| <i>Field or Control</i> | <i>Description</i> |
|-------------------------------------|---|
| Period ID | The ID for the time period that is covered by the calendar. |
| Begin Date and End Date | The begin and end dates that are associated with the Process Stat record. The dates match the calendar begin and end dates. |
| Target Calendar ID | The target calendar that you selected when defining the calendar for this calendar run. |
| Calc Time (calculation time) | The last time that calculations were run for this payee. |

Segment Information

| <i>Field or Control</i> | <i>Description</i> |
|---------------------------|--|
| Rate Type | The exchange rate type associated with the payment. (You define the exchange rate type on the Pay Group Name page and can override it by payee.) |
| Calculation Status | Values are: <i>Active in Segment:</i> Payee was active for at least one day during the calendar segment. <i>Inactive in Segment:</i> Payee was not active during that time period. |
| Transaction Type | Appears for off-cycle results. Values are <i>Correction</i> and <i>Advance</i> . |

Payment Keys

This group box displays any payment keys that have been defined for the payee's pay entity.

Related Links

[Status Codes and Process Indicators](#)

[Processing Details Page](#)

Results by Calendar - Accumulators Page

Use the Results by Calendar - Accumulators page (GP_RSLT_CAL_ACUM) to view accumulator amounts.

Navigation:

Global Payroll & Absence Mgmt > Absence and Payroll Processing > Review Absence/Payroll Info > Results by Calendar > Accumulators

This example illustrates the fields and controls on the Results by Calendar - Accumulators page.

Calendar Results
Earnings and Deductions
Accumulators
Supporting Elements

Lionel Blitz Employee Empl ID K0W101 Empl Record 0
 Calendar ID K0WCA PION04M12 Pay Group K0WPG PI1 Absence Management to PI

Calendar Information Find | View All First 1 of 1 Last

Calendar Group ID K0WCR PION04M12 Description Absence Mgmt-PI OnCycle 04M12
 Segment Number 1 Version 1 Revision 1
 Gross Result Value 0.00 USD Net Result Value 0.00 USD

Accumulators Personalize | Find | View All | First 1-5 of 6 Last

Accumulator Results
User Keys

| Period | Element Name | Amount | Description | From | Through |
|---------------|-----------------|------------|---------------------------|------------|------------|
| Year to Date | K0WAE SICK_BAL | 96.000000 | Sick Balance Hrs | 01/01/2004 | 12/31/2004 |
| Year to Date | K0WAE SICK_ENT | 96.000000 | Sick Entitlement Hrs | 01/01/2004 | 12/31/2004 |
| Year to Date | K0WAE VAC_BAL | 192.000000 | Vacations Balance Hrs | 01/01/2004 | 12/31/2004 |
| Year to Date | K0WAE VAC_ENT | 192.000000 | Vacations Entitlement Hrs | 01/01/2004 | 12/31/2004 |
| Custom Period | K0WAC SICK_CUST | 96.000000 | Sickness Balance Cust | 01/01/2000 | |

Accumulator Results

| <i>Field or Control</i> | <i>Description</i> |
|-------------------------|--|
| Period | The period of time tracked by the accumulator. |

User Keys

This tab displays the system element or variable element that is associated with the user keys for each accumulator.

Results by Calendar - Supporting Elements Page

Use the Results by Calendar - Supporting Elements page (GP_RSLT_CAL_PIN) to view information for each supporting element that was used to calculate absence results.

Navigation:

Global Payroll & Absence Mgmt > Absence and Payroll Processing > Review Absence/Payroll Info > Results by Calendar > Supporting Elements

This example illustrates the fields and controls on the Results by Calendar - Supporting Elements page.

| Calendar Results | | Earnings and Deductions | | Accumulators | | Supporting Elements | |
|-----------------------------------|-----------------|---|------------|---|------------|---------------------|----------------|
| Lionel Blitz | | Employee | | Empl ID K0W101 | | Empl Record 0 | |
| Calendar ID K0WCA PION04M12 | | Pay Group K0WPG PI1 | | Absence Management to PI | | | |
| Calendar Information | | | | Find View All First 1 of 1 Last | | | |
| Calendar Group ID K0WCR PION04M12 | | Description Absence Mgmt-PI OnCycle 04M12 | | | | | |
| Segment Number 1 | | Version 1 | | Revision 1 | | | |
| Gross Result Value 0.00 USD | | Net Result Value 0.00 USD | | | | | |
| Supporting Elements | | | | Personalize Find View All First 1-3 of 3 Last | | | |
| Element Type | Element Name | Description | Amount | Character Value | Date Value | Slice Begin Date | Slice End Date |
| Absence Entitlement | K0WAE SICK | Sick | 8.000000 | | | 12/01/2004 | 12/31/2004 |
| Absence Entitlement | K0WAE VAC | Vacations Entitlement | 16.000000 | | | 12/01/2004 | 12/31/2004 |
| Bracket | K0WBR VACATIONS | Vacations Granted Time | 192.000000 | | | 12/01/2004 | 12/31/2004 |

The type of value that the supporting element resolved to determines the column that it is listed under **Amount**, **Character Value**, or **Date Value**.

| Field or Control | Description |
|-------------------------------------|--|
| Slice Begin Date and Slice End Date | The begin and end dates of the slice in which the supporting element was resolved. |

Viewing Positive Input Results

Pages Used to View Positive Input Results

| Page Name | Definition Name | Usage |
|--|--------------------|--|
| <u>Positive Input - Absence Page</u> | GP_RSLT_CAL_AE | Displays balance adjustments made to frequency-based entitlement elements that are processed for the absence calendar. |
| Positive Input - Payroll Page | GP_RSLT_CAL_PI | This page is not applicable to Absence Management. No information will appear on this page. |
| Positive Input - Other Data (Note: This page is not applicable to Absence Management) Page | GP_RSLT_PI_COMP_SP | This page is not applicable to Absence Management. No information will appear on this page. |
| Positive Input - Supporting Element Overrides Page | GP_RSLT_PI_SOVR_SP | View detailed user instructions on the Positive Input - Supporting Elements page. |

| Page Name | Definition Name | Usage |
|--|------------------------------------|--|
| Generated Positive Input Page | GP_RSLT_CAL_GPI GP_RSLT_RUN_GPI | View resolved and unresolved positive input that was created for another calendar from a generated positive input section of the process list or the absence take process. |
| Results by Calendar - Positive Input - Details Page | GP_RSLT_GPICOMP_SP | Displays detailed information for a system-generated instance of positive input. |
| Generated Positive Input - Supporting Element Overrides Page | GP_RSLT_GPISOVR_SP | Displays information for supporting elements that are associated with a system-generated instance of positive input. |

Positive Input - Absence Page

Use the Positive Input - Absence page (GP_RSLT_CAL_AE) to view balance adjustments made to frequency-based entitlement elements that are processed for the absence calendar.

Navigation:

- **Global Payroll & Absence Mgmt > Absence and Payroll Processing > Review Absence/ Payroll Info > Results by Calendar > Calendar Results**

Click the **Positive Input - Absence** link on the Calendar Results page.

- **Global Payroll & Absence Mgmt > Absence and Payroll Processing > Review Absence/ Payroll Info > Results by Calendar Group > Calendar Group Results**

Click the **Positive Input - Absence** link on the Calendar Group Results page.

This example illustrates the fields and controls on the Positive Input - Absence page.

The screenshot shows the 'Positive Input - Absence' page for employee Lionel Blitz. The page header includes navigation tabs: 'Calendar Results', 'Positive Input - Absence' (selected), 'Positive Input - Payroll', and 'Generated Positive Input'. Employee information includes 'Lionel Blitz' (Employee), 'Empl ID KOW101', and 'Empl Record 0'. Calendar details include 'Calendar ID K0WCA PION04M12' and 'Pay Group K0WPG PI1'. A 'Calendar Information' section shows 'Calendar Group ID K0WCR PION04M12', 'Absence Mgmt-PI OnCycle 04M12', 'Segment Number 1', 'Version 1', and 'Revision 1'. Below this is a 'Balance Adjustments' table with columns: Element Name, Source, Action Type, Balance Adjustment, Begin Date, and End Date. The table is currently empty. At the bottom, there is a link 'Return To Main Result Pages'.

| Field or Control | Description |
|---------------------------------------|--|
| Source | <i>Absence</i> means that the instance of positive input was created by the Absence Take process. |
| Balance Adjustment | The number of units by which the entitlement balance for this absence take element is being adjusted, if applicable. |
| Begin Date and End Date | The first day and last day of the absence event. |

Generated Positive Input Page

Use the Generated Positive Input page (GP_RSLT_CAL_GPI) to view resolved and unresolved positive input that was created for another calendar from a generated positive input section of the process list or the absence take process.

Navigation:

- Click the **Generated Positive Input** link on the Calendar Results page.
- Click the **Generated Positive Input** link on the Calendar Group Results page.

This example illustrates the fields and controls on the Generated Positive Input page.

| Field or Control | Description |
|-------------------------|---|
| Other Data | Click to display the Other Data page to view detailed information about the instance of positive input. |
| Override | Click to display the Supporting Element Overrides page to view information for supporting elements that are associated with the generated instance. |

Generated Positive Input - Supporting Element Overrides Page

Use the Generated Positive Input - Supporting Element Overrides page (GP_RSLT_GPISOVR_SP) to view information for supporting elements that is associated with a system-generated instance of positive input.

Navigation:

Click the **Override** button on the Generated Positive Input page.

This example illustrates the fields and controls on the Results by Calendar - Supporting Element Overrides page.

SETID Data

This tab displays the SetID associated with the supporting element override.

Related Links

[Understanding Overrides](#)

Viewing Daily Results of the Absence Take Process

Pages Used to View Daily Results of the Absence Take Process

| <i>Page Name</i> | <i>Definition Name</i> | <i>Usage</i> |
|---|------------------------------------|--|
| Absence Data Page | GP_RSLT_CAL_ABS GP_RSLT_RUN_ABS | View the daily results of the Absence Take process, including the day count, paid and unpaid day count, ending entitlement balance, forecast value, absence type, and reason. |
| Absence Balance Data Page | GP_ABS_EXPLAIN_SP | View detailed information about the payee’s entitlement balance. |
| Absence Begin/End Data Page | GP_ABS_BGN_END_SP | View the hours that a payee was absent, if less than a full day. This page shows the first date of the absence and the original begin date, if this absence is linked to a previous absence. |

| Page Name | Definition Name | Usage |
|--|------------------------|--|
| <u>Configurable Fields Page</u> | GP_ABS_CONFIG_SP | View values that were entered in the User Defined fields when the absence was reported and the User Defined values that are associated with the take element. |
| <u>Work Schedule Data Page</u> | GP_ABS_WS_SP | View values that were entered in the Sch Cfg1...4 fields (Shifts page) that apply to the absence date. Also view values for the Sch Cfg fields that are associated with the Workday override schedule selected on the Daily Work Schedule Override page. |
| <u>Alternate Work Schedule Data Page</u> | GP_ABS_ALT_WS_SP | View values that were entered in the Sch Cfg1...4 fields (Shifts page or Daily Work Schedule Override page) that apply to the absence date. Applicable only if an alternate work schedule was in effect on the absence day. |

Absence Data Page

Use the Absence Data page (GP_RSLT_CAL_ABS) to view the daily results of the Absence Take process, including the day count, paid and unpaid day count, ending entitlement balance, forecast value, absence type, and reason.

Navigation:

- **Global Payroll & Absence Mgmt > Absence and Payroll Processing > Review Absence/ Payroll Info > Results by Calendar > Calendar Results**

Click the **Absence Data** link on the Calendar Results page.

- **Global Payroll & Absence Mgmt > Absence and Payroll Processing > Review Absence/ Payroll Info > Results by Calendar Group > Calendar Group Results**

Click the **Absence Data** link on the Calendar Group Results page.

This example illustrates the fields and controls on the Absence Data page.

Calendar Results | **Absence Data** | Retro Calculation Deltas

Rebekah Jones Employee Empl ID K0G001 Empl Record 0
 Calendar ID K0CA 1999/10 ABS Pay Group K0PGA

Calendar Information Find | View All First 1 of 1 Last

Calendar Group ID K0CRCYM 1999M10 Description October 1999
 Segment Number 1 Version 1 Revision 1
 Gross Result Value 0.00 USD Net Result Value 0.00 USD

Absence Daily Data Personalize | Find | View All | First 1-3 of 5 Last

Absence Detail1 | Absence Detail2 | Begin / End Data | Schedule Data and Config Fields | Related Elements

| Element Name | Description | Absence Date | Day | Day Count | Paid | Unpaid | Entitlement Balance | Balance Detail |
|--------------|---------------|--------------|-----------|-----------|----------|----------|---------------------|----------------|
| K0AT PTO | Paid Time Off | 10/08/1999 | Friday | 8.000000 | | 8.000000 | | Balance Detail |
| K0AT PTO | Paid Time Off | 10/07/1999 | Thursday | 8.000000 | 2.000000 | 6.000000 | | Balance Detail |
| K0AT PTO | Paid Time Off | 10/06/1999 | Wednesday | 8.000000 | 8.000000 | | 2.000000 | Balance Detail |

[Return To Main Result Pages](#)

| Field or Control | Description |
|----------------------------|---|
| Day Count | Displays the result of the Day Formula for the absence take element. |
| Entitlement Balance | Displays the number of paid absence days to which the payee is entitled after taking this absence into account. |
| Balance Detail | Click to open the Absence Balance Data page to view additional information about the absence. |

Absence Detail2

Access the Absence Detail2 tab.

This example illustrates the fields and controls on the Absence Data page: Absence Detail2 tab.

Calendar Results | **Absence Data** | Retro Calculation Deltas

Rebekah Jones Employee Empl ID K0G001 Empl Record 0
 Calendar ID K0CA 1999/10 ABS Pay Group K0PGA

Calendar Information Find | View All First 1 of 1 Last
 Calendar Group ID K0CRCYM 1999M10 Description October 1999
 Segment Number 1 Version 1 Revision 1
 Gross Result Value 0.00 USD Net Result Value 0.00 USD

Absence Daily Data Personalize | Find | View All First 1-3 of 5 Last
 Absence Detail1 | **Absence Detail2** | Begin / End Data | Schedule Data and Config Fields | Related Elements

| Element Name | Description | Absence Date | Absence Type | Absence Reason | Forecast Value |
|--------------|---------------|--------------|--------------|----------------|----------------|
| K0AT PTO | Paid Time Off | 10/08/1999 | | | |
| K0AT PTO | Paid Time Off | 10/07/1999 | | | |
| K0AT PTO | Paid Time Off | 10/06/1999 | | | |

[Return To Main Result Pages](#)

The **Forecast Value** field displays the forecast value for the last day of the absence event.

Begin/End Data

Access the Begin/End Data tab.

This example illustrates the fields and controls on the Absence Data page: Begin/End Data tab.

Calendar Results | **Absence Data** | Retro Calculation Deltas

Rebekah Jones Employee Empl ID K0G001 Empl Record 0
 Calendar ID K0CA 1999/10 ABS Pay Group K0PGA

Calendar Information Find | View All First 1 of 1 Last
 Calendar Group ID K0CRCYM 1999M10 Description October 1999
 Segment Number 1 Version 1 Revision 1
 Gross Result Value 0.00 USD Net Result Value 0.00 USD

Absence Daily Data Personalize | Find | View All First 1-3 of 5 Last
 Absence Detail1 | Absence Detail2 | **Begin / End Data** | Schedule Data and Config Fields | Related Elements

| Element Name | Description | Absence Date | Absence Data Source | Original Begin Date | Begin/End | Holiday Type | Holiday Hours |
|--------------|---------------|--------------|---------------------|---------------------|-----------|--------------|---------------|
| K0AT PTO | Paid Time Off | 10/08/1999 | Event Processing | 10/04/1999 | Begin/End | | |
| K0AT PTO | Paid Time Off | 10/07/1999 | Event Processing | 10/04/1999 | Begin/End | | |
| K0AT PTO | Paid Time Off | 10/06/1999 | Event Processing | 10/04/1999 | Begin/End | | |

[Return To Main Result Pages](#)

| Field or Control | Description |
|----------------------------|---|
| Absence Data Source | <p>Displays the absence process that generated the absence event:</p> <p><i>Take Processing:</i> The row was created when a negative entitlement balance was redirected to another take element (according to instructions on the Absence Take - Negative Balance page) or when the “mapped to” feature (defined on the Absence Take - Day Formula page) resulted in the creation of a second absence event.</p> <p><i>Event Processing:</i> The row was created when the absence event was expanded into daily rows during the Absence Take process.</p> |
| Original Begin Date | If this is a linked absence, the original begin date from the Absence Event Entry page appears. |
| Begin/End | Click to view the Begin/End Data tab to view information about partial-day absences. |
| Holiday Type | If the absence occurred on a holiday, the type of holiday is identified: <i>BRG</i> (bridge), <i>CAN</i> (Canadian), <i>HIGH</i> , <i>LOW</i> , <i>STD</i> (standard), <i>USA</i> (USA public), and <i>VERY</i> (very high). |
| Holiday Hours | Displays the number of hours from the Holiday schedule. |

Schedule Data and Config Fields (schedule data and configuration fields) Tab

Access the Schedule Data and Config Fields tab.

This example illustrates the fields and controls on the Absence Data page: Schedule Data and Config Fields tab.

The screenshot shows the 'Absence Data' page for employee Rebekah Jones. The 'Schedule Data and Config Fields' tab is active. The page includes a table with the following data:

| Element Name | Description | Absence Date | Configurable Fields | Scheduled Work Hours | Work Schedule | Alternate Scheduled Hours | Alternate Work Schedule |
|--------------|---------------|--------------|---------------------|----------------------|---------------|---------------------------|-------------------------|
| K0AT PTO | Paid Time Off | 10/08/1999 | Configurable Fields | 8.00 | Work Schedule | | Alternate Work Schedule |
| K0AT PTO | Paid Time Off | 10/07/1999 | Configurable Fields | 8.00 | Work Schedule | | Alternate Work Schedule |
| K0AT PTO | Paid Time Off | 10/06/1999 | Configurable Fields | 8.00 | Work Schedule | | Alternate Work Schedule |

| Field or Control | Description |
|----------------------------------|---|
| Configurable Fields | Click to access the Configurable Fields page to view information from the User Defined fields that are associated with the absence event and absence take element. |
| Scheduled Work Hours | Displays the number of hours that the payee was scheduled to work on the absence date. |
| Work Schedule | Click to access the Absence Configurable Data page to view the payee’s Work Day ID, data that is contained in the User Defined fields, and information about schedule overrides. |
| Alternate Scheduled Hours | Number of hours that the payee was scheduled to work, according to the payee’s alternate work schedule, on the absence date. |
| Alternate Work Schedule | Click to access the Alternate Work Schedule Data page to view the payee’s Work Day ID, data that is contained in the User Defined fields, and information about schedule overrides for the alternate work schedule. |

Related Elements

Access the Related Elements tab.

This example illustrates the fields and controls on the Absence Data page: Related Elements tab.

Calendar Results
Absence Data
Retro Calculation Deltas

Rebekah Jones Employee

Calendar ID K0CA 1999/10 ABS

Empl ID K0G001 Empl Record 0

Pay Group K0PGA

Calendar Information Find | View All First 1 of 1 Last

Calendar Group ID K0CRCYM 1999M10 Description October 1999

Segment Number 1 Version 1 Revision 1

Gross Result Value 0.00 USD Net Result Value 0.00 USD

Absence Daily Data Personalize | Find | View All | First 1-3 of 5 Last

Absence Detail1
Absence Detail2
Begin / End Data
Schedule Data and Config Fields
Related Elements

| Element Name | Description | Absence Date | Mapped To Element | Source Element | Negative Absence Element |
|--------------|---------------|--------------|-------------------|----------------|--------------------------|
| K0AT PTO | Paid Time Off | 10/08/1999 | | | |
| K0AT PTO | Paid Time Off | 10/07/1999 | | | |
| K0AT PTO | Paid Time Off | 10/06/1999 | | | |

[Return To Main Result Pages](#)

| Field or Control | Description |
|---------------------------------|--|
| Mapped to Element | If the absence take element that is associated with the payee’s absence is mapped to another take element (through the Take - Day Formula page), the name of the absence take element for which the system will generate a matching absence event appears. |
| Source Element | Displays the absence take element that triggered generation of a second absence event. |
| Negative Absence Element | If the event resulted in a negative entitlement balance, and you selected <i>Take with Other Absence</i> for this take element (on the Absence Take - Negative Balance page), the name of the specified take element appears. |

Absence Balance Data Page

Use the Absence Balance Data page (GP_ABS_EXPLAIN_SP) to view detailed information about the payee’s entitlement balance.

Navigation:

Click the **Balance Detail** link on the Absence Detail tab of the Absence Data page.

This example illustrates the fields and controls on the Absence Balance Data page.

| | |
|-----------------------------|--|
| Absence Balance Data | |
| Results by Calendar | |
| Absence Balance Data | |
| Element Name | K0AT PTO |
| Description | Paid Time Off |
| Absence Date | 10/08/1999 |
| Balance Detail | |
| Begin Entitlement Balance | 0.000000 |
| Entitlement Balance | 0.000000 |
| Day Count | 8.000000 |
| Paid | 0.000000 |
| Unpaid | 8.000000 |
| Beginning Wait Balance | 0.000000 |
| Ending Wait Balance | 0.000000 |
| Wait Count | 0.000000 |
| Cumulative Wait Count | 0.000000 |
| Eligibility Date Value | <input checked="" type="checkbox"/> Eligibility Indicator |
| Minimum Period | <input checked="" type="checkbox"/> Minimum Period Indicator |
| Link Period | <input type="checkbox"/> Linked Indicator |

| Field or Control | Description |
|--|--|
| Begin Entitlement Balance and Entitlement Balance | Displays the number of paid absence days to which the payee was entitled before and after taking this absence into account. |
| Day Count | Displays the calculated Day Count. |
| Beginning Wait Balance | If this absence is subject to a wait per absence rule, this field displays the remaining number of days that the payee must be absent before the current absence date can be paid. It does not count the current absence date. |
| Ending Wait Balance | Displays the waiting period balance after the current absence date is taken into account. |
| Wait Count | Displays the result of the Wait Count formula. |
| Cumulative Wait Count | Displays the wait units that are associated with the current absence event. |
| Eligibility Date Value | If the absence is subject to an eligibility period, the date that the payee becomes eligible to take a paid absence appears. Absences that are taken on or after this date can be applied against the entitlement balance. Days before this date are unpaid. |
| Eligibility Indicator | Selected if the eligibility date has been reached. |

| Field or Control | Description |
|---------------------------------|--|
| Minimum Period | If this absence is subject to a minimum period rule, this field displays the minimum number of calendar days that the payee must be absent before he or she can be paid for the entire absence. |
| Minimum Period Indicator | Selected if the minimum absence period for this absence has been met. |
| Link Period | This field applies only if the absence is subject to a linked absence rule. It displays the number of days (or other units) that can elapse between this absence and a related absence for the current absence date to be treated as a linked absence. Linked absences can share the same entitlement and wait period. |
| Linked Indicator | Selected if this absence event is linked to another absence event. |

Absence Begin/End Data Page

Use the Absence Begin/End Data page (GP_ABS_BGN_END_SP) to view the hours that a payee was absent, if less than a full day.

This page shows the first date of the absence and the original begin date, if this absence is linked to a previous absence.

Navigation:

Click the **Begin/End** link on the Begin/End tab of the Absence Data page.

This example illustrates the fields and controls on the Absence Begin/End Data page.

Absence Balance Data

Results by Calendar

Absence Begin / End Data

Element Name **K0AT PTO** Description **Paid Time Off**

Absence Date **10/08/1999**

Begin / End Data ?

Begin Absence Day End Absence Day

Begin Half Day End Half Day

Partial Hours

Absence Begin Date **10/04/1999** Absence End Date

First Event Begin Date **10/04/1999**

| Field or Control | Description |
|-------------------------------|---|
| Element Name | Displays the name of the absence take element. |
| Partial Hours | Displays the hours that the payee was absent, if the payee was absent only part of the day. |
| First Event Begin Date | Displays the date that was entered in the Original Begin Date field on the Absence Event Entry Detail page. |

Configurable Fields Page

Use the Configurable Fields page (GP_ABS_CONFIG_SP) to view values that were entered in the User Defined fields when the absence was reported and the User Defined values that are associated with the take element.

Navigation:

Click the **Configuration Fields** link on the Schedule Data and Config Details tab of the Absence Data page.

This example illustrates the fields and controls on the Configurable Fields page.

| Absence Configurable Data | | | | |
|---------------------------|------------|----------|-------------|---------------|
| Results by Calendar | | | | |
| Configurable Fields | | | | |
| Element Name | K0AT PTO | | Description | Paid Time Off |
| Absence Date | 10/08/1999 | | | |
| Absence Take | | | | |
| Configuration 1 | | | | |
| Configuration 2 | | | | |
| Configuration 3 | | | | |
| Configuration 4 | | | | |
| Absence Event | | | | |
| Date 1 | Decimal 1 | 0.000000 | Character 1 | Monetary 1 |
| Date 2 | Decimal 2 | 0.000000 | Character 2 | Monetary 2 |
| Date 3 | Decimal 3 | 0.000000 | Character 3 | Monetary 3 |
| Date 4 | Decimal 4 | 0.000000 | Character 4 | Monetary 4 |

Absence Take

| Field or Control | Description |
|--|--|
| Configuration 1, Configuration 2, Configuration 3 and Configuration 4 | These fields display information that was entered in the Used Defined fields on the Absence Take - Calculation page. |

Absence Event

These fields display information that a user entered into the User Defined fields on the Absence Event Entry Detail page.

Work Schedule Data Page

Use the Work Schedule Data page (GP_ABS_WS_SP) to view values that were entered in the Sch Cfg1... 4 fields (Shifts page) that apply to the absence date.

Also view values for the Sch Cfg fields that are associated with the Workday override schedule selected on the Daily Work Schedule Override page.

Navigation:

Click the **Work Schedule** link on the Schedule Data and Config Fields tab of the Absence Data page.

This example illustrates the fields and controls on the Work Schedule Data page.

| | |
|---|--|
| Absence Configurable Data | |
| Results by Calendar | |
| Work Schedule Data | |
| Element Name K0AT PTO | Description Paid Time Off |
| Absence Date 10/08/1999 | |
| Schedule Data | Schedule Overrides |
| <p>Scheduled Work Hours 8.00</p> <p>Work Day ID K0WRK1</p> <p>User Defined 1 12.00</p> <p>User Defined 2 4.00</p> <p>User Defined 3</p> <p>User Defined 4</p> | <p><input type="checkbox"/> Schedule Indicator Override</p> <p>Scheduled Hours Override</p> <p>Work Day ID Override</p> <p>User Defined 1 Override</p> <p>User Defined 2 Override</p> <p>User Defined 3 Override</p> <p>User Defined 4 Override</p> |

Schedule Data

| Field or Control | Description |
|-----------------------------|---|
| Scheduled Work Hours | Displays the number of hours the payee was scheduled to work on the absence date. The hours come from the Schedule Hours field on the Shift page. |
| Work Day ID | Displays the Work Day ID for the work pattern assigned to the payee. Word Day IDs are assigned to all members of a pay group via the Pay Group page and can be overridden for a payee on the Assign Schedules (Details) page. |

| Field or Control | Description |
|---------------------------|--|
| User Defined 1 – 4 | Displays the data that was entered in the Sch Cfg 1 – Cfg4 fields on the Shifts page for this shift. |

Schedule Overrides

| Field or Control | Description |
|------------------------------------|---|
| Schedule Indicator Override | Selected if an override was entered for the payee on the Override Scheduled Workday page. |
| Scheduled Hours Override | Displays the scheduled hours that are associated with the Workday override that was entered on the Override Scheduled Workday page. |
| Work Day ID Override | Displays the Work Day ID that was selected as an override on the Override Scheduled Workday page. |
| User Defined 1 – 4 Override | Displays the values of the Sch Cfg fields that are associated with the Workday override schedule selected on the Override Scheduled Workday page. |

Alternate Work Schedule Data Page

Use the Alternate Work Schedule Data page (GP_ABS_ALT_WS_SP) to view values that were entered in the Sch Cfg1...4 fields (Shifts page or Daily Work Schedule Override page) that apply to the absence date.

Applicable only if an alternate work schedule was in effect on the absence day.

Navigation:

Click the **Alternate Work Schedule** link on the Schedule Data and Config Fields tab of the Absence Data page.

The fields on this page are the same as those on the Configurable Fields page, but they apply to the alternate work schedule.

Viewing Results by Calendar Group

Pages Used to View Results by Calendar Group

| <i>Page Name</i> | <i>Definition Name</i> | <i>Usage</i> |
|---|------------------------|---|
| Calendar Group Results Page | GP_RSLT_RUN_SEG | View the processing statistics for an entire calendar group. This component displays the same information as the Results by Calendar component, except that it is for a calendar group rather than an individual calendar. Page includes links to other pages that display positive input, absence, and retroactive processing results. |
| Result Segment Detail Page | GP_RSLT_SEG_SP | View more information about a segment's process and segment statuses. |
| Results by Calendar Group - Earnings and Deductions Page | GP_RSLT_RUN_ED | This page is not applicable to Absence Management. No information will appear on this page. |
| Results by Calendar Group - Element Resolution Details Page | GP_RSLT_RES_SEC | This page is not applicable to Absence Management. No information will appear on this page. |
| Results by Calendar Group - Accumulators Page | GP_RSLT_RUN_ACUM | View accumulator amounts. |
| Results by Calendar Group - Supporting Elements Page | GP_RSLT_RUN_PIN | View information for each supporting element that was used to calculate entitlements and takes. |

Related Links

[Viewing Results by Calendar](#)

Configuring the Processing Monitor

Pages Used to Configure the Processing Monitor

| <i>Page Name</i> | <i>Definition Name</i> | <i>Usage</i> |
|--|------------------------|-----------------------------------|
| Monitor Configuration Page | GP_CS_INSTALL | Configure the Processing Monitor. |

Understanding the Processing Monitor

The Processing Monitor component provides a comprehensive set of processing statistics along with graphical representations of those statistics. The statistical information displayed on this page includes:

- Counts by selection, calculation, and segment status. This information is further broken down by the Absence and Payroll calculation types.
- Summarized gross pay and net pay results for payroll calculations.
- Summarized accumulator results for absence calculations.

The Processing Monitor presents this information by calendar group and by individual calendar.

Note: You cannot use the Processing Monitor to review processing statistics for off-cycle calendars.

Updating Processing Monitor Data

The system updates the data presented in the Processing Monitor during absence and payroll calculation batch processing. You can disable the portion of the batch process that updates the Processing Monitor by deselecting the Update Processing Monitor check box on the Debug and Tuning Options page.

This is an example of the Debug and Tuning Options page.

Debug and Performance Controls ×

Calculate Absence and Payroll

Debug and Tuning Options

Run Control ID 11

Calendar Group ID GXRTUSA1 199912

Performance Tuning ?

Update Statistics

Debugging ?

Suppress Bulk Insert
 No Trace
 Log SQL Time
 Trace All Elements
 Trace Elements in Error

Cobol Trace Parameters ?

Cobol Log Level

No Cobol Trace
 Summary
 Detail

You can also update Processing Monitor data for a specific calendar group using the Update Processing Monitor Data page.

Related Links

[Debug and Tuning Options Page](#)

[Update Processing Monitor Data page](#)

Prerequisites for Processing Monitor Configuration

To include absence accumulator information in the Summary portion of the Processing Monitor, you must:

1. Create element groups. The element groups you create determine which absence accumulators the system displays in the Summary portion of the Processing Monitor. When defining element groups for the Processing Monitor, follow these guidelines:

- On the [Element Group Members Page](#), select *Applications* in the **Element Group Use** field.
- When adding members on the Element Group Members page, make sure to select only members with an **Element Type** of *Accumulator*.

Note: Segment accumulators are the type of accumulators supported by the Processing Monitor feature.

- On the Element Group Members page, the sort order you enter in the **Application Default Sort Seq** (application default sort sequence) column determines the order in which each element link appears, from left to right, for each element group in the Summary portion of the Processing Monitor.
 - Make sure that the description for each element group members is unique.
 - Do not add more than four accumulators to an element group.
 - Ensure that all of the accumulators that you add to the element groups are included in a section of your process list.
2. Create an application using the [Define Application Page](#). An application is required to create an element list set.
 3. Use the [Define List Set Page](#) to create an element list set that contains the element groups you created to use with the Processing Monitor.

Note: Do not add more than four element groups to the element list set.

Note: It is not necessary to create an element list to view gross and net pay using the Processing Monitor.

Related Links

[Setting Up Sections](#)

[Setting Up Process Lists](#)

Monitor Configuration Page

Use the Monitor Configuration page (GP_CS_INSTALL) to configure the Processing Monitor.

Navigation:

Set Up HCM > Product Related > Global Payroll & Absence Mgmt > System Settings > Monitor Configuration

This example illustrates the fields and controls on the Monitor Configuration page.

Monitor Configuration

Country CYM Cayman Islands Refresh

Absence Management

Element List Set

Element List Personalize | Find | View All | [Print] | [Grid] | First 1-2 of 2 Last

| Element Group Name | Description | *Order |
|--------------------|-------------|--------------------------------|
| K0WRC_GRP_SICK | Sick Time | <input type="text" value="1"/> |
| K0WRC_GRP_UNP | Vacations | <input type="text" value="2"/> |

Payroll System

*Payroll System

Alert Icons

*Error Icon Name

*Warning Icon Name

Success Icon Name

Status Key Threshold Definitions Personalize | Find | View All | [Print] | [Grid] | First 1-3 of 3 Last

| Pay Group | *Status Monitor Key | *Error Percent Threshold | Warning Percent Threshold |
|--------------------------------|---|---------------------------------|---------------------------------|
| <input type="text" value="1"/> | <input type="text" value="Sel Stat - Cancelled"/> | <input type="text" value="7"/> | <input type="text" value="3"/> |
| <input type="text" value="2"/> | <input type="text" value="Sel Stat - Suspended by User"/> | <input type="text" value="20"/> | <input type="text" value="10"/> |
| <input type="text" value="3"/> | <input type="text" value="Calc Stat - Frozen"/> | <input type="text" value="10"/> | <input type="text" value="5"/> |

Results Threshold Definition Personalize | Find | View All | [Print] | [Grid] | First 1-5 of 8 Last

| Pay Group | *Accumulator Key | *Error Percent Threshold | Warning Percent Threshold |
|--------------------------------|---|---------------------------------|---------------------------------|
| <input type="text" value="1"/> | <input type="text" value="Gross Pay"/> | <input type="text" value="20"/> | <input type="text" value="15"/> |
| <input type="text" value="2"/> | <input type="text" value="Net Pay"/> | <input type="text" value="20"/> | <input type="text" value="15"/> |
| <input type="text" value="3"/> | <input type="text" value="Tax Gross"/> | <input type="text" value="15"/> | <input type="text" value="10"/> |
| <input type="text" value="4"/> | <input type="text" value="Sick Leave Balance"/> | <input type="text" value="15"/> | <input type="text" value="10"/> |
| <input type="text" value="5"/> | <input type="text" value="Sick Leave Taken"/> | <input type="text" value="15"/> | <input type="text" value="10"/> |

| Field or Control | Description |
|------------------|---|
| Refresh | Whenever you make a change to the list set selected in the Element List Set field or to any of the element groups it includes, you must click the Refresh button on this page to update the Monitor Configuration page. When you click this button, the system removes any obsolete values from both the Element List and Results Threshold Definition grids and refreshes the page. In addition, it resets the sort order of the Element List grid. |

Note: If you install a new language for your system after setting up the processing monitor configuration, you must access the Monitor Configuration page and click Save to make the configuration apply to the new language.

Absence Management

| <i>Field or Control</i> | <i>Description</i> |
|---------------------------|---|
| Element List Set | <p>Select the element list set that determines which absence accumulators are displayed in the Summary portion of the Processing Monitor for absence calculations. The system displays the element groups associated with the element list set in the Element List grid.</p> <p>This field is not required. If you leave it blank, the Summary portion of Processing Monitor doesn't display any absence information.</p> <hr/> <p>Note: The element list set that you select must contain no more than four element groups. If you select an element list that contains more than four element groups, you will receive an error.</p> <hr/> |
| Element Group Name | Lists the name of each element group associated with the selected element list set. |
| Description | Lists the description of each element group associated with the selected element list set. These descriptions appear on the tabs in the Summary portion of the Processing Monitor for absence calculations. |
| Order | Enter a number for each element group. This determines the order in which the tabs appear in the Summary portion of the Processing Monitor for absence calculations. |

Payroll System and Retro Definitions

| Field or Control | Description |
|-------------------------|---|
| Payroll System | <p>Select which type of payroll system you are using. Values are:</p> <ul style="list-style-type: none"> <i>Global Payroll</i>: Select if PeopleSoft Global Payroll is your payroll system. <i>Other</i>: Select if you use a payroll system other than PeopleSoft Global Payroll. <hr/> <p>Note: If you select <i>Other</i>, you will not be able to view gross and net pay calculation results using the Processing Monitor.</p> <hr/> |

Alert Icons

| Field or Control | Description |
|--------------------------|---|
| Error Icon Name | Enter the name of the icon that the system displays in the Alerts Icon columns of the Processing Monitor when an error is generated. By default this field is populated with the delivered error icon, PS_GP_PROC_ERR_ICN. |
| Warning Icon Name | Enter the name of the icon that the system displays in the Alerts Icon columns of the Processing Monitor when a warning is generated. By default this field is populated with the delivered warning icon, PS_GP_PROC_WRN_ICN. |
| Success Icon Name | Enter the name of the icon that the system displays in the Alerts Icon columns of the Processing Monitor for successful payroll or absence calculations. By default this field is populated with the delivered success icon, PS_GP_PROC_OK_ICN. |

Status Key Threshold Definitions

Use this grid to define the thresholds that trigger the system to display errors and warnings in the Counts sections of the Processing Monitor.

| Field or Control | Description |
|----------------------------------|--|
| Pay Group | Define the pay group to which the status key threshold definition applies. If you leave this field blank, the status key threshold definition applies to all pay groups. |
| Status Monitor Key | Select the type of status to which the threshold definition applies. |
| Error Percent Threshold | Enter a percentage. When the percentage of calculations with the status defined in the Status Monitor Key field is equal to or greater than the number you enter in this field, the system displays the Error icon in the Alert column for that status in the Counts portion of the Processing Monitor. |
| Warning Percent Threshold | Enter a percentage. When the percentage of calculations with the status defined in the Status Monitor Key field is equal to or greater than the number you enter in this field, the system displays the Warning icon in the Alert column for that status in the Counts portion of the Processing Monitor. |

Results Threshold Definitions

Use this grid to define the thresholds that trigger the system to display errors and warnings in the Summary section of the Processing Monitor.

| Field or Control | Description |
|--------------------------------|---|
| Pay Group | Define the pay group to which the results threshold definition applies. If you leave this field blank, the results threshold definition applies to all pay groups. |
| Accumulator Key | Select the accumulator to which the threshold definition applies. The valid values are <i>Gross Pay</i> , <i>Net Pay</i> , and the accumulators associated with the value you selected in the Element List Set field. |
| Error Percent Threshold | Enter a percentage. For the accumulator defined in the Accumulator Key field, when the value of the Percent Difference column in the Summary portion of the Processing Monitor is equal to or greater than the number you enter in this field, the system displays the Error icon in the Alerts Icon column. |

| <i>Field or Control</i> | <i>Description</i> |
|----------------------------------|---|
| Warning Percent Threshold | Enter a percentage. For the accumulator defined in the Accumulator Key field, when the value of the Percent Difference column in the Summary portion of the Processing Monitor is equal to or greater than the number you enter in this field, but less than the number in the Error Percent Threshold field, the system displays the Warning icon in the Alerts Icon column. |

Using the Processing Monitor

Pages Used to Use the Processing Monitor

| <i>Page Name</i> | <i>Definition Name</i> | <i>Usage</i> |
|---|--------------------------|--|
| Update Processing Monitor Data page | GP_CS_POP_RCNTL | Update Processing Monitor data for a calendar group. |
| Global Payroll Process Monitor Tile | HC_GP_WC_PROC_MON_FL_GBL | Access the Processing Monitor - By Calendar Group page. |
| Processing Monitor - By Calendar Group Page | GP_CS_STAT1 | View detailed processing statistics for calendar groups. |
| Processing Monitor - By Calendar Page | GP_CS_STAT2 | View detailed processing statistics for calendars. |

Understanding the Processing Monitor

The Processing Monitor component provides a comprehensive set of processing statistics along with graphical representations of those statistics. The statistical information displayed on this page includes:

- Counts by selection, calculation, and segment status. This information is further broken down by the Absence and Payroll calculation types.
- Summarized gross pay and net pay results for payroll calculations.
- Summarized accumulator results for absence calculations.

The Processing Monitor presents this information by calendar group and by individual calendar.

Note: You cannot use the Processing Monitor to review processing statistics for off-cycle calendars.

Updating Processing Monitor Data

The system updates the data presented in the Processing Monitor during absence and payroll calculation batch processing. You can disable the portion of the batch process that updates the Processing Monitor by deselecting the Update Processing Monitor check box on the Debug and Tuning Options page.

This is an example of the Debug and Tuning Options page.

The screenshot shows a window titled "Debug and Performance Controls" with a close button (x) in the top right corner. The main content area is titled "Calculate Absence and Payroll" and "Debug and Tuning Options". It displays the following information:

- Run Control ID: 11
- Calendar Group ID: GXRTUSA1 199912
- Performance Tuning** (with a help icon):
 - Update Statistics
- Debugging** (with a help icon):
 - Suppress Bulk Insert
 - No Trace
 - Trace All Elements
 - Log SQL Time
 - Trace Elements in Error
- Cobol Trace Parameters** (with a help icon):
 - Cobol Log Level**:
 - No Cobol Trace
 - Summary
 - Detail

You can also update Processing Monitor data for a specific calendar group using the Update Processing Monitor Data page.

Related Links

[Debug and Tuning Options Page](#)

[Update Processing Monitor Data page](#)

Update Processing Monitor Data page

Use the Update Processing Monitor Data page (GP_CS_POP_RCNTL) to update Processing Monitor data for a calendar group.

Note: This is a secondary process for updating Processing Monitor data. Typically, the system updates Processing Monitor data during absence and payroll calculation batch processing.

Navigation:

Global Payroll & Absence Mgmt > Absence and Payroll Processing > Update Processing Monitor Data

This example illustrates the fields and controls on the Update Processing Monitor Data page.

Select a **Calendar Group ID** and click the **Run** button. The Update Processing Monitor Data (GP_CS_POP_ST) application engine program updates the Processing Monitor data for the selected calendar group.

Note: If you update the Processing Monitor as part of the absence and payroll calculation batch process, you do not need to update it using the Update Processing Monitor Data process. For more information, see the documentation for the [Debug and Tuning Options Page](#).

Global Payroll Process Monitor Tile

Use the Global Payroll Process Monitor tile (HC_GP_WC_PROC_MON_FL_GBL) to access the Processing Monitor - By Calendar Group page.

Navigation:

You can add the delivered Global Payroll Process Monitor tile to your fluid home pages.

This example illustrates the Global Payroll Process Monitor tile.



Click the tile to access the page in the classic user interface.

Processing Monitor - By Calendar Group Page

Use the Processing Monitor - By Calendar Group page (GP_CS_STAT1) to view detailed processing statistics for calendar groups.

Navigation:

Global Payroll & Absence Mgmt > Absence and Payroll Processing > Review Absence/Payroll Info > Processing Monitor

This example illustrates the fields and controls on the Processing Monitor - By Calendar Group page (1 of 2).

By Calendar Group | By Calendar

Calendar Group ID KO 2012M07 KO 2012M07

Counts by Selection Status



Active

| Statistics by Selection Status | | | | |
|--------------------------------|---------------------|-------|---------|------------|
| Selection Status | Calculation Type | Count | Percent | Alert Icon |
| 1 Active | Payroll Calculation | 9 | 100.000 | |
| 2 Active | Absence Calculation | 9 | 100.000 | |

Counts by Calculation Status



Finalized

| Statistics by Calculation Status | | | | |
|----------------------------------|---------------------|-------|---------|------------|
| Calculation Status | Calculation Type | Count | Percent | Alert Icon |
| 1 Finalized | Absence Calculation | 9 | 100.000 | |
| 2 Finalized | Payroll Calculation | 9 | 100.000 | |

Counts by Segment Status



Active in Segment

| Statistics by Segment Status | | | | |
|------------------------------|---------------------|-------|---------|------------|
| Segment Status | Calculation Type | Count | Percent | Alert Icon |
| 1 Active in Segment | Absence Calculation | 9 | 100.000 | |
| 2 Active in Segment | Payroll Calculation | 9 | 100.000 | |

This example illustrates the fields and controls on the Processing Monitor - By Calendar Group page (2 of 2).

Summary

Payroll Calculation
 Absence Calculation

Gross Pay | Net Pay

Gross Pay Results Personalize | Find | [?] | [X]

| Pay Group | Calendar ID | Actions | Previous Calendar ID | Current Value | Previous Value | Value Difference | Percent Difference | Alert Icon |
|-----------|----------------------|-----------|----------------------|---------------|----------------|------------------|--------------------|------------|
| 1 K0PGA | KO 2012M07 PAYREG | ▼ Actions | KO 2012M06 PAYREG | 29275.360000 | 29852.360000 | -577.000000 | 1.932846 | ✓ |

Note: The Processing Monitor displays results from the first version (V1) and revision (R1) in the case of retroactive processing.

For more information on retroactive processing, see [Understanding General Rules of Retroactive Processing](#).

Counts by Selection Status

This section of the page includes a Statistics by Selection Status grid that presents processing statistics organized by **Selection Status** and **Calculation Type**. For each combination of selection status and calculation type that exists, the grid displays a row that includes a **Count**, a **Percent**, and an **Alert** if applicable.

To the left of the Statistics by Selection Status grid, the Counts by Selection Status section includes a pie chart that provides a graphical representation of the processing statistics presented in the grid.

Counts by Calculation Status

This section of the page includes a Statistics by Calculation Status grid that presents processing statistics organized by **Calculation Status** and **Calculation Type**. For each combination of calculation status and calculation type that exists, the grid displays a row that includes a **Count**, a **Percent**, and an **Alert** if applicable.

To the left of the Statistics by Calculation Status grid, the Counts by Calculation Status section includes a pie chart that provides a graphical representation of the processing statistics presented in the grid.

Counts by Segment Status

This section of the page includes a Statistics by Segment Status grid that presents processing statistics organized by **Segment Status** and **Calculation Type**. For each combination of segment status and calculation type that exists, the grid displays a row that includes a **Count**, a **Percent**, and an **Alert** if applicable.

To the left of the Statistics by Calculation Status grid, the Counts by Calculation Status section includes a pie chart that provides a graphical representation of the processing statistics presented in the grid.

Note: For the Counts by Selection Status, Counts by Calculation Status, and Counts by Segment Status sections, you determine what triggers this page to display alert icons by defining status key threshold definitions on the [Monitor Configuration Page](#).

Summary

This section displays a summary of payroll and absence calculation results.

Note: The Payroll Calculation and Absence Calculation options appear in this section only if you select a value in the **Element List Set** field of the [Monitor Configuration Page](#). If no element list set is selected, this section displays only payroll calculation results. Additionally, if you select *Other* as the **Payroll System** on the Monitor Configuration page, this section does not display any payroll calculation results.

| Field or Control | Description |
|----------------------------|--|
| Payroll Calculation | Select this option to display a summary of payroll calculation results in the Summary section of the page. When you select this option, the page displays two tabs of payroll calculations results: Gross Pay and Net Pay. |
| Absence Calculation | Select this option to display a summary of absence calculation results in the Summary section of the page. When you select this option, the page displays a tab for each element group associated with the element list set that you selected on the Monitor Configuration page. For each element group tab, the system displays a link for each absence accumulator that is a member of that element group. |

This example illustrates the Summary section of the Processing Monitor - By Calendar Group page with the Absence Calculation option selected.

Summary

Payroll Calculation
 Absence Calculation

[Sick Leave Balance](#) | [Sick Leave Entitlement](#) | [Sick Leave Taken](#) | [Sick Leave Adjusted](#)

Accumulator Results Personalize | Find |

| Pay Group | Calendar ID | Actions | Previous Calendar ID | Current Value | Previous Value | Value Difference | Percent Difference | Alert Icon |
|-----------|----------------------|-----------|----------------------|---------------|----------------|------------------|--------------------|------------|
| 1 K0PGA | K0 2012M07 ABSREG | ▼ Actions | K0 2012M06 ABSREG | 82.000000 | 120.000000 | -38.000000 | 31.666667 | |

For gross pay, net pay, and each absence accumulator, the grid displays a row for each pay group.

| Field or Control | Description |
|-----------------------------|---|
| Actions | <p>Click to access links to additional information for the row. Available actions are:</p> <ul style="list-style-type: none"> • <i>View Administrator Results:</i> Select to access the Summary page of the Administrator Results component for a specific payee. • <i>View Calendar Group Results:</i> Select to access the Calendar Group Results page for a specific payee. • <i>View Payee Status:</i> Select to access the Payee Status page. • <i>View Payee Iterative List:</i> Select to access the Payee Iterative List page. • <i>View Payee Messages:</i> Select to access the Payee Messages page. • <i>View Department ID Analysis:</i> Select to access the View Department ID Analysis pivot grid. |
| Previous Calendar ID | <p>Select the previous calendar to which you want to compare your current results. By default, the system populates this field with the calendar that immediately precedes the current calendar. Only finalized calendars associated with the respective pay group are available to select in this field.</p> |
| Current Value | <p>Displays the current calendar's value for gross pay, net pay, or an absence accumulator.</p> |
| Previous Value | <p>Displays the previous calendar's value for gross pay, net pay, or an absence accumulator.</p> |
| Value Difference | <p>Displays the difference between the current value and previous value for gross pay, net pay, or an absence accumulator.</p> |
| Percent Difference | <p>Displays the percentage of difference between the current value and previous value for gross pay, net pay, or an absence accumulator.</p> |
| Alert Icon | <p>Displays the appropriate alert icon based on the value of the Percent Difference field.</p> <hr/> <p>Note: You determine which icons correspond to which percentages of difference by defining results threshold definitions on the Monitor Configuration Page.</p> <hr/> |

Department ID Analysis Pivot Grid

When you click the **Action** link in the Summary portion of the Processing Monitor, select *View Department ID Analysis* to access the View Department ID Analysis pivot grid.

This example illustrates the fields and controls on the View Department ID Analysis page.

| | Current Value (Sum) | Previous Value (...) | Value Difference... |
|-------|---------------------|----------------------|---------------------|
| All | 82.000000 | 120.000000 | -38.000000 |
| 11000 | 50.000000 | 80.000000 | -30.000000 |
| 11100 | 16.000000 | 24.000000 | -8.000000 |
| 13000 | 16.000000 | 16.000000 | 0.000000 |

When fully expanded, this pivot grid shows the current value and value difference for the gross pay, net pay, or absence accumulator for each department associated with a specific pay group and calendar ID.

| Field or Control | Description |
|-------------------------|--|
| | Click the Options Menu button and select <i>Prompts</i> to select a different previous period for the department ID analysis. |
| Employee ID | Select the employees for which you want to filter the department details. You can click and drag this field to the column listing the departments to view the Current Value and Value Difference by employee for each department. |
| Current Value | Displays the current value for gross pay, net pay, or an absence accumulator. You can click on a link in this column to access the Pivot Grid Drilldown page where you can view payee-specific details. |

| Field or Control | Description |
|-------------------------|--|
| Previous Value | Displays the previous value for gross pay, net pay, or an absence accumulator. You can click on a link in this column to access the Pivot Grid Drilldown page where you can view payee-specific details. |
| Value Difference | Displays the value difference for gross pay, net pay, or an absence accumulator. You can click on a link in this column to access the Pivot Grid Drilldown page where you can view payee-specific details. |

This example illustrates the fields and controls on the Pivot Grid Drilldown page.

The screenshot shows a window titled "Pivot Grid Drilldown" with a "Detailed Data" tab. The table contains the following data:

| Department ID | Actions | Employee ID | Employee Record | Name | Calendar Group | Pay Group | Current Calendar ID | Previous Calendar ID | Element Name | Current Value | Previous Value | Value Difference | Percent Difference |
|---------------|---------|-------------|-----------------|-----------------|----------------|-----------|---------------------|----------------------|--------------------|---------------|----------------|------------------|--------------------|
| 1 11000 | Actions | K0G001 | 0 | Rebekah Jones | K0 2012M07 | K0PGA | K0 2012M07 ABSREG | K0 2012M06 ABSREG | Sick Leave Balance | 8.000000 | 24.000000 | -16.000000 | 66.666666 |
| 2 11000 | Actions | K0G008 | 0 | Clare Justin | K0 2012M07 | K0PGA | K0 2012M07 ABSREG | K0 2012M06 ABSREG | Sick Leave Balance | 18.000000 | 32.000000 | -14.000000 | 43.750000 |
| 3 11000 | Actions | K0G010 | 0 | Debroah Bickham | K0 2012M07 | K0PGA | K0 2012M07 ABSREG | K0 2012M06 ABSREG | Sick Leave Balance | 8.000000 | 8.000000 | 0.000000 | 0.000000 |
| 4 11000 | Actions | K0G007 | 0 | Marilyn Drake | K0 2012M07 | K0PGA | K0 2012M07 ABSREG | K0 2012M06 ABSREG | Sick Leave Balance | 8.000000 | 8.000000 | 0.000000 | 0.000000 |
| 5 11000 | Actions | K0G006 | 0 | Leo Puddephatt | K0 2012M07 | K0PGA | K0 2012M07 ABSREG | K0 2012M06 ABSREG | Sick Leave Balance | 8.000000 | 8.000000 | 0.000000 | 0.000000 |

A "Return" button is located at the bottom left of the window.

| Field or Control | Description |
|-------------------------|---|
| Actions | Click to access the View Employee Results link that you can use to access the Results by Calendar - Calendar Results page for the employee. |

For more information on pivot grids, see the product documentation for *PeopleTools: Pivot Grid*.

Processing Monitor - By Calendar Page

Use the Processing Monitor - By Calendar page (GP_CS_STAT2) to view detailed processing statistics for calendars.

Navigation:

Global Payroll & Absence Mgmt > Absence and Payroll Processing > Review Absence/Payroll Info > Processing Monitor > By Calendar

This example illustrates the fields and controls on the Processing Monitor - By Calendar (1 of 2).

By Calendar Group | **By Calendar**

Calendar Group ID K0 2012M05 K0 2012M05

Calendar Details

Calendar ID K0 2012M05 ABSREG Pay Group K0PGA

Counts by Selection Status



Active

| Statistics by Selection Status | | | |
|--------------------------------|-------|---------|------------|
| Selection Status | Count | Percent | Alert Icon |
| 1 Active | 9 | 100.000 | |

Counts by Calculation Status



Finalized

| Statistics by Calculation Status | | | |
|----------------------------------|-------|---------|------------|
| Calculation Status | Count | Percent | Alert Icon |
| 1 Finalized | 9 | 100.000 | |

Counts by Segment Status



Active in Segment



| Statistics by Segment Status | | | |
|------------------------------|-------|---------|------------|
| Segment Status | Count | Percent | Alert Icon |
| 1 Active in Segment | 9 | 100.000 | |

This example illustrates the fields and controls on the Processing Monitor - By Calendar (2 of 2).

Summary

Payroll Calculation
 Absence Calculation

Gross Pay | Net Pay

Gross Pay Results Personalize | Find |  | 

| Pay Group | Calendar ID | Actions | Previous Calendar ID | Current Value | Previous Value | Value Difference | Percent Difference | Alert Icon |
|-----------|----------------------|-----------|----------------------|---------------|----------------|------------------|--------------------|---|
| 1 K0PGA | K0 2012M05 ABSREG | ▼ Actions | K0 2012M04 ABSREG | 0.000000 | 0.000000 | 0.000000 | 0.000000 |  |

The fields on this page are identical to those on the Processing Monitor - By Calendar Group Page.

Defining Administrator Absence Results

Page Used to Define Administrator Absence Results

| <i>Page Name</i> | <i>Definition Name</i> | <i>Usage</i> |
|--|------------------------|---|
| <u>Define Administrator Results Page</u> | GP_RSLT_ADM_SETUP | Set up country options and link a list set to a PeopleSoft role for the Payee Detail group box on the Summary page. |

Prerequisites

List sets maintain the framework for Administrator Absence Results. A list set and application definition are delivered as system data. This definition is used to assign attributes to list sets and element groups. List sets are used to determine which elements appear on the page (through element groups defined for the set). These attributes will control the Administrator Absence Results component and the information displayed in the component. Therefore, you can set up many different list sets for different types of views of the data.

List sets provide the ability to address the following requirements:

- Determine which inquiry pages should be available or hidden.
- Specify which list set should appear in an list set area on a page.
- Either accept the defaulted title or override it.
- Specify lists of elements such as absences, accumulators, and supporting elements.
- Define a set of elements to be viewed in the inquiry pages.
- Compose attributes of the elements to be viewed.

See [Understanding Applications and List Sets](#).

Also, you have to determine what elements can be viewed by someone in a particular PeopleSoft role, such as an Absence Administrator or a Benefits Administrator. For example, your Absence Administrator may be able to view all elements, while your Benefits Administrator may only have access to the benefit elements.

See *PeopleTools 8.52: Security Administration, Setting Up Roles*

Define Administrator Results Page

Use the Define Administrator Results page (GP_RSLT_ADM_SETUP) to set up country options and link a list set to a PeopleSoft role for the Payee Detail group box on the Summary page.

Navigation:

Set Up HCM > Product Related > Global Payroll & Absence Mgmt > System Settings > Define Administrator Results > Define Administrator Results

This example illustrates the fields and controls on the Define Administrator Results page.

Roles

Enter the role name you want associated with the list set.

See *PeopleTools 8.52: Security Administration, Setting Up Roles*

Payee Detail Fields

| Field or Control | Description |
|-------------------------|--|
| Field Type | Enter the field type for the value you want displayed in the Payee Details section of the Summary page. Valid values are <i>Payment Key</i> and <i>Absence/Payroll Results</i> . |
| Payment Key | If <i>Payment Key</i> is selected for the Field Type enter payment key number you want displayed. |
| Entry Type | If <i>Absence/Payroll Results</i> is selected for the Field Type enter the entry type. Values are <i>System Element – Character</i> and <i>Variable – Character</i> . |
| Element Name | If <i>Absence/Payroll Results</i> is selected for the Field Type enter the element name for the entry type selected. |

Field Label

| Field or Control | Description |
|---------------------------|---|
| Label Type | <p>Select a label for the Field Type selected. Different fields will be able to be edited based on the Label Type selected.</p> <p>If the Field Type is <i>Payment Key</i>, the valid values are <i>Message Catalog</i> or <i>Text</i>.</p> <p>If the Field Type is <i>Absence/Payroll Results</i>, the valid values are <i>Element Description</i>, <i>Element Name</i>, <i>Message Catalog</i>, or <i>Text</i>.</p> |
| Label Text | <p>If the Label Type selected is <i>Text</i> enter the text you want to use for the label. This will display on the Summary page – Payee Details group box.</p> |
| Message Set Number | <p>If the Label Type selected is <i>Message Catalog</i> select the message set number to be displayed on the Summary page – Payee Details group box.</p> |
| Message Number | <p>If the Label Type selected is <i>Message Catalog</i> select the message number to be displayed on the Summary page – Payee Details group box.</p> |

Field Description

The fields in this section are used to retrieve the description of a field from the record indicated.

| Field or Control | Description |
|----------------------------|---|
| Record (Table) Name | <p>Enter the name of the record to retrieve a field description from if you want the field description on the Summary page – Payee Details group box.</p> |
| Field Name | <p>Enter the field name which has the description that you want displayed on the Summary page – Payee Details group box. Only character fields are allowed.</p> |
| SetID Controlled | <p>If the record selected is controlled by a SetID, the field will automatically be selected.</p> |

Viewing Administrator Absence Results

Pages Used to View Administrator Absence Results

| <i>Page Name</i> | <i>Definition Name</i> | <i>Usage</i> |
|---|------------------------|--|
| <u>Summary Page</u> | GP_RSLT_ADM_SUMM | View payee information by segment. |
| <u>Administrator Results - Supporting Elements Page</u> | GP_RSLT_ADM_SOVR | View information about supporting elements used to calculate entitlements and takes for a payee. |
| Administrator Results - Earnings and Deductions Page | GP_RSLT_ADM_ED | This page does not apply to Absence Management. No information will appear on this page. |
| <u>Administrator Results - Accumulators Page</u> | GP_RSLT_ADM_ACUM | View accumulator amounts. |
| <u>Administrator Results - Absences Page</u> | GP_RSLT_ADM_ABS | View absence daily data, generated positive input, and accumulators that are processed for the absence calendar. |

Understanding Administrator Absence Results

Administrator Absence Results inquiry pages are used for viewing absence results configured by the user. They provide the ability to view the following types of information after absences have been calculated:

- Summary information detailing payee and segment information.
- Supporting elements used in the absence calculation such as variables and accumulators.
- Accumulators.
- Absences.

Application definitions, list sets, and role-based settings on the Define Administrator Results component all contribute to the appearance of the Administrator Results component. For example, the settings in the List Set Attributes group box on the Define List Set page control what pages of the component appear. This is just one of many ways that list sets contribute to the appearance of the Administrator Results component.

This diagram presents an overview of this relationship.

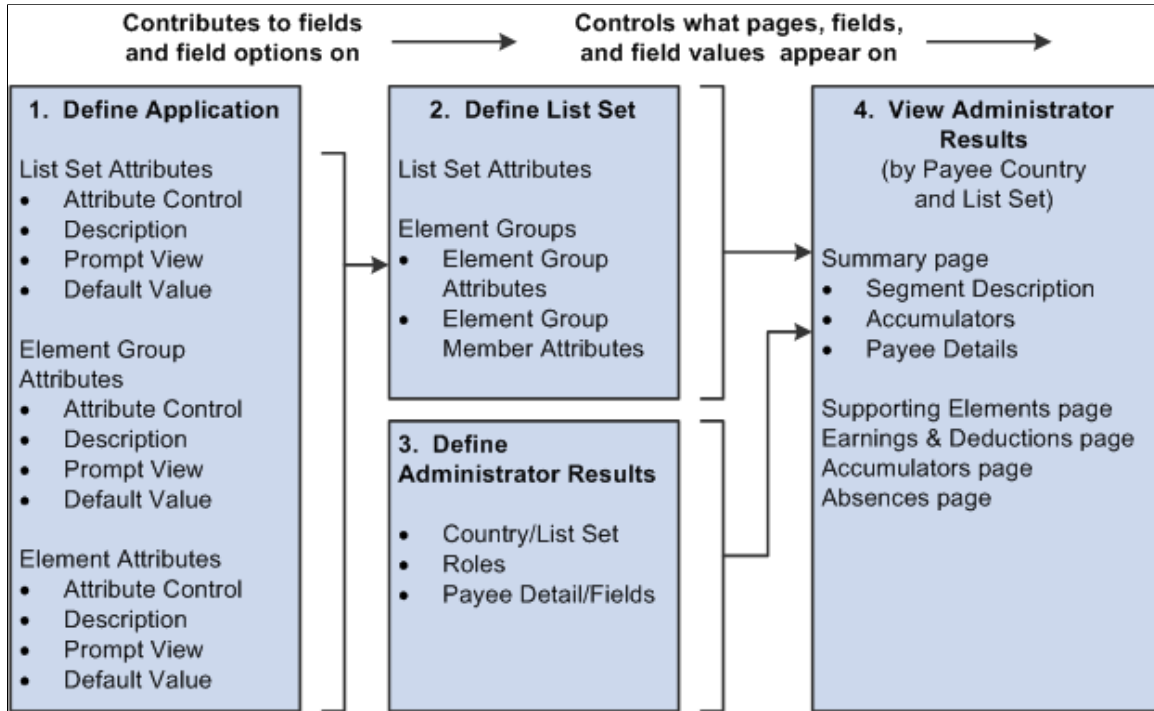

Note: PeopleSoft delivers an application of RSLT_ADM with a country of *ALL*, designed to work in conjunction with the Administrator Results component. You should not modify this delivered application. Link this application with a list set of your choosing, and use it to control the appearance of the Administrator Results component.

Summary Page

Use the Summary page (GP_RSLT_ADM_SUMM) to view payee information by segment.

Navigation:

Global Payroll & Absence Mgmt > Absence and Payroll Processing > Review Absence/Payroll Info > Administrator Results > Summary

This example illustrates the fields and controls on the Summary page.

| Summary | Supporting Elements | Earnings and Deductions | Accumulators | Absences | | | | | | | | | | | | | | | | | | | | | | | | | | | | | | | | | | | | | | | | | | | | | | | | | | | | | | | |
|---|---------------------|-------------------------|---------------|---------------------|---------------------|--------------|--|-------------|---------------------|-------------|---------|--------------|--|--|---|--|--|--|--|-------------------------------|--|--|--|--|--|--|--|--|--|-------------------------|--|--|--|--|--|--|--|--|--|--------------------|----------|--------------|--|--|-----------------|----------|--------------|--|--|----------------------|----------|-------------|--|--|---------------|----------|--------------|--|--|
| Fabio Fabiano Employee | | Empl ID G1GPERF03 | Empl Record 0 | | | | | | | | | | | | | | | | | | | | | | | | | | | | | | | | | | | | | | | | | | | | | | | | | | | | | | | | |
| Calendar Group ID G1_GRP_PERF_JUN04 | | List Set RSLT_ADM | | | | | | | | | | | | | | | | | | | | | | | | | | | | | | | | | | | | | | | | | | | | | | | | | | | | | | | | | |
| Segment Information Find First 1 of 2 Last | | | | | | | | | | | | | | | | | | | | | | | | | | | | | | | | | | | | | | | | | | | | | | | | | | | | | | | | | | | |
| <table border="1"> <thead> <tr> <th>Segment Description</th> <th colspan="2">Gross to Net</th> <th>Personalize</th> <th>First 1-4 of 4 Last</th> </tr> <tr> <th>Description</th> <th>Current</th> <th>Year to Date</th> <th></th> <th></th> </tr> </thead> <tbody> <tr> <td>Begin Date 06/01/2004 End Date 06/30/2004</td> <td></td> <td></td> <td></td> <td></td> </tr> <tr> <td>Calendar ID G1_PERF_JUN04_ABS</td> <td></td> <td></td> <td></td> <td></td> </tr> <tr> <td>Pay Group K1GPERFPG Performance Test Pay Group</td> <td></td> <td></td> <td></td> <td></td> </tr> <tr> <td>Payment Date 06/30/2004</td> <td></td> <td></td> <td></td> <td></td> </tr> <tr> <td>Calc Time 08/09/2004 3:40PM Calc Status Finalized - With Banking</td> <td></td> <td></td> <td></td> <td></td> </tr> <tr> <td>Total Earnings YTD</td> <td>0.000000</td> <td>38274.900000</td> <td></td> <td></td> </tr> <tr> <td>Total Taxes YTD</td> <td>0.000000</td> <td>12730.550000</td> <td></td> <td></td> </tr> <tr> <td>Total Deductions YTD</td> <td>0.000000</td> <td>1140.000000</td> <td></td> <td></td> </tr> <tr> <td>Total Net YTD</td> <td>0.000000</td> <td>24404.350000</td> <td></td> <td></td> </tr> </tbody> </table> | | | | | Segment Description | Gross to Net | | Personalize | First 1-4 of 4 Last | Description | Current | Year to Date | | | Begin Date 06/01/2004 End Date 06/30/2004 | | | | | Calendar ID G1_PERF_JUN04_ABS | | | | | Pay Group K1GPERFPG Performance Test Pay Group | | | | | Payment Date 06/30/2004 | | | | | Calc Time 08/09/2004 3:40PM Calc Status Finalized - With Banking | | | | | Total Earnings YTD | 0.000000 | 38274.900000 | | | Total Taxes YTD | 0.000000 | 12730.550000 | | | Total Deductions YTD | 0.000000 | 1140.000000 | | | Total Net YTD | 0.000000 | 24404.350000 | | |
| Segment Description | Gross to Net | | Personalize | First 1-4 of 4 Last | | | | | | | | | | | | | | | | | | | | | | | | | | | | | | | | | | | | | | | | | | | | | | | | | | | | | | | |
| Description | Current | Year to Date | | | | | | | | | | | | | | | | | | | | | | | | | | | | | | | | | | | | | | | | | | | | | | | | | | | | | | | | | |
| Begin Date 06/01/2004 End Date 06/30/2004 | | | | | | | | | | | | | | | | | | | | | | | | | | | | | | | | | | | | | | | | | | | | | | | | | | | | | | | | | | | |
| Calendar ID G1_PERF_JUN04_ABS | | | | | | | | | | | | | | | | | | | | | | | | | | | | | | | | | | | | | | | | | | | | | | | | | | | | | | | | | | | |
| Pay Group K1GPERFPG Performance Test Pay Group | | | | | | | | | | | | | | | | | | | | | | | | | | | | | | | | | | | | | | | | | | | | | | | | | | | | | | | | | | | |
| Payment Date 06/30/2004 | | | | | | | | | | | | | | | | | | | | | | | | | | | | | | | | | | | | | | | | | | | | | | | | | | | | | | | | | | | |
| Calc Time 08/09/2004 3:40PM Calc Status Finalized - With Banking | | | | | | | | | | | | | | | | | | | | | | | | | | | | | | | | | | | | | | | | | | | | | | | | | | | | | | | | | | | |
| Total Earnings YTD | 0.000000 | 38274.900000 | | | | | | | | | | | | | | | | | | | | | | | | | | | | | | | | | | | | | | | | | | | | | | | | | | | | | | | | | |
| Total Taxes YTD | 0.000000 | 12730.550000 | | | | | | | | | | | | | | | | | | | | | | | | | | | | | | | | | | | | | | | | | | | | | | | | | | | | | | | | | |
| Total Deductions YTD | 0.000000 | 1140.000000 | | | | | | | | | | | | | | | | | | | | | | | | | | | | | | | | | | | | | | | | | | | | | | | | | | | | | | | | | |
| Total Net YTD | 0.000000 | 24404.350000 | | | | | | | | | | | | | | | | | | | | | | | | | | | | | | | | | | | | | | | | | | | | | | | | | | | | | | | | | |
| Payee Details Personalize Find View All First 1 of 1 Last | | | | | | | | | | | | | | | | | | | | | | | | | | | | | | | | | | | | | | | | | | | | | | | | | | | | | | | | | | | |
| Field | Value | Description | | | | | | | | | | | | | | | | | | | | | | | | | | | | | | | | | | | | | | | | | | | | | | | | | | | | | | | | | |
| Company | K1G | GP US Company G | | | | | | | | | | | | | | | | | | | | | | | | | | | | | | | | | | | | | | | | | | | | | | | | | | | | | | | | | |

Note: The appearance of this page is controlled by List Sets and Role based security. Depending on a user's role, and the user's role association with a given list set, different values will appear.

See [Understanding Applications and List Sets](#).

See *PeopleTools: Security Administration*.

Segment Description

This area displays information pertaining to the payee's segment, regardless of list set setting. The segment begin date, segment end date, calendar, pay group, currency, calculation date and time, and the calculation status are displayed in this group box.

Payee Details

This area displays information that is stored in the absence result tables that relate to a payee's segment. The title and contents of this area are configured by country and are specified through the Payee Detail Fields group box settings on the Define Administrator Results page.

If segmentation occurs the value displayed will be that of the last slice.

Accumulators

This area displays segment and year to date accumulators that relate to a payee's segment. The title and content of this area are configured by country and are specified in an list set from an list set.

Administrator Results - Supporting Elements Page

Use the Administrator Results - Supporting Elements page (GP_RSLT_ADM_SOVR) to view information about supporting elements used to calculate entitlements and takes for a payee.

Navigation:

Global Payroll & Absence Mgmt > Absence and Payroll Processing > Review Absence/Payroll Info > Administrator Results > Supporting Elements

This example illustrates the fields and controls on the Supporting Elements page.

This page displays supporting elements that have been defined in an list set.

Selection Criteria

This group box is available on most of the inquiry pages. Unless selection criteria is entered, all elements applicable in the list set defined in the setup will be displayed. Any selection criterion entered will filter the elements on the current inquiry page but it does not filter the information on any of the other inquiry pages.

If multiple criteria are entered, elements must match all criteria specified in order to be displayed.

| Field or Control | Description |
|-------------------------|---|
| Category | Select the name of the category of elements to filter. These categories are from the Category table. See Defining Industries and Categories . |
| Amounts | Select the type of amount you want to display. Choices are <i>Negative Amounts</i> and <i>Positive Amounts</i> . Leave the Amount field blank to return all amounts. Note: Zero amounts will only display when you select no amount in the Amount field, as these are neither positive nor negative. |

Administrator Results - Accumulators Page

Use the Administrator Results - Accumulators page (GP_RSLT_ADM_ACUM) to view accumulator amounts.

Navigation:

Global Payroll & Absence Mgmt > Absence and Payroll Processing > Review Absence/Payroll Info > Administrator Results > Accumulators

This example illustrates the fields and controls on the Accumulators page.

The screenshot displays the 'Accumulators' page for employee Fabio Fabiano. It includes tabs for Summary, Supporting Elements, Earnings and Deductions, Accumulators, and Absences. The employee's details are: Employee Fabio Fabiano, Empl ID G1GPERF03, Empl Record 0, Calendar Group ID G1_GRP_PERF_JUN04, and List Set RSLT_ADM. The Selection Criteria section has dropdowns for Category and Amount, with buttons for 'Select with Matching Criteria' and 'Clear Criteria'. The Segment Information section shows Begin Date 06/01/2004, End Date 06/30/2004, and Calendar ID G1_PERF_JUN04_ABS. The Accumulators section has a table with columns: Period, Element Name, Description, Amount, From Date, and Through Date. The table shows one row with an amount of 0.000000.

This page displays accumulators that have been defined in a list set.

Administrator Results - Absences Page

Use the Administrator Results - Absences page (GP_RSLT_ADM_ABS) to view absence daily data, generated positive input, and accumulators that are processed for the absence calendar.

Navigation:

Global Payroll & Absence Mgmt > Absence and Payroll Processing > Review Absence/Payroll Info > Administrator Results > Absences

This example illustrates the fields and controls on the Absences page.

Summary
Supporting Elements
Earnings and Deductions
Accumulators
Absences

Fabio Fabiano Employee

Calendar Group ID G1_GRP_PERF_JUN04

Empl ID G1GPERF03 Empl Record 0

List Set RSLT_ADM

Selection Criteria

Category

Amount

Select with Matching Criteria

Clear Criteria

Segment Information Find First 1 of 2 Last

Begin Date 06/01/2004 End Date 06/30/2004 Calendar ID G1_PERF_JUN04_ABS

▼ **Absence Data** Personalize | Find | View All | First 1-3 of 3 Last

Results
Period
Entitlement Balances

| Absence Take Element | Description | Element Type | Day Count | Day Count Paid | Absence Begin Date | Absence End Date | Absence Date |
|----------------------|-------------|--------------|-----------|----------------|--------------------|------------------|--------------|
| SICK TAKE | Sick | AT | 8.000000 | 6.000000 | 06/23/2004 | 06/25/2004 | 06/25/2004 |
| SICK TAKE | Sick | AT | 8.000000 | 8.000000 | 06/23/2004 | 06/25/2004 | 06/24/2004 |
| SICK TAKE | Sick | AT | 8.000000 | 8.000000 | 06/23/2004 | 06/25/2004 | 06/23/2004 |

▼ **Generate Positive Input Member List** Personalize | Find | View All | First 1 of 1 Last

| Begin Date | End Date | Absence Take Element | Description | Percent | Unit |
|------------|----------|----------------------|-------------|---------|------|
| | | | | | |

▼ **Accumulators** Personalize | Find | View All | First 1-4 of 4 Last

Results
User Keys
Period

| Accumulator Period | Element Name | Description | Element Type | From Date | Through Date | Calc Result Value |
|--------------------|----------------|-------------|--------------|------------|--------------|-------------------|
| Year to Date | VAC PAID_YTDA | Vacation | AC | 01/01/2004 | 12/31/2004 | 353.306768 |
| Year to Date | VACATION_BAL | Vacation | AC | 01/01/2004 | 12/31/2004 | 0.000000 |
| Year to Date | SICK PAID_YTDA | Sick | AC | 01/01/2004 | 12/31/2004 | 1059.920304 |
| Year to Date | SICK_BAL | Sick | AC | 01/01/2004 | 12/31/2004 | 0.000000 |

This page displays three list set areas that display absence information. These lists areas include absence daily data, generated positive input, and accumulators. Each element displayed is defined in an list set.

Viewing an Element Resolution Chain

When you run absence calculations, you can generate an element resolution chain that shows, by payee, how and in what order each element was resolved and how long it took to resolve each element on the process list. This can be helpful if your absences are taking a long time to calculate, and you're doing some performance tuning on your rule definitions. Because significant system resources are required to produce an element resolution chain, we recommend that you use this feature for problem solving only.

Copyright © 1988, 2024, Oracle and/or its affiliates.

767

Pages Used to View the Element Resolution Chain

| Page Name | Definition Name | Usage |
|---|------------------------|--|
| Element Resolution Chain Page | GP_AUDIT_CHAIN | View elements that were resolved for a payee during processing. Select <i>Trace All Elements</i> or <i>Trace Elements in Error</i> on the Payroll/Absence Run Control page. |
| Detail Audit Chain Page | GP_AUDIT_DTL_SEC | View the order in which each element was resolved and the numeric, character, or date value to which the element resolved. |

Element Resolution Chain Page

Use the Element Resolution Chain page (GP_AUDIT_CHAIN) to view elements that were resolved for a payee during processing.

Select Trace All Elements or Trace Elements in Error on the Payroll/Absence Run Control page.

Navigation:

Global Payroll & Absence Mgmt > Absence and Payroll Processing > Review Absence/Payroll Info > Element Resolution Chain > Element Resolution Chain

| Field or Control | Description |
|---------------------------------------|---|
| Begin Date and End Date | Displays the begin and end dates of the calendar in which the element was processed. |
| Element Name | Click to access the Detail Audit Chain page where you can view the order in which the element resolved. |

Resolution Time

| Field or Control | Description |
|-------------------------|---|
| Seconds | The number of seconds taken to resolve the element. An asterisk (*) indicates that resolution took less than one second. |
| Invalid Trace | Selected if the system could not trace the element's resolution, due to a programming error, a corrupted table, or other problem. |

Slice Dates

Displays the begin date and end date of the slice in which the element resolved.

Additional Info

| <i>Field or Control</i> | <i>Description</i> |
|------------------------------|---|
| Pointer Value | Displays the PIN number to which the pointer element identified in the Name field resolved. Applies only to elements with a field format of <i>Pointer</i> . |
| Adjustment | Displays the amount of the calculated adjustment for the element, such as a retroactive adjustment. Applies only to elements with a field format of <i>Decimal</i> or <i>Monetary</i> . |
| Calculation Raw Value | Displays the amount before rounding if the element was rounded during processing. Applies only to elements with a field format of <i>Decimal</i> or <i>Monetary</i> . |

Related Links

[Understanding Data Retrieval Elements](#)

Detail Audit Chain Page

Use the Detail Audit Chain page (GP_AUDIT_DTL_SEC) to view the order in which each element was resolved and the numeric, character, or date value to which the element resolved.

Navigation:

Click the link of the element name to view the Detail Audit Chain for that element.

The **Order** field shows the order of resolution.

Correcting Batch Processing and Data Entry Errors

Page Used to Create the Payee Messages Report

| <i>Page Name</i> | <i>Definition Name</i> | <i>Usage</i> |
|---------------------------------------|------------------------|--|
| Payroll Messages Page | GP_GPSQR04_PNL | Run the Messages Report (GP000004) SQR process to identify payees who may need further editing to make it through finalization of the payroll. |

Understanding Batch Processing Errors

When an error occurs during batch processing, the system assigns one of the following calculation statuses to the absence:

- Error

The error occurred as the amount was being calculated. For example, the batch process could not find an appropriate effective-dated row for an element definition.

- Bypassed

The system did not attempt to calculate the payee because of an error. For example, the system could not find the payee's job row.

- Error - User

An error condition defined by your organization was met. For example, a formula element that generates an error message when a payee's results reach a specified maximum amount.

Each time you run the Calculate phase, you can review the Processing Statistics page for the number of calculations in error. You can also review the Payee Messages page for warnings or messages generated for each error. After fixing problems that caused errors, run the Calculate phase again. The system tries to recalculate the payee.

While the inquiry pages provide the level of detail that you need to resolve most errors, sometimes you might need more help. If you're having problems resolving errors for a few payees, you can generate an element resolution chain for only those people.

To generate a resolution chain:

1. On the Payee Status page, set the process indicator to *Recalculate*.
2. On the Calculate Absence and Payroll page, select the **Calculate** check box and select *Trace Elements in Error* as the Trace option.
3. Start the job.

Important! You cannot finalize an absence run with errors. If you can't resolve all errors before completing the absence run, cancel the absences that are in error and process them later in a supplemental run.

Understanding Batch Processing Messages

Batch messages in Absence Management fall into two categories:

- Messages 1 to 300.

Informational messages and messages that identify process terminating errors. These messages appear in the process log and inform you of the progress of the process or report critical errors that cause the process to terminate.

- Messages 301 and higher.

Warnings and errors of lesser severity that allow processing to continue even though they might set one or more segments (payments) in error for the payee that is identified on the Payee Messages page.

With a few exceptions, these messages report problems that caused the resolution of an element or a segment to be bypassed, and identify the affected payee. You can view these messages on the Payee Messages page.

These two categories of batch processing error messages apply to the delivered Message Set 17005 and to any Message Sets created by the customer.

Message Set number 17005 is the core application batch for Absence Management. Some of the key messages in that set are described below.

You can review batch processing messages on the Payee Messages page, or through the Payee Message Report. This report provides the ability to identify payees who may need further editing to make it through finalization of the absence run. It provides the same selection logic as is available online.

| Message Number | Message / Explanation |
|-----------------------|---|
| 3 | <p>Internal array overflow occurred for array %1 defined in copybook %2 with a max array count of %3</p> <p>COBOL does not offer an efficient way to dynamically allocate space for data, so we must define a predetermined number of rows in all arrays into which we read data. This message is issued when the process retrieves more data from the database than it can fit into the program's storage. The message identifies what storage area is exceeded, in what copy book the area is defined, and the limit of the area.</p> <p>To proceed, you must have a system administrator or system programmer expand the area to a reasonable number, recompile the Absence Management COBOL application, and rerun your process.</p> <p>Sample message:</p> <pre>GPPDPDM1: XB000 Internal array overflow occurred for array %1 defined in copybook %2 with a max array count of %3 L-PMT-DATA GPCDPDM.CBL 20</pre> <p>Sample Resolution: Go to the copybook in question, where you will find the setup shown below.</p> <pre>05 L-PMT-COUNT PIC 9999 VA=> LUE 0 COMP. 88 L-PMT-COUNT-MAX VA=> LUE 50. 05 L-PREV-PMT-PTR PIC 9999 VA=> LUE 0 COMP. 05 L-ORIG-PMT-COUNT PIC 9999 VA=> LUE 0 COMP. 05 L-PMT-DATA OC=> CURS 50 INDEX=> ED BY PMT-IDX.</pre> <p>Increase the number in the OCCURS clause and the VALUE for L-PMT-COUNT-MAX, keeping the two numbers in sync. This array contains one row for each segment that is being processed for a payee in a calendar group. It includes a single history row and any retro segments, as well as the number of segments in the current period for all employee record</p> |

| Message Number | Message / Explanation |
|-----------------------|---|
| | <p>numbers that are being processed (if the payee has multiple jobs).</p> |
| <p>301</p> | <p>Element %1 of parent element %2 on process List %3 is not found in %4. (PIN number %5)</p> <p>This error is issued by an element resolution program when the program cannot find an entry for the element in one of the key attribute arrays (UPINT or UPINA). It identifies the element component, its parent (%2), and the process list being processed (%3). It tells you that it could not find the entry in UPINT or in UPINA (%4) and what the PIN number of the element is (%5).</p> <p>This error can occur if the parent is set up to use an element that is defined as specific to a country other than the country for which the current calendar group is running.</p> <p>Resolution: Inspect the parent element (or the sections of the process list, if the element reported in error is directly on the process list). Modify the element dependencies or remove the element from the process list, as appropriate.</p> <p>Also see messages 314 and 315.</p> |
| <p>302</p> | <p>The definition for element %1 (parent element %2, process list element %3) is inactive as of %4</p> <p>On the Payee Messages page, the %n placeholders are substituted for the element names. The message is issued if the process encounters a request to resolve an element that was set to inactive on or before the date on which its resolution was requested (%4). The parent element (%2) is the element that is directly dependent on this element. The process list element (%3) shows the element on the process list that is dependent on both the element in error and its parent.</p> <p>In more complex setups, there may be multiple layers of elements between the parent and the element on the process list. If the error occurs for the process list entry itself, all three will show the same element name.</p> <p>Resolution: Review the definition of the element in error and assess whether the element should be inactivated. If so, modify the definition of the parent element to no longer depend on this element for resolution. If the element in error is directly on the process list (that is, in a section of a process list), remove it from that section.</p> |

| Message Number | Message / Explanation |
|-----------------------|---|
| 314 | <p>Element %1 has an invalid PIN (%2). Valid range is 1 through %3. PIN not loaded</p> <p>This message is issued as elements or element rule definitions are loaded. It identifies an element with a PIN number that is outside the valid range of PIN numbers (1 through 300,000). The upward limit is the array size of the UPINT array in GPCUPINT.</p> <p>Resolution: If the PIN number (%2) is 0, something is wrong with the setup of one of your rules. A PIN number that is greater than 300,000 indicates that your rule set is getting large. Consult your system administrator or application developer to expand the UPINT array.</p> |
| 315 | <p>Element %1 (PIN %2) - and data for the element - not loaded into the process. (N/A for country: %3)</p> <p>This message is issued during the loading of elements or element rule definitions. It differs from message 314 in that the PIN number is valid, but the element for which the process is attempting to load data is specific to a country that is different from the country that is associated with your current process (%3).</p> <p>Resolution: Review your rule setup, focusing on any modifications or additions to the rules that have been made since the last successful run.</p> |

Payroll Messages Page

Use the Payroll Messages page (GP_GPSQR04_PNL) to run the Messages Report (GP000004) SQR process to identify payees who may need further editing to make it through finalization of the payroll.

Navigation:

Global Payroll & Absence Management > Absence and Payroll Processing > Reports > Payroll Messages > Payroll Messages

This example illustrates the fields and controls on the Payroll Messages page.

Payroll Messages

Run Control ID PS Report Manager

Language English ▼

*Calendar Group ID

Process Monitor

Country

Run

Selection Criteria

Empl ID From

Pay Group

Group List ID

Message Set

Message Severity ▼

Empl ID To

Calendar ID

Calculation Status ▼

Message Number

| <i>Field or Control</i> | <i>Description</i> |
|----------------------------------|---|
| Calendar Group ID | The calendar group to process. |
| EmplID From and EmplID To | Range of payees to process. Do not enter an EmplID To value without also entering and EmplID From value. |
| Pay Group | The pay group to process. |
| Calendar ID | The calendar to process. |
| Group List ID | Payees currently assigned to the group list ID will be processed. |
| Calculation Status | Calculation status to process. |
| Message Set | A specific message set can be selected, and the system will report only those messages in Absence Management. |
| Message Number | This field is available if you select a message set. Enter any valid message number. |
| Message Severity | Select <i>Error</i> or <i>Warning</i> to exclude informational messages and process terminating errors (message numbers under 300) from the report. |

Finalizing an Absence Run

When you finalize an absence run, no further changes can be made. Only after you finalize a run can the calendars in a calendar group be picked up for retroactive processing in subsequent runs of other calendar groups.

You finalize an entire run at the end of an absence cycle, after you've resolved all errors and made all adjustments. When you run the Finalize phase, the system:

- Sets the calculation status of each absence to Finalize.
- Deletes all warnings, error messages, element resolution chains, processed retro triggers, and iterative triggers, including unprocessed, iterative triggers. (Positive input, segmentation triggers, and unprocessed retro triggers are not deleted.)
- Inserts a timestamp that you can view on the Calendar Group page.
- Marks the calendar group ID Finalized and clears the Open indicator.

Important! The Finalize phase cannot be reversed.

To finalize an absence run:

1. Ensure that the following requirements are met.

The batch process aborts if any of the following conditions are not met. To see which conditions were not met, check the Log File.

| Requirement | Where to Check |
|---|--|
| No absences are in Error or Identified status. | Processing Statistics pages for the calendar group ID. |
| No payees are Suspended by User or Suspended by System. | Processing Statistics pages for the calendar group ID. |
| All streams have been calculated, if stream processing is activated for the calendar group. | Processing Statistics pages. If you are unsure of the stream numbers, check the Stream Setup page. |
| All process indicators are set to Normal. | Payee Status page. |

Because the system deletes all iterative triggers, you may want to look at the Review Iterative Triggers page to see if there are unprocessed triggers that you need to address in a separate run.

2. Access the Calculate Absence and Payroll page for the same run control ID and select the **Finalize** check box.
3. Review the Processing Statistic pages for the calendar group ID and make sure that the *Finalized* and *Totals* figures match.

Canceling an Absence Run

This topic discusses how to:

- Cancel an entire absence run.
- Cancel an individual payee.

You can cancel an entire absence run (the entire calendar group ID) or you can cancel individual payees from a calendar group ID. For each canceled payee, the system deletes all calculations, sets the selection status to *Cancelled*, and deletes the Calculation status. It also deletes all error messages, warnings, and audit records, if you requested an element resolution chain.

Canceled payees are ignored during future iterations of processing, including retroactive runs, unless you manually *uncancel* them or run the Identify phase again—if you've canceled an entire run.

Canceling an Entire Absence Run

You rarely need to cancel an entire absence run. However, if you discover a problem that affects most or all payees, canceling the run may be the most efficient way to address the problem. For example, if you attach the wrong process list to a calendar or if you add calendars to the calendar group ID in the wrong order, it might be quicker to cancel the run, make the corrections, and run the Identify step again than to correct each payee individually.

To cancel a pay run, you select the **Cancel** check box on the Calculate Absence and Payroll page.

Canceling Individual Payees

To cancel an individual payee, set the process indicator for the payee to *Cancel*.

Uncanceling a payee creates an iterative trigger during the next processing run. During the next iteration of the Calculate phase, the system deletes and reidentifies the payee. If the identification process determines that the payee still meets the selection criteria, that payee is included in the run. Otherwise, the payee is canceled again.

Processing Special Situations

This topic discusses how to:

- Process payees in two open calendar groups.
- Run off-cycle calendar runs.

Processing Payees in Two Open Calendar Groups

If a payee is on more than one open calendar run, the payee is selected and processed in the first calendar group ID in which that payee is picked up. When the system processes the second calendar group ID, it puts the payee in an error status. To process that payee in the second calendar group ID, do one of the following:

- Finalize the first calendar group ID and then run the second calendar group ID.

- Suspend the payee in the first calendar group ID and recalculate the first calendar group ID (to invoke the suspend action). Rerun and finalize the second calendar group ID. Recalculate the first calendar group ID. This might be appropriate, for example, if the payee changes pay groups mid-period and the calendars for the previous and current pay groups are linked to different calendar group.

Running Off-Cycle Calendar Runs

Sometimes you need to run off-cycle absence calculations. For example, you may need to run absence calculations soon after a payee has been terminated. Instructions for performing off-cycle processing are covered elsewhere in this book.

Related Links

[Understanding Off-Cycle Processing](#)

Reporting Absence Data

Page Used to Report Absence Data

| <i>Page Name</i> | <i>Definition Name</i> | <i>Usage</i> |
|---|------------------------|--|
| Absence Results Register Page | GP_GPSQR01_PNL | Create a report containing individual results of a absence calculations. |

Absence Results Register Page

Use the Absence Results Register page (GP_GPSQR01_PNL) to create a report containing individual results of a absence calculations.

Navigation:

Global Payroll & Absence Mgmt > Absence and Payroll Processing > Reports > Absence Results Register

This example illustrates the fields and controls on the Absence Results Register page.

The screenshot shows the 'Absence Results Register' page interface. At the top, there are three tabs: 'Run Control ID PS', 'Report Manager', and 'Process Monitor'. A 'Run' button is located to the right of these tabs. Below the tabs, there is a 'Language' dropdown menu set to 'English'. A search field for '*Calendar Group' is present with a magnifying glass icon. At the bottom, there are two panels: 'Generate Report For' with radio buttons for 'Entire Calendar Group' (selected), 'Selected Pay Groups', and 'Selected Payees'; and 'Order Payees By' with radio buttons for 'Employee ID' (selected) and 'Name'.

| <i>Field or Control</i> | <i>Description</i> |
|--------------------------------|---|
| Language | Determines the language that is used during translations and the formatting for dates and numbers. |
| Calendar Group | Select the calendar group ID of the absence run for which you want to generate a report. |
| Generate Report For | Select the result set for this report. The options are: <ul style="list-style-type: none">• Entire Calendar Group• Selected pay groups• Selected Payees |
| Order Payees By | Select to sort payees by employee ID or name. |

Using the PeopleSoft Fluid User Interface to Work with Absences

Using the PeopleSoft Fluid User Interface to Work with Absences as an Employee

Employees can use the PeopleSoft Fluid User Interface to request absences, view absence requests, and view absence balances.

Click the Time tile on the Employee Self Service home page to access a list of PeopleSoft Time and Labor, and PeopleSoft Absence Management self-service tasks. The tasks listed are based on the applications that are installed and on the security access of the logged in user.

This topic describes the PeopleSoft Absence Management tasks that you access using the **Time** tile. For more information on the PeopleSoft Time and Labor tasks, see “Using PeopleSoft Fluid User Interface for Time Reporting as an Employee” (PeopleSoft Time and Labor)

Video: [Image Highlights, PeopleSoft HCM Update Image 43: Absence Balance and Forecast Enhancements](#)

Related Links

“Understanding PeopleSoft Fluid User Interface Homepages” (Application Fundamentals)

“Using the Employee Self-Service Homepage” (Application Fundamentals)

Pages Used to Work with Absences as an Employee Using the PeopleSoft Fluid User Interface

| <i>Page Name</i> | <i>Definition Name</i> | <i>Usage</i> |
|--------------------------------------|--|---|
| Time Tile | HC_TL_START_NAV_FLU_ESS2_GBL (this is the cref for the tile) | Access the PeopleSoft Time and Labor, and PeopleSoft Absence Management self-service pages. |
| Time Home Page | HC_TL_EMP_DSHBD_FL_LINK | Access employee self-service absence transactions. |
| Manage Absences Tile | HC_HGA_SS_REQ_FLU_GBL | Access Request Absence page. |
| Manage Absences Page | HGA_SS_REQ_FLU | Enter self-service absence requests. |

| <i>Page Name</i> | <i>Definition Name</i> | <i>Usage</i> |
|--|-------------------------------|--|
| <u>Cancel Absences Tile</u> | HC_HGA_SS_REQCAN_FLU_GBL | Access Cancel Absences page. |
| <u>Cancel Absences Page</u> | HGA_SS_REQ_FLU | Cancel an absence request. |
| <u>View Requests Tile</u> | HC_HGA_SS_REQHIST_FLU_GBL | Access View Requests page. |
| <u>View Requests Page</u> | HGA_SS_REQHIST_FLU | View your absence requests. |
| <u>Absence Details Page</u> | HGA_SS_REQ_FLU | View details of your absence requests. |
| <u>Absence Balances Tile</u> | HC_HGA_SS_BAL_FLU_GBL | Select to access Absence Balances page. |
| <u>Balances Page</u> | HGA_SS_BAL_FLU | View your current absence balances. |
| <u>Extended Absence Request Tile</u> | HGA_EA_REQ_LND_FL | Access the Extended Absence Request page. |
| <u>Extended Absence Request Page</u> | HGA_EA_REQ_INIT | View and create extended absence requests. |
| <u>Extended Absence Request Activity Guide</u> | HGA_EA_REQ_FLU | Create an extended absence request using the activity guide. |

Time Tile

Use the Time tile to access the fluid Time pages.

Navigation:

The Time tile is delivered as part of the Employee Self Service home page, but the location can change if you change the delivered home pages or if administrators personalize their home pages.

As an employee, you can add the tile, through personalization, to a system-delivered home page or a home page that you create.

This example illustrates the Time tile.

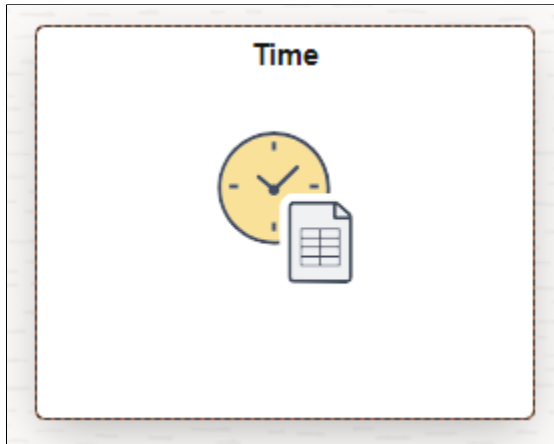

Select the Time tile to access these employee self-service absence transactions easily without using traditional menu navigations:

- Manage Absences
- Cancel Absences
- View Requests
- Absence Balances
- Extended Absence Request

Time Home Page

Use the Time (HC_TL_EMP_DSHBD_FL_LINK) home page to access the PeopleSoft Absence Management pages.

Navigation:

The Time tile is delivered as part of the Employee Self Service home page, but the location can change if you change the delivered home pages or if administrators personalize their home pages.

As an employee, you can add the tile, through personalization, to a system-delivered home page or a home page that you create.

Select Time Tile to access the actionable tiles.

The following video provides an overview of the Absence Actionable Tiles.

Video: [Image Highlights, PeopleSoft HCM Update Image 29: Redefine Employee Navigation for Time and Labor and Absence Transactions](#)

This example illustrates the Time home page.

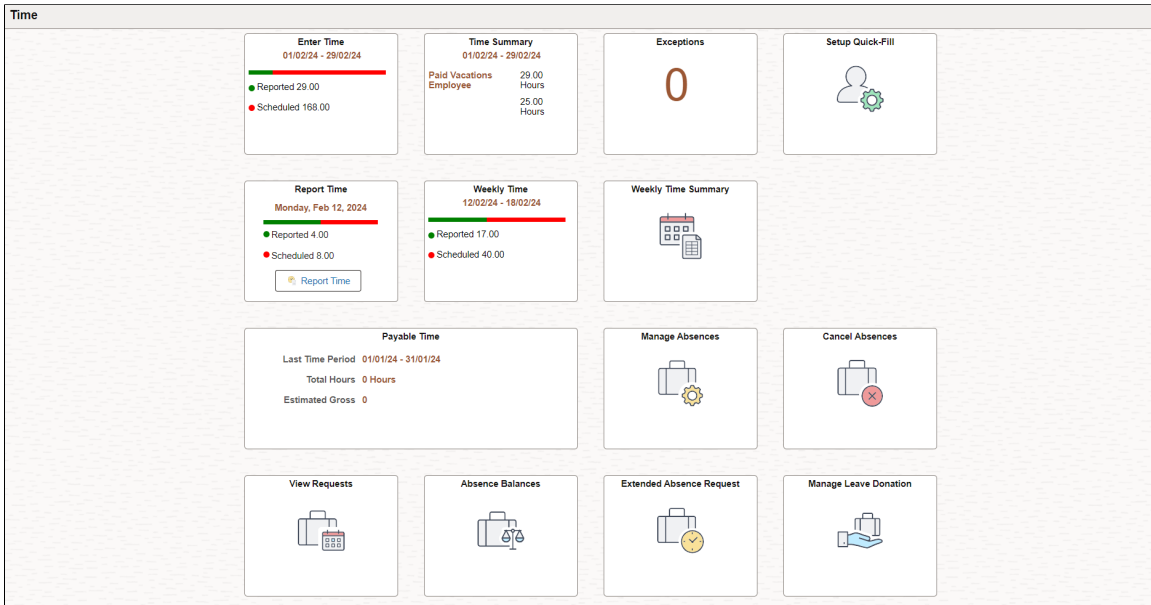

Manage Absences Tile

Use the Manage Absences (HC_HGA_SS_REQ_FLU_GBL) tile to access the [Manage Absences Page](#).

Navigation:

Employee Self Service > Time

This example illustrates the fields and controls on the Manage Absences Tile.

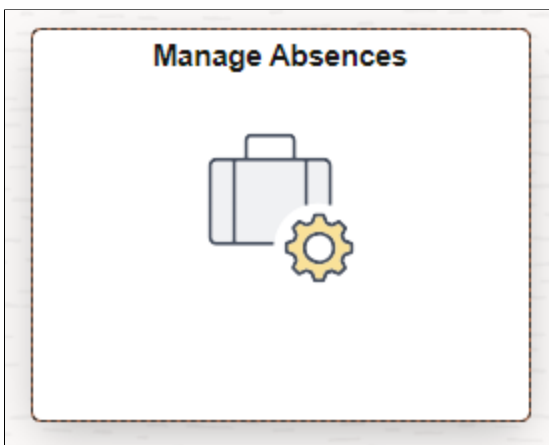

Manage Absences Page

Use the Manage Absences page (HGA_SS_REQ_FLU) to enter self-service absence requests.

Navigation:

Employee Self Service > Time > Manage Absences

This example illustrates the fields and controls on the Manage Absence page when user selects Apply Absence.

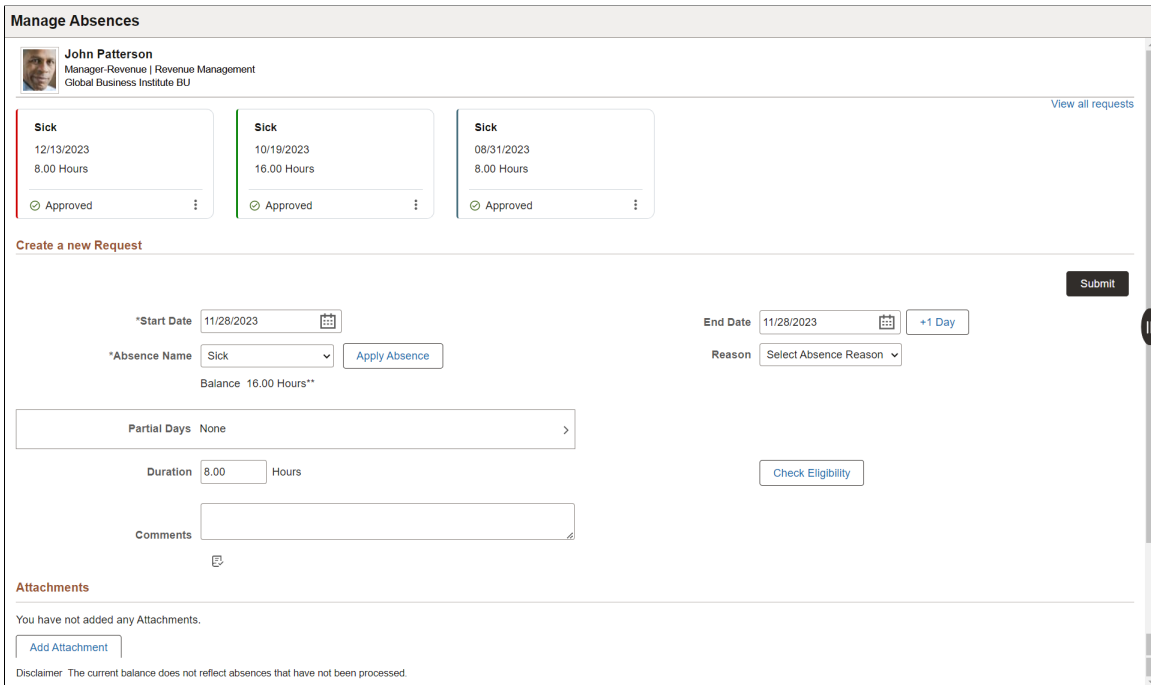

This example illustrates the Manage Absences page in screen reader mode.

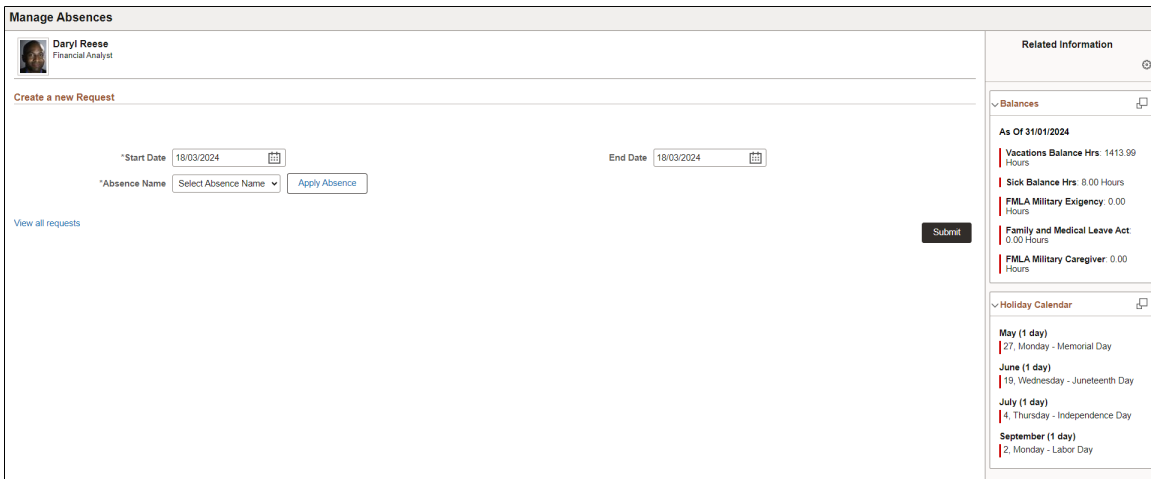

| Field or Control | Description |
|-------------------------|--|
| Employee Header | <p>Displays the employee details such as name and role along with employee photo. To configure the employee header data, see “(Fluid) Managing Employee Headers” (Application Fundamentals).</p> <p>For employees with multiple active jobs, the Select Another Job link is displayed, You can switch between them as required.</p> |

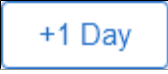
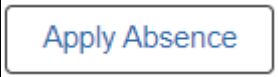
| Field or Control | Description |
|---|---|
| Absence Cards | <p>Displays the recent absence requests. The card includes the Absence name, start date, duration and status of the request. The related actions allows user to open the View Absence and Cancel Absence pages. The page displays the three most recent absence requests, sorted chronologically based on the submission date.</p> <hr/> <p>Note: In screen reader mode, the Manage Absences page does not display the absence cards. To view the absence requests, select View all requests link. In small form factor, the cards are displayed under the Manage Requests tab.</p> <hr/> |
| View all requests | Select to open the View Requests Page . |
| Start Date | <p>Select the first day of the absence event. The field option defaults to the current date. If there's a break in the absence, enter each event separately. For example, if you're out sick for two days, return to work for three days, and are out sick again, enter two absence events. If the absence includes a weekend (say, Thursday to Monday), enter one absence event.</p> <p>On the small form factor date, selectors are available in the Request Absence tab.</p> |
| End Date | Select the last day of the absence event. |
|  | Enables users to add absence end date by one increment. |
| Absence Name | Select the type of absence you want to request. |
|  | Select to view and update the details for your absence request. Additional fields such as <i>Partial Days</i> , <i>Duration</i> , and <i>Comments</i> are displayed. |
| Balance | Displays the hours available. |
| Reason | <p>Select a reason from the available options. Absence reasons are linked to the Absence Name (Take) through the Absence Take Type.</p> <p>See Defining Absence Types and Reasons.</p> |
| Partial Days | Select to open the Partial Days modal and enter the partial days information for your absence request. |

| Field or Control | Description |
|---|---|
| Duration | Displays the hours of your absence based on the Start Date and End Date. |
| Comments | Enter comments for your request. |
|  | Spell check the text entered in <i>Comments</i> . |
| Check Eligibility | Select to check if you are eligible to apply the absence. |
| Add Attachment | Select to add attachment for your absence request. |
| Submit | Select to submit the absence request. |
| Related Information | <p>The related information panel shows the Balances and Holiday Calendar.</p> <p>Administrators can add or remove the analytics using configuration.</p> <p>By default, the Holiday Calendar is configured to show holidays in the next six months.</p> <p>Use the Display Holiday Calendar in Modal Window to select a different period.</p> |

Partial Days Page

Select **Partial Days** in the absence request page to access the Partial Days modal window and enter the partial day information for your absence request.

This example illustrates the fields and controls on the Partial Days page.

Cancel

Partial Days

Done

Partial Days Start and End Days ▾

Start Date 01/04/2024

Start Day is Half Day Yes

Begin Time 10:00 AM 🕒

End Time 02:00 PM

End Date 02/04/2024

End Day Is Half Day Yes

Begin Time 08:00 AM 🕒

End Time 12:00 PM

| Field or Control | Description |
|--------------------------------|---|
| Partial Days | Specify which days of the absence event are partial days. Available options are: <ul style="list-style-type: none"> • <i>All Days</i> • <i>End Day Only</i> • <i>None</i> • <i>Start Day Only</i> • <i>Start and End Days</i> |
| Start Date and End Date | Displays the start and end date entered on the Manage Absence page. |

| Field or Control | Description |
|--|--|
| <p>All Days are Half Days, Start Day is Half Day, and End Day is Half Day</p> | <p>These fields are displayed based on the selection for the <i>Partial Days</i> field. Select <i>Yes</i> or <i>No</i> to indicate which days of the absence event are half days.</p> <hr/> <p>Important! These fields are not available unless the Country Take enables you to specify partial days on the Manage Absences page. To configure the display of partial days, see Configure Country Take Setup - Absences Page.</p> |
| <p>Begin Time and End Time</p> | <p>Enter the start and end time for the partial day. You can also select the time using the time picker. The End Time is calculated and displayed automatically based on the begin time and the unit type, and is non editable. If the duration is days, then the end time is calculated based on the begin time and work schedule. If the duration is hours, then the end time is calculated based on begin time and duration. See Configure Country Take Setup - Absences Page.</p> <hr/> <p>Note: These fields are displayed only if the employee indicates that one or more of the days are partial days. These fields are informational only and are not mandatory.</p> |

Check Eligibility

Select **Check Eligibility** to see if you are eligible for the absence request based on the values entered.

When you click the link, a pop up appears displaying the eligibility status.

Eligibility Result Page

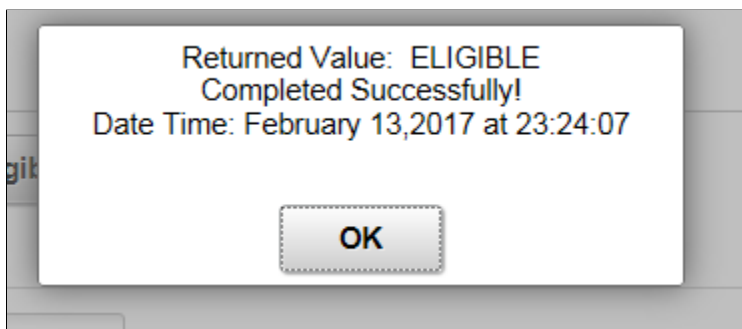

Note: When the current absences submitted by employees are taken, a message 'Eligibility has changed for some of the existing Absence Request. Please click on View Eligibility Details to know the current status.' is displayed.

View Eligibility Details

On checking the eligibility, **View Eligibility Details** link appears on the screen. Select the link to view the absence eligibility details of the selected employee.

This example illustrates the fields and controls on the Eligibility Details page.

Eligibility Details

×

| | | |
|--|--------|---|
| Sick Entitlement Hrs 01/01/2023 - 12/31/2023 | 96.00 | > |
| Sick Take Hrs 01/01/2023 - 12/31/2023 | 96.00 | > |
| Sick Balance Hrs 01/01/2023 - 12/31/2023 | 0.00 | > |
| Vacations Taken Hrs 01/01/2023 - 12/31/2023 | 16.00 | > |
| Vacations Balance Hrs 01/01/2023 - 12/31/2023 | 600.00 | > |

Eligibility for the following Absences has changed due to latest eligibility check. Please go to View Requests to see more details.

Absence Requests 2 rows

| | Absence Name | Begin Date | End Date | Eligibility Value |
|---|--------------|------------|------------|-------------------|
| 1 | Sick | 12/13/2023 | 12/13/2023 | Ineligible |

Select row to view the configured user keys corresponding to each entitlement.

Eligibility Details Sub Page



Note: To view these details at-least one user key should be configured. If not, the link appears as disabled.

Additional Information

Enter any additional information for the absence request. This section of the page appears only if the **Display User Fields** check box is selected on the Configure Country Take Setup - User Fields Page and you have user fields defined.

Attachments

Click *Add Attachment* button to open the File Attachment page and upload a file. After you have selected and uploaded the file, select **Done** to return to this page. The uploaded file will appear as an active link in the Attachment section along with the status, date and time the file was uploaded. You can also add description for the file and delete it, if required.

Note: Attachment option is available based on the configuration defined on the “Define Attachments Page” (Application Fundamentals).

Attachment subpage can also be configured to add and view multiple attachments with different types and categories. These are derived from the configuration ID set-up. For more information, see “Configuring and Working With Attachments” (Application Fundamentals)

Balance Information

| <i>Field or Control</i> | <i>Description</i> |
|-------------------------|---|
| View Balances | Click to view your current absence balances. |
| View Requests | Click to view your existing absence requests. |

On successful submission the user is directed back to the Manage Absence page.

The following video provides an overview of Attachments - Enhanced View of Types and Categories:

Video: Image Highlights, PeopleSoft HCM Update Image 32: Attachments - Enhanced View of Types and Categories

| Field or Control | Description |
|-------------------------|---|
| Approval Chain | Click Approval Chain link to access the Approval Chain page, where you can view your absence requests which are pending for approval. |

Manage Absences page with Delegation enabled

The employee can enable another person as his/her proxy to delegate the manage absence transaction.

The following video provides an overview of Absence Self Service Delegation for Fluid.

Video: [Image Highlights, PeopleSoft HCM Update Image 29: Absence Self Service Delegation for Fluid](#)

This example illustrates the fields and controls for Request Absence page with proxy enabled.

Note: Assign the role *EODL_User* to the user to access the Delegation tile and assign delegates.

Related Links

“Configuring Delegation Transactions” (Enterprise Components)

“Working with Self-Service Delegation” (Enterprise Components)

Cancel Absences Tile

Select Cancel Absences (HC_HGA_SS_REQCAN_FLU_GBL) tile to access the Cancel Absences page.

Navigation:

Select Time tile is available on the Employee Self Service Home page to access Cancel Absences Tile.

Select Cancel Absences Tile to access the Cancel Absences page.

This example illustrates the Cancel Absences tile.

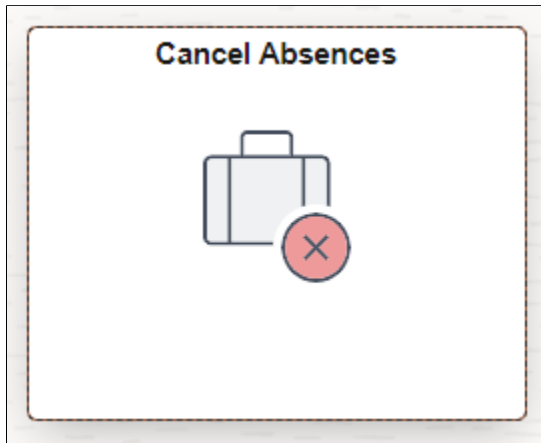



Cancel Absences Page

Use the Cancel Absences page (HGA_SS_REQ_FLU) to cancel an absence request.

Navigation

Employee Self Service > Time > Cancel Absences

This example illustrates the fields and controls on the Cancel Absences page.

| Cancel Absences | | |
|---|---|--------|
|  | Daryl Reese Financial Analyst | |
| View Requests | | 7 rows |
|  | | |
| Vacation Submitted | 01/04/2024 - 02/04/2024 8 Hours Not Processed | > |
| Vacation Submitted | 21/02/2024 - 22/02/2024 4 Hours Not Processed | > |
| Vacation Submitted | 16/02/2024 - 20/02/2024 8 Hours Not Processed | > |
| Vacation Submitted | 15/02/2024 3 Hours Not Processed | > |
| Vacation Submitted | 14/02/2024 4 Hours Not Processed | > |
| Vacation Submitted | 13/02/2024 2 Hours Not Processed | > |
| Vacation Submitted | 12/02/2024 4 Hours Not Processed | > |

This page lists your existing absence requests.

Select  icon to edit the display criteria for the absence requests.

Select an absence request to view the details and cancel the absence.

This example illustrates the fields and controls on the Cancel Absences details page.

| Field or Control | Description |
|-------------------------|--|
| Cancel Reason | Select a reason for canceling the absence request. |
| Comments | Enter any additional comments regarding the absence cancellation. |
| Approval Chain | Click this link to access the Approval Chain page, where you can view your absence requests which are pending for approval. |
| Cancel Absence | Select to submit the request to cancel the absence. You will receive a message confirming that you want to submit the request to cancel the absence. Select Yes to confirm the cancellation. The system changes the status of the absence request to <i>Cancel in Progress</i> and routes it to your manager for approval. |
| Add Attachment | Select to add an attachment for your request. Note: Previously attached documents are in view only mode. The documents attached as a part of cancel request can be edited before submitting. All attachments as part of Absence Request and Cancel Absence are part of Approval Request. |

Cancel Absences page with Delegation enabled

The employee can enable another person as his/her proxy to delegate the cancelling absence transaction. A **Request for** selector appears that allows the delegated employee to cancel the absence on other employee's behalf.

This example illustrates the fields and controls for Cancel Absences page with proxy enabled.

Cancel Absences

Daryl Reese
Financial Analyst

*Job Title: Financial Analyst

*Request for: Daryl Reese (selected), Rosanna Channing

View Requests 7 rows

| | | | |
|--------------------|-------------------------|---------------|---|
| Vacation Submitted | 01/04/2024 - 02/04/2024 | 8 Hours | > |
| | | Not Processed | |
| Vacation Submitted | 21/02/2024 - 22/02/2024 | 4 Hours | > |
| | | Not Processed | |
| Vacation Submitted | 16/02/2024 - 20/02/2024 | 8 Hours | > |
| | | Not Processed | |

Note: Assign the role *EODL_User* to the user to access the Delegation tile and assign delegates.

Related Links

“Configuring Delegation Transactions” (Enterprise Components)

“Working with Self-Service Delegation” (Enterprise Components)

View Requests Tile

Select View Requests (HC_HGA_SS_REQCAN_FLU_GBL) tile to access the [View Requests Page](#).

Navigation:

Select **Fluid Home** under the main menu. On the page that appears, select *Employee Self Service*. The Time tile is available on the Employee Self Service landing page.

Select View Requests Tile to access the View Requests page.

This example illustrates the View Requests tile.

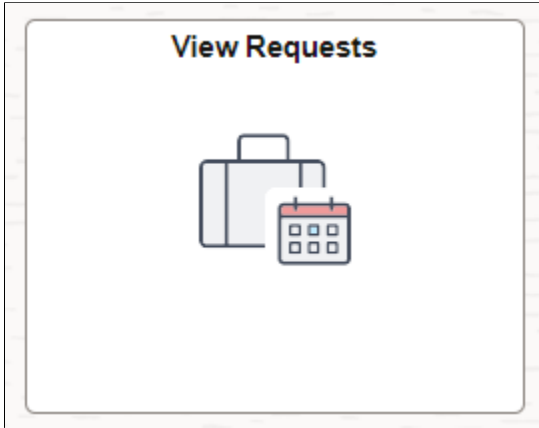

View Requests Page

Use the View Requests page (HGA_SS_REQHIST_FLU) to view your absence requests.

Navigation:

Click the Time tile on the Employee Self Service fluid home page, then click View Requests on the Time page.

This example illustrates the fields and controls on the View Requests page.

View Requests

Daryl Reese
Financial Analyst

View Requests 7 rows

| | | |
|--------------------------------------|--|-------------|
| <p>Vacation Submitted</p> | <p>01/04/2024 - 02/04/2024 8 Hours</p> | <p>></p> |
| <p>Eligible</p> | <p>Not Processed</p> | |
| <p>Vacation Submitted</p> | <p>21/02/2024 - 22/02/2024 4 Hours</p> | <p>></p> |
| <p>Eligible</p> | <p>Not Processed</p> | |

This page lists your existing absence requests along with the absence hours and processing status. Select a request to access the [Absence Details Page](#), and view additional information about the request.

| Field or Control | Description |
|-------------------------|--|
| | <p>Select to filter your absence requests by start date, end date, absence type, and absence status.</p> |

View Requests page with delegation enabled

The employee can enable another person as his/her proxy or delegate for viewing absence requests.

This example illustrates the fields and controls for View Requests page with proxy enabled.

The screenshot shows the 'View Requests' page for user Daryl Reese. At the top, there is a user profile card for Daryl Reese, Financial Analyst. Below the profile, there is a 'Job Title' dropdown set to 'Financial Analyst' and a 'View for' dropdown menu. The 'View for' menu is open, showing 'Daryl Reese' (selected) and 'Rosanna Channing'. Below the dropdowns, there is a table titled 'View Requests' with 7 rows. The table has columns for 'Vacation Submitted', 'Eligible', and 'Not Processed'. The first row shows a vacation request for 01/04/2024 - 02/04/2024, 8 Hours, with 'Eligible' status and 'Not Processed' status. The second row shows a vacation request for 21/02/2024 - 22/02/2024, 4 Hours, with 'Eligible' status and 'Not Processed' status.

| Vacation Submitted | Eligible | Not Processed |
|------------------------------------|----------|---------------|
| 01/04/2024 - 02/04/2024 8 Hours | | |
| 21/02/2024 - 22/02/2024 4 Hours | | |

Note: Assign the role *EODL_User* to the user to access the Delegation tile and assign delegates.

Related Links

“Working with Self-Service Delegation” (Enterprise Components)

Absence Details Page

Use the Absence Details (HGA_SS_REQ_FLU) page to view the detailed information for your absence requests.

Navigation:

Employee Self Service > Time > View Requests

Click any absence request to view the Absence Details page.

This example illustrates the fields and controls on the Request Details page.

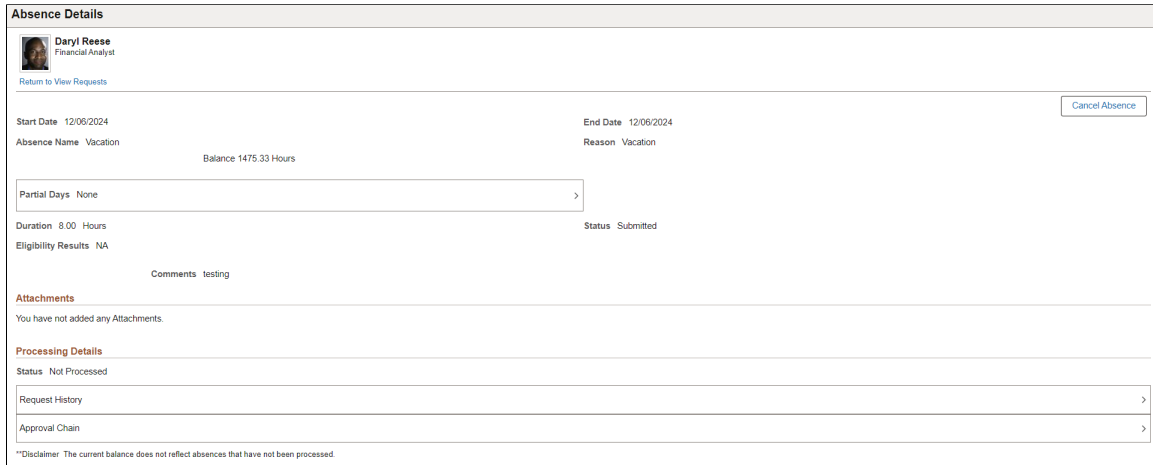

Absence Details

Daryl Reese
Financial Analyst

[Return to View Requests](#)

[Cancel Absence](#)

Start Date 12/06/2024 End Date 12/06/2024

Absence Name Vacation Reason Vacation

Balance 1475.33 Hours

Partial Days None

Duration 8.00 Hours Status Submitted

Eligibility Results NA

Comments testing

Attachments

You have not added any Attachments.

Processing Details

Status Not Processed

Request History

Approval Chain

**Disclaimer: The current balance does not reflect absences that have not been processed

This page displays details for a specific absence request along with your current balance for the associated absence type.

Note: You can edit your absence requests and attachments on this page if they have been saved, and not yet submitted.

You can view the Status and the Eligibility Results for the selected absence. Click the [View Eligibility](#) link to view your absence eligibility details.

You also have the option to cancel your absence from the Absence Details page. To cancel the absence, select **Cancel Absence**. This opens a modal page that allows you to select the reason for cancellation, attach supporting documents and add your comments. To complete the cancellation, select **Cancel Absence** from the modal.

Note: The **Cancel Absence** button is enabled only if **Cancel Allowed By** is set to *Employee* or *Employee and Manager* for the selected absence take in the [Configure Country Take Setup - Absences Page](#).

Attachments appear as view only or as editable, depending on the status of the absence. For example, absence in saved status would provide the ability to add attachments while an absence in submitted status will display attachment as a view only grid.

The processing details grid displays the status of the absence event as it relates to processing in payroll.

This example illustrates the Cancel Absence modal in the Absence Details page.

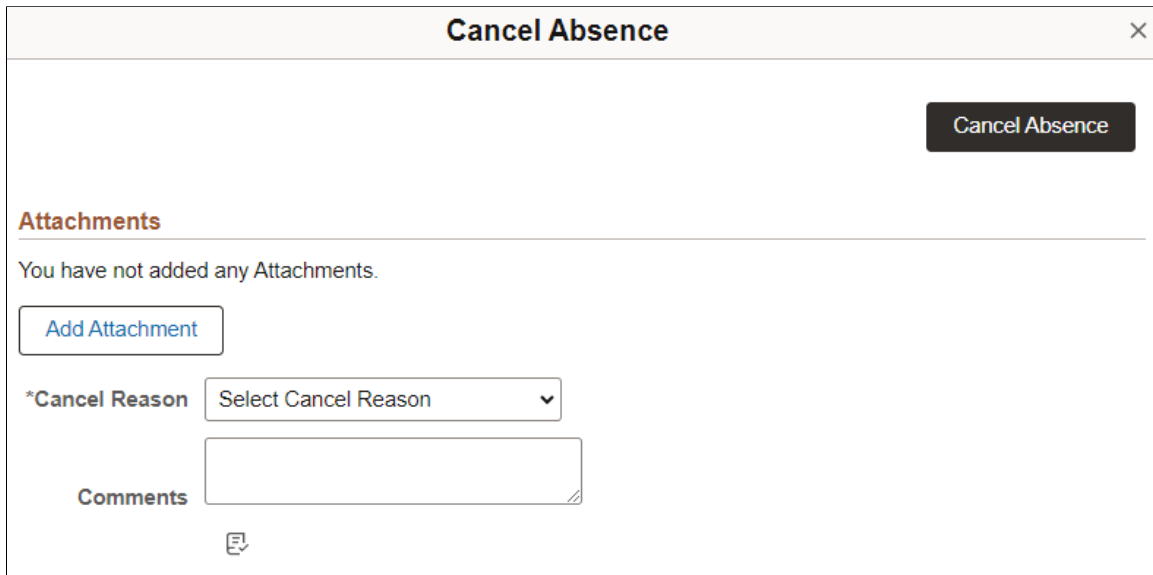

Cancel Absence ✕

Cancel Absence

Attachments

You have not added any Attachments.

Add Attachment

*Cancel Reason Select Cancel Reason ▼

Comments



Absence Balances Tile

Select Absence Balances (HC_HGA_SS_BAL_FLU_GBL) tile to access the Balances page.

Navigation:

Employee Self Service > Time > Absence Balances

This example illustrates the Absence Balances tile.

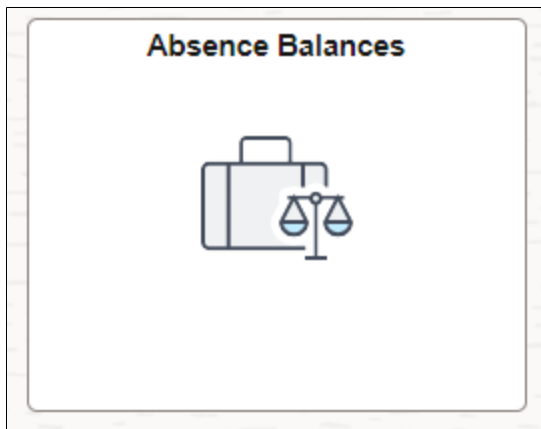

Balances Page

Use the Balances (HGA_SS_BAL_FLU) page to view your current absence balances.

Navigation:

Click the Time tile on the Employee Self Service fluid home page, then select Absence Balances tile on the Time page.

This example illustrates the fields and controls on the Balances page.

Balances



Daryl Reese
Financial Analyst

| | |
|-------------------------------------|-----------------|
| Vacations Balance Hrs | 1413.99 Hours > |
| As Of 31/01/2024 | |
| Sick Balance Hrs | 8.00 Hours > |
| As Of 31/01/2024 | |
| FMLA Military Exigency | 0.00 Hours > |
| As Of 31/01/2024 | |
| Family and Medical Leave Act | 0.00 Hours > |
| As Of 31/01/2024 | |
| FMLA Military Caregiver | 0.00 Hours > |
| As Of 31/01/2024 | |

**Disclaimer The current balance does not reflect absences that have not been processed.

Forecast Balance

As of Date

25/02/2024

📅

Filter by Type

All

▼

*Absence Name

Select Absence Name

▼

This page displays your current absence balances and forecast balance.

Select any absence balance row to access the Balance Details Page, to view balance details like Opening, Earned, Taken, and Adjustment balances.

This example illustrates the Balance Details page.

Balance Details x

***Entitlement**
FMLA Military Caregiver v

Balance as of 01/31/2023

0.00 Hours

Disclaimer: The current balance does not reflect absences that have not been processed.

Summary

| | |
|---|--------------------|
| Period | Earned 0.00 |
| 01/01/2023 - 01/31/2023 (Calendar Period) | Taken 0.00 |
| Adjustment 0.00 | |

Balance History

12 rows

| January | Opening Balance | Earned | Taken | Adjustment |
|------------|-----------------|--------|-------|------------|
| 0.00 Hours | 0.00 | 0.00 | 0.00 | 0.00 |
| December | Opening Balance | Earned | Taken | Adjustment |
| 0.00 Hours | 0.00 | 0.00 | 0.00 | 0.00 |
| November | Opening Balance | Earned | Taken | Adjustment |
| 0.00 Hours | 0.00 | 0.00 | 0.00 | 0.00 |
| October | Opening Balance | Earned | Taken | Adjustment |
| 0.00 Hours | 0.00 | 0.00 | 0.00 | 0.00 |

| Field or Control | Description |
|------------------------------|--|
| Absence Name | On selecting the absence name, the current balance of the employee based on the selected absence name is displayed. |
| Forecast Balance | On clicking the Forecast Balance button, you can view the forecast balance details of the employee. Note: Forecast Balance button appears only once you select a value in the Absence Name field. |
| View Forecast Details | On clicking the View Forecast Details link, you can view the absence forecast details of the employee. Note: View Forecast Details link appears on the screen only after you run the forecast balance using the Forecast Balance button. |

Absence Balance page with delegation enabled

The employee can enable another person as his/her proxy or delegate for viewing absence balances.

This example illustrates the fields and controls for Absence Balances page with proxy enabled.

| Balances | |
|--|--------------|
| *View for | Daryl Reese |
| *Job Title | Daryl Reese |
| FMLA Military Exigency | |
| As Of 12/31/2017 | 0.00 Hours |
| FMLA Military Caregiver | |
| As Of 12/31/2017 | 0.00 Hours |
| Family and Medical Leave Act | |
| As Of 12/31/2017 | 0.00 Hours |
| Vacations Balance Hrs | |
| As Of 12/31/2017 | 631.99 Hours |
| Sick Balance Hrs | |
| As Of 12/31/2017 | 88.00 Hours |
| **Disclaimer The current balance does not reflect absences that have not been processed. | |
| ▶ Forecast Balance | |

Note: Assign the role *EODL_User* to the user to access the Delegation tile and assign delegates.

Related Links

“Working with Self-Service Delegation” (Enterprise Components)

Extended Absence Request Tile

Use the Extended Absence Request (HGA_EA_REQ_LND_FL) tile to access Extended Absence Request page.

The following video gives an overview of the Extended Absence Request Tile:

Video: [Image Highlights, PeopleSoft HCM Update Image 31: Extended Absence Request Tile](#)

Navigation:

Select Time tile under Employee Self Service home page. The Extended Absence Request tile is available on the Time tile.

This example illustrates the fields and controls on the Extended Absence Request Tile.

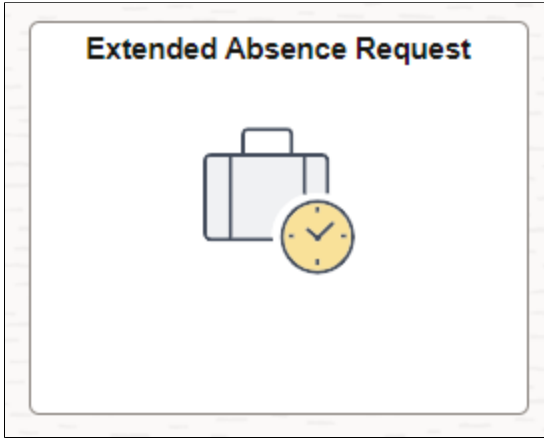

Select Extended Absence Request tile to open the Extended Absence Request page.

Extended Absence Request Page

Use the Extended Absence Request page (HGA_EA_REQ_INIT) to create and manage your extended absences. This page lists the saved and submitted extended absence requests.

Navigation:

Employee Self Service > Time > Extended Absence Request

This example illustrates the fields and controls on the Extended Absence Request Page with saved absences.

Extended Absence Request

 **Daryl Reese**
Financial Analyst

Manage Extended Absence

Create and manage your extended absences here. You can create and submit the extended absence request for approval by entering Start Date, Expected End Date, Absence Take with the rest of the required information. If you are missing some information, save your request for later to manage your extended absences at a later time.

Extended Absence Request

| Absence Name ¹ | Absence Reason ¹ | Start Date ¹ | Expected Return Date ¹ | Status ¹ | Source ¹ | Absence Request Exists ¹ |
|---------------------------|-----------------------------|-------------------------|-----------------------------------|---------------------|---------------------------|-------------------------------------|
| FMLA Medical | Broken Leg | 01/09/2014 | 15/10/2014 | Approved | Employee Extended Absence | Yes |

The Extended Absence Request page allows you to view your extended absences and create new requests.



Select  to create an extended absence request. Select your absence type and absence take and select **Launch** to open the [Extended Absence Request Activity Guide](#).

Absence reasons are linked to the Absence Name (Take) through the Absence Take Type. For more information, see [Defining Absence Types and Reasons](#).

The employee can review the existing absence requests and add a child absence if required. Select an absence to view the absence details.

This example illustrates the View Extended Absence Page when an employee selects an absence from the Extended Absence Request page.

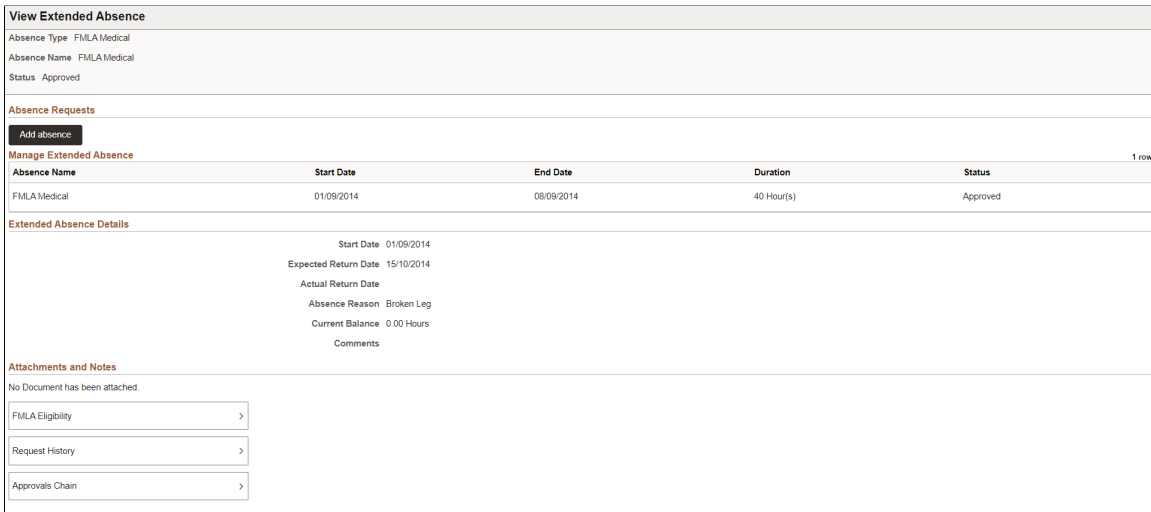

Select **Add absence** to add a child absence for an existing absence.

This example illustrates the Request Absence Page to add a child absence for the extended absence.

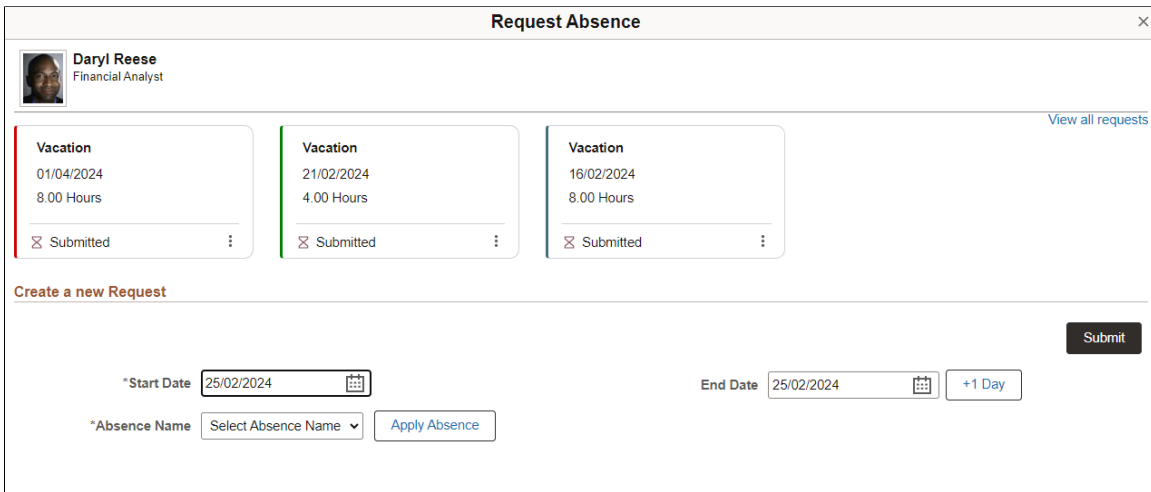

Extended Absence Request Activity Guide

Use the Extended Absence Request activity guide (HGA_EA_REQ_FLU) to create an extended absence request.

Navigation:

1. **Employee Self Service > Time > Extended Absence Request**

- 2.

Select  icon.

3. Select the **Absence Type** and **Absence Take** and select **Launch** to open the Extended Absence Request activity guide.

The activity guides includes the following steps:

1. Step 1 of 4: Absence Information
2. Step 2 of 4: FLMA Eligibility
3. Step 3 of 4: Attachments and Notes
4. Step 4 of 4: Review and Submit

Step 1 of 4: Absence Information

Enter the details of the absence such as start and end date and absence reason.

This example illustrates the fields and controls on the Extended Absence Request — Step 1 of 4: Absence Information Page.

Extended Absence Request

Absence Name FMLA Medical
Absence Type FMLA Medical
Status New

1 Absence Information
Visited

2 FLMA Eligibility
Not Started

3 Attachments and Notes
Not Started

4 Review and Submit
Not Started

Step 1 of 4: Absence Information

*Start Date

*Expected Return Date

Actual Return Date

Absence Reason

Current Balance 0.00 **

Comments

| Field or Control | Description |
|-----------------------------|--|
| Start Date | Select the first day of the extended absence event. The field option defaults to the current date. |
| Expected Return Date | Enter the expected return date. |
| Actual Return Date | Enter an actual return date according to the leave plan. |
| Absence Reason | Specify the reason for the selected absence take. Absence reasons are associated with absence takes through absence take types on the Absence Take Types page. |
| Comment | Enter additional comments, if any. |

Select **Save** and **Next** to continue to **Step 2 of 4: FLMA Eligibility**.

Step 2 of 4: FLMA Eligibility

Enter the eligibility details for the absence.

This example illustrates the fields and controls on the Extended Absence Request — Step 2 of 4: FLMA Eligibility Page.

| Field or Control | Description |
|------------------------------------|--|
| Medical Certification | The information in this grid is filled by your FMLA administrator and are not shared with management. |
| FMLA Eligibility (Employee) | Enter eligibility details in this grid. The employees eligibility criteria will be defined during the time of joining and the information available here will be according the template set. |
| Comments | Enter the comments, if any. |
| Validate Sections | Select to the validate the entered information. |

Select **Next** to continue to **Step 3 of 4: Attachments and Notes**.

Step 3 of 4: Attachments and Notes

Add supporting documents and notes for your absence request.

This example illustrates the fields and controls on the Extended Absence Request — Step 3 of 4: Attachments and Notes Page.

Step 4 of 4: Review and Submit

Review the absence information entered and submit the request.

This example illustrates the fields and controls on the Extended Absence Request — Step 4 of 4: Review and Submit Page.

Using the PeopleSoft Fluid User Interface to Work with Absences as a Manager

Managers can use the PeopleSoft Fluid User Interface to request absences, view absence requests, view absence balances, and cancel absences for their employees. Managers can also analyze the absence data and approve the absence requests using the fluid user interface.

This topic describes the PeopleSoft Absence Management tasks that you access using the **Team Time** tile. For more information on the PeopleSoft Time and Labor tasks, see “Using PeopleSoft Fluid User Interface for Time Management as a Manager” (PeopleSoft Time and Labor).

Related Links

- “Understanding PeopleSoft Fluid User Interface Homepages” (Application Fundamentals)
- “Using the Manager Self-Service Homepage” (Application Fundamentals)

Pages Used to Work with Absences as a Manager Using the PeopleSoft Fluid User Interface

| Page Name | Definition Name | Usage |
|---|--|---|
| Absence Analytics Tile | HC_HGA_EVENT_ANLY_FL_GBL (this is the cref for the tile) | Click this tile to access the Absence Analytics navigation collection page. For more information Absence Analytics, see Using the PeopleSoft Fluid User Interface to Work with Absence Analytics as a Manager |
| Approvals Tile | | Click this tile to access the Approvals navigation collection page. For more information Absence Approvals, see Approving Absence Transactions Using Fluid Approvals . |
| <u>Team Time Tile</u> | HC_TL_START_NAV_FLU_MSS_GBL (this is the cref for the tile) | Click this tile to access the Team Time navigation collection page. |
| <u>Team Time Page</u> | HR_PSEL_FLU | Access manager self-service absence transactions. Note: You can retain the employees' context when switching between transactions like request to view balances in Absence transactions within the navigation collection in Manager Self Service (MSS). |
| <u>Manage Absence (Select Employee) Page</u> | HR_PSEL_FLU | Select the employee for whom you want to enter an absence request. |
| <u>Manage Absences Page</u> | HGA_SS_REQ_FLU | Enter self-service absence requests for an employee. |
| <u>Cancel Absences (Select Employee) Page</u> | HR_PSEL_FLU | Select the employee for whom you want to cancel an absence request. |
| <u>Cancel Absences (View Requests) Page</u> | HGA_SS_REQHIST_FLU | Select an employee absence request that you want to cancel. |
| <u>Cancel Absences Page</u> | HGA_SS_REQ_FLU | Cancel an employee's absence request. |
| <u>View Requests (Select Employee) Page</u> | HR_PSEL_FLU | Select the employee for whom you want to view absence requests. |
| <u>View Requests Page</u> | HGA_SS_REQHIST_FLU | View an employee's absence requests. |

| Page Name | Definition Name | Usage |
|---|------------------------|---|
| <u>Request Details Page</u> | HGA_SS_REQ_FLU | View detailed information for an employee's absence requests. |
| <u>Absence Balances Page</u> | HR_PSEL_FLU | Select the employee for whom you want to view current absence balances. |
| <u>Balances Page</u> | HGA_SS_BAL_FLU | View an employee's current absence balances. |
| <u>Cancel Absences (Select Employee) Page</u> | HR_PSEL_FLU | Select the employee for whom you want to cancel the absence requests. |

Team Time Tile

Use the Team Time tile to access the Team Time page. Click the **Team Time** tile on the Manager Self Service home page to access a list of PeopleSoft Time and Labor, and PeopleSoft Absence Management manager self-service tasks that you can perform. The tasks listed are based on the applications that are installed and on the security access of the logged in user.

Navigation:

Select **Fluid Home** under the main menu. On the page that appears, select **Manager Self Service**. The Team Time tile is available on the Manager Self Service landing page.

As a manager, you can add the tile, through personalization, to a system-delivered home page or a home page that you create.

This example illustrates the Team Time tile.

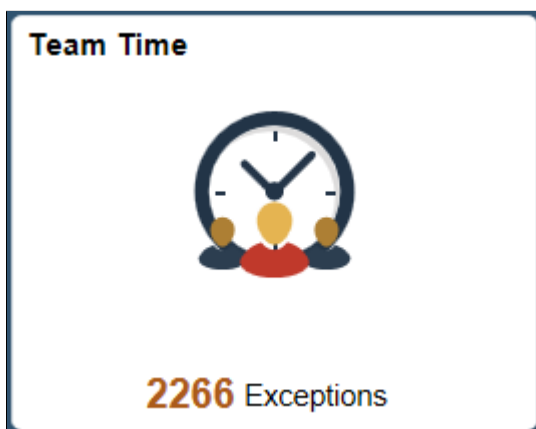

The tile shows the total number of exceptions. If no exceptions are available, the tile does not display a number count.

Click the tile to access these Team Time transactions without using traditional menu navigation:

- Manage absences for an employee.

- View requests.
- View absence balances.

Team Time Page

Use the Team Time navigation collection page (HR_PSEL_FLU) to access manager self-service absence transactions.

Navigation:

Click the Team Time tile on the Manager Self-Service fluid home page.

Note: You can retain the employees' context when switching between transactions like request to view balances in Absence transactions within the navigation collection in Manager Self Service (MSS). Only employee context is maintained and not date context.

This example illustrates the fields and controls on the Team Time navigation collection page.

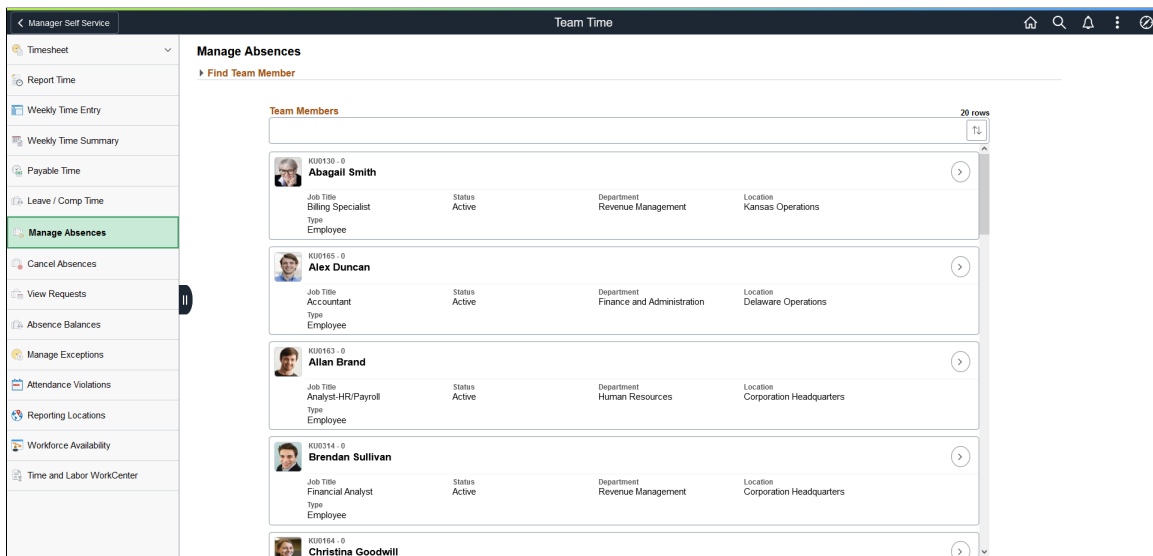

| Field or Control | Description |
|-------------------------|--|
| Manage Absence | Click to access the Manage Absence (Select Employee) Page . |
| Cancel Absences | Click to access the Cancel Absences (Select Employee) Page . |
| View Requests | Click to access the View Requests (Select Employee) Page . |
| Absence Balances | Click to access the Absence Balances Page . |

Manage Absence (Select Employee) Page

Use the Manage Absence (select employee) page (HR_PSEL_FLU) to select the employee for whom you want to enter an absence request.

Navigation:

Click the Team Time tile on the Manager Self Service fluid home page, then click Manage Absence on the Team Time page.

This example illustrates the fields and controls on the Manage Absence (select employee) page.

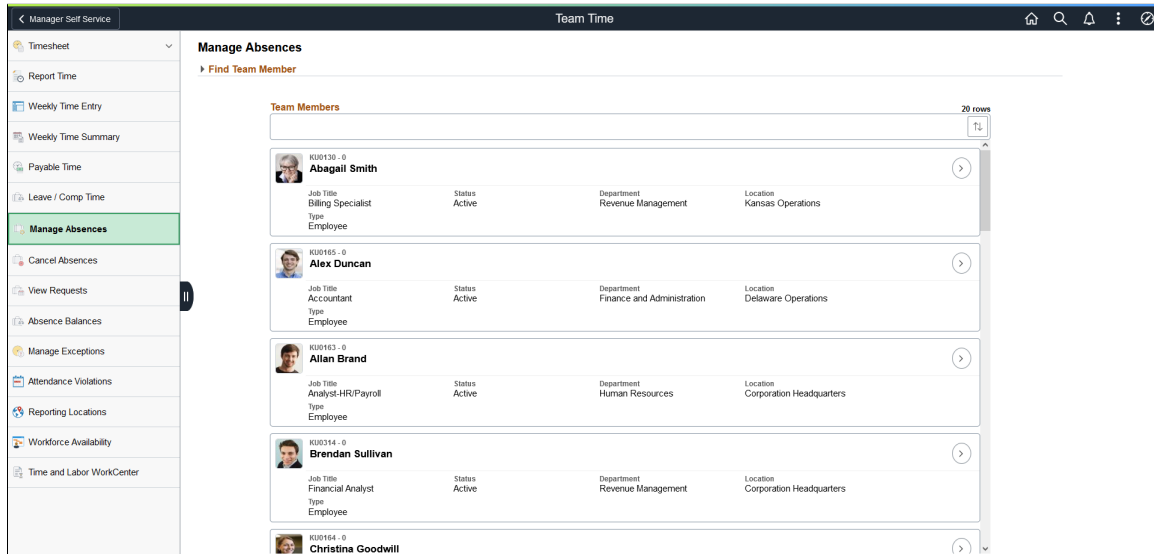

Use this page to search for and select an employee for whom you want to submit an absence request. Click the desired employee to access the [Manage Absences Page](#).

| Field or Control | Description |
|---|--|
|  (Grid Sort) | Click to sort the employees by Name, Job Title, ID - Record, Status, Schedule Type, Department, or Location. A green Grid Sort icon indicates that you have specified one of these grid sorts. |
| Directs/Total | When an employee has direct reports, the number and the total display as a link in this column. You can click the link to drill down to that employee’s list of direct reports. |

A manager can delegate their tasks of approving time, entering employee time, or entering their own time to another person due to workload or their own absence from the office. When a proxy to the manager (A manager granted authority to act on behalf of another manager) is logged in, ‘acting as’ field will be displayed to confirm if the person needs to view and process absence requests of his own employees or acts as a proxy to another manager.

This example illustrates the Request Absence (select employee) page when a proxy to the manager is logged in.

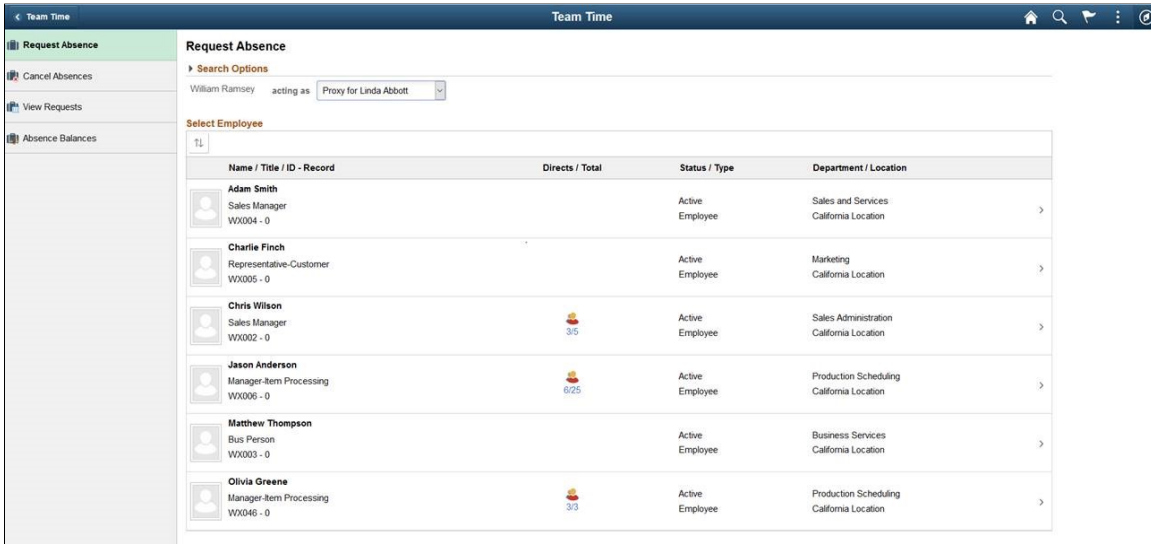

Based on the selection, the list of employees will be refreshed. For more information on delegation, see “Working with Self-Service Delegation” (Enterprise Components)

Manage Absences Page

Use the Manage Absence page (HGA_SS_REQ_FLU) to enter self-service absence requests for an employee.

Navigation:

Click an employee on the Manage Absence (select employee) page.

This example illustrates the fields and controls on the Manage Absence page.

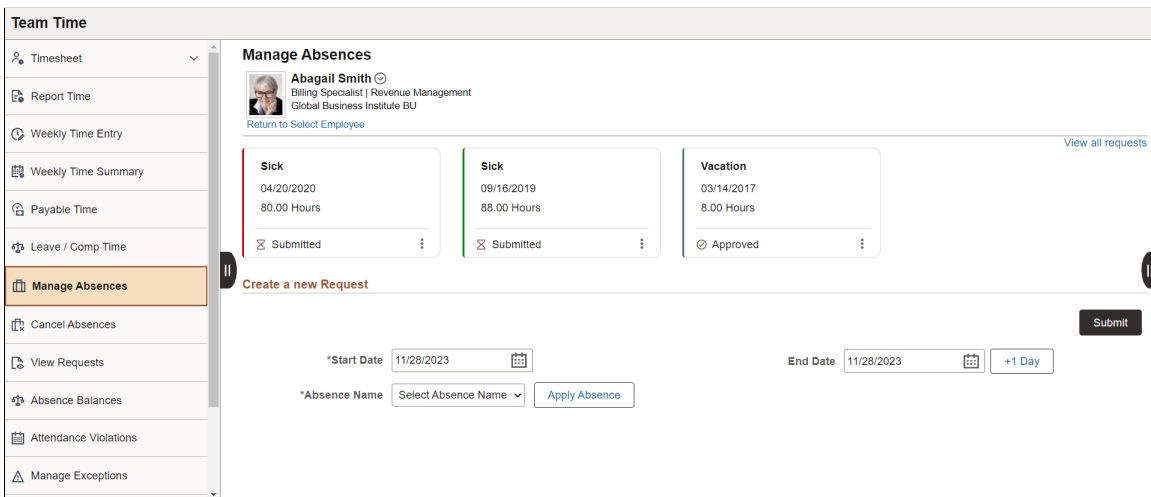

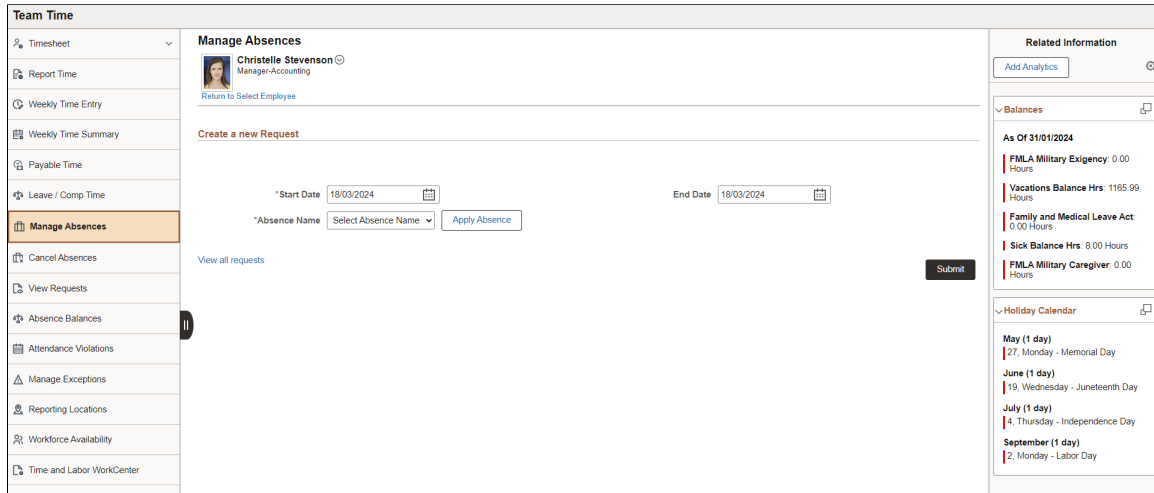

This example illustrates the fields and controls on the Manage Absence page in screen reader mode.



You can use this page to enter absence requests for employees.

| Field or Control | Description |
|---|--|
| Employee Header | <p>The employee header displays the employee photo and up to three lines of information for a selected job. This information can be configured using the employee header configuration. For more information, see “(Fluid) Managing Employee Headers” (Application Fundamentals).</p> <p>For employees with multiple active jobs, The Select Another Job link will be enabled to switch between them as required.</p> |
| Return to Select Employees | Select to go back to the search employees page. |
| Absence Cards | <p>Displays the recent absence requests. The card includes the Absence name, start date, duration and status of the request. The related actions allows user to open the View Absence and Cancel Absence pages. The page displays the three most recent absence requests, sorted chronologically based on the submission date.</p> <hr/> <p>Note: In screen reader mode, the Manage Absences page does not display the absence cards. To view the absence requests, select View all requests link.</p> |
| View all requests | Opens the View Requests Page . |
|  | Enables users to add absence end date by one increments. |

| Field or Control | Description |
|---|---|
|  <p>(Supplementary Panel tab button)</p> | <p>Click this icon to open the supplementary panel. The panel displays the My Analytics tab.</p> |
| <p>Absence Name</p> | <p>Select the absence name from the available options. The options available depends on the selection in the Filter by Type field, the absence takes that are enabled in the Country Take setup, and the elements for which the employee is eligible. After you select entries in the above fields, the system refreshes the page with additional fields.</p> <hr/> <p>Note: If you decide to change the Absence Name previously selected, the system will display a warning that all your existing absence data will be lost.</p> |
|  | <p>Enables users to view and update the create request page as a whole after selecting the required absence name.</p> |

This example illustrates the fields and controls on the Manage Absence page upon clicking the apply button.

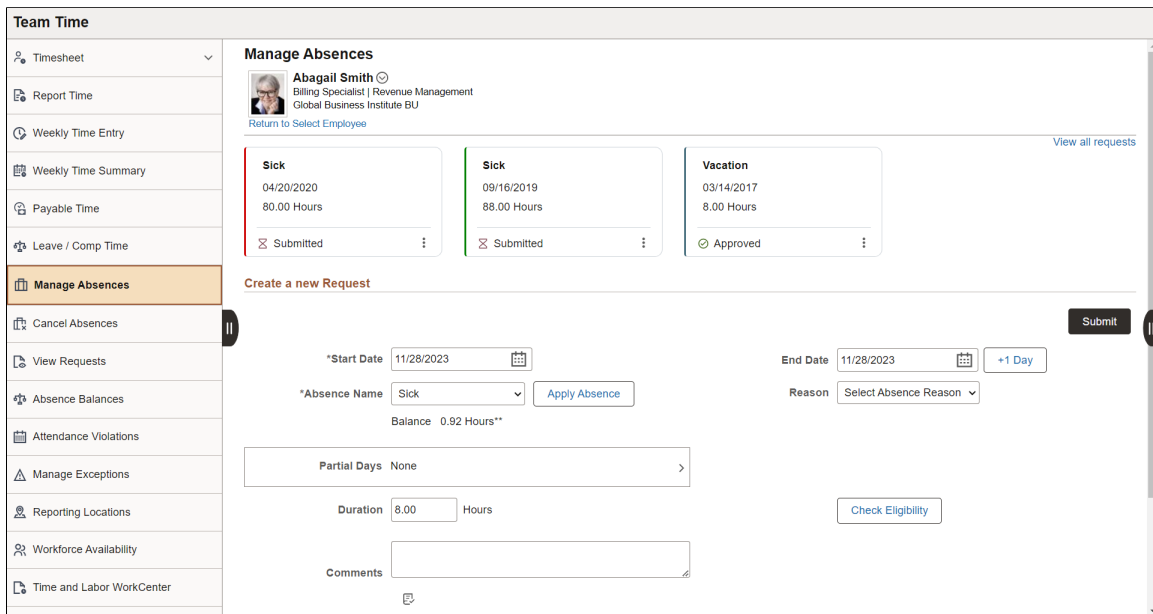

The system displays a page that is similar to the Employee Self Service, with the exception that it contains a **Workflow** section and a **Return to Select Employee** link to the *View Employee Absence Requests* page.

| Field or Control | Description |
|---|--|
| Reason | Select a reason from the available options. Absence reasons are linked to the Absence Name (Take) through the Absence Take Type. See Defining Absence Types and Reasons . |
| Duration | The system calculates the value of this field based on the Start Date and End Date that you enter. |
| Comments | Users can add comments using this field. |
|  | Allows users to perform spelling check and find corrections using this icon. |
| Check Eligibility | Click Check Eligibility to see if you are eligible for the absence request based on the values entered. On clicking the link, a pop up appears displaying the eligibility status. |
| Request As | Indicates whether the request is entered as an Employee or as a Manager. When the manager requests absences for an employee they can request the time as the employee or the manager. If the manager selects to request the time as the Employee the request will be automatically approved, if there are no other approvers in the approval path. The manager will receive an approval confirmation page when clicking Submit. If the manager selects to request the time as the Manager the request will be sent to the manager's next level of approval, and therefore the manager will receive a regular Submit confirmation page after clicking Submit. |
| Related Information | The related information panel shows the Balances and Holiday Calendar. By default, the Holiday Calendar is configured to show holidays in the next six months. Use the Display Holiday Calendar in Modal Window to select a different period. |
| Submit | Click to submit the absence request. |

For more information on other fields , see [Extended Absence Request Page](#)

My Analytics

The **My Analytics** tab provides access to the simplified analytics capabilities provided by PeopleTools 8.55 and later. Click the plus button to create a new absence-related chart.

The delivered role *PivotGridSuperUser* gives users the ability to create and publish reports.

For information on how to use the My Analytics tab and the Simplified Analytics Wizard, see *PeopleTools: Pivot Grid*, *Using Simplified Analytics*, *Creating and Using Simplified Analytic Reports*.

Video: [PeopleSoft Simplified Analytics](#)

This is an example of a pivot grid created using the My Analytics tab of the Request Absence page.

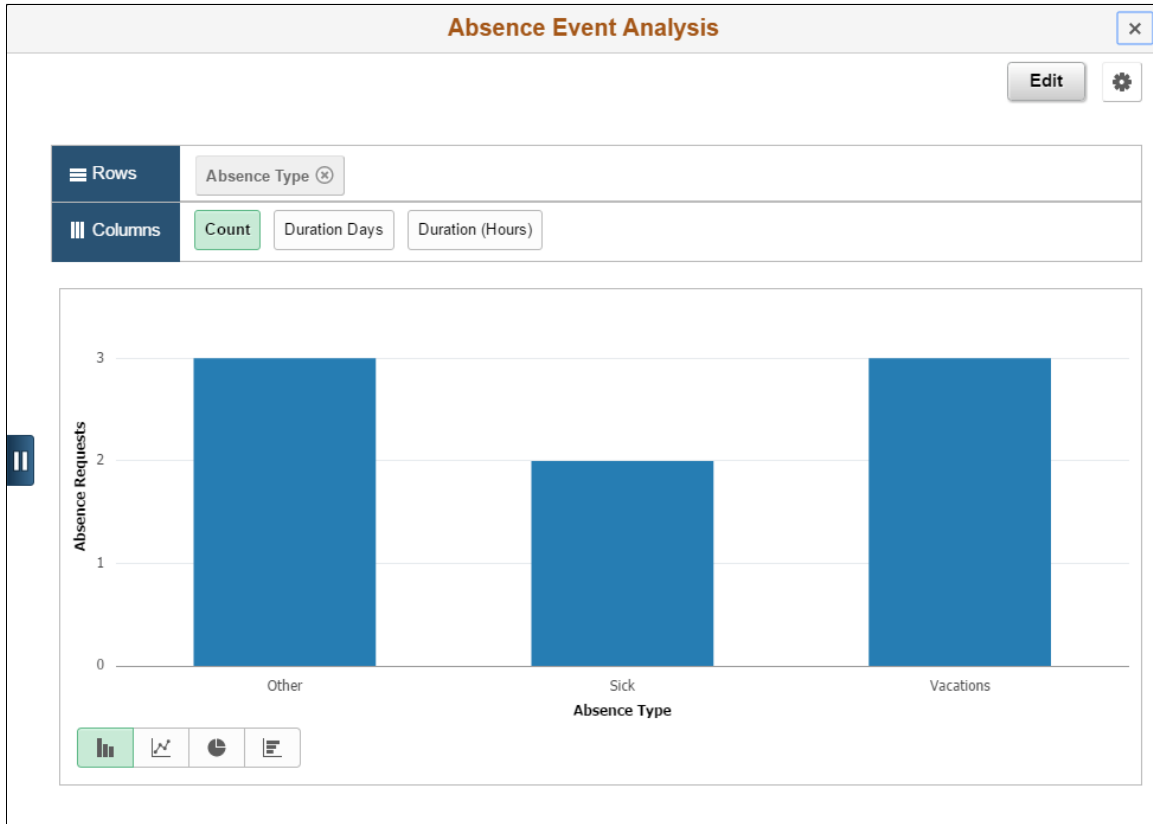

Cancel Absences (Select Employee) Page

Use the Cancel Absences (Select Employee) page (HR_PSEL_FLU) to select the employee for whom you want to cancel an absence request.

Navigation:

Click the Team Time tile on the Manager Self Service fluid home page, then click Cancel Absences on the Team Time page.

This example illustrates the fields and controls on the Cancel Absences (Select Employee) page.

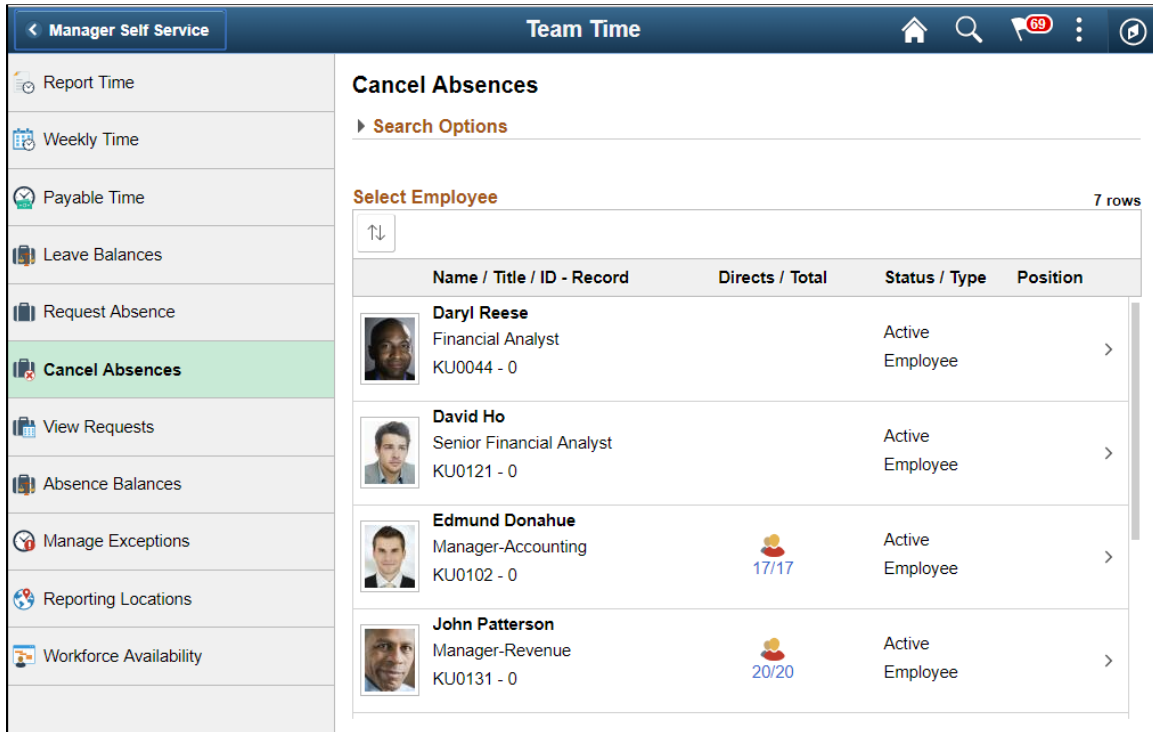

Use this page to search for and select an employee for whom you want to cancel an absence. Click the desired employee to access the [Cancel Absences \(View Requests\) Page](#).

| Field or Control | Description |
|---|--|
|  (Grid Sort) | Click to sort the employees by Name, Job Title, ID - Record, Status, Schedule Type, Department, or Location. A green Grid Sort icon indicates that you have specified one of these grid sorts. |
| Directs/Total | When an employee has direct reports, the number and the total display as a link in this column. You can click the link to drill down to that employee’s list of direct reports. |

When a proxy to the manager (A manager granted authority to act on behalf of another manager) is logged in, ‘acting as’ field will be displayed in the Cancel Absence Page to confirm if the manager needs to process absence cancellation for his own employees or acts as a proxy to another manager. Based on the selection, the list of employees will be refreshed.

This example illustrates the Cancel Absences (Select Employee) page when a proxy to the manager is logged in.

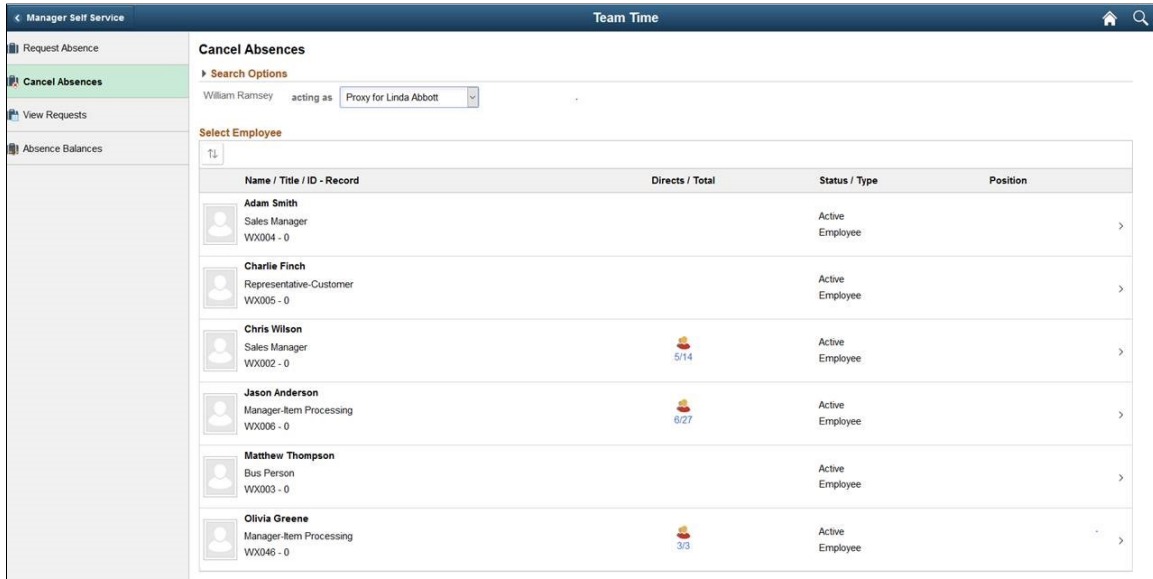

For more information on delegation, see “Understanding Delegation” (Enterprise Components)

Cancel Absences (View Requests) Page

Use the Cancel Absences (View Requests) page to select an employee absence request that you want to cancel.

Navigation:

Click an employee on the Cancel Absences (Select Employee) page.

This example illustrates the fields and controls on the Cancel Absences (View Requests) page.

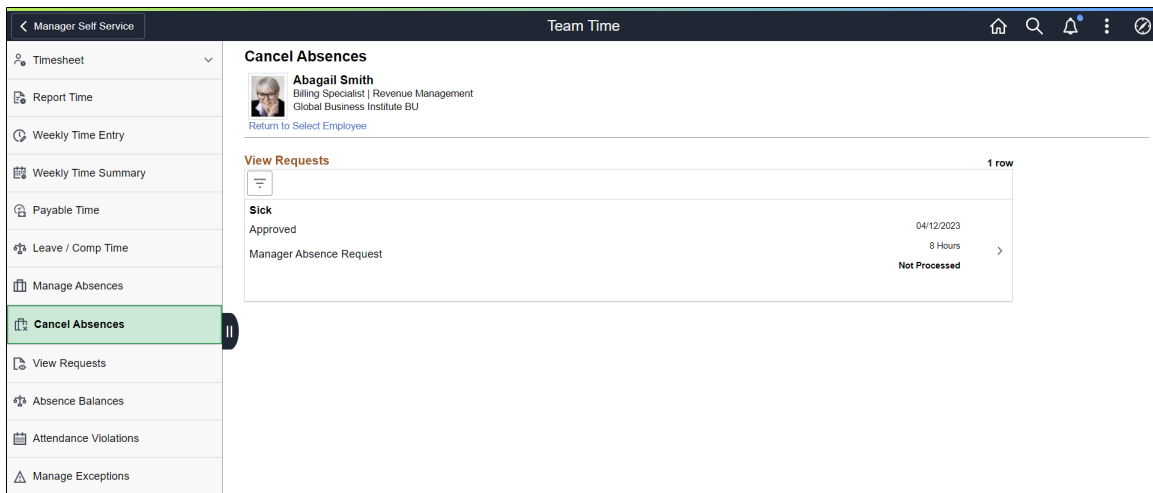

This page lists the employee’s existing absence requests. Click a request that you want to cancel to access the Cancel Absences Page.

| Field or Control | Description |
|---|---|
|  (Filters) | Click to filter the absence requests by start date, end date, and absence type. |
| Return to Select Employee | Select to go back to the search employees results page. |

Cancel Absences Page

Use the Cancel Absence page (HGA_SS_REQ_FLU) to cancel an employee’s absence request.

The following video includes a demonstration of absence cancellation.

Video: [Image Highlights, PeopleSoft HCM Update Image 19: Absence Request Cancellation](#)

Navigation:

Click an absence request on the Cancel Absences_View Requests page.

This example illustrates the fields and controls on the Cancel Absences page.

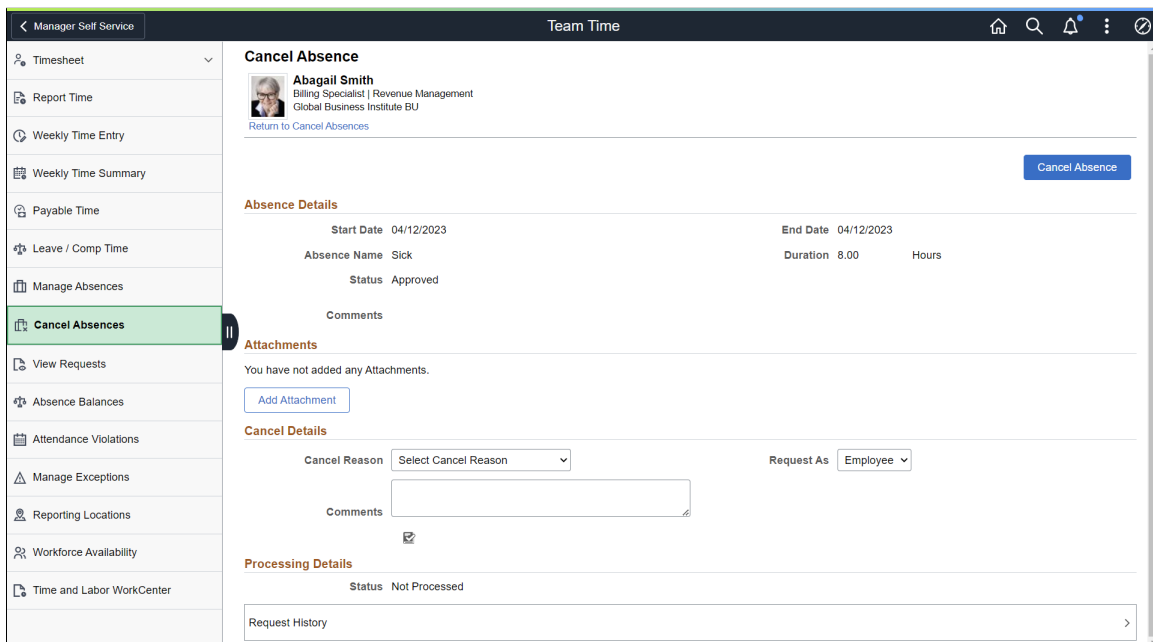

| Field or Control | Description |
|----------------------------------|---|
| Return to Cancel Absences | Select to go back to view request page for Cancel Absences. |
| Cancel Reason | Select a reason for canceling the absence request. |

| Field or Control | Description |
|-------------------------|--|
| Request As | Determines whether the absence cancellation is entered as an <i>Employee</i> or as a <i>Manager</i> . If you select <i>Employee</i> , the system approves the absence request. If you select <i>Manager</i> , the system routes the request to next available manager. |
| Comments | Enter any additional comments regarding the absence cancellation. |
| Cancel Absence | Click this button to cancel the absence. You will receive a message confirming that you want to cancel the absence. Click Yes to confirm the cancellation. The system changes the status of the absence request to <i>Canceled</i> . |

This example illustrates the fields and controls of the Cancel Absence page with absence request attached.

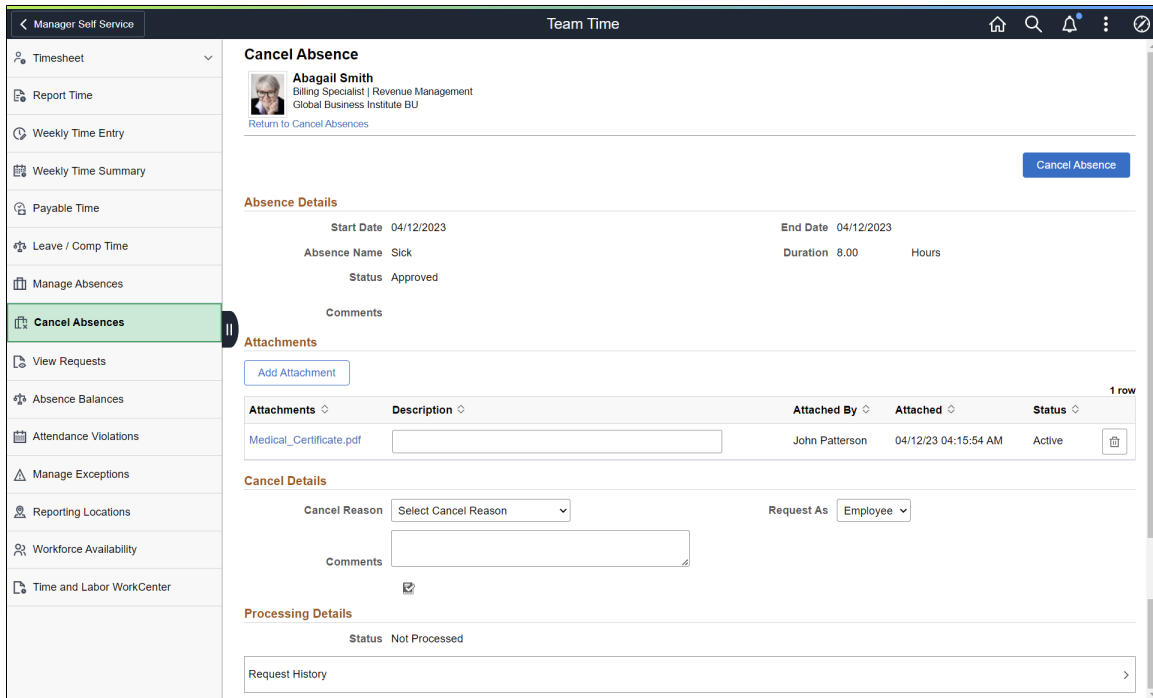

If the Manager cancels the absence request, he can add a new document as an attachment. Manager can view, edit and delete the newly added attachments.

This example illustrates the fields and controls of the Cancel Absence page with absence request attached using a smartphone.

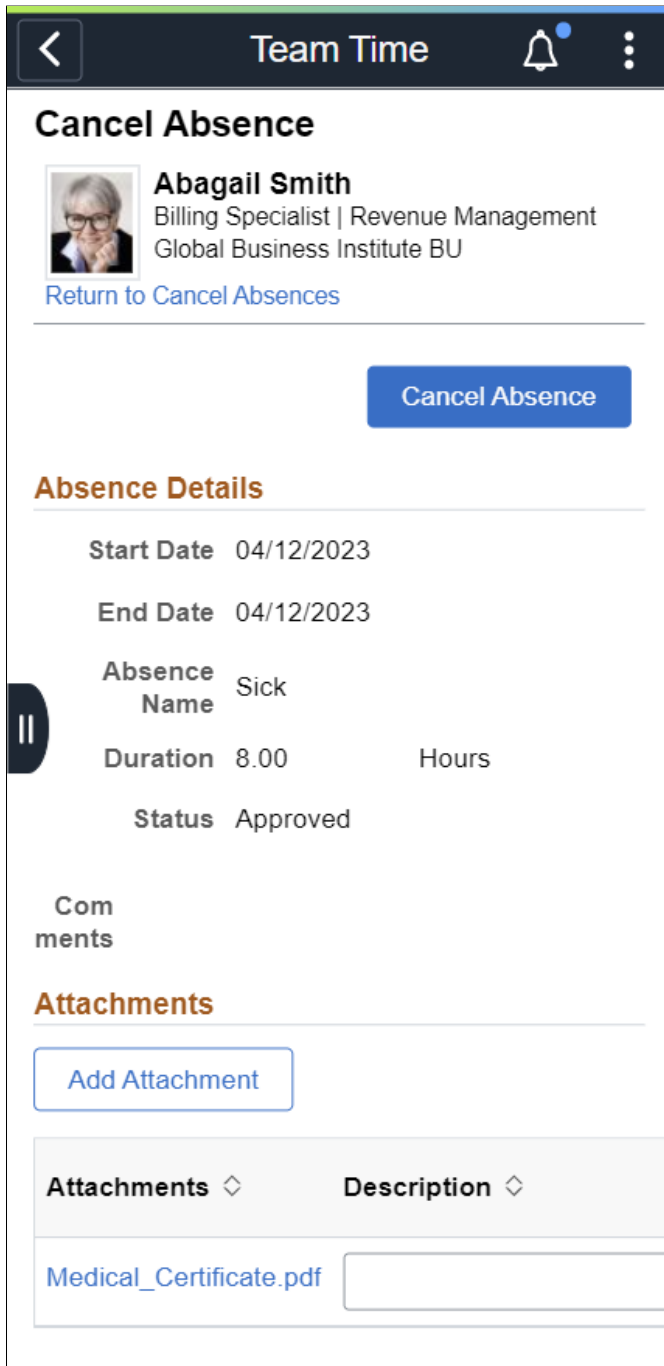

Team Time

Cancel Absence

Abigail Smith
Billing Specialist | Revenue Management
Global Business Institute BU
[Return to Cancel Absences](#)

Cancel Absence

Absence Details

Start Date 04/12/2023

End Date 04/12/2023

Absence Name Sick

Duration 8.00 Hours

Status Approved

Comments

Attachments

[Add Attachment](#)

| Attachments | Description |
|-------------------------|-------------|
| Medical_Certificate.pdf | |

View Requests (Select Employee) Page

Use the View Requests (select employee) page (HR_PSEL_FLU) to select the employee for whom you want to view absence requests.

Navigation:

Click the Team Time tile on the Manager Self Service fluid home page, then click View Requests on the Team Time page.

This example illustrates the fields and controls on the View Requests (select employee) page.

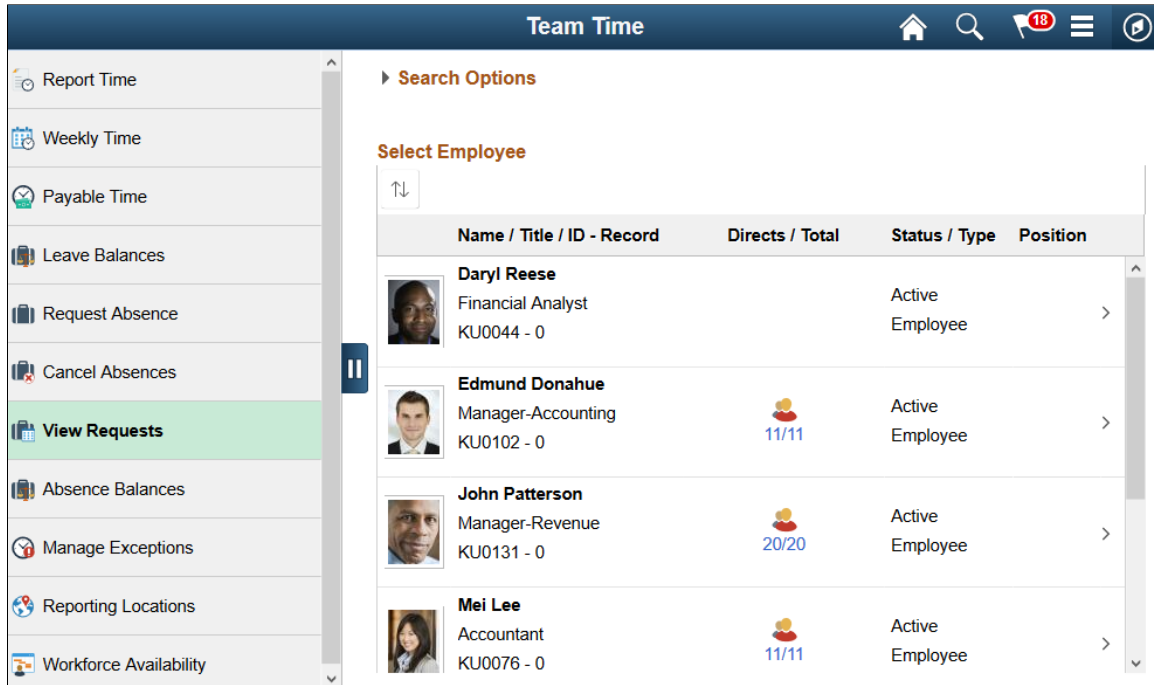

Use this page to search for and select an employee. Click the desired employee to access the [View Requests Page](#).

| Field or Control | Description |
|-------------------------|--|
| (Grid Sort) | Click to sort the employees by Name, Job Title, ID - Record, Status, Schedule Type, Department, or Location. A green Grid Sort icon indicates that you have specified one of these grid sorts. |
| Directs/Total | When an employee has direct reports, the number and the total display as a link in this column. You can click the link to drill down to that employee’s list of direct reports. |

When a proxy to the manager (A manager granted authority to act on behalf of another manager) is logged in, ‘acting as’ field will be displayed in the View Requests page to confirm if the person needs to view his own employee’s requests or acts as a proxy to another manager.

This example illustrates the View Requests (select employee) page when a proxy to the manager is logged in.

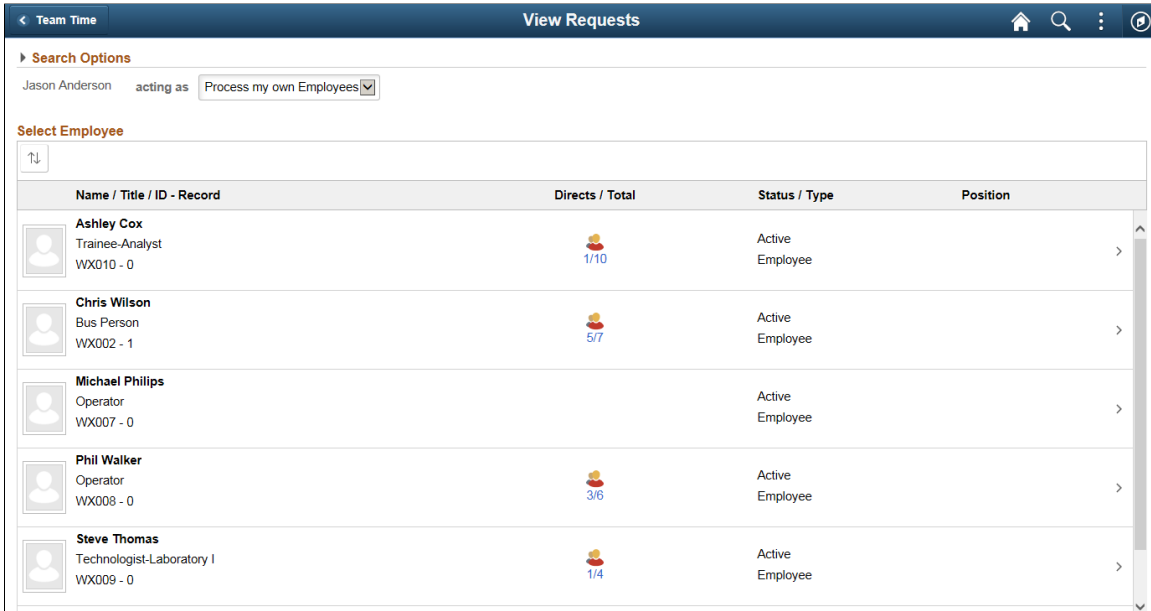

Based on the selection, the list of employees will be refreshed. For more information on delegation, see “Working with Self-Service Delegation” (Enterprise Components)

View Requests Page

Use the View Requests page (HGA_SS_REQHIST_FLU) to view an employee’s absence requests.

Navigation:

Click an employee on the View Requests (select employee) page.

This example illustrates the fields and controls on the View Requests page.

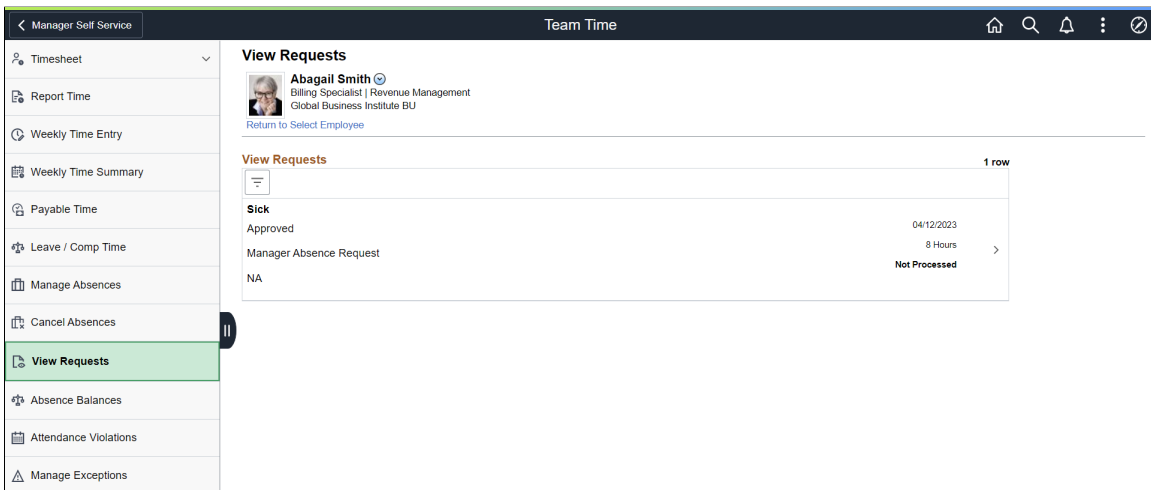

This page lists an employee’s existing absence requests. Click a request to access the Request Details Page, where you can view additional information about the request.

| Field or Control | Description |
|---|---|
| Return to Select Employee | Select to return to the employee search results for view requests. |
|  (Filters) | Click to filter the absence requests by start date, end date, absence type, and absence status. |

Request Details Page

Use the Request Details page (HGA_SS_REQ_FLU) to view detailed information for an employee’s absence requests.

Navigation:

Manager Self Service > Team Tile > View Requests

Click an employee on the View Requests (select employee) page.

Click an absence request to view the details.

This example illustrates the fields and controls on the Request Details page.

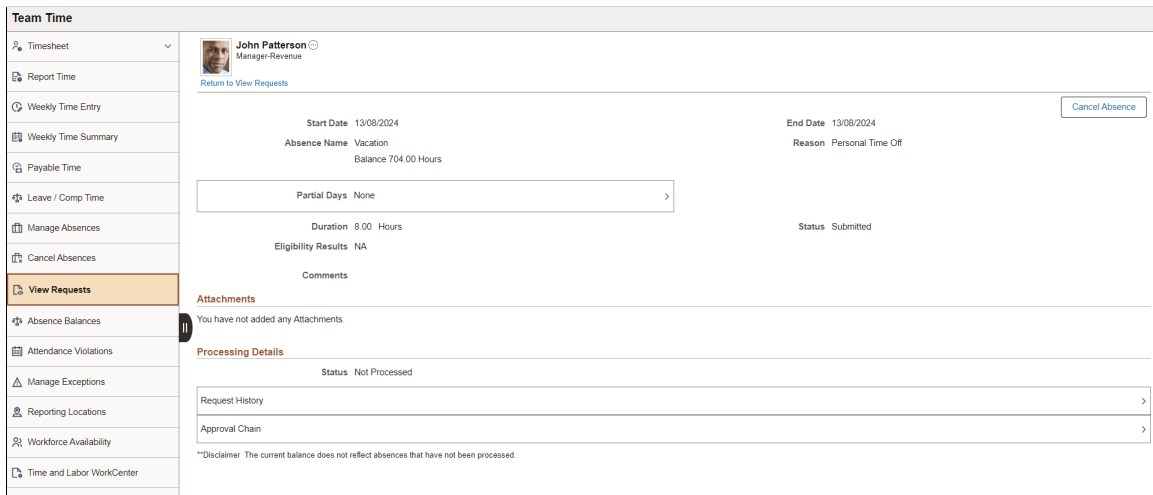

| Field or Control | Description |
|--------------------------------|--|
| Return to View Requests | Select to go back to the View Requests page. |

This page displays details for a specific absence request along with the employee’s current balance for the associated absence type.

Note: As a Manager, you can view any document uploaded along with an Absence Request in the *View Request-Request Details* page.

The **Cancel Absence** button is enabled only if **Cancel Allowed By** is set to *Manager* or *Employee and Manager* for the selected absence take in the Configure Country Take Setup - Absences Page.

Absence Balances Page

Use the Absence Balance page (HR_PSEL_FLU) to select the employee for whom you want to view current absence balances.

Navigation:

Click the Team Time tile on the Manager Self Service fluid home page, then click Absence Balances on the Team Time page.

This example illustrates the fields and controls on the Absence Balance page.

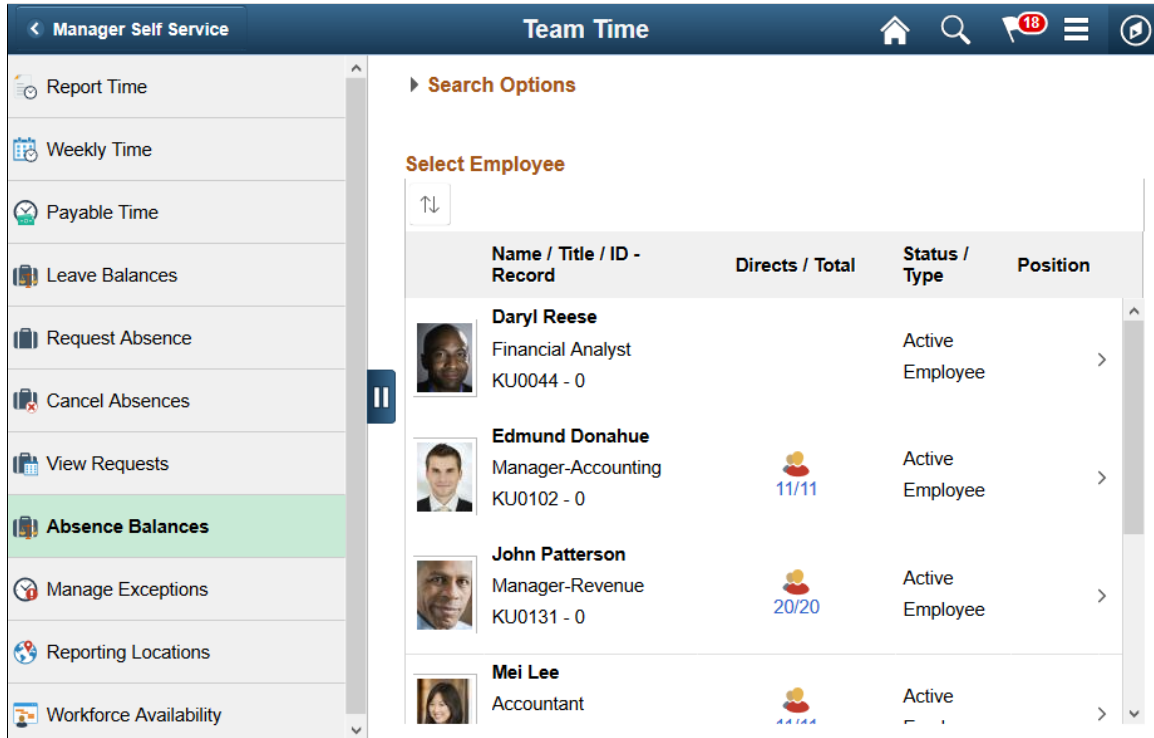

Use this page to search for and select an employee. Click the desired employee to access the Balances page.

| Field or Control | Description |
|---|--|
|  (Grid Sort) | Click to sort the employees by Name, Job Title, ID - Record, Status, Schedule Type, Department, or Location. A green Grid Sort icon indicates that you have specified one of these grid sorts. |
| Directs/Total | When an employee has direct reports, the number and the total display as a link in this column. You can click the link to drill down to that employee's list of direct reports. |

Note: When a proxy to the manager (A manager granted authority to act on behalf of another manager) is logged in, ‘acting as’ field will be displayed in the Absence Balance Page to confirm if the manager needs to view current absence balances for his own employees or acts as a proxy to another manager. Based on the selection, the list of employees will be refreshed.

This example illustrates the Absence Balance page when a proxy to the manager is logged in.

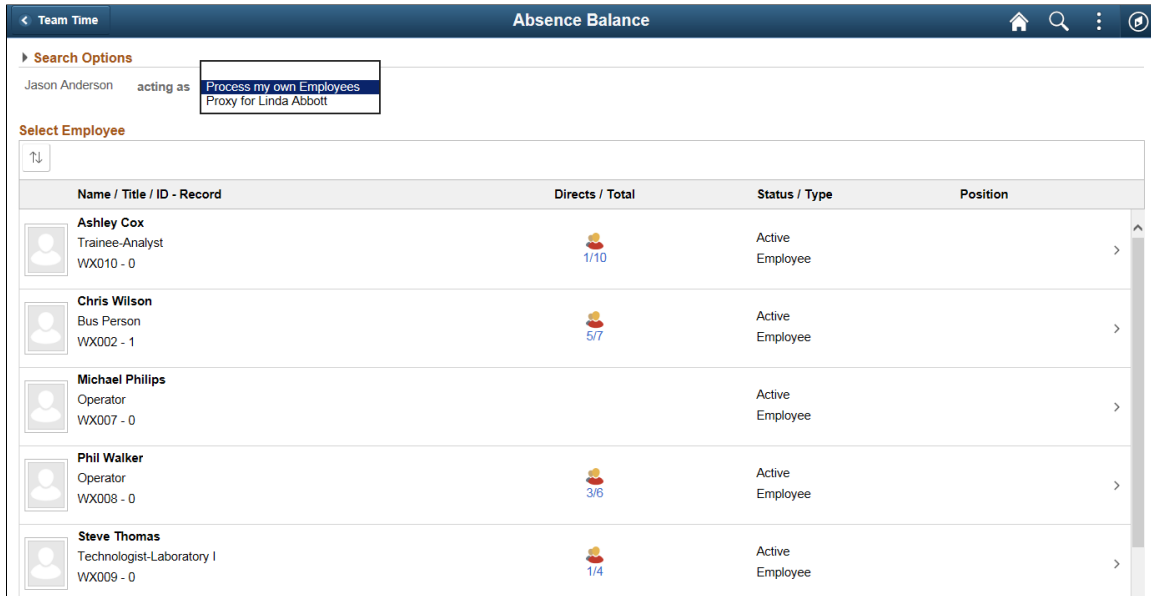

The screenshot shows the 'Absence Balance' page. At the top, the user is identified as 'Jason Anderson' and is 'acting as' a proxy for 'Linda Abbott'. A dropdown menu is open, showing two options: 'Process my own Employees' (selected) and 'Proxy for Linda Abbott'. Below this is a 'Select Employee' section with a table of employees.

| Name / Title / ID - Record | Directs / Total | Status / Type | Position |
|--|-----------------|--------------------|----------|
| Ashley Cox Trainee-Analyst WX010 - 0 | 1/10 | Active Employee | |
| Chris Wilson Bus Person WX002 - 1 | 5/7 | Active Employee | |
| Michael Phillips Operator WX007 - 0 | | Active Employee | |
| Phil Walker Operator WX008 - 0 | 3/6 | Active Employee | |
| Steve Thomas Technologist-Laboratory I WX009 - 0 | 1/4 | Active Employee | |

Based on the selection, the list of employees will be refreshed. For more information on delegation, see “Understanding Delegation” (Enterprise Components).

Balances Page

Use the Balances page to view your current absence balances.

Navigation:

Click an employee on the Absence Balance page.

This example illustrates the fields and controls on the Balances page.

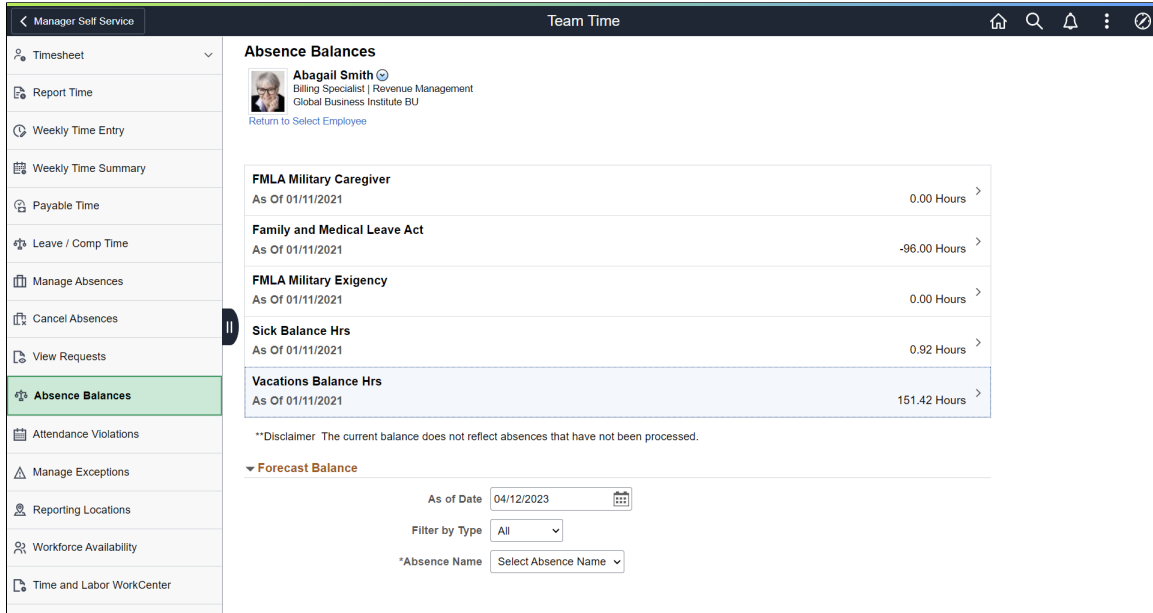

This page displays an employee’s current absence balances.

| Field or Control | Description |
|----------------------------------|--|
| Return to Select Employee | Select to return to the search result page for absence balances. |

Using the PeopleSoft Fluid User Interface to Work with Absences as an Administrator

This topic discusses how administrators use the PeopleSoft Fluid User Interface to perform absence-related transactions.

For general information about fluid pages in PeopleSoft HCM, see “Understanding PeopleSoft Fluid User Interface Homepages” (Application Fundamentals)

Pages Used to Work with Absences as an Administrator Using the PeopleSoft Fluid User Interface

| Page Name | Definition Name | Usage |
|--|--|--|
| <u>Absence Administration Tile</u> | HC_HGA_ADM_DASHBOARD_FL (cref for the tile) | Access the Absence Administration dashboard for a collection of tiles to frequently-used Absence Management administrative components. |

| Page Name | Definition Name | Usage |
|---|------------------------|---|
| <u>Absence Administration Dashboard</u> | PT_LANDINGPAGE | Access tiles for managing Administrative tasks, Processing Absences Insights, and Absence Event Insights. |
| <u>Administrative tasks Tile</u> | HC_ABSADMN_FL | Access a collection of frequently-used Absence Management administrative components. |
| <u>Absence Event Insights Tile</u> | HC_GP_ABS_RQST_FL | Select to access the Absence Event Insights that contain the collection of analytics and other information. |
| “Generate Absence Payable Time Page” (PeopleSoft Time and Labor) | TL_ABS_RUN_CNTL_FL | Process absence calculation and generate payable time for one or more calendar groups. |
| Time and Labor Exceptions Page | TL_MNG_EXCEP_NUI | View and resolve the time and labor exceptions using Fluid User Interface. For more information, see “Manage Exceptions Page” (PeopleSoft Time and Labor) |
| <u>Absence Exceptions Page</u> | HGA_PAYEE_MSG_FL | Review the exceptions (errors and warnings) generated for absence calculations. |
| Absence Event - <u>Absence Event Entry Page</u> | GP_ABS_EVENT | Enter, update, and void absences. Start the Absence Forecasting process. |
| Review Absence Balances - <u>Current Balance Page</u> | GP_ABS_CUR_BAL | View a payee’s current entitlement balances. |
| “Calculate Absence and Payroll Page” (PeopleSoft Global Payroll) | GP_RUNCTL | Enter processing instructions for a payroll process, an absence take process, or an absence entitlement process. This page is used to run both on-cycle and off-cycle payrolls. |
| “Positive Input By Calendar Page” (PeopleSoft Global Payroll) | GP_PI_GRP_ERNDED | Enter, edit, or view positive input for payees in the same pay group and calendar. |

| Page Name | Definition Name | Usage |
|---|------------------------|--|
| Results by Calendar Group - Calendar Group Results Page | GP_RSLT_RUN_SEG | View the processing statistics for an entire calendar group. This component displays the same information as the Results by Calendar component, except that it is for a calendar group rather than an individual calendar. Page includes links to other pages that display positive input, absence, and retroactive processing results. |
| Absence Analytics Dashboard | N/A | Quickly analyze absence and payroll results using a variety of pivot grid pagelets. For more information, see Using the Absence Analytics Dashboard Pagelets . |
| Off Cycle On Demand Page | GP_ONDEMAND | <p>Access the pages to:</p> <ul style="list-style-type: none"> • Create or edit an off cycle request. • Create or Edit an off cycle calendar group. • Process the off cycle calendar group. You can calculate, cancel or finalize the run from this page. <hr/> <p>Note: TL_ABS_GENPT will be triggered when calculate is run through Off Cycle On Demand page. When you click 'Calculate' on Off Cycle On Demand page, the GP_PAYAFTER will be triggered which in turn trigger the TL_ABS_GENPT process. This is also applicable for Cancel button.</p> <hr/> |
| Add Leave Transfer Recipients - Leave Transfer Recipients Page | GP_ABS_LVDN_RCP | Use this page to specify the eligible recipients for a leave transfer program. |
| Run Leave Donation Process - Run Leave Donations Page | GP_ABS_LVDN_RUNCTL | Run the Leave Transfer process to process all approved leave transfer requests. |
| Manage/Approve Leave Donations - Manage and Approve Requests Page | GP_ABS_LVDN_APPROV | Manage and approve leave donation requests. |
| Leave Donations History - View Transaction History Page | GP_ABS_LVDN_TRANS | Review leave donation transaction history. |
| Periods Page | GP_CALENDAR_PERIOD | Define a single absence period. |

| Page Name | Definition Name | Usage |
|---|------------------------|--|
| <u>Calendars - Definition Page</u> | GP_CALENDAR1 | Link together the pay group, period ID, run type ID, target calendar ID, and payee selection criteria associated with a calendar. |
| “Element Browser Page” (PeopleSoft Global Payroll) | GPSC_ELM_BRW_LFL | Browse element information for a selected country. |
| <u>Calendar Groups Page</u> | GP_CALENDAR_RUN | Define a group of calendars to process together. Calendars are processed in the order listed. |
| Absence Entitlements - <u>Absence Entitlement Name Page</u> | GP_PIN | Name the element and define basic parameters. |
| Absence Takes - <u>Absence Take Name Page</u> | GP_PIN | Name the element and define basic parameters. |
| Formulas - <u>Formula Name Page</u> | GP_PIN | Name the element and define its basic parameters. |
| Brackets - <u>Bracket Name Page</u> | GP_PIN | Name the element and define its basic parameters. |
| <u>Bracket Data Page</u> | GP_BRACKET_DATA | Update search key values and return column values for existing bracket elements. |
| Country Setup for Absence Take - <u>Entitlement Grid Page</u> | GP_ABS_SS_CNTRY1 | Select the entitlement fields that appear on the View Absence Balances page. |
| <u>Configure Country Take Setup - Absences Page</u> | GP_ABS_ELIG_SS | For a given Take element and country, define absence units (days or hours), who can submit and approve requests, what happens to cancelled requests, and whether to allow partial-day absences. You can also specify whether to display the absence reason and entitlement balances. |
| Configure Absence Forecasting - <u>Forecasting Page</u> | GP_ABS_TAKE6 | Specify which forecasting result elements to display in the Forecasting Results grid. Also specify whether to display a customized label from the HR Text Catalog as the description or the element description as defined on the Element Name page (GP_PIN). |

| Page Name | Definition Name | Usage |
|---|--|--|
| <u>Administer Extended Absence Page</u> | GP_ABS_EA_ADM | Edit or approve extended leave requests. The extended absence administrator can also use this page to check the extended absence history and view details for an extended absence. |
| <u>Request Extended Absence Page</u> | GP_ABS_EA_REQ | Request an extended absence using the defined extended absence types. Review the status of an extended leave |
| <u>Absence Event Insights Tile</u> | HC_GP_ABS_RQST_FL (this is the cref for the tile) | Access a dashboard to analyze the employee absences event data. |
| <u>Absence Event Insights Dashboard</u> | HC_GP_ABS_RQST_FL | View and analyze absence event data using Insights visualizations. |
| <u>Processed Absence Insights Tile</u> | HC_HGA_PROCESSED_EVT_FL (this is the cref for the tile) | Access a dashboard to analyze the employee processed absences data. |
| <u>Processed Absence Insights Dashboard</u> | HC_HGA_PROCESSED_ABS, HC_HGA_PI_GEN, and HC_HGA_BALANCE_TRENDS | View and analyze processed absence data using Insights visualizations. |

Absence Administration Tile

Administrators use the Absence Administration tile to access the Absence Administration dashboard for a collection of tiles to frequently-used Absence Management administrative components.

Navigation:

The **Absence Administration** tile is delivered as part of the **Workforce Administrator** homepage, but the location can change if you change the delivered home pages or if administrators personalize their home pages.

This example illustrates the Absence Administration tile.

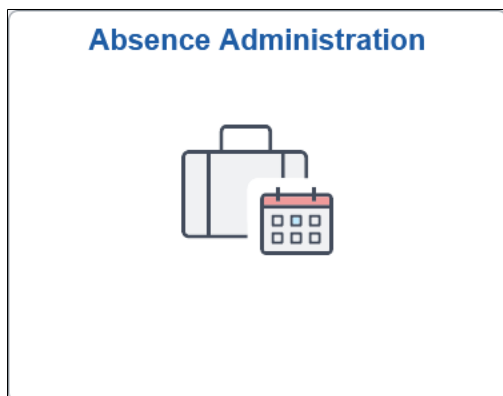

Click the Absence Administration tile to access the tile collection landing page for Administrative tasks and Event Insights tiles.

Absence Administration Dashboard

Administrators use the Absence Administration dashboard to access tiles for managing Administrative tasks, Processing Absences Insights, and Absence Event Insights.

Navigation:

Select the [Absence Administration Tile](#).

This example illustrates the Absences Administration dashboard.

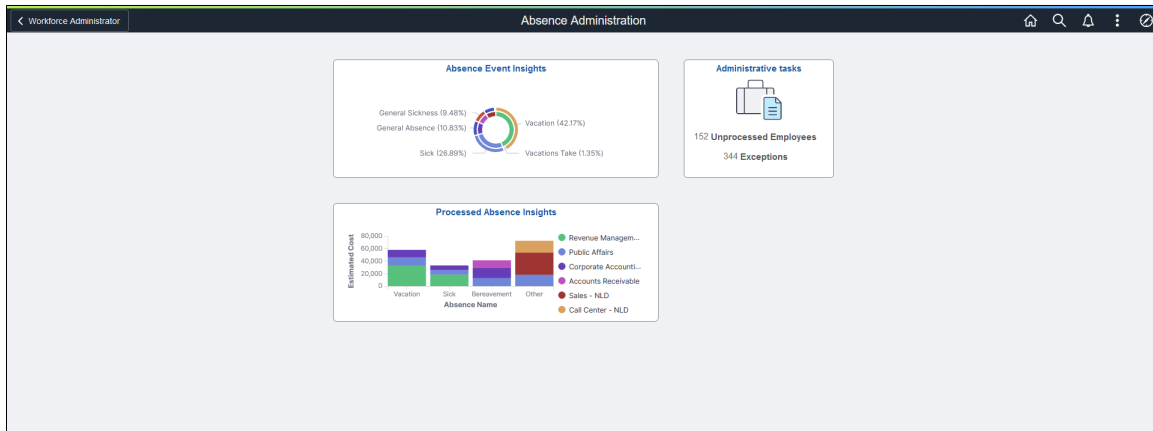

Administrative tasks Tile

Use the Administrative tasks tile to access a collection of frequently-used Absence Management administrative components.

Navigation:

The **Administrative tasks** tile is part of the [Absence Administration Dashboard](#) landing page.

This example illustrates the fields and controls on the Administrative tasks tile.



Select **Administrative tasks** tile to access Absence Administration application start page.

| Field or Control | Description |
|------------------------------|--|
| Unprocessed Employees | Displays the number of employees for whom approved absence has not been processed. |
| Exceptions | Displays sum of the errors and warnings from absence and TL exceptions. |

Note: Unprocessed Employee Count/Exceptions Count is displayed only if the **Generate Absence Payable Time** check box is selected on the “Configurations Page” (PeopleSoft Time and Labor).

Click the tile to access the Absence Administration application start page.

This example illustrates the Absence Administration Start page.

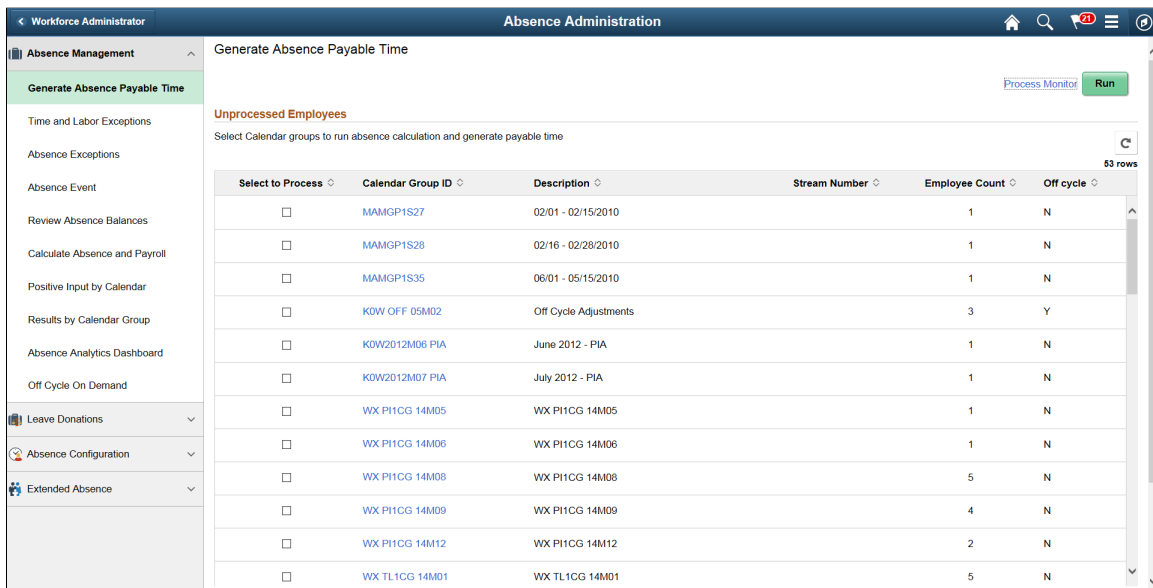

This application start page is a navigation collection that enables administrators to access frequently-used Absence Management components from one location. The left panel of this page lists the components collected under four categories:

- Absence Management
- Leave Donations
- Absence Configuration
- Extended Absence

The right panel displays the component selected in the left panel.

Absence Exceptions Page

Use the Absence Exceptions page (HGA_PAYEE_MSG_FL) to view the details of the errors and warnings for absence calculations.

Navigation:

Click the Absence Administration tile on the Workforce Administrator fluid home page and select Absence Exceptions from the Absence Management navigation collection.

Click the Absence Calculations Tile from Exceptions section on the Generate Absence Payable Time page.

This example illustrates the Absence Exceptions Page.

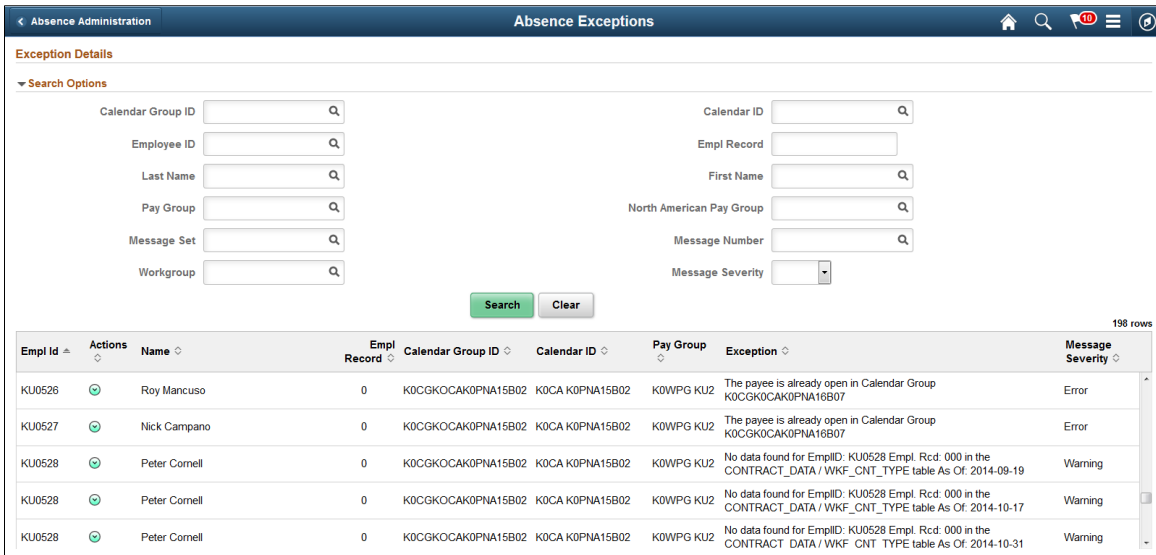

| Field or Control | Description |
|-------------------------|---|
| Search Options | Use the search option to filter the exception details using Calendar Group Id, Calendar Id, Employee Id, Employee Record, Name, Pay Group, Message Set, Message Number, Workgroup and Severity. |
| Actions | Use the related actions to access the following pages: <ul style="list-style-type: none"> • View Results by Calendar Group • View Messages • View Status • Review Triggers • Create and Maintain Absence • Approve Absence • Administer Extended Absence • Calculate Absence and Payroll • Review Absence Balances |

Absence Event Insights Tile

The administrator can use the Absence Event Insights tile to access [Absence Event Insights Dashboard](#) and analyze the employee absences event data.

This example illustrates the fields and controls on the Absence Event Insights tile.

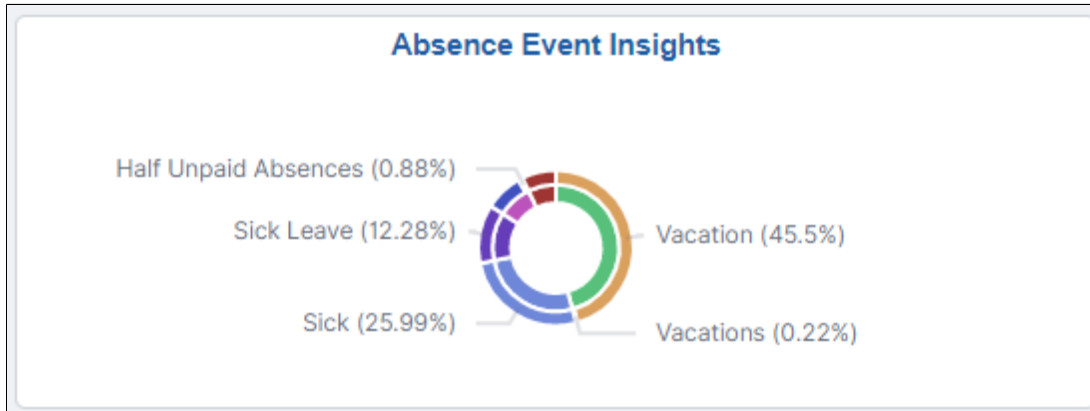

Based on user privileges, administrators can access the visualizations delivered on the Absence Event Insights dashboard.

The absence event data is the data submitted by employee, manager or administrator.

The Absence Event Insights Analytics dashboard is built on the PeopleSoft Insights platform, which relies on an underlying analytics engine and search engine. Absence Event data that is visible on the dashboard comes from the HC_GP_ABS_RQST search index.

For information on Insights, see PeopleTools *Search Technology*, “Monitoring PeopleSoft Search Framework and OpenSearch” and “Working with Insights Dashboards for PeopleSoft Application Data” documentation.

These videos provide an overview of the Insights feature:

Video: [Insights with PeopleSoft](#)

Video: [PeopleSoft HCM Insights](#)

Note: The absence counts are count by events and not the days of absences. The canceled absences are excluded from the absence type and name visualization.

Deploying the Absence Event Insights Analytics

Before administrators can access the Absence Event Insights data in PeopleSoft Insights, the following steps should be performed:

1. Deploy the *HC_GP_ABS_RQST* (Absence Events data) index.

(PeopleTools > Search Framework > Search Admin Activity Guide > Administration > Deploy/Delete Object)

2. Build the *HC_GP_ABS_RQST* search index.

(PeopleTools > Search Framework > Search Admin Activity Guide > Administration > Schedule Search Index)

3. Deploy the *Absence Event Insight Tile* and *Absence Event Insights* dashboard.

(PeopleTools > Search Framework > Administration > Deploy Dashboards to Insights)

Note: The full index must be run before the dashboard can be deployed.

4. Assign *Absence Insights Administrator* roles to administrators to access and view Absence Events Insight Analytics visualizations.

Absence Event Insights Dashboard

PeopleSoft Absence Analytics Event Insights dashboard provides administrators the ability to view and analyze absence event data using Insights visualizations.

Navigation:

Workforce Administrator home page > Absence Administration tile > Absence Event Insights tile

This video provides an overview of the Absence Management Insights feature:

Video: [Image Highlights, PeopleSoft HCM Update Image 38: Absence Event Insights Dashboard](#)

This example illustrates the fields and controls on the Absence Event Insights dashboard. You can find definitions for the fields and controls later on this page.

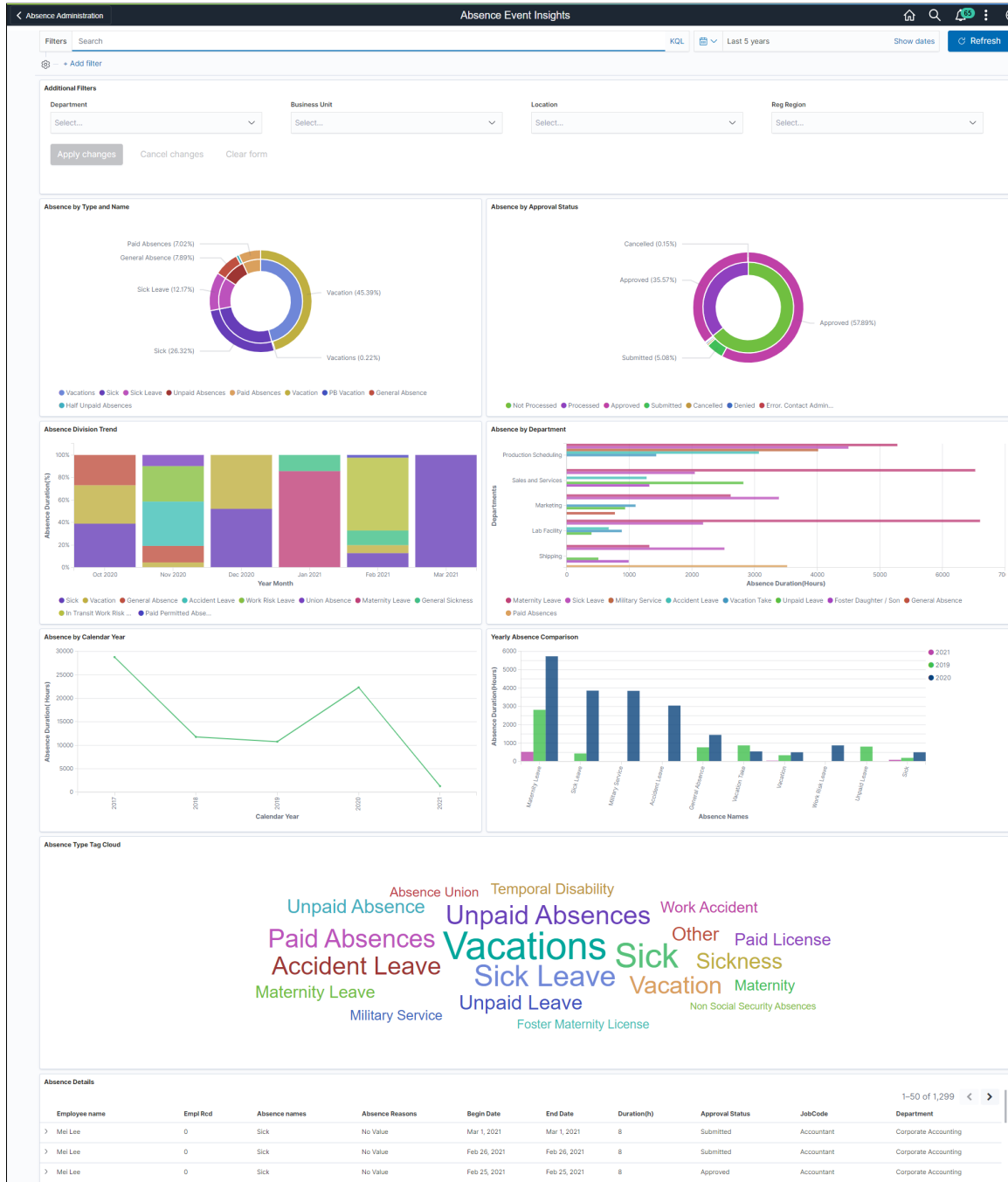



The different visualizations can be used by the administrator to:

- Work with managers and first level administrators to manage absenteeism in their realm of work.
- Take corrective actions before processing absences.

Common Elements and Controls

Note: Filtering options apply to all visualizations, which allows administrators to drill down on all the charts at once.

| Field or Control | Description |
|--|--|
| Open in Insights | This link appears only for users with role <i>Absence Insights Administrator</i> . |
| Filters search field  , Change all filters icon (Change all filters), and + Add filter | <p>Enter criteria to filter data on the visualizations. You can add filters in a number of ways:</p> <ul style="list-style-type: none"> • Enter them manually in the Filters search field. • Use the + Add filter link to create filters using fields, operators and field values. • Select a chart item from a visualization. • Use the filter options in the Absence Details grid to add or exclude items. • Use the legend to add or exclude items. |
|  Calendar icon (Calendar) or Show dates | Click to select a different time period for the analytics. You can enter it manually, or choose from commonly used date ranges provided by the system or from the recently used selections. When a new period is selected, all visualizations are refreshed automatically to reflect that change. If you have selected a commonly used date range, for example, <i>This month</i> , or <i>Week to date</i> , click the Show dates link to view the approximate date period in relation to the current date. For example, the current date is November 1 and the selected date range is <i>Year to date</i> . Clicking the Show dates link displays ~ <i>10 months ago</i> —> now, which indicates that the selected date range started from approximately 10 months ago and ends on the current date. |

Additional Filters

This example illustrates the fields and controls on the Additional Filters. You can find definitions for the fields and controls later on this page.

The screenshot shows the 'Absence Event Insights' interface. At the top, there is a search bar and a date range set to 'Last 5 years'. Below this is the 'Additional Filters' section, which contains four dropdown menus: 'Department', 'Business Unit', 'Location', and 'Reg Region'. Each dropdown menu has a 'Select...' placeholder. At the bottom of the filter section, there are three buttons: 'Apply changes', 'Cancel changes', and 'Clear form'.

Note: By default, the data populates for the past five years.

Additional Filters allow you to select the following filters:

- Department
- Business Unit
- Location
- Regulatory Region

Absence by Type and Name Visualization

Use this visualization to view the absences by type and name for the selected period in an organization.

This example illustrates the fields and controls on the Absence by Type and Name.

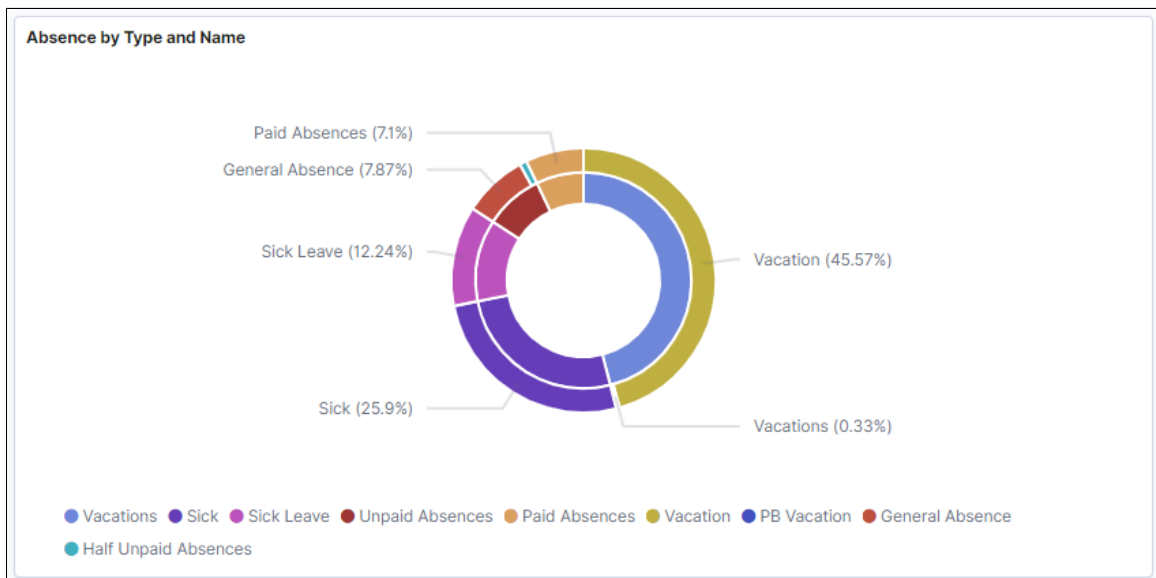

The double doughnut visualization represents count of different absence within each absence type used by the organization. The inner doughnut is the absence type and outer doughnut represents the absences names within each type.

Absence by Approval Status Visualization

Use this visualization to view the absences by approval status for the selected period in an organization. This example illustrates the fields and controls on the Absence by Approval Status.

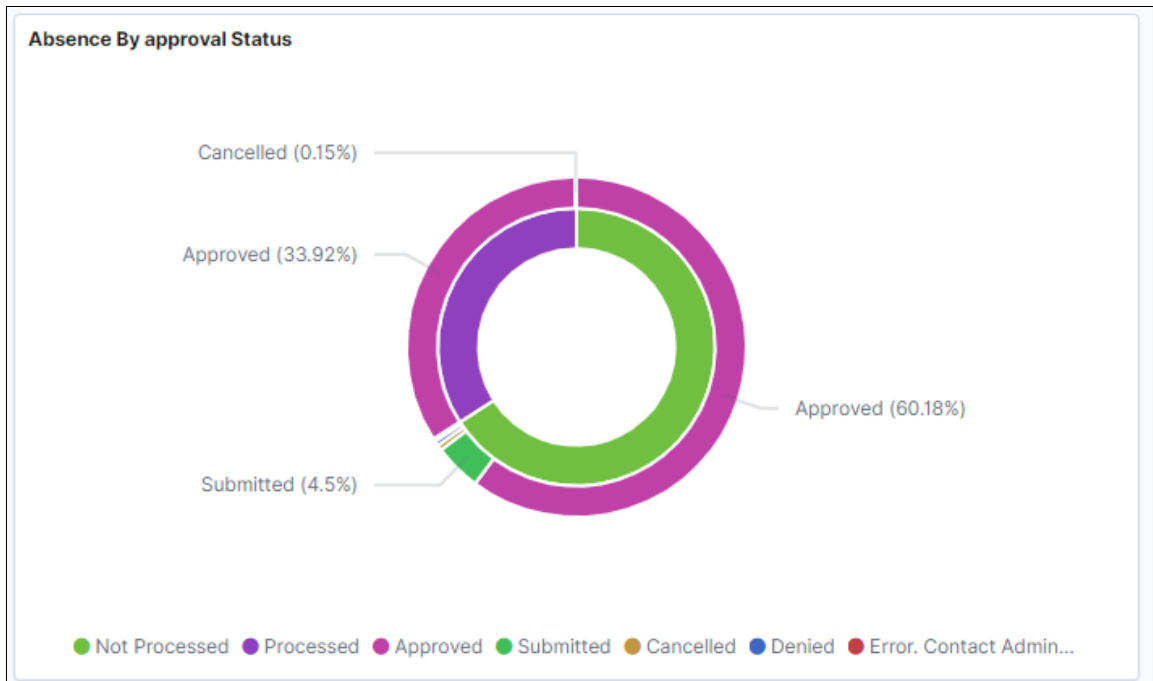

This visualization represents the absences on the basis of approval status. Here, the inner doughnut is the absence processed and unprocessed status and the outer one is the absence approval status within each of it.

Absence Division Trend Visualization

Use this visualization to view the absence division trend for the selected period. This example illustrates the fields and controls on the Absence Division Trend.

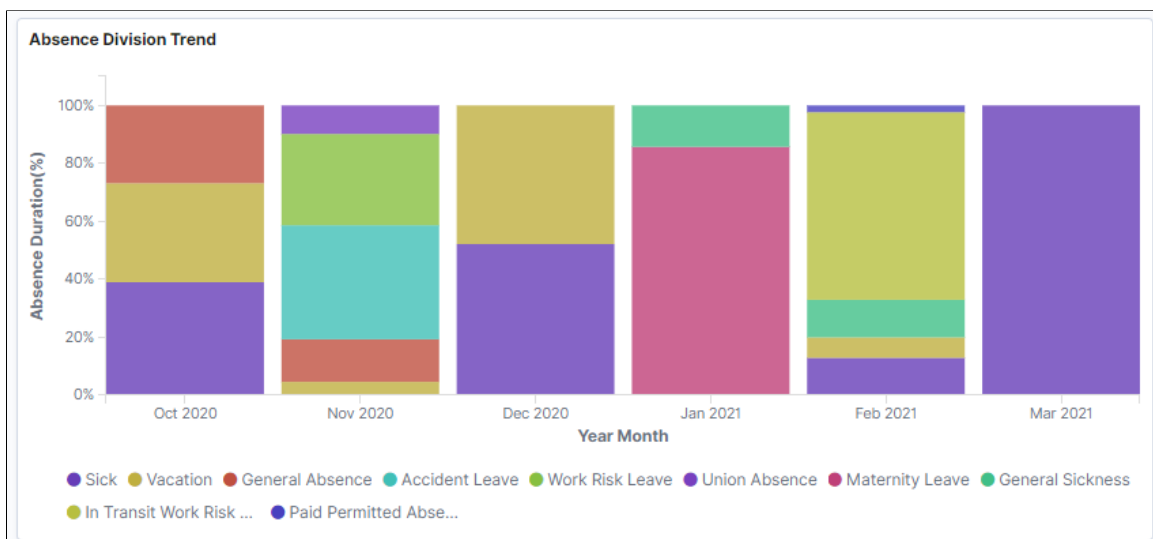

The bar chart shows the percentile information of each absences and represents the monthly trend of absence submissions. The default setting is for the last six month of data.

Note: If the Administrators have access rights to update the design of visualization, they can do it in the Insights Designer mode.

Absence by Department Visualization

Use this visualization to view the absence trends by department for the selected period.

This example illustrates the fields and controls on the Absence by Department.

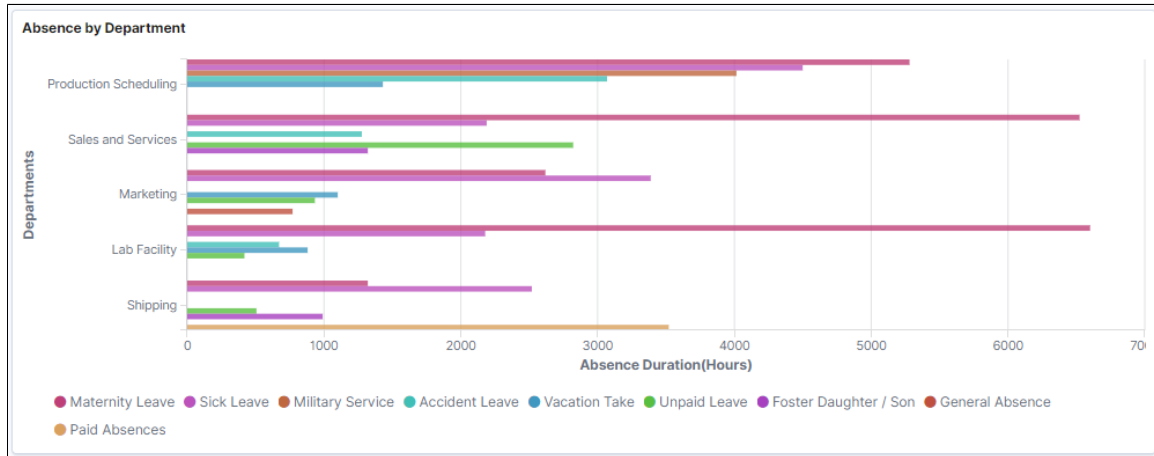

This visualization represents absence duration by departments and shows how the absences are submitted across departments in terms of absence duration. The default visualization is set for five departments.

Absence by Calendar Year Visualization

Use this visualization to view the absence by calendar year for the selected period.

This example illustrates the fields and controls on the Absence by Calendar year.



Line diagram which represents the totals or cumulative of absence duration in hours. You can check the absenteeism by year on year. The default visualization is set for five years.

Yearly Absence Comparison Visualization

Use this visualization to view the absence duration trends in hours by its names for the selected period.

This example illustrates the fields and controls on the Yearly Absence Comparison.

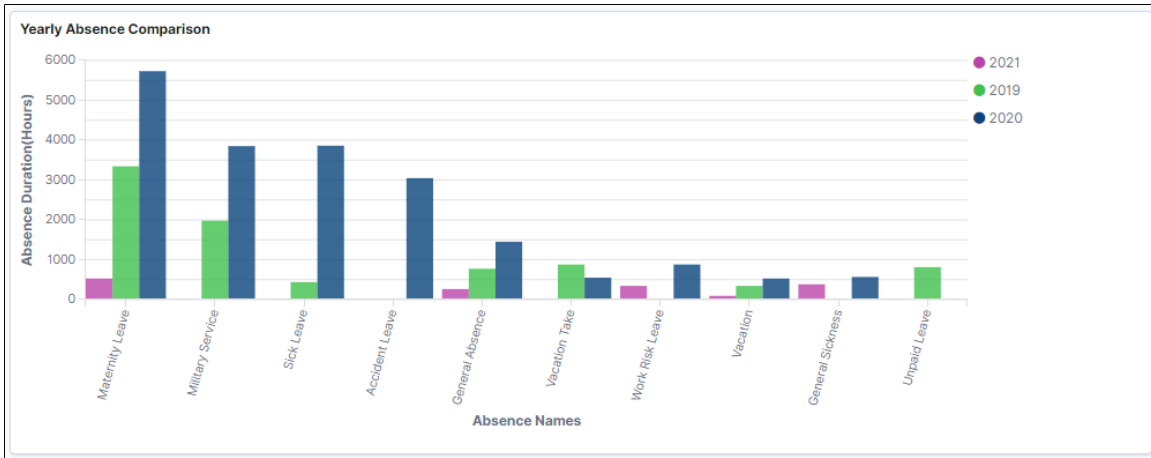

The bar chart with different color shows the year-on-year trend by absence name. This is on the basis of the timeline selected. The default is set to three years of calendar year series.

Absence Type Tag Cloud

The Administrator can view the information regarding a particular Absence and on selecting the absence name, it gives more information in different analytics.

This example illustrates the fields and controls on the Absence Type Tag Cloud.

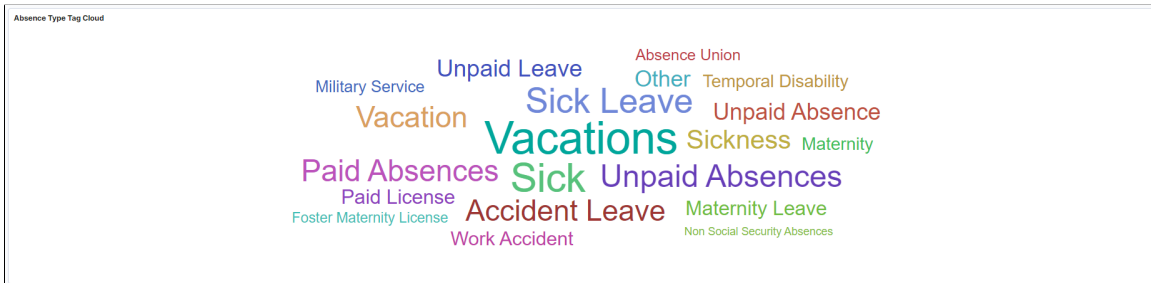

The absence types labels size appear in the descending order of most applied, with the size of the absence type label with most applied absences displayed as the biggest. In this case, it is Vacation. The Administrator can use this information as the immediate filter, much more than the filter applied. On selecting one particular absence type refreshes the entire dashboard.

Absence Details

This example illustrates the fields and controls on the Absence Details.

| Employee Name | Empl Record | Absence Name | Absence Reason | Begin Date | End Date | Duration(h) | Approval Status | Job Code | Department | Transaction Number |
|----------------------|-------------|--------------------------|-------------------|--------------|--------------|-------------|-----------------|--------------------|--------------------------|--------------------|
| Vicki Zim | 0 | Vacation | Personal Time Off | Jul 6, 2021 | Jul 6, 2021 | 8 | Approved | Accountant | Corporate Accounting | 3018 |
| Christelle Stevenson | 0 | Sick | Flu | Jul 5, 2021 | Jul 5, 2021 | 0 | Approved | Manager-Accounting | Accounts Receivable | 3016 |
| Francisco Benitez | 0 | Vacations Take | No Value | Nov 9, 2020 | Nov 19, 2020 | 72 | Approved | Programmer | Research and Development | 3013 |
| Francisco Fonseca | 0 | Vacations Take | No Value | Sep 14, 2020 | Oct 1, 2020 | 112 | Approved | Programmer | Research and Development | 3012 |
| Francisco Valdez | 0 | Vacations Take | No Value | May 4, 2020 | Jun 1, 2020 | 168 | Approved | Programmer | Research and Development | 3011 |
| Francisco Mota | 0 | Vacations Take | No Value | Sep 14, 2020 | Sep 18, 2020 | 40 | Approved | Programmer | Research and Development | 3010 |
| Francisco Mota | 0 | Paid Permitted Absence | No Value | Jun 15, 2020 | Jun 23, 2020 | 56 | Approved | Programmer | Research and Development | 3009 |
| Francisco Mota | 0 | General Sickness | No Value | Jul 13, 2020 | Jul 19, 2020 | 88 | Approved | Programmer | Research and Development | 3008 |
| Francisco Mota | 0 | Work Risk Leave | No Value | Oct 19, 2020 | Oct 25, 2020 | 88 | Approved | Programmer | Research and Development | 3007 |
| Francisco Garcia | 0 | Unpaid Permitted Absence | No Value | Oct 19, 2020 | Nov 27, 2020 | 240 | Approved | Programmer | Research and Development | 3006 |

Absence details is the customizable list of information presented based on user needs.

Processed Absence Insights Tile

The administrator can use the Processed Absence Insights tile to access [Processed Absence Insights Dashboard](#) and analyze the employee processed absences data.

This example illustrates the fields and controls on the Processed Absence Insights tile.

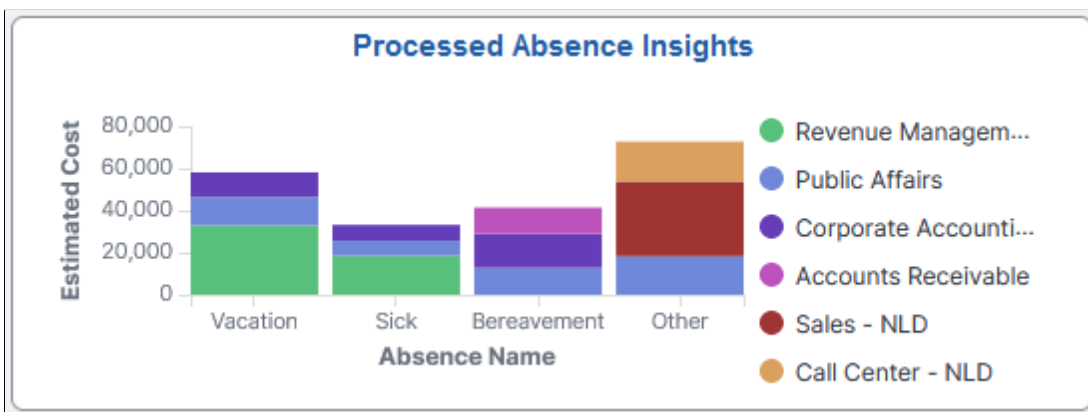

Based on user privileges, administrators can access the visualizations delivered on the Processed Absence Insights dashboard.

The processed absence data is the data submitted by employee, manager or administrator.

For information on Insights, see PeopleTools *Search Technology*, “Monitoring PeopleSoft Search Framework and OpenSearch” and “Working with Insights Dashboards for PeopleSoft Application Data” documentation.

These videos provide an overview of the Insights feature:

Video: [Insights with PeopleSoft](#)

Video: [PeopleSoft HCM Insights](#)

Deploying the Processed Absence Insights Analytics

Before administrators can access the Processed Absence Insights data in Insights, the following steps should be performed:

1. Deploy the *HC_HGA_PROCESSED_ABS* (Processed Absence data) *HC_HGA_PI_GEN* (Absence Generated Positive Input) and *HC_HGA_BALANCE_TRENDS* (Absence Balance Trends) index.

(PeopleTools > Search Framework > Search Admin Activity Guide > Administration > Deploy/Delete Object)

2. Deploy the *Processed Absence Insights Tile* and *Processed Absence Insights* dashboard.

(PeopleTools > Search Framework > Administration > Deploy Dashboards to Insights)

Note: The full index must be run before the dashboard can be deployed.

3. Assign *Absence Insights Administrator* roles to administrators to access and view Processed Absence Insight Analytics visualizations.

Processed Absence Insights Dashboard

Processed Absence Insights dashboard provides administrators the ability to view and analyze processed absence data using Insights visualizations.

Navigation:

Workforce Administrator home page > Absence Administration tile > Processed Absence Insights tile

Note: If the Administrators have access rights to update the design of visualization, they can do it in the Insights Designer mode.

This example illustrates the fields and controls on the Processed Absence Insights dashboard. You can find definitions for the fields and controls later on this page

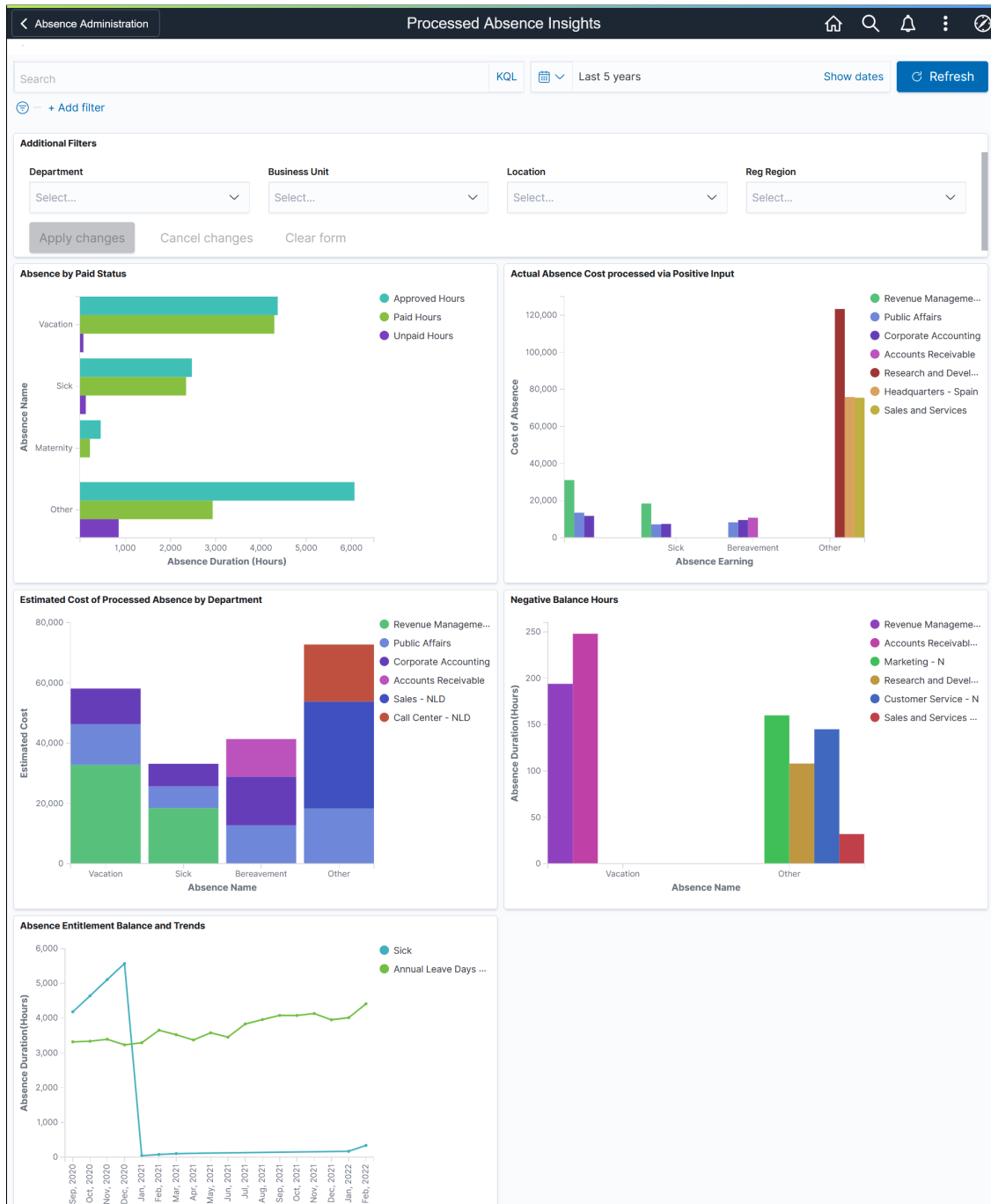

The different visualizations can be used by Administrator to:

- View the processed absence data for the employee.
- Work with HR, Finance and first level administrators to understand/ manage absence cost, productivity and liabilities.

Additional Filters

This example illustrates the fields and controls on the Additional Filters. You can find definitions for the fields and controls later on this page.

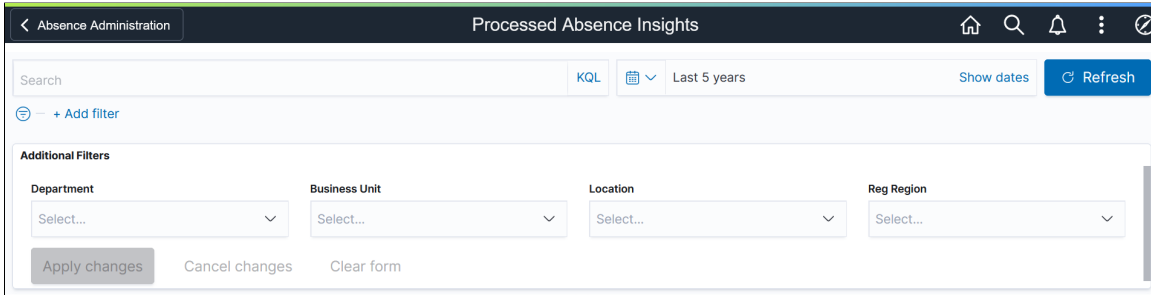

Note: By default, the data populates for the past five years.

Additional Filters allow you to select the following filters:

- Department
- Business Unit
- Location
- Regulatory Region

Absence by Paid Status Visualization

Use this visualization to view the absences by paid status for the selected period in an organization.

This example illustrates the fields and controls on the Absence by Paid Status Visualization.

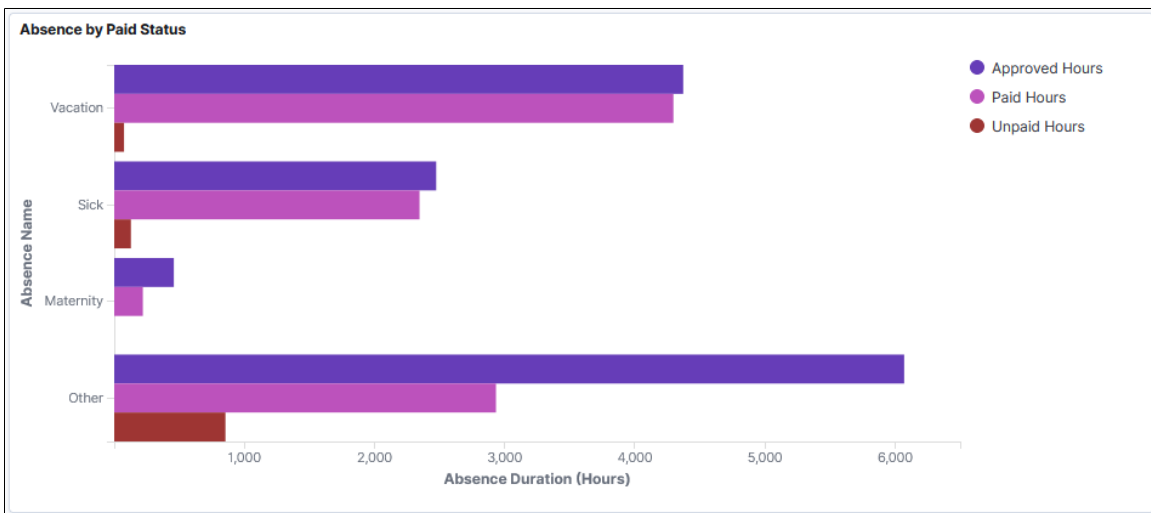

This visualization represents the total hours of approved absences and how many of those hours were paid versus unpaid. Each absence type used by the organization will be represented.

Actual Absence Cost processed via Positive Input

Use this visualization to view the cost of generated positive input by department for different absence types.

This example illustrates the fields and controls on the Actual Absence Cost processed via Positive Input Visualization.



The bar chart shows the cost of positive inputs for each absence types in each departments.

Estimated Cost of Processed Absence by Department

Use this visualization to view the cost of processed absences by department for the selected period in an organization.

This example illustrates the fields and controls on the Estimated Cost of Processed Absence by Department.

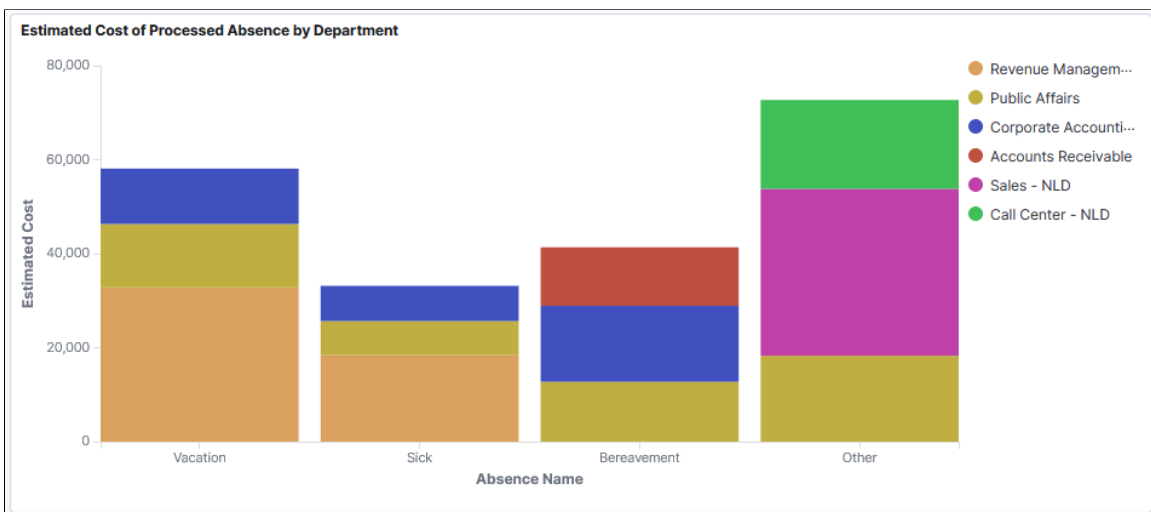

The bar chart represents the cost of different absences by departments.

Negative Balance Hours Visualization

Use this visualization to view the number of negative absence balance hours for each absence type for the selected period.

This example illustrates the fields and controls on the Negative Balance Hours Visualization.



This visualization represents negative absence balances in hours for each absence type by department. The default visualization is set for six departments.

Absence Entitlement Balance and Trends Visualization

Use this visualization to view the trend of absence balances by absence type and month.

This example illustrates the fields and controls on the Absence Entitlement Balance and Trends Visualization.



Line diagram which represents the entitlement balances by month.

Approving Absence Transactions Using Fluid Approvals

This topic describes how to approve absence transactions using Fluid Approvals.

See also “Using PeopleSoft Fluid User Interface Self-Service Approval Transactions” (Application Fundamentals).

Pages Used to Approve Absence Transactions Using Fluid Approvals

| <i>Page Name</i> | <i>Definition Name</i> | <i>Usage</i> |
|---|------------------------|---|
| Absence Approvals Tile | EOAWMA_USER_FL | Tap to access the Absence Approvals page. |
| <u>Approvals Navigation Collection</u> | EOAWMA_MAIN_FL | Select the navigation collection of the left panel to access: <ul style="list-style-type: none"> • Absence Request • Cancel Absence • Extended Absences • Leave Donations |
| <u>Pending Approvals - Absence Request Page</u> | EOAWMA_TXNHDTL_FL | Approve an absence request. |
| <u>Additional Information Page</u> | HGA_FA_ADD_INFO_FL | Review additional absence request details. |
| <u>Pending Approvals - Cancel Absence Page</u> | EOAWMA_TXNHDTL_FL | Approve an absence cancelation. |
| <u>Pending Approvals — Attachment Page</u> | HGA_ATTACH_FL_SCF | Displays the attachment for request absences/cancel absences. |
| <u>Pending Approvals - Extended Absence</u> | EOAWMA_TXNHDTL_FL | Approve an extended absences. |
| <u>Attachments and Notes Page</u> | HGA_EX_ABS_ATT_SCF | View attachments and notes related to extended absences. |
| <u>Additional Information Page</u> | HGA_FA_ADD_INFO_FL | Additional information for extended absence details. |
| <u>Approval Chain</u> | EOAWMA_APPC_SCF | View the information about approvers associated with the request and approval status. |

| Page Name | Definition Name | Usage |
|--|------------------------|--------------------------------------|
| Pending Approvals — Leave Donations Page | EOAWMA_MAIN_FL | Approve an absence donation request. |

Approvals Navigation Collection

Use the Approval Navigation Collection (EOAWMA_MAIN_FL) to select the approval types from left panel..

Navigation:

On the Manager Self-Service home page, click the Approvals tile to access the Pending Approvals page.

You can access the following absence approval transactions from left panel:

- [Pending Approvals - Absence Request Page](#)
- [Pending Approvals - Cancel Absence Page](#)
- [Pending Approvals - Extended Absence](#)

This example illustrates the fields and controls on the Pending Approvals page.

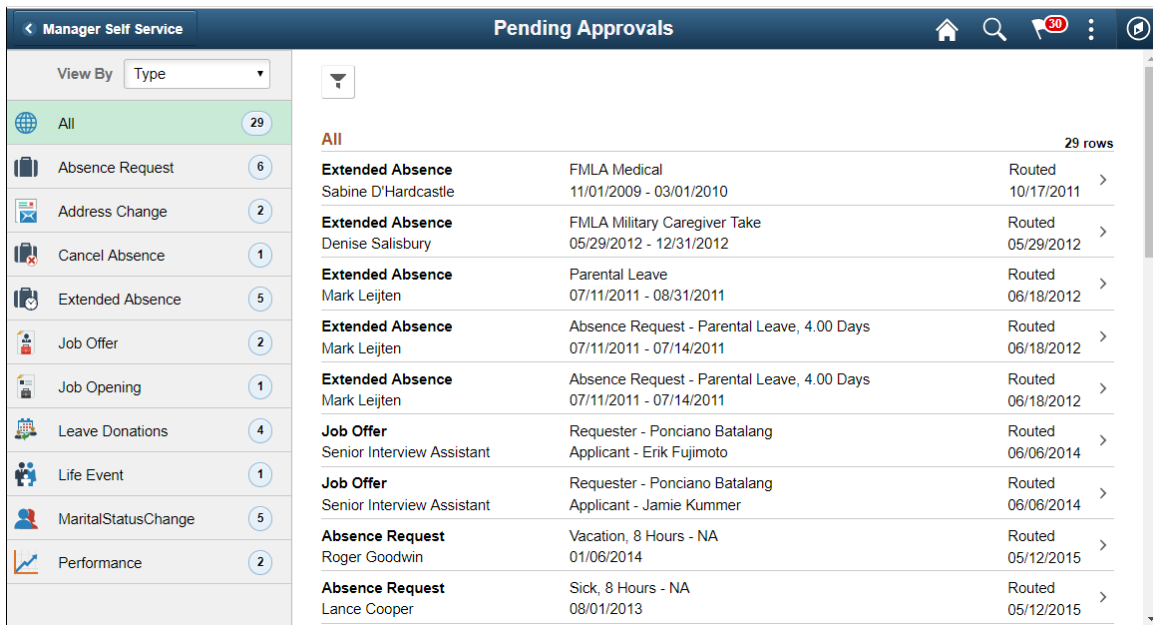

Pending Approvals - Absence Request Page

Use the Pending Approvals - Absence Request page (EOAWMA_TXNHDTL_FL) to approve an absence request.

Navigation:

On the Manager Self-Service home page, click the Approvals tile to access the Pending Approvals page. Then click an absence request entry on the Pending Approvals page.

This example illustrates the fields and controls on the Pending Approvals - Absence Request page.

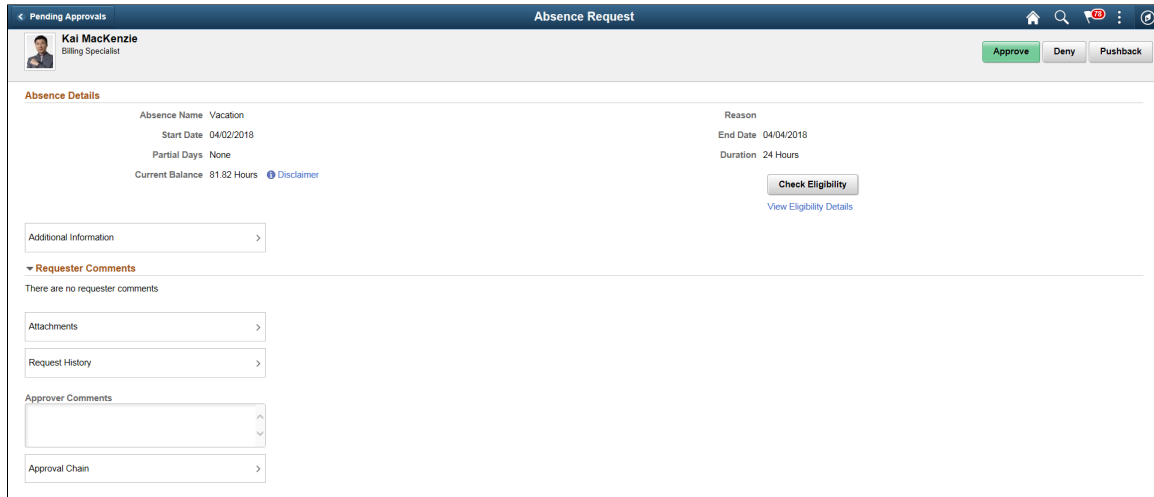

Approval Options

The approval options on this page are common to all fluid approval transactions, as described in the documentation for the “Pending Approvals - <Transaction Details> Page” (Application Fundamentals).

| Field or Control | Description |
|------------------------------------|---|
| Approve, Deny, and Pushback | Use these buttons to take action on the requested approval. |

Absence Details

The absence request fields on this page provide information about the transaction you are being asked to approve. Fields correspond to the same-named fields on the [Extended Absence Request Page](#).

| Field or Control | Description |
|---------------------------------|---|
| Check Eligibility | Click Check Eligibility to see if the employee is eligible for the absence request. |
| View Eligibility Details | Click the View Eligibility Details link to view the absence eligibility details of the selected employee. |

| Field or Control | Description |
|-------------------------------|--|
| Additional Information | Click this link to access the Additional Information Page , where you can review additional absence request details. |

| Field or Control | Description |
|---------------------------|--|
| Requester Comments | Displays any comments entered by the absence requester. |
| Attachments | Click the item to open the <i>Attachments</i> page. Using this page, you can view and download the files that the requester attached to the request. |

This example illustrates the Attachments page.

The screenshot shows a window titled "Attachments" with a close button (x). Below the title bar, the word "Attachments" is displayed. A table with 5 columns is shown, with a "1 row" indicator on the right. The columns are: Attachments (with a dropdown arrow), Description (with a dropdown arrow), Attached By (with a dropdown arrow), Attached (with a dropdown arrow), and Status (with a dropdown arrow). The data row contains: [ATT_SETUP_IMP.txt](#), ATT_SETUP_IMP.txt, Mei Lee, 02/24/18 12:23:55 AM, and Active.

| Attachments | Description | Attached By | Attached | Status |
|-----------------------------------|-------------------|-------------|----------------------|--------|
| ATT_SETUP_IMP.txt | ATT_SETUP_IMP.txt | Mei Lee | 02/24/18 12:23:55 AM | Active |

Note: Attachments are available on this page only if requestor has included attachments when requesting an absence.

| Field or Control | Description |
|--------------------------|--|
| Request History | Click Request History to view the transaction history for this absence request. |
| Approver Comments | Enter any comments related to the approval action you take. |
| Approval Chain | Click this item to open the Approval Chain page, where you can review information about all approvers for the transaction. |

Additional Information Page

Use the Additional Details page (HGA_FA_ADD_INFO_FL) to review additional absence request details.

Navigation:

Click the **Additional Details** item on the Pending Approvals - Absence Request page.

This example illustrates the fields and controls on the Additional Details page.

Additional Information x

| | |
|--|-------------------------------|
| Emergency Contact JANE JONES | Phone Number 555123456 |
| Earliest Return Date 11/24/2016 | |

The fields displayed on this page correspond to the user fields defined on the [Configure Country Take Setup - User Fields Page](#).

Pending Approvals - Cancel Absence Page

Use the Pending Approvals - Cancel Absence page (EOAWMA_TXNHDTL_FL) to approve an absence request.

Navigation:

On the Manager Self-Service home page, click the Approvals tile to access the Pending Approvals page. Then click a cancel absence entry on the Pending Approvals page.

This example illustrates the fields and controls on the Pending Approvals - Cancel Absence page.

Pending Approvals
Cancel Absence

Daryl Reese
Financial Analyst

Approve
Deny

Absence Details

| | |
|--------------|------------|
| Absence Name | Sick |
| Reason | |
| Start Date | 05/22/2018 |
| End Date | 05/22/2018 |
| Duration | 8 Hours |
| Status | Approved |
| Comments | |

Cancelation Details

| | |
|---------------|-----------|
| Cancel Status | Submitted |
| Reason | |
| Comments | |

Attachments >

Request History >

Approver Comments

Approval Chain >

Approval Options

The approval options on this page are common to all fluid approval transactions, as described in the documentation for the “Pending Approvals - <Transaction Details> Page” (Application Fundamentals).

| Field or Control | Description |
|--------------------------|---|
| Approve and Deny | Use these buttons to take action on the requested approval. |
| Attachments | Select to open Pending Approvals — Attachment Page where you can see attachments added as part of request absences and cancelling the same request. |
| Request History | Click Request History link to view the transaction history for this absence request. |
| Approver Comments | Enter any comments related to the approval action you take. |
| Approval Chain | Click this item to open the Approval Chain page, where you can review information about all approvers for the transaction. |

Absence Details

The absence request fields on this page provide information about the transaction you are being asked to approve. Fields correspond to the same-named fields on the [Extended Absence Request Page](#).

Cancellation Details

The absence cancellation fields on this page provide information about the transaction you are being asked to approve. Fields correspond to the same-named fields on the [Cancel Absences Page](#).

Pending Approvals — Attachment Page

Use the Pending Approvals-Attachment (HGA_ATTACH_FL_SCF) page to view the attachment submitted for absences.

This example illustrates the fields and controls on the Pending Approvals-Attachment page.

The screenshot displays the 'Cancel Absence' page in the PeopleSoft Fluid User Interface. At the top, the user profile for Daryl Reese (Financial Analyst) is visible, along with 'Approve' and 'Deny' buttons. The main content area is titled 'Absence Details' and shows 'Absence Name Sick'. A modal window titled 'Attachments' is open, displaying a table with two rows of attachment information. Below the table, there are sections for 'Request History' and 'Approver Comments'.

| Attachments | Description | Attached By | Attached | Status |
|--------------------------------------|---------------------------|-------------|----------------------|--------|
| Absence_request.docx | Absence_request.docx | Daryl Reese | 06/06/18 10:48:01 PM | Active |
| Cancel_Absence.docx | Request to cancel Absence | Daryl Reese | 06/06/18 10:48:01 PM | Active |

This example illustrates the fields and controls on the Pending Approvals-Attachment page using a smartphone.

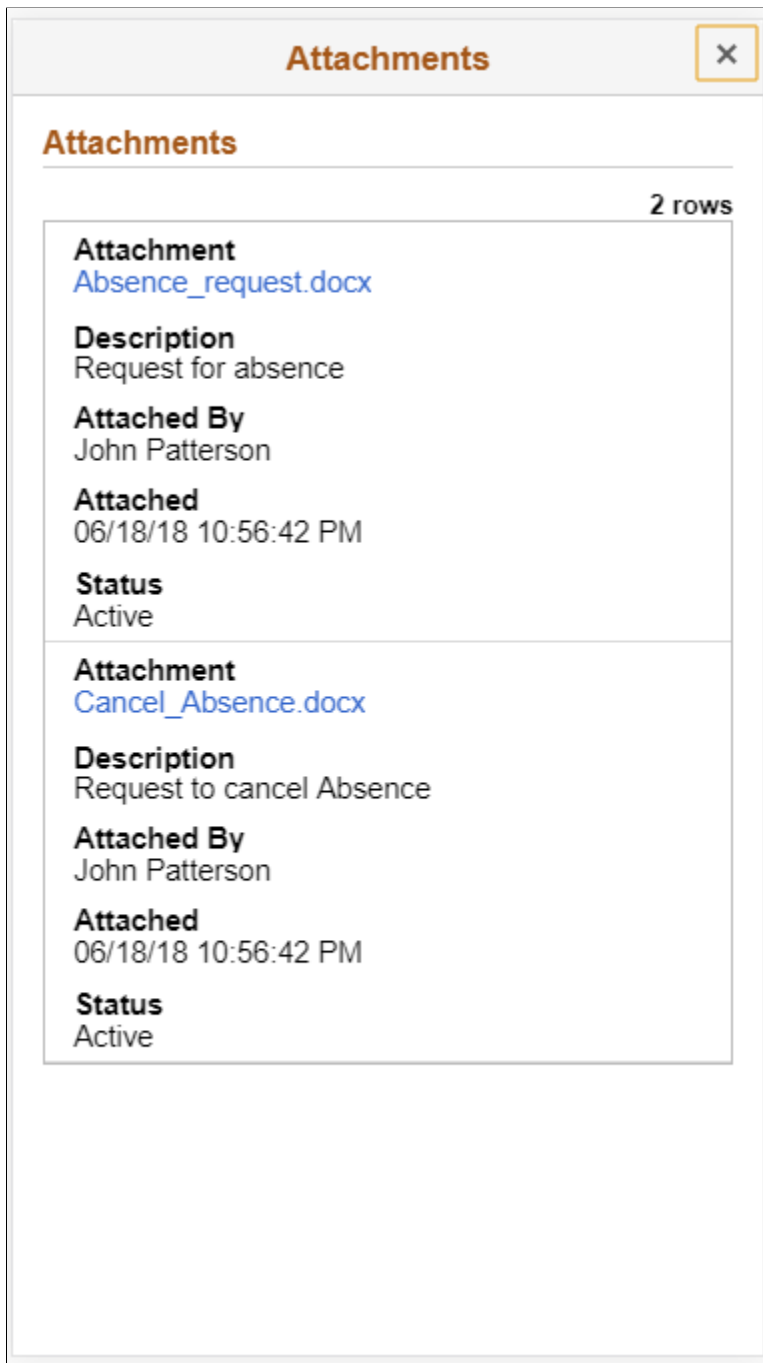

Pending Approvals - Extended Absence

Use the Pending Approvals - Extended Absence (EOAWMA_TXNHDTL_FL) page to approve an extended absence request.

Navigation:

On the Manager Self-Service home page, click the Approvals tile to access the Extended absence. On the left pane, you can see the Extended Absence listing.

Select the chevron towards the right side of an extended absence listing to access Pending Approval — Extended Absence page

The following video provides an overview of Fluid Approval Extended Absence.

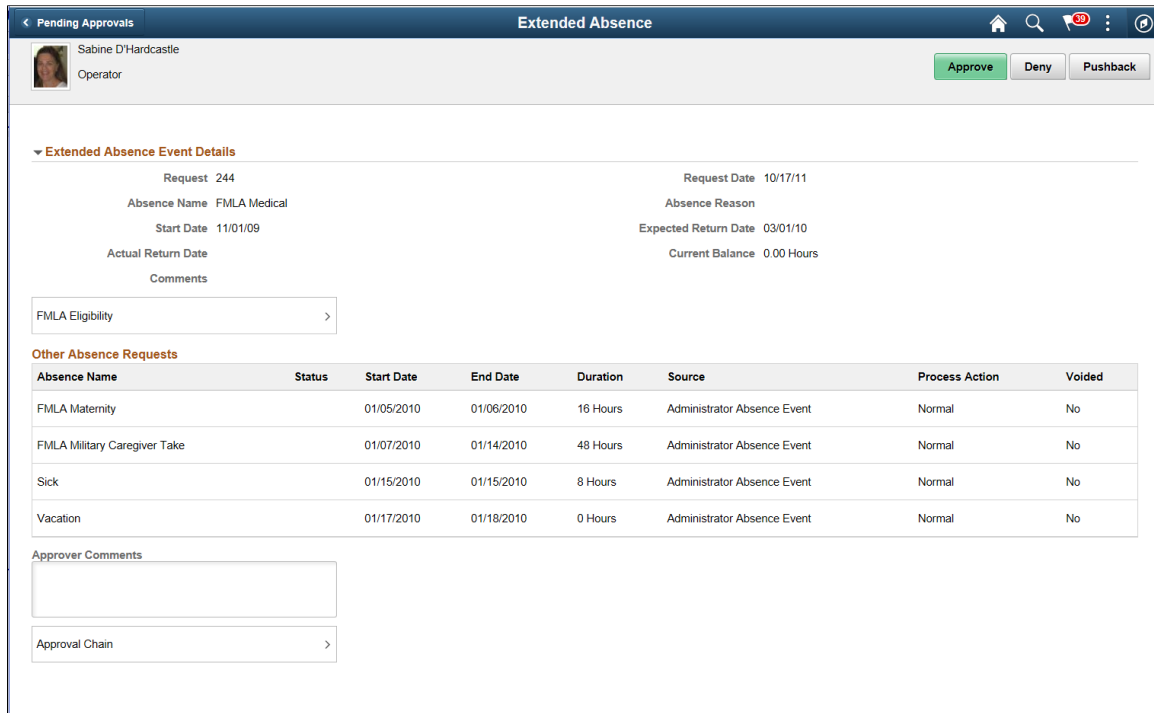

Video: [Image Highlights, PeopleSoft HCM Update Image 29: Fluid Approval Extended Absence.](#)

This example illustrates the fields and controls on the Pending Approvals - Extended Absence page which displays different types of absence requests under *Other Absence Requests* section.

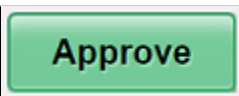

Approval Options

The approval options on this page are common to all fluid approval transactions:

| Field or Control | Description |
|---|---|
|  and  | Use these buttons to take action on the requested approval. |
|  | Click this item to revert the approval. |
| Approver Comments | Field for approvers to provide comments, if any. |

| Field or Control | Description |
|-------------------------|---|
| Approval Chain | Click to access the Approval Chain to view the information about approvers associated with the request and approval status. |

This feature has two types of approvals:

- Extended Absence Event.
- Child absence added once extended absence event is approved.

This example illustrates the fields and controls on the Pending Approvals — Extended Absence Event page.

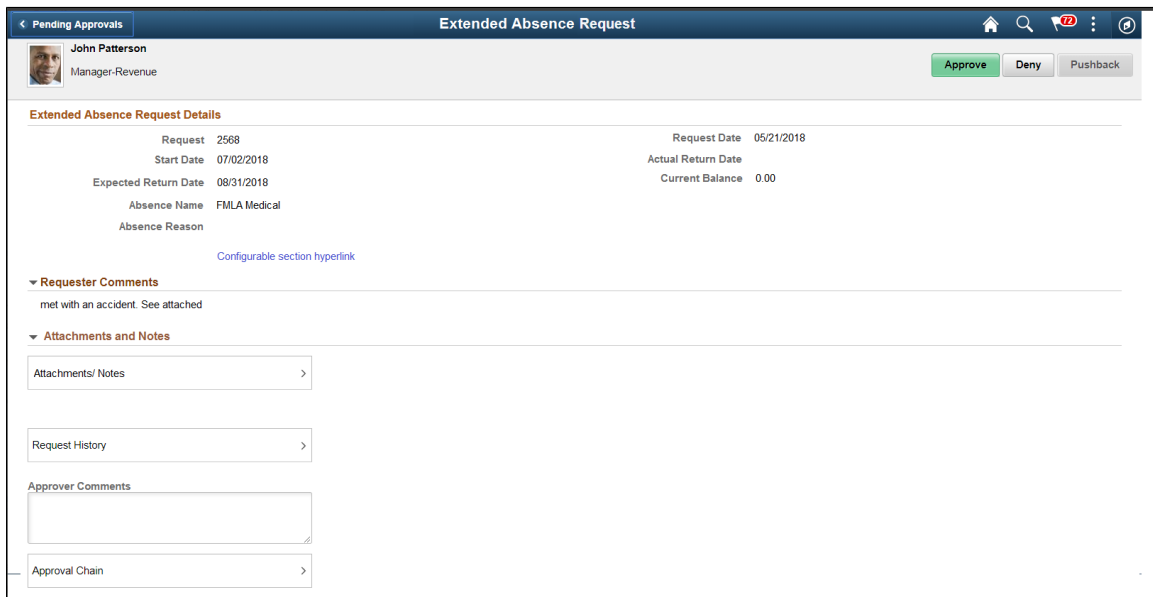

This example illustrates the fields and controls on the Pending Approvals — Extended Absence page in which child absence reported within an extended absence.

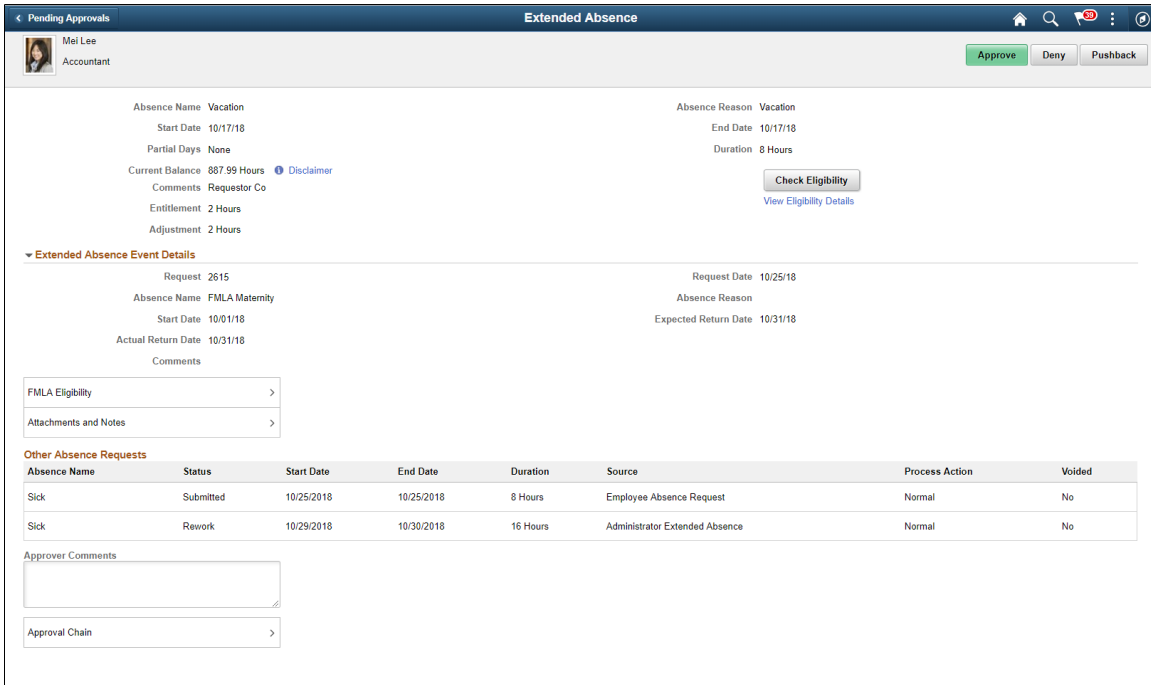

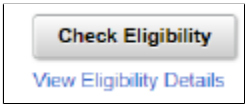
| Field or Control | Description |
|---|--|
|  | Select to view if the employee is eligible for the extended absence request. |

Extended Absence Event Details

This section displays the details like number of requests, request date, type of absence, absence reason, date of absence and the comments entered during the absence request.

| Field or Control | Description |
|------------------------------|--|
| FMLA Eligibility | Select to open <u>Extended Absence Detail Information — FMLA Eligibility</u> page. |
| Attachments and Notes | Click to access the <u>Attachments and Notes Page</u> to view Overtime Request history with date and comments. |

Other Absence Requests

| <i>Field or Control</i> | <i>Description</i> |
|-------------------------|---|
| Source | displays the information like employee absence request or administrator extended absence. |

Extended Absence Detail Information — FMLA Eligibility

Use the Extended Absence Detail (GP_ABS_DATA) modal to view the extended absence details and FMLA Eligibility details.

Navigation:

Click the FMLA Eligibility item on the Pending Approval — Extended Absence page.

This example illustrates the fields and controls on the Extended Absence Detail Modal.

The screenshot shows a web browser window titled "Extended Absence Detail". At the top, there is a message: "Use this Template form to enter Employee Extended Absence Request related information. In order to save your data entry updates, please navigate back to the Extended Absence Request page using the Return to Extended Absence Request link. Your Extended Absence Request must be saved in order for changes to go into effect." Below this is a section titled "Extended Absence Detail Information" with a sub-section "FMLA Eligibility (FMLA Administrator)".

The "FMLA Eligibility" section is divided into "Eligibility Details" and "FMLA Balances".

Eligibility Details:

- Override Eligibility
- Employee's Spouse works for the same company. A label "What is the Spouse's employee number?" is positioned to the right.

Federal Eligibility:

- The employee has been employed for at least 12 months. Current Months: 60.000000
- The employee has worked for at least 1250 hours in the past 12 months. Current Hours: 2086.000000
- At least 50 Employees are employed by the employer within a 75 miles radius

State Eligibility:

- The employee has been employed for at least 12 months. Current Months: 60.000000
- The employee has worked for at least 1250 hours in the past 12 months. Current Hours: 2086.000000
- At least 50 Employees are employed by the employer within a 75 miles radius

FMLA Balances:

- Leave Available: 60.000000
- Leave Taken: (blank)

At the bottom left, it says "Validated on 05/25/2012".

This example illustrates the fields and controls on the Approval Chain Details page.

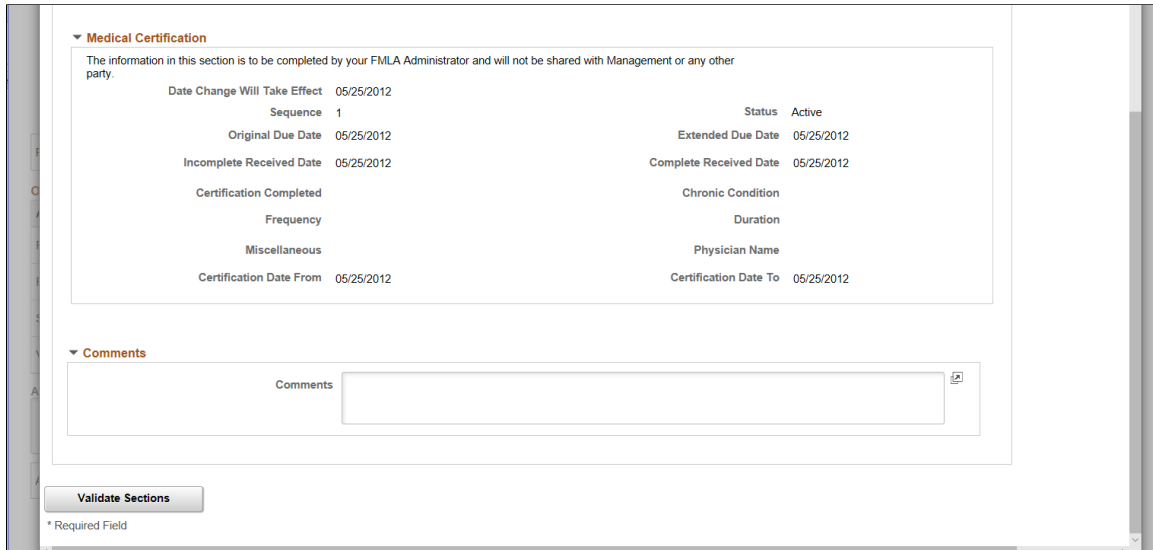

Attachments and Notes Page

Use the Attachment and Notes (HGA_EX_ABS_ATT_SCF) modal to view the attachments and notes associated with the extended absence requests.

Navigation:

Click the Attachment and Notes item on the Extended Absence — Pending Approvals page.

This example illustrates the fields and controls on the Attachments and Notes Modal.

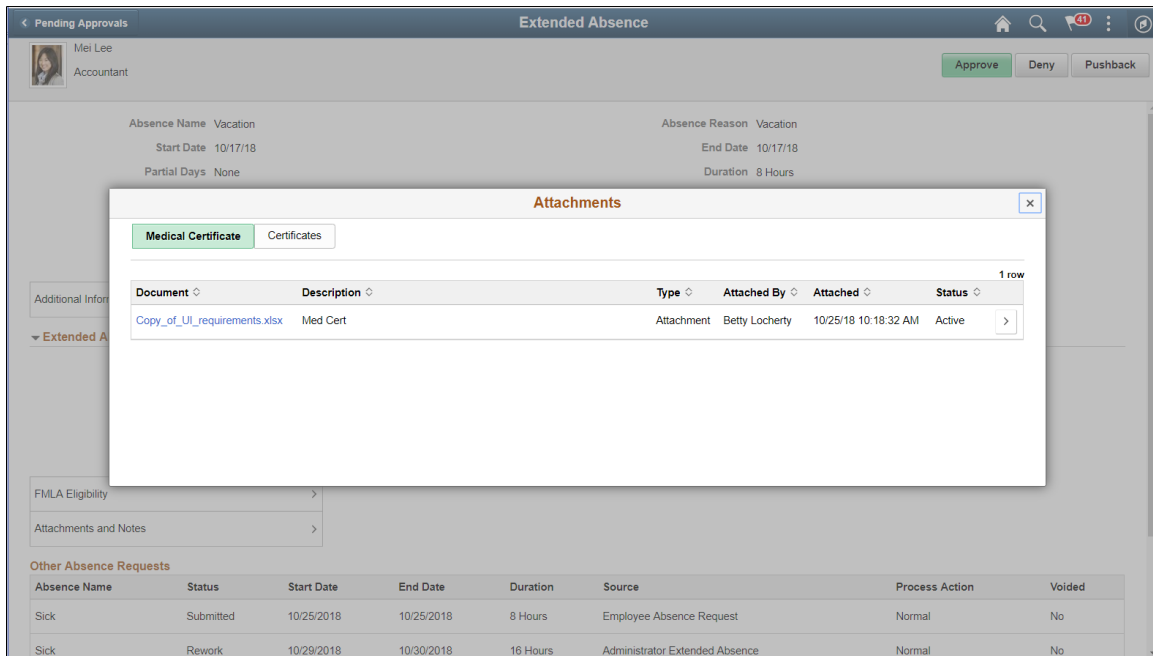

This modal separates the documents in two tabs?

Select the chevron to open Additional Information Page

Additional Information Page

Use the Additional Information (HGA_FA_ADD_INFO_FL) modal to view the additional information for the Extended Absence details.

Navigation:

Click the Extended Absence Details item on the Pending Approvals - Extended Absence page.

Select Additional Information.

This example illustrates the example for Additional Information Modal.

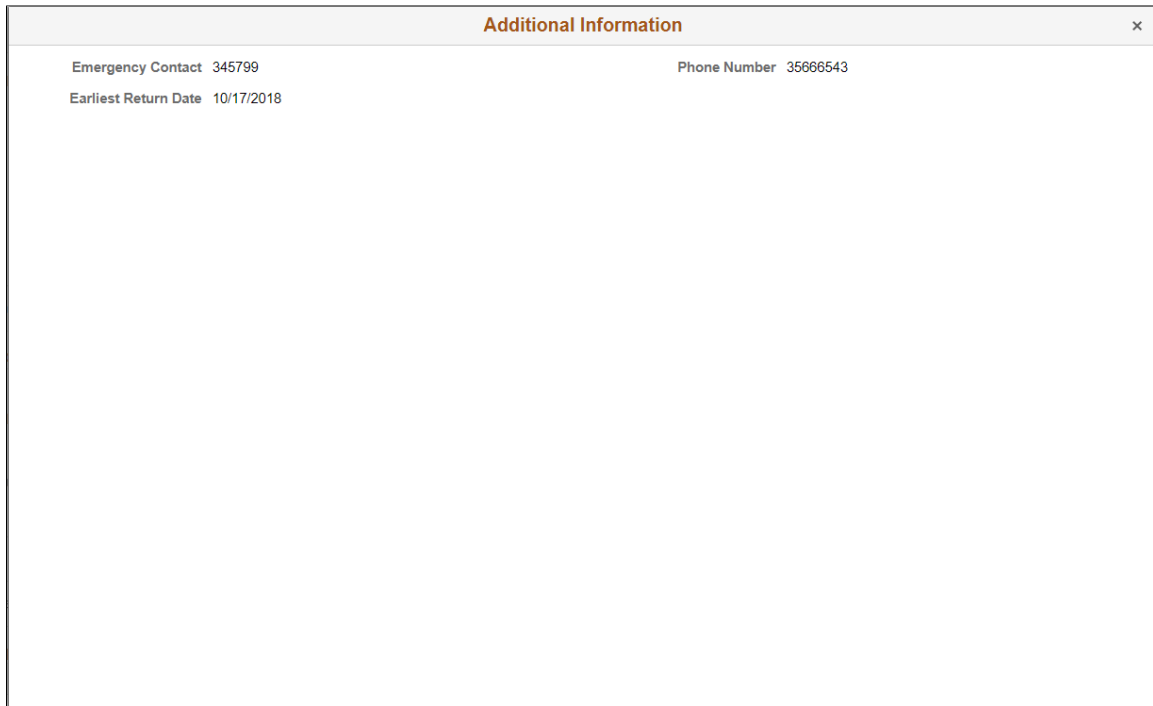

The screenshot shows a modal window titled "Additional Information" with a close button (x) in the top right corner. The modal contains the following information:

| | | | |
|----------------------|------------|--------------|----------|
| Emergency Contact | 345799 | Phone Number | 35666543 |
| Earliest Return Date | 10/17/2018 | | |

Approval Chain

Use the Approval Chain Details page (EOAWMA_APPC_SCF) to view the information about approvers associated with the request and approval status.

This example illustrates the Approval Chain Modal.

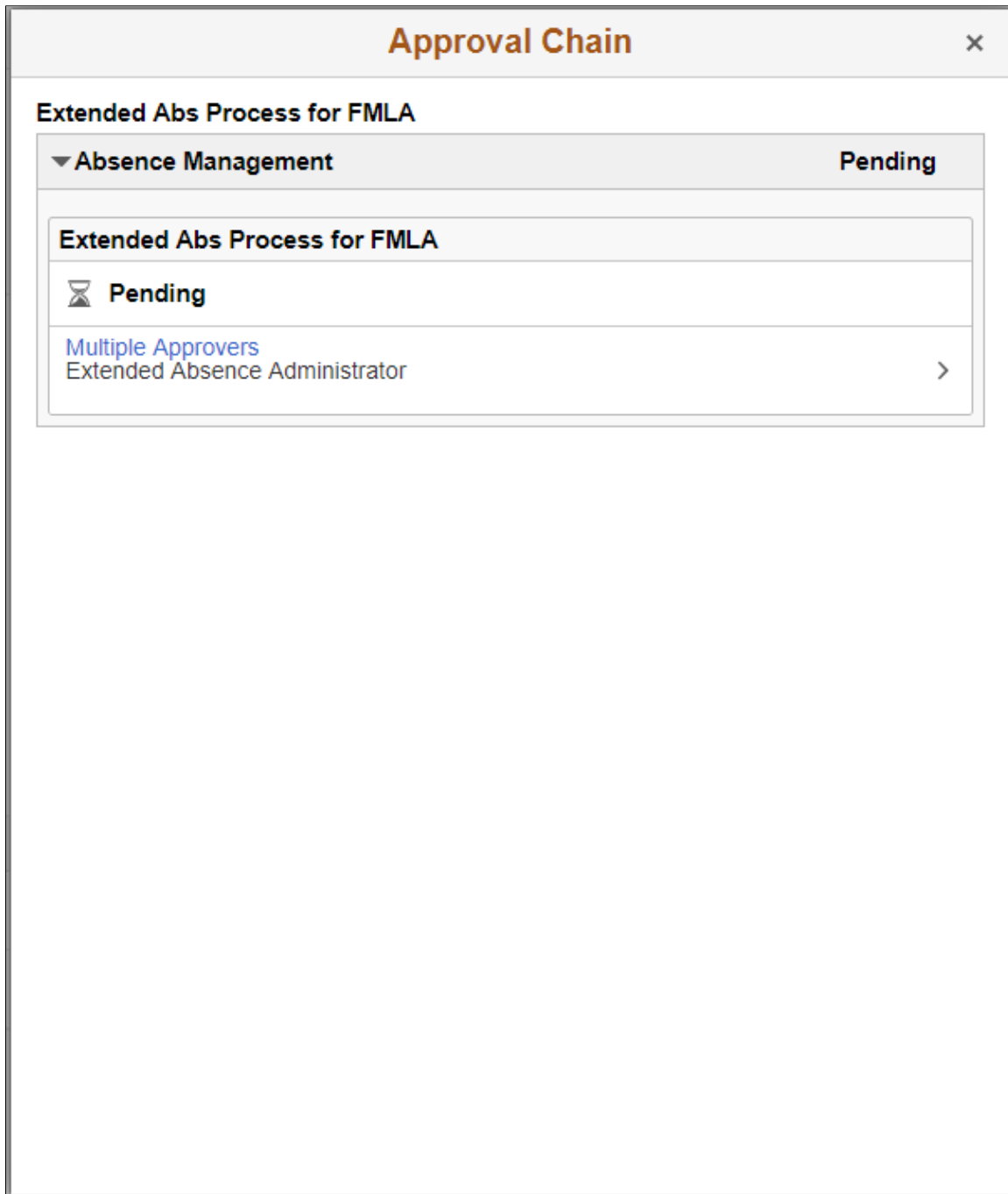

Pending Approvals — Leave Donations Page

Use the Pending Approvals - Leave Donations page (EOAWMA_MAIN_FL) to approve a leave donation request.

Note: Only users with Leave Donation Administrator role can manage leave donation transactions.

Navigation:

On the Manager Self-Service home page, tap the Approvals tile to access the Pending Approvals page. Then tap the Leave Donations entry from the Pending Approvals page.

This example illustrates the fields and controls on the Pending Approvals — Leave Donations page using a smartphone.

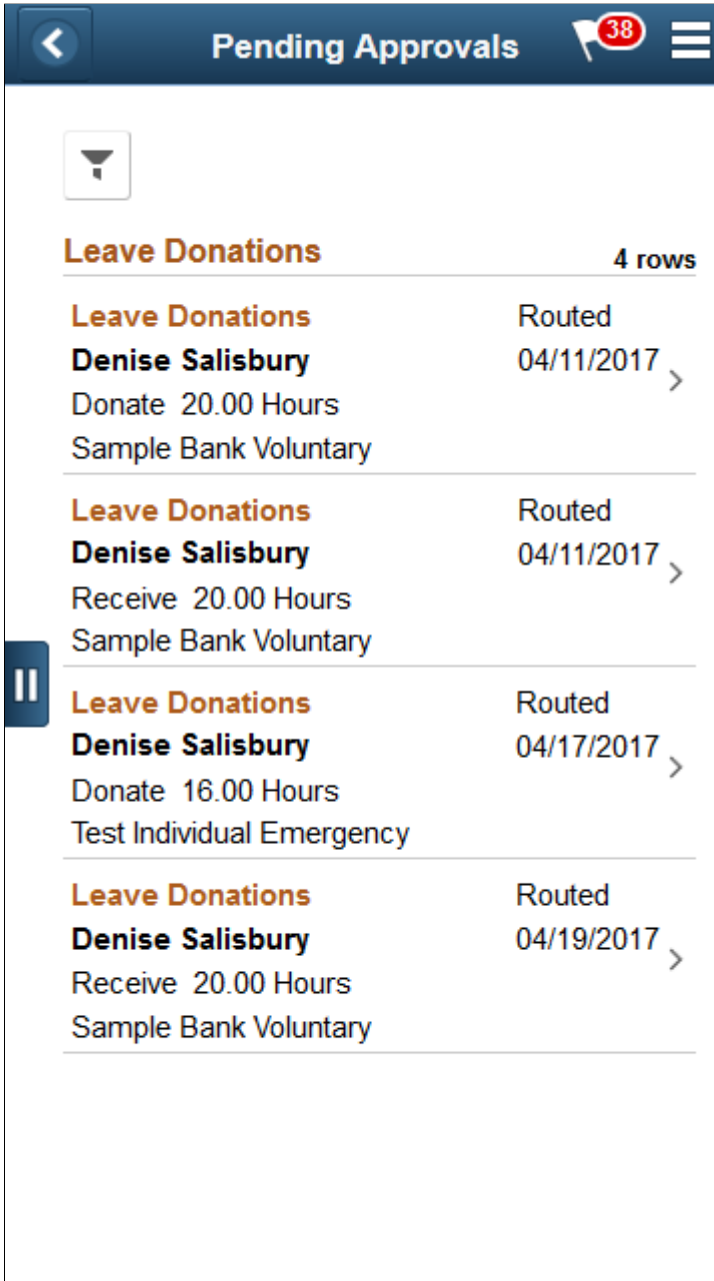

This example illustrates the fields and controls on the Pending Approvals — Leave Donations page using a desktop.

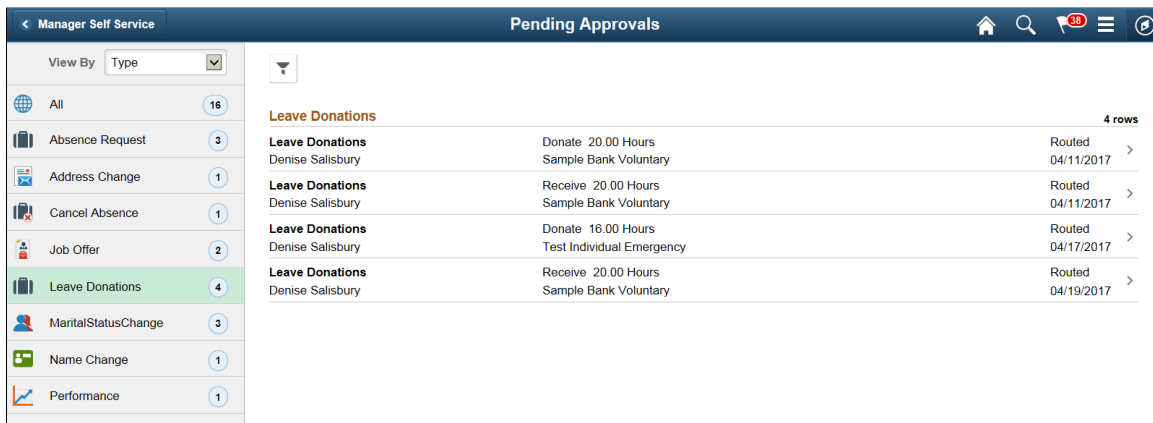

| Field or Control | Description |
|-------------------------|---|
| Leave Donations | Click the leave donation request to open the Leave Donations page, where you can review information about the leave donation request. |

This example illustrates the Leave Donations page using a smartphone

Leave Donations 73

 **Daryl Reese**
Financial Analyst

Request Type Donate

Leave Program Bank Voluntary

Date Submitted 02/24/16

Leave Donation Details >

▼ **Requester Comments**

Want to contribute to bank

▼ **Leave Program Details**

Program Type Voluntary

Category Bank

Contribution Type Recurring

Frequency Monthly

Unit Type Hours

Approve **Deny** **Pushback**

This example illustrates the Leave Donations page using a desktop.

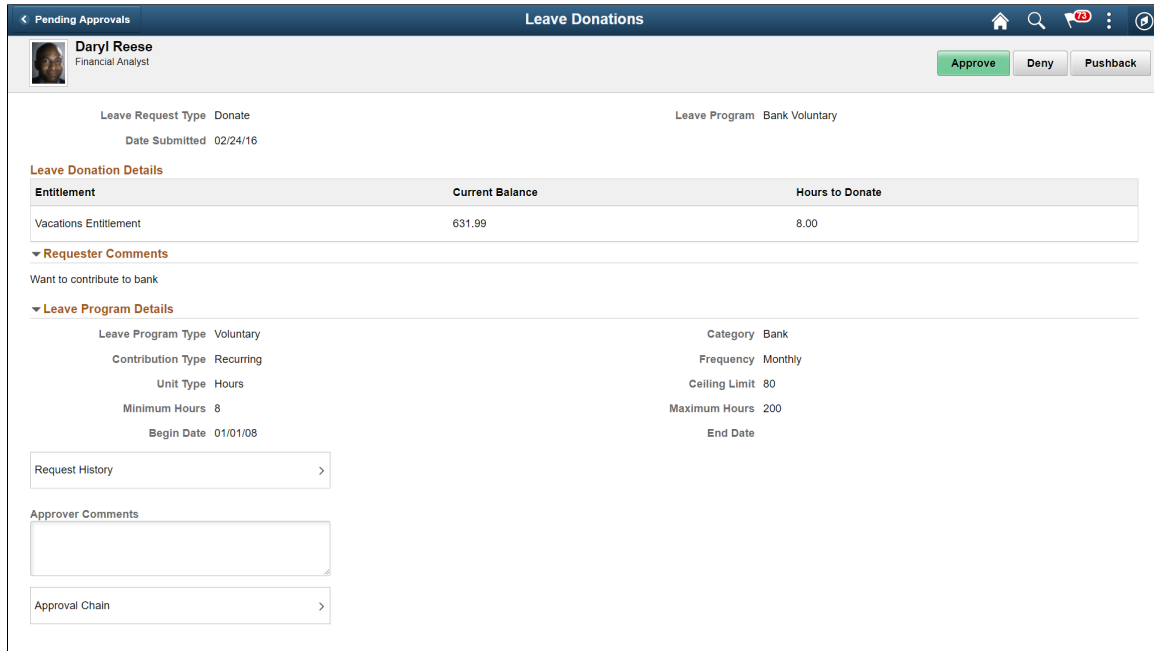

The approval options on this page are common to all fluid approval transactions, as described in the documentation for the “Pending Approvals - <Transaction Details> Page” (Application Fundamentals)

| Field or Control | Description |
|-----------------------------------|---|
| Approve, Deny and Pushback | Use these buttons to take action on the requested approval. Note: These buttons will be enabled only when the leave donation request is selected. |
| Approver Comments | Enter any comments related to the approval action you take. |
| Request History | Click the Request History link to view the transaction history for this leave donation request. |
| Approver Comments | Enter any comments related to the approval action you take. |
| Approval Chain | Click this item to open the Approval Chain page, where you can review information about all approvers for the transaction |

Using Absence Analytics

Understanding Absence Analytics

PeopleSoft Global Payroll and Absence Management include a set of configurable pivot grids that provide you with robust tools to analyze your absence data. There are three ways that users can access these absence analytics pivot grids, depending on their role:

- Administrators can use the Absence Analytics Dashboard to access all eight delivered pivot grids.

For more information on using the Absence Analytics Dashboard, see [Defining the Absence Analytics Dashboard Content and Layout](#) and [Using the Absence Analytics Dashboard Pagelets](#).

- Managers can access the Absence Event Analysis, Absence Cost Analysis, Absence Liability & Trends, and Periodic Absence Rate pivot grids using the Absence Events Analysis pagelet on the Manager Dashboard.

For more information, see the documentation for the “Absence Events Analysis Pagelet” (PeopleSoft eProfile Manager Desktop).

- Managers can access the Absence Event Analysis pivot grid using the PeopleSoft Fluid User Interface. For more information, see [Using the PeopleSoft Fluid User Interface to Work with Absence Analytics as a Manager](#).

Video: [PeopleSoft Absence Analytics](#)

Preparing and Loading Absence Analytics Data

Before you can analyze absence data using the delivered absence analytics pivot grids, you must first prepare and load your absence data.

Pages Used to Prepare and Load Absence Analytics Data

| <i>Page Name</i> | <i>Definition Name</i> | <i>Usage</i> |
|---|------------------------|---|
| Refresh Employee Information Page | HGA_EMPREF_RUNCNTL | Update employee information with the most current data. |
| Load Absence Analytics Data Page | HGA_PG_RUNCNTL | Load absence analytics data for a specific date range. |

Refresh Employee Information Page

Use the Refresh Employee Information page (HGA_EMPREF_RUNCNTL) to update employee information with the most current data.

Navigation:

Global Payroll & Absence Mgmt > Absence and Payroll Processing > Refresh Absence Employee Info

Click Run on this page to initiate the Refresh Employee Info (HGA_EMP_REF) Application Engine process, which updates employee data with the most current data.

Load Absence Analytics Data Page

Use the Load Absence Analytics Data page (HGA_PG_RUNCNTL) to load absence analytics data for a specific date range.

Navigation:

Global Payroll & Absence Mgmt > Absence and Payroll Processing > Load Absence Analytics Data

This example illustrates the fields and controls on the Load Absence Analytics Data page.

| <i>Field or Control</i> | <i>Description</i> |
|--------------------------------|---|
| From Date and Thru Date | Enter the date range for which you want to load absence analytics data. |

Click Run to initiate the Load Absence Analytics Data (HGA_INIPGDAT) Application Engine process. This process uses the ABSENCE PIVOTS report data definition to load absence analytics data for all open and finalized calendar groups that fall within the specified date range.

Note: The system loads absence analytics data for individual calendar groups as part of the absence and payroll calculation process (GP_PAYE). The Load Absence Analytics Data process enables you to load absence analytics data for multiple existing calendar groups.

Related Links

[Defining Report Data](#)

Defining the Absence Analytics Dashboard Content and Layout

Pages Used to Define the Absence Analytics Dashboard Content and Layout

| <i>Page Name</i> | <i>Definition Name</i> | <i>Usage</i> |
|---|------------------------|---|
| Personalize Content: Absence Analytics Dashboard Page | PORTAL_HPCOMP | Specify which pagelets appear on the Absence Analytics Dashboard. |
| Defining the Absence Analytics Dashboard Content and Layout | PORTAL_HPLAYOUT | Define the layout of the pagelets on the Absence Analytics Dashboard. |

Personalize Content: Absence Analytics Dashboard Page

Use the Personalize Content: Absence Analytics Dashboard page (PORTAL_HPCOMP) to specify which pagelets appear on the Absence Analytics Dashboard.

Navigation:

Global Payroll & Absence Mgmt > Absence Analytics Dashboard

Click the **Content** link on the Absence Analytics Dashboard page.

This example illustrates the fields and controls on the Personalize Content: Absence Analytics Dashboard page.

Personalize Home Page

Personalize Content:

Tab Name Absence Analytics Dashboard

Welcome Message

Choose Pagelets: Simply check the items that you want to appear on your homepage.
Remember to click "Save" when done.

Arrange Pagelets: Go to [Personalize Layout](#)

Absence Mgmt Admin Pagelets

- Absence Events Analysis
- Absence Cost Analysis
- Absence Liability and Trends
- Periodic Absence Rate
- Absence by Take and Type
- Employee with Negative Balance
- Absence by Paid Unpaid Status
- By Generated Positive Input

Use this page to choose which pagelets you want to display in your Learning Home.

| Field or Control | Description |
|---------------------------|---|
| Personalize Layout | Click to access the Defining the Absence Analytics Dashboard Content and Layout . |
| <pagelet name> | Click a pagelet name link to see a preview of the pagelet. |

Personalize Layout: Absence Analytics Dashboard Page

Use the Personalize Layout: Absence Analytics Dashboard page (PORTAL_HPLAYOUT) to specify which pagelets appear on the Absence Analytics Dashboard.

Navigation:

Global Payroll & Absence Mgmt > Absence Analytics Dashboard

Click the **Layout** link on the Absence Analytics Dashboard page.

This example illustrates the fields and controls on the Personalize Layout: Absence Analytics Dashboard page.

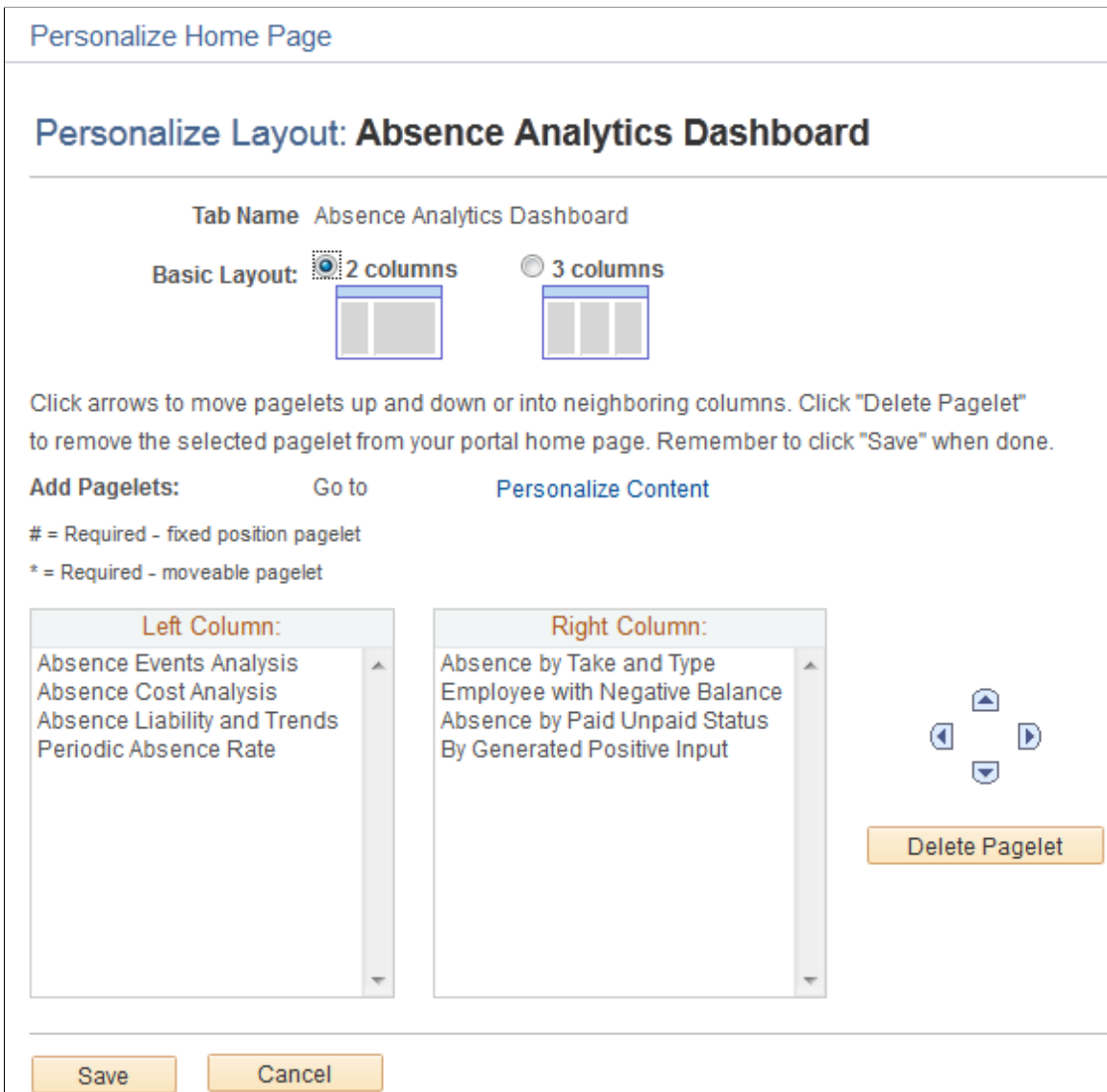

Use this page to define the arrangement of the pagelets in your Learning Home.

| Field or Control | Description |
|----------------------------|---|
| Personalize Content | Click to access the Personalize Content: Absence Analytics Dashboard Page . |

Using the Absence Analytics Dashboard Pagelets

Understanding the Absence Analytics Dashboard

The Absence Analytics Dashboard enables administrators to quickly analyze absence and payroll results using a variety of pivot grid pagelets. The user determines which pivot grid pagelets appear on the dashboard and how they are laid out on the page.

The system loads absence analytics data for individual calendar groups as part of the absence and payroll calculation process (GP_PAYE). You can also use the [Load Absence Analytics Data Page](#) to load absence analytics data for existing calendar groups within a given date range.

Accessing the Absence Analytics Dashboard

You can access the Absence Analytics Dashboard using the classic navigation, **Global Payroll & Absence Mgmt > Absence Analytics Dashboard**, or the [Absence Analytics Dashboard Tile](#).





Delivered Learning Home Pagelets

The following pagelets are delivered for the Absence Analytics Dashboard.

| <i>Pagelet</i> | <i>Usage</i> |
|--|---|
| Absence Cost Analysis Pagelet | Analyze the cost of reported absences by absence type, absence take, and absence reason. |
| Absence Events Analysis Pagelet | Analyze absence entries by status, absence type, absence take, and absence reason. |
| Absence Liability and Trends Pagelet | Analyze the absence liability for all absence entitlements by period begin date. |
| Periodic Absence Rate Pagelet | Analyze absence entries by employee engagement factors such as absence rate for a business entity as of a specific date, absence rate for a given period, total number of absence days, average absence duration, and average absence days. |
| Absence by Take and Type Pagelet | Analyze absence results by absence take and absence type. |
| Employee with Negative Balance Pagelet | Analyze absence results associated with negative balances. |
| Absence by Paid Unpaid Status Pagelet | Analyze absence results that include unpaid and partially paid absences. |

| Pagelet | Usage |
|--|---|
| <u>By Generated Positive Input Pagelet</u> | Analyze absence results associated with generated positive input. |

Common Elements Used in this Topic

| Field or Control | Description |
|---|--|
|  Pagelet Settings | Click the Page Settings icon to access the pagelet settings. Values are: <ul style="list-style-type: none"> <i>Minimize</i>: select to minimize a pagelet. <i>Remove</i>: select to remove the pagelet from the Absence Analytics Dashboard. You can add it back using the Personalize Content: Absence Analytics Dashboard Page. |
|  Refresh Pagelet | Click the Refresh Pagelet icon to refresh the contents of the pagelet. |
|  Options Menu | Click to open the Options Menu and select an action to perform on the pivot grid or chart. Available actions are: <ul style="list-style-type: none"> Prompts: Click to access the Datasource Prompts page to view or change the Query prompts used for the pivot grid. View Grid: Click to view data in the grid format in a new modal window. You can change how data is presented in the grid by dragging and dropping segment data to a different axis. Export Data: Click to export the underlying PSQuery data into a spreadsheet. Chart Options: Click to open the User Charting Options page where you can change the chart layout, information displayed on chart axes, and filters. Save: Click to save the current grid and chart layout as the default view of the current model. |
| Filters | Displays the filtering fields that are selected in the chart options. Users can use the available filters to change the data to be displayed in the pivot grid or chart. |
|  Pivot Grid Chart Types | Click to display data in the chart type represented by the icon. Available chart types include vertical bar, line, pie and horizontal bar. |

For more information on pivot grid functionality, see the product documentation for *PeopleTools: Pivot Grid*.

Absence Analytics Dashboard Tile

Use the Absence Analytics Dashboard tile (HC_GP_WC_ABS_ANLTC_FLU_GBL) to access the Absence Analytics Dashboard.

Navigation:

You can add the delivered Absence Analytics Dashboard tile to your fluid home pages.

This example illustrates the Absence Analytics Dashboard tile.

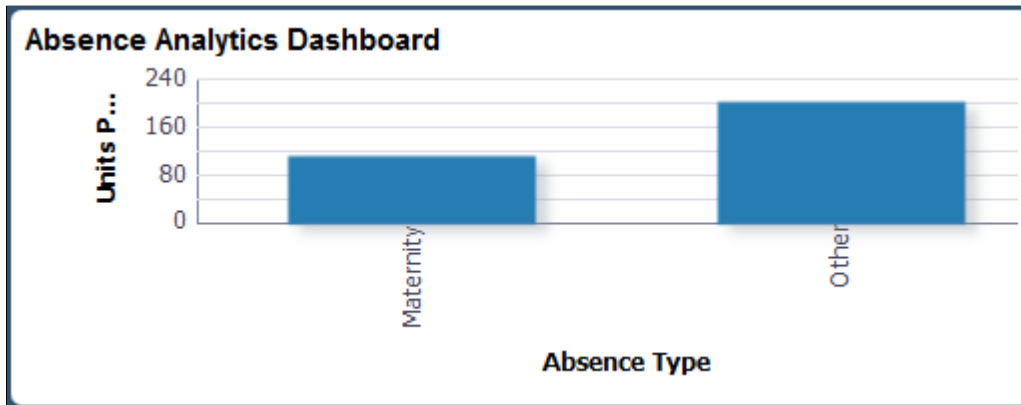

The tile displays a bar chart of the units per absence event by absence type. Click it to access the Absence Analytics dashboard in the classic user interface.

Absence Cost Analysis Pagelet

Use the Absence Cost Analysis pagelet to analyze the cost of reported absences by absence type, absence take, and absence reason.

This example illustrates the fields and controls on the Absence Cost Analysis pagelet.

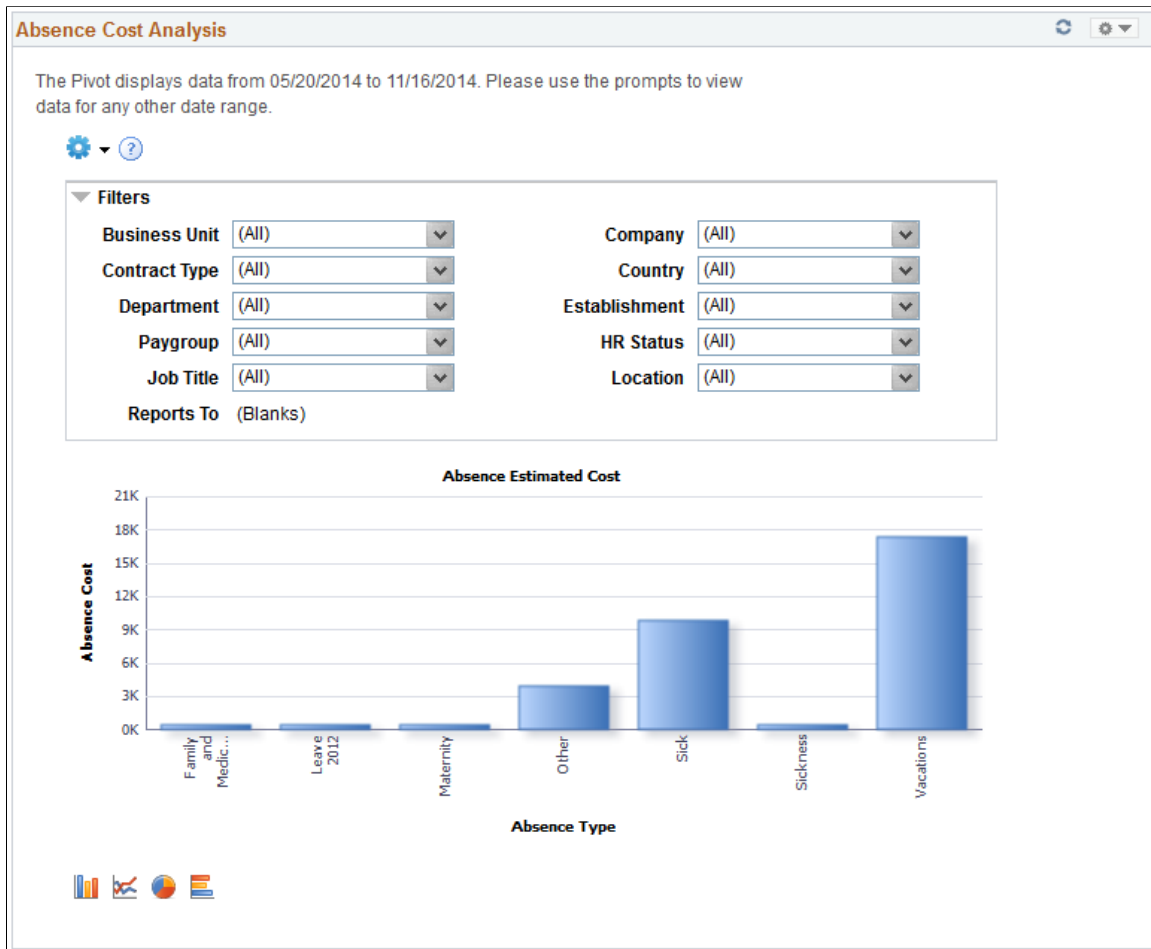

By default this pivot grid displays a bar chart of the total absence cost for the specified date range by absence type.

Examples of what administrators can use this pivot grid to determine are:

- The amount that paid employee absences have cost the company for a given date range.
- What costs were incurred by the company for a specific team across different locations.
- The variation in absence costs over different pay calendars for a given date range.

Absence Events Analysis Pagelet

Use the Absence Events Analysis pagelet to analyze absence entries by status, absence type, absence take, and absence reason.

This example illustrates the fields and controls on the Absence Events Analysis pagelet.

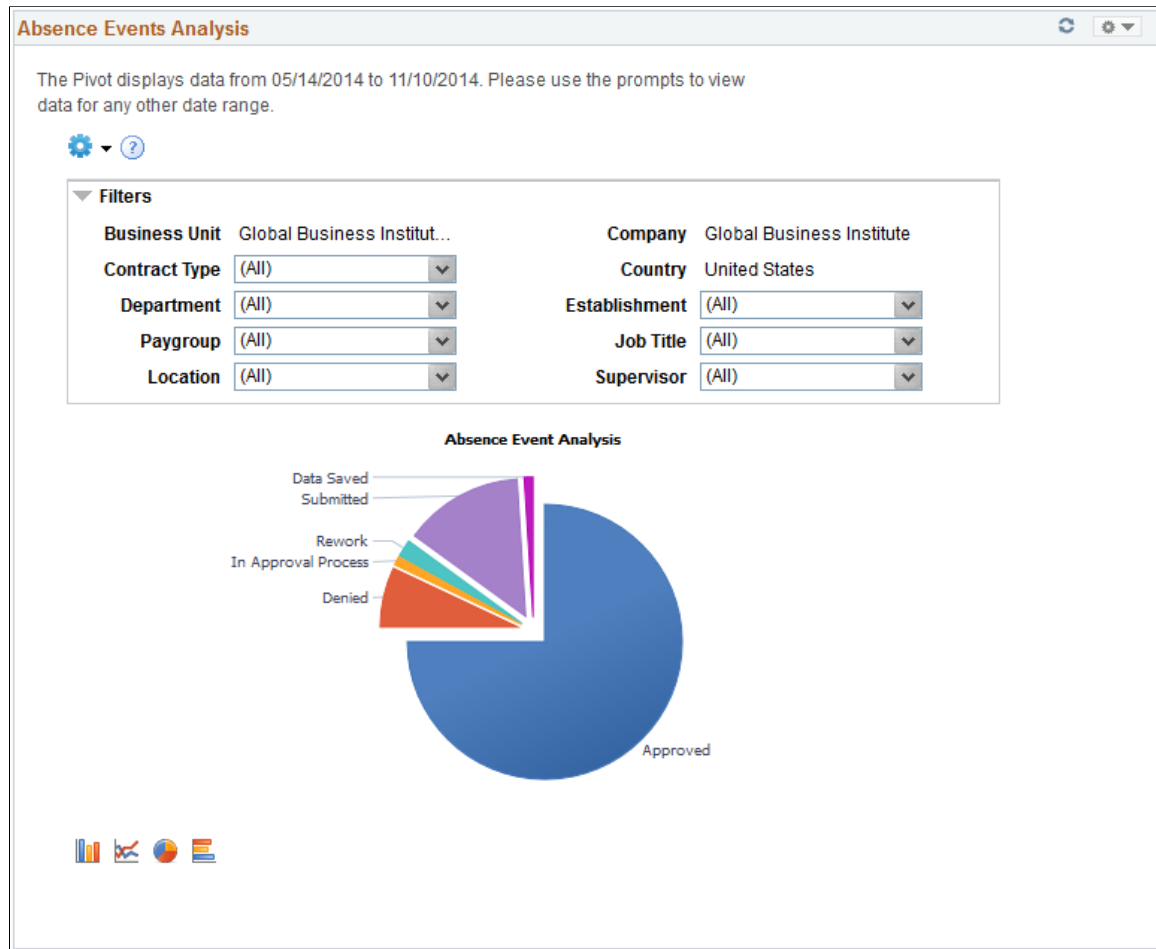

By default, this pivot grid displays a pie chart of the absences for the administrator's company for the specified date range by approval status.

Note: When a manager accesses this pivot grid through the Manager Dashboard or through the PeopleSoft Fluid User Interface, it displays a bar chart of the absences by approval status for the employees who report to the manager.

Examples of what administrators can use this pivot grid to determine are:

- The number of absences pending approval, and the employees with which they are associated.
- The number of absence requests entered for a given pay period.
- The types of absence requests that employees and direct reports are entering.
- Which employees reported absences with partial hours or partial days.
- The counts of absence entry composition by entry source.

Related Actions

You can click an area of the chart and select Detailed View to view the absence event data using the Pivot Grid Drilldown page.

This example illustrates the fields and controls on the Pivot Grid Drilldown page.

| Employee ID | Actions | First Name | Last Name | Empl Record | Job Title | Person Type | HR Status | Absence Name | Begin Date | End Date | Absence Type | Absence Reason | Entry Source | Approval Status | Duration in Hours | Duration in Days | Unit Type | Processing Calendar | Period Type | Processing Status | Forecast Value | Transaction Number | Hire Date |
|-------------|---------|------------|-----------|-------------|---------------------------|-------------|-----------|--------------|------------|------------|--------------|----------------|--------------------------|-----------------|-------------------|------------------|-----------|---------------------|-------------|-------------------|----------------|--------------------|-----------|
| KU0148 | Actions | Melissa | Caldwell | 0 | Clerk-File | Employee | Active | Sick | 2014-08-29 | 2014-08-29 | Sick | | Employee Absence Request | Submitted | 8.00 | 1.00 | Hours | KOCA KGPNA14810 | Current | Not Processed | | 785 | 2012 |
| KU0133 | Actions | Heidi | Dubas | 0 | Bookkeeper | Employee | Active | Vacation | 2014-10-31 | 2014-10-31 | Vacations | Vacation | Employee Timesheet | Submitted | 8.00 | 1.00 | Hours | KOCA KGPNA14820 | Current | Not Processed | | 739 | 2012 |
| KU0147 | Actions | Kim | Balinger | 0 | Clerk-Data Entry | Employee | Active | Sick | 2014-06-30 | 2014-06-30 | Sick | Flu | Employee Absence Request | Submitted | 8.00 | 1.00 | Hours | KOCA KGPNA14814 | Retro | Not Processed | | 690 | 2012 |
| KU0016 | Actions | Joanna | Strunsky | 0 | Bookkeeper | Employee | Active | Sick | 2014-09-26 | 2014-09-26 | Sick | | Employee Timesheet | Submitted | 8.00 | 1.00 | Hours | KOCA KGPNA14820 | Current | Not Processed | | 737 | 1981 |
| KU0079 | Actions | Russell | Parier | 0 | Bookkeeper | Employee | Active | Bereavement | 2014-09-22 | 2014-09-26 | Other | Bereavement | Employee Timesheet | Submitted | 40.00 | 5.00 | Days | KOCA KGPNA14820 | Current | Not Processed | | 738 | 1995 |
| KU0059 | Actions | Vicki | Zinn | 0 | Accountant | Employee | Active | Sick | 2014-09-26 | 2014-09-26 | Sick | | Employee Absence Request | Submitted | 8.00 | 1.00 | Hours | KOCA KOC14M09 | Current | Not Processed | | 713 | 1988 |
| K0W204 | Actions | Horace | White | 0 | Analyst-Budget II | Employee | Active | Vacation | 2014-10-13 | 2014-10-15 | Vacations | Vacation | Employee Absence Request | Submitted | 24.00 | 3.00 | Hours | K0W102014M10 | Current | Not Processed | | 639 | 2000 |
| KU0046 | Actions | Rosanna | Channing | 0 | Senior Manager-Accounting | Employee | Active | Vacation | 2014-10-06 | 2014-10-06 | Vacations | Vacation | Employee Absence Request | Submitted | 8.00 | 1.00 | Hours | KOCA KOC14M10 | Current | Not Processed | | 551 | 1986 |
| KU0020 | Actions | Christelle | Stevenson | 0 | Manager-Accounting | Employee | Active | Vacation | 2014-10-06 | 2014-10-08 | Vacations | | Employee Absence Request | Submitted | 24.00 | 3.00 | Hours | KOCA KOC14M10 | Current | Not Processed | | 546 | 1982 |
| K0W235 | Actions | Caine | Diter | 0 | Analyst-Budget II | Employee | Active | Sick | 2014-10-01 | 2014-10-03 | Sick | Food Poisoning | Employee Absence Request | Submitted | 22.00 | 2.75 | Hours | K0WTLA K0W2014M10 | Current | Not Processed | | 648 | 2000 |

| Field or Control | Description |
|-----------------------|---|
| <p>Actions</p> | <p>Click to access the available related actions for the absence request. Valid values are:</p> <ul style="list-style-type: none"> <i>Notify Employee:</i> Click to access the Notify Employee page where you can send a message to the employee associated with the absence request as an announcement, an email, or both. <i>Approve Absence:</i> Click to access the Approve Absence Requests page where you can approve, deny, or push back the absence request. <i>Reassign Absence</i> Click to access the Reassign Absence Requests page where you can reassign an absence request to another approver. <i>Notify Approver:</i> Click to access the Notify Approver page where you can send a message to the approver assigned to the absence request as an announcement, an email, or both. <i>Notify Supervisor:</i> Click to access the Notify Supervisor page where you can send a message to the supervisor associated with the absence request as an announcement, an email, or both. |

Absence Liability and Trends Pagelet

Use the Absence Liability and Trends pagelet to analyze the absence liability for all absence entitlements by period begin date.

This example illustrates the fields and controls on the Absence Liability and Trends pagelet.

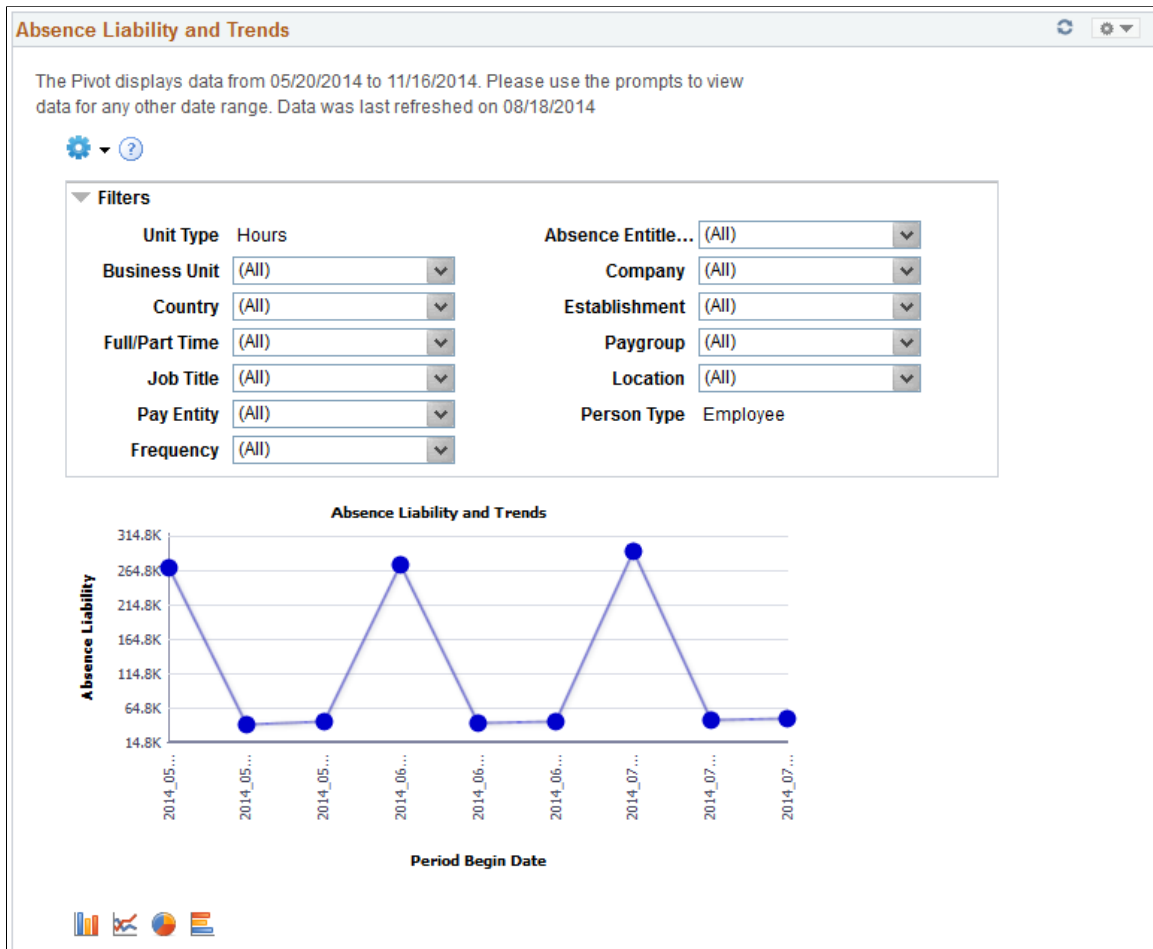

By default, this pivot grid displays a line chart of total absence liability for the specified date range by period begin date.

Examples of what administrators can use this pivot grid to determine are:

- The current liability for a given pay period.
- The current year-to-date absence liability for a specific business unit.
- The trends for reported absences and accrual balances for a given pay period.

Periodic Absence Rate Pagelet

Use the Periodic Absence Rate pagelet to analyze absence entries by employee engagement factors such as absence rate for a business entity as of a specific date, absence rate for a given period, total number of absence days, average absence duration, and average absence days.

This example illustrates the fields and controls on the Periodic Absence Rate pagelet.

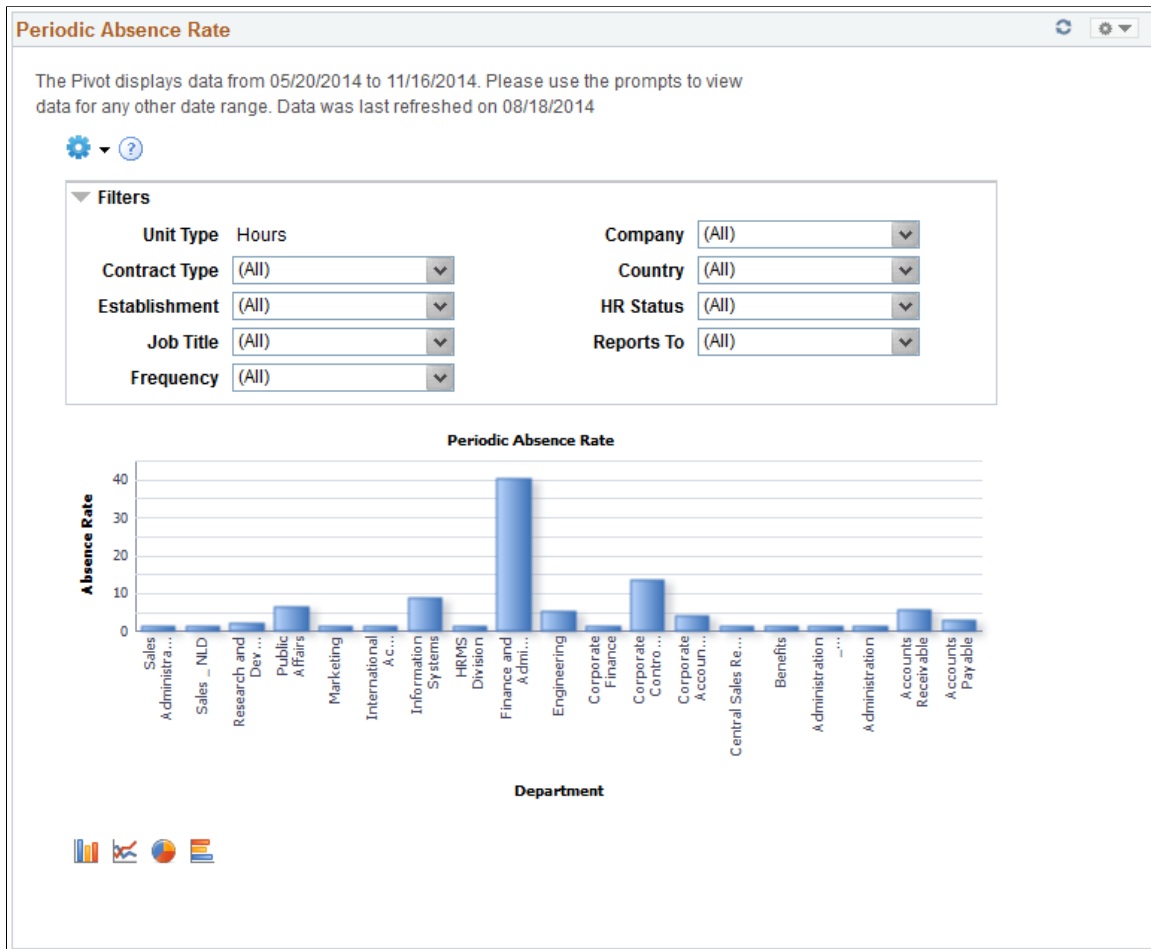

By default, this pivot grid displays a bar chart of the overall absence rate in hours for the specified date range by department. The absence rate is defined as the working time lost divided by the working time available, multiplied by 100.

Examples of what administrators can use this pivot grid to determine are:

- The absence rate for a business unit for a given date range.
- The average absence rate across an organizational entity.

Absence by Take and Type Pagelet

Use the Absence by Take and Type pagelet to analyze absence results by absence take and absence type.

This example illustrates the fields and controls on the Absence by Take and Type pagelet.

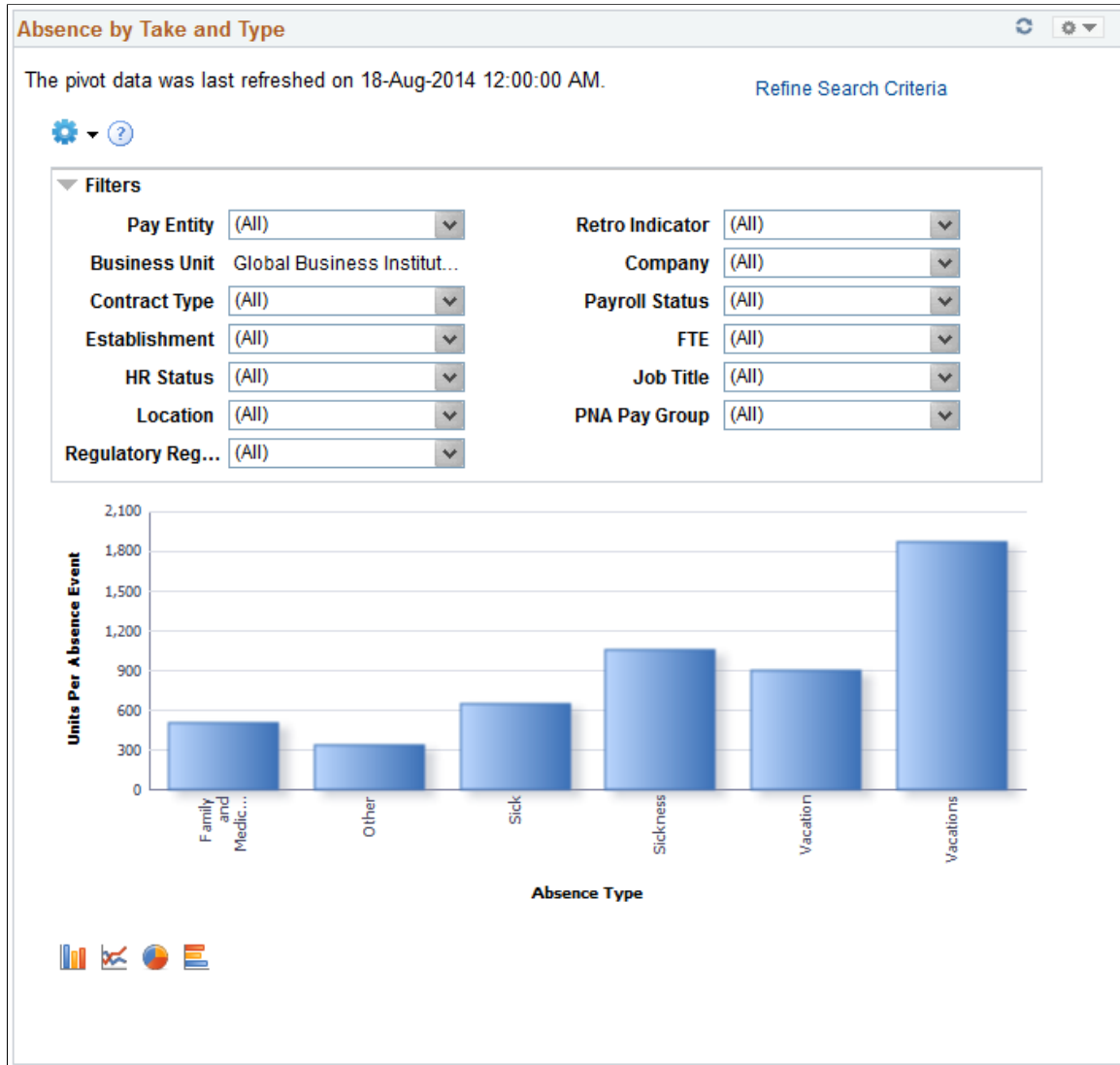

By default, this pivot grid displays a bar chart of the units per absence event by absence type.

Examples of what administrators can use this pivot grid to determine are:

- The amount of sick leave taken reported by a specific department.
- The amount of work-related absences for a specific calendar group.

| Field or Control | Description |
|-------------------------------|--|
| Refine Search Criteria | By default, the pivot grid displays all the absence analytics data that you have loaded in your system. Click this link to access the Refine Search Criteria modal page, which enables you to analyze a smaller, refined set of data. After entering your search criteria, click Run to apply them. Click Save Criteria and Run if you want the system to apply these search criteria the next time you access the pivot grid. |

Employee with Negative Balance Pagelet

Use the Employee with Negative Balance pagelet to analyze absence results associated with negative balances.

This example illustrates the fields and controls on the Employee with Negative Balance pagelet.

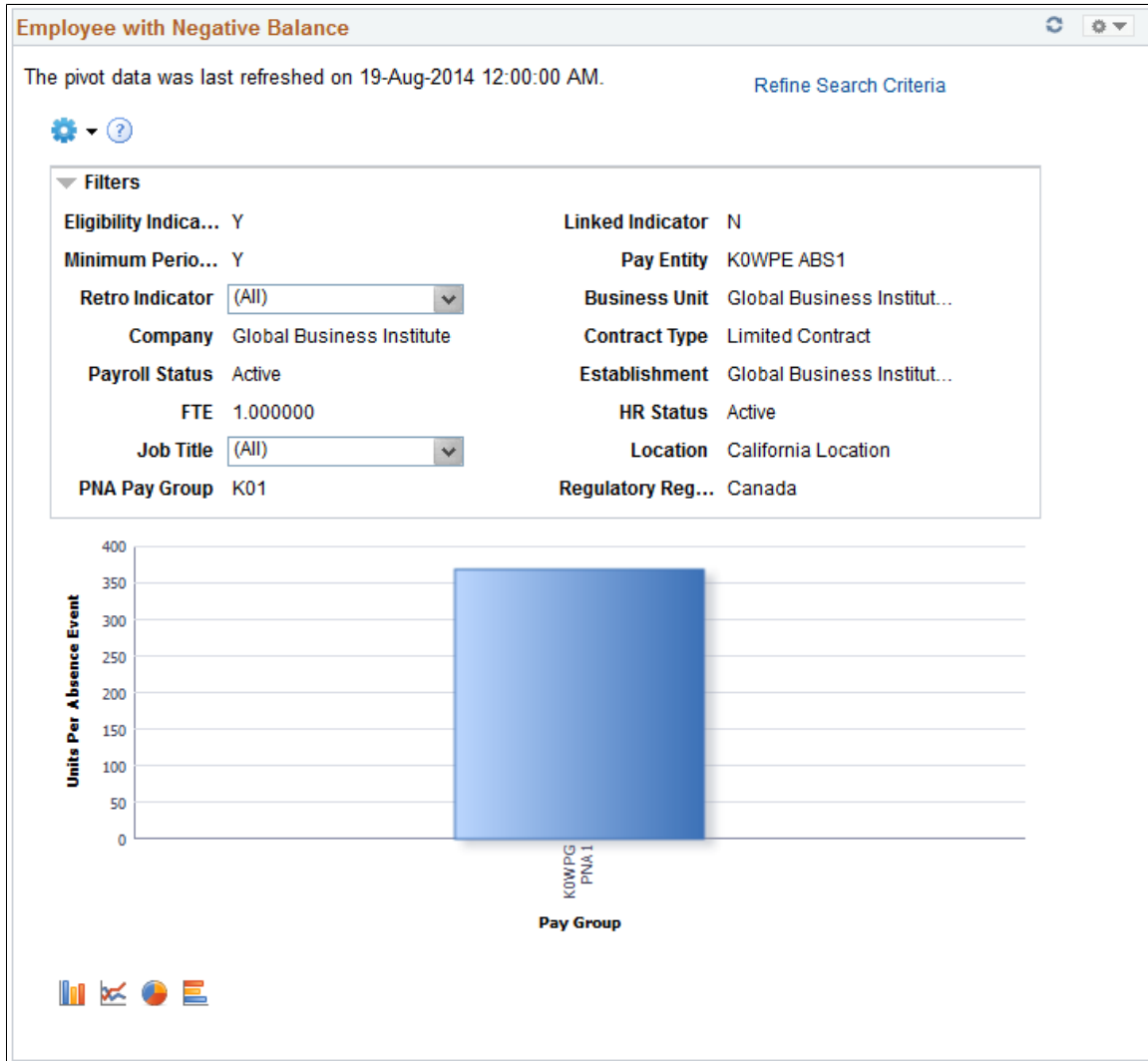

By default, this pivot grid displays a bar chart of the units per absence event by pay group.

Examples of what administrators can use this pivot grid to determine are:

- The number of employees paid for absences using a negative balance limit.
- The amount of absences paid using a negative balance limit for a specific absence type.

| Field or Control | Description |
|-------------------------------|--|
| Refine Search Criteria | By default, the pivot grid displays all the absence analytics data that you have loaded in your system. Click this link to access the Refine Search Criteria modal page, which enables you to analyze a smaller, refined set of data. After entering your search criteria, click Run to apply them. Click Save Criteria and Run if you want the system to apply these search criteria the next time you access the pivot grid. |

Absence by Paid Unpaid Status Pagelet

Use the Absence by Paid Unpaid Status pagelet to analyze absence results that include unpaid and partially paid absences.

This example illustrates the fields and controls on the Absence by Paid Unpaid Status pagelet.

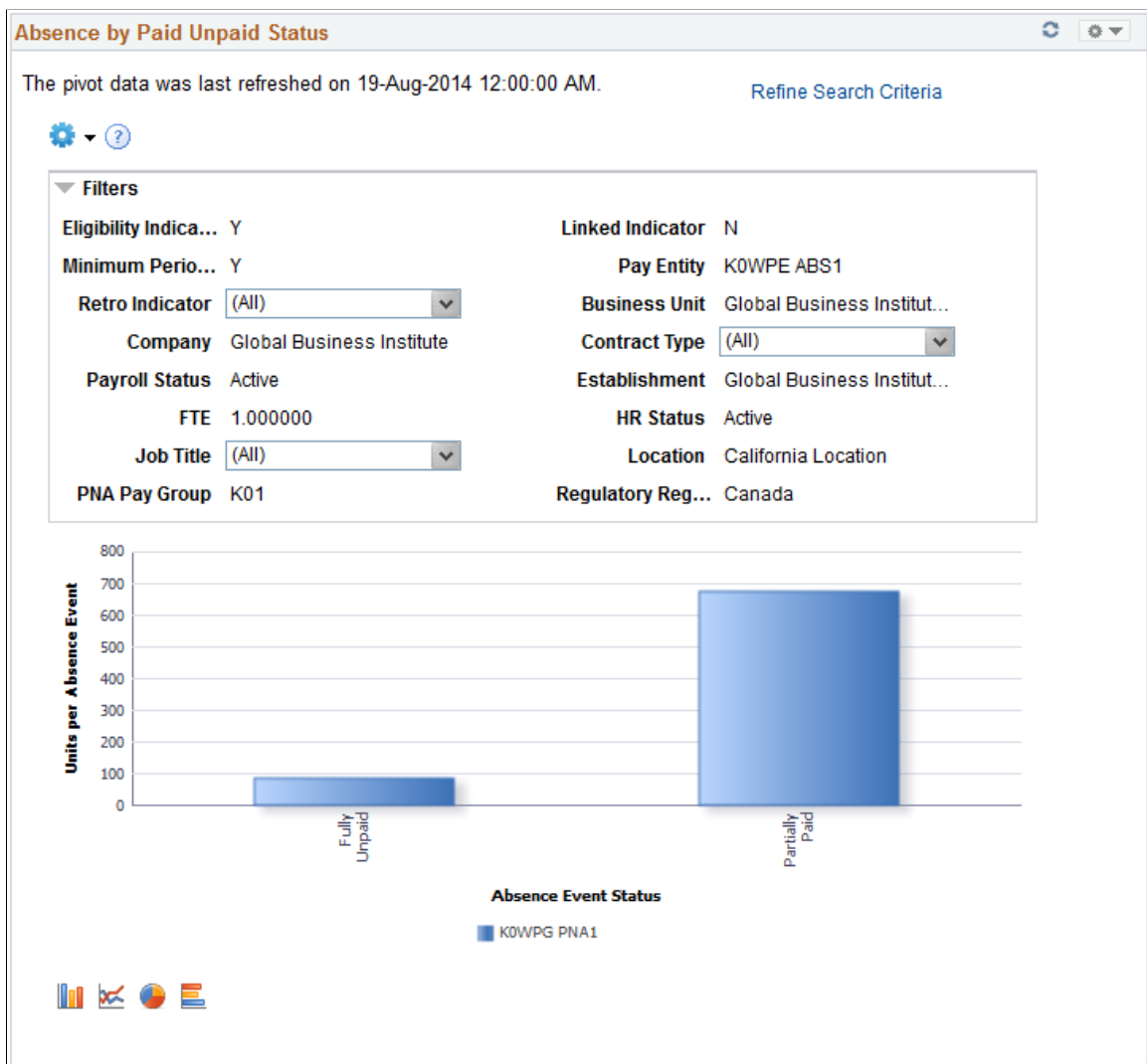

By default, this pivot grid displays a bar chart of the units per absence event by absence event status and pay group.

Examples of what administrators can use this pivot grid to determine are:

- Identify employees with absences that have an unpaid or partially paid status.
- View absence event status for a pay group by absence type.

| <i>Field or Control</i> | <i>Description</i> |
|--------------------------------|--|
| Refine Search Criteria | By default, the pivot grid displays all the absence analytics data that you have loaded in your system. Click this link to access the Refine Search Criteria modal page, which enables you to analyze a smaller, refined set of data. After entering your search criteria, click Run to apply them. Click Save Criteria and Run if you want the system to apply these search criteria the next time you access the pivot grid. |

By Generated Positive Input Pagelet

Use the By Generated Positive Input pagelet to Analyze absence results associated with generated positive input.

This example illustrates the fields and controls on the By Generated Positive Input pagelet.

By Generated Positive Input ↻ ⚙

The pivot data was last refreshed on 18-Aug-2014 12:00:00 AM. [Refine Search Criteria](#)

⚙ ?

Filters

| | |
|---------------------------|---|
| PNA Earnings C... (All) ▼ | Pay Entity (All) ▼ |
| Retro Indicator (All) ▼ | Time Reporting... (All) ▼ |
| Workgroup (Blanks) | Business Unit Global Business Institut... |
| Company (All) ▼ | Contract Type (All) ▼ |
| Payroll Status (All) ▼ | Establishment (All) ▼ |
| FTE (All) ▼ | HR Status (All) ▼ |
| Job Title (All) ▼ | Location (All) ▼ |
| PNA Pay Group (All) ▼ | Regulatory Reg... (All) ▼ |

| | |
|--------|---------|
| 21.48% | 32.71% |
| 5.745% | 0.1596% |
| 5.745% | 9.974% |
| 24.18% | 5.745% |

| | | | | | | |
|---------|-------------|-------------|-------------|--------------|-------------|-------------|
| ■ K0PGA | ■ K0WPG KU2 | ■ K0WPG KU4 | ■ K0WPG PIA | ■ K0WPG PNA1 | ■ K0WPG TL1 | ■ K0WPG TLA |
|---------|-------------|-------------|-------------|--------------|-------------|-------------|

📊 📈 🌐 📄

By default, this pivot grid displays a pie chart displaying the percentages of units per absence event by pay group.

| Field or Control | Description |
|-------------------------------|--|
| Refine Search Criteria | By default, the pivot grid displays all the absence analytics data that you have loaded in your system. Click this link to access the Refine Search Criteria modal page, which enables you to analyze a smaller, refined set of data. After entering your search criteria, click Run to apply them. Click Save Criteria and Run if you want the system to apply these search criteria the next time you access the pivot grid. |

Using the PeopleSoft Fluid User Interface to Work with Absence Analytics as a Manager

For general information about fluid pages in PeopleSoft HCM, see “Understanding PeopleSoft Fluid User Interface Homepages” (Application Fundamentals)

Pages Used to Work with Absence Analytics as a Manager Using the PeopleSoft Fluid Interface

| <i>Page Name</i> | <i>Definition Name</i> | <i>Usage</i> |
|-------------------------------|---|--|
| <u>Absence Analytics Tile</u> | HC_HGA_EVENT_ANLY_FL_GBL (this is the cref for the tile) | Tap to access the Absence Analytics page. |
| <u>Absence Analytics Page</u> | HGA_PG_LAUNCH_FL | Analyze absence entries by status, absence type, absence take, and absence reason. |

Absence Analytics Tile

Use the Absence Analytics tile to access the Absence Analytics page.

Navigation:

Select **Fluid Home** under the main menu. On the page that appears, select *Manager Self Service*. The Absence Analytics tile is available on the Manager Self Service landing page.

As a manager, you can add the tile, through personalization, to a system-delivered homepage or a homepage that you create.

This example illustrates the Absence Analytics tile.



Tap the Absence Analytics tile to access the manager self-service absence analytic transaction easily without using traditional menu navigation.

Absence Analytics Page

Use the Absence Analytics page (HGA_PG_LAUNCH_FL) to analyze absence entries by status, absence type, absence take, and absence reason.

Navigation:

Tap the Absence Analytics tile on the Manager Self-Service fluid home page.

This example illustrates the fields and controls on the Absence Analytics page.

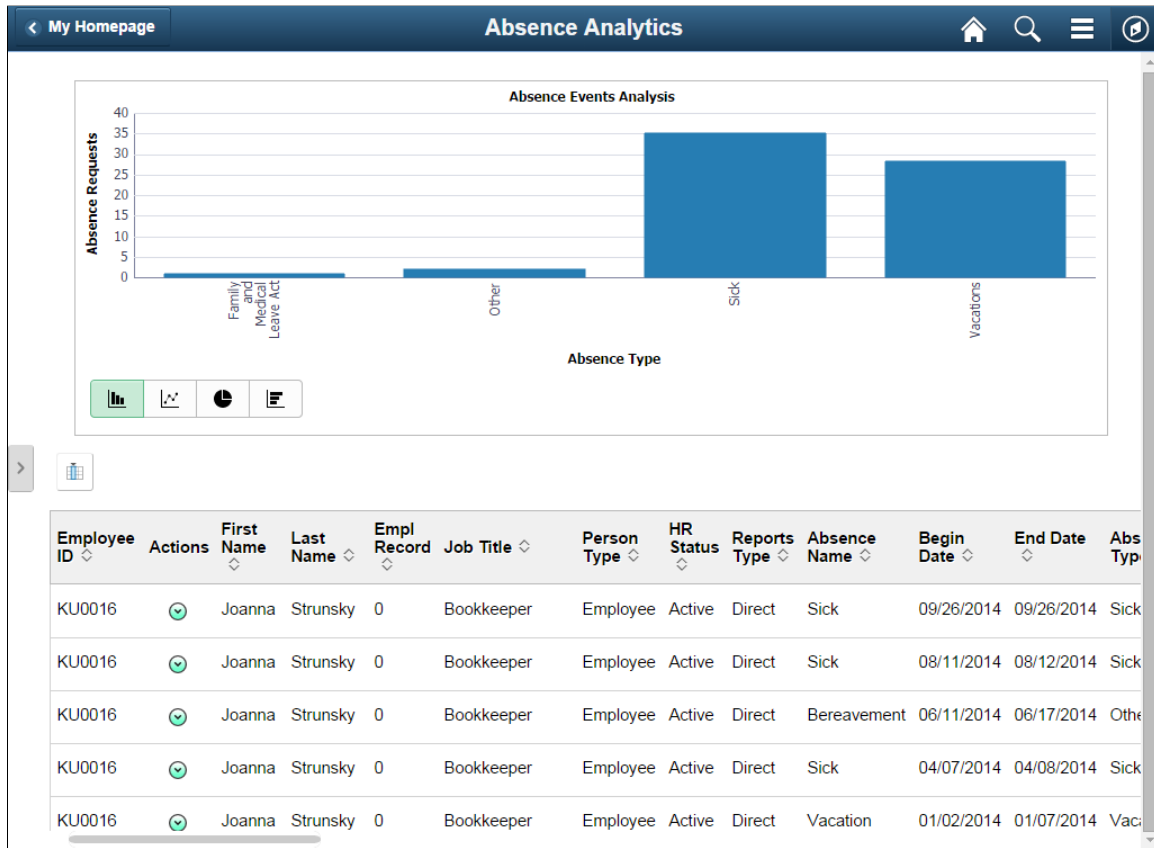

This page includes the Absence Events Analysis pivot grid, which by default displays a bar chart of your employees' absence requests by absence type. The page also displays a detailed grid view of your employees' absence requests.

| Field or Control | Description |
|-------------------------|---|
| Actions | <p>Tap the button in this column to access the available related actions for the absence request. Valid values are:</p> <ul style="list-style-type: none"> • <i>Notify Employee</i>: Tap to access the Notify Employee page where you can send a message to the employee associated with the absence request as an announcement, an email, or both. • <i>Approve Absence</i>: Tap to access the Approve Absence Requests page where you can approve, deny, or push back the absence request. • <i>View Absence</i>: Tap to access the Request Details page where you can view details for the absence request. • <i>Notify Approver</i>: Tap to access the Notify Approver page where you can send a message to the approver assigned to the absence request as an announcement, an email, or both. • <i>Notify Supervisor</i>: Tap to access the Notify Supervisor page where you can send a message to the supervisor associated with the absence request as an announcement, an email, or both. |

Related Links

[Absence Events Analysis Pagelet](#)

“Understanding PeopleSoft Fluid User Interface Homepages” (Application Fundamentals)

“Using the Manager Self-Service Homepage” (Application Fundamentals)

Transferring Leave Time

Understanding Leave Transfers

A leave transfer program enables employees to donate their accrued leave hours to other employees, who have exhausted their own leave due to a qualifying emergency.

Managing leave transfer request programs consists of four major functions:

- Program definition and page configurations.
- Employee self service requests to donate leave, request leave, terminate participation, return unused leave, and view a request history.
- Administrative actions that define program recipients, manage and approve employee self-service requests, adjust program bank balances, initiate payee requests and adjustments, and view transaction histories.
- The Leave Transfer Process (GP_ABSLVDNPI) Application Engine program processes all of the employee and administrator requests and inserts input data for Global Payroll core processing.

This diagram illustrates the process flow and relationship of the pages used to configure and manage the leave transfer request process.

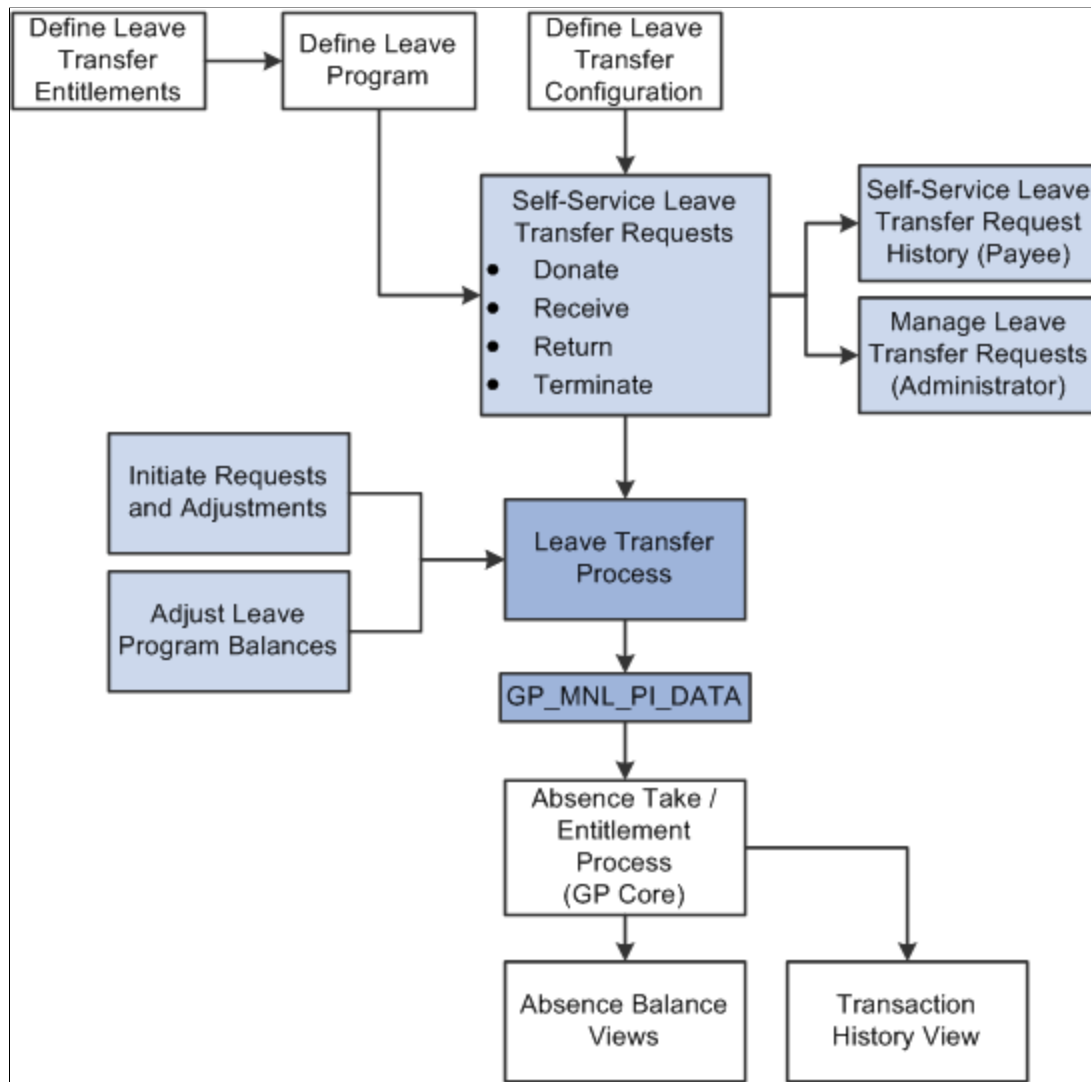

Defining Leave Transfer Entitlements

This topic discusses how to:

- Define new leave transfer entitlements
- Modify originating entitlement accumulators

Defining New Leave Transfer Entitlements

In order to set up a leave donation program in PeopleSoft Absence Management, you must define at least two frequency-based entitlements: a donate entitlement and a receive entitlement. Use a numeric entitlement type for each of these entitlements and set the leave transfer entitlement as well as the corresponding auto-assigned accumulators to either increase or decrease the units of the respective originating entitlement as necessary.

Many programs consider all donations from a donor irrevocable. However, if your leave transfer program enables participants to return unused leave time back to the program or donor you must also create a return entitlement.

You must create a leave transfer entitlement for each originating, or eligible to be donated, entitlement. For example, if your leave transfer program enables donors to contribute time from both sick leave and vacation time, you must define donate entitlements, receive entitlements, and, if applicable, return entitlements for both sick leave and vacation time.

Each of the leave transfer entitlements you create uses

- An Entitlement type of *Numeric*
- A Balance accumulator using the *BAL* suffix
- A Unit Adjustment component using the *UNAD* suffix.

Each leave transfer entitlement uses auto-assigned accumulators shown in the following tables:

- For the Donate entitlement:

| Element Name | Element Type | Accumulator Sign | Contribution |
|--------------------------|---------------------|-------------------------|---------------------|
| Donate Entitlement Units | Absence Entitlement | Add | 100% |
| Donate_UNAD | Auto-assign | Add | 100% |

- For the Receive entitlement:

| Element Name | Element Type | Accumulator Sign | Contribution |
|---------------------------|---------------------|-------------------------|---------------------|
| Receive Entitlement Units | Absence Entitlement | Add | 100% |
| Receive_UNAD | Auto-assign | Add | 100% |

- for the Return entitlement:

| Element Name | Element Type | Accumulator Sign | Contribution |
|--------------------------|---------------------|-------------------------|---------------------|
| Return Entitlement Units | Absence Entitlement | Add | 100% |
| Return_UNAD | Auto-assign | Add | 100% |

In addition, depending on your current business rules, you must add the leave transfer entitlements to the appropriate existing absence element group, with the Eligibility Assignment of *By Eligibility Group*, or to a new element group created specifically for these entitlements. If you create a new element group, it must also be added to the appropriate eligibility group.

Modifying Originating Entitlement Accumulators

After leave transfer entitlements have been defined, the Balance accumulator of the eligible originating entitlement must be modified to include the new leave transfer entitlements, as shown in the following example:

The user has a leave donation program that allows employees to donate from their accrued vacation leave. There are three entitlements involved in this scenario:

- *Vacation* is the eligible originating entitlement.
- *Donate* is the new donation leave transfer entitlement.
- *Receive* is the new entitlement for receiving leave donations.

In addition, the two new leave transfer entitlements have new corresponding accumulators.

In order for the leave transfer program to work properly, you must add the following element members to the Vacation entitlement Balance accumulator:

| Element Name | Element Type | Accumulator Sign | Contribution |
|---------------------------|---------------------|-------------------------|---------------------|
| Donate Entitlement Units | Absence Entitl | Subtract | 100% |
| Donate_UNAD | Auto-assign | Subtract | 100% |
| Receive Entitlement Units | Absence Entitl | Add | 100% |
| Receive_UNAD | Auto-assign | Add | 100% |

Setting Up Leave Transfers

Pages Used to Set Up Leave Transfers

| Page Name | Definition Name | Usage |
|---|------------------------|--|
| <u>Leave Program Definition Page</u> | GP_ABS_LVDN_PRG1 | Define the parameters for a leave transfer program. |
| <u>Leave Program Entitlements Page</u> | GP_ABS_LVDN_PRG2 | Define the entitlement parameters for a leave transfer program |
| <u>Leave Program Board Members Page</u> | GP_ABS_LVDN_PRG3 | Define the board members of a leave transfer program |

| Page Name | Definition Name | Usage |
|--|------------------------|---|
| <u>Leave Transfer Configuration Page</u> | GP_ABS_LVDN_CFG | Define whether or not to display agreement and compliance confirmation as well as which, if any, leave reasons can be selected when submitting requests to receive leave. |
| <u>Leave Transfer Recipients Page</u> | GP_ABS_LVDN_RCP | Use this page to specify the eligible recipients for a leave transfer program. |

Leave Program Definition Page

Use the Leave Program Definition page (GP_ABS_LVDN_PRG1) to define the parameters for a leave transfer program.

Navigation:

Set Up HCM > Product Related > Global Payroll & Absence Mgmt > Absence Management > Define Leave Donation Program > Leave Program Definition

This example illustrates the fields and controls on the Leave Program Definition page.

| Field or Control | Description |
|-------------------------|---|
| Leave Program | Displays the name of the leave transfer program. |
| Unit Type | Select the time units for the leave transfer program, either hours or days. |

| <i>Field or Control</i> | <i>Description</i> |
|--------------------------------|--|
| Leave Program Category | <p>Indicate how hours contributed to the leave transfer program are allocated.</p> <ul style="list-style-type: none"> • Select Individual to enable contributors to specify a recipient for the contributed hours. • Select Bank when the contributed hours for this program are held in a single pool of hours. |
| Leave Program Type | <p>Specify whether the leave transfer program is ongoing or has been created for a specific event.</p> <ul style="list-style-type: none"> • Select Emergency if the leave transfer program is established to respond to a specific emergency or crisis. • Select Voluntary to establish an ongoing, voluntary leave transfer program. |
| Begin Date and End Date | <p>Enter the start and end dates for the leave transfer program. For ongoing programs, leave the End Date field empty.</p> |
| Target Donation Hours | <p>Specify the number of accrued hours desired for the leave transfer program. This is typically specified for emergency leave transfer programs.</p> |
| Contribution Type | <p>Specify whether contributors can make recurring contributions to the leave transfer program.</p> <ul style="list-style-type: none"> • Select One-Time to enable contributors to make a one-time donation of hours. • Select Recurring to enable contributors to regularly donate hours to the leave transfer program. For example, contribute hours every pay period. • Select Recurring or One-Time to enable contributors to donate hours to the leave transfer program either one-time or regularly. |

Program Balance Limits

| <i>Field or Control</i> | <i>Description</i> |
|-------------------------|--|
| Minimum Hours | <p>Enter the minimum number of hours to maintain in the leave transfer program. The system will not disperse any hours unless the number of available contributed hours is greater than this number.</p> |

| Field or Control | Description |
|-------------------------|--|
| Maximum Hours | Enter the maximum number of hours to maintain in the leave transfer program. The system stops accruing contributions from all employees when the value in this field is reached or exceeded. |

Payee Contribution Limits

| Field or Control | Description |
|-------------------------|---|
| Frequency | Indicate how often employees can contribute to the leave transfer program. The valid values are: <ul style="list-style-type: none"> • Monthly • Quarterly • Annual |
| Minimum Hours | Enter the minimum number of hours each employee can contribute to the leave transfer program for each recurring contribution. For example if the Frequency is <i>Monthly</i> and you enter a value of 10 for the Minimum Hours field, then each employee that contributes to the leave transfer program must donate at least 10 hours of leave time each month. |
| Maximum Hours | Enter the maximum number of hours that each employee can contribute to the leave transfer program for each recurring contribution. This prevents employees from donating more hours than they regularly receive from the company. |
| Ceiling Limit | Enter the maximum contribution a single employee can make to a program over the duration of the leave transfer program, as specified by the program begin and end dates. The system will not accumulate any contributions from an employee once his or her donations reach this amount. |

Return of Unused Leave

| <i>Field or Control</i> | <i>Description</i> |
|---|---|
| Allow recipient to return unused leave | Select this check box to enable a recipient to return unused hours to the contributors. Selecting this field enables you to specify the Usage Allocation Method . The system calculates the number of leave hours that should be returned to each contributor based on the Usage Allocation Method specified. When this field is selected, the system verifies that a return entitlement has been defined and associated with the originating element. |
| Usage Allocation Method | <p>The fields in this region are only active when you select the Allow recipient to return unused leave check box and the Leave Program Category is set to Individual.</p> <ul style="list-style-type: none"> When you select Weighted Average, the system calculates the usage of donated hours based on the total number of hours donated to an individual, against the amount of each contributor's donated time to that individual when an approved request is processed. Select FIFO to use the leave time contributed to the program in the order the hours were received. |

The scenario shows the difference in calculation between the two usage allocation methods. In this example, three donors have contributed a total of 45 hours to the leave transfer program and the recipient uses 15 of those donated hours. The recipient then enters a leave return request for the remaining hours. The following table describes the individual contributions and distribution of contributed hours using the two different usage allocation methods:

| <i>Donor</i> | <i>Donation Date</i> | <i>Donated Hours</i> | <i>Percentage of the Total Hours (Individual Donation / Total Donations)</i> | <i>Usage Allocation: FIFO Method</i> | <i>Usage Allocation: Weighted Average (Hours Used * Percentage of Total Hours)</i> |
|--------------|----------------------|----------------------|--|--|--|
| A | January 1 | 10 | 22% | 0 | 6.6 |
| B | February 1 | 15 | 33% | 10 | 9.9 |
| C | March 1 | 20 | 45% | 20 | 13.5 |

| Donor | Donation Date | Donated Hours | Percentage of the Total Hours (Individual Donation / Total Donations) | Usage Allocation: FIFO Method | Usage Allocation: Weighted Average (Hours Used * Percentage of Total Hours) |
|--------------|----------------------|----------------------|--|--|--|
| TOTALS | | 45 Hours | | 30 Hours | 30 Hours |

In this example, Donor C contributed 20 hours to the leave transfer program, but was the last donor to contribute. The 20 contributed hours represents 45% (20 hours / 45 hours) of the hours in the leave transfer program at the time the recipient's request was processed. Using the FIFO method, the hours contributed by Donor C would not be used, since the hours donated by the other contributors were sufficient to cover the requested and returned number of hours. Using the Weighted Average allocation method, Donor C contributes 45% of the recipient's requested hours, or 13.5 hours (30 hours returned * 45%.)

Leave Program Entitlements Page

Use the Leave Program Entitlements page (GP_ABS_LVDN_PRG2) to .

Navigation:

Set Up HCM > Product Related > Global Payroll & Absence Mgmt > Absence Management > Define Leave Donation Program > Leave Program Entitlements

This example illustrates the fields and controls on the Leave Program Entitlements page.

The screenshot shows the 'Define Leave Donation Program' page with the 'Leave Program Entitlements' tab selected. The page displays the following details:

- Country:** USA (United States)
- Leave Program:** KOWINVEMY
- Description:** Individual Emergency
- Unit Type:** Hours
- Status:** Active
- Short Description:** Ind Emerg

Leave Program Details

Entitlement Tracking

| *Eligible Entitlement | *Target Donate Entitlement | *Target Receive Entitlement | *Target Return Entitlement | | |
|-----------------------|----------------------------|-----------------------------|----------------------------|---|---|
| Sick | Target Sick Donate Entitle | Target Sick Receive Ent | Target Sick Return Entitle | + | - |
| Bereavement | | | | + | - |

Allow donor to terminate participation in program
 Allow donor to automatically be an eligible recipient in program

Approval Process

Approval Process ID: Abs Mgmt - Leave Donations
 Approval Definition ID: Leave Donations

Buttons: Save, Return to Search, Previous in List, Next in List, Notify, Add, Update/Display

Use this page to define the eligible entitlements that may be donated to the leave transfer program. The eligible entitlements are then associated or linked with the defined donate entitlement, receive entitlement,

and return entitlement. The association between eligible entitlements and the target entitlements is a one to one relationship.

Note: After running the first leave transfer process for a leave transfer program definition, you cannot make changes to the program definition other than to change the status to *Inactive*. If the parameters of a leave transfer program change, then you must define a new leave transfer program.

| Field or Control | Description |
|---|--|
| Eligible Entitlement | Select an active, eligible, entitlement. You can add multiple entitlements. |
| Target Donate Entitlement | Enter the donate entitlement that participants can use to donate leave time, such as a vacation donation entitlement, or a sick leave donation entitlement. |
| Target Receive Entitlement | Enter the receive entitlement for participant leave donations. |
| Target Return Entitlement | Enter the return entitlement, if any, that is used to return unused leave time back to the donor or leave transfer program. |
| Allow donor to terminate participation in program | Select this field to enable a donors to terminate their participation or enrollment in the leave transfer program |
| Allow donor to automatically be an eligible recipient in program | Select this field to enable an approved donor to also be an eligible recipient of the leave transfer program. When this check box is selected, approved donors are automatically added to the list of leave transfer recipients. |
| Approval Process ID | Enter the ID associated with a particular approval process definition in the Approval Workflow Engine. Each transaction registered with the Approval Workflow Engine must have at least one defined process ID. |
| Approval Definition ID | Enter the definition of the approval process within the Approval Workflow Engine. The definition can contain stages, paths, steps, varying hierarchies, and criteria, as well as other configurable parameters. |

Leave Program Board Members Page

Use the Leave Program Board Members page (GP_ABS_LVDN_PRG3) to update the details of board members for the leave program.

Navigation:

Set Up HCM > Product Related > Global Payroll & Absence Mgmt > Absence Management > Define Leave Donation Program > Leave Program Members

This example illustrates the fields and controls on the Leave Program Board Members page.

| Define Leave Donation Program | | | |
|------------------------------------|----------------------|--|-----------|
| Leave Program Definition | | Leave Program Entitlements | |
| Leave Program Board Members | | | |
| Country | USA | United States | |
| Leave Program | K0WINVEMY | Status | Active |
| Description | Individual Emergency | Short Description | Ind Emerg |
| Unit Type | Hours | | |
| Board Members | | | |
| <input type="text" value="Ryan"/> | | <input type="text" value="ryan.philip@gmail.com"/> | |

Enter the full name and email address for each board member.

Leave Transfer Configuration Page

Use the Leave Transfer Configuration page (GP_ABS_LVDN_CFG) to used this page to define whether or not to display agreement and compliance confirmation as well as which, if any, leave reasons can be selected when submitting requests to receive leave.

Navigation:

Set Up HCM > Product Related > Global Payroll & Absence Mgmt > Absence Management > Configure Leave Transfer Setup > Leave Transfer Configuration

This example illustrates the fields and controls on the Leave Transfer Configuration page.

Leave Transfer Configuration

Country USA United States

Leave Donation Configuration
1 of 1 | View All

*Effective Date *Status + -

Donate Request

Require Acceptance of Donation Requests Acknowledgement ID

Receive Request

Reasons

| Leave Reason | Description Text ID | Display Reason | Order of Appearance | | |
|-----------------------|---------------------|-------------------------------------|---------------------|---|---|
| Waiting Period | RECV_REASON_1 | <input checked="" type="checkbox"/> | 3 | + | - |
| Short Term Disability | RECV_REASON_2 | <input checked="" type="checkbox"/> | 1 | + | - |
| Paid Family Leave | RECV_REASON_3 | <input checked="" type="checkbox"/> | 2 | + | - |

Require Acceptance of Recipient Requests Acknowledgement ID

Terminate Request

Require Acceptance of Termination Requests Acknowledgement ID

This page controls some of the fields displayed on the self service requests pages. You can specify whether or not to display agreement and compliance confirmation.

| Field or Control | Description |
|---|--|
| Require Acceptance of Donation Requests | Select this field to require users to agree to the terms of the leave transfer program on the Request to Donate Leave page before a request to donate leave can be submitted. |
| Leave Reason | Define which leave reasons can be selected when requesting a donated leave transfer. The valid values are: Disability, Other, Paid Leave, Waiting Pd |
| Require Acceptance of Recipient Requests | Select this field to require users to agree to the terms of the leave transfer program on the Request to Receive Donated Leave page before a request to receive leave time can be submitted. |
| Require Acceptance of Termination Requests | Select this field to require users to agree to the terms of the leave transfer program on the Request to Terminate Participation page before a donor can end his or her participation in a leave transfer program. |

| Field or Control | Description |
|---------------------------|---|
| Acknowledgement ID | Select the required Acknowledgement IDs for Donating, Receiving or Terminating the leave donation. For creating acknowledgement IDs, see the “Setting Up the Acknowledgement Framework” (Enterprise Components) topic. |

Leave Transfer Recipients Page

Use the Leave Transfer Recipients page (GP_ABS_LVDN_RCP) to use this page to specify the eligible recipients for a leave transfer program.

Navigation:

Global Payroll & Absence Mgmt > Payee Data > Leave Donations > Add Leave Transfer Recipients > Leave Transfer Recipients

This example illustrates the fields and controls on the Leave Transfer Recipients page.

Leave Transfer Recipients

| | | | | | |
|---------------|----------------------|---------------|-------------------|------------|--------|
| Country | USA | United States | | Status | Active |
| Leave Program | K0WINVEMY | | Short Description | Ind Emerg | |
| Description | Individual Emergency | | Unit Type | Hours | |
| Begin Date | 01/01/2008 | | End Date | 31/12/2025 | |

List of Qualified Recipients

1-1 of 1

| *Empl ID | Empl Record | Name | *Begin Date | *End Date | Comments |
|----------|-------------|---------------|-------------|------------|----------|
| K0G001 | 0 | Rebekah Jones | 01/01/2008 | 31/12/2025 | Comments |

Use this page to define the recipients for a leave transfer program.

| Field or Control | Description |
|--------------------------------|---|
| Begin Date and End Date | Enter the dates that a recipient in the leave transfer program is eligible to receive leave time from the program. |
| Comments | Click to open the Comments page. The Comments page enables an administrator to enter information such as an explanation of why a recipient is eligible to receive donated leave time. |

Using Leave Donation Self Service Requests

Pages Used to Donate and Receive Leave Time

| Page Name | Definition Name | Usage |
|---|--------------------|--|
| Request to Donate Leave Page | GP_ABS_LVDN_SSDON | Donate leave time to an eligible employee or to a leave bank. |
| Request to Receive Donated Leave Page | GP_ABS_LVDN_SSRECV | Request donated leave from a leave program for yourself or on behalf of another employee |
| Request to Return Unused Leave Page | GP_ABS_LVDN_SSRETN | Return unused donated leave to the donors or a leave bank. |
| Request to Terminate Participation Page | GP_ABS_LVDN_SSTERM | Used to terminate recurring participation or enrollment in a leave transfer program |
| Leave Transfer Requests History Page | GP_ABS_LVDN_EEHIST | Enables employees to view the history and status of their leave donation requests and edit any saved requests. |

Request to Donate Leave Page

Use the Request to Donate Leave page (GP_ABS_LVDN_SSDON) to donate leave time to an eligible employee or to a leave bank.

Navigation:

Self Service > Leave Transfer Requests > Donate Leave Request

This example illustrates the fields and controls on the Request to Donate Leave page (1 of 2).

Request to Donate Leave

Antonio Smith
Administrator

This form may be used to Donate leave time to either an eligible employee or to a leave bank.

Employees on written warning may not donate accrued leave time. Additionally, employees who have provided notice or have been given notice of termination of employment may not donate time.

Donation Program

*Program Name: Select Program

| | |
|-------------------|---------------|
| Category | Type |
| Contribution Type | Frequency |
| Unit Type | Ceiling Limit |
| Minimum Days | Maximum Days |
| Begin Date | End Date |

Leave Contribution Personalize | Find | First 1 of 1 Last

| From Entitlement | Balance | Days to Donate | Recipient Type | Name | Details | Delete |
|---|---------|----------------------|---|--|-------------------------|------------------------|
| Select Entitlement | Balance | <input type="text"/> | | <input style="width: 80%;" type="text"/> | Details | Delete |

[Add Contribution](#)

This example illustrates the fields and controls on the Request to Donate Leave page (2 of 2).

Comments

Requester Comments

Agreement and Compliance

- I have read the Leave Donation Policy.
- I acknowledge that if I am donating hours/days to this program or to another employee, I authorize the donation of hours/days and understand that the donation is irrevocable.
- I certify that I have not provided or been given notice of termination.

I hereby confirm that I have read and comply with the above statements.

Submit
Save for Later

| Field or Control | Description |
|--------------------------|--|
| Description | Enter the name of an active leave transfer program. |
| Category | Displays how hours contributed to the selected leave transfer program are allocated. Leave time is donated either to an individual or a leave bank. |
| Type | Shows whether the selected leave transfer program is ongoing or has been created for a specific event. Valid values are <i>Voluntary</i> or <i>Emergency</i> . |
| Contribution Type | Shows whether contributors can make a single contribution or recurring contributions to the selected leave transfer program. |
| Unit Type | Displays the time units for the selected leave transfer program, either hours or days. The names of other fields on this page may change to reflect the displayed Unit Type . |
| Frequency | Displays how often employees can contribute to the selected leave transfer program. |
| Ceiling Limit | Displays the maximum contribution a single employee can make to the selected leave transfer program. |
| Minimum | Displays the minimum number of hours an employee can contribute to the selected leave transfer program for each recurring contribution. |
| Maximum | Displays the maximum number of hours an employee can contribute to the selected leave transfer program for each recurring contribution. |

| Field or Control | Description |
|---------------------------------|---|
| From Entitlement | Select the entitlement plan to receive your donated time. You can only select entitlements that have been defined at the program definition level. For example, select from vacation time or available sick time any hours or days you want to donate to the selected leave transfer program. |
| Balance | Click to access the current Balance Inquiry page to view your accrual balances, including the leave transfer entitlement balances for defined donated, received, and returned entitlements. |
| Days to Donate | Enter the amount of time you want to donate to the selected leave transfer program. The name of this field changes to Hours to Donate when the Unit Type is set to <i>Hours</i> . |
| Recipient Type | Select the of individual that is receiving donated leave time. This field is not available when the Category is set to <i>Bank</i> . Valid values are: <i>Employee</i> and <i>Other</i> . Selecting <i>Employee</i> enables you to enter a value in the Name field. |
| Name | Enter the name of the individual leave transfer recipient. |
| Details | Click to enter information regarding donations between agencies on the Details page. |
| Agreement and Compliance | Select the check box in this region to agree to the terms of the leave transfer program. You cannot submit the request to donate leave time until the check box in this region is selected. You do not need to select the check box in this region when you click the Save for Later button. |

Request to Receive Donated Leave Page

Use the Request to Receive Donated Leave page (GP_ABS_LVDN_SSRECV) to receive leaves from an eligible employee or a leave bank.

Navigation:

Self Service > Leave Transfer Requests > Receive Donated Leave Request

This example illustrates the fields and controls on the Request to Receive Donated Leave page (1 of 2).

Request to Receive Donated Leave

Antonio Smith
Administrator

This form may be used to request donated leave from a leave program for yourself or on behalf of another employee.

Donation Program

*Program Name: Select Program

| | |
|-------------------|---------------|
| Category | Type |
| Contribution Type | Frequency |
| Unit Type | Ceiling Limit |
| Minimum Days | Maximum Days |
| Begin Date | End Date |

Leave Time Request

*Recipient: Self Recipient Name:

*Begin Date: BY *End Date: BY

*Days Requested: [View Balances](#)

This is a Recurring Occurrence

This example illustrates the fields and controls on the Request to Receive Donated Leave page (2 of 2).

Leave Reason

Reason

| Description |
|---|
| <input type="radio"/> I am taking a Family Care Leave to care for an immediate family member with a catastrophic illness or injury. |
| <input type="radio"/> I am taking a Leave for my own catastrophic illness or injury. |
| <input type="radio"/> I need to cover the 7 calendar day waiting period before Short Term Disability or Paid Family Leave (California employees only) begins. |
| <input type="radio"/> Other (Please provide additional details.) |

Additional Details: BY

Comments

Requester Comments: BY

Agreement and Compliance

- I have read the Leave Donation Policy.
- I certify that I have not provided or been given notice of termination.
- I certify that I am currently not on a written warning of any kind.

I hereby confirm that I have read and comply with the above statements.

Submit
Save for Later

This page enables a user, or their proxy, to request donated leave hours from a leave transfer program with a *Bank* program category. This request needs to be approved by a leave transfer administrator.

Note: Leave transfer programs that use the *Individual* program category do not require a request to receive donated leave.

Enter the leave transfer program name in the **Description** field. The system automatically populates the other fields in the **Donation Program** region.

| Field or Control | Description |
|---------------------------------------|--|
| Recipient | Select Other Employee if you are requesting leave time for another employee. You must enter the name of the employee in the Recipient Name field. Select Self if you are requesting leave time for yourself. The Recipient Name field is not available when you request leave time for yourself. |
| Start Date and End Date | Enter the start and end dates for the requested leave time. |
| Days Requested | Enter the amount of donated leave time requested for the specified employee. The name of this field changes to Hours Requested when the Unit Type is set to <i>Hours</i> . |
| View Balances | Click to access the current Balance Inquiry page in order to view the specified employee's accrual balances, including the leave transfer entitlement balances for defined donated, received, and returned entitlements. |
| This is a Recurring Occurrence | Select to indicate an ongoing condition. This field is informational only. |
| Reason | Select the reason for this leave request. The available choices are defined on the Leave Transfer Configuration page. |
| Agreement and Compliance | Select the check box in this region to agree to the terms of the leave transfer program. You cannot submit the request to receive donated leave time until the check box in this region is selected. You do not need to select the check box in this region when you click the Save for Later button. |

Request to Return Unused Leave Page

Use the Request to Return Unused Leave page (GP_ABS_LVDN_SSRETN) to return unused donated leave to the donors or a leave bank.

Navigation:

Self Service > Leave Transfer Requests > Return Unused Leave Request

This example illustrates the fields and controls on the Request to Return Unused Leave page.

Request to Return Unused Leave

Antonio Smith
Administrator
This form is used to return unused donated leave to the donors.

Donation Program

*Program Name:

| | |
|-------------------|---------------|
| Category | Type |
| Contribution Type | Frequency |
| Unit Type | Ceiling Limit |
| Minimum Days | Maximum Days |
| Begin Date | End Date |

Return of Unused Leave

Unused Days to Return: 0.00

Additional Details:

Comments

Requester Comments:

This page enables a leave recipient to return any unused leave time back to the donors or the leave transfer program.

Enter the leave transfer program name in the **Description** field. The system automatically populates the other fields in the **Donation Program** region.

| Field or Control | Description |
|------------------------------|---|
| Unused Days to Return | <p>Displays the amount of unused leave time that the system is to return. The system returns the lesser of the target balance accumulator (RECIEVE_BAL) or the current leave balance of the originating entitlement.</p> <p>When the request has been processed, the name of this field is Unused Days Returned.The name of this field changes to Unused Hours to Return or Unused Hours Returnedwhen the Unit Type is set to <i>Hours</i>.</p> |

Request to Terminate Participation Page

Use the Request to Terminate Participation page (GP_ABS_LVDN_SSTERM) to end the participation of enrolment in a leave program.

Navigation:

Self Service > Leave Transfer Requests > End Leave Transfer Request > Request to Terminate Participation

This example illustrates the fields and controls on the Request to Terminate Participation page.

Request to Terminate Participation

Antonio Smith
Administrator

This form is used to terminate participation or enrollment in a leave program.

Donation Program

*Program Name:

| | |
|-------------------|---------------|
| Category | Type |
| Contribution Type | Frequency |
| Unit Type | Ceiling Limit |
| Minimum | Maximum |
| Begin Date | End Date |

Terminate Program Participation

Termination Date: 01/03/2014

Comments

Requester Comments:

Agreement and Compliance

I acknowledge and understand that donated leave hours or days are forfeited by me and are non-returnable.

I hereby confirm that I have read and comply with the above statements.

This page enables a donor to end his or her participation in a banked leave program where the donation occurs on a recurring basis.

The system does not return any donated leave time when an employee ends his or her participation in a leave transfer program. The return of unused leave time is set up at the program definition level and is controlled by the Request to Return Unused Leave page. Termination of enrollment occurs during the next available calendar run after the termination request has been approved.

Note: Terminating leave program participation and returning unused leave time are auto-approved requests. The system automatically approves these requests without input from a program administrator.

Enter the leave transfer program name in the **Description** field. The system automatically populates the other fields in the **Donation Program** region.

| Field or Control | Description |
|---------------------------------|--|
| Termination Date | Displays the current date. This date indicates the effective date to end participation in the leave transfer program. The recurring donation stops during the next available open calendar run. |
| Agreement and Compliance | Select the check box in this region to agree to the terms of the leave transfer program. You cannot terminate your participation in the leave transfer program until the check box in this region is selected. You do not need to select the check box in this region when you click the Save for Later button. |

Leave Transfer Requests History Page

Use the Leave Transfer Requests History page (GP_ABS_LVDN_EEHIST) to enables employees to view the history and status of their leave donation requests and edit any saved requests.

Navigation:

Self Service > Leave Transfer Requests > Leave Transfer Request History



This page enables an employee to view, track, and edit any outstanding leave donation program requests.

This example illustrates the fields and controls on the Leave Transfer Requests History page.

Leave Transfer Requests History

Antonio Smith
Administrator

Specify the date range of interest. To retrieve a complete history, leave From and Through dates blank and select Refresh. Select the Request Type link to view request details. Select Edit button to modify and delete the request.

Begin Date  End Date 

| Field or Control | Description |
|--------------------------------|---|
| Begin Date and End Date | Enter the date range to manage and click the Refresh button to limit the list of dates displayed in the Request History region. Retrieve a complete history by leaving the Begin Date and End Date fields empty and clicking the Refresh button |
| Submit Date | Displays the date that leave time was received from or donated to a leave transfer program. |
| Request Type | Displays the type of request. <i>Donate</i> indicates that you requested a donation to the leave transfer program specified in the Leave Program Name field. <i>Receive</i> indicates that the system received a request to receive donated leave time. Click on each value in the Request Type column to display the details of the request. |

| Field or Control | Description |
|-------------------------|--|
| Workflow Status | <p>Displays the status of the request. Values are:</p> <ul style="list-style-type: none"> • <i>Saved</i> • <i>Submitted</i> • <i>Approved</i> • <i>Denied</i> • <i>Cancelled</i> • <i>Push Back</i> <p>Indicating that the request needs rework.</p> <ul style="list-style-type: none"> • <i>Error</i> <p>Indicating that the request has an error and the user should contact the leave program administrator.</p> <ul style="list-style-type: none"> • <i>FnI Apprvl</i> (final approval) <p>Indicating that the request is awaiting final approval.</p> <ul style="list-style-type: none"> • <i>Apprvl Prc</i> (Approval Process) <p>Indicating that the request is in the approval process.</p> <ul style="list-style-type: none"> • <i>Admin Proc</i> (administrator processing) <p>Indicating that the administrator is processing the request.</p> <p>The values in the Workflow Status field are derived from the Absence Management table values, rather than from the Approval Workflow Engine (AWE) status values.</p> |
| Process Status | <p>Displays the process status of the request. Values are <i>Processed</i> or <i>Unprocessed</i>.</p> <hr/> <p>Note: Denied or Unprocessed request are not available for editing.</p> <hr/> |

Using The PeopleSoft Fluid To Manage Leave Donation As An Employee

Employees can use the PeopleSoft Fluid User Interface to donate, receive, terminate, and view leave donation history.

Pages Used to Manage Leave Donation

| Page Name | Definition Name | Usage |
|--|--|--|
| <u>Manage Leave Donation Tile</u> | CREF for the tile is HC_HGA_LVDN_LAUNCH_FL | Access the Manage Leave Donation home page. |
| <u>Manage Leave Donation Home Page</u> | HC_HGA_LVDN_LAUNCH_FL | Access the fluid leave donation pages. |
| <u>Donate Leave Page</u> | HC_HGA_LVDN_REQDON_FL | Donate leave time to an eligible employee or to a leave bank. |
| <u>Receive Leave Donation Page</u> | HC_HGA_LVDN_SSRCV_FLU | Request donated leave from a leave program for yourself or on behalf of another employee. |
| <u>Return Unused Leave Page</u> | HC_HGA_LVDN_SSRET_FL_GBL | Return unused donated leave to the donors or a leave bank. |
| <u>End Leave Donation Page</u> | HC_HGA_LVDN_SSEND_FL_GBL | Used to terminate recurring participation or enrollment in a leave donation program. |
| <u>Leave Donation History Page</u> | HC_HGA_SS_LD_HIST_FL_GBL | Enables employees to view the history and status of their leave donation requests and edit any saved requests. |

Manage Leave Donation Tile

Use the Manage Leave Donation tile (CREF is HC_HGA_LVDN_LAUNCH_FL) to access the Manage Leave Donation home page and perform leave donation transactions. Users can also access this tile in SFF: Small Form Factor, such as smart phones.

Navigation:

Employee Self Service > Time

This example illustrates the Manage Leave Donation tile.



Use the Manage Leave Donation tile to access the leave donation transactions easily without using traditional menu navigations.

Manage Leave Donation Home Page

Use the Manage Leave Donation home page (HC_HGA_LVDN_LAUNCH_FL) to access the leave donation transactions.

Navigation:

Select the Manage Leave Donation Tile.

This example illustrates the Manage Leave Donation home page.

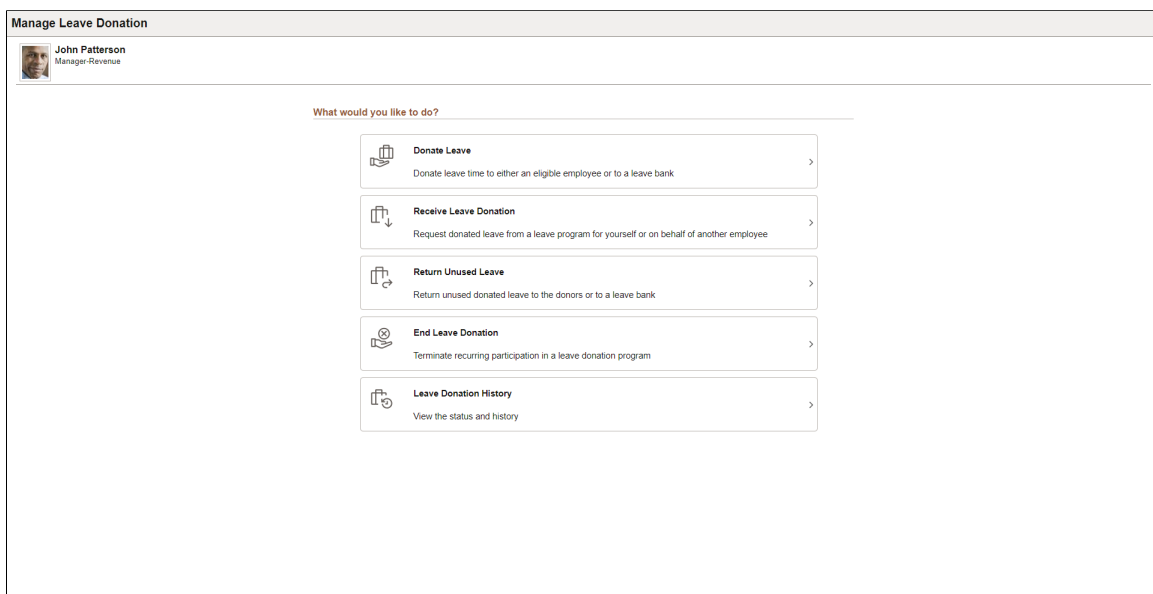

The employee can access the following leave donation transactions using the Manage Leave Donation home page:

- Donate Leave
- Receive Leave Donation

- Return Unused Leave
- End Leave Donation
- Leave Donation History

Note: By default, the home page displays only the **Donate Leave** and **Receive Leave Donation** tiles. Once the employee donates or requests a leave donation, the **Leave Donation History** tile appears. The employee can see the **Return Unused Leave** and **End Leave Donation** tiles after the absence calendar is finalized.

Donate Leave Page

Use the Donate Leave page (HC_HGA_LVDN_REQDON_FL) to donate leave time to an eligible employee or to a leave bank.

Navigation:

Employee Self Service > Time > Manage Leave Donation > Donate Leave

This example illustrates the fields and controls on the Donate Leave page when the employee has not made any leave donation.

Leave Donation

Rosanna Channing
Senior Accounting Manager

[Return to selection page](#)

Donate Leave

This page may be used to Donate leave time to either an eligible employee or to leave bank. Employees on written warning may not donate accrued leave time. Additionally, employees who have provided notice or have been given notice of termination of employment may not donate time.

This example illustrates the fields and controls on the Leave Donation page with existing requests.

Leave Donation

Daryl Reese
Financial Analyst

[Return to selection page](#)



Donate Leave

This page may be used to Donate leave time to either an eligible employee or to leave bank. Employees on written warning may not donate accrued leave time. Additionally, employees who have provided notice or have been given notice of termination of employment may not donate time.

View Requests 4 rows

+

| Program Name / Type | Submit Date | Approval Status |
|-------------------------------|-------------|-----------------|
| Bank Voluntary / Voluntary | 02/24/2016 | Submitted > |
| Bank Voluntary / Voluntary | 06/28/2017 | Submitted > |
| Catastrophic Plan / Emergency | 11/14/2023 | Approved > |
| Catastrophic Plan / Emergency | | Approved > |

| Field or Control | Description |
|--|---|
| Return to selection page | Select to go back to the Manage Leave Donation home page. |
|  or  | Select to open the Leave Program Details modal and select a leave program for the leave donation. |

This example illustrates the fields and controls on the Leave Program Details Modal.

Cancel
Leave Program Details
Done

*Leave Program Bank Voluntary ▼

Program Details

Category Bank

Leave Program Type Voluntary

Contribution Type Recurring

Frequency Monthly

Unit Type Hours

Ceiling Limit 80.00

Minimum 8.00

Maximum 200.00

Begin Date 01/01/2008

End Date

| Field or Control | Description |
|---------------------------|---|
| Leave Program | Select the name of an active leave donation program. |
| Category | Displays how the contributed units of time (hours or days) are allocated to the selected leave donation program. Leave time is donated either to an individual or a leave bank. |
| Leave Program Type | Displays if the selected leave donation program is ongoing or has been created for a specific event. Valid values are <i>Voluntary</i> or <i>Emergency</i> . |

| Field or Control | Description |
|--------------------------|--|
| Contribution Type | Displays if the contributors can make a single contribution or recurring contributions to the selected leave donation program. |
| Frequency | Displays how often the employees can contribute to the selected leave donation program. |
| Unit Type | Displays the time units for the selected leave donation program, either hours or days. The names of other fields on this page may change to reflect the displayed Unit Type . To configure the Unit Type, see Leave Program Definition Page . |
| Ceiling Limit | Displays the maximum contribution a single employee can make to the selected leave donation program over the duration of the program, as specified by the program begin and end dates. The system will not accumulate any contributions from an employee once his or her donations reach this limit. |
| Minimum | Displays the minimum units of time an employee can contribute to the selected leave donation program for each recurring contribution. |
| Maximum | Displays the maximum units of time an employee can contribute to the selected leave donation program for each recurring contribution. |
| Begin Date | Displays the start date of the leave program selected. |
| End Date | Displays the end date of the leave program selected if available. |
| Done | Select to open the Define Contribution page and submit the leave donation. |

Use the Define Contribution page to view the program details and update the leave contribution information.

This example illustrates the fields and controls on the Define Contribution page.

| Field or Control | Description |
|----------------------------------|--|
| Return to Program Summary | Select to go back to the Leave Donation page. |
| Program Details | Displays the selected program details for donating leaves. |
| Expanded View | Toggle the expanded view between <i>Yes</i> or <i>No</i> to show or hide the program details like <i>Program Name</i> , <i>Type</i> , <i>Category</i> , <i>Contribution Type</i> , <i>Unit Type</i> , and <i>End Date</i> . |
| Entitlement | Select the entitlement plan to donate your time. You can only select entitlements that have been defined at the program definition level. For example, select from vacation time or available sick time any hours or days you want to donate to the selected leave donation program. |
| Balance | Select to open the Balances page in a modal and view your available balances. |
| Hours to Donate | Enter the units of time (hours or days) to donate to the selected leave donation program. |
| Name | Enter the name of the individual leave donation recipient. |
| Requester Comments | Enter comments to the approver for your leave donation request. |
| Submit | Select to open the <i>Agreement and Compliance</i> modal to confirm your submission. |
| Save for later | Select to save your request without submitting to manage your leave donation at a later time. |

Select the check box in the **Agreement and Compliance** modal to agree to the terms of the leave donation program. You cannot submit the request to donate leave time until the check box in this region is selected. These acknowledgements are assigned on the Leave Transfer Configuration page for every leave donation transaction. For more information, see [Leave Transfer Configuration Page](#) and “Setting Up the Acknowledgement Framework” (Enterprise Components) topics.

Select **Confirm and Accept** to submit your leave contribution for approval.

Employees can view the submitted donation requests from the **View Requests** section on the **Leave Donation** page.

This example illustrates the fields and controls on the Define Contribution page of a submitted leave donation.

Define Contribution for Bank Voluntary

Daryl Reese
Financial Analyst
[Return to Program Summary](#)

Program Details

Recurring Monthly 0 of 200 balance in Hours

Program Name Bank Voluntary
Type Voluntary
Frequency Monthly
End Date

Category Bank
Contribution Type Recurring
Unit Type Hours

Leave Contribution

| Entitlement | Balance | Hours to Donate |
|-----------------------|---------|-----------------|
| Vacations Entitlement | 1275.99 | 8.00 |

1 row

Monthly Allowed Range 8 - 24 Hours. Maximum Program Limit: 80 Hours.
Your contribution of 8.00 Hours will be processed Monthly with maximum contribution cap of 80 Hours.

Request History >

Approval Chain >

The **Leave Contribution** section shows the entitlement type for that request along with the balance hours and hours donated.

Select **Request History** to view the summary of the request and its approval status.

Select **Approval Chain** to view the approver information for the leave contribution request.

Receive Leave Donation Page

Use the Receive Leave Donation page (HC_HGA_LVDN_SSRCV_FLU) to receive leaves from an eligible employee or a leave bank.

Navigation:

Employee Self Service > Time > Manage Leave Donation > Receive Leave Donation

This example illustrates the fields and controls on the Receive Leave Donation page.

Employees can request donated leave from a leave program for themselves or on behalf of another employee.

Leave donation programs that use the *Individual* program category do not require a request to receive donated leave.

Select Receive Donation to open the Leave Program Details modal.

This example illustrates the fields and controls on the Leave Program Details modal.

The Leave Program drop down displays the active leave programs for the user. This field is inactive if there are no active leave programs for the user.

Select the leave program name and the system automatically populates the other fields in the **Program Details** section.

Select **Done** to navigate to the **Receive Donation** page and submit your request.

This example illustrates the fields and controls on the Receive Donation page.

| Field or Control | Description |
|--------------------------------|---|
| Recipient | Select Other Employee if you are requesting leave time for another employee. You must lookup the name of the employee in the Recipient Name field. Select Self if you are requesting leave time for yourself. The Recipient Name field is not available when you request leave time for yourself. |
| Begin Date and End Date | Enter the begin and end dates for receiving the requested leave time. |
| Hours Requested | Enter the units (hours or days) of donated leave time requested for the specified employee. |
| Reason | Select the reason for this leave request. The available choices are defined on the Leave Transfer Configuration page. |
| Additional Details | Enter any additional details for the receive donation request. If you select <i>Other</i> for Reason then this field becomes mandatory. |
| Requester Comments | Enter comments to the approver for your leave request. |

Select **Submit** to open the *Agreement and Compliance* modal to confirm submission.

Select the check box in this region to agree to the terms of the leave donation program. You cannot submit the request to receive donated leave time until the check box in this region is selected. You do not need to select the check box in this region when you click the **Save for Later** button.

Return Unused Leave Page

Use the Return Unused Leave page (HC_HGA_LVDN_SSRET_FL_GBL) to return unused donated leave to the donors or a leave bank.

Navigation:

Employee Self Service > Time > Manage Leave Donation > Return Unused Leave

This example illustrates the fields and controls on the Return Unused Leave page.

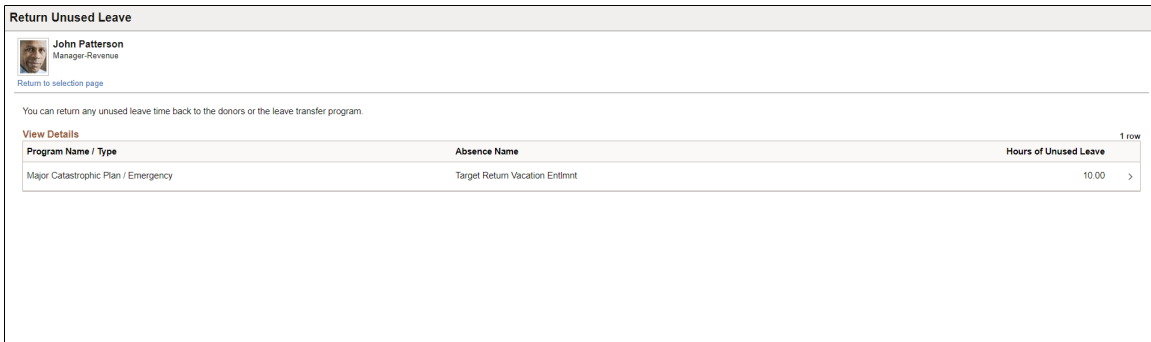

This page enables a leave recipient to return any unused leave time, back to the donors or the leave donation program.

Select the program name in the **View Details** section to navigate to the Return Unused Leave page of the selected program.

This example illustrates the fields and controls on the Return Unused Leave page of the selected program.

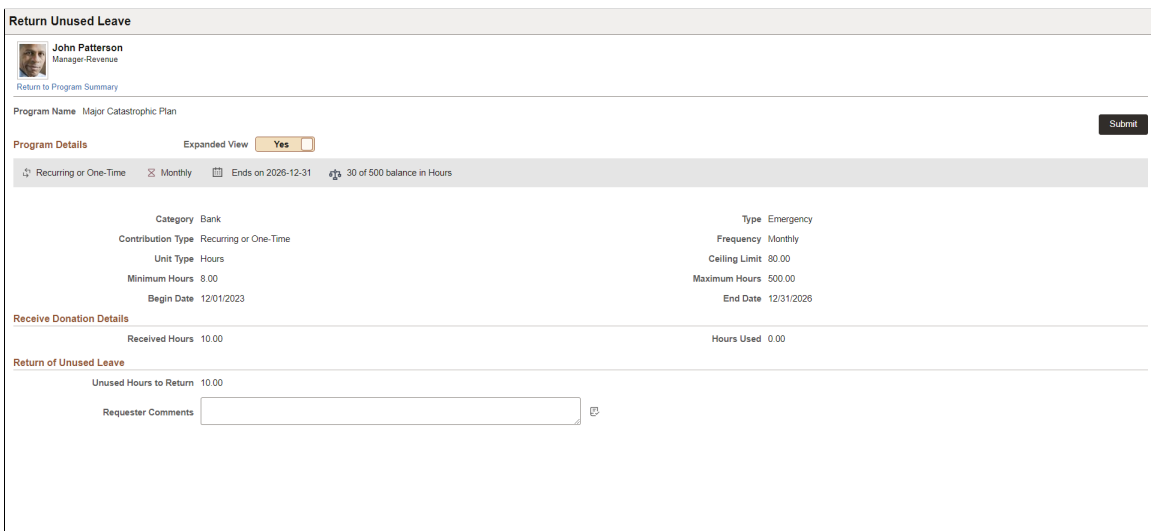

| Field or Control | Description |
|-------------------------------|---|
| Received Hours | Displays the units (hours or days) of received leave time. |
| Hours Used | Displays the units (hours or days) of used leave time. |
| Unused Hours to Return | Displays the units (hours or days) of unused leave time. The system returns the lesser of the target balance accumulator (RECIEVE_BAL) or the current leave balance of the originating entitlement. |

Note: The units of time (hours or days) is displayed based on the configuration of **Unit Type** in the Leave Program Definition Page.

End Leave Donation Page

Use the End Leave Donation page (HC_HGA_LVDN_SSEND_FL_GBL) to terminate the participation of enrollment in a leave donation program.

Navigation:

Employee Self Service > Time > Manage Leave Donation > End Leave Donation

This example illustrates the fields and controls on the End Leave Donation page.

End Leave Donation

John Patterson
Manager Revenue

[Return to selection page](#)

You can terminate recurring participation in a leave donation program. Termination of enrollment occurs during the next available calendar run after the termination request has been approved.

View Details 2 rows

| Program Name / Type | Donated To Date |
|-------------------------------------|-----------------|
| Bank Voluntary / Voluntary | 24.00 > |
| Major Catastrophic Plan / Emergency | 24.00 > |

This page enables a donor to end his or her participation in a banked leave program where the donation occurs on a recurring basis.

The system does not return any donated leave time when an employee ends his or her participation in a leave donation program. The return of unused leave time is set up at the program definition level and is controlled by the End Leave Donation page. Termination of enrollment occurs during the next available calendar run after the termination request has been approved.

Terminating leave program participation and returning unused leave time are auto-approved requests. The system automatically approves these requests without input from a program administrator.

Select the program name in the **View Details** section to navigate to the End Leave Donation page of the selected program.

This example illustrates the fields and controls on the End Leave Donation page of the selected program.

The screenshot shows the 'End Leave Donation' page for John Patterson, Manager Revenue. At the top, there is a 'Return to Program Summary' link. Below that, the 'Program Name' is 'Bank Voluntary' and there is a 'Submit' button. The 'Program Details' section includes an 'Expanded View' toggle set to 'Yes'. A summary bar shows 'Recurring' (checked), 'Monthly', 'Ends on 2020-12-31', and '0 of 200 balance in Hours'. The details are organized into two columns:

- Category: Bank
- Contribution Type: Recurring
- Unit Type: Hours
- Minimum Hours: 8.00
- Begin Date: 01/01/2008
- Type: Voluntary
- Frequency: Monthly
- Ceiling Limit: 80.00
- Maximum Hours: 200.00
- End Date: 12/31/2020

 The 'End Leave Donation' section shows 'Donated To Date: 24.00' and 'Termination Date: 12/07/2023'. At the bottom, there is a 'Requester Comments' text area with a small icon to its right.

| Field or Control | Description |
|-------------------------|---|
| Termination Date | Displays the current date. This date indicates the effective date to end participation in the leave donation program. The recurring donation stops during the next available open calendar run. |

Select the check box in this region to agree to the terms of the leave donation program. You cannot terminate your participation in the leave donation program until the check box in this region is selected.

Leave Donation History Page

Use the Leave Donation History page (HC_HGA_SS_LD_HIST_FL_GBL) to view the history and status of your leave donation requests and edit any saved requests.

Navigation:

Employee Self Service > Time > Manage Leave Donation > Leave Donation History

This page enables an employee to view, track, and edit any outstanding leave donation program requests.

This example illustrates the fields and controls on the Leave Donation History page.

Leave Donation History

Daryl Reese
Financial Analyst

[Return to selection page](#)

You can view the history and status of the leave donation requests

Request History 6 rows

| Leave Program Name | Request Type | Submit Date | Approval Status | |
|--------------------|--------------|-------------|-----------------|---|
| Catastrophic Plan | Terminate | 11/14/2023 | Approved | > |
| Catastrophic Plan | Donate | 11/14/2023 | Approved | > |
| Bank Voluntary | Terminate | 11/14/2023 | Approved | > |
| Bank Voluntary | Donate | 06/28/2017 | Submitted | > |
| Bank Voluntary | Donate | 02/24/2016 | Submitted | > |
| Catastrophic Plan | Donate | | Approved | > |

| Field or Control | Description |
|-------------------------|---|
| Request History | Displays the list of all donation requests with the <i>LeaveProgram Name</i> , <i>Request Type</i> , <i>Submit Date</i> , and <i>Approval Status</i> . |
| Request Type | <p>Displays the type of request. <i>Donate</i> indicates that you requested a donation to the leave donation program specified in the Leave Program Name field.</p> <p><i>Receive</i> indicates that the system received a request to receive donated leave time.</p> <p><i>Terminate</i> indicates that the system received a request to end the donated leave.</p> |
| Submit Date | Displays the date that leave time was received from or donated to a leave donation program. |
| Approval Status | <p>Displays the status of the request. Values are <i>Submitted</i> or <i>Approved</i>.</p> <hr/> <p>Note: Denied or Unprocessed request are not available for editing.</p> <hr/> |

Select a request from the **Request History** section to view the request details.

This example illustrates the fields and controls on the Request History modal.

Fluid End Leave Donation ✕

Daryl Reese
Financial Analyst

Program Details

| | |
|--------------------------------|---|
| Program Name Catastrophic Plan | Category Bank |
| Type Emergency | Contribution Type Recurring or One-Time |
| Frequency Monthly | Unit Type Hours |
| Ceiling Limit 60.00 | Minimum Hours 8.00 |
| Maximum Hours 500.00 | Begin Date 11/01/2023 |
| End Date 12/31/2024 | |

End Leave Donation

Donated To Date 8.00

Termination Date 11/14/2023

Requester Comments

Workflow Status Approved

Managing Leave Donation Programs

Pages Used to Administer Leave Transfer Programs

| <i>Page Name</i> | <i>Definition Name</i> | <i>Usage</i> |
|---|------------------------|--|
| <u>Manage and Approve Requests Page</u> | GP_ABS_LVDN_APPROV | Manage and approve leave donation requests. |
| <u>Adjust Leave Program Balances Page</u> | GP_ABS_LVDN_ADJ | Allocate leave time to one or more employees from a leave transfer program and transfer hours in or out of a leave transfer program and adjust the leave program bank balance. |
| <u>Initiate Requests Page</u> | GP_ABS_LVDN_INIT | This page enables a program administrator to initiate requests on behalf of employees. |
| <u>View Transaction History Page</u> | GP_ABS_LVDN_TRANS | Review leave donation transaction history. |

Manage and Approve Requests Page

Use the Manage and Approve Requests page (GP_ABS_LVDN_APPROV) to manage and approve leave donation requests.

Navigation:

Global Payroll & Absence Mgmt > Payee Data > Leave Donations > Manage/Approve Leave Donations > Manage and Approve Requests

This example illustrates the fields and controls on the Manage and Approve Requests page.

Use this page to edit existing requests to receive or donate leave time or to approve, deny, or push back one or more requests at one time.

The fields in the **Selection Criteria** region enable you to limit the number of entries displayed in the **Request History** region of the page.

| Field or Control | Description |
|-------------------------|--|
| Request Type | <p>Select a value to filter the displayed entries in the Request History region based on the type of request.</p> <p>Select one of the following values:</p> <ul style="list-style-type: none"> • <i>Adjust.</i> • <i>Donate</i> to select requests to donate leave time. • <i>Receive</i> to select requests to receive donated leave time. • <i>Return</i> to select requests to return unused leave time. • <i>Terminate</i> to select requests to terminate participation in a leave transfer program. |
| Workflow Status | <p>Select a value to filter the displayed entries based on the status of the request.</p> |

| Field or Control | Description |
|--------------------------------------|--|
| Select with Matching Criteria | Click this button to populate the Request History region of the page based on the specified selection criteria. |

Adjust Leave Program Balances Page

Use the Adjust Leave Program Balances page (GP_ABS_LVDN_ADJ) to allocate leave time to one or more employees from a leave transfer program and transfer hours in or out of a leave transfer program and adjust the leave program bank balance.

Navigation:

Global Payroll & Absence Mgmt > Payee Data > Leave Donations > Adjust Leave Program Balances

This example illustrates the fields and controls on the Adjust Leave Program Balances page.

The Adjust Leave Program Balances page enables a leave transfer program administrator to handle exceptions, such as adjustments and write-offs. This page enables a program administrator to make adjustments to participating employees' balances. For example, an administrator can allocate time from a program bank to one or more individual employees.

| Field or Control | Description |
|----------------------------------|---|
| Available Program Balance | Displays the available hours in the selected leave transfer program at the time of the last Leave Transfer Transaction process. |

Adjust Bank Balance

Use the fields in this region to make manual adjustments to a leave transfer program balance for programs that have a leave program category of *Bank*. Indicate the number of hours to add or subtract from the bank balance, and any supporting comments related to the adjustment.

| Field or Control | Description |
|-------------------------|--|
| Adjustment Hours | Enter the number of hours to add or subtract from the balance of the specified leave transfer program. Use negative numbers to indicate hours that should be subtracted from a leave transfer program. |

Adjust Individual Balances

Use the fields in this region to manually adjust a leave transfer program that uses the *Individual* leave program category.

| Field or Control | Description |
|-------------------------------|---|
| Target Entitlement | Enter the entitlement plan that you want to adjust. You can only select entitlements that have been defined at the program definition level. |
| Adjustment Date | Enter the date of the adjustment in this field. The administrator can enter a date in the future for the adjustment to occur, as long as the date is prior to the end-date of the leave donation program. |
| View Employee Balances | Click to access the current Balance Inquiry page for the specified employee, including the leave transfer entitlement balances for donated, received, and returned entitlements. |

Initiate Requests Page

Use the Initiate Requests page (GP_ABS_LVDN_INIT) to this page enables a program administrator to initiate requests on behalf of employees.

Navigation:

Global Payroll & Absence Mgmt > Payee Data > Leave Donations > Initiate Leave Payee Requests > Initiate Requests

This example illustrates the fields and controls on the Initiate Requests page.

The screenshot shows the 'Initiate Requests' page with the following details:

- Country: CYM (Cayman Islands)
- Leave Program: INDIV EMER
- Leave Program Category: [Empty]
- *Request Date: 01/03/2014
- Description: [Empty]
- Leave Program Type: [Empty]
- Available Balance: 545.00

The table below shows a single request entry:

| *Empl ID | *Empl Record | Name | *Request Type | *Hours | View Details | View Balances | Time Stamp | Updated By User |
|----------|--------------|---------|---------------|--------|--------------|---------------|-----------------------|-----------------|
| [Empty] | 0 | [Empty] | [Dropdown] | 0.00 | View Details | View Balances | 01/03/2014 11:45:04AM | PS |

This page enables a program administrator to initiate requests on behalf of employees. For example, in cases where recipient employees may not be available to submit a request for leave time, an administrator may initiate a request on behalf of an employee.

| Field or Control | Description |
|----------------------|---|
| Request Type | Select the request type to adjust or initiate for the specified employee. Values are: <i>Adjust</i> , <i>Donate</i> , <i>Receive</i> , <i>Return</i> , and <i>Terminate</i> . |
| Hours | Enter the number of hours to add or subtract from an individual's entitlement balance. Use negative numbers to indicate hours that should be subtracted from an individual's leave balance. You cannot enter a value greater than the available program balance. |
| View Details | Click to access a page with detailed information based on the specified request type. The Details page displays different employee data and information based on the following request types: <ul style="list-style-type: none"> Selecting <i>Donate</i> displays employee data and information from the Leave Contribution region of the Request to Donate Leave page Selecting <i>Receive</i> displays employee data and information from the Leave Time Request region of the Request to Receive Donated Leave page. Selecting <i>Return</i> displays employee data and information from the Return of Unused Leave region of the Request to Return Unused Leave page. Selecting <i>Terminate</i> displays employee data and information from the Terminate Program Participation region of the Request to Terminate Participation page. |
| View Balances | Click to access the current Balance Inquiry page for the specified employee, including the leave transfer entitlement balances for donated, received, and returned entitlements. |

View Transaction History Page

Use the View Transaction History page (GP_ABS_LVDN_TRANS) to review leave donation transaction history.

Navigation:

Global Payroll & Absence Mgmt > Payee Data > Leave Donations History > View Transaction History

This example illustrates the fields and controls on the View Transaction History page.

View Transaction History

Country CYM Cayman Islands
 Leave Program INDIV EMER Description
 Program Category Program Type
 Contribution Type Program Balance 545.000000 Unit Type

Selection Criteria

From Date To Date
 Request Type Transaction Status
 Empl ID From Empl ID To

[Personalize](#) | [Find](#) | [View All](#) | [Print](#) | [First](#) | [1-2 of 2](#) | [Last](#)

| Request Details | Transfer Details | | | | | | | | |
|-----------------|------------------|---------------------|--------------|--------|----------------|------------------|-----------------|------------------|--|
| Empl ID | Job | Name | Request Type | Hours | Date Submitted | Recipient Emplid | Workflow Status | Termination Date | |
| K0W131 | 0 | Sabine D'Hardcastle | Adjust | 40.00 | 10/17/2011 | | Approved | | |
| K0W137 | 0 | Ciel Marriman | Receive | 100.00 | 07/02/2012 | K0W137 | Approved | | |

| Field or Control | Description |
|--|--|
| From Date and To Date | Enter a range of dates for which you want to view the transaction history. |
| Request Type | Select the request types you want to view. Values are: <i>All, Donate, Receive, Return, Terminate and Adjustment</i> |
| Transaction Status | Select the status for the requests you want to view. Values are: <i>All, Unprocessed, and Processed.</i> |
| EmplID From (Employee ID From) and EmplID To (Employee ID To) | Enter a range of employee IDs for which you want to view the transaction history. |
| Select with Matching Criteria | Click to populate the Leave Transfer Transaction Information region based on the criteria you specify.. |
| Clear All | Click to clear the entries in the Selection Criteria region |

Transfer Details

| <i>Field or Control</i> | <i>Description</i> |
|--|---|
| PI Entries (Positive Input Entries) | Click the links in this column to review the positive input for the entitlement on the Positive Input Details page. |

Processing Leave Transfer Transactions

The Leave Transfer process locates all approved leave transfer requests and populates the GP_PI_MNL_DATA record in order to provide the revised absence information to Global Payroll.

Note: You should run this process before you initiate your standard Absence Entitlement and Absence Take processes.

Page Used to Process Leave Transfer Transactions

| <i>Page Name</i> | <i>Definition Name</i> | <i>Usage</i> |
|--------------------------|------------------------|---|
| Run Leave Donations Page | GP_ABS_LVDN_RUNCTL | Run the Leave Transfer process to process all approved leave transfer requests. |

Managing Off Cycle Processing

Understanding Off-Cycle Processing

This topic discusses:

- Differences between on and off cycle runs.
- Types of off cycle transactions.
- Features of off cycle processing.
- Steps for entering off cycle requests.
- Processing and postprocessing steps.
- Off cycle batch processing.
- System elements for developing off cycle rules.

Common Elements Used for Off-Cycle Processing

| <i>Field or Control</i> | <i>Description</i> |
|--|---|
| Off Cycle Group | Identifies a set of off cycle transactions to process. The name of an off cycle group is user defined. You can use any value. |
| Period Begin Date and Period End Date | <p>Dates the system uses to determine:</p> <ul style="list-style-type: none"> • The period for updating accumulators, for those accumulators that are defined to accumulate based on period begin date or period end date. • The element definitions to retrieve during processing, for those elements that use period begin date or period end date as the definition as of date. <p>Corrections inherit these dates from the target calendar; you can override the default dates. Advance payments inherit these dates from the source calendar, the calendar that is being advanced; you cannot override these dates for advances.</p> |
| Target Period ID | Affects the period for which balance accumulators are updated. The target period provides the default values for the period begin date and period end date for all transaction types except advances. For advances, the target period determines the process begin date and process end date. |

Differences Between On and Off Cycle Absence Runs

On cycle processing refers to executing regularly scheduled runs. In Absence Management these are recurring runs for which a period, calendar, and calendar group have been predefined. A pay group with a monthly frequency has twelve regularly scheduled on cycle absence runs each year.

Off-cycle absence processing refers to processing absences and making corrections to finalized results outside of the normal absence schedule. Off cycle transactions are typically made to correct prior absence results or to make termination payments that can't wait until the next scheduled on cycle absence run.

With the exceptions that are explained in this documentation, the concepts that apply to on cycle processing also apply to off cycle processing: retroactivity, segmentation, calendars, calendar groups and running calculations. The primary difference between on and off cycle processing is the way in which you enter instructions for what and whom to process.

Related Links

[Understanding Absence Processing](#)

Types of Off Cycle Transactions

Absence Management supports two types of off cycle transactions.

- Corrections

These are transactions that correct the results of a finalized absence run. An example is reversing an absence entitlement that was made to a payee in error.

- Advances

Advances are the processing of segments before they are normally scheduled, such as the early calculation of absence transactions in order to pay wages due to termination or to process a leave of absence in advance.

Features of Off Cycle Processing

With off cycle processing, you can override supporting elements.

For all off cycle transactions except advances, you can override the values of brackets, dates, duration, formulas, and variables for a given payee and calendar. Advances will take these overrides from the calendar definitions of the calendars being advanced.

Steps for Entering an Off Cycle Payment

You can enter multiple off cycle requests for the same pay group and target period.

To enter requests for off cycle transactions:

1. Create an off cycle group using the Off Cycle On Demand (GP_ONDEMAND) component.

An off cycle group is a group of payees that are processed together. It identifies which off cycle transactions to process and the processing instructions, including who and what to process (pay group) and when to process it (target calendar ID). Its purpose is similar to a calendar in an on cycle process,

except that you enter specific instructions for each payee. Name the off cycle group on the Off Cycle On Demand page.

2. Enter individual requests for off cycle processing.

The Off Cycle On Demand component prevents you from performing off cycle steps out of order. You will enter a request by clicking either the **Create Request** or **Edit Request** button. If at least one request has been create the button is labeled **Edit Request**.

Once the button is clicked, you are transferred to the main request page which includes the valid off cycle types for your organization. On this main page, you indicate the payee ID by type of transaction. Next, select the detail link and you are transferred to the individual detail page for the transaction type.

3. Create a calendar group for the off cycle run.

A calendar group for an off cycle run identifies the *off cycle groups* to process together (whereas a calendar group for an on cycle process identifies the *calendars* to process together). Use the same page to create all calendar groups, completing the fields that pertain to off cycle processing.

You create a calendar group for an off cycle run directly on the Off Cycle On Demand page of the Off Cycle On Demand component by clicking the **Create Calendar Group** button. When you create the Calendar Group through the dashboard, the system uses the name of the off cycle group (one of the keys) as the name of the calendar group. Also, the system populates the Calendar Group page with the other information required to generate the off cycle calendar group.

Note: When processing a correction request, ensure the **Process Retro** field is selected on the Calendar Group page.

Processing and Postprocessing Steps

To process requests for off cycle transactions:

1. Initiate the off cycle run.

Use the Off Cycle On Demand page of the Off Cycle On Demand component to initiate off cycle runs by clicking the **Calculate** button. The calculation is performed as a remote call. The remote call causes the browser to remain on the Off Cycle On Demand page for the duration of the calculation process. Any pertinent messages are displayed upon completion. Each time the calculation is run, the system cancels the payees, identifies the payees that are eligible for calculation, and calculates all elements for the payees.

Note: Off cycle processing can also be run using the Calculate Absence and Payroll page as it would for an on cycle process.

When the calculation finishes, it opens the Payee Status page. From this page you can access the Results by Calendar Group page as well as the Payee Messages page. The Payee Status page reflects that the results are calculated. From this page you can review:

- Payee Calculation Status.
- Payee Results.

- Payee Messages.

Note: When the calendar group is created, you can access the Payee Status page at any time by clicking the **View Status and Results** link.

2. When you review the processing results, you can choose to:
 - Cancel the calculation. Click the **Cancel** button on the Off Cycle On Demand page.
 - Calculate again due to changes made to the off cycle transactions. Click the **Calculate** button on the Off Cycle On Demand page.
 - Finalize the end the absence calculation. Click the **Finalize** button on the Off Cycle On Demand page. Once this is done, move on to Step 3.
3. Run all post-processes, such as Absence Conversion Programs to Payroll for North America and/or for Payroll Interface and reports.

Each postprocessing step needs to be run with the same sequence as on cycle.

Related Links

[Viewing Payee Status and Updating a Payee's Processing Instructions](#)

Off Cycle Batch Processing

With off cycle processing, the system automatically suspends affected payees from other runs in which they are active so that they can be included in the off cycle process. (A payee can only be active in one run at a time.)

Here's what the system does when you submit an off cycle request:

- Checks whether the payee is associated with an open calendar group.
- If yes, suspends the payee in the calendar group so that the payee can be calculated immediately in the off cycle group.

Note: If the Calculation status is set to Frozen, the system suspends the payee in the off cycle calendar group.

Transaction processing varies depending on the type of off cycle request being processed.

Corrections

Off cycle corrections are based on retroactive processing similar to the retroactive corrections that take place during on cycle runs.

- A trigger must exist on or before the period end date for the calendar being corrected or reversed.
- The type of correction is replacement which replaces an existing absence run.
- The type of retroactive method is Forced Corrective.

- New calendars are created and will be processed. :

Advances

For advances, calendar groups are processed with the applicable calendars. Batch processing follows the same logic as on cycle processing.

System Elements for Developing Off Cycle Rules

The following table provides information about delivered system elements that are used during off cycle processing:

| <i>System Element</i> | <i>Description</i> | <i>Values</i> |
|-----------------------|---|---|
| GP TX TYPE | Identifies the transaction type | <ul style="list-style-type: none"> • R (Correction) • A (Advances) • Blank (on cycle runs) |
| OFF CYCLE | Identifies whether calendar is off cycle or on cycle. | <ul style="list-style-type: none"> • Y (Yes) = off cycle calendar. • N (No) = on cycle calendar. (Any run with a defined calendar is considered on cycle, including semi-regular runs.) |
| GP CORR TYPE | Identifies the correction type | <ul style="list-style-type: none"> • R (Replacement — Normal Retro). • W (Reversal — Replacement). |

Initiating Off Cycle Transactions

Pages Used to Initiate Off Cycle Transactions

| <i>Page Name</i> | <i>Definition Name</i> | <i>Usage</i> |
|---------------------------------|------------------------|---|
| <u>Off Cycle On Demand Page</u> | GP_ONDEMAND | Access the pages to: <ul style="list-style-type: none"> • Create or edit an off cycle request. • Create or Edit an off cycle calendar group. • Process the off cycle calendar group. You can calculate, cancel or finalize the run from this page. |

| Page Name | Definition Name | Usage |
|-------------------------------|------------------------|---|
| <u>Off Cycle Request Page</u> | GP_OFFCYCLE_REQ | Access the detail pages of the off cycle transaction types for the employee ID's entered. |

Understanding the Preliminary Entry for Off Cycle Transactions

You can create an off cycle request by accessing the Off Cycle On Demand page or the Off Cycle Requests page. Use the Off Cycle On Demand component (GP_ONDEMAND) to create an off cycle request, process the request, and view the results. Use the Off Cycle Requests component (GP_OFFCYCLE_REQ) to enter the employee ID for the applicable off cycle transaction type. After entering the employee ID on the Off Cycle Request page, you complete a separate page of the component to complete details for each transaction type you intend to process.

If a payee has entries for more than one transaction type, the system processes the correction transactions first, then the advance transactions. To process the transactions in any other order, set up separate off-cycle groups and process the advances in separate runs.

Off Cycle On Demand Page

Use the Off Cycle On Demand page (GP_ONDEMAND) to:

- Create or edit an off cycle request.
- Create or Edit an off cycle calendar group.
- Process the off cycle calendar group. You can calculate, cancel or finalize the run from this page.

Navigation:

Global Payroll & Absence Mgmt > Absence and Payroll Processing > Off Cycle > Off Cycle On Demand > Off Cycle On Demand

This example illustrates the fields and controls on the Off Cycle On Demand page.

Off Cycle On Demand

Pay Group K0WPG PNA1 Absence Management to PNA

Target Period ID K0WCA05M02 K0WCA05M02 Monthly 02/01/2005 - 02/28/2005

Off Cycle Group K0W OFF 05M02 Country CYM

Set Up Request ?

Edit Request

Edit Calendar Group

Request entered

Calendar Group created Calendar Group K0W OFF 05M02

Process Calendar Group ?

Calculate

[View Status and Results](#)

Finalize

Results can be finalized Processing Status Unprocessed

Finalized Cancel

| Field or Control | Description |
|---|--|
| Create Request or Edit Request | Click to create a request on the Off Cycle Request page. When the request has been created, the button reads Edit Request , which you click to edit the off cycle request that is created. |
| Create Calendar Group or Edit Calendar Group | Click to access the Calendar Group page to create a calendar group for processing the off cycle transactions. When the calendar group has been created, the button reads Edit Calendar Group , which you click to edit the calendar group that is created. See Defining Calendar Groups . |
| Calculate | Click to calculate the off cycle transactions. The calculation is performed as a remote call. The remote call causes the browser to remain on the Off Cycle On Demand page for the duration of the calculation process. Note: The simplified approach of the Calculate push-button does not allow certain options like freezing calculations or running the process with element trace on. If this is desired, go to the Calculate Absence and Payroll page to process the off cycle calendar group. See “Entering Processing Instructions” (PeopleSoft Global Payroll). |
| View Status and Results | Click to access the Payee Status page. Use this page to view payees by process indicator, calculation status, or other criteria and specify the action that the system is to take. Also, you can access Results by Calendar Group component (GP_RSLT_CAL_RUN) or Payee Messages component (GP_MESSAGE) by clicking the links on the Payee Status page. See Viewing Payee Status and Updating a Payee’s Processing Instructions . See Viewing Results by Calendar . See Viewing Payee Messages . |
| Finalize | Click to finalize an off cycle run. This button is available only after the calendar group has been successfully calculated. |
| Cancel | Click to cancel an off cycle run. This option becomes available as soon as the off cycle group has been associated with a calendar group. |

| Field or Control | Description |
|--|---|
| <p>Request entered, Calendar Group Created, Results can be finalized, and Finalized</p> | <p>The check boxes to the right of the push buttons on the Off Cycle On Demand page are unavailable for entry. The system maintains these check boxes, which consists of milestones, that indicate how far along you are in the off cycle process. For example, if you have already created the request, completed your calendar group creation, and run a calculation once with no errors, the system selects several check boxes (Request entered, Calendar Group Created, and Results can be finalized) on the Off Cycle On Demand page, representing the steps you have already completed.</p> |

Off Cycle Request Page

Use the Off Cycle Request page (GP_OFFCYCLE_REQ) to access the detail pages of the off cycle transaction types for the employee ID's entered.

Navigation:

- Click **Create Request** link on the Off Cycle On Demand page.
- **Global Payroll & Absence Mgmt > Absence and Payroll Processing > Off Cycle > Off Cycle Request > Off Cycle Request**

This example illustrates the fields and controls on the Off Cycle Request page.

Enter Off-Cycle Requests

Off Cycle Request

Pay Group K0WPG PNA1 **Absence Management to PNA**
Target Period ID K0WCA05M02 K0WCA05M02 Monthly 02/01/2005 - 02/28/2005
Off Cycle Group K0W OFF 05M02 **Country** CYM

▼ Calendars to Correct (2)

Corrections - List Payees and Calendars to correct Personalize | Find | | First 1-2 of 2 Last

| *Employee ID | Name | Empl Record | Calendar To Correct | Correction Details | | |
|--------------|-----------------|-------------|---------------------|--------------------|--|--|
| K0W003 | Owen Wills | 000 | K0WCA PNAON04M12 | | | |
| K0W004 | Will Smitherson | 000 | K0WCA PNAON04M11 | | | |

▼ Advances (1)

Advances - List Payees and Calendar Groups to advance Personalize | Find | | First 1 of 1 Last

| *Employee ID | Name | Empl Record | Calendar Group | Advance Details | | |
|--------------|-------------|-------------|------------------|-----------------|--|--|
| K0W005 | Laura Jones | 000 | K0WCR PNAON05M03 | | | |

| Field or Control | Description |
|--|--|
| Employee ID | Enter the employee ID in the applicable off cycle transaction section. The section will limit itself to payees (and jobs) associated with the pay group that is associated with the off cycle group. |
| Empl Rcd Nbr (Employee Record Number) | Select the job for which you want to create the off cycle transaction. |
| Correction Details or Advance Details | Click to access the Correction Detail page or Advance Detail page where you enter the details for the applicable off cycle transaction type. |

Correcting or Reversing Absence Results

With its built-in retroactive processing capabilities, Absence Management generally handles corrections as a basic part of regular on cycle absence runs. With off cycle processing, you can quickly address the more critical exceptions.

Pages Used to Correct Absence Results

| Page Name | Definition Name | Usage |
|--|------------------------|--|
| Correction Request Detail Page | GP_OFFCYCLE_C_SEC | Enter instructions for processing absence corrections. |
| Absence Event Entry Page | GP_ABS_EVENT | Enter absence events that need correcting. |
| Retro Page | GP_TRIGGER_RTO | Enter or review retroactive trigger information. |
| Adjust Absence Balances Page | GP_PI_MNL_AE | Adjust frequency-based entitlement for a payee by calendar period. |

Understanding Absence Result Corrections

For Absence Management the correction type of *Replacement* is processed. The type of retroactive method used with corrections is *Forced Corrective*.

Example of a Replacement Correction

For a *replacement correction*, the system handles the adjustment using the normal retroactive processing mode and processing set, as dictated by the existing triggers. Standard use and validation of retroactive rules apply (as if running on cycle). This includes:

- The retroactive mode is corrective (the system ignores for processing the retroactive events of the trigger).
- No elements are forwarded (the system ignores the retroactive processing set).
- All elements are recalculated (the system ignores the retroactive recalculate setting).

Correction Request Detail Page

Use the Correction Request Detail page (GP_OFFCYCLE_C_SEC) to enter instructions for processing absence corrections.

Navigation:

Click **Correction Details** button on the Corrections - List Payees and Calendars to correct section of the Off Cycle Request page.

This example illustrates the fields and controls on the Correction Request Detail page.

Enter Off-Cycle Correction

Off Cycle Request

Correction Request Detail

Pay Group K0WPG PNA1 Period ID K0WCA05M02 Off Cycle Group K0W OFF 05M02
 Employee ID K0W003 Name Owen Willis Empl Record 0

Calendar To Correct

*Calendar ID Adjust Absence Balances
Absence Event Entry

Review Triggers Retro Triggers Exist

| Retro Triggers | | | | | Personalize Find View All |
|------------------------|------------------|----------------|--------------------|-------------|-------------------------------|
| Trigger Effective Date | Trigger Event ID | Trigger Status | Trigger Source | Trigger Tag | |
| | | Unprocessed | Manually Generated | | |

First 1 of 1 Last

OK Cancel

| Field or Control | Description |
|--------------------------------|---|
| Calendar ID | Select the calendar that needs a correction made to it. |
| Adjust Absence Balances | Use this link to enter any adjustments to absence balances. |
| Absence Event Entry | Click to access the Absence Event Entry page. |
| Review Triggers | Click link to view, edit, and add retroactive triggers. |

| Field or Control | Description |
|--|---|
| Retro Triggers Exist (retroactive triggers exist) | This system will select this check box if a trigger exists that falls on or before the period end date of the calendar to be corrected, and if the trigger represents the same country as the country associated with the pay group of the off cycle group. If the check box is cleared, you must manually create the trigger or make the correction to data that will cause the trigger to be generated. |
| Retro Triggers | Displays a list of retro triggers associated with the same country as the correction. |

Processing Advances

Pages Used to Process Advances

| Page Name | Definition Name | Usage |
|------------------------------------|------------------------|--|
| <u>Advance Request Detail Page</u> | GP_OFFCYCLE_A_SEC | Enter instructions for processing absences in advance. |
| Adjust Absence Balances Page | GP_PI_MNL_AE | Adjust entitlement balances. |
| Retro Page | GP_TRIGGER_RTO | Enter or review retroactive trigger information. |
| Absence Event Entry Page | GP_ABS_EVENT | Enter absence events related to the advance absence. |
| Payee Calendar Groups Page | GP_PYE_RUN | Enter payee calendar override details for the period being advanced. |

Understanding Advances

Advance processing is the processing of on cycle calendars ahead of their regular schedule. Examples include payments for early termination or a full or partial period advance.

Note: The advance on cycle calendars are processed individually exactly like they would have been within their scheduled run. The only difference is the timing.

For additional information about processing advances using on cycle processing, see Entering Calendar Override Instructions for a Payee.

Advance Request Detail Page

Use the Advance Request Detail page (GP_OFFCYCLE_A_SEC) to enter instructions for processing absences in advance.

Navigation:

Click the **Advance Details** icon on the Advances section on the Off Cycle Request page.

This example illustrates the fields and controls on the Advance Request Detail page.

Enter Off-Cycle Advance

Off Cycle Request

Advance Request Detail

Pay Group K0WPG PNA1 Period ID K0WCA05M02 Off Cycle Group K0W OFF 05M02
 Employee ID K0W005 Name Laura Jones Empl Record 0
 Calendar Group

Calendars Personalize | Find | View All | | First 1 of 1 Last

| Calendar ID | Calculate From Date | Calculate Thru Date | Adjust Absence Balances |
|------------------|----------------------|----------------------|-------------------------|
| K0WCA PNAON05M03 | <input type="text"/> | <input type="text"/> | |

[Review Triggers](#) [Absence Event Entry](#) [Review Payee Calendar Override](#) Overrides exist

Retro Triggers Personalize | Find | View All | | First 1 of 1 Last

| Trigger Effective Date | Trigger Event ID | Trigger Status | Trigger Source | Trigger Tag |
|------------------------|------------------|----------------|--------------------|-------------|
| | | Unprocessed | Manually Generated | |

Note: The system will not process more than one advance for the same calendar group and person within the same off cycle run. If you need to advance smaller fractions of the same absence period (such as, the 1st through the 5th and the 10th through 11th) at the same time, you must set up two different requests and process each in a separate run.

In addition, if two advances are set up for the same payee and calendar group in two different off cycle requests, and you attempt to process these together in the same run, the system issues a warning that informs you that the duplicate was discovered and that all but one request will be ignored. You can ignore the warning and proceed, or go back and modify the request before processing.

| <i>Field or Control</i> | <i>Description</i> |
|-------------------------|---|
| Calendar Group | Select the unfinalized calendar group that is associated with the pay group. In the Calendars grid, the system lists, in the defined processing order, all calendars that are associated with the selected calendar group. |

| Field or Control | Description |
|--|--|
| Calculate From Date and Calculate Thru Date | <p>To calculate absence transactions for a partial period, enter the begin and end dates for the period of time. Entering dates here causes period segmentation to occur during the off cycle run, without the presence of a segmentation trigger. (Segmentation triggers would affect both on and off cycle transactions, which is not a desirable outcome.)</p> <p>To avoid unintentional duplicate absences, whenever from and through dates are defined for a calendar, subsequent processes will review the segments to ensure that new segments do not cover the same period of time for the same calendar. This rule applies whether or not the run type allows duplicates for the calendar period.</p> |
| Adjust Absence Balances | Click to access the Adjust Absence Balances page where you can adjust entitlement balances. |
| Review Triggers | Click the link to access the Retro page to review, add, or delete triggers. |
| Absence Event Entry | Click to access the Absence Event Entry page. |
| Review Payee Calendar Overrides | Click to access the Payee Calendar Override (GP_PYE_RUN) component. You can view or modify overrides here. The system respects all payee calendar overrides when processing the advance payment, including overrides to prevent the processing of calendars. |
| Overrides Exist | This indicator will be turned on if payee calendar overrides exist for the calendar group. |
| Retro Triggers | Displays a list of retro triggers associated with the same country as the advance. |

Processing and Viewing Results for Off Cycle Transactions

The Off Cycle On Demand component is used to create a request, create a calendar, as well as, to process and view off cycle requests. On the Off Cycle On Demand page you can calculate a run, view results, and finalize or cancel the process. Every time you calculate a run, the system first cancels all results then identifies and calculates the off cycle request. Therefore iterative trigger set up is not needed, as long as you run the calculation process from the On Demand page. If you use the Calculate Absence and Payroll Run Control page to calculate your off cycle requests, iterative triggers are necessary to cause a re-identification and recalculation if you select the **Calculate** option without selecting the **Recalculate All** option.

When you are processing from this page, a remote call is made to calculate, finalize, or cancel the run, depending on the button that you click. This causes the process to run while remaining on the Off Cycle

On Demand page. It will not redirect you to the Calculate Absence and Payroll page. If you want to run the process with a resolution chain, streams, or process lists, you will have to run it using the Calculate Absence and Payroll page, the same page from which you run the on cycle absence processes. When you have run the calculation process successfully from the Off Cycle On Demand page, the system will automatically transfer you to the Payee Status page, upon completion of calculation or finalize. When the you run cancel, instead of redirecting you to the Payee Status page, a message appears that confirms the cancel process ran successfully.

Related Links

[Understanding Absence Processing](#)

[Viewing Payee Status and Updating a Payee's Processing Instructions](#)

[Viewing Results by Calendar](#)

[Viewing Payee Messages](#)

Setting Up Triggers

Understanding Triggers

This topic discusses:

- Trigger uses.
- Trigger table data.
- Trigger generation.
- Managing used or obsolete triggers.
- Defining triggers manually.

Trigger Uses

In Absence Management, the mechanism used to detect online data changes that should result in iterative, retroactive, or segmentation processing is called a *trigger*. To set up triggers, you select the database records and fields that you want to make sensitive to data changes such as job location changes and terminations; then, when the change occurs, the system writes a line of data to a table called a *trigger table* to tell the system how to process the change.

There are three types of triggers:

- Iterative

An *iterative* trigger tells the system to process (or reprocess) a payee in the current open calendar, possibly because payee data has changed or the payee was placed in suspended mode during batch processing. The system generates only one iterative trigger per payee per open calendar group, regardless of the number of calendars in the calendar group. When data changes for the payee, the system (using online code) generates iterative triggers that enable the batch process to recalculate the payee, add the payee to the calendar run, or remove the payee from the calendar run.

- Retroactive

A *retroactive (or retro)* trigger tells the system to reprocess previously calculated (closed) calendars. For example, this can occur when a payee's absence type for days reported changes and the change goes back to a prior calendar. The absence data must be reprocessed to ensure that the payee receives the right amount of absence days for the correct type of absence.

See [Understanding Retroactive Processing](#).

- Segmentation

A segmentation trigger tells the system to segment all or a subset of absence elements in an absence run in response to a change in payee data.

See [Understanding Segmentation Setup](#).

You can generate triggers in two ways:

- **Manually:** Doesn't require you to set up trigger definitions. You create triggers manually for a given payee.

See [Managing Automatically Generated Triggers and Defining Triggers Manually](#).

Note: You can generate triggers manually only for retroactive and segmentation triggers.

- **Automatically:** Requires you to set up trigger definitions. These trigger definitions tell the system how and when to generate "automatic" triggers when a database change occurs.

Once triggers are generated (manually or automatically), the batch process uses the trigger to perform the proper action.

Trigger Table Data

When a trigger is generated by a change to a record or record and field combination, the system writes the data needed to process the change to a trigger table. Each type of trigger has a separate table for storing this data.

Iterative Trigger Table

The information generated by an iterative trigger is stored in the iterative trigger table (GP_ITER_TRGR). This table contains the following data:

| Field | Purpose |
|----------------|--|
| EMPLID | <p>Iterative triggers are payee-level triggers generated from records that have Employee ID as part of their key structure. The EMPLID identifies the payee affected by the change that generates the trigger.</p> <p>Mass triggers function differently and are not restricted to records that have Employee ID as part of their key structure.</p> <p>See Understanding Mass Triggers.</p> |
| CAL_RUN_ID | Identifies the calendar run in which the iterative trigger is processed. |
| TRGR_CREATE_TS | The system date and time when a trigger is generated (for information only). If you change data so that the same iterative trigger is generated repeatedly, a timestamp is needed to keep the instances unique. |

| Field | Purpose |
|-------------------|--|
| ITER_TRGR_STATUS | Identifies whether the system is processing a trigger. Options are: <i>Canceled:</i> You can cancel a trigger whose status is <i>Unprocessed</i> on the Payee Triggers - Iterative page. <i>In-Process:</i> For triggers that are being considered by the batch process. <i>Processed:</i> For triggers that were processed by the system and can't be reconsidered. <i>Unprocessed:</i> For triggers that haven't been processed by the system. |
| ITER_TRGR_SRC | Identifies how the iterative trigger is generated. Options are: <i>Batch:</i> For triggers that are generated during batch processing. <i>Online:</i> For triggers that are generated by the online code. |
| COUNTRY | The country code associated with the iterative trigger. |
| RECNAME | Identifies the source record from which the iterative trigger is generated. |
| FIELDNAME | Identifies the field that generates the iterative trigger in response to a data change. |
| TRGR_FLD_VAL_CHAR | Identifies the character value change that causes the iterative trigger to be generated. This field is not populated if the trigger is defined at the record level only. |
| TRGR_FLD_VAL_DT | Identifies the date value change that causes the iterative trigger to be generated. This field is not populated if the trigger is defined at the record level only. |
| TRGR_FLD_VAL_NUM | Identifies the numeric value change that causes the iterative trigger to be generated. This field is not populated if the trigger is defined at the record level only. |

When an iterative trigger is generated by a data change, the system writes the employee ID, the country, and the calendar run ID along with other information to the trigger table to facilitate iterative processing by the batch code.

Among other things, this data tells the system:

- Which payees to process or reprocess.
- Which open calendars to process.

In addition, the system uses the RECNAME, FIELDNAME, TRGR_FLD_VAL_CHAR, TRGR_FLD_VAL_DT, and TRGR_FLD_VAL_NUM fields to identify the source of an iterative trigger (the record, field, and/or field value changes that generate a trigger). This information enables a clearer understanding of what causes iterative processing of a payee's absences, and can be used to facilitate debugging or answer queries.

Note: You can view the trigger source data stored in this table on the Iterative page.

See [Iterative Page](#).

Retroactive Trigger Table

The information generated by a retroactive trigger is stored in the retroactive trigger table (GP_RTO_TRGR). This table contains the following data:

| Field | Purpose |
|----------------|---|
| EMPLID | Retroactive (or <i>retro</i>) triggers are payee-level triggers generated from records that have Employee ID as part of their key structure. The EMPLID identifies the payee affected by the change that generates the trigger. Mass triggers function differently and are not restricted to records that have Employee ID as part of their key structure. See Understanding Mass Triggers . |
| COUNTRY | The country code associated with a retroactive trigger. |
| TRGR_EVENT_ID | The trigger event ID associated with record, field, or value changes as defined in the trigger setup. |
| TRGR_EFFDT | The effective date tells the system which periods to process retroactively (for example, a retro trigger with an effective date of January 1, 2006 tells the system to reprocess all calendars beginning with the January 2006 absence run). |
| TRGR_CREATE_TS | The system date and time when a trigger is generated (for information only). If you change data so that the same retroactive trigger is generated repeatedly, a timestamp is needed to keep the instances unique. |

| Field | Purpose |
|-------------------|--|
| RTO_TRGR_SRC | Identifies how the retro trigger is generated. Options are: <i>Automatic:</i> Identifies triggers that are generated by the online code. <i>Manual:</i> Denotes manually generated triggers. <i>Utility-Generated:</i> Not available. |
| TRGR_STATUS | Identifies whether the system is processing a trigger. Options are: <i>Canceled:</i> You can cancel a trigger whose status is <i>Unprocessed</i> on the Payee Triggers page. <i>In-Process:</i> Denotes triggers that are being considered by the batch process. <i>Processed:</i> Identifies triggers that were processed by the system and can't be reconsidered. <i>Unprocessed:</i> Identifies triggers that haven't been processed by the system. |
| TRGR_DESCR | This field serves as the trigger tag or description of a trigger. For use with the <i>Utility-Generated</i> source value. |
| CAL_RUN_ID | Identifies the calendar run in which the retroactive trigger is processed. |
| RECNAME | Identifies the source record from which the retro trigger is generated. |
| FIELDNAME | Identifies the field that generates the retro trigger in response to a data change. |
| TRGR_FLD_VAL_CHAR | Identifies the character value change that causes the retro trigger to be generated. This field is not populated if the trigger is defined at the record level only. |
| TRGR_FLD_VAL_DT | Identifies the date value change that causes the retro trigger to be generated. This field is not populated if the trigger is defined at the record level only. |

| Field | Purpose |
|------------------|--|
| TRGR_FLD_VAL_NUM | Identifies the numeric value change that causes the retro trigger to be generated. This field is not populated if the trigger is defined at the record level only. |

When a retroactive trigger is generated by a data change, the system writes the employee ID, the effective date of the change (also called the trigger effective date), the country, and the associated event ID along with other information to the trigger table to facilitate retroactive processing by the batch code.

Among other things, this data tells the system:

- Which payees to process.
- Which periods to process retroactively, based on the trigger effective date.
- Which process definition to use to recalculate prior periods.

In addition, the system uses the RECNAME, FIELDNAME, TRGR_FLD_VAL_CHAR, TRGR_FLD_VAL_DT, and TRGR_FLD_VAL_NUM fields to identify the source of a retro trigger (the record, field, and/or field value changes that generate a trigger). This information enables a clearer understanding of what causes retroactive processing of a payee's absences, and can be used to facilitate debugging or answer queries.

Note: You can view the trigger source data stored in this table on the Retro page.

See [Retro Page](#).

Note: You can generate multiple rows of trigger data for one event by making multiple record and field combinations sensitive to retroactive data changes. For example, a retroactive change in hire date and a retroactive change in pay group might both generate retro triggers for the same event. In the case of multiple retro triggers, the earliest trigger effective date is used to drive limit calculations, which, in turn, direct retroactive calculations.

Segmentation Trigger Table

The information generated by a segmentation trigger is stored in the segmentation trigger table (GP_SEG_TRGR). This table contains the following data:

| Field | Purpose |
|--------------|---|
| EMPLID | <p>Segmentation triggers are payee-level triggers generated from records that have Employee ID as part of their key structure. The EMPLID identifies the payee affected by the change that generates the trigger.</p> <p>Mass triggers function differently and are not restricted to records that have Employee ID as part of their key structure.</p> <p>See Understanding Mass Triggers.</p> |

| Field | Purpose |
|-----------------|---|
| EMPL_RCD | Identifies the job affected by a segmentation event. |
| COUNTRY | The country code associated with the segmentation trigger. |
| TRGR_EVENT_ID | The trigger event ID associated with a triggering condition, as defined in your setup. It tells the system what type of segmentation to apply and the elements to segment (in the case of element segmentation). |
| TRGR_EFFDT | The effective date tells the system how to segment a period (for example, a segmentation trigger with an effective date of June 15 tells the system to divide the June period into two segments, one with the dates June 1 to June 15, and another with the dates June 16 to June 30). |
| TRGR_CREATE_TS | The system date and time when a trigger is generated (for information only). If you change data so that the same segmentation trigger is generated repeatedly, a timestamp is needed to keep the instances unique. |
| SEG_TRGR_SRC | Identifies how the segmentation trigger is generated. Options are: <i>Automatic:</i> Identifies triggers generated by the online code. <i>Manual:</i> Denotes manually generated triggers. |
| SEG_TRGR_STATUS | Identifies whether the system is processing a trigger. Options are: <i>Active:</i> Indicates that the trigger has been written out and will remain active until canceled by a user. <i>Canceled:</i> You can cancel a trigger whose status is <i>Active</i> on the Payee Triggers page. |
| SEG_TRGR_LVL | Specifies whether a trigger is payee-level or at the payee-job (EMPL_RCD) level trigger. Instructs the system to process for one job only or for all jobs. |
| CAL_RUN_ID | Identifies the first calendar group ID that uses a segmentation trigger. If the segmentation trigger is reused because of retroactivity, the calendar group ID isn't updated. |

| Field | Purpose |
|-------------------|---|
| RECNAME | Identifies the source record from which the segmentation trigger is generated. |
| FIELDNAME | Identifies the field that generates the segmentation trigger in response to a data change. |
| TRGR_FLD_VAL_CHAR | Identifies the character value change that causes the segmentation trigger to be generated. This field is not populated if the trigger is defined at the record level only. |
| TRGR_FLD_VAL_DT | Identifies the date value change that causes the segmentation trigger to be generated. This field is not populated if the trigger is defined at the record level only. |
| TRGR_FLD_VAL_NUM | Identifies the numeric value change that causes the segmentation trigger to be generated. This field is not populated if the trigger is defined at the record level only. |

When a segmentation trigger is generated by a data change, the system writes the employee ID, the effective date of the change (also called the trigger effective date), the country, and the associated event ID along with other information to the trigger table to facilitate retroactive processing by the batch code.

Among other things, this data tells the system:

- Which payees to process.
- The dates to use for the period segments or slices.
- What type of segmentation to use and the elements to segment (in the case of element segmentation).

In addition, the system uses the RECNAME, FIELDNAME, TRGR_FLD_VAL_CHAR, TRGR_FLD_VAL_DT, and TRGR_FLD_VAL_NUM fields to identify the source of a segmentation trigger (the record, field, and/or field value changes that generate a trigger). This information enables a clearer understanding of what causes segmentation of a payee's absences, and can be used to facilitate debugging or answer queries.

Note: You can view the trigger source data stored in this table on the Segmentation page.

See [Segmentation Page](#).

Trigger Generation

This topic discusses the concept of trigger effective date types (Trigger Effdt Type) and trigger levels, and describes how and when the system generates triggers based on effective date types and trigger levels.

Effective Dates and Effective Date Types

All triggers except iterative triggers are stored in the trigger tables with their trigger effective dates (TRGR_EFFDT). These dates are based on—but are not necessarily identical to—the dates of the database changes that cause the triggers to be generated. In the PeopleSoft system, these database change dates are recorded in the following fields: Effective Date, Begin and End Date, and Fixed Date fields. Because of the central role played by these fields, retro and segmentation triggers can *only* be generated from *dated* records: retroactive triggers can only be defined for records with *Effective* or *Begin* and *End Date* fields, or records with *Fixed Date* fields; and segmentation triggers can only be defined for records with *Effective Date* fields.

Based on which date field is the source of the trigger effective date, every retro and segmentation trigger falls into one of the following *effective date types*:

- *Effective Date*: Trigger date is based on an Effective Date field.
- *Begin/End Date*: Trigger date is based on a Begin or End Date field.
- *Fixed Date*: Trigger date is based on a fixed date that has been passed as a parameter to the generic PeopleCode function `Generate_Triggers`.

See [Implementing Triggers](#).

When the system processes retro and segmentation triggers, it uses the effective date type to determine what date to use as the trigger effective date.

Note: Iterative triggers do not use the concept of trigger effective dates, since the change date is irrelevant to their function, which is to trigger the calculation or recalculation of the current absence run for a specific payee. They can be defined for non-effective-dated records as well as effective-dated and begin and end dated records.

Trigger Levels

When you set up triggers in Absence Management, you must specify the level at which the system responds to database changes. You can set up the system to generate triggers in response to effective or begin and end date changes to any field in a record (trigger level = *Record*), to all changes to a specific field in the record (trigger level = *Field, Non Value Based*), or only when a specific value is entered in the field (trigger level = *Field, Value Based*). The trigger level determines when and under what conditions the system generates triggers.

Rules for Iterative Triggers: Generating Triggers

Iterative triggers are generated only when an open calendar group exists; the calendar group must be "Identified."

When the trigger level is *Record*, the system generates an iterative trigger if a row is added, changed, or deleted.

When the trigger level is *Field, Non-Value-based*, the system generates an iterative trigger if:

- A row and the field are changed.
- A row is added or deleted.

Note: For *Field*, Non-Value-based triggers, adding a row causes a trigger to be generated only if the field value changes.

When the trigger level is *Field*, Value-based, besides observing the rules for non-value-based triggers, the system generates an iterative trigger only if the value of the added, changed, or deleted row matches a value you specified earlier, or you have chosen to generate triggers even if no values match.

Rules for Retroactive Triggers: Setting Trigger Effective Dates and Generating Triggers

When Trigger Effdt Type is *Effective Date*:

- By default, if a row is added, the system uses the effective date as the trigger effective date.

Note: Although the default is to use the change date (the effective date of the added row) as the trigger effective date, you can modify effective dating of retro triggers on the Trigger Definitions – Field Values page so that the trigger date falls before or after the actual change date.

See [Trigger Definitions - Field Values Page](#).

- If a row is deleted, the system uses the initial effective date as the trigger effective date.
- If a row is changed, the system uses the earlier of the initial effective date and the changed effective date as the trigger effective date.

The initial effective date is the effective date with which the row was loaded. The changed effective date is the effective date of the row at save time. If you haven't changed the effective date, it's the same as the initial effective date. If you've changed the effective date, it is different from the initial effective date.

When Trigger Effdt Type is *Begin/End Date*:

- By default, if a row is added, the system uses the begin date as the trigger effective date.

Note: Although the default is to use the change date (the begin date of the added row) as the trigger effective date, you can modify effective dating of retro triggers on the Trigger Definitions – Field Values page so that the trigger date falls before or after the actual change date.

See [Trigger Definitions - Field Values Page](#).

- If a row is deleted, the system uses the initial begin date as the trigger effective date.
- If a row is changed and the end date is the only changed field, the system uses the earlier of the initial end date and changed end date as the trigger effective date; otherwise, the system uses the earlier of the initial begin date and the changed begin date as the trigger effective date.

The initial begin date is the begin date with which the row was loaded. The changed begin date is the begin date of the row at save time. If you haven't changed the begin date, it's the same as the initial begin date. If you've changed the begin date, it is different from the initial begin date.

The initial end date is the end date with which the row was loaded. The changed end date is the end date on the row at save time. If you haven't changed the end date, it's the same as the initial end date. If you've changed the end date, it's different from the initial end date.

Note: With absences, the system uses the begin date as the trigger effective date even if you change the end date. If an existing row is voided, and a new row is created, the system uses the begin date as the trigger effective date.

When Trigger Effdt Type is *Fixed Date*, the trigger date is the date that you specify as a parameter in the PeopleCode function `Generate_Triggers`.

When Trigger Level is *Record*:

- The system generates a retro trigger if a row is added, changed, or deleted.
- If you change multiple rows, the earliest trigger date from all the changed rows is used as the trigger effective date.

When Trigger Level is *Field*, Non-Value-based:

- If a row is added or deleted, the system finds the maximum effective-dated row that's earlier than the trigger date for the row.

If the field value differs between the prior row and the added or deleted row, the system generates a retroactive trigger.

- If a row and the field value are changed, the system generates a retroactive trigger regardless of whether the effective date for that row is changed.
- If a row and the effective date for that row are changed (assume the effective date before the change is the "old date" and the effective date after the change is the "new date"):
 - If the field is changed, the system generates a retroactive trigger.
 - The system finds the row whose maximum effective date is less than the new date.

If the field value differs between the prior row and the changed row, a retroactive trigger is generated.

- The system finds the row whose maximum effective date is less than the old date.

If the field value differs between the prior row and the changed row, a retroactive trigger is generated.
- If a prior row isn't found, the added, changed, or deleted row is the first row in the buffer.

In this case, a retroactive trigger is generated with the primary event ID specified in the trigger definition.

When Trigger Level is *Field*, Value-based, besides observing the rules for non-value-based triggers, the system generates a retroactive trigger only if the value of the added, changed, or deleted row matches a value you specified earlier or you've chosen to generate a trigger even if no values match.

Rules for Segmentation Triggers: Setting Trigger Effective Dates and Generating Triggers

For Absence Management, you can generate segmentation triggers only from records whose Trigger Effdt Type is *Effective Date*.

See [Segmentation Page](#).

Segmentation triggers aren't generated for deleted rows.

When Trigger Effdt Type is *Effective Date*:

- If a row is added, the system uses the effective date of the added row as the trigger effective date.
- If a row is changed, the system uses the effective date of the change as the trigger effective date (not the initial effective date).

Note: The initial effective date is the effective date with which the row was loaded. The changed effective date is the effective date of the row at save time.

- If a row is added, the system uses the begin date as the effective date of the initial trigger, and the end date + 1 as the effective date of the terminal trigger.
- If a row is changed and the end date is the only changed field, the system uses the changed end date + 1 as the new terminal trigger effective date. If a row is changed and the begin date is the only changed field, the system uses the changed begin date as the new initial trigger effective date.

The initial begin date is the begin date with which the row was loaded. The changed begin date is the begin date of the row at save time. If you haven't changed the begin date, it's the same as the initial begin date. If you've changed the begin date, it is different from the initial begin date.

The initial end date is the end date with which the row was loaded. The changed end date is the end date on the row at save time. If you haven't changed the end date, it's the same as the initial end date. If you've changed the end date, it's different from the initial end date.

When Trigger Level is *Record*, the system generates a segmentation trigger if a row is added or changed.

When Trigger Level is *Field*, Non-Value-based:

- If a row is added or changed, the system finds the row whose maximum effective date is less than the added or changed row.

If the field value differs between the prior and current row, the system generates a segmentation trigger.

- If a prior row cannot be found:
 - If the field value is changed, the system generates a segmentation trigger.
 - If it is a new row, the system generates a segmentation trigger for all specified fields.

When Trigger Level is *Field*, Value-based, besides observing the rules for non-value-based triggers, the system generates a segmentation trigger only if the value of the added or changed row matches a value you specified earlier or you have chosen to generate triggers even if no values match.

Managing Used or Obsolete Triggers

The Absence Management system automatically marks retro and iterative triggers as used once they initiate the required processing so that they do not affect future calculations. In addition, you can manually cancel both iterative and retro triggers that have been created in error or that you do not want

to impact absence processing. By contrast, segmentation triggers are designed to remain active in the system, since if a segmentation event occurs during a calculation period, it should trigger segmentation every time the period is processed. However, there are times when segmentation events need to be modified or removed after they are entered in the system, either because they should not have been entered at all, the dates of the event were entered incorrectly, or other data was recorded incorrectly. The Absence Management system addresses the problem of unnecessary segmentation triggers by automatically deleting them in response to the following data changes at each of the three trigger levels (*Record, Field-Non Value Based, Field-Value Based*):

| Data Change | Record Trigger Level | Field – Non Value Based Trigger Level | Field – Value Based Trigger Level |
|--|-----------------------------|--|--|
| Effective, Begin, or End Date Correction | Yes | Yes | Yes |
| Field Value Correction | No | Yes | Yes |
| Row Deletion | Yes | Yes | Yes |

Important! The system only deletes automatically generated triggers, not manually generated triggers or mass triggers.

Note: Although the system automatically removes segmentation triggers in the situations described here, you can also manually cancel segmentation triggers just as you can iterative and retro triggers. To manage and cancel triggers, use the pages in the Review Triggers (GP_TRIGGER) and Review Iterative Triggers (GP_TRGRITER_CALRUN) components.

Example: Removing a Segmentation Trigger In Response to a Change In the Effective Date of a Row

Assume that there is a *Field, Value Based* trigger on the JOB record.

The field and field values defined to generate triggers are **Action** and *DTA* (data change) or *TER* (termination).

Assume that you change the effective date of a termination action (TER) from November 15 to November 20.

When the effective date associated with this action changes, the system should:

- Delete the old trigger associated with the changed source row.
- Insert a new trigger with a new trigger effective date.

| User Action | Field Change | Effdt/Effseq | Trigger Action | Trigger Effdt | Source Field Value | Trigger Event ID |
|--------------------|---------------------|---------------------|-----------------------|----------------------|---------------------------|-------------------------|
| Existing Row | DTA | 10/20/05 | Insert | 10/20/05 | DTA | Event 1 |

| User Action | Field Change | Effdt/Effseq | Trigger Action | Trigger Effdt | Source Field Value | Trigger Event ID |
|--------------------|---------------------|---------------------|-----------------------|----------------------|---------------------------|-------------------------|
| Existing Row | TER | 11/15/05 | Insert | 11/15/05 | TER | Event 1 |
| Correction | TER | 11/20/05 | Delete | 11/15/05 | TER | Event 1 |
| | | | Insert | 11/20/05 | TER | Event 1 |

In this example, the effective date of the November 15 termination row changes to November 20. As a result, the system deletes the November 15 trigger and creates a new trigger with an effective date of November 20.

Example: Removing a Segmentation Trigger In Response to a Change In a Field Value

Assume that there is a *Field, Value Based* trigger on the JOB record.

The field and field values defined to generate triggers are **Action** and *PAY* (pay rate change) or *TER* (termination).

Assume that you change the Action value of an October 20 effective-dated row from TER (termination) to DTA (data change).

When the effective date associated with this action changes, the system should delete the old trigger without creating a new one:

| User Action | Field Change | Effdt/Effseq | Trigger Action | Trigger Effdt | Source Field Value | Trigger Event ID |
|--------------------|---------------------|---------------------|-----------------------|----------------------|---------------------------|-------------------------|
| Existing Row | PAY | 01/01/05 | Insert | 01/01/05 | PAY | Event 1 |
| Existing Row | TER | 10/20/05 | Insert | 10/20/05 | TER | Event 1 |
| Existing Row | DTA | 11/15/05 | None | | TER | Event 1 |
| Correction | DTA | 10/20/05 | Delete | 10/20/05 | TER | Event 1 |
| | | | No Trigger | | | |

In this example, the value of the October 20 effective-dated row changes from TER to DTA. Because DTA is not a recognized value for trigger generation (only TER and PAY are set up to generate triggers), the system deletes the trigger with the October 20 effective date without generating a new one.

Example: Removing a Segmentation Trigger In Response to a Change In a Field Value

Assume that there is a *Field, Value Based* trigger on the JOB record.

The field and field values defined to generate triggers are **Action** and *DTA* (data change) or *TER* (termination).

Assume that you change the Action value of a July 1, 2005 effective-dated row from PAY (pay rate change) to DTA (data change), and that there is a second, preexisting row with a value of DTA and an effective date of January 1, 2006. This example shows that the latter row is affected by the change to the earlier row:

| User Action | Field Change | Effdt/Effseq | Trigger Action | Trigger Effdt | Source Field Value | Trigger Event ID |
|--------------------|---------------------|---------------------|-----------------------|-----------------------|---------------------------|-------------------------|
| Existing Row | PAY | 01/01/05 | None | | DTA | Event 1 |
| Existing Row | PAY | 07/01/05 | None | | TER | Event 1 |
| Existing Row | DTA | 01/01/06 | Insert | 01/01/06 | TER | Event 1 |
| Correction | DTA | 07/01/05 | Delete | No trigger to delete. | TER | Event 1 |
| | | | Insert | 07/01/05 | | |
| | | | Delete | 01/01/06 | | |
| | | | No Trigger | | | |

In this example, the value of the July 1, 2005 effective-dated row changes from PAY to DTA. Because trigger generation is based on field value changes, and there is no change between the July 1, 2005 and January 1, 2006 rows (both have a field value of DTA), the system deletes the trigger originally created for the latter row, and inserts a new trigger with a July 1, 2005 effective date. Note that there are no triggers for the PAY rows, as PAY is not a value that has been defined for trigger generation.

Special Rules for Field-Based Segmentation Triggers for Records Containing EFFSEQ (Effective Sequence) Field

There are special rules for managing field-based segmentation triggers if the record contains the field EFFSEQ (for example, the JOB record):

- When the trigger definition is *Field – Non Value Based*, the trigger generation PeopleCode inserts a trigger for a given effective date using only the highest effective sequence row. That is, only the highest effective sequence row per effective date matters when the trigger definition is Field – Non Value based. This prevents unnecessary trigger generation when you enter first one effective sequence row and then another with the same effective date to correct errors in the first row.

- When the trigger definition is *Field – Value Based*, the trigger generation PeopleCode inserts a separate trigger for each effective sequence row with a given effective date. In other words, all effective sequence rows are processed when the trigger definition is value based. This is to accommodate situations in which it is necessary or desirable to have multiple effective sequence rows. For example, there are some fields such as JOB.ACTION in which you might enter a transfer and a promotion one after another on the same day. This field would most likely have a value-based trigger definition.

Defining Triggers Manually

In addition to setting up the system to generate triggers automatically, you can enter triggers manually on the Review Triggers component (GP_TRIGGER) by selecting the trigger type, the trigger effective date, the process definition, and other data needed by the system to initiate retroactive or segmentation processing.

Note: Iterative triggers can not be added manually.

See [Managing Automatically Generated Triggers and Defining Triggers Manually](#).

Setting Up Trigger Definitions

Pages Used to Set Up Trigger Definitions

| <i>Page Name</i> | <i>Definition Name</i> | <i>Usage</i> |
|---|------------------------|---|
| Trigger Definitions Page | GP_TRGR_SETUP | Define iterative, segmentation, and retroactive triggers. To create a retroactive or segmentation trigger, first define the appropriate event ID on the Retro Event Definition page or Segmentation Event Definition page. |
| Trigger Definitions - Field Values Page | GP_TRGR_SETUP_SEC | Indicate which field values initiate actions. |

Related Links

[Understanding Calendars](#)

[Understanding Retroactive Processing](#)

[Understanding Segmentation Setup](#)

Understanding Trigger Definition Setup

This topic discusses the setup steps for automatic trigger generation by the online system.

Note: PeopleSoft recommends that when you define a retroactive or segmentation trigger, you also define an iterative trigger. If a calendar group has been calculated once and data changes are subsequently made, unless an iterative trigger is defined, retroactive or segmentation triggers generated from the data changes are not processed until the next Identify phase.

Setting Up Iterative Triggers

Iterative triggers can be defined for both effective and begin and end dated records, as well as for non-dated records.

To set up iterative triggers:

1. Select Set Up HCM, Product Related, Global Payroll & Absence Mgmt, Triggers, Trigger Definitions.

The search page for the Trigger Definitions component (GP_TRGR_SETUP) appears.

2. Select the Add a New Value tab.

3. On the Add a New Value tab, select a country, identify the record you want to make sensitive to data changes in the **Record (Table) Name** field, and select a trigger type of *Iterative*.

4. Click the Add button.

The Trigger Definitions page appears.

5. On the Trigger Definitions page, select a **Trigger Level** of *Record* or *Field*.

Select *Record* to generate a trigger in response to a change to any field in the record; select *Field* if you want the system to generate a trigger only in response to changes to a specific field or group of fields in the record.

If you select *Field*, you must list the fields that you want to make sensitive to data changes in the **List Fields With Trigger** group box. You can further restrict the data changes that result in trigger generation by selecting the **Dependent on Field Value Action** check box for a specific field and specifying the values that trigger iterative processing.

Setting Up Retro Triggers

Retro triggers can be defined for both effective and begin and end dated records, as well as for fixed date records.

To set up retro triggers:

1. Select Set Up HCM, Product Related, Global Payroll & Absence Mgmt, Triggers, Trigger Definitions.

The search page for the Trigger Definitions component (GP_TRGR_SETUP) appears.

2. Select the Add a New Value tab.

3. On the Add a New Value tab, select a country, identify the record you want to make sensitive to data changes in the **Record (Table) Name** field, and select a trigger type of *Retro*.

4. Click the Add button.

The Trigger Definitions page appears.

5. On the Trigger Definitions page, select a trigger event ID (or primary event ID if the trigger level is *Field*).

Trigger event IDs tell the system how to process retroactive data.

Note: Define trigger event IDs on the Retro Event Definition page.

See [Setting Up Retroactive Processing](#).

6. On the Trigger Definitions page, select a **Trigger Level** of *Record* or *Field*.

Select *Record* if you want the system to generate a trigger in response to a change to any field in the record; select *Field* if you want the system to generate a trigger in response to changes to a specific field or group of fields in the record.

If you select *Field*, you must list the fields that you want to make sensitive to data changes in the **List Fields With Trigger** group box. You can further restrict the data changes that result in trigger generation by selecting the **Dependent on Field Value Action** check box for a specific field, click the **List Field Values** link, and specifying the values that trigger retro processing.

7. In addition, you must specify a trigger event ID or primary event ID at one of the following levels:
 - If you select *Record* as the trigger level, specify the trigger event ID in the **Trigger Event ID** field at the record level on the Trigger Definitions page.
 - If you select *Field* as the trigger level, and trigger generation is not dependent on specific field values, specify the trigger event ID at the field level in the **List Fields With Trigger** group box on the Trigger Definitions page.
 - If you select *Field* as the trigger level, and retro is dependent on specific field values, click the **List Field Values** link and specify the trigger event ID at the field value level in the **Field Values** group box on the Trigger Definitions – Field Values page.
 - In addition, if you select *Field* as the trigger level, you must enter a primary event ID at the record level in the **Primary Event ID** field on the Trigger Definitions page. This ID functions as the default event ID when the changed, added, or deleted row that triggers retro processing is the first row in the buffer (that is, a prior row cannot be found).

Note: The **Primary Event ID** field appears only when the trigger type is *Retro* and the trigger level is *Field*.

Setting Up Segmentation Triggers for Effective-dated Records

In Absence Management, you can set up segmentation triggers for effective-dated records. In this topic we discuss the steps for setting up segmentation triggers for effective-dated records.

To set up segmentation triggers for effective-dated records:

1. Select Set Up HCM, Product Related, Global Payroll & Absence Mgmt, Triggers, Trigger Definitions.
The search page for the Trigger Definitions component (GP_TRGR_SETUP) appears.
2. Select the Add a New Value tab.

3. On the Add a New Value tab, select a country, identify the record you want to make sensitive to data changes in the **Record (Table) Name** field, and select a trigger type of *Segmentation*.
4. Click the Add button.

The Trigger Definitions page appears.

5. On the Trigger Definitions page, select a **Trigger Level** of *Record* or *Field*.

Select *Record* if you want the system to generate a trigger in response to a change to any field in the record; select *Field* if you want the system to generate a trigger in response to changes to a specific field or group of fields in the record.

If you select *Field*, you must list the fields that you want to make sensitive to data changes in the **List Fields With Trigger** group box. You can further restrict the data changes that result in trigger generation by selecting the **Dependent on Field Value Action** check box for a specific field, click the **List Field Values** link, and specifying the values that should result in trigger generation.

6. In addition, you must define a trigger event ID at the appropriate level:
 - If you select *Record* as the trigger level, define the trigger event ID at the record level on the Trigger Definitions page.
 - If you select *Field* as the trigger level, and segmentation is not dependent on specific field values, specify the trigger event ID at the field level in the **List Fields With Trigger** group box on the Trigger Definitions page.
 - And if you select *Field* as the trigger level, and segmentation is dependent on specific field values, click the **List Field Values** link and specify the trigger event ID at the field value level in the **Field Values** group box on the Trigger Definitions – Field Values page.

Note: The trigger event IDs tells the system what type of segmentation to use (*period* or *element* segmentation), and in the case of element segmentation, what elements to segment in response to a change in data. You define trigger event IDs on the Segmentation Event Definition page.

See [Segmentation Event Definition Page](#).

Trigger Definitions Page

Use the Trigger Definitions page (GP_TRGR_SETUP) to define iterative, segmentation, and retroactive triggers.

To create a retroactive or segmentation trigger, first define the appropriate event ID on the Retro Event Definition page or Segmentation Event Definition page.

Navigation:

Set Up HCM > Product Related > Global Payroll & Absence Mgmt > Triggers > Trigger Definitions > Trigger Definitions

This example illustrates the fields and controls on the Trigger Definitions page.

Trigger Definitions

Country

Record (Table) Name

Trigger Type

*Trigger Event ID

*Trigger Status

*Trigger Level

*Trigger Effective Date Type

List Fields with trigger Personalize | Find | View All | First 1-5 of 5 Last

| Field Name | Dependent on Field Value | List Field Values | Trigger Event ID |
|---|-------------------------------------|-------------------|----------------------------------|
| <input type="text" value="ACTION"/> | <input checked="" type="checkbox"/> | List Field Values | |
| <input type="text" value="COMPANY"/> | <input type="checkbox"/> | | <input type="text" value="JOB"/> |
| <input type="text" value="DEPTID"/> | <input type="checkbox"/> | | <input type="text" value="JOB"/> |
| <input type="text" value="GP_PAYGROUP"/> | <input type="checkbox"/> | | <input type="text" value="JOB"/> |
| <input type="text" value="PAY_SYSTEM_FLG"/> | <input type="checkbox"/> | | <input type="text" value="JOB"/> |

Note: The fields on this page vary depending on the type of trigger you are creating and the values you select.

| Field or Control | Description |
|----------------------------|---|
| Country | Specify the country for which you are defining the trigger. |
| Record (Table) Name | Displays the record (table) name that you selected to access this page. This record can stand alone or be part of the record and field combination that generates a trigger in response to an online data change. |
| Trigger Type | Displays the trigger type that you selected to access this page. Options are: <i>Iterative</i> , <i>Retro</i> , and <i>Segmentation</i> . |

| Field or Control | Description |
|-------------------------|--|
| Trigger Event ID | <p>For retro and segmentation triggers, specify the trigger event ID at the record level, the field level, or the field value level:</p> <ul style="list-style-type: none"> If the Trigger Level is <i>Record</i>, specify the trigger event ID in the Trigger Event ID field at the top of the page. <hr/> <p>Note: This field isn't available at the record level when the trigger type is <i>Segmentation</i> and trigger level is <i>Field</i>.</p> <hr/> <p>Note: The Trigger Event ID, record level field is replaced by the Primary Event ID field when the trigger type is <i>Retro</i> and the Trigger Level is <i>Field</i> (see below).</p> <hr/> <ul style="list-style-type: none"> If the Trigger Level is <i>Field-Non Value Based</i>, specify the trigger event ID in the Trigger Event ID field in the List Fields With Trigger group box. If the Trigger Level is <i>Field-Value Based</i>, specify the trigger event ID in the Field Values group box on the Trigger Definitions-Field Values page. <hr/> <p>Note: Iterative triggers don't have trigger event definitions, because their only function is to process a payee in the current open calendar; therefore, the defined event is always the same.</p> |
| Trigger Status | To activate the trigger definition, select <i>Active</i> . |
| Trigger Level | <p>Select <i>Record</i> if you want the system to generate a trigger in response to a change to any field in the record; select <i>Field</i> if you want the system to generate a trigger in response to changes to a specific field or group of fields in the record.</p> <p>If you select <i>Field</i>, you must list the fields that you want to make sensitive to data changes in the Field column in the List Fields With Trigger group box. You can further restrict the data changes that result in trigger generation by selecting the Dependent on Field Value Action check box for a specific field, click the List Field Values link, and specifying the values that should result in trigger generation.</p> |
| Primary Event ID | <p>Enter one of the event IDs defined on the Retro Event Definition page.</p> <p>The primary event ID functions as the default event ID when the trigger level is <i>Field</i> and the changed, added, or deleted row that triggers retro processing is the first row in the buffer (that is, a prior row cannot be found). In this case, the system generates a retroactive trigger using the primary retroactive event ID.</p> <hr/> <p>Note: The Primary Event ID field appears only when the trigger type is <i>Retro</i> and the trigger level is <i>Field</i>.</p> |

| Field or Control | Description |
|---------------------------|---|
| Trigger Effdt Type | <p>This field displays one of the following values, based on the record specified in the Record (Table) Name field:</p> <p><i>Effective Date</i></p> <p><i>Begin-End Date</i></p> <p><i>Fixed Date</i></p> <p>Only retro triggers can have a trigger effdt type of <i>Fixed Date</i>. To generate retro triggers with a fixed trigger effective date, you must pass the date as a parameter to the generic PeopleCode function <i>Generate_Triggers</i>. The system generates only one trigger regardless of the number of data changes.</p> <p>See Reviewing PeopleSoft Delivered Triggers.</p> |

List Fields with Trigger

If you select *Field* in the **Trigger Level** field, the **List Fields With Trigger** group box becomes available.

| Field or Control | Description |
|---------------------------------|---|
| Field Name | Enter the name of the field that you want to make sensitive to data changes. |
| Dependent on Field Value | Select this check box to indicate that the fields that you've defined as sensitive to data changes are dependent on specific field values. In this case, only changes to the values you specify on the Trigger Definition - Field Values page will trigger a system action. This enables you to limit the kinds of changes that cause iterative, retroactive, or segmentation processing. |
| List Field Values | <p>This link becomes available when you select the <i>Dependent on Field Value</i> check box.</p> <p>Click to access the Trigger Definitions - Field Values page, where you can list the field values that trigger an action.</p> |
| Trigger Event ID | <p>This field is required when the trigger level is <i>Field</i> and Dependent on Field Value is cleared. Based on the type of trigger you are defining, enter an event ID that you defined on either the Retro Event Definition page or the Segmentation Event Definition page.</p> <hr/> <p>Note: This field is not used with iterative triggers.</p> <hr/> |

Trigger Definitions - Field Values Page

Use the Trigger Definitions - Field Values page (GP_TRGR_SETUP_SEC) to indicate which field values initiate actions.

Navigation:

Click the **List Field Values** link on the Trigger Definitions page.

This example illustrates the fields and controls on the Trigger Definitions – Field Values page.

Trigger Setup-Values

Trigger Definitions

Field Values

Country CYM Cayman Islands
 Record (Table) Name JOB
 Field Name ACTION

| *Sequence | *Character Value | *Trigger Event ID | | |
|-----------|------------------|-------------------|---|---|
| 1 | HIR | JOB | + | - |
| 2 | TER | JOB | + | - |
| 3 | RET | JOB | + | - |

No Match on Field Value Option

Do Not Trigger

Trigger Using Specified Event

Trigger Event ID

Field Values

| <i>Field or Control</i> | <i>Description</i> |
|-------------------------|---|
| Sequence | Enter a sequence number, which the system needs to uniquely identify the field values and distinguish them from other rows of data that you might set up. |
| Numeric Value | If the record and field combination stores numeric values, this field is available for entry. Enter the value that triggers a system action. |
| Character Value | If the record and field combination stores character values, this field is available for entry. Enter the value that triggers a system action. |

| Field or Control | Description |
|-------------------------|---|
| Date Value | If the record and field combination stores date values, this field is available for entry. Enter the value that triggers a system action. |
| Trigger Event ID | <p>This field is required when the trigger level is <i>Field</i> and Dependent on Field Value is selected. Based on the type of trigger you are defining, enter an event ID that you defined on either the Retro Event Definition page or the Segmentation Event Definition page.</p> <hr/> <p>Note: This field is not used with iterative triggers.</p> |
| Offset Days | <p>This field is available only when the trigger type is <i>Retro</i>.</p> <p>Enter a positive or negative number to increase or decrease the retro trigger effective date relative to the date of a database change. For example, if you enter -1 in the Offset Days field for one of the values listed in the Field Values group box, and you retroactively enter that value into the database with an effective date of January 1, 2000, the system automatically adjusts the trigger effective date to December 31, 1999 (one day earlier). The system then processes pay periods going back to December 1999 rather than January 2000.</p> |

No Match on Field Value Option

Use the fields in this group box to specify a default trigger event ID to use when a change to a field involves values other than those listed on the Trigger Definitions – Field Values page. Use these fields only if you want these other values to trigger iterative, retro, or segmentation processing.

| Field or Control | Description |
|-------------------------|---|
| Do Not Trigger | This option is selected by default because the system assumes that triggers should be generated only when there is a match between values actually entered in the database and the field values that you identify on the Trigger Definitions – Field Values page. |
| Trigger | When you select this option, the Trigger Event ID field becomes available for entry. |
| Trigger Event ID | Enter a default trigger event ID to use to process field values that are not linked to a trigger event ID on the Trigger Definitions – Field Values page. |

Example: Using Offset Days with Retro Triggers

In PeopleSoft system considers the effective date of a termination entered in the **Action** field in the JOB record to be the first day that a payee is no longer working (in other words, the day before the termination is the last day the payee is considered active). If you attach a trigger to this field to process retroactive terminations, the system, by default, sets the trigger effective date equal to the effective date of the termination row in JOB. This can create problems when the termination effective date is equal to the period begin date (meaning, the last day worked is the last day of the prior pay period). For example, assume that you enter a termination in the JOB record on February 1 after processing and closing the January calendar. In this situation, the system generates a retro trigger with an effective date of February 1, which is within the current period—a period in which the payee is "inactive" and will not be picked up for processing. Because there is no trigger in the prior, closed period (January), this period will not be recalculated and any rules you have set up to generate termination payments will not be processed. To avoid this problem, set the offset days for the *Termination* action value in the JOB record equal to *-1*.

Related Links

[Understanding Retroactive Processing](#)

Implementing Triggers

To implement the trigger definitions you have defined, you must set up your system so that the records used in these definitions declare and call the function `Generate_Triggers` in one of their field's `SavePostChange PeopleCode`. This `PeopleCode` has already been added to most of the records for which you are likely to define triggers—such as JOB—so it is unlikely that you will have to perform this step more than a few times. However, if you do need to add a trigger to a record, complete these steps.

Note: We provide a list of the records to which the `SavePostChange PeopleCode` has been added at the end of this documentation.

1. Declare the function that generates triggers:

```
Declare Function Generate_Triggers PeopleCode
FUNCLIB_GP.TRGR_FUNCTIONS FieldFormula;
```

2. Declare a local date variable as:

```
Local date &L_DT;
```

3. Invoke the function as:

```
Generate_Triggers(EMPLID, &L_DT);
```

The function `Generate_Triggers` is defined in `FUNCLIB_GP.TRGR_FUNCTIONS.FieldFormula` and needs two parameters when it's invoked. The parameters are:

1. `&P_EMPLID`

Indicates the `EMPLID` for which the triggers are to be generated. Use field `EMPLID` for `&P_EMPLID`.

2. `&P_FIXED_DT`

Holds the value of the trigger effective date for records with a Trigger Effdt Type of *Fixed Date*. It is ignored for records with a Trigger Effdt Type of *Effdt* or *Begin-End Date*. Use &L_DT for &P_FIXED_DT.

The variable &L_DT needs to be assigned a value only in case of the Fixed Date type of triggers. Examples are the positive input records, the Manual Positive Input table (GP_PI_MNL_DATA) and the Manual Positive Input Supporting Element Override table (GP_PI_MNL_SOVR).

Note: You can enter PeopleCode that can invoke the function only if certain conditions are met, as discussed in example 2 below.

The following example is from PeopleCode that's delivered with the database. The example shows changes necessary for any additional records that are to generate triggers.

Example: Trigger Record = GP_PYE_SOVR

Sample PeopleCode:

```

PeopleCode on GP_PYE_SOVR.EMPLID.SavePostChange

Declare Function Generate_Triggers PeopleCode
FUNCLIB_GP.TRGR_FUNCTIONS FieldFormula;

Local date &L_DT;

/*-----Function to generate Triggers for Global Payroll-----*/

Generate_Triggers(EMPLID, &L_DT);
    
```

In this example, &L_DT isn't assigned a value, because the Trigger Effdt Type for the Payee Supporting Element Override table (GP_PYE_SOVR) is not *Fixed Date*.

Related Links

[Reviewing PeopleSoft Delivered Triggers](#)

Managing Automatically Generated Triggers and Defining Triggers Manually

Pages Used to Manage Triggers and Enter Triggers Manually

| <i>Page Name</i> | <i>Definition Name</i> | <i>Usage</i> |
|-----------------------------------|------------------------|--|
| Segmentation Page | GP_TRIGGER_SEG | View, add, or cancel segmentation triggers by payee. A segmentation trigger must be active to be viewed or managed on this page. |

| Page Name | Definition Name | Usage |
|---------------------------------------|------------------------|---|
| <u>Retro Page</u> | GP_TRIGGER_RTO | View, add, or cancel retroactive triggers by payee. A retroactive trigger must be unprocessed to be viewed or managed on this page. |
| <u>Iterative Page</u> | GP_TRIGGER_ITER | View iterative triggers by payee. An iterative trigger must be unprocessed to be viewed on this page. |
| <u>Review Iterative Triggers Page</u> | GP_TRGRITER_CALRUN | View iterative triggers by calendar group ID. An iterative trigger must be unprocessed to be viewed on this page. |

Understanding Trigger Management And Manual Trigger Entry

Use the Review Triggers (GP_TRIGGER) and Review Iterative Triggers (GP_TRGRITER_CALRUN) components to:

- Review and manage triggers generated automatically by the online system.
- Define retro and segmentation triggers manually when you want to bypass the setup for online trigger generation.
- View the *source* record or field for a trigger as well as the field value changes that cause iterative, segmentation, or retro processing. This information is useful for debugging and troubleshooting when you are trying to determine why a particular instance of iterative, retro, or segmentation processing took place.

Note: The system does not display source data for manually defined triggers.

Note: You cannot define iterative triggers manually using the Review Triggers (GP_TRIGGER) or Review Iterative Triggers (GP_TRGRITER_CALRUN) components.

Segmentation Page

Use the Segmentation page (GP_TRIGGER_SEG) to view, add, or cancel segmentation triggers by payee.

A segmentation trigger must be active to be viewed or managed on this page.

Navigation:

Global Payroll & Absence Mgmt > Absence and Payroll Processing > Prepare Payroll > Review Triggers > Segmentation

This example illustrates the fields and controls on the Segmentation page – Event ID tab.

| Country | Effective Date | Event ID | Description | *Trigger Level | Empl Record | Trigger Status |
|---------|----------------|----------|---------------------------|----------------|-------------|----------------|
| FRA | 06/15/1996 | EMPLOI | Job segmentation (period) | Job | 0 | Active |

This example illustrates the fields and controls on the Segmentation page – Source tab.

| Country | Effective Date | Event ID | Trigger Source | Created | Source Record | Field Name |
|---------|----------------|----------|-------------------------|--------------------|---------------|--------------|
| FRA | 06/15/1996 | EMPLOI | Automatically Generated | 08/18/2006 11:49AM | JOB | CONTRACT_NUM |

This example illustrates the fields and controls on the Segmentation page – Values tab.

| Country | Effective Date | Event ID | Trigger Field Value | Element |
|---------|----------------|----------|---------------------|---------|
| FRA | 06/15/1996 | EMPLOI | | |

Event ID

Select the Event ID tab.

Use the fields on the Event ID tab to view basic data such as the trigger effective date and trigger event ID for an automatically generated segmentation trigger, or add this data to define a trigger manually.

| Field or Control | Description |
|-------------------------|--|
| Country | Displays the country to which the trigger applies. Enter a country code if you are creating a trigger manually. |
| Effective Date | Displays the trigger effective date in relation to which a pay period or the elements in a pay period are segmented. Enter a trigger effective date if you are defining a trigger manually. |

| Field or Control | Description |
|---|---|
| Event ID | <p>Displays the event ID, which tells the system what type of segmentation to use to process segmentation events and which elements to segment (in the case of element segmentation). The event IDs displayed here are those that you defined on the Segmentation Event Definition page.</p> <p>Enter an event ID if you are creating a trigger manually.</p> |
| Description | <p>Displays a description of the trigger event ID that you defined on the Segmentation Event Definition page.</p> |
| Trigger Level | <p>Options are:</p> <p><i>Payee</i>: If the trigger level is <i>Payee</i>, the system segments pay elements for all jobs belonging to the payee.</p> <p><i>Job</i>: If the trigger level is <i>Job</i>, the system segments pay elements for the job identified by the employee record number in the Empl Rcd # field.</p> |
| Empl Rcd# (employee record number) | <p>Displays the employee record number (job) affected by the segmentation trigger.</p> <p>If you are defining triggers manually, select the employee record number (job) for which you want to create a trigger.</p> <p>If the trigger level is <i>Payee</i>, the system automatically sets the value of this field to <i>0</i>.</p> |
| Trigger Status | <p>Select a trigger status.</p> <p>Options are:</p> <p><i>Active</i>: By default, the value of this field is <i>Active</i>.</p> <p><i>Canceled</i>: Select to cancel an active segmentation trigger. When you select <i>Canceled</i>, the trigger disappears when you click Save and reenter the page.</p> |

Source/TS

Select the Source/TS tab.

Use the Source/TS tab to view the source record and field for a segmentation trigger.

The system displays either the source record, or both the source record and field for a trigger, depending on the trigger level:

| Trigger Level | Information Displayed |
|------------------------|------------------------------|
| Record | Record Information |
| Field, Non-Value Based | Record and Field Information |
| Field, Value-Based | Record and Field Information |

| Field or Control | Description |
|-------------------------|---|
| Country | Same as the Country field on the Event ID tab. |
| Effective Date | Same as the Effective Date field on the Event ID tab. |
| Event ID | Same as the Event ID field on the Event ID tab. |
| Trigger Source | <p>Displays one of the following values:</p> <ul style="list-style-type: none"> • <i>Automatically Generated</i> Indicates that the trigger was created by the online system based on predefined conditions specified during setup. • <i>Manually Generated</i> Indicates that the trigger was manually entered on this page. |
| Source Record | <p>View the record that is the source of a trigger.</p> <p>For manually defined triggers, this field is blank.</p> |
| Field Name | <p>View the field that is the source of the trigger.</p> <p>For manually defined triggers, this field is blank.</p> |
| Timestamp | <p>Displays the day and time the trigger was created.</p> <p>For manually defined triggers, this field is blank.</p> |

Value

Select the Value tab.

Use the Value tab to determine what field value change caused the system to generate a segmentation trigger.

The system displays field values only for triggers at the following trigger levels:

| Trigger Level | Information Displayed |
|------------------------|--|
| Field, Non-Value Based | Field Value Information For segmentation triggers generated from effective-dated records, the system displays the character, date, or numeric value that triggers segmentation. |
| Field, Value-Based | Field Value Information For segmentation triggers generated from effective-dated records, the system displays the character, date, or numeric value that triggers segmentation. |

| Field or Control | Description |
|-------------------------|---|
| Country | Same as the Country field on the Event ID and Source/TS tabs. |
| Effective Date | Same as the Effective Date field on the Event ID and Source/TS tabs. |
| Event ID | Same as the Event ID field on the Event ID and Source/TS tabs. |
| Character Value | Displays the character value that generates a trigger. |
| Numeric Value | Displays the numeric value that generates a trigger. |
| Date Value | Displays the date value that generates a trigger. |

Adding Manual Segmentation Triggers

To manually insert a segmentation trigger:

- Enter a country and an effective date on the Segmentation page – Event ID tab. The system uses the effective date that you specify as the basis for the trigger effective date.
- Specify an event ID for the trigger on the Segmentation page – Event ID tab.

The system uses the event ID to determine which type of segmentation to use and which elements to segment in the case of element segmentation.

The system sets the trigger source to *Manual*, and the trigger status to *Active*.

Note: Unlike automatically generated triggers, manual triggers are independent of any database change defined by a record or record and field combination on the Triggers Definition page. It's important to understand the potential consequences of creating manual triggers. Because they aren't linked to a specific data change, you might segment periods and elements where nothing has changed.

Updating and Canceling Segmentation Triggers

For automatically and manually generated rows of trigger data:

- You can change the event ID.
- You can change the trigger status from *Active* to *Canceled*.
- You cannot reinstate a canceled trigger; you must add a new manual trigger.

For the effective date on generated rows of trigger data:

- The effective date on the Segmentation page is the date in relation to which segmentation occurs.
- You can change the effective date of a manually generated trigger.
- You cannot alter the effective date of a trigger that was generated by the system based on predefined setup rules.

Related Links

[Segmentation and Retro](#)

Retro Page

Use the Retro page (GP_TRIGGER_RTO) to view, add, or cancel retroactive triggers by payee.

A retroactive trigger must be unprocessed to be viewed or managed on this page.

Navigation:

Global Payroll & Absence Mgmt > Absence and Payroll Processing > Prepare Payroll > Review Triggers > Retro

This example illustrates the fields and controls on the Retro page – Event ID tab.

| Country | Trigger Effective Date | Trigger Event ID | Description | Trigger Status |
|---------|------------------------|------------------|------------------------|----------------|
| CYM | 01/01/200 | K0RETRO | Retro Event Definition | Unprocessed |

This example illustrates the fields and controls on the Retro page – Source tab.

| Country | Trigger Effective Date | Trigger Event ID | Retro Trigger Source | Created | Source Record | Field Name |
|---------|------------------------|------------------|----------------------|---------|---------------|------------|
| CYM | 01/01/200 | K0RETRO | Manually Generated | | | |

This example illustrates the fields and controls on the Retro page – Values tab.

| Country | Trigger Effective Date | Trigger Event ID | Trigger Field Value | Trigger Tag |
|---------|------------------------|------------------|---------------------|-------------|
| CYM | 01/01/200 | K0RETRO | | |

Event ID

Select the Event ID Tab.

Use the fields on the Event ID tab to view basic data such as the trigger effective date and trigger event ID for an automatically generated retro trigger, or add this data to define a trigger manually.

| Field or Control | Description |
|-------------------------|--|
| Country | Displays the country to which the trigger applies. Enter a country code if you are creating a trigger manually. |

| Field or Control | Description |
|-------------------------------|--|
| Trigger Effective Date | <p>Displays the trigger effective date. The system uses this date to determine which pay periods to recalculate.</p> <p>Enter a trigger effective date if you are defining a trigger manually.</p> |
| Event ID | <p>Displays the event ID, which tells the system what retro event definition to use to process the retroactive data. The event IDs displayed here are those that you defined on the Retro Event Definition page.</p> <p>Enter an event ID if you are creating a trigger manually.</p> |
| Description | <p>Displays a description of the trigger event ID that you defined on the Retro Event Definition page.</p> |
| Trigger Status | <p>Select a trigger status.</p> <p>Options are:</p> <p><i>Unprocessed</i>: By default, the value of this field is <i>Unprocessed</i>.</p> <p><i>Canceled</i>: Select to cancel a retro trigger. When you select <i>Canceled</i>, the trigger disappears when you click Save and reenter the page.</p> |

Source

Select the Source tab.

Use the Source tab to view the source record and field for a retro trigger.

The system displays either the source record, or both the source record and field for a trigger, depending on the trigger level:

| Trigger Level | Information Displayed |
|------------------------|------------------------------|
| Record | Record Information |
| Field, Non-Value Based | Record and Field Information |
| Field, Value-Based | Record and Field Information |

| Field or Control | Description |
|-------------------------|--|
| Country | Same as the Country field on the Event ID tab. |
| Effective Date | Same as the Effective Date field on the Event ID tab. |
| Event ID | Same as the Event ID field on the Event ID tab. |
| Trigger Source | <p>Displays one of the following values:</p> <ul style="list-style-type: none"> • <i>Automatically Generated</i> Indicates that the trigger was created by the online system based on predefined conditions specified during setup. • <i>Manually Generated</i> Indicates that the trigger was manually entered on this page. • <i>Benefits Administration</i> Indicates that the trigger originates from a PeopleSoft Benefits Administration record. • <i>Mass Triggers</i> Indicates that the trigger was generated using the mass trigger setup. See Understanding Mass Triggers. • <i>Utility Generated</i> Indicates that the trigger was created by third-party software. |
| Trigger Tag | If a trigger is utility-generated, this field displays the source of the trigger. |
| Source Record | <p>View the record that is the source of a trigger.</p> <p>For manually defined triggers, this field is blank.</p> |
| Field Name | <p>View the field that is the source of the trigger.</p> <p>For manually defined triggers, this field is blank.</p> |

Value

Select the Value tab.

Use the Value tab to determine what field value change caused the system to generate a retro trigger.

The system displays field values (character, date, or numeric values) only for triggers at the following trigger levels:

- Field, Non-Value Based
- Field, Value-Based

| Field or Control | Description |
|-------------------------------|---|
| Country | Same as the Country field on the Event ID and Source tabs. |
| Trigger Effective Date | Same as the Trigger Effective Date field on the Event ID and Source tabs. |
| Event ID | Same as the Event ID field on the Event ID and Source tabs. |
| Character Value | Displays the character value that generates a trigger. |
| Numeric Value | Displays the numeric value that generates a trigger. |
| Date Value | Displays the date value that generates a trigger. |
| Timestamp | Displays the day and time the trigger was created. For manually defined triggers, this field is blank. |

Adding Manual Retroactive Triggers

To manually insert a retro trigger:

- Enter the country and an effective date on the Retro page.

The system uses the effective date to determine which periods to recalculate, as in standard retroactivity.

- Connect the trigger to an event ID.

The system uses the event ID that you specify to determine how retroactivity should be processed.

The system sets the trigger source to *Manual* and the trigger status to *Unprocessed*.

Note: Unlike automatically generated triggers, manual triggers are independent of any database changes to a record or a record and field combination. It's important to understand the potential consequences of creating manual triggers. Because they aren't linked to a specific data change, you might process retroactivity in previous periods, where nothing has changed.

Warning! If you add or cancel a retroactive trigger, you should adjust the corresponding retroactive data in the database.

Updating and Canceling Retroactive Triggers

For automatically and manually generated rows of trigger data:

- You can change the event ID.
- You can change the trigger status from *Unprocessed* to *Canceled*.

After a trigger is processed, you cannot alter the trigger status, because it's no longer unprocessed and therefore doesn't appear on the Retro page.

- You cannot reinstate a canceled trigger.

You must add a new manual trigger.

For the trigger effective date on generated rows of trigger data:

- The trigger effective date on the Retro page is the date the system uses to determine what periods to process.
- You can change the trigger effective date of a manually generated trigger (trigger source = *Manual*).
- You cannot alter the trigger effective date of a trigger that has been generated by the system based on predefined setup rules.

Warning! Canceling a trigger does not undo the database change that created the trigger. If there's retroactivity for another reason, this change can be picked up when prior periods are recalculated.

Iterative Page

Use the Iterative page (GP_TRIGGER_ITER) to view iterative triggers by payee.

An iterative trigger must be unprocessed to be viewed on this page.

Navigation:

Global Payroll & Absence Mgmt > Absence and Payroll Processing > Prepare Payroll > Review Triggers > Iterative

This example illustrates the fields and controls on the Iterative page – Calendar Group tab.

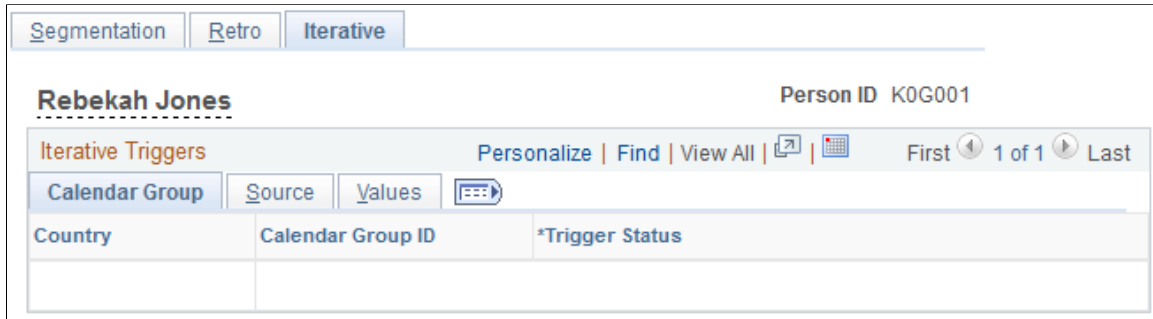

This example illustrates the fields and controls on the Iterative page – Source tab.



This example illustrates the fields and controls on the Iterative page – Values tab.

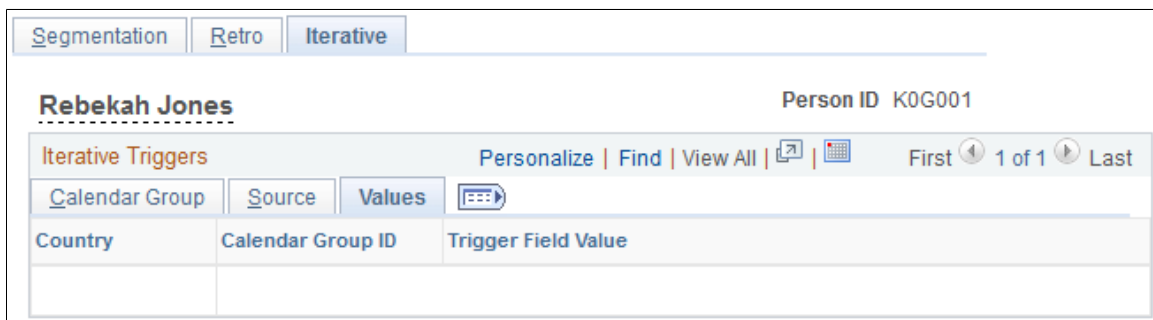

Calendar Group

Select the Calendar Group tab.

Use the fields on the Calendar Group tab to view basic data such as the trigger effective date and calendar group ID for an automatically generated iterative trigger.

| Field or Control | Description |
|--------------------------|--|
| Country | Displays the country to which the trigger applies. |
| Calendar Group ID | Identifies the calendar group in which the iterative trigger is processed. |

| Field or Control | Description |
|-------------------------|---|
| Trigger Status | <p>Select a trigger status.</p> <p>Options are:</p> <p><i>Unprocessed</i>: By default, the value of this field is <i>Unprocessed</i>.</p> <p><i>Canceled</i>: Select to cancel an iterative trigger. When you select <i>Canceled</i>, the trigger disappears when you click Save and reenter the page.</p> |

Source

Select the Source tab.

Use the Source tab to view the source record and field for an iterative trigger.

The system displays either the source record, or both the source record and field for a trigger, depending on the trigger level:

| Trigger Level | Information Displayed |
|------------------------|------------------------------|
| Record | Record Information |
| Field, Non-Value Based | Record and Field Information |
| Field, Value-Based | Record and Field Information |

| Field or Control | Description |
|--------------------------|---|
| Country | Same as the Country field on the Calendar Group tab. |
| Calendar Group ID | Same as the Calendar Group ID field on the Calendar Group tab. |

| Field or Control | Description |
|-------------------------|---|
| Trigger Source | <p>Displays one of the following values:</p> <ul style="list-style-type: none"> • <i>Batch</i> Indicates that the trigger was generated by the system during batch processing. • <i>Online</i> Indicates that the trigger was generated by the online code based on conditions that you specified during setup. • <i>Benefits Administration</i> Indicates that the trigger originates from a Benefits Administration record. • <i>Mass Trigger</i> Indicates that the trigger was generated using mass triggers. See Understanding Mass Triggers. • <i>Uncancel</i> Indicates that the trigger was created when the payee's status was set to <i>Uncancel</i> on the Payee Status page. • <i>Unsuspend</i> Indicates that the trigger was created when the payee's status was set to <i>Unsuspend</i> on the Payee Status page. • <i>Time & Labor</i> • <i>Time & Labor Feed</i> |
| Source Record | View the record that is the source of a trigger. |
| Field Name | View the field that is the source of a trigger. |

Values

Select the Values tab.

Use the Values tab to determine what field value change caused the system to generate an iterative trigger.

The system displays field values (character, date, or numeric values) only for triggers at the following trigger levels:

- Field, Non-Value Based
- Field, Value-Based

| Field or Control | Description |
|--------------------------|---|
| Country | Same as the Country field on the Source tab. |
| Calendar Group ID | Same as the Calendar Group ID field on the Source tab. |
| Character Value | Displays the character value that generates a trigger. |
| Numeric Value | Displays the numeric value that generates a trigger. |
| Date Value | Displays the date value that generates a trigger. |
| Timestamp | Displays the day and time the trigger was created. |

Adding Manual Iterative Triggers

You cannot manually insert a row of trigger data on this page.

Updating and Canceling Iterative Triggers

For automatically generated rows of trigger data, you can change the trigger status from *Unprocessed* to *Canceled*. After a trigger is processed, you cannot alter the trigger status, because it's no longer unprocessed and therefore doesn't appear on the Iterative page.

Review Iterative Triggers Page

Use the Review Iterative Triggers page (GP_TRGRITER_CALRUN) to view iterative triggers by calendar group ID.

An iterative trigger must be unprocessed to be viewed on this page.

Navigation:

Global Payroll & Absence Mgmt > Absence and Payroll Processing > Prepare Payroll > Review Iterative Triggers > Review Iterative Triggers

This example illustrates the fields and controls on the Review Iterative Triggers page – Name tab.

Review Iterative Triggers

Calendar Group ID KZ B200601 2006 01 - Biweekly
Country NZL New Zealand

Iterative Triggers
Personalize | Find | View 100 | | First 1-10 of 294 Last

| Name | Source | Values | |
|----------|-----------------|-----------------|--|
| Empl ID | Name | *Trigger Status | |
| GATAX001 | HENRY KING | UnProcessed | |
| GATAX002 | JACK WELCH | UnProcessed | |
| GATAX003 | SHYAMA VARGESE | UnProcessed | |
| GATAX004 | SOWMYA GOMES | UnProcessed | |
| GATAX005 | Michele Pfiffer | UnProcessed | |
| GATAX006 | CHARLEIZ THERON | UnProcessed | |
| GATAX007 | ABDUR RAZZAQ | UnProcessed | |
| GATAX008 | REHMAN MALLICK | UnProcessed | |
| GATAX009 | VINOD DHAM | UnProcessed | |
| GATAX009 | VINOD DHAM | UnProcessed | |

This example illustrates the fields and controls on the Review Iterative Triggers page – Source tab.

Review Iterative Triggers

Calendar Group ID KZ B200601 2006 01 - Biweekly
Country NZL New Zealand

Iterative Triggers
Personalize | Find | View 100 | | First 1-10 of 294 Last

| Name | Source | Values | | |
|----------|----------------|--------------------|-------------|------------|
| Empl ID | Trigger Source | Created | Record Name | Field Name |
| GATAX001 | Online | 05/26/2013 9:15PM | JOB | ACTION |
| GATAX002 | Online | 05/26/2013 9:30PM | JOB | ACTION |
| GATAX003 | Online | 05/26/2013 9:51PM | JOB | ACTION |
| GATAX004 | Online | 05/26/2013 10:03PM | JOB | ACTION |
| GATAX005 | Online | 05/26/2013 10:30PM | JOB | ACTION |
| GATAX006 | Online | 05/26/2013 11:25PM | JOB | ACTION |
| GATAX007 | Online | 05/26/2013 11:30PM | JOB | ACTION |
| GATAX008 | Online | 05/26/2013 11:38PM | JOB | ACTION |
| GATAX009 | Online | 05/26/2013 11:51PM | PERSON | BIRTHDATE |
| GATAX009 | Online | 05/26/2013 11:51PM | JOB | ACTION |

This example illustrates the fields and controls on the Review Iterative Triggers page – Values tab.

Review Iterative Triggers

Calendar Group ID KZ B200601 2006 01 - Biweekly

Country NZL New Zealand

Iterative Triggers
Personalize | Find | View 100 | |
First 1-10 of 294 Last

| Name | Source | Values | |
|----------|-----------------|---------------|------------|
| Empl ID | Character Value | Numeric Value | Date Value |
| GATAX001 | HIR | | |
| GATAX002 | HIR | | |
| GATAX003 | HIR | | |
| GATAX004 | HIR | | |
| GATAX005 | HIR | | |
| GATAX006 | HIR | | |
| GATAX007 | HIR | | |
| GATAX008 | HIR | | |
| GATAX009 | | | 01/01/1985 |
| GATAX009 | HIR | | |

Name

Select the Name tab.

Use the fields on the Name tab to view basic data such as the EmplID, employee name, and status associated with an automatically generated trigger.

| Field or Control | Description |
|-------------------------|---|
| EmplID | Displays the EmplID of the payee associated with the iterative trigger. |
| Name | Displays the name of the payee associated with the iterative trigger. |

| Field or Control | Description |
|-------------------------|---|
| Trigger Status | <p>Select a trigger status.</p> <p>Options are:</p> <p><i>Unprocessed</i>: By default, the value of this field is <i>Unprocessed</i>.</p> <p><i>Canceled</i>: Select to cancel an iterative trigger. When you select <i>Canceled</i>, the trigger disappears when you click Save and reenter the page.</p> |

Source

Select the Source tab.

Use the Source tab to view the source record and field for an iterative trigger.

The system displays either the source record, or both the source record and field for a trigger, depending on the trigger level:

| Trigger Level | Information Displayed |
|------------------------|------------------------------|
| Record | Record Information |
| Field, Non-Value Based | Record and Field Information |
| Field, Value-Based | Record and Field Information |

| Field or Control | Description |
|-------------------------|--|
| EmpIID | Same as the EmpIID field on the Name tab. |
| Name | Same as the Name field on the Name tab. |

| Field or Control | Description |
|-------------------------|---|
| Trigger Source | <p>Displays one of the following values:</p> <ul style="list-style-type: none"> • <i>Batch</i> Indicates that the trigger was generated by the system during batch processing. • <i>Online</i> Indicates that the trigger was generated by the online code based on conditions that you specified during setup. • <i>Benefits Administration</i> Indicates that the trigger originates from a Benefits Administration record. • <i>Mass Trigger</i> Indicates that the trigger was generated using mass triggers. See Understanding Mass Triggers. • <i>Uncancel</i> Indicates that the trigger was created when the payee's status was set to <i>Uncancel</i> on the Payee Status page. • <i>Unsuspend</i> Indicates that the trigger was created when the payee's status was set to <i>Unsuspend</i> on the Payee Status page. • <i>Time & Labor</i> • <i>Time & Labor Feed</i> |
| Record Name | View the record that is the source of a trigger. |
| Field Name | View the field that is the source of a trigger. |

Values

Select the Values tab.

Use the Values tab to determine what field value change caused the system to generate an iterative trigger.

The system displays field values (character, date, or numeric values) only for triggers at the following trigger levels:

- Field, Non-Value Based
- Field, Value-Based

| Field or Control | Description |
|-------------------------|--|
| EmplID | Same as the EmplID field on the Source tab. |
| Name | Same as the Name field on the Source tab. |
| Character Value | Displays the character value that generates a trigger. |
| Numeric Value | Displays the numeric value that generates a trigger. |
| Date Value | Displays the date value that generates a trigger. |
| Timestamp | Displays the day and time the trigger was created. |

Reviewing PeopleSoft Delivered Triggers

To facilitate trigger generation, Absence Management delivers the following records with trigger PeopleCode attached. These are delivered as a starting point. You can add trigger-generating PeopleCode to other records to meet your specific business needs, or delete the PeopleCode from any of these records:

Note: Absence Management trigger-generation logic is stored in the FUNCLIB_GP.TRGR_FUNCTIONS FieldFormula PeopleCode. In order for a record to generate triggers, the GENERATE_TRIGGERS function stored there must be declared and called from the record in SavePostedit peoplecode.

See [Implementing Triggers](#).

- ADDRESSES
- BEN_PROG_PARTIC
- COMPENSATION
- CONTRACT_DATA
- DEP_BEN_ADDR
- DEP_BEN_EFF
- DEP_BEN_NAME
- GP_ABS_EVNT
- GP_ABS_OVRD

- GP_OFFCYCL_A_VW
- GP_OFFCYCL_M_VW
- GP_OFFCYCL_M_VW
- GP_OFFCYCL_U_VW
- GP_PI_MNL_DATA
- GP_PI_MNL_D_VW
- GP_PI_MNL_E_VW
- GP_PI_MNL_SOVR
- GP_PI_MNL_SSN
- GP_PYE_OVRD
- GP_PYE_OVR_SOVR
- GP_PYE_SECT_DTL
- GP_PYE_SOVR
- GP_RTO_TRGR
- GP_RTO_TRGR_VW
- GP_SEG_TRGR
- HEALTH_BENEFIT
- JOB
- JOB_JR
- LIFE_ADD_BEN
- LIFE_ADD_BENEFC
- PERSON
- PERS_DATA_EFFDT
- PER_ORG_ASGN
- PRIMARY_JOBS
- SCH_ASSIGN
- SCH_MNG
- SCH_TBL
- WKF_CNT_TYPE

Note: PeopleSoft recommends that you set up period segmentation triggers for changes in the **Pay System Flag** and **Pay Group** fields on the JOB record.

Setting Up Mass Triggers

Understanding Mass Triggers

This feature enables you to generate employee triggers based on changes to setup tables. Mass triggers can be established for specific records on specific components. A set of SQL objects defines the population affected by the setup table change. Once the affected employees are determined, you can review the trigger details before accepting the changes.

To set up mass triggers you must:

- Define the component/record and fields that activate the trigger on the Mass Trigger Definition page.
See [Mass Trigger Definition Page](#).
- Set up the SQL objects that will check the records to determine the population affected by the setup table change. You must define the SQL objects using PeopleTools and select them on the Mass Trigger SQL page.
See [Mass Trigger SQL Page](#).
- Set up your system so that the records used in the mass trigger definitions declare and call the function `Generate_Triggers` in one of their field's `SavePostChange` PeopleCode.
See [Declaring and Calling the Generate_Triggers Function](#).

The mass trigger event process occurs in three steps:

1. After saving the page containing the component/record and fields that activate the mass trigger, the event and the field values are stored in the mass trigger result table (`GP_MT_TRIGGER`). The event status is set to `Unexpanded`.
2. The system evaluates the SQL objects and writes the results to the mass trigger results table (`GP_MT_RESULT`), which records the impacted population. The event status is set to `Expanded`, if all objects expand successfully.
3. The system generates a list of retro and iterative triggers for the impacted population. Once completed, the event status is set to `Triggers Generated`.

You can view the events and their results on the Mass Trigger Events component. The system enables you to do the following:

- Delete a trigger event using the Mass Trigger Events page. This includes the mass trigger, the impacted population, and the generated payee triggers. Deletion cannot occur if any of the generated triggers have been processed.
See [Mass Trigger Events Page](#).

- Manually expand an event using the Affected Employees page. You may want to generate triggers after correcting an erroneous SQL object. Manually expanded triggers can do the following:
 - Generate the impacted population and the retroactive and iterative triggers for events that have a status of Unexpanded.
 - Generate retroactive and iterative triggers for events that have a status of Expanded.

See [Affected Employees Page](#).

Declaring and Calling the Generate_Triggers Function

Absence Management trigger-generation logic is stored in the FUNCLIB_GP.TRGR_FUNCTIONS FieldFormula PeopleCode. In order for a record to generate triggers, the GENERATE_TRIGGERS function stored there must be declared and called from the record in SavePostChange PeopleCode. We describe this function in detail with supporting examples in the documentation on defining retroactive, segmentation, and iterative triggers. In this topic, we summarize only the main setup steps.

Using Generate_Triggers PeopleCode

To declare and call the Generate_Triggers function:

1. Declare the function that generates triggers:

```
Declare Function Generate_Triggers PeopleCode
FUNCLIB_GP.TRGR_FUNCTIONS FieldFormula;
```

2. Declare a local date variable as:

```
Local date &L_DT;
```

3. Invoke the function as:

```
Generate_Triggers(EMPLID, &L_DT);
```

The function Generate_Triggers is defined in FUNCLIB_GP.TRGR_FUNCTIONS.FieldFormula and needs two parameters when it is invoked. These parameters are:

- **&P_EMPLID**
Identifies the EMPLID for which a trigger should be generated. Use field EMPLID for &P_EMPLID.
- **&P_FIXED_DT**
Holds the value of the trigger effective date for records with a Trigger Effdt Type of *Fixed Date*. It is ignored for records with a Trigger Effdt Type of *Effdt* or *Begin-End Date*. Use &L_DT for &P_FIXED_DT.

The variable &L_DT needs to be assigned a value only in the case of *Fixed Date* type triggers.

Related Links

[Implementing Triggers](#)

Setting Up Mass Triggers

Pages Used to Set Up Triggers

| <i>Page Name</i> | <i>Definition Name</i> | <i>Usage</i> |
|--|------------------------|--|
| Mass Trigger Definition Page | GP_MT_TRG_DFN | Define which record activates the trigger. |
| Mass Trigger SQL Page | GP_MT_TRG_SQL | Specify which SQL objects must be executed in order to retrieve the population impacted by a mass trigger event. |
| View SQL Definition Page | GP_MT_SQLTXT_SEC | View the SQL definition. |

Mass Trigger Definition Page

Use the Mass Trigger Definition page (GP_MT_TRG_DFN) to define which record activates the trigger.

Navigation:

Set Up HCM > Product Related > Global Payroll & Absence Mgmt > Triggers > Mass Trigger Definitions > Mass Trigger Definition

This example illustrates the fields and controls on the Mass Trigger Definition page.

The screenshot displays the 'Mass Trigger Definition' page. At the top, there are two tabs: 'Mass Trigger Definition' (selected) and 'Mass Trigger SQL'. Below the tabs, the 'Component Name' is 'BEN_PROG_DEFN' and the 'Benefit Program Table' is 'Benefit Program Table'. The 'Record List' section shows a single record with the following details:

- *Record Name: BEN_DEFN_COST (Benefit Opt Cost Definition)
- *Status: Active
- *Country: USA (United States)
- *Trigger Event ID: BEN MT (Benefits Mass Triggers)
- Ignore Terminated Employees

Below the record list is a 'Field List' table:

| Field Name | Description | | |
|---------------|----------------------------|---|---|
| CALC_RULES_ID | Calculation Rules Table ID | + | - |
| RATE_TBL_ID | Rate Table ID | + | - |
| RATE_TYPE | Benefit Rate Type | + | - |

| Field or Control | Description |
|------------------------------------|--|
| Trigger Event ID | Associate a Trigger Event ID with the record (table) to link the mass trigger to the retroactive process ID that processes the generated payee triggers. |
| Ignore Terminated Employees | Select to ignore terminated employees when processing the mass trigger. |
| Field Name | List the fields that cause the system to generate a mass trigger event. Fields used as input parameters on the SQL Objects page need not be listed here. The system inserts them after saving. |

Mass Trigger SQL Page

Use the Mass Trigger SQL page (GP_MT_TRG_SQL) to specify which SQL objects must be executed in order to retrieve the population impacted by a mass trigger event.

Navigation:

Set Up HCM > Product Related > Global Payroll & Absence Mgmt > Triggers > Mass Trigger Definitions > Mass Trigger SQL

This example illustrates the fields and controls on the Mass Trigger SQL page.

The screenshot displays the 'Mass Trigger SQL' page. At the top, there are tabs for 'Mass Trigger Definition' and 'Mass Trigger SQL'. Below the tabs, the component name is 'BEN_PROG_DEFN' and the benefit program table is 'Benefit Program Table'. The record list shows 'Record Name BEN_DEFN_COST' and 'Benefit Opt Cost Definition'. The SQL list shows '*SQL Object ID GPUS_MT_BEN_DEFN_COST_1X' and 'GP Mass Trigger SQL'. Below this is a table for 'Bind variables (SQL Parameters)' with columns for 'Sequence number', 'Field Name', and 'Description'. The table contains five rows of parameters.

| Sequence number | Field Name | Description |
|-----------------|-----------------|-----------------|
| 1 | EFFDT | Effective Date |
| 2 | EFFDT | Effective Date |
| 3 | BENEFIT_PROGRAM | Benefit Program |
| 4 | OPTION_ID | Option ID |
| 5 | EFFDT | Effective Date |

| Field or Control | Description |
|----------------------------|---|
| SQL Object ID | Select any stand alone SQL object defined in Application Designer. These objects contain placeholders for input parameters. |
| View SQL Definition | Click to access the SQL Definition page. |
| Sequence number | Enter the number of the respective placeholders in the SQL object. |
| Field Name | Enter the fields used to fill the SQL object placeholders at runtime. Available fields prompt from the record listed above. Once saved, the system adds these fields to the Mass Trigger Definition page. |

View SQL Definition Page

Use the View SQL Definition page (GP_MT_SQLTXT_SEC) to view the SQL definition.

Navigation:

Select the **View SQL Definition** link on the Mass Trigger SQL page.

This example illustrates the fields and controls on the View SQL Definition page.

View SQL Definition

Description

GP Mass trigger SQL for record BEN_DEFN_COST in component BEN_PROG_DEFN

SQL Statement Text

```

SELECT HB.EMPLID , HB.EMPL_RCD , %DateOut(HB.EFFDT) FROM
PS_BEN_PROG_PARTIC BP , PS_HEALTH_BENEFIT HB WHERE BP.EFFDT = ( SELECT
MAX(BP1.EFFDT) FROM PS_BEN_PROG_PARTIC BP1 WHERE BP1.EMPLID =
BP.EMPLID AND BP1.EFFDT <= %DateIn(:1)) AND HB.EMPLID = BP.EMPLID AND
HB.PLAN_TYPE IN ('10','11') AND HB.EFFDT = ( SELECT MAX(HB1.EFFDT) FROM
PS_HEALTH_BENEFIT HB1 WHERE HB1.EMPLID = HB.EMPLID AND HB1.PLAN_TYPE =
HB.PLAN_TYPE AND HB1.EFFDT >= BP.EFFDT AND HB1.EFFDT <= %DateIn(:2)) AND
HB.COVERAGE_ELECT = 'E' AND EXISTS ( SELECT 'X' FROM PS_BEN_DEFN_COST
DC , PS_BEN_DEFN_OPTN OP WHERE DC.BENEFIT_PROGRAM = :3 AND
DC.BENEFIT_PROGRAM = BP.BENEFIT_PROGRAM AND DC.PLAN_TYPE IN ('10','11')
AND DC.OPTION_ID = :4 AND DC.COST_TYPE = 'P' AND DC.EFFDT = ( SELECT
MAX(DC1.EFFDT) FROM PS_BEN_DEFN_COST DC1 WHERE
DC1.BENEFIT_PROGRAM = DC.BENEFIT_PROGRAM AND DC1.PLAN_TYPE =
                
```

Use this page to view a description of the SQL statement as well view the actual SQL text.

Managing Mass Trigger Action Events

Pages Used to Process Trigger Events

| <i>Page Name</i> | <i>Definition Name</i> | <i>Usage</i> |
|--|------------------------|--|
| Mass Trigger Events Page | GP_MT_TRIGGER | View all mass trigger events listed for a component/record. Delete an event. |
| Mass Trigger Event Messages Page | GP_MT_MSG_SEC | View a message. |
| Event Message Detail Page | GP_MT_MSGLNG_SEC | View message details. |
| Field Values Page | GP_MT_TRG_VAL | View the field values valid before and after the mass trigger event. |
| Affected Employees Page | GP_MT_RESULT | View the list of employees affected by the mass trigger event. Manually expand an event. |
| Retro Triggers Page | GP_MT_RTO_TRG | View the retroactive triggers generated for a mass trigger event. |
| Iterative Triggers Page | GP_MT_ITER_TRG | View the iterative triggers generated for a mass trigger event. |
| Triggers by Calendar Group Page | GP_MT_ITER_SEC | View triggers by calendar group for a payee. |

Mass Trigger Events Page

Use the Mass Trigger Events page (GP_MT_TRIGGER) to view all mass trigger events listed for a component/record.

Delete an event.

Navigation:

Global Payroll & Absence Mgmt > Absence and Payroll Processing > Prepare Payroll > Review/Expand Mass Triggers > Mass Trigger Events

This example illustrates the fields and controls on the Mass Trigger Events page.

| Mass Trigger Events | | | | | |
|------------------------------|-------------------|--------------------|-------------------------------|--------------------------------|---------------------|
| Field Values | | Affected Employees | | Retro Triggers | |
| Iterative Triggers | | | | | |
| Component Name | | COVERAGE_GROUP_TBL | | Coverage Group Table | |
| Record Name | | COVG_GROUP_TBL | | Coverage Group - Maximum Covrg | |
| Trigger Events Launched | | | Personalize Find View All | | First 1-4 of 4 Last |
| Created | Triggering Action | Event Status | Messages | User ID | |
| 01/11/2008 11:47:52.000000AM | Change Attribute | Triggers Generated | Messages | SAMPLE | - |
| 08/23/2004 3:15:46.000000PM | New | Triggers Generated | Messages | SAMPLE | - |
| 08/16/2004 1:06:41.000000PM | New | Triggers Generated | Messages | SAMPLE | - |
| 08/14/2004 2:46:46.000000PM | Change Attribute | Triggers Generated | Messages | SAMPLE | - |

Click the **Delete** button to delete an event before processing the trigger. This action deletes the event's results tables, thus removing the field values, the list of affected employees, the retroactive triggers and the iterative triggers generated for the event. Only the users who created the trigger event can delete it.

Affected Employees Page

Use the Affected Employees page (GP_MT_RESULT) to view the list of employees affected by the mass trigger event.

Manually expand an event.

Navigation:

Global Payroll & Absence Mgmt > Absence and Payroll Processing > Prepare Payroll > Review/Expand Mass Triggers > Affected Employees

This example illustrates the fields and controls on the Affected Employees page.

| Mass Trigger Events | | | | |
|-------------------------|------|-------------------------------|------------------------------|--------------------------------|
| Field Values | | Affected Employees | | Retro Triggers |
| Iterative Triggers | | | | |
| Component Name | | COVERAGE_GROUP_TBL | | Coverage Group Table |
| Record Name | | COVG_GROUP_TBL | | Coverage Group - Maximum Covrg |
| Trigger Events Launched | | | Find View All | |
| | | | First 1 of 4 Last | |
| Created | | 01/11/2008 11:47:52.000000AM | | |
| Action | | Change Attribute | | |
| | | | Expand/Refresh Employee List | |
| Employee List | | Personalize Find View All | | First 1 of 1 Last |
| Employee ID | Name | Empl Record | As Of Date | |
| | | 0 | | |

| Field or Control | Description |
|-------------------------------------|---|
| Expand/Refresh Employee List | Select to manually expand an event. Once activated, the system deletes the current list and generates a new one. All related retroactive and iterative triggers are also deleted and regenerated. The refresh button can only be activated if none of the related triggers have been processed. Only the user who created the mass trigger event can activate it. |
| Employee ID | The system generates this list when storing the mass trigger event. |
| As of Date | The date as of which retroactive or segmentation processing occurs. |

Retro Triggers Page

Use the Retro Triggers page (GP_MT_RTO_TRG) to view the retroactive triggers generated for a mass trigger event.

Navigation:

Global Payroll & Absence Mgmt > Absence and Payroll Processing > Prepare Payroll > Review/Expand Mass Triggers > Retro Triggers

This example illustrates the fields and controls on the Retro Triggers page.

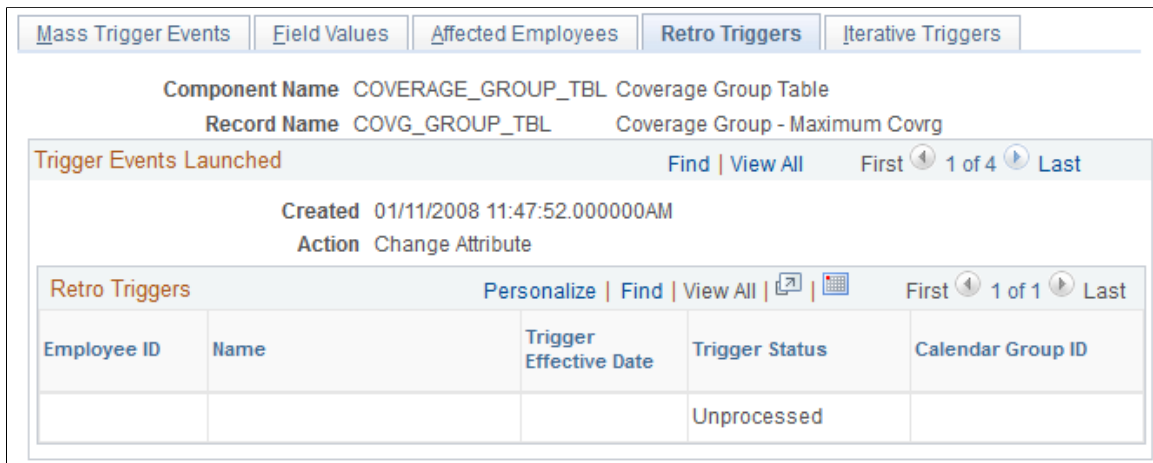

| Field or Control | Description |
|-------------------------------|---|
| Trigger Effective Date | Corresponds to the As of Date on the Affected Employees page. |
| Trigger Status | Can either be <i>Unprocessed</i> , <i>In Process</i> , <i>Processed</i> , or <i>Cancelled</i> . |

| <i>Field or Control</i> | <i>Description</i> |
|--------------------------|---|
| Calendar Group ID | This is the ID used for processing the retroactive trigger. |

Iterative Triggers Page

Use the Iterative Triggers page (GP_MT_ITER_TRG) to view the iterative triggers generated for a mass trigger event.

Navigation:

Global Payroll & Absence Mgmt > Absence and Payroll Processing > Prepare Payroll > Review/Expand Mass Triggers > Iterative Triggers

This example illustrates the fields and controls on the Iterative Triggers page.

The screenshot displays the 'Iterative Triggers' page. At the top, there are navigation tabs: 'Mass Trigger Events', 'Field Values', 'Affected Employees', 'Retro Triggers', and 'Iterative Triggers'. Below the tabs, the following information is shown:

- Component Name:** COVERAGE_GROUP_TBL Coverage Group Table
- Record Name:** COVG_GROUP_TBL Coverage Group - Maximum Covrg
- Trigger Events Launched:** Find | View All First 1 of 4 Last
- Created:** 01/11/2008 11:47:52.000000AM
- Action:** Change Attribute

The 'Iterative Triggers' section includes a table with columns 'Employee ID' and 'Name'. To the right of the table is a link 'Triggers by Calendar Group'. Below the table, there is another instance of the 'Triggers by Calendar Group' link.

When a mass trigger is expanded, an iterative trigger is generated for every affected employee and for every calendar group ID that is currently open. Click the **Triggers by Calendar Group** link to access the Calendar Groups page and view the calendar groups for which an iterative trigger has been created.

Defining Segmentation

Understanding Segmentation Setup

Segmentation refers to the process of calculating all or a subset of elements in a process list in separate slices or segments. You can *segment* calculations based on events such as changes in compensation or employee status during a calculation period. For example, if an individual changes jobs during the period and your organization separates calculations for the first job from those for the second job, you can set up the system to trigger segmentation of entitlement when there's a change to the job change action/reason field in HR.

This topic discusses:

- Types of segmentation.
- Relationship of period, segment, and slice dates.
- Basic rules of element resolution.
- Effective-dated element definitions.
- Rules for slicing accumulators and accumulator members.
- Rules for parent and child element resolutions.
- Segmentation and payee overrides.
- Proration and segmentation.
- Retroactive processing and segmentation.
- Segmentation system elements.

Types of Segmentation

This topic discusses:

- Types of segmentation.
- Selecting elements to segment.

Types of Segmentation

Absence Management offers two types of segmentation:

- Period segmentation

This type of segmentation is applicable when data that changes mid period, such as a compensation rate, requires all elements in the process list to be calculated repeatedly on either side of the change date. The system divides the period (defined by the period begin and end dates) into two or more distinct segments and treats each segment as a complete and separate set of absence calculations. It calculates each element in the process list for each segment, so a payee has multiple Payee Process Stat records. The system calculates each element using components that were effective during the different time slices.

- Element segmentation

This type of segmentation is applicable when data that changes mid period requires the affected element (and perhaps a subset of other elements) to be calculated repeatedly on either side of the change date. (Each sub period is called a *slice*.) The system segments only the elements that you select and it creates separate result rows only for the specified elements. In element segmentation, there's only one result set.

Selecting Elements to Segment

With period segmentation, the system segments all elements on the process list automatically. With element segmentation, you must specify which elements in the process list to slice. To do this, you add the elements to be segmented to an *element list* that you define using the Segmentation Event Definition page.

Related Links

[Segmentation Event Definition Page](#)

Relationship of Period, Segment, and Slice Dates

For every absence period, the system generates begin and end dates for:

- Periods

The calendar period—monthly, biweekly, or weekly—used to group and calculate a payee's absence entitlement and take. Each period has a begin and end date and can be sliced or segmented.

- Segments

A *sub period* of time in the normal period that's created due to period segmentation. Each segment represents a separate calculation of every element in the period and has begin and end dates. Individual elements can be *sliced* within a sub period.

- Slices

The span of time into which an element is segmented due to element segmentation. Unlike a segment or period, it doesn't represent a separate calculation, because it affects only a limited set of elements in a period or segment. Like a segment, a slice has begin and end dates.

All three sets of dates (period, segment, and slice) are generated every time an absence is processed, regardless of whether a period is sliced or segmented. The begin and end dates for periods, segments, and slices, are stored in the output result tables for the period and made available as system-computed elements for use in other calculations.

Example 1: Unsegmented Period

In an unsegmented period the number of periods equals the number of segments, which equals the number of slices. All three have identical begin and end dates.

This diagram illustrates the relationship between period, segment, and slice begin and end dates for an unsegmented period.

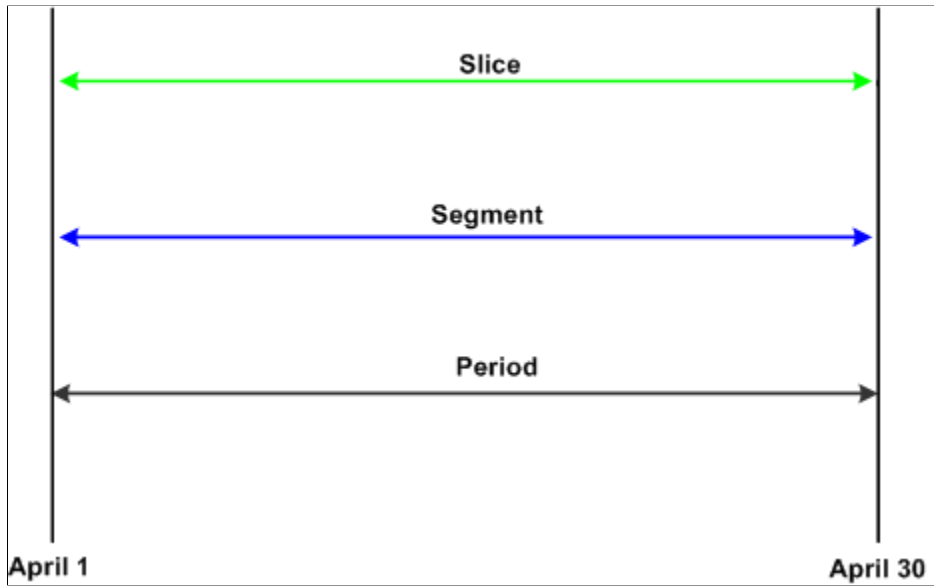

Example 2: Segmented Period

This diagram shows a period with two segments; segment 1 contains a sliced element.

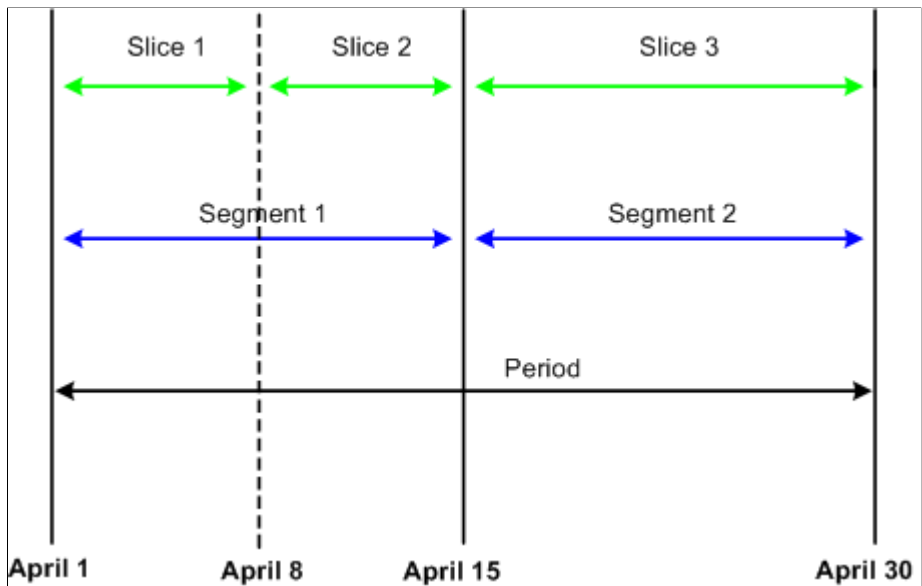

Basic Rules of Element Resolution

This topic discusses the basic rules of element resolution for period and element segmentation.

Using Period Segmentation

With using period segmentation, all elements are resolved once in each segment.

Using Element Segmentation

When using element segmentation:

- Primary elements are resolved once in each slice if they are set up to be sliced.
- Supporting elements are resolved once in each slice if they are set up to be sliced.

A supporting element is also resolved in each slice if it is a component of an element that's defined to be sliced. Suppose that an entitlement element E1 is sliced. If this element uses a duration element (a supporting element) that measures years of service, and the value of entitlement E1 is based on the years returned by the duration element, the duration element is resolved whenever E1 is resolved, because it's a component of E1.

Note: To define the elements to be sliced, use the Segmentation Event Definition page.

Example of Period Segmentation

In period segmentation, all elements are calculated once for each segment. This table lists examples of elements and the associated period segmentation rules:

| <i>Element</i> | <i>Element Type</i> | <i>Entitlement</i> | <i>Proration</i> |
|------------------|---------------------|-----------------------|------------------|
| E1 | Numeric | 10 | Yes |
| E2 | Formula | $F1 = E1 \times 10\%$ | No |
| A1 (accumulator) | $E1 + E2$ | N/A | N/A |

Assume that E1 represents vacation entitlement and the value of E1 increases from 10 to 20, triggering the segmentation of the September absence period into two equal parts. This scenario is represented in this table.

| <i>Element</i> | <i>Segment 1: September 1–September 15</i> | <i>Segment 2: September 16–September 30</i> |
|----------------|---|---|
| E1 | $10\% \times \frac{1}{2} = 5$ | $20 \times \frac{1}{2} = 10$ |
| E2 | $E1, \text{Segment 1} \times 10\% = (5 \times 10\%) = .5$ | $E1, \text{Segment 2} \times 10\% = (10 \times 10\%) = 1$ |
| A1 | Sum of E1 and E2 for Segment 1 = $(5 + .5) = 5.5$ | Sum of E1 and E2 for Segment 2 = $(10 + 1) = 11$ |

Example of Element Segmentation

When performing element segmentation, the system segments only those elements that are included in the list of elements to be segmented.

This table lists examples of elements and associated element segmentation rules:

| <i>Element</i> | <i>Element Type</i> | <i>Entitlement</i> | <i>On Element List for Segmentation?</i> | <i>Proration</i> |
|------------------|---------------------|-----------------------|--|------------------|
| E1 | Numeric | 10 | Yes | Yes |
| E2 | Formula | $F1 = E1 \times 10\%$ | No | Yes |
| A1 (accumulator) | $E1 + E2$ | N/A | N/A | No |

Assume that E1 represents vacation entitlement and the value of E1 increases from 10 to 20 on September 16, triggering the slicing of E1 into two equal parts. This scenario is represented in this table.

| <i>Element</i> | <i>Segment 1: September 1–September 15</i> | <i>Segment 2: September 16–September 30</i> |
|----------------|--|---|
| E1 | $10\% \times \frac{1}{2} = 5$ | $20 \times \frac{1}{2} = 10$ |
| E2 | Sum of E1 $\times 10\% = (5 + 10) \times 10\% = 1.5$ | |
| A1 | Sum of E1 and E2 $= (15 + 1.5) = 16.5$ | |

E1 is sliced once on September 16, resulting in two separate calculations for E1: one for each slice.

Related Links

[Segmentation Event Definition Page](#)

Effective-Dated Element Definitions

All effective-dated elements contain a **Definition as of Date** field that tells the system which effective-dated row to use when retrieving the definition of an element. Options include calendar period begin date, calendar period end date, and payment date.

The same Definition as of Date definition is used for all segments and slices within the period.

Related Links

[Understanding the Process of Selecting Definition As Of Dates](#)

Rules for Slicing Accumulators and Accumulator Members

This section describes the rules for slicing accumulators and accumulator members.

Using Period Segmentation

With period segmentation, every element and supporting element is segmented—a situation cannot exist in which an element is segmented but the accumulator to which it belongs isn't segmented.

Using Element Segmentation

The slicing of a member of an accumulator does not cause slicing of the accumulator, but the slicing of an accumulator causes all member elements to be sliced.

Rules for Parent and Child Element Resolutions

When an element is composed of (or based on) other elements, the system defines those other elements as *child* elements and the elements that are based on them as *parent* elements. Elements and supporting elements can be parents or children.

Say variable A is a percentage of entitlement E1 and entitlement E2 (variable $A = 10\% \times (E1 + E2)$). In this example, variable A is the parent and entitlement E1 and entitlement E2 are the children. The concept of *child* and *parent* elements is central to understanding how an element that's based on other elements is resolved.

Matching and Mismatching Slices and Segments

During period segmentation, all elements are segmented equally, and parent and child elements always match.

During element segmentation, parent and child elements can be sliced equally, or one may be sliced more than the other. For example, the parent might be included in the list of elements to segment, while the child is not. If the parent and child slices are identical, the parent and child are said to match; if they are not identical, they are referred to as mismatching.

Absence Management follows specific rules for processing matching and mismatching elements. These rules are illustrated in the following examples.

Examples 1–7: Parent Element Is a Primary Element or a Supporting Element

The following cases use these elements:

- Entitlement E1 = Percent of F1 (supporting element).
- Entitlement E3 = Percent of E2 (primary element).
- F1 = 100 (supporting element).
- E2 = 100 (primary element).

This table summarizes the examples that follow in this topic. The child and parent slices in these examples do not always match, as indicated in the Match/No Match column.

| Case Number | Parent Action | Child Action | Child Type | Match/No Match | Process Rule |
|--------------------|----------------------|---------------------|-------------------------|---|--|
| 1 | Sliced | Not Sliced | Primary Element (E2) | No Match | <i>Use</i> the value of the child for each slice of the parent. |
| 2 | Sliced | Sliced | Primary Element (E2) | Match | <i>Use</i> the slice value of the child for each slice of the parent. |
| 3 | Sliced | Sliced | Primary Element (E2) | Partial Match Child Sliced More | <i>Sum</i> the value for each child slice that matches the parent slice. |
| 4 | Sliced | Sliced | Primary Element (E2) | Partial Match Child Sliced Less | <i>Use</i> the Slice value of the child where dates match. If they don't match, <i>sum</i> the value of all child slices. May return incorrect values. |
| 5 | Sliced | Sliced | Primary Element (E2) | No Match | <i>Sum</i> the value of all child slices. May return incorrect values. |
| 6 | Not Sliced | Sliced | Primary Element (E2) | No Match | <i>Sum</i> of the child values. |
| 7 | Sliced | Not Sliced | Supporting Element (F1) | Not applicable. Matching does not matter when the child is a supporting element. | <i>Resolve</i> the value of the child for each slice of the parent. (See note following case details.) |

Note: The following examples show the results with and without proration. Prorated amounts are in parentheses.

Case 1

Assumptions:

E2 (primary element) = 100

E3 (primary element) = 10% of E2

Proration on E3

Scenario: Parent is sliced; child is not sliced. Child is a primary element.

| Element | Slice 1 Results | Slice 2 Results |
|----------------|-----------------------------------|-----------------------------------|
| E3 (parent) | <i>Slice 1</i> 10% of 100 (50) | <i>Slice 2</i> 10% of 100 (50) |
| E2 (child) | <i>Slice 1</i> 100 | |

Each slice of E3 uses the full value of the child (E2). This causes a warning message to be displayed in the Payee Messages component.

Case 2

Assumptions:

E2 (primary element) = 100

E3 (primary element) = 10% of E2

Proration on E2

Scenario: Parent is sliced; child is sliced. Child is a primary element.

| Element | Slice 1 Results | Slice 2 Results |
|----------------|-----------------------------------|-----------------------------------|
| E3 (parent) | <i>Slice 1</i> 10% of 100 (50) | <i>Slice 2</i> 10% of 100 (50) |
| E2 (child) | <i>Slice 1</i> 100 (50) | <i>Slice 2</i> 100 (50) |

When the parent's slice dates equal the child's slice dates, the parent uses the child's value. Although the slice dates match, without proration on the child, the results may be incorrect.

Case 3

Assumptions:

E2 (primary element) = 100

E3 (primary element) = 10% of E2

Proration on E2

Scenario: Parent is sliced; child is sliced more. Slices partially match. Child is a primary element.

| Element | Slice 1 | Slice 2 | Slice 3 |
|----------------|--------------------------------------|--|-------------------------------|
| E3 (parent) | <i>Slice 1</i> 10% of 100 (33.33) | <i>Slice 2</i> 10% of 200 (33.33 + 33.34) | |
| E2 (child) | <i>Slice 1</i> 100 (33.33) | <i>Slice 2</i> 100 (33.33) | <i>Slice 3</i> 100 (33.33) |

Slice 1 of the parent and child match, so the system sums the child slices (slice 1, in this example). For the second slice of E3 (the parent), the system sums slice 2 and slice 3 of E2 (the child), because the begin date of slice 2 and end date of slice 3 match slice 2 of E3 (the parent). This scenario causes a warning message to be displayed in the Payee Messages component.

Case 4

Assumptions:

E2 (primary element) = 100

E3 (primary element) = 10% of E2

Proration on E2

Scenario: Parent is sliced; child is sliced less. Slices partially match. Child is a primary element.

| Element | Slice 1 Results | Slice 2 Results | Slice 3 Results |
|----------------|--------------------------------------|--------------------------------------|--------------------------------------|
| E3 (parent) | <i>Slice 1</i> 10% of 100 (33.33) | <i>Slice 2</i> 10% of 200 (66.67) | <i>Slice 3</i> 10% of 200 (66.67) |
| E2 (child) | <i>Slice 1</i> 100 (33.33) | <i>Slice 2</i> 100 (66.67) | |

Generally, if the child is a primary element, it should be on the same list of elements to be sliced as the parent element. This ensures that both the child and parent have matching slices. Otherwise, the above scenario could occur and should be avoided.

The resolution is twofold. When there are exact matches (as in slice 1 of the parent and the child), the system uses the child's value. If the parent or the child has proration turned on, the result is correct. The second resolution of the parent sums all resolutions of the child (200, in this example), resulting in an over calculated amount. This is because the system cannot get a match on the slice dates for the parent and the child. Even with proration turned on, the amount of the child is overstated (see the amounts in parentheses).

Case 5

Assumptions:

E2 (primary element) = 100

E3 (primary element) = 10% of E2

Proration on E2

Parent is sliced. Child is sliced. No match on slice dates. Child is a primary element.

| <i>Element</i> | <i>Slice 1 Results</i> | <i>Slice 2 Results</i> | <i>Slice 3 Results</i> |
|-----------------------|------------------------------------|------------------------------------|-------------------------------|
| E3 (parent) | <i>Slice 1</i> 10% of 300 (100) | <i>Slice 2</i> 10% of 300 (100) | |
| E2 (child) | <i>Slice 1</i> 300 (100) | <i>Slice 2</i> 300 (100) | <i>Slice 3</i> 300 (100) |

Generally, if the child is a primary element, it should be on the same list of elements to be sliced as the parent element. This ensures that both the child and parent have matching slices. Otherwise, the above scenario could occur and should be avoided.

When the parent's slice dates do not match any of the child's slice dates—as in the second resolution in Case 5—the system sums the value of all child slices for each resolution of the parent. This causes a warning message to be displayed in the Payee Messages component.

Case 6

Assumptions:

E2 (primary element) = 100

E3 (primary element) = 10% of E2

Proration on E2

Parent is not sliced. Child is sliced. No match on slice dates. (Slice dates are not applicable to the parent.)
Child is a primary element.

| Element | Slice 1 Results | Slice 2 Results |
|----------------|------------------------------------|-----------------------------|
| E3 (parent) | <i>Slice 1</i> 10% of 200 (100) | |
| E2 (child) | <i>Slice 1</i> 200 (100) | <i>Slice 2</i> 200 (100) |

When the parent isn't sliced, and the child is—and the child is a primary element—the resolution of the parent element sums the values of all resolutions of the child. This causes a warning message to be displayed in the Payee Messages component.

Case 7

Assumptions:

E1 (primary element) = 10% of F1

F1 (supporting element) = 100

Proration on E1

Parent is sliced. Child is not sliced. Child is a supporting element.

| Element | Slice 1 Results | Slice 2 Results |
|----------------|-----------------------------------|-----------------------------------|
| E1 (parent) | <i>Slice 1</i> 10% of 100 (50) | <i>Slice 2</i> 10% of 100 (50) |
| F1 (child) | <i>Slice 1</i> 100 | <i>Slice 2</i> 100 |

Slice 1 of E1 resolves the child for the slice 1 time period. F1 is sliced because, as a supporting element child, it will resolve for each parent's slice.

Note: If a supporting element is populated through an array, bracket, or a formula, then that array, bracket or formula element must be on the same list of elements to slice as the parent. (Define the list of elements to slice using the Element List grid on the Segmentation Event Definition page described in this documentation.)

System Generated Warning Messages

During the absence calculation, the system issues a warning message in the following situations if the child element is a primary element and its slice dates don't match the parent's slice dates:

- Parent is sliced. Child isn't sliced (see Case 1).
- Parent is sliced. Child is sliced. The slice dates of the parent don't match the slice dates of the child (see Cases 3, 4, and 5).
- Parent isn't sliced. Child is sliced (see Case 6).

If the child element is an accumulator, a warning message is issued whenever the accumulator's slice dates don't match the parent's slice date.

Messages are displayed in the Payee Messages component.

Segmentation and Payee Overrides

You can define two types of overrides at the payee level:

- Primary element overrides.
- Supporting element overrides.

Both types of overrides are called *payee level* overrides, and the system follows the same basic rules for applying these overrides to segmented and unsegmented periods. Generally, when an absence period has period or element segmentation, payee overrides are applied to a segment based on the segment end date and the end date of the override, following the rules below. The rules are the same for primary and supporting element overrides at the payee level; only primary element overrides are discussed here. Any minor differences in these two types of overrides are clarified in the following examples.

The rules for applying overrides at the payee level are:

- Primary element overrides apply to absence entitlement and absence take elements, and the overrides must have begin dates. End dates are not required.

Supporting element overrides apply to elements such as variables, formulas, arrays, and brackets.

- If an override is to apply to a segment, the end date of the override must equal or be greater (or blank) than the end date of the segment (see Overrides 3 and 4 in the diagram that follows).
- An override can apply to more than one segment if the end date of the override is greater than one segment's end date and greater than or equal to the subsequent segment's end date (or blank) (see Override 3 in the diagram that follows).
- If the end date of the override is less than the end date of the segment, the override doesn't apply to that segment (see Overrides 1 and 2 in the diagram that follows).
- Primary element overrides are prorated if the element is defined to be prorated.

With supporting element overrides, the supporting element is prorated if it's a component of an element that's defined to be prorated and that element is segmented.

- Payee overrides must be active as of the segment end date.

This diagram shows an example of a primary element override.

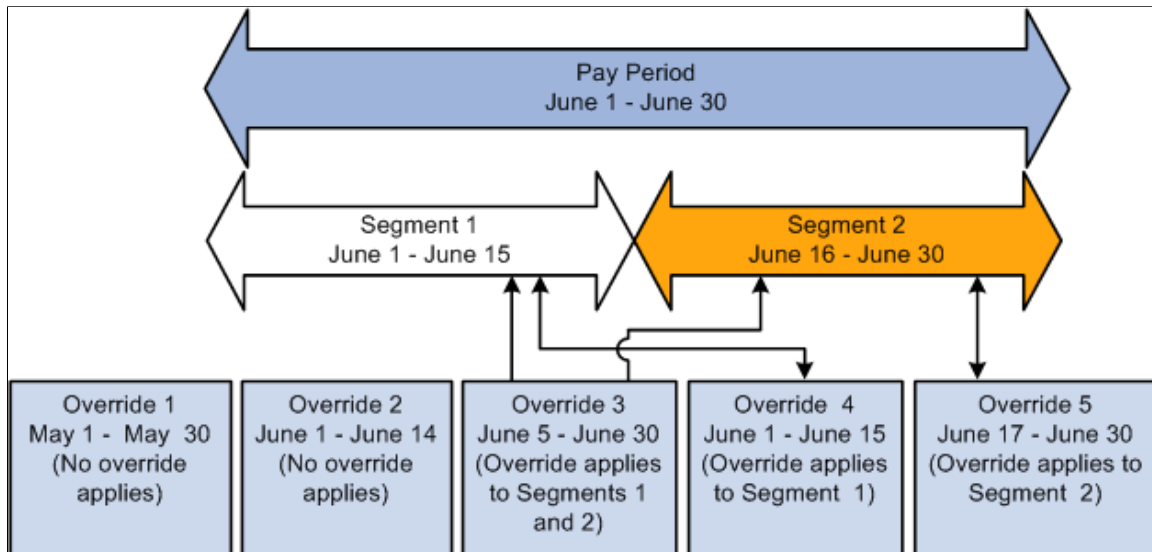

- Overrides 1 and 2 apply to neither segment, because their end dates come before the end dates of Segments 1 and 2.
- Override 3 applies to Segments 1 and 2 equally, because its end date is greater than the first segment's end date and greater than or equal to the second segment's end date.
- Override 4 applies to Segment 1 because its end date is greater than or equal to the end date of Segment 1 and less than the end date of Segment 2.
- Override 5 applies to Segment 2, because its end date is equal to the end date of Segment 2 and its begin date is after the end date of Segment 1.

The following examples offer a more detailed view of how payee overrides are applied to segmented and unsegmented periods:

Scenario: Two payees are eligible to receive entitlement (E1) whose value is 10. Assume that Payee 1 has no segmentation and that Payee 2 has period segmentation in the January period. The segment dates for Payee 2 are January 1, 2005–January 15, 2005 and January 16, 2005 – January 31, 2005. The payees have identical supporting element overrides, and the period being processed is January 1, 2005 – January 31, 2005. This table lists cases that show how the system applies primary element overrides:

Note: In this example, override is abbreviated *Over*.

| Case | Over. Begin Dt | Over. End Dt | Over. Value | Payee 1 Results | Payee 2 Results | Reasons |
|------|----------------|---------------|-------------|-----------------|-----------------|--|
| 1 | Jan. 1, 2000 | Dec. 31, 2004 | 20 | 10 | 10 | End date is less than period/segment end date. |

| Case | Over. Begin Dt | Over. End Dt | Over. Value | Payee 1 Results | Payee 2 Results | Reasons |
|-------------|-----------------------|---------------------|--------------------|------------------------|------------------------|--|
| 2 | Jan. 1, 2000 | Jan. 5, 2005 | 20 | 10 | 10 | End date is less than period/segment end date. |
| 3 | Jan. 1, 2005 | Jan. 5, 2005 | 20 | 10 | 10 | End date is less than period/segment end date. |
| 5 | Jan. 5, 2005 | Jan. 20, 2005 | 20 | 10 | S1=20 S2=10 | For Payee 2, Segment 1 uses the override because the end date is greater than Segment 1's end date. |
| 6 | Jan. 20, 2005 | Jan. 25, 2005 | 20 | 10 | 10 | The override's begin date is greater than Segment 1's end date and its end date is less than Segment 2's end date, so the override doesn't apply to either segment of Payee 2. For Payee 1, the override's end date is less than the end date of the period, so no override applies. |
| 7 | Jan. 5, 2005 | Jan. 31, 2005 | 20 | 20 | S1=20 S2=20 | The override's begin date is before the end date of Segment 1, and its end date is greater than or equal to the end dates of both segments, so it applies to both segments. |

| Case | Over. Begin Dt | Over. End Dt | Over. Value | Payee 1 Results | Payee 2 Results | Reasons |
|-------------|-----------------------|---------------------|--------------------|------------------------|------------------------|--|
| 8 | Jan. 20, 2005 | Feb. 1, 2005 | 20 | 20 | S1=10 S2=20 | For Payee 2, Segment 1 doesn't use the override, because the override's begin date is greater than Segment 1's end date. |

Note: Although these examples refer to period segmentation, the same basic rules apply to element segmentation: if a sliced element is overridden at the payee level, the override applies to the slices just as it applies to segments with period segmentation.

Related Links

[Understanding Overrides](#)

Proration and Segmentation

When you set up the Absence Management system up to segment absence entitlement elements in an absence run, you can also instruct the system to generate prorated calculation results for these elements based on such factors as the number of work hours or days in each slice/segment relative to the total number of work hours or days in the absence period. To do this, you must associate each absence entitlement element you want to prorate with a proration rule on the element definition pages. Then, when segmentation or slicing occurs, the element automatically calls the appropriate proration factor.

This topic discusses:

- Segmentation with proration
- Segmentation without proration

Segmentation with Proration

To have the system prorate a segmented, frequency-based entitlement element, specify proration as part of the element's definition.

You must define the proration rule to use in segmentation processing, because the rule is not hard-coded. Generally, a proration rule that you define consists of a numerator, representing the slice or segment, and a denominator, representing the entire calendar period.

You can determine how to define the numerator and denominator that constitute the proration factor. The numerator and denominator can be any of these elements:

- Accumulator
- Count

- Duration
- Formula
- Variable

Note: When you define a proration element, the **Always Recalculate** check box on the Proration Name page is automatically selected. This is to ensure that the system correctly calculates the proration factor when there is element segmentation.

Segmentation without Proration

To apply segmentation without proration, select the *No Proration* option on the Rounding/Proration page of the Absence Entitlement component.

Retroactive Processing and Segmentation

When a retroactive trigger is generated in response to an event, the system writes the effective date of the change to trigger tables in Absence Management. The system uses this date to determine how far back in time to recalculate closed periods, using this logic:

- Without backward limits, the system takes the effective date of the change that triggers retroactive processing, returns to the first calendar period in which the effective date falls, and calculates the entire period and everything going forward.
- If the effective date of the retroactive change falls mid period, the system doesn't automatically segment the period or use proration when recalculating original absence items (because it tries to recalculate the *entire* period).
- Segmentation triggers remain active and available to the system because they may be needed for future retroactive processing.

Related Links

[Setting Backward and Forward Retro Limits](#)

[Trigger Table Data](#)

[Understanding Retroactive Processing](#)

Segmentation System Elements

This table lists the system elements that are delivered for segmentation:

| System Element | Description |
|-----------------------|---|
| FIRST ACT SEGMENT | First Active Segment (Y/N) Indicates whether the segment that is being processed is the first <i>active</i> segment within the calendar period. |
| FIRST SEGMENT | First Segment (Y/N) Indicates whether the segment that is being processed is the first segment within the calendar period. |

| System Element | Description |
|-----------------------|---|
| LAST ACT SEGMENT | Last Active Segment (Y/N) Indicates whether the segment that is being processed is the last <i>active</i> segment within the calendar period. |
| LAST SEGMENT | Last Segment (Y/N) Indicates whether the segment that is being processed is the last segment within the calendar period. |
| SEGMENTATION-PRD | SEGMENTATION-PRD indicates whether the segment being processed is the same as the calendar period (it indicates whether period segmentation has occurred) by returning the following values: 1 (true) if the segment being processed <i>does not</i> match the calendar period and 0 (false) if this segment <i>does</i> match the calendar period. |
| SEGMENTATION-ELEM | SEGMENTATION-ELEM indicates whether the slice being processed is the same as the calendar period (it indicates whether element segmentation has occurred) by returning the following values: 1 (true) if the slice being processed <i>does not</i> match the calendar period and 0 (false) if this slice <i>does</i> match the calendar period. |

Setting Up Segmentation

Pages Used to Set Up Segmentation

| Page Name | Definition Name | Usage |
|--|------------------------|---|
| Segmentation Event Definition Page | GP_SEG_EVENT | Define segmentation events, specify a segmentation type, and select individual elements for segmentation. |
| Trigger Definitions Page | GP_TRGR_SETUP | Define triggers. |

Understanding Segmentation

To set up segmentation:

1. Define an event ID and segmentation type on the Segmentation Event Definition page.

Segmentation can be caused by events such as pay group transfers, pay entity transfers, and new hires. The system does not automatically know what type of segmentation (period or element) to apply to an event. When you create an event ID, you specify:

- The type of segmentation to use.

- The elements to slice (for element segmentation only).
2. Define the records or record-field combinations that trigger segmentation in response to data changes on the Trigger Definition page, and link them to the event ID defined in step 1 (above).

These records and fields become *trigger records* or *trigger fields* which trigger segmentation in response to changes in payee data. By attaching an event ID to a field, you tell the system what type of segmentation to use when a segmentation event occurs.

Related Links

[Understanding Triggers](#)
[Segmentation Page](#)

Segmentation Event Definition Page

Use the Segmentation Event Definition page (GP_SEG_EVENT) to define segmentation events, specify a segmentation type, and select individual elements for segmentation.

Navigation:

Set Up HCM > Product Related > Global Payroll & Absence Mgmt > Triggers > Segmentation Event Definitions > Segmentation Event Definition

This example illustrates the fields and controls on the Segmentation Event Definition page.

Segmentation Event Definitions

Country ESP Spain

Trigger Event ID RISK_CODE

*Description Short Description

*Segment Type Element ▼

Effective Date Find | View All First 1 of 1 Last

*Effective Date *Status Active ▼ + -

| Element List | | Personalize Find View All | First 1-5 of 11 Last |
|--------------|--|--------------------------------|----------------------|
| *Entry Type | Element Name | Description | |
| Formula ▼ | <input type="text" value="GEN FM SEGMNTCN"/> | Resolve elements not segmented | + - |
| Seg. Accm ▼ | <input type="text" value="GEN AC SEG COMP"/> | Compensation slicing | + - |
| Seg. Accm ▼ | <input type="text" value="GEN AC SEG CP"/> | Prof. contingencies slicing | + - |
| Seg. Accm ▼ | <input type="text" value="GEN AC SEG AUS"/> | Absences slicing | + - |
| Seg. Accm ▼ | <input type="text" value="GEN AC SEG CC"/> | Common contingencies slicing | + - |

| Field or Control | Description |
|-------------------------|---|
| Country | Displays the country that uses the trigger event ID defined on this page. Event IDs are defined by country because one country (or organization in a country) might decide to process an event by segmenting one subset of elements (in the case of element segmentation), whereas another might decide to process the same event by segmenting a different subset of elements. Or one country might use period segmentation while another uses element segmentation to process the same event. |
| Trigger Event ID | Displays the trigger event ID that you entered to access this page. This ID tells the system which segmentation type to use to process segmentation events and which elements to segment if you use element segmentation. |
| Segment Type | Select a segment type. Options are <i>Period</i> and <i>Element</i> . See Types of Segmentation . |
| Effective Date | Enter the effective date of the trigger event ID. You can enter multiple effective-dated rows for each trigger event ID if the trigger event definition changes. |
| Status | Select the status of the trigger event ID. Options are <i>Active</i> and <i>Inactive</i> . |

Element List

If you use element segmentation to process an event, you must specify which elements in the process list should be sliced, because element segmentation affects only a limited set of elements. Enter the elements to be segmented in the **Element List** group box.

| Field or Control | Description |
|-------------------------|--|
| Entry Type | Select the type of element to segment. Options are: <i>Abs Entitl</i> (absence entitlement), <i>Array</i> , <i>Bracket</i> , <i>Date</i> , <i>Formula</i> , <i>Seg Accm</i> (segment accumulator), and <i>WritArray</i> (writable array). <hr/> Note: <i>Earnings</i> and <i>Deduction</i> are used by Global Payroll only. <hr/> Only segment accumulators are available for segmentation. |
| Element Name | Select the element name. |

Related Links

- [Understanding Retroactive Processing](#)
- [Setting Backward and Forward Retro Limits](#)
- [Trigger Table Data](#)

Trigger Definitions Page

Use the Trigger Definitions page (GP_TRGR_SETUP) to define triggers.

Navigation:

Set Up HCM > Product Related > Global Payroll & Absence Mgmt > Triggers > Trigger Definitions > Trigger Definitions

On this page you define the records or record-field combinations that trigger segmentation, and link them to an event ID.

Note: The Trigger Definition page is also used to define iterative and retroactive triggers.

Related Links

- [Setting Up Trigger Definitions](#)

Managing Segmentation

Trigger data is generated automatically by the online system based on the conditions that you specify during setup. After the online system generates segmentation triggers, use the Review Triggers - Segmentation page to manage those triggers so that segmentation occurs only when you want it to—and only in response to appropriate changes in system data.

Page Used to Manage Segmentation

| <i>Page Name</i> | <i>Definition Name</i> | <i>Usage</i> |
|-----------------------------------|------------------------|--|
| Segmentation Page | GP_TRIGGER_SEG | View, add, or cancel segmentation triggers by payee. A segmentation trigger must be active to be viewed or managed on this page. |

Segmentation Page

Use the Segmentation page (GP_TRIGGER_SEG) to view, add, or cancel segmentation triggers by payee.

A segmentation trigger must be active to be viewed or managed on this page.

Navigation:

Global Payroll & Absence Mgmt > Absence and Payroll Processing > Prepare Payroll > Review Triggers > Segmentation

Use this page to view segmentation triggers for each employee ID/employee record combination. You can also manually add and cancel trigger rows through this page.

Related Links

[Setting Up Trigger Definitions](#)

Defining Retroactive Processing

Understanding Retroactive Processing

Retroactive (retro) processing refers to the recalculation of prior periods due to changes in payee data that could result in adjustments to entitlement or compensation.

Absence Management uses a form of retroactive processing referred to as *corrective retro*. With corrective retro, the system:

1. Recalculates the elements of the absence run that are defined to be recalculated during retroactive processing.
2. Replaces the previous calculations with the recalculated values for the elements of the run.
3. Updates balance and segment accumulators in the recalculated period.
4. Executes a full reversal of the prior calculation results.

The recalculated run replaces the previously calculated run. However, the original run calculations remain available for auditing and reporting purposes.

Common Elements Used for Retroactive Processing

This section defines some of the key terms used to describe retroactivity in this documentation.

Prior Results and Recalculated Results

When retroactive processing occurs for a previously calculated period, new results are created for that period. The new results are called the *recalculated results*. The results from the previously calculated period are called the *prior results*.

Recalc Period

A period that has been previously calculated and is being recalculated due to retroactivity.

Retro Deltas

When retroactive processing occurs for a given payee, the system recalculates each element generated for the payee. The system compares the recalculated results to the prior results. The difference between these results is typically called the *retro delta*. A retro delta represents an increase or a decrease that results in an adjustment to the payee's calculations.

Note: Retro Deltas are not applicable to Absence Management.

Retro on Retro

When a period that has already been processed for retroactivity is processed again due to additional retroactive data changes, the recalculation is called *retro on retro*.

Version and Revision Numbers

In the following sections you will see numerous references to version and revision numbers. Absence Management tags each Payee Process Stat record with a version and revision number. The version number is the vehicle for tracking recalculation of a calendar period due to retroactivity.

The system defines the original set of output results for a calendar calculation as Version 1, Revision 1 (V1R1). Each subsequent recalculation of the calendar increases the version number while the revision number stays at one. For example, the first retro would be Version 2, Revision 1 (V2R1). The second retro would be Version 3, Revision 1 (V3R1), and so forth. Version numbers are updated during corrective retro processing, for example, in absence calendars. Revision numbers are updated during forwarding retro processing. (This does not occur in Absence Management.)

Related Links

[Tracking Recalculated Calendars](#)

Understanding General Rules of Retro Processing

This topic provides an example of a retroactive calculation and discusses how Absence Management:

- Tracks recalculated calendars.
- Loads balance accumulators.
- Stores recalculated results.
- Set backward and forward limits.

Example: Corrective Retro—No Exceptions

In this example, Earning 1 rate changes from 100 to 120; effective date is in period 1; notified in period 2:

| Recalc Option | Calendar Period 1 | Prior Results (Old Value) | Re-Calculation (New Value) | Deltas | Corrective Replace Old Value with New Value | Forward Y/N |
|----------------------|---------------------------|----------------------------------|-----------------------------------|---------------|--|--------------------|
| Always | Earning 1 | 100 | 120 | 20 | Y | N |
| Always | Deduction 1 (flat amount) | 30 | 30 | 0 | Y | N |

This table shows the processing results for the example above:

| Calendar Period 2 | Current Results | Retro Adjustment |
|---------------------------|------------------------|-------------------------|
| Earning 1 | 120 | None |
| Deduction 1 (flat amount) | 30 | None |

In this example, only Earning 1 generates a retro delta. The new value of Earning 1 replaces its old value.

Tracking Recalculated Calendars

Absence Management tags each Payee Process Stat Record with a version number to track the recalculation of a calendar period due to retroactivity.

The system defines the original set of output results for a calendar calculation as Version 1, Revision 1 (V1R1). Each subsequent recalculation increments the version number by 1. The revision number stays the same. For example, the first corrective retro is Version 2, Revision 1 (V2R1). The second corrective retro (retro on retro) is Version 3, Revision 1 (V3R1), and so forth.

The system uses these numbers to determine which calculations to use as the *old* and *new* values when processing retro deltas.

Version and Revision Numbers in Retro Adds

A retro add is a situation in which a previous calculation does not exist for a payee, and retroactivity calls for a payee process status record to be created for the first time. For example, suppose that a payee initially thought to have been hired in February was actually hired in January. There are no calculations for January, so when January is processed for retro, the system must create a payee process status record for the period and assign version and revision numbers to it. In this case, the first calculation is labeled V1R1. The reason is that corrective retro replaces the results of the prior calculation (it does not use them only to create retro deltas), so when a period is added, it treats this period as if it were the original one.

The following tables illustrate how the system numbers payee process status records in retro add situations:

Scenario:

In the following retro add situation, it is discovered that a payee who was calculated as part of period 1 should not have been processed in that period. The calculations for the payee are therefore reversed in Recalc No. 2. When it is later discovered that the payee belongs in that period after all, the system produces a new calculation using the version and revision numbers that are indicated in Recalc No. 3.

| Period/Recalculation | Numbering |
|---------------------------------|------------------|
| Period 1 (original calculation) | V1R1 |
| Recalc No. 1 | V2R1 |
| Recalc No. 2 (reversal) | V3R1 |

| <i>Period/Recalculation</i> | <i>Numbering</i> |
|-----------------------------|------------------|
| Recalc No. 3 (add) | V4R1 |

In each example, all calculations for the payee are reversed in Recalc No. 2 when the payee is eliminated from the calendar. When the payee is later restored (when it is discovered that he or she belongs in the original calendar), new calculations are created. The new calculation uses the numbering that is indicated in Recalc No. 3.

Related Links

[Retroactive Adds](#)

[Retroactive Deletes](#)

Loading Balance Accumulators

Before the system recalculates elements during retro, it loads balances to produce the correct value for the balance accumulators.

The system loads the balance for the element from the calculation with the highest version number in the previous period.

Storing Recalculated Results

When a trigger starts retroactive processing for a payee, the system recalculates each calculation that is generated for the payee from the date of retroactivity forward. The system compares the recalculated results to the original results. If there is a difference between them, the system:

1. Stores prior results for auditing purposes.
2. Replaces the prior results with new ones in the recalculated period and stores the new calculation results for each payee.

These results represent the true results for that period.

Setting Backward and Forward Retro Limits

In Absence Management, you use the Pay Entity Retro Limits page to establish default backward and forward limits for retro processing. These defaults tell the system how far back in time to go to recalculate closed calendars that are associated with a pay entity, and how long after a payee becomes inactive he/she is eligible for retro processing.

To determine how far back in time to go to process retroactivity, the system compares the backward limit defined on the Pay Entity Retro Limits page to the following system dates:

- Trigger Effective Date.

This date—the effective date of the change that triggers retroactive processing—establishes a theoretical goal for how far back in time to go to recalculate data. When the system determines which periods to process, the backward limit date takes precedence over the trigger effective date. For

example, if the trigger effective date is January 1, 1990, and the backward limit date is January 1, 1995, the backward limit date stops all calculations prior to (and including) that date. By contrast, if the backward limit date is January 1, 1990, and the trigger effective date is January 1, 1995, then the trigger effective date establishes the number of periods to recalculate.

- No Retro Processing Before Date.

This is the date that a payee enters the Absence Management system. This date takes precedence over the trigger effective date and the backward limit date because no matter what these dates are, there is no historical data to recalculate before the **No Retro Processing Before Date**.

This diagram illustrates the interaction of the dates used to determine the number of past periods to recalculate.

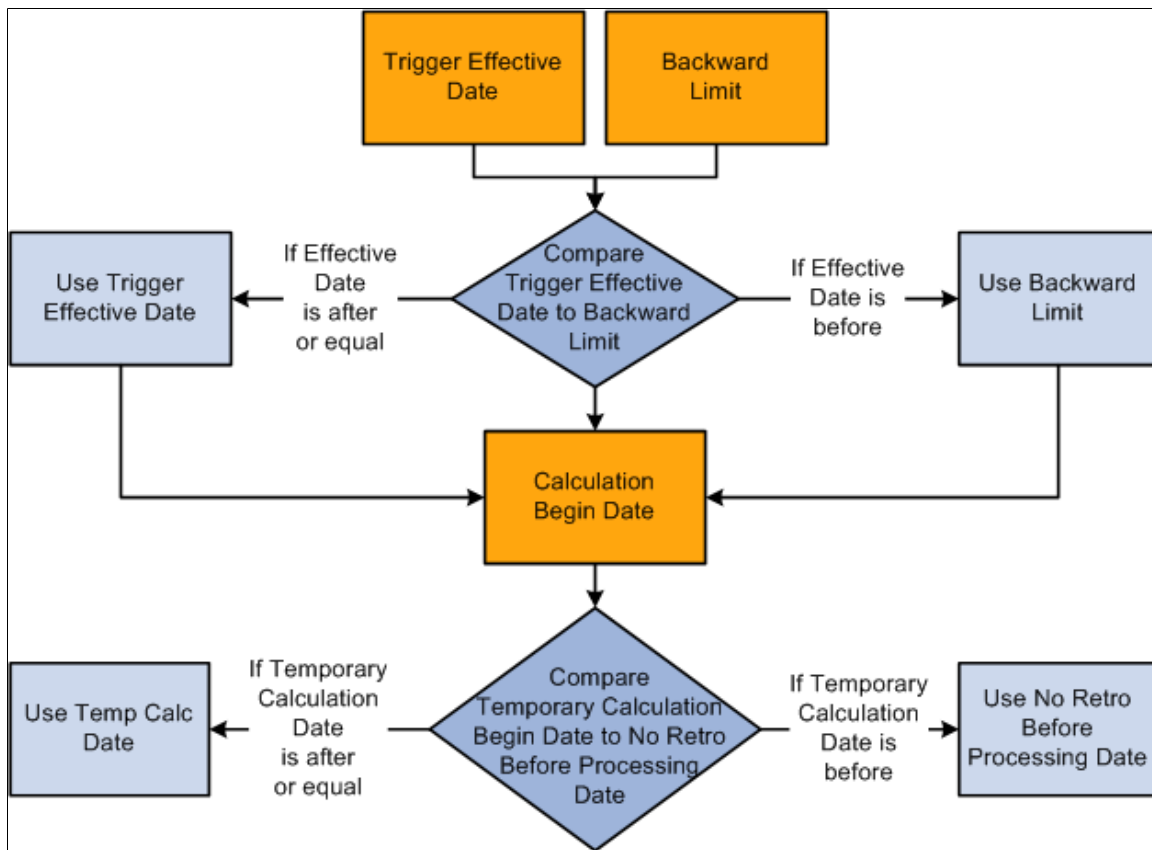

The Absence Management system determines the first recalculation period by comparing the trigger effective date to the backward limit date and comparing both dates to the calculation begin date.

The process for determining forward limits is less complex than for backward limits, because the system does not compare trigger effective dates to either the forward limit or the **No Retro Processing Before Date**. It only needs to determine whether payees are within the forward limits defined on the Pay Entity Retro Limits page. If a payee is within these limits, the system applies the backward limits to determine the number of past periods to recalculate.

For forward limits to apply, a payee must be inactive in all jobs (EMPL_STATUS on the Job record is used to validate the payee's status). A payee is considered inactive if the EMPL_STATUS value is *D* (deceased), *R* (retired), *T* (terminated), *V* (terminated pension payout), or *X* (retired-pension administration). If a payee has multiple jobs, the highest effective date of all rows that are returned is used as the inactive date.

Setting Up Retroactive Processing

To set up retroactive processing, use the Countries (GP_COUNTRY) and the Retro Process Definitions (GP_RTO_PRC_DEFN) components.

Pages Used to Set Up Retroactive Processing

| <i>Page Name</i> | <i>Definition Name</i> | <i>Usage</i> |
|---------------------------|------------------------|---|
| Countries | GP_COUNTRY | Define the retro method at the country level. |
| Retro Process Definitions | GP_RTO_PRC_DEFN | Define a retro process. |
| Retro Event Definition | GP_RTO_EVT | Associate a triggering event (a change in critical data) with one of the processes that you defined on the Retro Process Definition page. |
| Retro Limits | GP_PYENT_RETRO | Define the backward and forward limits for retro processing at the pay entity level. |
| Retro Limits Assignment | GP_PYE_RTO_LIM | Override, at the payee level, the backward and forward limits for retro processing that you established at the pay entity level on the Retro Limits page. |

Related Links

[Additional Pages Affecting Retroactive Processing](#)

Understanding Retroactive Processing Setup

Follow these steps to set up retroactive processing:

1. Specify the retroactivity defaults.

Using the Countries page, select the corrective method for processing retroactivity. (Forwarding retro applies only to Global Payroll.)

See [Countries Page](#).

2. Define a retro process.

Once you have selected a default method for the country, define a retro process on the Retro Process Definition page.

3. Map retro processes to trigger event IDs.

Use the Retro Event Definition page to associate the retro process you defined in step 2 with a trigger event ID. This event ID tells the system how to process data changes to the records or fields you make sensitive to retroactive data changes in step 4 (see below).

4. Define trigger records and fields.

After mapping retro processes to event IDs, you must decide which database records and fields will trigger retroactive processing in response to data changes. You identify these fields and records on the Trigger Definitions component (GP_TRGR_SETUP) and link them to one of the trigger event IDs that you defined in Step 3. Because trigger event IDs identify retro process definitions, any field or record that is linked to this ID triggers the correct process in response to a data change.

5. Determine which pay entities allow retroactive processing.

Use the Pay Entity Retro Limits page to enable retroactive processing of calendars in a pay entity.

6. Specify backward and forward limits.

There are two pages on which you can set backward and forward limits:

- Use the Pay Entity Retro Limits page to establish default backward and forward limits for retro processing (optional). This tells the system how far back in time to go to recalculate closed calendars that are associated with a pay entity, and how long after a payee becomes inactive he/she is eligible for retro processing.
- If necessary, override the default backward and forward limits for specific payees using the Retro Limits Assignment page.

7. View, add, and cancel retro triggers.

After the online system generates retro triggers, use the Payee Triggers - Retro page to manage retro events so that retroactive processing takes place only in response to the appropriate changes in system data. This page enables you to view retro triggers for each payee; you can also add and cancel triggers on this page.

Note: Retro trigger data is generated by the online system based on conditions that you specify during setup. You can also manually enter retro trigger rows that were not created automatically.

Warning! Canceling a trigger does not undo the database change that created the trigger in the first place. If there is retro for some other reason, this change may be picked up when prior periods are recalculated.

Countries Page

Use the Countries page (GP_COUNTRY) to define the retro method at the country level.

Navigation:

Set Up HCM > Product Related > Global Payroll & Absence Mgmt > System Settings > Countries > Countries

Note: We discuss the Countries page in detail elsewhere in this documentation.

See [Countries Page](#).

Retro Process Definitions Page

Use the Retro Process Definitions page (GP_RTO_PRC_DEFN) to define a retro process.

Navigation:

Set Up HCM > Product Related > Global Payroll & Absence Mgmt > Triggers > Retro Process Definitions > Retro Process Definition

This example illustrates the fields and controls on the Retro Process Definitions page.

| <i>Field or Control</i> | <i>Description</i> |
|--|--|
| Retro Process Definition ID (retroactive process definition ID) | Identifies the retro process you are defining. |
| Retro Method | For Absence Management, this value should always be set to <i>Corrective</i> . |
| Retro Method Varies | Leave this check box empty. It applies only to Global Payroll. |

Retro Method Decided By

The fields in this group box apply only to Global Payroll.

Retro Event Definitions Page

Use the Retro Event Definitions page (GP_RTO_EVT) to associate a triggering event (a change in critical data) with one of the processes that you defined on the Retro Process Definition page.

Navigation:

Set Up HCM > Product Related > Global Payroll & Absence Mgmt > Triggers > Retro Event Definitions > Retro Event Definitions

This example illustrates the fields and controls on the Retro Event Definitions page.

Retro Event Definitions

Country BRA Brazil

Trigger Event ID PER AQ

*Description Short Description

*Retro Process Definition ID Entitlement Period Trigger Absence Event

The mechanism that is used to track online data changes that should trigger retroactive processing is called a *trigger*. In Absence Management, you set up triggers by identifying the records and fields that should trigger retroactive processing in response to data changes, and by defining the retro process definition to use to process these changes:

1. On the Retro Event Definitions page, associate each of the retro processes defined on the Retro Process Definitions page with a trigger event ID.
2. On the Trigger Definitions page, identify the records and fields that should trigger retroactive processing when data is modified or updated retroactively.
3. On the Trigger Definitions and Trigger Definitions - Field Values pages, associate the records and fields identified in step 2 with one of the trigger event IDs you defined in step 1. Because each ID is linked to a process definition, the system can automatically apply the correct retro process when one of these records or fields is modified or updated.

Note: Because the Trigger Definitions and Trigger Definitions - Field Values pages are documented in another topic, this topic describes only the use of the Retro Event Definitions page.

See [Understanding Trigger Definition Setup](#).

| Field or Control | Description |
|------------------------------------|--|
| Country | This display-only field is populated based on the country that you selected on the search page. |
| Trigger Event ID | This display-only field is populated based on the trigger event ID that you selected on the search page. Link each trigger event ID to one of the processes you defined on the Retro Process Definition page. |
| Retro Process Definition ID | Select a process that you defined on the Retro Process Definition page to link to the trigger event ID. Note: Different countries can process the same event differently. |
| Absence Event | Select if the trigger event ID is for an absence event only. |

Example of an Absence Event

The Absence Event indicator determines the first calendar for recalculation, which avoids processing calendars unnecessarily. Selection of the indicator depends on such things as the processing order of the calendars for a particular period, as well as what absence related trigger definitions have been defined and to which retro events they point. When the indicator is set to yes, processing can start at the first absence calendar instead of the first calendar that qualifies after checking retro limits.

Note: Absence balance accumulators are always defined as corrective—they must be updated (replaced) at the end of each calculation period.

Related Links

[Trigger Definitions Page](#)

[Understanding Accumulators](#)

Retro Limits Page

Use the Retro Limits page (GP_PYENT_RETRO) to define the backward and forward limits for retro processing at the pay entity level.

Navigation:

Set Up HCM > Product Related > Global Payroll & Absence Mgmt > Framework > Organizational > Pay Entities > Retro Limits

This example illustrates the fields and controls on the Retro Limits page.

The screenshot displays the 'Retro Limits' configuration page for pay entity GN1PYENT01. It features two main sections: 'Retro Period Backward Limit' and 'Retro Period Forward Limit'. Each section includes radio button options for 'No Limit', 'Limit by Months', and 'Limit by Years'. Below these options are input fields for 'Number of Months/Years', 'Retro Back/Forward Limit Start Month', and 'Retro Back/Forward Limit Start Day'. At the top of the page, there are checkboxes for 'Process Retro', 'Accum Adjustments Persist', and 'Deltas Cross Pay Groups'. The page also has a navigation bar with tabs for 'Pay Entity Address', 'Processing Details', 'Retro Limits', 'Supporting Element Overrides', 'Source Bank Link', and 'Combine Payments'.

After you have defined a retro method and the events that trigger retro processing, you must specify the backward and forward limits for retro processing at the pay entity level. This tells the system how far back in time to go to recalculate closed calendars, and how long a payee is eligible for retroactive processing after being inactivated or terminated.

Note: You can override backward and forward limits you define at the pay entity level using the Retro Limits Assignment page at the payee level.

Retro Period Backward Limit

Use the fields in this group box to limit the number of calendar periods that Absence Management can reprocess going into the past.

To determine how far back to go, the system compares the backward limit defined on the Retro Limits page to the retro trigger effective date. If the trigger effective date comes before the backward limit date, the system uses the backward limit date to determine the first retro period. If the backward limit date comes before the trigger effective date, the system uses the trigger date to determine the first retro period to process.

| <i>Field or Control</i> | <i>Description</i> |
|--|--|
| Process Retro | Select to enable retroactive processing at the pay entity level. You can override your selection at the payee level. |
| Acm Adjustments Persist (accumulator adjustments persist) | <p>Select to retain adjustments to accumulator balances when retroactive processing causes an accumulator to be recalculated in a prior period. This option may be needed because Absence Management does not automatically include adjustment amounts when recalculating accumulator balances. For example, if you select this check box and reprocess a prior period in which an accumulator with a value of 100 received an adjustment of 10, the system computes the incoming balance as the sum of the original accumulator and the user-entered adjustment, and returns a value of 110. Otherwise, the system ignores the adjustment and returns a balance of 100.</p> <hr/> <p>Note: The preferred approach to managing accumulator balances is to correct the elements (entitlements or takes) that contribute to the accumulator, rather than to adjust the accumulator directly. This is because other accumulators that store period-to-date amounts or other values based on the calculation of the same elements will not be automatically updated, possibly resulting in calculation or reporting errors.</p> <hr/> <p>Note: To adjust accumulator balances, use the Adjust Accumulator Balance page.</p> <hr/> <p>See Adjusting Accumulator Balances.</p> |
| Deltas Cross Pay Groups | Leave this check box empty. It applies only to Global Payroll. |

| Field or Control | Description |
|---|---|
| No Limit - Backward | <p>If you select this option, then retro processing begins with the first period that includes the trigger effective date and goes forward.</p> <p>Selecting this option does not mean that there are no limits to how far back you can go. The No Retro Processing Before date limits how far back in time you can go to process retroactivity.</p> |
| Limit by Months - Backward and Number of Months - Backward | <p>To define a limit in terms of months, select this option and enter the number of months that the system can calculate into the past. The system determines the maximum number of months to go back starting from the begin date of the first calendar in the current calendar group for the payee.</p> |
| Limit by Years - Backward and Number of Years - Backward | <p>To define a limit in years, select this option and enter the number of years that the system is to calculate into the past. This limit year, in conjunction with the Retro Back Limit Start Month and Retro Back Limit Start Day fields, determines how far back the system can go when processing retroactivity.</p> <p>For example, if Number of Years - Backward is 2, Retro Back Limit Start Month is 06 (June), Retro Back Limit Start Day is 01, and the current period begin date is April 1, 2005, then the backward limit is June 1, 2003. The system allows retroactivity 2 years from the current period begin date, but not prior to June 1 of that year.</p> |
| Retro Back Limit Start Month | Select the calendar month to use as the backward limit. |
| Retro Back Limit Start Day | Select the day to use as the backward limit. |

Example 1: Using months criterion to determine the first retro period to recalculate.

| Trigger Effective Date | Current Calendar Period | Backward Limit | First Retro Period |
|-------------------------------|--------------------------------|--------------------------|--------------------------------|
| February 15, 2005 | June 1, 2005–June 30, 2005 | 2 months = April 1, 2005 | April 1, 2005 – April 30, 2005 |

Absence Management determines the backward limit by going back two months from the current calendar period begin date of June 1, 2005, providing a limit date of April 1, 2005. The system compares the backward limit date to the trigger effective date. The trigger effective date precedes the backward limit date, so the system uses the backward limit date to determine the first retro period. Two periods are recalculated. April (April 1, 2005–April 30, 2005) and May (May 1, 2005–May 31, 2005).

Example 2: Using years, months, and days criteria to determine the first retro period to recalculate (trigger effective date does not exceed backward limit date).

| Trigger Effective Date | Current Calendar Period | Backward Limit | First Retro Period |
|-------------------------------|--------------------------------|---|----------------------------|
| June 30, 2004 | June 1, 2005–June 30, 2005 | Year =1, Month = 3, Day = 15 (March 15, 2004) | June 1, 2004–June 30, 2004 |

Absence Management determines the backward limit by going back one year (the start year is determined by the year of the begin date of the first calendar) and applying the month and day that are defined: The result is a backward limit date of March 15, 2004. The system compares the limit to the trigger effective date, which (in this example) establishes the first retro period because it does not exceed the backward limit date. Twelve periods will be recalculated.

Example 3: Using years, months, and days criteria to determine the first retro period to recalculate (trigger effective date exceeds backward limit date).

| Trigger Effective Date | Current Calendar Period | Backward Limit | First Retro Period |
|-------------------------------|--------------------------------|---|------------------------------|
| February 28, 2004 | June 1, 2005–June 30, 2005 | Year = 1, Month = 3, Day =15 (March 15, 2004) | March 1, 2004–March 31, 2004 |

Absence Management determines the backward limit by going back one year (the start year is determined by the year of the begin date of the first calendar) and applying the month and day that are defined: The result is a backward limit date of March 15, 2004. The system compares that date to the trigger effective date, which (in this example) exceeds the backward limit date, so that the backward limit date determines the first retro period. Fifteen periods will be recalculated.

Retro Period Forward Limit

Use the fields in this group box to specify the amount of time that retroactive data can continue to be processed after a payee is terminated or becomes inactive.

| Field or Control | Description |
|---|--|
| No Limit - Forward | If you select this option, retroactive data can be processed indefinitely for inactive payees belonging to this pay entity. Although eligible for retro processing, the inactive payee is still restricted by the backward limits. |
| Limit by Months - Forward and Number of Months - Forward | To define the forward limit in months, select this option and enter the number of months to continue calculating retroactivity after a payee becomes inactive. The system determines the maximum number of months using the <i>Inactive</i> date of the last active job. |

| Field or Control | Description |
|--|---|
| Limit by Years - Forward and Number of Years - Forward | To define the forward limit in years, select this option and enter the number of years beyond the inactive date to process retro. The year, in conjunction with the Retro Fwd Limit Start Month and Retro Fwd Limit Start Day , determines how long after the inactive date the system allows retroactivity processing. |
| Retro Fwd Limit Start Month (retro forward limit start month) | Enter the calendar month to use as the forward limit in conjunction with the year in the Number of Years - Forward field. |
| Retro Fwd Limit Start Day (retro forward limit start day) | The day to use as the forward limit in conjunction with the year and month entered in the Number of Years - Forward and Retro Fwd Limit Start Month fields. For example, if the Number of Years is 2, the Retro Fwd Limit Start Month is 06 (June), the Retro Fwd Limit Start Day is 01, and the termination date is January 1, 2005, the limit for processing retroactivity would be June 1, 2007. In this example, the system knows to allow retroactivity for 2 years from the <i>Inactive</i> date, but not after June 1 of that year. |

Example 1: Using months criterion to determine the first retro period to recalculate (calendar period does not exceed forward limit).

| Inactive Date | Current Calendar Period | Forward Limit | Eligible for Retro Processing? |
|----------------------|--------------------------------|------------------------------|---------------------------------------|
| January 1, 2005 | June 1, 2005–June 30, 2005 | 12 months (January 31, 2006) | Yes |

Absence Management determines the forward limit by going forward 12 months from the inactive date. The current calendar period does not exceed the forward limit, so retro processing can occur. The retro triggers are compared to the backward limits to continue the process.

Example 2: Using months criterion to determine the first retro period to recalculate (calendar period exceeds forward limit).

| Inactive Date | Current Calendar Period | Forward Limit | Eligible for Retro Processing? |
|----------------------|--------------------------------|---------------------------|---------------------------------------|
| January 31, 2005 | June 1, 2005–June 30, 2005 | 3 months (April 30, 2005) | No |

Absence Management determines the forward limit by going forward 3 months from the inactive date. The current calendar period (in this example) exceeds the forward limit, so retro processing cannot occur. The retro triggers are ignored and marked as used.

Assign Retro Limits Page

Use the Assign Retro Limits page (GP_PYE_RTO_LIM) to override, at the payee level, the backward and forward limits for retro processing that you established at the pay entity level on the Retro Limits page.

Navigation:

Global Payroll & Absence Mgmt > Payee Data > Create Overrides > Assign Retro Limits > Retro Limits Assignment

This example illustrates the fields and controls on the Assign Retro Limits page.

Assign Retro Limits

Gerrit Mastenbroek
Person ID KNG003

No Retro Processing Before 31

Use Pay Entity Retro Limits

Process Retro

Backward Limit

No Limit - Backward

Limit by Months - Backward
Number of Months - Backward

Limit by Years - Backward
Number of Years - Backward
Retro Back Limit Start Month
Retro Back Limit Start Day

Forward Limit

No Limit - Forward

Limit by Months - Forward
Number of Months - Forward

Limit by Years - Forward
Number of Years - Forward
Retro Fwd Limit Start Month
Retro Fwd Limit Start Day

Note: The fields on this page are almost identical to those on the Retro Limits page. To view definitions of the shared fields, return to the section on the Retro Limits page. In this topic we discuss only the fields that are unique to the Retro Limits Assignment page.

| Field or Control | Description |
|------------------------------------|---|
| No Retro Processing Before | This date is the date when Absence Management begins processing a payee. It is set by the system, but you can override it. The system cannot process retroactivity for a payee prior to this date. If a payee has multiple jobs, be sure that this date is correct, to support all jobs. |
| Use Pay Entity Retro Limits | Select to use the retro limits that are defined for the pay entity to which the payee belongs. When this check box is selected, the system uses the values from the pay entity definition, and all other fields on this page, other than No Retro Processing Before , are unavailable for entry. When this check box is cleared, the Process Retro check box becomes available for entry, and the system uses the values that were entered at the payee level, rather than those that were entered at the pay entity level. |

| <i>Field or Control</i> | <i>Description</i> |
|-------------------------|---|
| Process Retro | Select if you want retroactivity to be processed. If you select this check box, the fields in the Backward Limit and Forward Limit group boxes become available for data entry. |

Related Links

[Setting Backward and Forward Retro Limits](#)

Additional Pages Affecting Retroactive Processing

In addition to the pages described earlier in this documentation, several other pages affect retro processing. These pages are of two types—general setup pages and calendar setup. The following table describes these pages:

| <i>Page Type</i> | <i>Page Name</i> | <i>Description</i> |
|---------------------|---------------------------------|---|
| General Setup Page | Pay Entity - Processing Details | Define payment keys. Retro adjustments respect payment key values when they are applied to a segment. |
| Calendar Setup Page | Run Types | Identify the run types that can process retro triggers. The run type is linked to a calendar, which is linked to a calendar group. If at least one calendar in the group is defined to process retro triggers, the calendar group uses the instructions defined for the run type as the default instructions for processing retro triggers. |
| Calendar Setup Page | Calendars - Definition | Specify the payees to process in a calendar run. You can select payees with retro triggers (active or inactive) for processing. |
| Calendar Setup Page | Calendar Group | Indicate whether to process retro triggers defaults from Run Type. If at least one calendar allows retro triggers to be processed, the Process Retro Triggers check box will be selected. Otherwise it will be cleared. It can be cleared so that retro triggers are not processed. However, you cannot select it in order to process retro triggers if the default setting is cleared. |

Understanding Complex Retro Processing

This topic discusses:

- Segmentation and retro
- Retroactive deletes
- Retroactive adds

Segmentation and Retro

Segmentation can affect retro processing when a segmented period is being recalculated for retro, and the segmentation dates of the original calculation don't coincide with those of the recalculation.

This is called a *segment mismatch*, and it affects how retro deltas are calculated.

Note: Segmentation also affects how the system manages the Retro Recalculation Option of **Do Not Recalculate**.

See [Understanding Segmentation Setup](#).

Calculating Deltas in Matched and Mismatched Segments

The way that Absence Management calculates deltas varies depending on whether the segmentation dates and payment keys of the prior period match those of the recalc period.

When Segments Match

When segment dates match and payment keys are the same, the system recalculates the original segments (to determine the new values for each segment), subtracts the old value from the new value for each element of pay, and writes new results to the output tables.

When Segments Don't Match

When segments don't match, the system treats the old and new values as if they belong to separate segments.

- The system creates reversal segments for each segment that existed in the prior calculation and then creates new recalc segments.
- A reversal segment does not have any results.

The new recalc segments generate the new values. The new values are written to the output result tables.

Note: When the value of a payment key (for example, company ID) changes between a prior calculation and the recalculation, the system handles the situation as a segment mismatch. That is, it treats the old and new calculations as belonging to separate segments—just as if the segment dates no longer matched.

See [Understanding Segmentation Setup](#).

Retroactive Deletes

A retroactive delete occurs when there is a retroactive termination, a retroactive pay group transfer, or a retroactive change in pay system. In all cases the information is received after the actual effective dates for these changes. The result is that calculations were made when they should not have been and these results must be completely reversed.

Retroactive Adds

A retroactive add occurs when there is a retroactive hire or a retroactive pay group transfer. With a retroactive hire, there is no previous calculation. In the case of a retroactive pay group transfer, the retro add refers to the pay group to which the payee is transferred.

Reviewing Tips for Retroactive Processing

The following table provides hints on using retroactive processing.

| Question | Answer |
|--|--|
| Can Absence Management calculate retro across countries? | The default retro method, retro process definitions, and trigger event IDs are defined by country. The system does not calculate retro across countries. However, if a payee transfers to another country, and it's later discovered that the payee should have received additional entitlement while employed in the first country, it might be possible to process retro for that payee even though he or she is inactive in the original country. This depends on the forward limits that apply at the pay entity level and other processing rules that determine how long after a payee is inactive he or she remains eligible for retroactive processing. |

| Question | Answer |
|---|---|
| <p>What happens when multiple triggers are generated and each points to a different retro process definition?</p> | <p>Suppose that multiple retro events occur, causing multiple retro triggers to be written to the trigger tables. If these triggers call for that calendar run to be processed (recalculated) using different process definitions, a conflict will occur. In such a situation, where the events that cause retroactive processing activate the application of more than one process definition for the same payee in the same calendar, the system writes an error message and does not process retro. Only the current period is calculated. Retro triggers are not marked as processed.</p> <hr/> <p>Note: The retro conflict method that is specified on the Countries page does not apply to the conflict situation described here. In this situation, the retro conflict method will not resolve the conflict. However, you can change the event ID that is associated with the retro trigger, using the Payee Trigger Retro Expanded page.</p> <hr/> <p>For a payee, you cannot have more than one process definition resulting from the retro events that cause retroactivity for that calendar run. The same process must apply for all calendars in the calendar group.</p> |

Related Links

[Setting Up Retroactive Processing](#)

[Understanding Segmentation Setup](#)

Integrating Absence Management and the Payroll System

Understanding How Absence Management Integrates with the Payroll System

This topic discusses:

- Mapping Absence Management pay groups to the payroll system.
- Mapping Absence Management codes to the payroll system.
- Setting up job level data to assign Absence Management to payees.
- Running Absence Management processes to create an absence generated positive input file.
- Managing the generated positive input file.
- Running the Absence Management conversion process to Payroll for North America or Payroll Interface.
- Running payroll system processes.

Mapping Absence Management Pay Groups to the Payroll System

Pay groups are defined in both Absence Management and in the payroll system. You must establish a one-to-one correspondence between each pay group in Absence Management and each pay group in either Payroll for North America or Payroll Interface, depending on which application you use.

Mapping Absence Management Codes to the Payroll System

Absence codes in Absence Management need to be translated to either earning or deduction codes in the payroll system. You must establish a one-to-one correspondence between the codes in Absence Management and the codes in Payroll for North America or Payroll Interface, depending on which application you use.

The direct interfaces to Payroll for North America and to Payroll Interface map their Absence Codes on the Earnings/Deduction Mapping page in Absence Management. Payroll for North America with a Time and Labor interface maps Absence Codes on the Time Reporting Code— TRC page in Time and Labor.

Setting Up Job Level Data to Assign Absence Management to Payees

At the job data level you assign Absence Management to each payee. Additionally, you must enroll payees in Time and Labor if you use it in conjunction with Payroll for North America.

Running Absence Management Processes to Create an Absence Generated Positive Input File

Running the absence calculation process creates absence results as generated positive input in Absence Management.

Managing the Generated Positive Input File

Any generated positive input record created by Absence Management can be marked to not be converted or sent to the payroll system.

Running the Absence Management Conversion Process for Payroll for North America or Payroll Interface

Running the conversion process transfers or makes the absence results available to the payroll system for processing.

Note: Absence Management and Time and Labor integration involves the ability for Absence administrators to process absence multiple times and send the absence data immediately to Time & Labor. This also allows the administrator to run multiple calendar groups at the same time. Absence conversion process is applicable only for Non-TL employees if this feature is enabled. When this feature is enabled, Absence conversion process will not process TL employees. And for Non-TL employees, it will proceed with loading the PSHUP table.

Running Payroll System Processes

Running the payroll process generates payroll results that take into account absence-related earning or deductions that were calculated in Absence Management and provided to your payroll system through integration.

Configuring Absence Management Integration with PeopleSoft Payroll Systems

Most mapping and setup pages are shared by Payroll for North America and Payroll Interface. Additional setup is required when Payroll for North America is used with PeopleSoft Time and Labor. After you complete the setup, the application runs separate conversion processes depending on the payroll system with which you integrate. These processes are discussed in subsequent sections.

Pages Used to Configure Absence Management Integration with Payroll for North America or Payroll Interface

| <i>Page Name</i> | <i>Definition Name</i> | <i>Usage</i> |
|--|------------------------|---|
| Absence Pay Group Mapping Page | GP_ABS_PAYGROUP | Map pay groups that are defined in Absence Management to pay groups that are defined in Payroll for North America or Payroll Interface. |
| Absence Earns/Deductn Mapping Page | GP_ABS_ERN_DED_MAP | Map elements defined in Absence Management to codes in direct interface with Payroll for North America or Payroll Interface. |
| Mng Generated Positive Input Page | GP_ABS_MANAGE_GPI | View and manage generated positive input from the absence process by Calendar Group ID. Filter records by EmplID and select or clear specific records for conversion to Payroll for North America or Payroll Interface. |

Absence Pay Group Mapping Page

Use the Absence Pay Group Mapping page (GP_ABS_PAYGROUP) to map pay groups that are defined in Absence Management to pay groups that are defined in Payroll for North America or Payroll Interface.

Navigation:

Set Up HCM > Product Related > Global Payroll & Absence Mgmt > Integration > Absence Pay Group Mapping > Absence Pay Group Mapping

This example illustrates the fields and controls on the Absence Pay Group Mapping page.

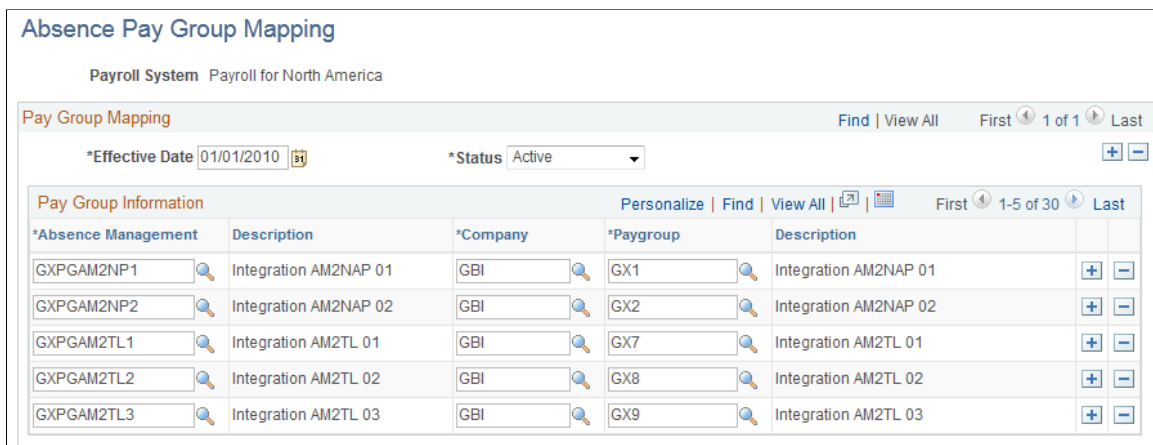

Use this page to establish a one-to-one correspondence between pay groups in Absence Management and pay groups in Payroll for North America or Payroll Interface. For Payroll for North America, the pay group prompt list originates from the Payroll for North America Pay Group Table without any PI Configuration value; those for Payroll Interface have a PI Configuration value.

Note: A company may have multiple pay groups, but each pay group is attached to only one company.

Absence Earns/Deductn Mapping Page

Use the Absence Earns/Deductn Mapping page (GP_ABS_ERN_DED_MAP) to map elements defined in Absence Management to codes in direct interface with Payroll for North America or Payroll Interface.

Navigation:

Set Up HCM > Product Related > Global Payroll & Absence Mgmt > Integration > Earnings/Deductions Mapping > Earnings/Deductions Mapping

You use different pages to map Absence Management codes to the payroll system's earning or deduction codes depending on which applications you use. This topic discusses pages used to:

- Map Absence Management codes to Payroll for North America without Time and Labor.
- Map Absence Management codes to Payroll for North America with Time and Labor.
- Map Absence Management codes to Payroll Interface.

Mapping Absence Management Codes to Payroll for North America without Time and Labor

Access the Absence Earnings/Deduction Mapping page using Payroll for North America as the payroll system (**Set Up HCM > Product Related > Global Payroll & Absence Mgmt > Integration > Earnings/Deductions Mapping > Absence Earns/Deductn Mapping**).

This example illustrates the fields and controls on the Absence Earns/Deductn Mapping page for Payroll for North America without Time and Labor.

The screenshot shows the 'Absence Earns/Deductn Mapping' page for 'Payroll System: Payroll for North America'. It features a 'Mapping' section with filters for '*Effective Date' (01/01/1990) and '*Status' (Active). Below is an 'Earnings' table with the following data:

| *Element Type | *Element Name | *NA Earnings Code | Description |
|---------------|---------------|-------------------|--------------------|
| Earnings | K0WBEREAV UP | KW2 | Unpaid Bereavement |
| Earnings | K0WBEREAV PD | KW1 | Bereavement |
| Earnings | K0WSICK PAID | KW5 | Sick |
| Earnings | K0WSICK UNP | KW6 | Unpaid Sick |
| Earnings | K0WJURY PAID | KW3 | Jury Leave |

Use this page to map earning elements in Absence Management to Earning Codes in a Payroll for North America system that does not interface with Time and Labor.

Note: All positive input generated in Absence Management that interfaces directly with Payroll for North America without Time and Labor must be linked to earning codes on the Absence Earnings/Deduction Mapping page. Earning codes for Payroll for North America originate from the Payroll for North America Earnings Code table.

Mapping Absence Management Codes to Payroll for North America with Time and Labor

If you use Time and Labor, you must map Time Reporting Codes (TRCs) to both Payroll for North America Earnings Codes and Absence Management elements at the same time. You do this on the Time and Labor TRC setup pages by selecting the Absence Flag and selecting North American Payroll as the payroll system.

See “Defining and Mapping Time Reporting Codes (TRCs)” (PeopleSoft Time and Labor).

Mapping Absence Management Codes to Payroll Interface

Access the Absence Earnings/Deduction Mapping page using Payroll Interface as the payroll system (**Set Up HCM > Product Related > Global Payroll & Absence Mgmt > Integration > Earnings/Deductions Mapping > Absence Earns/Deductn Mapping**).

This example illustrates the fields and controls on the Absence Earns/Deductn Mapping page for Payroll Interface.

The screenshot displays the 'Absence Earns/Deductn Mapping' page for the 'Payroll System: Payroll Interface'. The page includes search and navigation controls at the top, such as 'Find | View All', 'First', '1 of 1', and 'Last'. Below these are filters for '*Effective Date' (01/01/1990) and '*Status' (Active). The main content is a table titled 'Earnings/Deductions' with columns for '*Element Type', '*Element Name', and '*Payroll Interface Code'. The table contains five rows of data, each with a search icon and '+'/'-' buttons for adding or removing rows.

| *Element Type | *Element Name | *Payroll Interface Code |
|---------------|---------------|-------------------------|
| Earnings | K0WBEREAV UP | BER_UNP |
| Earnings | K0WBEREAV PD | BER_PAID |
| Earnings | K0WSICK PAID | SICK_PAID |
| Earnings | K0WSICK UNP | SICK_UNP |
| Earnings | K0WJURY PAID | JURY_PAID |

For Payroll Interface, you can map both earning and deduction elements from Absence Management.

Note: Positive input generated in Absence Management does not need to be mapped to valid Payroll Interface codes. Absence Management does not validate Payroll Interface codes. Mapped Payroll Interface codes are free form, as defined by the third-party payroll system's interface. Element numbers (PIN_NUM), Element Codes (PIN_CODE) or Element Names (PIN_NM) can be used instead of mapped Payroll Interface codes to identify Absence codes in Absence Management's output interface file.

Identifying Absence Management at the Payee Job Level

You must identify the payroll and absence system for each payee using the Payroll page in the Job Data component of PeopleSoft HR.

See “Changing Job Data” (PeopleSoft Human Resources Administer Workforce).

Select *Payroll for North America* or *Payroll Interface* in the **Payroll System** field. In addition, select *Absence Management* in the **Absence System** field. Enter the Absence Management system's **Pay Group, Eligibility Group, Exchange Rate Type, and Use Rate As Of** in the fields provided in the Absence Management System group box. To set any of the latter three values to default from the Absence Management pay group's values, select the appropriate check box under **Use Pay Group Value**. Otherwise, enter a corresponding value in each field.

Note: If you are using Absence Management as a stand alone system, the valid **Payroll System** in Job Data is *Global Payroll*. When you select *Global Payroll* as a **Payroll System**, the **Absence System** is automatically defaulted to *Absence Management*. Thus there are no additional integration components to setup other than the usual processing and organizational framework.

Note: For Payroll for North America that interfaces with Time and Labor, the employee should also be enrolled in Time and Labor's Time Reporter Data.

Related Links

“Entering and Maintaining Time Reporter Data” (PeopleSoft Time and Labor)

Mng Generated Positive Input Page

Use the Mng Generated Positive Input (Manage Generated Positive Input) page (GP_ABS_MANAGE_GPI) to view and manage generated positive input from the absence process by Calendar Group ID.

Filter records by EmplID and select or clear specific records for conversion to Payroll for North America or Payroll Interface.

Navigation:

Global Payroll & Absence Mgmt > Absence and Payroll Processing > Absence Conversion Processing > Mng Generated Positive Input > Mng Generated Positive Input

This example illustrates the fields and controls on the Mng Generated Positive Input page.

Absence Management creates a Generated Positive Input (GP_PI_GEN_DATA) file when the Absence Take process runs during absence processing. Absence Management uses this file to provide information to the payroll system's interface file.

After the Generated Positive Input file is created, the user can opt not to send or process some absences to the payroll system. This page displays absence results for the selected Calendar Group ID as generated positive input. Select the **Do Not Process** check box in the Positive Input Details group box for all items that you do not want to transfer to the payroll system that Absence Management integrates with, either Payroll for North America or Payroll Interface.

Use the following fields and buttons to filter results by Employee ID and select or clear all check boxes.

| Field or Control | Description |
|----------------------------------|--|
| EmplID From and EmplID To | Enter an employee ID in one or both fields to limit the records that display in the Positive Input Details group box. Specifying a value in the EmplID From field sets the lower end of the range of values. Specifying a value in the EmplID To field sets the higher end of the range of values. You can leave these fields blank to display all generated positive input for the Calendar Group ID. |
| Select Payees | Click this button to display records for the range of EmplIDs that you specified in the EmplID From and EmplID To fields. |

| <i>Field or Control</i> | <i>Description</i> |
|----------------------------------|---|
| Clear | Click this button to remove values in the EmplID From and EmplID To fields. After clicking this button, you must click the Select Payees button again to display records for all, or a different range of EmplIDs. |
| Set All to Do Not Process | Click this button to select the Do Not Process check box for all displayed records. |
| Clear All | Click this button to clear the Do Not Process check box for all displayed records. |

Integrating with Payroll for North America

This diagram illustrates the flow of information from Absence Management to Payroll for North America, with or without the interface to Time and Labor.

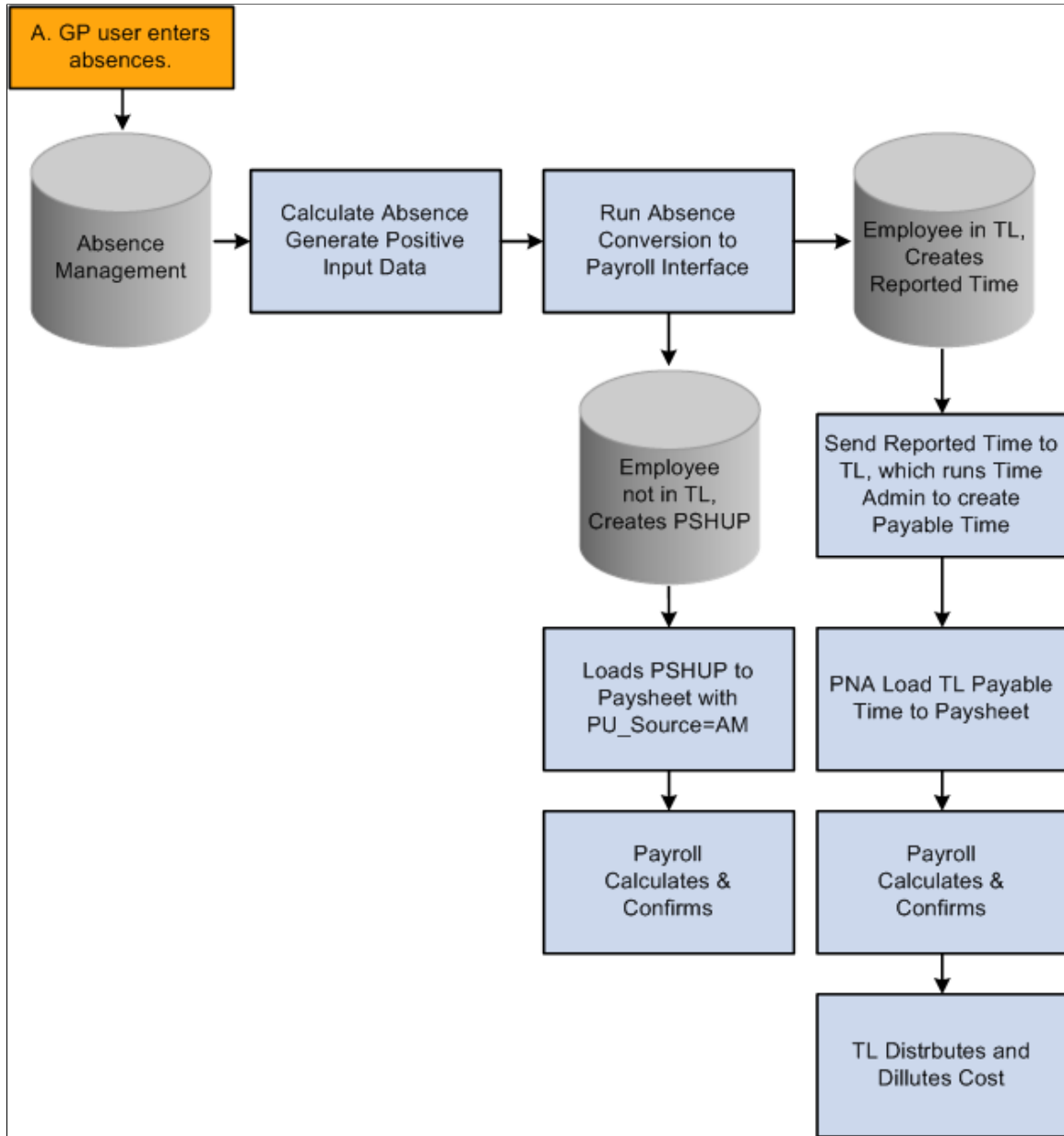

There are two types of integration between Absence Management and Payroll for North America, direct integration or integration though Time and Labor. To enable direct integration between Absence Management and Payroll for North America, Absence Management exports computed absence results to the PSHUP_TXN table where the rest of the interfaces with payroll for North America are deposited. Later on the Absence data can be loaded into Paysheets with the Load Transactions Table process, using the source code Absence Management.

If your organization uses Time and Labor in conjunction with Payroll for North America, Absence Management exports computed absence results in Time and Labor. Time and Labor converts the absence results into Payable Time.

This topic discusses how to:

- Run the Absence Conversion process to Payroll for North America.
- Run direct interface to Payroll for North America processes.
- Run interface to Payroll for North America through Time and Labor processes.
- Calculate absences with Payroll for North America.

Page Used to Integrate Absence Management to Payroll for North America

| <i>Page Name</i> | <i>Definition Name</i> | <i>Usage</i> |
|------------------------------|------------------------|---|
| To Payroll for North America | GP_ABS_NA_RUNCTL | Run the process that sends the generated positive input from the absence process to the Paysheet Load Holding Record (PSHUP) for use by Payroll for North America, or create Time and Labor Payable Time for use by Time and Labor. |

To Payroll for North America Page

Use the To Payroll for North America page (GP_ABS_NA_RUNCTL) to run the process that sends the generated positive input from the absence process to the Paysheet Load Holding Record (PSHUP) for use by Payroll for North America, or create Time and Labor Payable Time for use by Time and Labor.

Navigation:

Global Payroll & Absence Mgmt > Absence and Payroll Processing > Absence Conversion Processing > Send Data to Payroll for NA > To Payroll for North America

This example illustrates the fields and controls on the To Payroll for North America page.

To Payroll for North America

Run Control ID 1
Report Manager
Process Monitor
Run

Calendar Group ID ?

*Calendar Group ID Absence Mgmt-PNA OnCycle 04M06

Stream Number Process Streams

Calendar List Personalize | Find | View All | First 1 of 1 Last

| Pay Group | Calendar ID |
|------------|------------------|
| K0WPG PNA1 | K0WCA PNAON04M06 |

Streams Personalize | Find | View All | First 1 of 1 Last

| Stream Number | Date/Time of Query Creation |
|---------------|-----------------------------|
| | |

Use this page to transfer generated positive input from Absence Management to Payroll for North America. After this process is completed, the Absence Management data resides in the Paysheet Load Holding Record (PSHUP_TXN) in Payroll for North America for those employees that are not enrolled in Time and Labor.

See “Loading Paysheet Transactions” (PeopleSoft Payroll for North America).

Time and Labor Payable Time (TL_PAYABLE_TIME) updated through the Conversion Process

When payees are enrolled in Time and Labor and you run the Absence Conversion process, the system creates Time and Labor Payable Time (TL_PAYABLE_TIME) instead of creating data in the Paysheet Load Holding Record (PSHUP_TXN).

Note: A subset of payees whose absences are processed in Absence Management can be enrolled in Time and Labor. When you run the conversion process to Payroll for North America, the system identifies which payees are enrolled in Time and Labor and creates data appropriate for processing by Time and Labor before payroll processes occur.

Paysheet Load Holding Record (PSHUP_TXN) Fields Updated Through the Conversion Process

The following table lists values that populate the Paysheet Load Holding Record (PSHUP_TXN) fields in Payroll for North America. The PSHUP_TXN fields that are not listed are populated with blanks, zeroes or nulls depending on the field type. Key fields such as PAY_END_DT, OFF_CYCLE, PAGE_NUM, LINE_NUM, ADDL_NBR and SEPCHK are assigned values during the actual Paysheet Load process.

| <i>PSHUP_TXN Field</i> | <i>Value or Record.Field</i> |
|-------------------------------|-------------------------------------|
| PU_SOURCE | 'AM 'for Absence Management |
| CREATION_DT | Run's Current Date |
| COMPANY | JOB.COMPANY |
| PAYGROUP | JOB.PAYGROUP |
| PAY_END_DT | Null |
| OFF_CYCLE | 'N' |
| EARNNS_BEGIN_DT | GP_PI_GEN_DATA.BGN_DT |
| EARNNS_END_DT | GP_PI_GEN_DATA.END_DT |
| EMPLID | GP_PI_GEN_DATA.EMPLID |
| EMPL_RCD | GP_PI_GEN_DATA.EMPL_RCD |
| SEQNO | Assigned Unique Sequence Number |
| PU_TXN_TYPE | 'E' |
| PU_TXN_STATUS | 'A' |
| PAGE_NUM | 0 |
| LINE_NUM | 0 |
| ADDL_NBR | 0 |
| SEPCHK | 0 |
| DEPTID | JOB.DEPTID |
| JOBCODE | JOB.JOBCODE |

| <i>PSHUP_TXN Field</i> | <i>Value or Record.Field</i> |
|-------------------------------|-------------------------------------|
| POSITION_NBR | JOB.POSITION_NBR |
| ACCT_CD | JOB.ACCT_CD |
| PU_DISTRIBUTE | 'N' |
| ERNCD | GP_ABS_ERNDDMAP.ERNCD |
| ADDL_PAY_SHIFT | 'N' |
| ADDL_SEQ | 0 |
| ADDLPAY_REASON | 'N' |
| OTH_HRS | GP_PI_GEN_DATA.GP_UNIT |
| HOURLY_RT | GP_PI_GEN_DATA.GP_RATE |
| DISABLE_DIR_DEP | 'N' |
| BUSINESS_UNIT | GP_PI_GEN_DATA.BUSINESS_UNIT |
| AMT | GP_PI_GEN_DATA.GP_AMT |
| MANUAL_CHECK | 'N' |
| CURRENCY_CD | GP_PI_GEN_DATA.CURRENCY_CD |
| GROSSUP | 'N' |

Running Payroll System Processes for Payroll for North America

Absence Management converts the generated positive input file into a Payroll for North America Paysheet Transaction file (PSHUP_TXN) for employees not enrolled in Time and Labor. The paysheet transactions can be loaded using the Load Paysheet Transactions page in Payroll for North America by selecting *Absence Management* in the **Paysheet Update Source** field in the Calculate Options group box.

Absence Management data sent to Paysheets via Paysheets transaction file will be editable in Paysheets, just as rest of the transactions loaded using this method.

Note: If an employee is enrolled in Time and Labor in the middle of a pay period and there is absence data reported for such period of time, a portion of the absence will be sent to the Paysheet Transaction file and the other portion will be sent to Time and Labor Payable Time.

See “Load Paysheet Transactions Page” (PeopleSoft Payroll for North America).

Running Payroll for North America through Time and Labor

For employees enrolled in Time and Labor, the conversion process creates Time and Labor Payable time from Absence Management's generated positive input. . Consequently, you can load the payable time which includes your absence and time to paysheets using the Load Time and Labor process page in Payroll for North America.

Calculating Absences with Payroll for North America

After absence transactions are loaded into paysheets, Payroll for North America calculates the absences as earnings. If there is an interface through Time and Labor, then the process can go through Time and Labor cost distribution as needed.

See “Understanding the Pay Calculation Business Process” (PeopleSoft Payroll for North America).

Integrating with Payroll Interface

This diagram illustrates the flow of information from Absence Management to Payroll Interface.

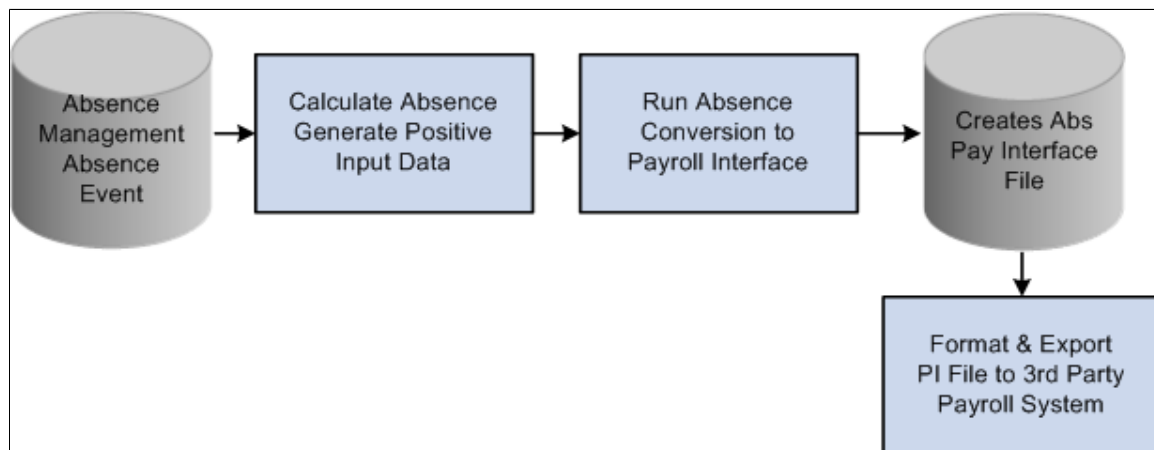

This topic discusses how to:

- Run the Absence Conversion process.
- Set up and run Payroll Interface processes.

Pages Used to Integrate Absence Management with Payroll Interface

| <i>Page Name</i> | <i>Definition Name</i> | <i>Usage</i> |
|---------------------------|------------------------|---|
| To Payroll Interface File | GP_ABS_PI_RUNCTL | Run the process that sends the generated positive input from the absence process to a new table from which Payroll Interface extracts data for use in the payroll system. |

To Payroll Interface File Page

Use the To Payroll Interface File page (GP_ABS_PI_RUNCTL) to run the process that sends the generated positive input from the absence process to a new table from which Payroll Interface extracts data for use in the payroll system.

Navigation:

Global Payroll & Absence Mgmt > Absence and Payroll Processing > Absence Conversion Processing > Send Data to Payroll Interface > To Payroll Interface File

This example illustrates the fields and controls on the To Payroll Interface File page.

The screenshot shows the 'To Payroll Interface' page with the following elements:

- Page title: **To Payroll Interface**
- Navigation: Run Control ID 1 | Report Manager | Process Monitor | **Run** button
- Input section:
 - Calendar Group ID: *Calendar Group ID Absence Mgmt-PI OnCycle 04M06
 - Stream Number:
 - Process Streams
- Calendar List table:

| Pay Group | Calendar ID |
|-----------|-----------------|
| K0WPG P11 | K0WCA PION04M06 |
- Streams table:

| Stream Number | DateTime of Query Creation |
|---------------|----------------------------|
| | |

Use this page to transfer generated positive input from Absence Management to Payroll Interface. After this process is completed, the Absence Management data resides in new table, Absence Management to Payroll Interface - Output File (GP_ABS_PAY_INTF), from which Payroll Interface extracts data for use in the payroll system.

Absence Management to Payroll Interface - Output File (GP_ABS_PAY_INTF) Fields Updated Through the Conversion Process

The following table shows values that populate GP_ABS_PAY_INTF fields for Payroll Interface. This record is available for further conversion and export according to third-party payroll system's requirements using Payroll Interface components.

| GP_ABS_PAY_INTF | Value or Record.Field |
|------------------------|--------------------------------|
| EMPLID | GP_PI_GEN_DATA.EMPLID |
| EMPL_RCD | GP_PI_GEN_DATA.EMPL_RCD |
| GP_PAYGROUP | GP_PI_GEN_DATA.GP_PAYGROUP |
| CAL_ID | GP_PI_GEN_DATA.CAL_ID |
| SRC_CAL_ID | GP_PI_GEN_DATA.SRC_CAL_ID |
| PI_VER_NUM | GP_PI_GEN_DATA.PI_VER_NUM |
| PIN_NUM | GP_PI_GEN_DATA.PIN_NUM |
| PI_SOURCE | GP_PI_GEN_DATA.PI_SOURCE |
| GEN_INSTANCE | GP_PI_GEN_DATA.GEN_INSTANCE |
| BGN_DT | GP_PI_GEN_DATA.BGN_DT |
| END_DT | GP_PI_GEN_DATA.END_DT |
| SRC_CAL_RUN_ID | GP_PI_GEN_DATA.SRC_CAL_RUN_ID |
| PAY_SYSTEM_FLG | JOB.PAY_SYSTEM_FLG |
| COMPANY | JOB.COMPANY |
| PAYGROUP | JOB.PAYGROUP |
| PI_FIELD_VALUE | GP_ABS_ERNDDMAP.PI_FIELD_VALUE |

| GP_ABS_PAY_INTF | Value or Record.Field |
|------------------------|-------------------------------|
| PIN_CODE | GP_PIN.PIN_CODE |
| PIN_NM | GP_PIN.PIN_NM |
| PI_ACTION_TYPE | GP_PI_GEN_DATA.PI_ACTION_TYPE |
| CURRENCY_CD | GP_PI_GEN_DATA.CURRENCY_CD |
| RATE_ASOF_DATE | GP_PI_GEN_DATA.RATE_ASOF_DATE |
| GP_RATE | GP_PI_GEN_DATA.GP_RATE |
| GP_UNIT | GP_PI_GEN_DATA.GP_UNIT |
| GP_BASE | GP_PI_GEN_DATA.GP_BASE |
| GP_PCT | GP_PI_GEN_DATA.GP_PCT |
| GP_AMT | GP_PI_GEN_DATA.GP_AMT |
| BUSINESS_UNIT | GP_PI_GEN_DATA.BUSINESS_UNIT |
| DESCR | GP_PI_GEN_DATA.DESCR |
| ABS_PRD_BGN_DT | GP_PI_GEN_DATA.ABS_PRD_BGN_DT |
| ABS_PRD_END_DT | GP_PI_GEN_DATA.ABS_PRD_END_DT |
| ABS_BGN_DT | GP_PI_GEN_DATA.ABS_BGN_DT |
| ABS_END_DT) | GP_PI_GEN_DATA.ABS_END_DT |

Setting Up and Running Payroll Interface Processes

Use Payroll Interface pages to set up and configure the process of extracting data from the new table that Absence Management creates during the Absence Conversion process to Payroll Interface. On the Payroll Interface set up pages enter GP_ABS_PAY_INTF as the Record Name. For Field Names, enter those listed in the table in the previous section.

See “Exporting or Importing Data” (PeopleSoft Payroll Interface).

Absence Management Integration and Retroactivity

Regardless of the payroll system's retroactive mode—which can be corrective or forwarding—the Absence Management retro conversions are always done in corrective mode. This means that all prior transactions for the retroactive period are reversed and new transactions are created for all entries from the recalculated results. This ensures that not only changes to amounts, but also changes to Absence Take codes and any segmentation that may result from retroactive processes is reflected in the updated transactions. Payroll for North America, Time and Labor and/or any third-party payroll system integrated with Payroll Interface processes the reversing of old transactions as well as new transactions; consequently, the system calculates the correct net amount for each absence code.

Note: If an employee whose absences are tracked using Absence Management is transferred to a different pay systems that uses Absence Management, we recommend that this be done at the beginning or end of the pay period. The generated positive input from Absence Management does not handle segments; consequently, there is a risk of sending the absence data to both systems if the Calendar ID's Additional Criteria is defined to process positive input.

Managing Applications and List Sets

Understanding Applications and List Sets

Application definitions and list sets work together, so you can configure the appearance of:

- Administrator results
- Reports
- Processes

Application definitions are high-level groups of settings that enable you to define what types of fields and field values you require at multiple element levels (list sets, element groups, and elements, for example). When you create a list set, the system prompts you to enter an application. Based on the application definition you select, the Define List Set page refreshes to display the available configuration fields.

List sets enable you to create groups of elements and corresponding element attributes to associate with a specific application, such as administrator results, a new report, or a process. For example, if you were to create your own report, you could have a list of entitlements, takes, and accumulators from which you would extract your report data. You can further specify the circumstances under which certain elements may or may not be printed. The List Set feature enables you to do this without having to create new pages and new records. In summary, list sets enable you to:

- Associate groups of elements with a specific application.
- Associate which element groups are part of the list set.
- Set up the configuration required for the application at various levels, including the list set level, element group level, and element level.

Note: To illustrate the relationship between applications and lists sets, we present exhibits that reference the delivered RSLT_ADM application. This application is delivered for use with the Administrator Results component, and is only one of many ways in which you can define applications and lists sets to control a variety of reports and processes in your system.

Primary List Set Components

The Application Definition and List Set feature is composed of three key parts:

- Element Groups

An element group is a list of elements. An absence administrator can use element groups to create a list of elements that may be used for one or multiple applications.

- Application Definitions

An application definition describes a set of attributes, such as sequence or print options, used to indicate what attributes the absence administrator will need to assign to elements in a list set to make them available for an application.

- List Sets

A list set is a set of element groups connected to an application definition in order to assign application specific attributes to list sets. The absence administrator uses list sets to group the element groups together and assign attributes to the elements, element groups, or the entire set. The list set includes all of the elements that will be available for the application.

Setup Flow of Application Definitions and List Sets

This diagram illustrates how setup on the Application Definition page determines which fields appear on the Define List Set page.

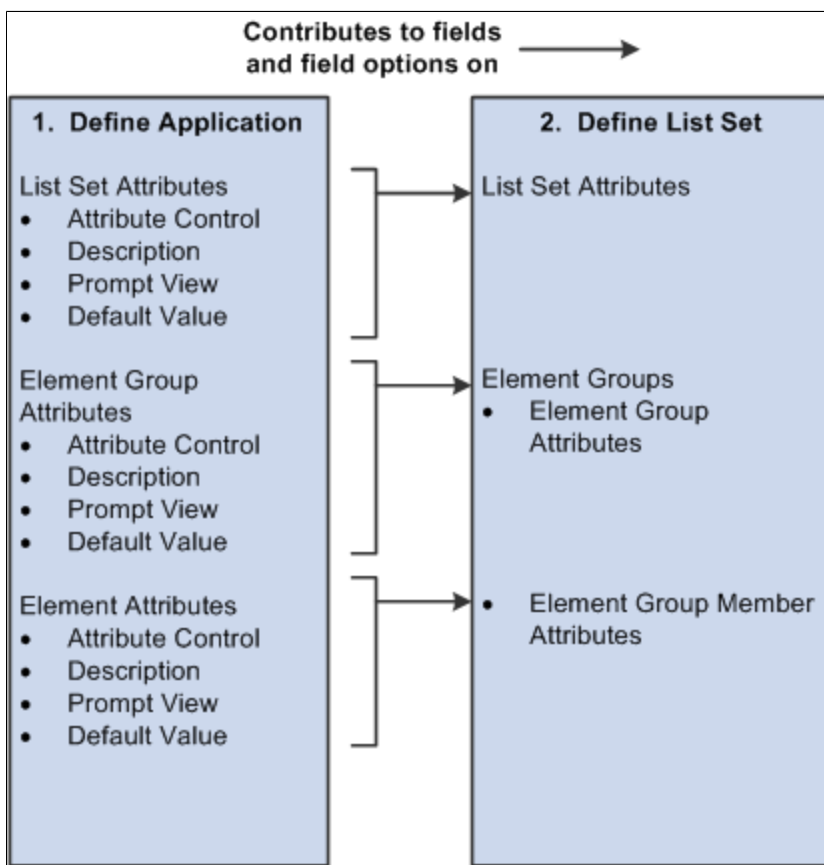

How to Set Up Applications and List Set Configurations

To build a list set using an application definition you must complete the following steps:

1. Use the Define Application page to identify and label the attributes you want to define. These can be defined at the list set, element group, and element level. The system uses the information on the Define Application page to populate the List Set page.
2. Use the Define Values for Attribute secondary page to specify additional values, as necessary.

3. Use the Define List Set page to identify various element groups that you want to associate with the list set, and specify attribute values for each. If you defined any attributes at the list set level on the Define Applications page, the system displays them here. You may also create new element groups from this page if you have not previously done so.
4. Use the Element Group Attributes secondary page to view or update element group and element attribute details.

Prerequisite for Applications and List Sets

Element groups are needed on the Define List Set page. Therefore, before you can set up application definitions and lists sets, you should set up element groups. If you do not set up Element Groups prior to creating a list set, you will have the opportunity to create the element group as you go. However, PeopleSoft recommends that you define any needed element groups before you set up applications and list sets.

Related Links

[Defining Element Groups](#)

Common Elements Used to Manage Applications and List Sets

| <i>Field or Control</i> | <i>Description</i> |
|-------------------------|---|
| Application | A feature, process, or report delivered by Absence Management or developed by the customer that requires the use of element groups and list sets. |
| Attribute | Characteristics defined for elements in a list, groups in a set, or for an entire set of elements such as at the element level "Print Rate" check box or at the list level "Rate Column Label" character field. |
| Element Group | An element group is a list, or group of elements. |
| List Set | A set of element groups defined for use with an application. |

Setting Up Applications

To set up application definitions, use the Define Application (GP_ELN_APP) component.

Pages Used to Set Up Application Definitions

| Page Name | Definition Name | Usage |
|---|--|---|
| <u>Define Application Page</u> | GP_ELN_APP | Define attributes attached to a list set, an element group, or an element. |
| <u>Define Values for Attribute Page</u> | GP_ELN_LIST_SET GP_ELN_LIST_LST GPE_ELN_LIST_PIN | Set up the specific attribute values available for a list set, element group, or element. |

Define Application Page

Use the Define Application page (GP_ELN_APP) to define attributes attached to a list set, an element group, or an element.

Navigation:

Set Up HCM > Product Related > Global Payroll & Absence Mgmt > Elements > Define Application > Define Application

This example illustrates the fields and controls on the Define Application page (1 of 2).

Define Application

Country ALL
 Application RSLT_ADM
 *Description Administrator Results

| List Set | | Personalize Find | First 1-10 of 10 Last |
|--------------------|-------------------------|--------------------|-----------------------|
| *Attribute Control | *Description | Prompt View | Default Value |
| Edit Box | Summary Grid Col 1 Msc | PSMSGSETDEFN | <input type="text"/> |
| Check Box | Display Summary | | Y |
| Edit Box | Summary Grid Col 1 Msc | | <input type="text"/> |
| Check Box | Display Supporting Elen | | Y |
| Check Box | Display Summary Grid O | | Y |
| Check Box | Display Earnings Deduc | | Y |
| Edit Box | Summary Grid Col 2 Msc | PSMSGSETDEFN | <input type="text"/> |
| Check Box | Display Accumulators | | Y |
| Edit Box | Summary Grid Col 2 Msc | | <input type="text"/> |
| Check Box | Display Absences | | Y |

This example illustrates the fields and controls on the Define Application page (1 of 2).

| Element Group | | Personalize Find [?] [] | | First | 1-5 of 5 | Last |
|--------------------|-------------------------|--------------------------------|--------|---------------|----------|------|
| *Attribute Control | *Description | Prompt View | Values | Default Value | | |
| Drop Down List | Element Grid | | | | | + - |
| Drop Down List | Element Grid Title Type | | | | | + - |
| Edit Box | Element Grid Title | | | | | + - |
| Edit Box | Message Set Number | PSMSGSETDEFN | | | | + - |
| Edit Box | Message Number | | | | | + - |

| Element | | Personalize Find [?] [] | | First | 1 of 1 | Last |
|--------------------|--------------|--------------------------------|---------------|-------|--------|------|
| *Attribute Control | *Description | Values | Default Value | | | |
| Drop Down List | Column | | 10 | | | + - |

Note: PeopleSoft delivers an application of RSLT_ADM with a country of ALL (shown in the preceding exhibit), designed to work in conjunction with the Administrator Results component. . You should not modify this delivered application. Link this delivered application with a list set of your choosing, and use it to control the appearance of the Administrator Results component.

See [Defining Administrator Absence Results](#).

See [Viewing Administrator Absence Results](#).

There is no minimum number of attributes required for each level (represented by the three group boxes). An application definition can be created without specifying attributes. This may be done for applications for which you intend to use the list set solely to group multiple element groups. There is a maximum of ten attributes for each level.

Attributes defined at the list set level apply to all of the element lists in the set.

| Field or Control | Description |
|--------------------------|---|
| Attribute Control | Specify how to display the attribute on the Define List Set page. Options are: <i>Check Box:</i> This attribute is displayed as a check box. <i>Drop Down List:</i> This attribute is a character field that only accepts input from a list of values that you can create on the Define Values for Attribute page. <i>Edit Box:</i> This attribute is a character field that accepts any character value. <i>Translate:</i> This attribute is a character field that only accepts input from a prompt list of translate values. |
| Description | Enter the field label name to appear on the List Set Definition page. |

| Field or Control | Description |
|-------------------------|--|
| Prompt View | Select a record from which to create a prompt table. The input will be validated against this table. This field is available only if the Attribute Control is <i>Edit Box</i> . Important! This is straight prompting on the record specified. There is no additional security utilized nor any relationship prompting (for example, using SetID logic, and so on). |
| Values | Select this link to record the available values on the Define Values for Attribute page. This field is available only if the Attribute Control is <i>Drop Down List</i> . |
| Field Name | Enter an element that contains translate values. The system presents these translate values in a drop down list on the Define List Set page. This field is available only if the Attribute Type is <i>Translate</i> . |
| Default Value | To have the system populate a specific attribute value on the Define List Set page, enter a valid default value. The default value must be valid for the associated attribute control. |

Define Values for Attribute Page

Use the Define Values for Attribute page (GP_ELN_LIST_SET) to set up the specific attribute values available for a list set, element group, or element.

Navigation:

On the Define Application page, click the **Values** link for attribute controls with a value of *Drop Down List*.

This example illustrates the fields and controls on the Define Values for Attribute page.





Define Values for Attribute















Country ALL

Application RSLT_ADM Administrator Results

Attribute Control Drop Down List

Description Element Grid

Values Personalize | Find | View All |   First  1-7 of 7  Last

| *Value | *Description | | |
|--------|--------------------------|---|---|
| 01 | Summary Accumulators |  |  |
| 02 | Supporting Elements |  |  |
| 03 | Earnings Deductions |  |  |
| 04 | Accumulators |  |  |
| 05 | Absence Daily Data |  |  |
| 06 | Generated Positive Input |  |  |
| 07 | Absence Accumulators |  |  |

For attributes with an attribute control of *Drop Down List*, you must specify the drop down field values. The system displays these values as options on the Element Group Attributes page during list set setup. You can use any value in the **Value** column as a default value.

| Field or Control | Description |
|-------------------------|--|
| Value | Enter the value returned. |
| Description | Enter the description associated with the value. |

Setting Up List Sets

To create list sets, use the Define List Set (GP_ELN_SET) component.

Pages Used to Define List Sets

| Page Name | Definition Name | Usage |
|------------------|------------------------|--|
| Define List Set | GP_ELN_SET | Assign element groups to an application. |

| Page Name | Definition Name | Usage |
|--------------------------|------------------------|--|
| Element Group Attributes | GP_ELN_SET_SEC | Enter the element and element group attribute values for a list set. |

Define List Set Page

Use the Define List Set page (GP_ELN_SET) to assign element groups to an application.

Navigation:

Set Up HCM > Product Related > Global Payroll & Absence Mgmt > Elements > Define List Set > Define List Set

This example illustrates the fields and controls on the Define List Set page.

Define List Set

Country GBR United Kingdom
 List Set RSLT_ADM
 *Description Administrator Results
 *Application Country ALL
 *Application RSLT_ADM Administrator Results

List Set Details Find | View All First 1 of 1 Last

*Effective Date 01/01/1990

List Set Attributes

| | |
|--|---|
| Summary Grid Col 1 Msg Set 17000 | <input checked="" type="checkbox"/> Display Summary |
| Summary Grid Col 1 Msg Nbr 4583 | <input checked="" type="checkbox"/> Display Supporting Elements |
| <input checked="" type="checkbox"/> Display Summary Grid Col 2 | <input checked="" type="checkbox"/> Display Earnings Deductions |
| Summary Grid Col 2 Msg Set 17000 | <input checked="" type="checkbox"/> Display Accumulators |
| Summary Grid Col 2 Msg Nbr 4584 | <input checked="" type="checkbox"/> Display Absences |

Element Groups Personalize | Find | View All First 1-7 of 7 Last

| *Element Group Name | Description | | |
|---------------------|----------------------------|--|-----|
| RSLT ADM SUMM ACM | Result Admin - Summ Accums | | + - |
| RSLT ADM SUPP ELEM | Result Admin - Supp Elem | | + - |
| RSLT ADM ACM | Result Admin - Accums | | + - |
| RSLT ADM ABS ACM | Result Admin - Abs Accums | | + - |
| RSLT ADM ABS TAKE | Result Admin - Abs Takes | | + - |
| RSLT ADM ABS GENPI | Result Admin - Abs Gen PI | | + - |
| RSLT ADM ERN DED | Result Admin - Earn / Ded | | + - |

[Create new Element Group](#)

| Field or Control | Description |
|-------------------------|---------------------------------------|
| Description | Enter a description for the list set. |

| Field or Control | Description |
|----------------------------|---|
| Application Country | Select the country for which you want to locate an application definition. |
| Application | Select the application definition. Doing so will cause the system to display a variety of fields on the page, based on the values defined for the application definition. |

List Set Attributes

All of the fields in the List Set Attributes group box are user-defined and come from the setup on the Define Application page. For example, the **Summary Grid Col 1 Msg Set** field in the previous exhibit was defined on the Define Application page using the **Attribute Control**, **Description**, and **Prompt View** fields. The **Display Summary** check box was defined there as well. In row number 2 of the following exhibit, you can see that the Display Summary check box was set up with a default value of *Y* for yes. This means that on the Define List Set page in *Add* mode for the *RSLT_ADM* application, the **Display Summary** check box appears and is selected by default.

This example illustrates the fields and controls on the Example of the setup source for the List Set Attributes group box.







Define Application

Country ALL

Application RSLT_ADM

*Description Administrator Results 

List Set Personalize | Find |  First 1-10 of 10 Last

| *Attribute Control | *Description | Prompt View | Default Value | | |
|--------------------|--|---|---------------|---|---|
| Edit Box | Summary Grid Col 1 Msg  | PSMSGSETDEFN  | |  |  |
| Check Box | Display Summary  | | Y |  |  |

Element Groups

Initially, in *Add* mode, there are no element groups in this group box. You must select all of the element groups you want to associate with this list set. If you want to assign an element group that has not yet been created, you may do so by clicking the Create new Element Group link.

| Field or Control | Description |
|---------------------------|---|
| Element Group Name | Enter the element groups to associate with this list set. The element groups you specify can appear in any component, report, or process that you configure using the list set. |

| Field or Control | Description |
|---------------------------------|--|
| Description | Click to access the Element Group Members page, where you can review details for the element group, and make changes if necessary. |
| Element Group Details | Click to access the Element Group Attributes page, where, depending on your settings on the Application Definition page, you can define more specifically where and how the details for each element group will appear in related components, reports, and processes. |
| Create new Element Group | Click to access the Element Groups component in <i>Add</i> mode where you can create an element group. This link is useful if you have not previously defined an element group that you want to reference in your list set. See Defining Element Groups . |

Note: The Define List Set page displays all of the added and updated elements with their default attribute values. The system first loads the list of elements from the element group definition and then assigns the values of the attributes from the GP_ELN_PIN_ATTR table. Thus, the page always displays the exact element group members. If an element is removed from the element group, the element is removed from the list set. The element group member list is refreshed each time the user views the Element Group Details page.

Element Group Attributes Page

Use the Element Group Attributes page (GP_ELN_SET_SEC) to enter the element and element group attribute values for a list set.

Navigation:

Select the **Element Group Details** link on the Define List Set page.

This example illustrates the fields and controls on the Element Group Attributes page.

Element Group Attributes

Country GBR United Kingdom
List Set RSLT_ADM Administrator Results
Effective Date 01/01/1990
Element Group Name RSLT ADM SUMM ACM Result Admin - Summ Accum

Element Group Attributes

Element Grid Summary Accumulators
Element Grid Title
Message Number

Element Grid Title Type
Message Set Number

Element Group Members and Attributes Personalize | Find | View All | First 1-10 of 15 Last

Attributes | Type and Description

| Element Name | Application Default Sort Seq | Column |
|------------------|------------------------------|----------|
| GBR AC GROSS SEG | 10 | Column 1 |
| GBR AC GRTX SEG | 20 | Column 1 |
| GBR AC NIBL SEG | 30 | Column 1 |
| GBR AC PENBL SEG | 40 | Column 1 |
| NI DD EES PTD | 80 | Column 1 |
| NI DD EES YTD | 80 | Column 2 |
| NI DD EESRBT PTD | 90 | Column 1 |
| NI DD EESRBT YTD | 90 | Column 2 |
| NI DD ERS PTD | 100 | Column 1 |
| NI DD ERS YTD | 100 | Column 2 |

The fields available on this page depend upon the values selected on the Define Application page. The system refreshes the values on this page each time you access it, in order to account for any changes at the element group level.

Each time you access the page, the system:

- Brings in any new elements that are members of the defined element group, along with their default attribute values.
- Removes any elements that are no longer members of the defined element group.

Use this page to define more specifically where and how the details for each element group appear in components, reports, and processes that use this list set.

Element Group Attributes

All of the fields in the Element Group Attributes group box are user-defined and come from the setup on the Define Application page. For example, the **Element Grid** field in the previous exhibit was defined on the Define Application page using the **Attribute Control, Description, and Values** fields. In the following exhibit, you can see that the **Element Grid** field was set up with valid values of *Summary Accumulators, Supporting Elements, Earnings Deductions, Accumulators, Absence Daily Data, Generated Positive Input, and Absence Accumulators*.

This example illustrates the fields and controls on the Example of the setup source for the Element Group Attributes group box.

Define Values for Attribute

Country ALL

Application RSLT_ADM Administrator Results

Attribute Control Drop Down List

Description Element Grid

Values Personalize | Find | View All | |
First 1-7 of 7 Last

| *Value | *Description | | |
|--------|--------------------------|--|--|
| 01 | Summary Accumulators | | |
| 02 | Supporting Elements | | |
| 03 | Earnings Deductions | | |
| 04 | Accumulators | | |
| 05 | Absence Daily Data | | |
| 06 | Generated Positive Input | | |
| 07 | Absence Accumulators | | |

OK Cancel

Element Group Members and Attributes

Each element that is a member of the element group appears in the Element Name column on the Element Group Attributes page. Then, based on settings from the Define Application page setup, you can specify details for reach. For example, the Column header on the Attributes tab of the Element Group Attributes page comes from the **Attribute Control** and **Description** fields on the Define Application page.

This example illustrates the fields and controls on the Element Group Attributes page.

Element Personalize | Find | |
First 1 of 1 Last

| *Attribute Control | *Description | | Default Value |
|--------------------|--------------|--------|---------------|
| Drop Down List | Column | Values | 10 |

The available values under the **Column** header on the Attributes tab of the Element Group Attributes page comes from the corresponding **Define Values for Attribute** page.

This example illustrates the fields and controls on the Example of the setup source for the field values in the Element Group Members and Attributes group box.

The screenshot shows a dialog box titled "Define Values for Attribute". It contains the following configuration:

- Country: ALL
- Application: RSLT_ADM Administrator Results
- Attribute Control: Drop Down List
- Description: Column

Below the configuration is a table with two columns: *Value and *Description. The table contains two rows of data:

| *Value | *Description | | |
|--------|--------------|------|---|
| 10 | Column 1 | +... | - |
| 20 | Column 2 | +... | - |

At the bottom of the dialog are "OK" and "Cancel" buttons.

Type and Description

Access the Type and Description tab.

This example illustrates the fields and controls on the Element Group Attributes page: Type and Description tab.

Element Group Attributes

Country GBR United Kingdom
 List Set RSLT_ADM Administrator Results
 Effective Date 01/01/1990
 Element Group Name RSLT ADM SUMM ACM Result Admin - Summ Accumus

Element Group Attributes

Element Grid Summary Accumulators Element Grid Title Type
 Element Grid Title Message Set Number

Element Group Members and Attributes Personalize | Find | View All | First 1-10 of 15 Last

Attributes **Type and Description**

| Element Name | Element Type | Description |
|------------------|--------------|-------------------------------|
| GBR AC GROSS SEG | Accumulator | Gross Pay Segment |
| GBR AC GRTX SEG | Accumulator | Generic Gross taxable Segment |
| GBR AC NIBL SEG | Accumulator | Generic Niable Pay SEG |
| GBR AC PENBL SEG | Accumulator | Pensionable Pay this Run |
| NI DD EES PTD | Accumulator | NI Employees Deds |
| NI DD EES YTD | Accumulator | NI Employees Deds |
| NI DD EESRBT PTD | Accumulator | NI Employees Rebate |
| NI DD EESRBT YTD | Accumulator | NI Employees Rebate |
| NI DD ERS PTD | Accumulator | NI Employers Deds |
| NI DD ERS YTD | Accumulator | NI Employers Deds |

On this tab you can view the element type and description values for each element. These values come from the element setup. The description is what appears in the component, report, or process that you configure using this list set.

Using the Utilities

Understanding the Absence Management Utilities

This topic discusses:

- Utility usage guidelines.
- The packaging and upgrading processes.
- Base and related languages.
- The versioning functions.
- The delete functions.
- The process of connecting UNIX and NT directories.

Common Terms Used in This Documentation

| <i>Field or Control</i> | <i>Description</i> |
|-------------------------|---|
| Element Map | <p>Depicts the relationships between the elements in your database.</p> <p>The element map plays a critical role in packaging and moving elements and data to other databases. Because the map must be current and accurate when you create packages, the system rebuilds it when you start the process that creates rule packages. During mapping, the system validates that the defined fields exist in the records.</p> <hr/> <p>Note: Mapping includes PIN-level records only. You must include those records that don't have a PIN number as the primary key in order to use the non-rule packager.</p> |
| Focus Element | The focal point of a process or action. |
| Non-rule | Non-rule data includes processing results, payee data, setup definitions, and other data where PIN_NUM isn't the primary key. |
| Package Status | Click this link to access the Package Status page. |

| Field or Control | Description |
|--|---|
| PIN Code (pay item name code) | The only element attribute that must be unique across databases. Like a PIN number, it's automatically assigned to every element, those delivered by PeopleSoft and those you create. The Code consists of the element name plus the suffix <i>ALL</i> if the element is used by all countries, or a three-character country code if the element is used by one country—for example, BASE ALL or BASE ITA. When you move elements between databases, the system compares the elements that you're exporting with those in the target database. PIN code is one of the attributes that the system checks when comparing elements. |
| PIN Number (pay item name number) | This number is a pointer back to a PIN name-related data in GP_PIN, and other tables. It is generated and assigned to every element, those delivered by PeopleSoft and those you create. Absence Management programs access and process elements by referring to their PIN numbers (PIN_NUM), not their names. PIN numbers are assigned sequentially in a given database, meaning that the same element can have different PIN numbers in different databases. So when you move elements between databases, the utilities don't rely on the PIN number to determine if the source elements that you're copying exist in the target database. |
| Rule | In Absence Management a rule is an element or combination of elements used to define a business rule. For example, an entitlement or take rule, or a count or rounding rule. The primary key for rule-definition tables is PIN_NUM. |
| Target PIN Number (target pay item name number) | The element's PIN number in the target database. |
| Upgrading | This process consists of copying items from a source database to a target database; comparing the copied items with items already in the target database; overlaying items in the target database or adding new items, depending on the comparison results; and deleting selected items from the target database. |
| Source Database | The database containing the rule or non-rule elements that you are packaging from and moving into the target database. |
| Target Database | The database into which you are moving the packaged rule or non-rule elements from the source database. |

Related Links

[Why the Core Application Uses Element Name Number \(PIN\) Processing](#)

Utility Usage Guidelines

Absence Management provides a suite of integrated tools for implementing and maintaining the elements that define your absence rules. You can use these utilities to view the relationships between elements, package and move elements and data between databases, and delete elements. When implementing your absence system, you can use the utilities to move all or selected rules that you've created and tested into your production database. In an existing system, these utilities streamline the process of introducing new rules, installing system updates, and moving processing results and absence data to other databases.

Here are some guidelines for using the utilities:

- Operations involving the utilities can have a significant impact on the system, so anyone using these tools must be very familiar with Absence Management.
- Source and target databases must use the same PeopleTools release.

The source and target databases used by the non-rule packager must share the same base language.

- Do not change the PIN_CODE in the Absence Management language table (GP_PIN_LANG).

Doing so can affect your ability to move elements.

- The utilities shouldn't be used during an absence run or while online work is being performed, but rather after business hours.
- *You can import only one package at a time.*

Warning! Attempting to import more than one package at a time could result in the loss of critical data.

The Packaging and Upgrading Processes

To move rules and data between databases, you use several utilities in a specific sequence.

This illustration shows the typical sequence for using the utilities to move rules and data between databases.

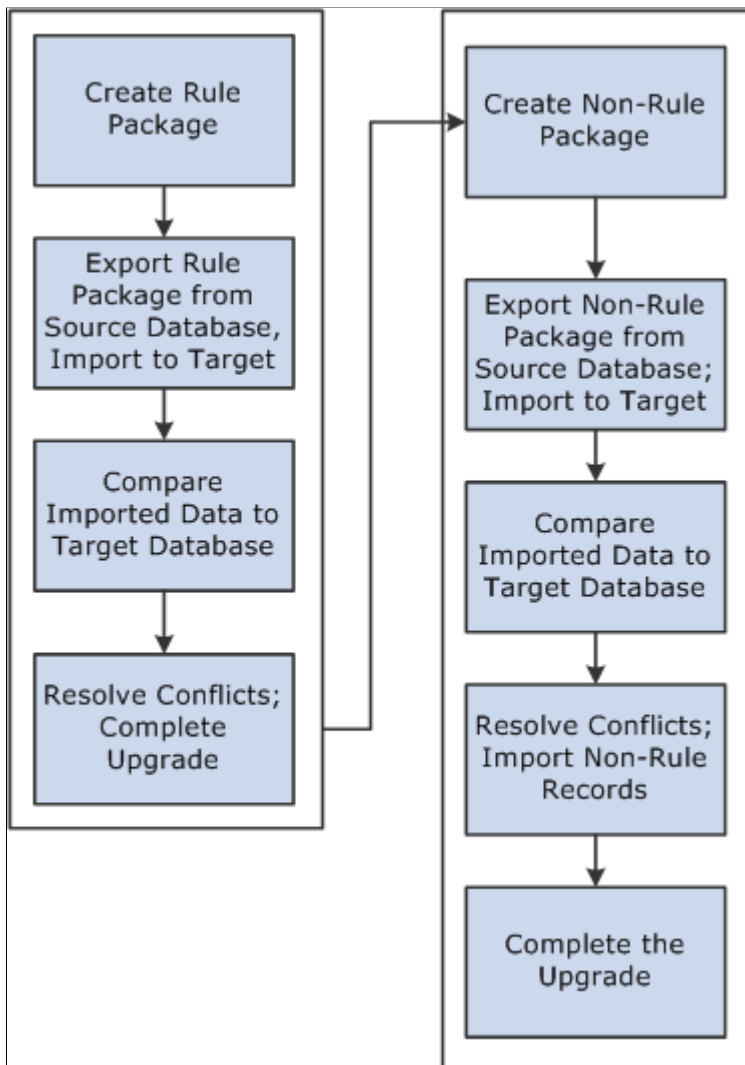

To move rules and data between databases:

1. Create and upgrade a rule package.

A rule package contains elements that are defined in records with PIN_NUM as the primary key. You use the Create/Export Rule Package and Apply Rule Package components to package and upgrade the elements you want to move. You can select individual elements for a package by name or by attribute, or you can select elements based on their version number. You tell the system whether you want to include only the focus elements or the focus elements plus the elements the focus elements use, based on the element map.

You can direct the system to delete or upgrade elements in the target database. A batch process creates a package of elements that you can view online.

After creating a package, you export it from the source database and import it into the target database; the system adds 50 000 000 to the value of each PIN number in the package to avoid overwriting elements in the target database that have matching PIN numbers.

An batch compare process follows, in which the system compares the packaged elements with those in the target database. The goal is to determine which elements are new to the target database, which match elements that exist in the database, and which need deleting according to your instructions. Elements that are new to the target database are assigned the next PIN number.

After reviewing the results of the comparison and resolving conflicts, you complete the upgrade process.

2. Create and upgrade a non-rule package.

Non-rule packages contain data from records where PIN_NUM is *not* the primary key—plus information about related elements.

To create a non-rule package:

- a. Define the criteria for creating the package of data to move.
- b. Export the non-rule data and element information from the source database.
- c. Import information for the elements (not the elements themselves) into the target database.
- d. Run a compare process that compares the packaged elements with those in the target database and identifies conflicts to address before importing non-rule data.
- e. Import the non-rule data and start an upgrade process that renumbers the PINs in the non-rule data records that were moved to the target database.

For example, imagine that the absence results record (GP RSLT ABS) contains a take element with a PIN number of 1333 on the source database. The element was moved to the target database, and because it matches (based on PIN code) an element in the target database with PIN number 3453, the non-rule packager renumbers the PIN number in the absence results record.

Base and Related Languages

In the case of rule packages, the source and target database need not have the same base language. The rule packager, using Data Mover functionality, can identify the base language in the target database and use the correct language from either the base or related language table if that language existed in the source package. Additionally, the rule packager also creates a related language entry on the target database for the source database's base language. Consider the following example:

A German (DEU) target database contains the following data:

Base Data

| <i>PIN_NUM</i> | <i>PIN_CODE</i> | <i>Translatable Data</i> | <i>Non translatable Data</i> |
|-----------------------|------------------------|-----------------------------------|--|
| 701 | GP_TEMP001_DEU | Current German Text content | Current values on the target database |

You create a package from an English (ENG) source database copying PIN_CODE GP_TEMP001 for base language only. The system:

- Exports a data file containing information for PIN_CODE GP_TEMP001 from the ENG database.

The data file contains the new PIN_NUM of 50 000 701.

- Imports the data file to the target database.

Upon import, DataMover automatically creates a related language row with a language code of ENG.

The German target database now looks like this:

| PIN_NUM | PIN_CODE | Translatable Data | Non translatable Data |
|----------------|-----------------|--------------------------|---------------------------------------|
| 701 | GP_TEMP001_DEU | CONTENT | Current values on the target database |
| 50 000 701 | GP_TEMP001_DEU | TAKE | New values from the source database |

Related Language Data

| PIN_NUM | PIN_CODE | LANGUAGE_CD | Translatable Data |
|----------------|-----------------|--------------------|--------------------------|
| 50 000 701 | GP_TEMP001_DEU | ENG | TAKE |

The system then:

- Connects 50 000 701 with 701 using the PIN_CODE.
- Copies the DEU translatable fields from 701 to 50 000 701.
- Deletes the original PIN_NUM 701.
- Renumbers the new rows with the PIN_NUM of the target database.

The result of the process is updated information on the base table and a new ENG entry on the related language table, as shown below.

Base Table

| PIN_NUM | PIN_CODE | Translatable Data | Non translatable Data |
|----------------|-----------------|--------------------------|-------------------------------------|
| 701 | GP_TEMP001 DEU | CONTENT | New values from the source database |

Related Language Table

| <i>PIN_NUM</i> | <i>PIN_CODE</i> | <i>LANGUAGE_CD</i> | <i>Translatable Data</i> |
|----------------|-----------------|--------------------|--------------------------|
| 701 | GP_TEMP001 DEU | ENG | TAKE |

Had the package been defined as both *base* and *related languages*, the swapping of languages to some extent would already have been completed by datamover during the package import (if a related language row for the language of the target database was part of the package.) This would result in overlaying translatable fields of the base row with the contents of the copied language row. If only the related language was copied with the package, the process is the same as described above, except for translatable fields of the base row of the target database, which would be updated to contain the values of the moved language row.

The Versioning Functions

You can use the versioning utilities of Absence Management to assign a version number to elements, and then have the system package only elements with this version number. Having created a package by version, you can move it to another database. In this case, the system moves changes from element definitions or component records.

Version-based packages only pull data from the database base language table, not from the Pay Item Names — Related Language table (GP_PIN_LANG). The only way to move related language information from GP_PIN_LANG is to use a regular rule package.

The Delete Functions

To delete rules from the target or source database, you can enter instructions for deleting elements when defining the selection criteria for a package. To preserve the integrity of your data, you can delete an element only if it's not associated with other data. That is, the element being deleted must meet all the following conditions:

- Not used in a result table.
- Not associated with payee data.
- Not linked to a non-rule table.
- Not used by another element.
- Not created by the PeopleSoft system.

Important! PeopleSoft recommends that you place elements to be deleted in a separate package from elements that you want to move from the source to the target database.

Related Links

[Define Criteria By Attribute Page](#)

The Process of Connecting UNIX and NT Directories

If your application runs on UNIX, exporting and importing packages involves additional considerations. You can create data mover scripts on the UNIX machine, but the data mover used for importing and exporting packages can only be run through an NT Process Scheduler.

Important! Any job or process that uses data mover in a UNIX environment *must* run on an NT Process Scheduler.

Because UNIX and NT reference directories differently, you must define a shared directory that can be accessed by both platforms. In order to do so, the same paths must be mounted on both platforms. The path name must be defined identically on both machines. For example, we have defined the following directory structure to store datamover files:

- NT system: \\xx-xxx\hcm\datamover\
- UNIX system: /xx-xxx/hcm/datamover/

When you specify the path names before creating scripts, importing packages, or exporting packages, you must always use the NT notation including the double back slash. PeopleCode automatically transcribes the path name to the appropriate platform notation when needed.

Important! You *must* add the location of your scripts to the psprcs.cfg file in the NT Process Scheduler. You should verify that the section marked *[Data Mover]* has the Input and Output paths pointed to the same drive.

Defining Element Relationships

To define element relationships, use the Define Element Relationships (GP_PIN_FLD_MAP1) component.

The Define Element Relationships utility builds an element map that shows how elements with PIN numbers are related. It defines the relationship between elements, and enables packager to determine if elements are used in non-rule data, which is important when deleting elements and packaging non-rule data.

Although the packager process rebuilds the map when you create a rule package, we recommend that you rebuild the map when you define new elements, change existing elements, or delete elements. It's also advisable to rebuild the map for the target database after completing an upgrade. This ensures that the map is current when displayed.

Pages Used to Define Element Relationships

| <i>Page Name</i> | <i>Definition Name</i> | <i>Usage</i> |
|-----------------------------------|------------------------|---|
| Define/Build Page | GP_PIN_FLD_MAP | Start the GP_PINMAP process, which rebuilds element maps. View which records contain fields that store PIN numbers. You can add and delete records that you've created to the rule map. |
| Validation Page | GP_PIN_FLD_MAP_ERR | Review for errors after rebuilding the element map. |

Related Links

[Adding Records to an Element Map](#)

Define/Build Page

Use the Define/Build page (GP_PIN_FLD_MAP) to start the GP_PINMAP process, which rebuilds element maps.

View which records contain fields that store PIN numbers. You can add and delete records that you've created to the rule map.

Navigation:

Set Up HCM > Product Related > Global Payroll & Absence Mgmt > Elements > Define Element Relationships > Define/Build

This example illustrates the fields and controls on the Define/Build page.

The screenshot shows the 'Define/Build' page interface. At the top, there are tabs for 'Define/Build' and 'Validation'. Below the tabs, the 'Definition' section includes several configuration fields:

- *Record Type: Payee Data
- *Record: EMPL_REG_TC_BRA
- *Export Record: GPBR_NRP_ERR_VW
- *Effective Date Type: Begin - End Date
- *ADS Staging Record: GPBR_NRP_ERR_AD
- *Field Name: PIN_TAKE_NUM

 Below these fields, there are two summary tables:

- Fields Referencing Other Elements:** A table with columns for Field Name, Field Long Name, and Field Status. It lists 'PIN_TAKE_NUM' with the long name 'Absence Take' and status 'Valid'.
- Applicable Element Types:** A table with a column for Element Type, currently empty.

 At the bottom of the page, there are three buttons: 'Rebuild Effdt Element Map', 'Process Monitor', and 'Process Instance'.

This page only lists those records that contain elements (which store PIN numbers). PIN NUM is often the key to these records, though this is not always the case.

Note: You cannot edit this page if it displays information for a PeopleSoft-delivered object.

See [Adding Records to an Element Map](#).

| Field or Control | Description |
|-------------------------|---|
| Record Type | <p>Select a record type, which is the type of record that contains elements. Values are:</p> <p><i>Element Definition:</i> Records of this type define elements with a primary key of PIN_NUM. Examples: GP_ABS_TAKE (absence takes), GP_ARRAY arrays and GP_FORMULA (formulas).</p> <hr/> <p>Note: The Element Definition record type is used only by PeopleSoft.</p> <hr/> <p>Records that contain elements but don't define elements have one of the following record types:</p> <p><i>Set-up Definition:</i> These are records you define when you implement Absence Management. Examples: GP_ELIG_GRP_MBR (eligibility group member) and GP_RUN_TYPE_DTL (run type detail).</p> <p><i>Output Result Data:</i> These records contain calculation results. Examples: GP_RSLT_ACUM (accumulator results) and GP_RSLT_PIN.</p> <p><i>Payee Data:</i> These records contain payee-specific data. Examples: GP_ABS_EVENT (absence events) or GP_PYE_OVRD (payee overrides).</p> |
| Record | Displays the name of the record, containing one or more elements. |
| Export Record | Displays the name of the record that the system uses when exporting this data to another database. |

| Field or Control | Description |
|----------------------------|--|
| Effective Date Type | <p>Identifies whether the record is effective-dated. If this field is set incorrectly, the packager may fail.</p> <p><i>Effdt</i> (effective date): This is the default value. Indicates that the record is effective-dated. Example: GP_BRACKET.</p> <hr/> <p>Note: If you include in a package an element that has more than one effective-dated row, the system tries to match each row when comparing the source elements with the target database. If it finds a match, it replaces the row in the target database; if it doesn't find a match, it adds the row to the target database. And if a row in the target database has no match, the system leaves the row in the target database unchanged.</p> <hr/> <p><i>No Effdt</i> (not effective-dated): Indicates that the record doesn't have an effective date. Example: GP_ARRAY.</p> <hr/> <p>Note: If you include in a package an element with no effective date, the system replaces all data for that element in the target database when you upgrade the package.</p> <hr/> <p><i>Begin – End</i>: Indicates that the record isn't effective-dated but contains begin and end dates. Example: GP_ACM_MBR.</p> <hr/> <p>Note: If you include in a package an element with begin and end dates, the system replaces all data for that element in the target database when you upgrade the package.</p> |
| Field Name | <p>Displays the name of the field in the record that contains other PIN number elements.</p> <p>For a record type of <i>Element Definition</i>, the system displays the name of the key field (PIN_NUM).</p> |

Fields Referencing Other Elements

This group box displays all fields that store the PIN numbers of (member) elements that are used by the record/field combination at the top of the page.

The sample page displays information for GP_ERN_DED, the record that defines earning and deduction elements. This record can use up to 17 elements. PIN_AMT_NUM and PIN_BASE_NUM are some of the fields that store PIN numbers of member elements. For example, PIN_BASE_NUM identifies the element that returns the base amount. To resolve an earning or deduction element, the system must know the PIN numbers of elements that store the amount, base, generation control instructions, and so on.

| Field or Control | Description |
|-------------------------|---|
| Field Name | Displays the name of the field that stores a member element's PIN number. |

| Field or Control | Description |
|-------------------------|--|
| Field Long Name | Displays the long name of the field. |
| Field Status | <p>Displays the field's status. Values are:</p> <p><i>Valid:</i> Indicates that the field in the record existed when the element map was last rebuilt.</p> <p><i>Invalid:</i> Indicates that a field has been renamed or removed from the record, or that the record no longer exists. The system flags invalid fields when you rebuild the element map.</p> |

Applicable Element Types

When the record type is *Element Definition*, this group box identifies the corresponding element types.

| Field or Control | Description |
|--|--|
| Element Type | Important when packaging elements. The element type that you select when creating a package gives the system information needed to select rows from the appropriate record. |
| Rebuild Effdt Element Map (rebuild effective-dated element map) | <p>Click to start the rebuild process. If the system cannot build the element map because of errors, this message appears on the page: "Effdt Element Map hasn't been built. Please check Validation page for errors."</p> <hr/> <p>Note: If the rebuild process is unsuccessful, an error message also appears in the message log.</p> <hr/> |

Validation Page

Use the Validation page (GP_PIN_FLD_MAP_ERR) to review for errors after rebuilding the element map.

Navigation:

Set Up HCM > Product Related > Global Payroll & Absence Mgmt > Elements > Define Element Relationships > Validation

This example illustrates the fields and controls on the Validation page.

| Status | Record (Table) Name | PIN Nbr Fieldname | Field Name | Message |
|--------|---------------------|-------------------|------------|---------|
| | | | | |

Review this page for errors generated by the rebuild process.

| Field or Control | Description |
|--|---|
| Status | Displays <i>Invalid</i> if an error occurred. Usually means that a field has been renamed or removed from the record, or that the record no longer exists. If this is a PS Delivered/Maintained (PeopleSoft system delivered/maintained) record, contact the PeopleSoft support. If the error involves a record that you created, check the record to make sure all the fields are still valid. |
| Record (Table) Name | Identifies the record that contained the invalid field. |
| PIN Num Fieldname (pay item name number field name) | Displays the name of the field that appears in the Field Name field at the top of the Define/Build page. |
| Field Name | Displays the field name that no longer exists in the record but appears on the Define/Build page. |
| Message | Displays an error message pertaining to the specific field. |

Adding Records to an Element Map

The procedure of adding records to an element map depends on the record's main (first) key:

- If the main key is PIN_NUM, the record type is *Element Definition*, (also called Rule Definition).

Note: Rule definitions are created only by PeopleSoft.

- If the main key is not PIN_NUM, the record type is *Output Result Data*, *Payee Data*, or *Set Up Definition*, depending on its purpose.

This topic discusses how to add non-rules to an element map.

Adding Non-Rules to an Element Map

This section describes the procedure for adding non-rule definitions to an element map, where the record's main key is not PIN_NUM.

To add a non-rule to an element map:

1. Use PeopleTools to create a SQL view for the record.

The view must have the same structure as your new record, as illustrated in the following example.

In the Select statement, enter + 50 000 000 after each field in the record that references a PIN number.

2. On the Define/Build page, add a row for the new record.
3. Complete these fields on the Define/Build page:
 - a. For **Record Type**, select *Output Result Data, Payee Data, or Set up Definition*.
 - b. For **Record**, select your new record.
 - c. For **Export Record**, select the view that you created in step 1.
 - d. For **Effective Date Type**, select the appropriate value for the record.
 - e. For **Field Name**, select any field in the record that references PIN_NUM.
 - f. In the **Fields Referencing Other Elements** group box, list each field within your record that contains a PIN number.

This includes the field name defined in step e. You can select only PIN_NUM.

Example

This illustration shows how your SQL statement should match the record structure.

| Record Fields | | Record Type | | | | | |
|---------------|----------------------|-------------|------|--------|--------------|-----------------------|--|
| Num | Field Name | Type | Len | Format | Short Name | Long Name | |
| 1 | EMPLID | Char | 11 | Upper | ID | EmplID | |
| 2 | EMPL_RCD | Nbr | 3 | | Empl Rcd# | Empl Rcd Nbr | |
| 3 | PIN_NUM | Nbr | 8 | | PIN Number | PIN Number | |
| 4 | BGN_DT | Date | 10 | | Begin Date | Begin Date | |
| 5 | PIN_SOVR_NUM | Nbr | 8 | | Supp Ovr PIN | Supp Element PIN numb | |
| 6 | END_DT | Date | 10 | | End Date | End Date | |
| 7 | ENTRY_TYPE_SOVR | Char | 3 | Upper | Element Type | Element Entry Type | |
| 8 | SOVR_VAL_CHAR | Char | 25 | Upper | Value | Character Value | |
| 9 | SOVR_VAL_NUM | Sign | 12.6 | | Value | Numeric Value | |
| 10 | SOVR_VAL_DT | Date | 10 | | Value | Date Value | |

```
SELECT EMPLID
,EMPL_RCD
,PIN_NUM + 50000000
,BGN_DT
,PIN_SOVR_NUM + 50000000
,END_DT
,ENTRY_TYPE_SOVR
```

```
, SOVR_VAL_CHAR
, SOVR_VAL_NUM
, SOVR_VAL_DT
FROM PS_GP_PYE_OVR_SOVR
```

Viewing Element Relationships

You can use the View Element Relationships utility to view hierarchical maps, including a map that existed as of a specific date.

Pages Used to View Element Relationships

| <i>Page Name</i> | <i>Definition Name</i> | <i>Usage</i> |
|------------------------------|------------------------|--|
| Uses Page | GP_PINTREE_EFFDT | View a map of elements that a focus element uses. The element relationship map must be built before the data is displayed. |
| Used By Page | GP_PINTREE_EFFDT2 | View elements that use the focus element. |

Uses Page

Use the Uses page (GP_PINTREE_EFFDT) to view a map of elements that a focus element uses.

The element relationship map must be built before the data is displayed.

Navigation:

Set Up HCM > Product Related > Global Payroll & Absence Mgmt > Elements > View Element Relationships > Uses

This example illustrates the fields and controls on the Uses page.

The screenshot displays the 'Uses' page interface. At the top, there are two tabs: 'Uses' (selected) and 'Used By'. Below the tabs, the 'Element Name' is 'K0WAE SICK', the 'Type' is 'Absence Entitlement', and the 'As Of Date' is '01/03/2014'. The main content area is divided into two sections: 'Element Uses' and 'Perspective'. The 'Element Uses' section contains a list of elements with expandable icons, including 'K0WAE SICK-Absence Entitlement', 'K0WFM SICK ENTITL-Formula', 'K0WPO SICK HOURS-Proration Rul', 'COMPANY-System Element', 'PAY ENTITY-System Element', 'GP PAYGROUUP-System Element', 'K0WAE SICK_BAL-Accumulator', 'K0WAE SICK_UNP-Auto Assigned C', and 'K0WAE SICK_UNAD-Auto Assigned'. The 'Perspective' section shows a dropdown menu for '*Perspective' set to 'Technical', and other fields: 'Type' AE, 'Name' K0WAE SICK, 'Description' Sick, 'Record', and 'Field'.

Element maps include fields that contain PIN_NUM only. So, when looking at the map for an entitlement element, you don't see fields for frequency, currency, and other non-element information.

| Field or Control | Description |
|-------------------------|---|
| Element Name | Displays the name of the element that you selected on the search page. This is the <i>focus</i> element. |
| Type | Displays the element type of the focus element. |
| As Of Date | To see the relationship map that was in effect on a specific date, enter the date in this field. |
| Element Uses | Click the element name to view its member elements. This information appears in a tree structure that expands or collapses as you click the + or – folder before an element name. |

Perspective

To see additional information on a related element, click the element name in the **Element Uses** group box and select a view in the **Perspective** field.

| Field or Control | Description |
|-------------------------|---|
| Perspective | Select the format for the data in this group box. Values are: <i>Functional</i> : Displays descriptive names of the data. <i>Technical</i> : Displays technical names for the data. |
| Type | <i>Functional</i> : Displays the name of the element type for the selected element. <i>Technical</i> : Displays the 2 character code of the element type for the selected element. |
| Name | Displays the name of the selected element. (The name is the same for the functional and technical views.) |
| Description | Displays the description of the selected element. (The description is the same for the functional and technical views.) |

| Field or Control | Description |
|-------------------------|--|
| Record | <p><i>Functional:</i> Displays the descriptive name of the record in which the selected element resides.</p> <p><i>Technical:</i> Displays the technical name of the record in which the selected element resides.</p> |
| Field | <p><i>Functional:</i> Displays the descriptive name of the field that stores the element's value.</p> <p><i>Technical:</i> Displays the technical name of the field that stores the element's value.</p> |

Used By Page

Use the Used By page (GP_PINTREE_EFFDT2) to view elements that use the focus element.

Navigation:

Set Up HCM > Product Related > Global Payroll & Absence Mgmt > Elements > View Element Relationships > Used By

This example illustrates the fields and controls on the Used By page.

This page resembles the Uses page but shows all elements that use the focus element.

Related Links

[Uses Page](#)

Creating and Exporting Rule Packages

Absence Management offers a streamlined package creation process that enables you to create rule packages, create import/export scripts, and export rule packages using a single component for both standard and version based rule packages. You can run each step in this process—from package creation, to script creation, to package export—as part of a continuous sequence of steps, or run one step at a time. The Absence Management system ensures that each step is complete before the next step begins, and displays the status of the package so that you can track your progress through the export process.

In addition, Absence Management enables you to specify a default location on the Installation Settings page for the scripts used in the import/export process so that you do not need to enter the same basic information each time you export a package.

Pages Used to Create and Export Rule Packages

| <i>Page Name</i> | <i>Definition Name</i> | <i>Usage</i> |
|--|------------------------|--|
| <u>Package Definition Page</u> | GP_PKG_DFN | Name a rule package and enter a description and comments. |
| <u>Define Criteria By Element Page</u> | GP_PKGCRIT_ELM_SEC | Define selection criteria for a package by element. |
| <u>Define Criteria By Attribute Page</u> | GP_PKGCRIT_ATR_SEC | Define selection criteria for a package by attribute. |
| <u>Define Criteria By Version Page</u> | GP_PKGCRIT_VER_SEC | Define selection criteria for a package by version. |
| <u>Where Clause Page</u> | GP_PKG_CRIT2_SEC | View and modify the SQL Where clause for the selection criteria defined on the Define Criteria By Version page. |
| <u>Package Processing Page</u> | GP_PKG_S_RUNCTL | <ul style="list-style-type: none"> • Package elements meeting the selection criteria you have defined. • Generate scripts for the export and import process. • Export packages. |
| <u>View Package Page</u> | GP_PKG_VIEW | View the elements in a rule package. View the action (upgrade or delete) that the system takes when you copy the package. You can cancel elements in the package. |
| <u>View Version Detail Page</u> | GP_PKG_VERDTL_SEC | View version details for a package by version. |

| Page Name | Definition Name | Usage |
|-------------------------------------|------------------------|---|
| Package Status Page | GP_PKG_DTTM_SEC | View the date and time a package was created, exported, imported, compared, and upgraded. |
| View Scripts Page | GP_PKG_SCRIPTS_SEC | View export, import, and cleanup scripts. |

Understanding How to Create and Export Rule Packages

To create and export a rule package:

Note: Rule packages can only include elements defined in records having PIN_NUM as the key.

1. Define criteria for selecting the elements in a rule package.

You can define different kinds of selection criteria:

- Use the Define Criteria By Element page of the Create/Export Rule Package (GP_PKG_CREXP) component to select elements for a package by name.
- Use the Define Criteria By Attribute page of the Create/Export Rule Package component to select elements by attribute (element type, owner, used by, class, category, country).

You can modify the SQL code that the system uses to select elements when you define criteria by attribute.

- Use the Define Criteria By Version page of this component to select elements for a package based on their version number.

You can specify criteria by element *and* by attribute for the same package. If you do this, the system selects all elements that meet the criteria specified on the Define Criteria By Element page *or* the Define Criteria By Attribute page.

You cannot define criteria by version for a package together with criteria by element and/or by attribute. Version criteria are exclusive of other selection criteria.

2. Run the create package process to package the elements meeting the selection criteria.

Do this on the Package Processing page of the Create/Export Rule Package component.

3. View the package and clear any elements that you do not want to move to the target database.

Do this on the View Package page of the Create/Export Rule Package component

4. Run the create scripts process.

Do this on the Package Processing page.

Note: The system generates three scripts for the export and import process: xxx_exp.dms (export script), xxx_imp.dms (import script), and gp_cleanup.dms (cleanup script), where xxx represents the name of the rule package.

- Review the scripts created in step 4 (above).

Do this on the View Scripts page of the Create/Export Rule Package component.

- Run the export package process.

Do this on the Package Processing page.

You must export the package before you can import it into the target database.

Note: This section represents the create rule package, create import/export scripts, and export rule package steps as separate, discrete processes; however, you can also run these steps as part of a single continuous process.

Warning! If you add or change an element after creating a package, you must recreate the package to include the element.

Package Definition Page

Use the Package Definition page (GP_PKG_DFN) to name a rule package and enter a description and comments.

Navigation:

Set Up HCM > Product Related > Global Payroll & Absence Mgmt > Elements > Manage Global Payroll Packages > Create/Export Rule Package > Package Definition

This example illustrates the fields and controls on the Package Definition page.

The screenshot shows the 'Package Definition' page with the following fields and controls:

- Package ID: CH16900D
- Version Based
- *Description: Swiss Rules Bundle 116900 Del
- Short Description: CH16900D
- Comment: Swiss Rules Bundle #1, 2003. 116900D Delete package.
- Define Criteria By Element
- Define Criteria by Attribute

Enter a description of the package and comments.

| Field or Control | Description |
|--------------------------------|--|
| Description and Comment | Enter a description of the package and comments. |

| <i>Field or Control</i> | <i>Description</i> |
|--|--|
| Version Based and Define Criteria By Version | <p>Select the Version Based check box to define a package using version criteria. By default, this check box is cleared.</p> <p>When you select this check box, the Define Criteria By Version link appears and the Define Criteria By Element and Define Criteria By Attribute Links disappear.</p> <p>Click the Define Criteria By Version link to access the Define Criteria By Version page, where you can specify the version of the elements that you want to include in the rule package.</p> |
| Define Criteria By Element | <p>Click to access the Define Criteria By Element page, where you can select elements to include in the package by name.</p> <hr/> <p>Note: When you specify the elements to include in the package on the Define Criteria By Element page and click OK, the check box in front of this link is automatically selected.</p> <hr/> |
| Define Criteria by Attribute | <p>Click to access the Define Criteria By Attribute page, where you can select elements to include in the package based on attributes of the elements.</p> <hr/> <p>Note: When you define element attributes on the Define Criteria By Attribute page and click OK, the check box in front of this link is automatically selected</p> <hr/> <p>Note: You cannot define version based criteria for a package together with element or attribute criteria, as these package types are mutually exclusive. The system provides the following controls to prevent this from occurring: After you define and save version criteria for a package, you cannot access the Define Criteria By Element or Define Criteria By Attribute pages to add element and attribute criteria. In addition, if you try to combine package types before saving your work—for example, you define a version based rule package and then try to define additional criteria by element or by attribute—all of the version criteria you have already entered will be deleted at save time and you will receive a warning message.</p> <hr/> |

Note: After you import a package, the **Define Criteria By Element**, **Define Criteria By Attribute**, and **Define Criteria By Version** links are disabled and you can no longer modify the selection criteria.

Define Criteria By Element Page

Use the Define Criteria By Element page (GP_PKGCRIT_ELM_SEC) to define selection criteria for a package by element.

Navigation:

Click **Define Criteria By Element** link on the Package Definition page.

This example illustrates the fields and controls on the Define Criteria By Element page.

Rule Package Criteria 1

Create/Export Rule Package

Define Criteria By Element

Package ID CH16900D Swiss Rules Bundle 116900 Del

Packaging Criteria - Element List

Personalize | Find | View 100 | | First 1-5 of 149 Last

| Entry Type | Element Name | Element Owner | *Include | *Language | *Action | |
|------------|----------------------|---------------|--------------------|---------------|---------|--|
| Rate Code | <input type="text"/> | | Focus Element Only | All(Base&Rel) | Delete | |
| Elem Group | <input type="text"/> | | Focus Element Only | All(Base&Rel) | Delete | |
| Elem Group | <input type="text"/> | | Focus Element Only | All(Base&Rel) | Delete | |
| Variable | <input type="text"/> | | Focus Element Only | All(Base&Rel) | Delete | |
| Elem Group | <input type="text"/> | | Focus Element Only | All(Base&Rel) | Delete | |

Packaging Criteria - Element List

| Field or Control | Description |
|-------------------------|---|
| Entry Type | Select the entry type for the element to include in the package. This determines which elements you can select in the Element Name field. |
| Element Name | In this required field, select the name of the element to include in the package. This element is referred to as the <i>focus</i> element. |
| Element Owner | Identifies who created the element that you selected in the Element Name field and who's responsible for maintaining it. Valid values are <i>Customer</i> , <i>Modified</i> , <i>PS Mnt</i> (PeopleSoft Maintained), <i>PS NonMnt</i> , and <i>PS Secure</i> . |

| Field or Control | Description |
|-------------------------|--|
| Include | <p>Select the elements to include in the package.</p> <p>Values are:</p> <p><i>Focus Element + Members</i>: The system includes focus elements (the elements in the Element Name field) as well as any member elements used by the focus elements (as depicted on the Uses page).</p> <p><i>Focus Element Only</i> (default): The system includes focus elements as well as any auto-generated components and accumulators. First level elements are selected as information only elements.</p> <hr/> <p>Warning! Select <i>Focus Element Only</i> only if you know that the target database contains all the member elements. If it doesn't, the system reports an error during the compare process.</p> <hr/> <p>Note: The system always includes information for the member elements in the package—even when you select <i>Focus Element Only</i>. Although the member elements aren't copied to the target database, the system uses the information to perform the Compare process described later in this documentation.</p> <hr/> |
| Language | <p>Specify whether to copy base and related language data to the target database.</p> <p>All fields on GP_PIN that are translatable have associated related language data. Related language data is stored on the related-language table for GP_PIN, GP_PIN_LANG.</p> <p>Valid values are:</p> <ul style="list-style-type: none"> • <i>All</i>: Add all language information to the package. • <i>Base</i>: Select to get only the base language data. • <i>Related</i>: Copy all language data related to the element but not for the element itself. |

| Field or Control | Description |
|-------------------------|--|
| Action | <p>Select the action the system should take with this element when upgrading the target database. Values are:</p> <p><i>Upgrade</i> (default): Adds the element to the target database or updates a matching element that's in the target database.</p> <p><i>Delete</i>: Deletes the element from the target database. (One database can be used as both the source and target database.)</p> <p>You cannot delete elements that meet any of the following conditions:</p> <ul style="list-style-type: none"> • Used in a results table. • Associated with payee data. • Linked to a non-rule table. • Used by another element. • Delivered by the PeopleSoft system. <hr/> <p>Note: You can delete the related language or all language information but not the base language alone. If you are deleting both a parent and a child element, you must still unhook the child from the parent.</p> <hr/> <p>Warning! PeopleSoft strongly recommends that you place deletes in a separate package from all other elements.</p> <hr/> |

Related Links

[Base and Related Languages](#)

Define Criteria By Attribute Page

Use the Define Criteria By Attribute page (GP_PKGCRIT_ATR_SEC) to define selection criteria for a package by attribute.

Navigation:

Click **Define Criteria By Attribute** link on the Package Definition page.

This example illustrates the fields and controls on the Define Criteria by Attribute page – Attribute Set1 tab.

Rule Package Criteria 2

Create/Export Rule Package

Define Criteria by Attribute

Package ID CH16900D Swiss Rules Bundle 116900 Del

Packaging Criteria - Element Attributes Personalize | Find | View All | [?] | [] First 1 of 1 Last

Attribute Set1 | Attribute Set2 []

| *Include | *Language | *Action | Element Type | Element Owner | | |
|--------------------|---------------|---------|--------------|---------------|--|-----|
| Focus Element Only | All(Base&Rel) | Upgrade | | | | + - |

This example illustrates the fields and controls on the Define Criteria by Attribute page – Attribute Set2 tab.

Rule Package Criteria 2

Create/Export Rule Package

Define Criteria by Attribute

Package ID CH16900D Swiss Rules Bundle 116900 Del

Packaging Criteria - Element Attributes Personalize | Find | View All | [?] | [] First 1 of 1 Last

Attribute Set1 | Attribute Set2 []

| Used By | Country | Category | Element Class | Where Clause Option | Show Where Clause | | |
|---------|---------|----------|---------------|--------------------------|-------------------|--|-----|
| | | | | Use Default WHERE Clause | Show Where Clause | | + - |

Attribute Set1

Select the Attribute Set1 tab.

| Field or Control | Description |
|-------------------------|---|
| Include | <p>Specify whether the package includes only focus elements (which meet the selection criteria on the Attribute Set1 tab) or also includes elements that are used by the focus elements.</p> <p>Values are <i>Focus Element + Members</i> and <i>Focus Element Only</i>.</p> <p><i>Focus Element + Members</i>: The system includes focus elements (in the Element Name field) as well as any member elements used by the focus elements (as depicted on the Element Relationship Uses page).</p> <p><i>Focus Element Only</i> (default): The system includes focus elements as well as any auto generated components and accumulators. First level elements are selected as information only elements. Information only elements are used by the focus element and its immediate children (if this information has not been previously selected).</p> <hr/> <p>Warning! Select <i>Focus Element Only</i> only if you know that the target database contains all the member elements. If it doesn't, the system reports an error during the compare process.</p> <hr/> <p>Note: The system always includes information for the member elements in the package—even when you select <i>Focus Element Only</i>. Although the member elements aren't copied to the target database, the system uses the information to perform the compare process described later in this documentation.</p> <hr/> |
| Language | <p>Specify whether to copy base and related language data for GP_PIN fields to the target database.</p> <p>All fields on GP_PIN that are translatable have related language data. This data is stored in the related-language table for GP_PIN, GP_PIN_LANG.</p> <p>Values are:</p> <ul style="list-style-type: none"> • <i>All</i>: Add all language information to the package. • <i>Base</i>: Select to get only the base language data. • <i>Related</i>: Copy all language data related to the element but not for the element itself. |

| Field or Control | Description |
|-------------------------|--|
| Action | <p>Select the action the system should take with this element when upgrading the target database. Values are:</p> <p><i>Upgrade</i> (default): Adds the element to the target database or updates a matching element that's in the target database.</p> <p><i>Delete</i>: Deletes the element information from the target.</p> <p>You cannot delete elements that meet any of the following conditions:</p> <ul style="list-style-type: none"> • Used in a results table. • Associated with payee data. • Linked to a non-rule table. • Used by another element. • Delivered by the PeopleSoft system. <hr/> <p>Note: You can delete the related language or all language information but not the base language alone. If you are deleting both a parent and a child element, you must still unhook the child from the parent.</p> <hr/> <p>Warning! PeopleSoft strongly recommends that you place deletes in a separate package from all other elements.</p> <hr/> |
| Element Type | Select the element type. |
| Element Owner | Select the element owner. Valid values are: <i>Customer</i> , <i>Modified</i> , <i>PS Mnt</i> , <i>PS Non-Mnt</i> , and <i>PS Secure</i> . |

Attribute Set2

Select the Attribute Set2 tab.

| Field or Control | Description |
|-------------------------|--|
| Used By | Select where elements are used. Valid values are <i>All Countries</i> (default) and <i>Specific Country</i> . If you select <i>Specific Country</i> , you must select the country in the Country field. |
| Country | Select the country's three-digit country code if you selected <i>Specific Country</i> in the Used By field. |

| Field or Control | Description |
|----------------------------|---|
| Category | To select only elements assigned to a particular category, select the category. (You assign a category to an element on the Element Name page.) |
| Element Class | Select the element class to package. (You assign an element class to an element on the Element Name page.) Valid values are: <i>Customary</i> , <i>Not Classified</i> , <i>Sample Data</i> , <i>Statutory</i> , and <i>System Data</i> . |
| Where Clause Option | The system converts the criteria entered on the Define Criteria by Attribute page into SQL in order to select elements for the package. Values are: <i>Use Default WHERE Clause</i> : Tells the system to use the default Where clause. If the where clause has been changed and <i>Use Default WHERE Clause</i> is selected again, the page discards any SQL code modifications you have made and reverts to the Where clause based on the criteria you specified. <i>Change WHERE Clause</i> : Makes all other fields on the page unavailable and puts the SQL code on the Where Clause page in edit mode. |
| Show Where Clause | Displays the Where Clause page, where you can view and alter the SQL code for your selection criteria. |

Related Links

[Define Criteria By Element Page](#)

[Understanding Security](#)

[Base and Related Languages](#)

Where Clause Page

Use the Where Clause page (GP_PKG_CRIT2_SEC) to view and modify the SQL Where clause for the selection criteria defined on the Define Criteria By Version page.

Navigation:

Click the **Show Where Clause** link on the Define Criteria By Attribute page – Attribute Set2 tab.

This example illustrates the fields and controls on the Where Clause page.

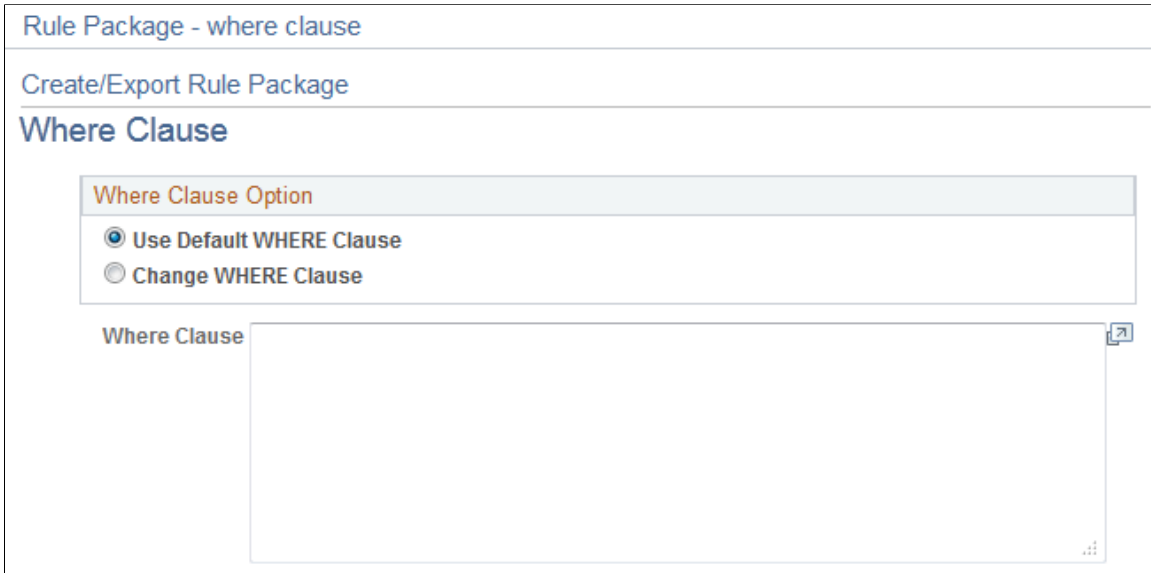

| Field or Control | Description |
|----------------------------|--|
| Where Clause Option | <p>Select <i>Use Default WHERE Clause</i> to use the default clause or revert to it after editing the SQL code. Any edits you make to the Where clause will be lost when you select <i>Use Default WHERE Clause</i>.</p> <p>Select <i>Change WHERE Clause</i> to make the code on the lower part of the page available for editing.</p> |
| Where Clause | <p>If you select <i>Use Default WHERE Clause</i> as the Where Clause Option, the system displays the Where clause of the SQL statement that it created based on the selection criteria defined on the Define Criteria by Attribute page. The Where clause is not editable.</p> <p>If you select <i>Change Where Clause</i>, you can edit the SQL Where clause. The following rules apply:</p> <ul style="list-style-type: none"> • Do not use PIN_NUM as a selection criterion or any field where PIN_NUM can be stored. (Doing so prevents renumbering during the import process.) • Add the prefix PS_GP_PIN to field names that you enter. Example: PS_GP_PIN.RECALC_IND. <hr/> <p>Note: When you Click OK and save, the system checks for the use of PIN_NUM, and looks for SQL syntax errors.</p> |

Define Criteria By Version Page

Use the Define Criteria By Version page (GP_PKGCRIT_VER_SEC) to define selection criteria for a package by version.

Navigation:

Select the **Version Based** check box on the Package Definition page and click the **Define Criteria By Version** link.

This example illustrates the fields and controls on the Define Criteria By Version page.

| Field or Control | Description |
|-------------------------|--|
| Used By | Select <i>All Countries</i> or <i>Specific Country</i> depending on whether you are defining version criteria for all countries or a single country. |
| Specific Country | If you select <i>Specific Country</i> in the Used By field, specify the country. |
| Version | Select the version of elements to include in the package. You can select multiple versions if they are for the same country. |

Package Processing Page

Use the Package Processing page (GP_PKG_S_RUNCTL) to .

Navigation:

Set Up HCM > Product Related > Global Payroll & Absence Mgmt > Elements > Manage Global Payroll Packages > Create/Export Rule Package > Package Processing

This example illustrates the fields and controls on the Package Processing page.

After defining selection criteria for a package, use the Package Processing page to:

- Create packages based on the selection criteria you have defined.
- Create scripts to use in the export and import process.
- Export packages to the target database.
- Track the status of a package.

During the export process, the system automatically adds 50 000 000 to the value of the PIN number assigned to each element so that it can distinguish the imported elements from elements that exist in the target database.

Processing Options

The check boxes under **Processing Options** display the status of the creation and export process. Status values are:

- *Created*: If this check box is selected, the package has been created.
- *Scripts Created*: If this check box is selected, scripts have been created for the package.
- *Exported*: If this check box is selected, the package has been exported to the target database.

| Field or Control | Description |
|-------------------------|---|
| Package Status | Click to access the Package Status page, where you can view the date and time packages and scripts were created, and see when packages were exported, imported, compared, and upgraded. |

Create Processing

| <i>Field or Control</i> | <i>Description</i> |
|-------------------------|---|
| Create Package | Select Create Package to have the program create the package based on the criteria, attributes, or version you have defined. |

Export Processing

| <i>Field or Control</i> | <i>Description</i> |
|-------------------------|---|
| Create Scripts | <p>Select Create Scripts to have the system to generate three scripts for the export and import process: xxx_exp.dms (export script), xxx_imp.dms (import script), and gp_cleanup.dms (cleanup script), where xxx represents the name of the rule package.</p> <p>This check box becomes available under the following conditions:</p> <ul style="list-style-type: none"> You select the Create Package check box. The package has already been created. <hr/> <p>Note: You must specify a path to the script location to generate a script.</p> <hr/> <p>Note: You can select Create Package and Create Scripts at the same time, and the system will generate the package and then create the export and import scripts. However, you cannot select Create Scripts before you generate the package.</p> <hr/> |

| Field or Control | Description |
|-------------------------|---|
| Script Location | <p>Specify the path to the location where you want the scripts to be created.</p> <p>This field becomes available when you:</p> <ul style="list-style-type: none"> • Select the Create Scripts check box. • Select the Export Package check box. • Have created the scripts for a package. <p>The location of the scripts and data files must be accessible by both the import and export NT Process Scheduler for the import and export databases. You must specify the script location in the Process Scheduler configuration file (psprcs.cfg).</p> <hr/> <p>Note: We discuss how to specify the script location in the Process Scheduler configuration file in the section titled <i>The Process of Connecting UNIX and NT Directories</i>.</p> <hr/> <p>See The Process of Connecting UNIX and NT Directories.</p> <hr/> <p>Note: You can define a default script location on the Installation Settings page for all packager scripts.</p> <hr/> <p>See Installation Settings Page.</p> |
| View Scripts | Click to access the View Scripts page, where you can review export and import scripts. |

| Field or Control | Description |
|-------------------------|--|
| Export Package | <p>Select Export Package to have the system export the package during processing.</p> <p>This field becomes available when you:</p> <ul style="list-style-type: none"> • Select the Create Package and Create Scripts check boxes. • Have created a package and then select the Create Scripts check box. • Have created the package and the scripts. <p>After exporting the package from the source database, you can import it into the target database using the Apply Rule Package (GP_PKG_APPLY) component.</p> <hr/> <p>Note: During the export process, the system automatically adds 50 000 000 to the value of the PIN number assigned to each element so that it can distinguish the imported elements from elements that exist in the target database.</p> <hr/> |

Process

Click the **Process** button to call and run the processes denoted by the check boxes you have selected: **Create Package, Create Scripts, and Export Package**. Note that you can select all three check boxes at the same time and run these processes as a single, continuous sequence, or run one process at a time. However, the processes must run in the order of create package first, then create scripts, then export package.

Note: When you click the Process button the Process Monitor page appears, so that you can monitor the process. Wait until the program finishes before opening a page associated with the package.

View Package Page

Use the View Package page (GP_PKG_VIEW) to view the elements in a rule package.

View the action (upgrade or delete) that the system takes when you copy the package. You can cancel elements in the package.

Navigation:

Set Up HCM > Product Related > Global Payroll & Absence Mgmt > Elements > Manage Global Payroll Packages > Create/Export Rule Package > View Package

This example illustrates the fields and controls on the View Package page.

| Package Definition | | Package Processing | | View Package | | | | | | | | | |
|--------------------|-------------------|--------------------|---------------|-------------------------------|--------------------------------|--------------------|--------------------------|-------------------|------|----------|-------|------------|------|
| Package ID | | CH16900D | | Swiss Rules Bundle 116900 Del | | | | | | | | | |
| Element List | | | | | | | | Personalize | Find | View 100 | First | 1-5 of 302 | Last |
| Country | Source PII Number | Element Name | Description | Element Type | Element Owner | Action | Upgrade | Language | | | | | |
| | 7 | ACTION | Action | SystemElem | PS Delivered/Maintained/Secure | Informational Only | <input type="checkbox"/> | All(Base&Related) | | | | | |
| | 9 | ACTION REASON | Reason Code | SystemElem | PS Delivered/Maintained/Secure | Informational Only | <input type="checkbox"/> | All(Base&Related) | | | | | |
| | 18 | ANNUAL RT | Annual Rate | SystemElem | PS Delivered/Maintained/Secure | Informational Only | <input type="checkbox"/> | All(Base&Related) | | | | | |
| | 31 | BUSINESS UNIT | Business Unit | SystemElem | PS Delivered/Maintained/Secure | Informational Only | <input type="checkbox"/> | All(Base&Related) | | | | | |
| | 34 | CITY | City | SystemElem | PS Delivered/Maintained/Secure | Informational Only | <input type="checkbox"/> | All(Base&Related) | | | | | |

After creating a package, you can view the elements in the package and individually select any elements that you do not want to export to the target database.

| Field or Control | Description |
|----------------------------|--|
| Action | Displays the action applicable to the element in your package. Values are: <i>Upgrade</i> , <i>Delete</i> , and <i>Info Only</i> . When deleting items, the source database and target database can be the same. |
| Upgrade | This check box is selected by default to include the element in the package for export. Clear it to exclude the element from the export. |
| View Version Detail | If the elements displayed on the View Package page are packaged by version, the View Version Detail link appears. Click this link to access the View Version Detail page, where you can view each element's version number and the database records (tables) containing the element definitions. |

View Version Detail Page

Use the View Version Detail page (GP_PKG_VERDTL_SEC) to view version details for a package by version.

Navigation:

Click the **View Version Detail** link on the View Package page for a package by version.

This example illustrates the fields and controls on the View Version Detail page.

| Package Details-Versioning | | | | | |
|----------------------------|--------------------|-----------------------------------|--|----------------|--------------|
| Create/Export Rule Package | | | | | |
| View Version Detail | | | | | |
| Package ID | | GIT8388R Upgrade 8.3 -> 8.8 Italy | | | |
| Country | | ITA Italy | | | |
| Package Elements (Detail) | | | Personalize Find View 100 First 1-5 of 8013 Last | | |
| PIN Number | Element Name | Description | Record (Table) Name | Effective Date | Version |
| 110001 | RTR AC LNODETR STD | Gross salary no reduct applied | GP_ACCUMULATOR | | P_8.80.00.00 |
| 110001 | RTR AC LNODETR STD | Gross salary no reduct applied | GP_ACM_MBR | | P_8.80.00.00 |
| 110001 | RTR AC LNODETR STD | Gross salary no reduct applied | GP_ELM_DFN_SOVR | | P_8.80.00.00 |
| 110001 | RTR AC LNODETR STD | Gross salary no reduct applied | GP_PIN | | P_8.80.00.00 |
| 110002 | RTR AC LORDO STD | Gross salary for reduction | GP_ACCUMULATOR | | P_8.80.00.00 |

For elements packaged by version, access the View Version Detail page to view each element's version number and the database records (tables) containing the element definitions.

Package Status Page

Use the Package Status page (GP_PKG_DTTM_SEC) to view the date and time a package was created, exported, imported, compared, and upgraded.

Navigation:

Click the **Package Status** link on the Package Processing page.

This example illustrates the fields and controls on the Package Status page.

| Package Status | |
|----------------------------|--|
| Create/Export Rule Package | |
| Package Status | |
| Package ID | CH16900D Swiss Rules Bundle 116900 Del |
| Created | Imported 08/08/2003 9:22:09PM |
| Scripts Created | Compared 08/08/2003 9:46:06PM |
| Exported | Upgraded 08/08/2003 9:54:17PM |

View the date and time packages and scripts were created, and see when packages were exported, imported, compared, and upgraded.

View Scripts Page

Use the View Scripts page (GP_PKG_SCRIPTS_SEC) to view export, import, and cleanup scripts.

Navigation:

Click the **View Scripts** link on the Package Processing page.

This example illustrates the fields and controls on the View Scripts page.

The screenshot shows a dialog box titled "Package Export Import Defns" with a sub-header "Create/Export Rule Package". The main section is "View Scripts". It displays "Package ID" as "DERULGER" and "Global Payroll DEU Rule Trans". The "*Script Location" is "c:\temp". Below this is a "Script Location example: C:\folder\". There is a "View Package Script" dropdown menu and a large "SQL Statement Text" area. At the bottom are "OK" and "Cancel" buttons.

| Field or Control | Description |
|----------------------------|--|
| Script Location | <p>Displays the script location, which must be accessible by both the import and export NT Process Scheduler for the import and export databases. You must specify the script location in the Process Scheduler configuration file (pspres.cfg).</p> <hr/> <p>Note: We discuss how to specify the script location in the Process Scheduler configuration file in the section titled <i>The Process of Connecting UNIX and NT Directories</i>.</p> <hr/> <p>See The Process of Connecting UNIX and NT Directories.</p> <hr/> <p>Note: You can define a default script location on the Installation Settings page for all packager scripts.</p> <hr/> <p>See Installation Settings Page.</p> |
| View Package Script | <p>Select the type of script that you want to view: export, import, or cleanup. The DataMover script appears.</p> |

Importing, Comparing, and Upgrading Rule Packages

Absence Management offers a streamlined package import and compare process that enables you to run the import, compare, and upgrade process using a single component for both standard and version based rule packages. You can run each step in this process—from package import, to comparison, to upgrade—as part of a continuous sequence of steps, or run one step at a time. The Absence Management system

ensures that each step is complete before the next one begins, and displays the status of the package so that you know exactly where you are in the process.

In addition, Absence Management enables you to specify default packager-related options on the Installation Settings page so that you do not need to enter the same basic information each time you run the import, compare, and upgrade process. Use the Installation Settings page to:

- Specify a default location for the scripts used in the import process.
- Specify compare report print options for standard and version based rule packages to control the type of information that appears in the compare report.
- Specify the conditions under which an upgrade is permitted—that is, you can elect to proceed with upgrades despite errors and warnings in the compare process, or choose not to allow upgrades containing errors or warnings.

See [Installation Settings Page](#).

Pages Used to Import, Compare, and Upgrade Rule Packages

| Page Name | Definition Name | Usage |
|--|------------------------|--|
| Package Definition Page | GP_PKG_DFN | View the description and package ID of a rule package. |
| Package Processing Page | GP_PKG_T_RUNCTL | <ul style="list-style-type: none"> • Import rule packages into the target database. • Run the Compare process and generate the Compare Report. • Run the Upgrade Process. |
| Package Elements Page | GP_PKG_ELEM_UPG | View the results of the Compare processes and exclude elements from the Upgrade process. |
| Package Compare Audit Page | GP_PKG_CMP_AUDIT | Review for errors that occur during the Compare process. Before continuing with the Upgrade process, correct the errors and rerun the Compare process. |
| Package Status Page | GP_PKG_DTTM_SEC | View the date and time a package was created, exported, imported, compared, and upgraded. |
| View Scripts Page | GP_PKG_SCRIPTS_SEC | View export, import, and cleanup scripts. |

Understanding Rule Package Imports, Comparisons, and Upgrades

After running the export process, use the Apply Rule Package (GP_PKG_APPLY) component to import the package into the target database, compare the rules in the source database to those in the target database, and upgrade the rule package.

To import, compare, and upgrade a rule package:

1. Run the import process on the Package Processing page of the Apply Rule Package component.
2. Compare the packaged elements with the elements in the target database by running the compare process and generating the compare report on the Package Processing page of the Apply Rule Package component. Generating the compare report is optional.

The system determines which elements are new to the target database, which update existing elements in the target database, and which need deleting from the target database.

3. Review the compare report and the results displayed on the Package Elements and Package Compare Audit pages of the Apply Rule Package component to determine the results of the compare process.

On the Package Elements page you can exclude elements from the upgrade process.

4. Resolve warnings and errors that are identified in the compare report, on the Package Elements page, and on the Package Compare Audit page during the compare process.

Warnings and errors can occur for several reasons. For example, the source element could use other elements that don't exist in the target database and are not included in your package or an element that you want to delete could be used in a results table. The corrective action depends on the type of error and warning.

5. Rerun the compare process on the Package Processing page after correcting errors or excluding elements from the package.
6. Run the upgrade process after deciding whether to proceed with errors and/or warnings.

Do this on the Package Processing page.

During the upgrade process the system:

- Updates the imported elements with the correct PIN number if they already exist in the database.
- Assigns new numbers to the new elements.
- Deletes rows according to the option chosen in the package.

You can run this process only once.

Note: This section presents the package import, comparison, and upgrade steps as separate, discrete processes; however, you can run these steps as part of a single continuous process.

Note: Before moving multiple elements simultaneously, it is recommended that you back up the target database.

What Happens During the Compare Process

For each exported element, the system looks for an element in the target database with the same PIN code, element type, and element owner.

This flowchart shows the logic that the system uses to perform the comparison and generate the resulting warning or error messages (flowchart 1).

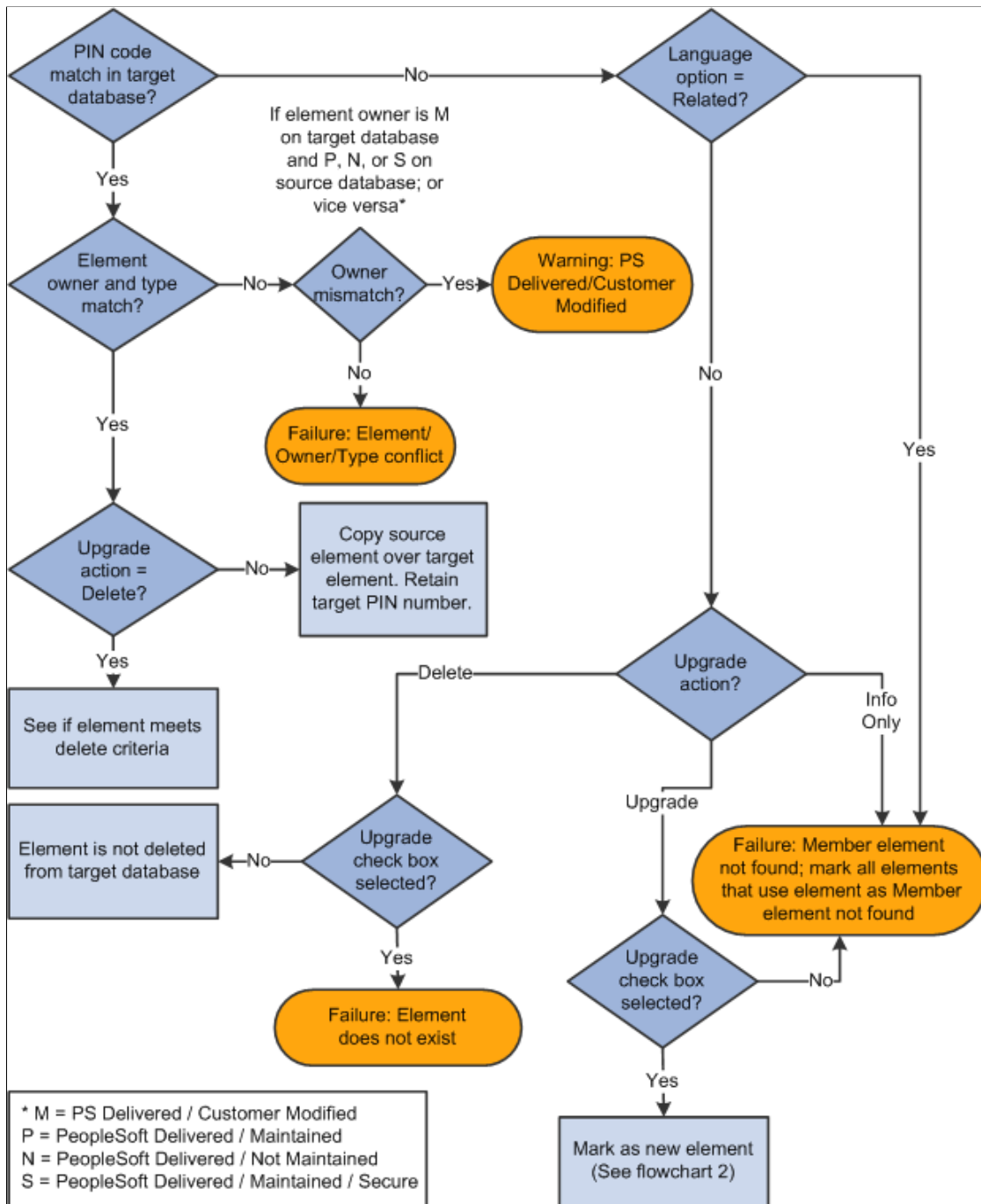

This flowchart shows the logic that the system uses to perform the comparison and generate the resulting warning or error messages (flowchart 2).

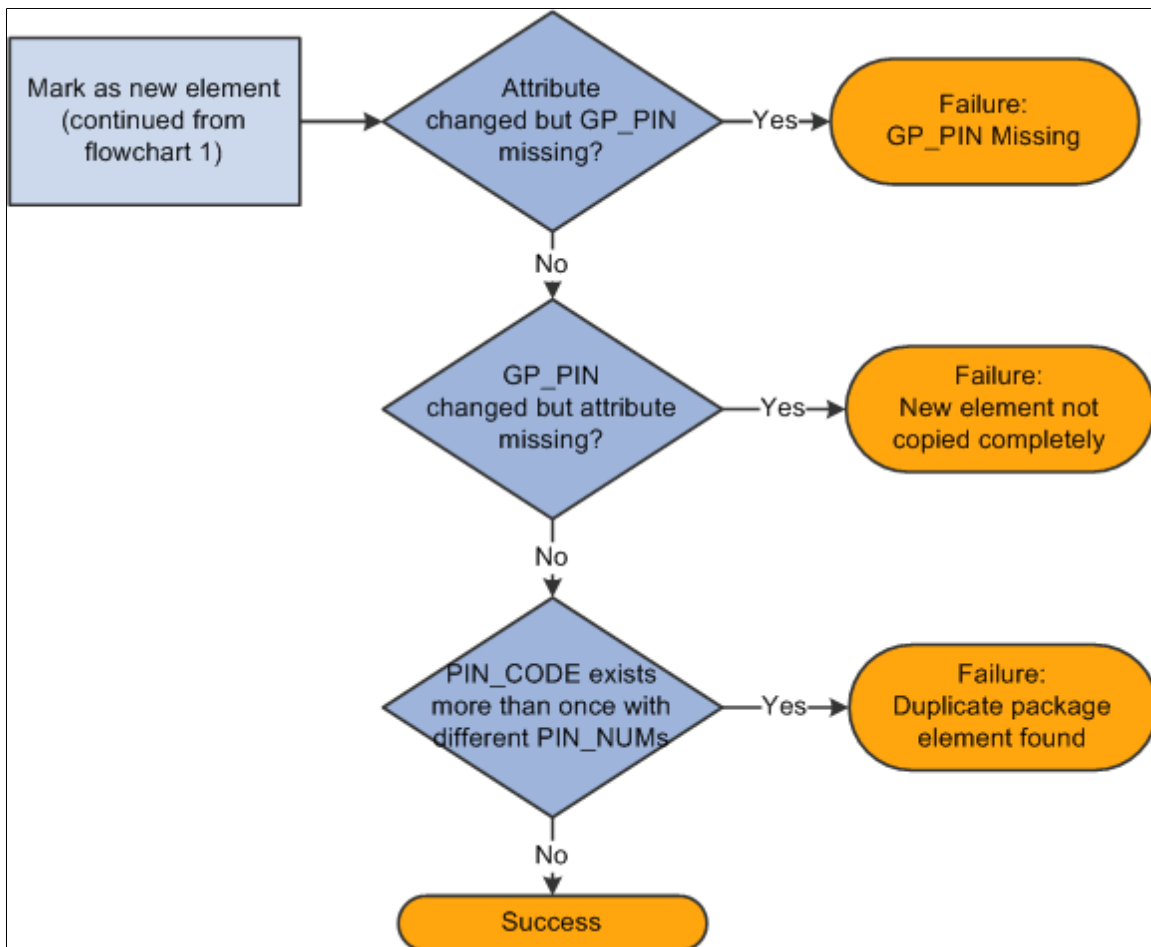

Warning! Upgrades override elements in the target database with the information that has been sent over from the source.

Important! When you upgrade an existing element, the system updates the matching element in the target database, but it does not delete member data unless there is new member data to replace it. For example, if you delete the last row of an existing formula in the source database and then export and apply a package to the target database, the child rows remain unchanged in the target database. Likewise, if you remove all child elements from the Generate Positive Input Member List for an absence take in the source database, the system does not remove the child elements from the same absence take in the target database.

Related Links

[The Delete Functions](#)

Running the Compare Report

You can generate a compare report while performing the compare process. The compare report enables you to see what elements the Rule Package will change on a field-by-field basis. Use this information to decide whether to upgrade a specific element.

The compare report creates a report displaying the affected elements and what the differences are between the elements in the Rule Package and the elements in the target database. The compare report can only be run at the same time as the compare process.

Compare Report Summary Page

The summary page is the first page of the compare report. It includes the following information:

- Type of rule package (regular or version based).
- Version of the elements included in the rule package if the package is version based.
- The names of the source and target databases.
- The date and time that the import and compare processes were run.
- The countries with elements included in the package.
- The total number of elements in each of these categories listed below, depending on the Compare Report Print Options selected on the Package Processing page:
 - Elements with errors/warnings.
 - Modified elements.
 - New elements.
 - Deleted elements.
 - Unchanged elements.

Note: These totals are for all of the elements in a package except those that are for information only, and are not separated by country. The exception to this rule is that the total for errors/warnings includes informational elements.

Compare Report Body

The body of the compare report consists of four columns. The columns and contents are described in the following table:

| Column | Contents |
|-----------------|---|
| Elements | <ul style="list-style-type: none"> • PIN code. • PIN type. • Upgrade action (either Upgrade, Delete, or Informational Only). • Upgrade (either Yes or No). • Compare status. • Error or Warning (if applicable). <hr/> <p>Note: Upgrade action, upgrade, compare status, and error or warning messages appear only on the Elements With Error/Warning Messages page of the report.</p> <hr/> |
| Record.Field | Record and field name for the values contained in the Source Database and Target Database columns. |
| Source Database | Data values that are moving from the source to the target database as part of the Rule Package for the applicable record or field name. |
| Target Database | Data values that are currently in the target database for the applicable record or field name. |

Note: Elements in the compare report are displayed based on the alphabetical order of their country codes. For example, elements for *CHE* (Switzerland) appear before elements for *DEU* (Germany). The country code *All* (Across All Countries) appears if there is an element in the package that is defined for *All* countries or is in error/warning status.

Elements Displayed in the Compare Report

The compare report is made up of different sections containing detailed information about different categories of elements:

- Elements with Errors or Warnings — All elements that have an error or warning message appear in this first section with basic information about the element (if it is available). All errors and warnings should be looked into and resolved before continuing the upgrade process.
- Modified Elements — This section is for modified elements and displays the rows (records and fields) that will be changed in an upgrade. If a new row of data is being added, it also appears in this section.

Important! The element definition tables for array, bracket, formula, fictitious calculation, and historical rule elements include a sequence number field. This field is not always displayed online and has a purely technical function; however, you may see these elements appearing in the compare report as *modified* due only to changes in their sequence number. This is expected, as the report provides a field-by-field comparison. If the report lists these elements as modified, you should determine whether fields and information other than sequence number have changed (as this is what is critical from a functional perspective). If only the sequence number has changed, there will be no functional impact from an upgrade to these elements.

Important! Rate Code elements are keyed by both PIN Number (PIN_NUM) and HR Compensation Rate Code (COMP_RATECD). As a result, if the HR Rate Code is changed in an element definition, you will see this displayed in the modified elements section of the compare report as a new row (with 2 key fields appearing) and a deleted row (with 2 key fields appearing).

- **New Elements** — This section is for new elements in the rule package (elements that are not in the target database), and displays the following fields from GP_PIN: PIN Code (as the key field); PIN_NM; DESCR; COMMENTS.
 - **Deleted Elements** — This section is for deleted elements, and displays the following fields from GP_PIN: PIN Code (as the key field); PIN_NM; DESCR; COMMENTS.
 - **Elements with no changes** — Only pin code and element name are displayed in this section.
-

Note: These report sections are displayed country by country in alphabetical order of the country codes. For example, report sections for CHE (Switzerland) appear before those for DEU (Germany). If you request a report section and there are no elements belonging to that category, the following message appears in that section of the compare report: "There are no elements that qualify for this section." For country code 'All' (Across All Countries), the report sections only print out if there are elements to report on. No page is printed if no elements exist for 'All' in the section—not even the message noted above appears. Country code 'All' pages always appear at the end of the report.

Note: For formulas, only the formula text is displayed, rather than details about each individual field. For all PIN Number fields, the compare report displays the corresponding PIN Code instead of the PIN Number.

Note: In the compare report, record information is printed in the following sort order: GP_PIN (if applicable), Parent Element Definition Record (if applicable), and Child Element Definition Records (if applicable). Within each of these records, the data displayed is sorted by effective-date descending (if effective date is in the record) and then by key fields ascending.

Package Definition Page

Use the Package Definition page (GP_PKG_DFN) to view the description and package ID of a rule package.

Navigation:

Set Up HCM > Product Related > Global Payroll & Absence Mgmt > Elements > Manage Global Payroll Packages > Apply Rule Package > Package Definition

This example illustrates the fields and controls on the Package Definition page.

| Package Definition | Package Processing | Package Elements | Package Compare Audit |
|--|--|---|-----------------------|
| Package ID | CH16900D | <input type="checkbox"/> Version Based | |
| Description | Swiss Rules Bundle 116900 Del | Short Description | CH16900D |
| Comment | Swiss Rules Bundle #1, 2003. 116900D Delete package. | | |
| <input checked="" type="checkbox"/> Define Criteria By Element | | <input type="checkbox"/> Define Criteria by Attribute | |

View the Package ID and description of the package you are comparing and upgrading.

Package Processing Page

Use the Package Processing page (GP_PKG_T_RUNCTL) to .

Navigation:

Set Up HCM > Product Related > Global Payroll & Absence Mgmt > Elements > Manage Global Payroll Packages > Apply Rule Package > Package Processing

Access this page from the *target* database.

This example illustrates the fields and controls on the Package Processing page.

The screenshot shows the 'Package Processing' page with the following elements:

- Tabs:** Package Definition, Package Processing (selected), Package Elements, Package Compare Audit.
- Package Information:** Package ID CH16900D, Swiss Rules Bundle 116900 Del, and a Process button.
- Processing Options:**
 - Imported
 - Compared
 - Upgraded
 - [Process Monitor](#)
 - [Package Status](#)
- Import Processing:**
 - Import Package
 - Import ADS Package
 - [View Scripts](#)
 - *Script Location:
 - Script Location example: C:\folder\
- Compare Processing:**
 - Compare Package
 - Create Compare Report
 - Update Statistics
 - Compare Report Print Options:**
 - Errors/Warnings
 - Modified
 - New
 - Deleted
 - Unchanged
- Upgrade Processing:**
 - Upgrade Package
 - Update Statistics
 - Continue Upgrade Processing:**
 - With Errors
 - With Warnings

Use this page to import, compare, and upgrade rule packages and to track the status of an upgrade.

Processing Options

The check boxes under **Processing Options** display the status of the upgrade. Status values are:

- *Imported:* If this check box is selected, the package has been imported into the target database.
- *Compared:* If this check box is selected, the elements in the package have been compared with those in the target database.
- *Upgraded:* If this check box is selected, the target database has been upgraded with the elements in the package.

| Field or Control | Description |
|-------------------------|---|
| Package Status | Click to access the Package Status page, where you can view the date and time packages and scripts were created, and see when packages were exported, imported, compared, and upgraded. |

Import Processing

| Field or Control | Description |
|-------------------------|---|
| Import Package | <p>Select Import Package to instruct the system to import the elements in the package into the target database during processing. You must specify a path to the scripts used to import the package.</p> <p>This check box is always enabled, regardless of whether the package has already been imported.</p> |
| Script Location | <p>Specify the path to the location where you want the scripts to be created.</p> <p>The location of the scripts and data files must be accessible by both the import and export NT Process Scheduler for the import and export databases. You must specify the script location in the Process Scheduler configuration file (psprcs.cfg).</p> <hr/> <p>Note: We discuss how to specify the script location in the Process Scheduler configuration file in the section titled <i>The Process of Connecting UNIX and NT Directories</i>.</p> <hr/> <p>See The Process of Connecting UNIX and NT Directories.</p> <hr/> <p>Note: You can define a default script location on the Installation Settings page for all packager scripts.</p> <hr/> <p>See Installation Settings Page.</p> |
| View Scripts | <p>Click to access the View Scripts page, where you can view the export, import, and cleanup scripts.</p> |

Compare Processing

| <i>Field or Control</i> | <i>Description</i> |
|--------------------------------|---|
| Compare Package | <p>Select Compare Package to have the system compare the imported elements with those in the target database during processing.</p> <p>This check box is enabled when:</p> <ul style="list-style-type: none"> • The package has already been imported but not upgraded. • You select the Import Package check box. <p>When the compare process is complete, check the Package Upgrade tab on the Package Elements tab and then review the Package Compare Audit page for errors.</p> |
| Create Compare Report | <p>Select to generate a report comparing elements in the rule package to the elements in the target database on a field-by-field basis.</p> <p>This check box is enabled when you select the Compare Package check box.</p> |
| Update Statistics | <p>Select to update statistics in the appropriate tables when running the compare process.</p> |

| Field or Control | Description |
|-------------------------------------|---|
| Compare Report Print Options | <p>These check boxes determine what data appears in the compare report.</p> <ul style="list-style-type: none"> • <i>Errors/Warnings</i>: Report includes all warning or errors that occur during the compare. The default setting for this check box is <i>on</i>. • <i>Modified</i>: Report includes packaged elements that are different from those in the target database. The default setting for this check box is <i>on</i>. • <i>New</i>: Report includes the new elements. The default setting for this check box is <i>off</i>. • <i>Deleted</i>: Report includes the elements selected for deletion. The default setting for this check box is <i>off</i>. • <i>Unchanged</i>: Report includes the elements that have not changed. The default setting for this check box is <i>off</i>. <hr/> <p>Note: You can set default print options for the compare report on the Installation Settings page. You can override these defaults when you run the compare process on the Package Processing page.</p> <hr/> <p>See Installation Settings Page.</p> |

Upgrade Processing

| Field or Control | Description |
|--------------------------|---|
| Upgrade Package | <p>Select Upgrade Package to have the system upgrade the target database with the elements in the package during processing.</p> <p>This check box is enabled when:</p> <ul style="list-style-type: none"> • The package has been compared but not upgraded. • You select the Compare Package check box. <p>This process upgrades only those elements that pass the compare process without errors. You can upgrade a package only once.</p> <hr/> <p>Note: The upgrade process will not be completed if there are errors or warnings—unless you select <i>upgrade with errors and/or warnings</i>. If you choose <i>not</i> to upgrade with errors and warnings and there is an error or a warning, the process monitor will show success but the message log will display one of the following messages:</p> <ol style="list-style-type: none"> 1. "The Upgrade process cannot continue because the compare process finished with some elements having a status of Error. Please see online 'Package Elements' page or review the 'Error/Warning' section of your report." <p><i>or</i></p> <ol style="list-style-type: none"> 2. "The Upgrade process cannot continue because the compare process finished with some elements having a status of Warning. Please see online 'Package Elements' page or review the 'Error/Warning' section of your report." <p>Even with the upgrade with errors and warnings check boxes selected, at least one element must have a status of success for the process to upgrade the elements. You must fix the errors.</p> <hr/> <p>Important! Do not run the compare and upgrade processes together with regular payroll processes. This is to avoid affecting other users.</p> <hr/> |
| Update Statistics | <p>Select to generate and view statistics on the upgrade process.</p> <p>This check box becomes available when you select Upgrade Package.</p> |

| Field or Control | Description |
|------------------------------------|---|
| Continue Upgrade Processing | <p>Select <i>With Errors</i> and/or <i>With Warnings</i> to proceed with the upgrade despite errors and warnings in the compare report. If you do not select one or both of these options, and there are errors or warnings, the process will not upgrade. The process will run to success but a message will be generated with information about the errors or warnings.</p> <p>These check boxes become available when the Upgrade Package check box is selected.</p> <hr/> <p>Note: Even with the <i>With Errors</i> check box selected, elements that are in error are not included in the upgrade—only elements in the package that are not in error are upgraded in the target database when you run the upgrade process. By contrast, selecting the <i>With Warnings</i> check box does not prevent an element with an associated warning from being included in the upgrade if the upgrade check box is selected. However, if you do not select <i>With Errors</i> and/or <i>With Warnings</i>, and there is even a single error or warning, the process will not upgrade. The process will run to success but a message will be generated with information about the errors or warnings.</p> <hr/> <p>Note: You can set default options for continuing an upgrade on the Installation Settings page. You can override these defaults when you run the upgrade process on the Package Processing page.</p> <hr/> <p>See Installation Settings Page.</p> |

Process

Click the **Process** button to call and run the processes denoted by the check boxes you have selected: **Import Package**, **Compare Package**, and **Upgrade Package**. Note that you can select all three check boxes at the same time and run these processes as a single, continuous sequence, or run one process at a time. However, the processes must run in the order of import first, then compare, then upgrade.

Note: When you click the Process button the Process Monitor page appears, so that you can monitor the process. Wait until the program finishes before opening a page associated with the package.

Package Elements Page

Use the Package Elements page (GP_PKG_ELEM_UPG) to view the results of the Compare processes and exclude elements from the Upgrade process.

Navigation:

Set Up HCM > Product Related > Global Payroll & Absence Mgmt > Elements > Manage Global Payroll Packages > Apply Rule Package > Package Elements

This example illustrates the fields and controls on the Package Elements page: Elements tab.

| Country | Source PIN Number | Element Name | Action | Element Type | Element Owner | Language |
|---------|-------------------|------------------|--------------------|--------------|---------------------------|-------------------|
| | 40635 | CH_ER_12500 | Informational Only | Earnings | PS Delivered / Maintained | All(Base&Related) |
| | 40699 | CH_UV_PRIMPROV | Informational Only | Variable | PS Delivered / Maintained | All(Base&Related) |
| | 40597 | CH_AB_U090 | Informational Only | Abs Take | PS Delivered / Maintained | All(Base&Related) |
| | 40749 | CH_CA_COMPANY_S1 | Informational Only | Variable | PS Delivered / Maintained | All(Base&Related) |
| | 40761 | CH_CA_PSCODE | Informational Only | Variable | PS Delivered / Maintained | All(Base&Related) |

This example illustrates the fields and controls on the Package Elements page: Package Upgrade tab.

| Country | Source PIN Number | Element Name | Action | Upgrade | Result | Reason | New Element | Target PIN Number | Upgrade Status |
|---------|-------------------|------------------|--------------------|--------------------------|------------|--------|--------------------------|-------------------|----------------|
| | 40635 | CH_ER_12500 | Informational Only | <input type="checkbox"/> | Successful | | <input type="checkbox"/> | 40635 | Not Applicable |
| | 40699 | CH_UV_PRIMPROV | Informational Only | <input type="checkbox"/> | Successful | | <input type="checkbox"/> | 40699 | Not Applicable |
| | 40597 | CH_AB_U090 | Informational Only | <input type="checkbox"/> | Successful | | <input type="checkbox"/> | 40597 | Not Applicable |
| | 40749 | CH_CA_COMPANY_S1 | Informational Only | <input type="checkbox"/> | Successful | | <input type="checkbox"/> | 40749 | Not Applicable |
| | 40761 | CH_CA_PSCODE | Informational Only | <input type="checkbox"/> | Successful | | <input type="checkbox"/> | 40761 | Not Applicable |

This page displays the results of the compare process. If failures are reported, correct the errors before continuing with the upgrade. The Package Compare Audit page provides additional information about the errors.

| Field or Control | Description |
|--|--|
| View Element Browser Compare | Click this button to load the package into the “Element Browser Page” (PeopleSoft Global Payroll) where you can view a comparison of the elements updated by the package. |
| Source PIN Number (source pay item name number) | Displays the PIN number of the element from the source database (without an added 50 000 000). |
| Element Name | Displays the name of the element in the source database. |
| Upgrade | Select this option to overwrite the element with the data from the source database. If you modified the target element then your changes will be lost. To exclude the element from the upgrade process, clear the check box. Excluded elements will retain any changes you may have made. Important! If you exclude an element from the package, you must rerun the compare process before resuming the upgrade. |

| Field or Control | Description |
|-------------------------|---|
| Result | <p>Displays the result of the comparison. Values are:</p> <p><i>Not Done:</i> You haven't yet run the compare process.</p> <p><i>Success:</i> The compare process encountered no errors.</p> <p><i>Failure:</i> The compare process failed. The Reason field shows why.</p> <p><i>Warning:</i> The PeopleSoft system has modified the element in the source database (the upgrade flag is checked on) or you have taken control of the element ownership (the upgrade flag is checked off). The Reason field explains the reason for the warning.</p> <p>In order to accept or ignore the change, update the upgrade flag to indicate whether you want the element upgraded.</p> <hr/> <p>Note: Failures are listed first, followed by warnings and then successes, so if the entries on the first page all read Success, you can assume that the entire comparison process succeeded.</p> <hr/> |

| Field or Control | Description |
|-------------------------|---|
| Reason | <p>If the compare process failed or generated a warning, one of the following reasons appears here:</p> <p><i>New Element Not Copied Completely:</i> You're trying to copy a new element into the target database but that element has no GP_PIN record—only a definition. (For example, you stamp and package elements by version. Another person modifies the element and clears the version number.) Restamp the element with the appropriate version and export it again.</p> <hr/> <p>Note: This error occurs when an element is new and only GP_PIN is brought in and not the definition, or when the definition is there but not GP_PIN.</p> <hr/> <p><i>Element Owner / Type Conflict:</i> The PIN code for the source element matches a PIN code in the target database, but the owner or element type doesn't match. Use the Element Rename page to change the PIN code in the target database.</p> <p>If an element is customer-defined, the Element Owner field on the Compare and Upgrade Package - Package Elements page reads <i>Customer</i>:</p> <p><i>Member Element not found:</i> The source element uses other elements that don't exist in the target database and aren't included in the package. Remove the element from the upgrade process by clearing the <i>Upgrade</i> check box, or include the missing elements in the packaging criteria, recreate the package in the source database, and re-import it.</p> <p><i>Mbr Element Owner/Type Conflict</i> (member element owner/type conflict): This is similar to the <i>Element Owner/Type Conflict</i> message but applies to a member element that's used by the focus element. Use the Element Rename page to change the PIN code in the target database.</p> <p><i>Element does not exist:</i> You're trying to delete an element that's not in the target database.</p> <p><i>PS Delivered/Customer Modified:</i> This warning indicates that the element in the target database has been modified and no longer matches the element in the source database. To accept the PeopleSoft or customer modifications and overwrite any changes in the target database, select the Upgrade check box. The element ownership remains PS Delivered/Customer Modified once the check box is selected.</p> <p><i>PS Delivered/PS Modified:</i> This warning indicates that the PeopleSoft system has changed the ownership of the element in the source database so that it's no longer PeopleSoft delivered or maintained. To reject the change, clear the Upgrade check box.</p> <p><i>Cannot delete PS-Owned Element:</i> You're trying to delete a PeopleSoft-owned element from the target database. You cannot delete such elements.</p> <p><i>Duplicate Package Element Found:</i> You're trying to import an element that is in another package that's being upgraded.</p> |

| Field or Control | Description |
|-------------------------|--|
| | <p><i>Used in Non-Elem Defn (element definition):</i> You are trying to delete an element that is used in a non-element definition. Modify the non element definition so that it no longer uses this element.</p> <p><i>Used in Output Results:</i> You are trying to delete an element that is used in a processing result table. (Results cannot be deleted from the result tables.)</p> <p><i>Used in Payee Data:</i> You're trying to delete an element that's associated with payee data. Modify the payee data so that it no longer uses this element.</p> <p><i>Used in Rule Defn (definition):</i> You are trying to delete an element that is used by another element. Modify the rule definition so that it is no longer uses this element.</p> <p><i>Auto-component used in RuleDfn (rule definition):</i> You are trying to delete an element whose component is used by a rule definition. Modify the element definition so that it is no longer uses this component.</p> |
| New Element | The check box is selected if the element to be upgraded isn't in the target database. |
| Upgrade Status | Indicates whether the upgrade process has occurred. Changes from <i>Not Done</i> to <i>Done</i> after you complete the compare and upgrade processes. |

Package Compare Audit Page

Use the Package Compare Audit page (GP_PKG_CMP_AUDIT) to review for errors that occur during the Compare process.

Before continuing with the Upgrade process, correct the errors and rerun the Compare process.

Navigation:

Set Up HCM > Product Related > Global Payroll & Absence Mgmt > Elements > Manage Global Payroll Packages > Apply Rule Package > Package Compare Audit

This example illustrates the fields and controls on the Package Compare Audit page – Elements tab.

| Parent | Member Element | Failure Reason | Upgrade Action |
|--------|----------------|----------------|----------------|
| | | | |

This example illustrates the fields and controls on the Package Compare Audit – Package Upgrade tab.

| Package ID | CH16900D | Swiss Rules Bundle | 116900 Del |
|---|----------------|---------------------|-------------------|
| Element List Personalize Find View All First 1 of 1 Last | | | |
| Elements Package Upgrade | | | |
| Parent | Member Element | Record (Table) Name | PIN Nbr Fieldname |
| | | | |
| | | | |

| Field or Control | Description |
|-------------------------|--|
| Parent | Displays the name of the parent element. |
| Member Element | Displays the name of the member element that generated the error. |
| Failure Reason | Displays the cause of the failure. The same information appears in the Reason field on the Package Elements tab. |
| Upgrade Action | Displays the action that the system was trying to take when the error occurred. Values are: <i>Upgrade, Delete, and Info Only.</i> |

Package Upgrade

Select the Package Upgrade tab.

| Field or Control | Description |
|--|---|
| Parent | Displays the name of the parent element that generated the error. |
| Member Element | Displays the name of the member element that generated the error. |
| Record (Table) Name | Displays the name of the record that stores the parent element and its members. |
| PIN Num Fieldname (pay item name number field name) | Displays the name of the field that contains the key field. |
| Field Name | Displays the name of the field that contains the member element that created the error. |

Package Status Page

Use the Package Status page (GP_PKG_DTTM_SEC) to view the date and time a package was created, exported, imported, compared, and upgraded.

Navigation:

Click the **Package Status** link on the Package Processing page.

This example illustrates the fields and controls on the Package Status page.

| Package Status | |
|------------------------------------|--|
| Apply Rule Package | |
| Package Status | |
| Package ID | CH16900D Swiss Rules Bundle 116900 Del |
| Created | Imported 08/08/2003 9:22:09PM |
| Scripts Created | Compared 08/08/2003 9:46:06PM |
| Exported | Upgraded 08/08/2003 9:54:17PM |

View the date and time packages and scripts were created, and see when packages were exported, imported, compared, and upgraded.

View Scripts Page

Use the View Scripts page (GP_PKG_SCRIPTS_SEC) to view export, import, and cleanup scripts.

Navigation:

Click the **View Scripts** link on the Package Processing page.

This example illustrates the fields and controls on the View Scripts page.

| Package Export Import Defns | |
|---|---|
| Apply Rule Package | |
| View Scripts | |
| Package ID | AU689611 GP 9 Bundle 2 (GP Australia) |
| *Script Location | <input type="text" value="c:\templ"/> |
| | Script Location example: C:\folder\ |
| View Package Script | <input type="text" value=""/> |
| SQL Statement Text | <div style="border: 1px solid gray; height: 150px; width: 100%;"></div> |
| <input type="button" value="OK"/> <input type="button" value="Cancel"/> | |

| Field or Control | Description |
|----------------------------|--|
| Script Location | <p>Displays the script location, which must be accessible by both the import and export NT Process Scheduler for the import and export databases. You must specify the script location in the Process Scheduler configuration file (pspres.cfg).</p> <hr/> <p>Note: We discuss how to specify the script location in the Process Scheduler configuration file in the section titled <i>The Process of Connecting UNIX and NT Directories</i>.</p> <hr/> <p>See The Process of Connecting UNIX and NT Directories.</p> <hr/> <p>Note: You can define a default script location on the Installation Settings page for all packager scripts.</p> <hr/> <p>See Installation Settings Page.</p> |
| View Package Script | Select the type of script that you want to view: export, import, or cleanup. The DataMover script appears. |

Renaming Elements

Page Used to Rename Elements

| Page Name | Definition Name | Usage |
|-------------------------------------|------------------------|-------------------------------|
| Element Rename Page | GP_PIN_RENAME | Change an element's PIN code. |

Understanding How to Rename Elements

Sometimes the compare process finds an element in the target database whose PIN code is the same as the source element's, but the two elements have different element types or owners. In this case, you receive one of the following error messages: "Element Owner/Type Conflict" or "Mbr Element Owner/Type Conflict."

To continue exporting the element, you can use the Element Rename Utility to change the PIN code of the target element. After changing the PIN code, always rerun the compare process.

When you instruct the system to change an element's PIN code, it checks the following:

- Is the new PIN code already in use?

If yes, the system generates an error.

- Is the old PIN code used in PeopleSoft Time and Labor?

If yes, the system creates a warning. Remap the element in Time and Labor to reflect the new code.

- Is the new PIN code the same as the old PIN code?

If yes, the system issues a warning.

Important! Do not rename an element when you are in the process of creating a package. PeopleSoft created elements cannot be renamed.

Warning! Time and Labor stores PIN code information, so if you make a change, you must update Time and Labor data accordingly.

Related Links

[The Delete Functions](#)

“Integrating Time and Labor with Global Payroll” (PeopleSoft Time and Labor)

Element Rename Page

Use the Element Rename page (GP_PIN_RENAME) to change an element's PIN code.

Navigation:

Set Up HCM > Product Related > Global Payroll & Absence Mgmt > Elements > Rename Element Codes > Element Rename

This example illustrates the fields and controls on the Rename Element Codes page .

Rename Element Codes

| | |
|---|---|
| <p>Old Code ABS BGN DATE ALL Name ABS BGN DATE Description Absence Begin Date</p> | <p>New PIN Code <input style="width: 100%;" type="text"/> Element Type System Element Field Format Date <input checked="" type="checkbox"/> Always Recalculate</p> |
|---|---|

| | |
|---|--|
| <p>Element Use</p> <p>Owner PS Delivered/Maintained/Secure Class System Data Used By All Countries Country ALL Industry/Region Category ABS Absence</p> | <p>Override Levels</p> <p><input type="checkbox"/> Pay Entity <input type="checkbox"/> Pay Group <input type="checkbox"/> Payee <input type="checkbox"/> Calendar <input type="checkbox"/> Via Elements <input type="checkbox"/> Element Definition <input type="checkbox"/> Positive Input</p> |
| <p>Results</p> <p><input type="checkbox"/> Store <input type="checkbox"/> Store if Zero</p> | <p>Forecasting</p> <p>This element type does not support forecasting.</p> |

Go to [Comments](#)

| Field or Control | Description |
|--|--|
| New PIN Code (new pay item name code) | Enter the new code. The old PIN code is replaced when you save. Note: When renaming a PIN, make sure that you use the PIN name plus the country suffix. For example: PIN NAME DEU. |

Creating and Exporting Non-Rule Packages

Pages Used to Create and Export Non-Rule Packages

| Page Name | Definition Name | Usage |
|---|------------------------|---|
| <u>Create Non-Rule Package – Package Definition Page</u> Export Non-Rule Package – Package Definition Page | GP_NR_PKG_DFN | Name or view a non-rule package and enter a description and comments. |
| <u>Package Criteria Page</u> | GP_NR_PKG_CRIT | Define criteria for selecting items for the non-rule package and create the package. |
| <u>Create Non-Rule Package – Package Records Page</u> | GP_NR_PKG_RECS | View and optionally edit the Where clause of a SQL statement that the system creates based on selection criteria that you enter on the Package Criteria page. |
| <u>Create Non-Rule Package – Package Elements Page</u> Export Non-Rule Package – Package Elements Page | GP_NR_PKG_ELMTS | View the elements of a non-rule package. |
| <u>Export Non-Rule Package – Package Records Page</u> | GP_NR_PKG_DATA | <ul style="list-style-type: none"> • Create scripts and export package records and element information. • View Where clause of SQL statement that the system creates based on selection criteria that you enter on the Package Criteria page. |
| <u>View Script Page</u> | GP_NR_PKG_EXPIMP | View non-rule export and import scripts. |
| <u>Package Status Page</u> | GP_NR_PKG_DTTM_SEC | View the date and time a package was created, exported, imported, compared, and upgraded. |

Understanding How to Create and Export Non-Rule Packages

Non-rule packages contain both non-elements and element information. Non-elements are those that belong to records where PIN_NUM is *not* the primary key.

Important! When creating a non-rule package, make sure that records that are related to the record you are moving are included in the same package. To move a complete set of related data, you need to understand which records are related.

Before moving non-rule data, make sure that the elements that are associated with the non-rule data exist in the target database. You can do this by creating a rule package that contains the elements that are associated with the data record that's being moved and copying (upgrading) the rule package to the target database.

For example, suppose that you are moving non-rule calendar detail records. Calendar details are associated with the process number element (PIN_PRC_NUM). Before moving the calendar data, create a rule package that contains the process number element and move it to the target database. The system can assign a new PIN number to this element in the target database, if necessary. Once this package is in the target database, you can move the calendar details by creating a non-rule package.

When the system moves the calendar details, it finds the process number element in the target database, retrieves the new PIN number that was assigned during the rule upgrade process, and renumbers the process number PIN in the calendar detail record. (Without renumbering, the calendar detail would contain PIN numbers that may not exist or are not related the element used by that calendar in the target database.)

To create and export a non-rule package:

1. Create the non-rule package.

To do this, use the Create Non-Rule Package (GP_NR_PKG_CREATE) component.

On this component you can:

- Define the selection criteria for the records to move from the source database.
- Run the create package process.
- View the rules that are associated with the data that you're moving.

2. Export the non-rule package.

To do this, use the Export Non-Rule Package (GP_NR_PKG_EXPORT) component.

The system exports the non-rule data and the element information contained in the non-rule package.

Note: Absence Management enables you to specify a default location for the scripts used in the export non-rule package process so that you do not need to enter the same basic information each time you export a package. To do this, access the Installation Settings page for Absence Management (**Set Up HCM > Product Related > Global Payroll & Absence Mgmt > System Settings > Installation Settings**) and specify the script location.

Create Non-Rule Package – Package Definition Page

Use the Create Non-Rule Package – Package Definition page (GP_NR_PKG_DFN) to name or view a non-rule package and enter a description and comments.

Navigation:

- **Set Up HCM > Product Related > Global Payroll & Absence Mgmt > Elements > Manage Global Payroll Packages > Create Non-Rule Package > Package Definition**
- Set Up HCM, Product Related, Global Payroll & Absence Mgmt, Elements, Manage Global Payroll Packages, Export Non-Rule Package, Package Definition

Enter a description of the package and comments.

This example illustrates the fields and controls on the Package Definition page.

The screenshot shows the 'Package Definition' tab selected. The 'Package ID' is CH16900 and the 'Package Status' is 'Package Status'. The '*Description' field contains 'CHE Non-Rules - Bundle 16900' and the 'Short Description' field contains 'Swiss Non-'. The 'Comment' field contains 'Swiss Non-Rules Bundle #1,2003 16900'.

Package Criteria Page

Use the Package Criteria page (GP_NR_PKG_CRIT) to define criteria for selecting items for the non-rule package and create the package.

Navigation:

- **Set Up HCM > Product Related > Global Payroll & Absence Mgmt > Elements > Manage Global Payroll Packages > Create Non-Rule Package > Package Criteria**

This example illustrates the fields and controls on the Package Criteria page.

The screenshot shows the 'Package Criteria' tab selected. The 'Package ID' is CH16900 and the 'Description' is 'CHE Non-Rules - Bundle 16900'. The 'Record Selection Criteria' section shows 'Record' as 'BANK_EC_TBL' and '*Where Clause Option' as 'Use Default WHERE Clause'. The 'Data Selection' table is as follows:

| *Field Name | Field Format | *Operator | Character |
|-------------|--------------|-----------|-----------|
| COUNTRY | Character | = | CHE |

A 'Create Package' button is visible at the bottom.

| Field or Control | Description |
|----------------------------|---|
| Package ID | Displays the package ID. |
| Record | Select the record that contains the data to move. The Data Selection group box becomes available. |
| Where Clause Option | <p>The system converts the criteria entered on this page into SQL in order to select elements for the package.</p> <p>Values are:</p> <p><i>Use Default WHERE Clause:</i> Tells the system to use the default Where clause. If the where clause has been changed and <i>Use Default WHERE Clause</i> is selected again, the page discards any SQL code modifications you have made and reverts to the Where clause based on the criteria you specified.</p> <p><i>Change WHERE Clause:</i> Makes all other fields on the page unavailable and puts the SQL code on the Package Records page in edit mode.</p> |

Data Selection

Use the fields in the Data Selection group box to indicate which data to move. Selection criteria are optional, but if you don't enter selection criteria, no delete process is performed on the target database before source data importation. This can result in a "Duplicate Record" message from Data Mover during import, or it can cause the upgrade process to fail.

| Field or Control | Description |
|-------------------------|--|
| Field Name | Select the field on which to base the selection criteria. (It is advisable to use a key field, which are identified in the prompt table's Key Position column.) |
| Field Format | Displays the format of the field that you selected. |
| Operator | <p>Select the operator that the system uses to select the data to include in the package. Values are <, <=, <>, =, >, >=, and <i>LIKE</i>. If you select <i>LIKE</i>, you can enter a partial value, such as <i>S</i>, in the field to the right.</p> <p>In the field on the right of the Operator field, enter the value the system searches for. (The name of this field varies with field format.)</p> |

| Field or Control | Description |
|-------------------------|---|
| Create Package | <p>Click to create the package after defining the selection criteria. The Create Non-Rule Package - Package Records page appears when the package is created.</p> <p>To review the package contents, select the Package Elements tab.</p> |

Create Non-Rule Package – Package Records Page

Use the Create Non-Rule Package – Package Records page (GP_NR_PKG_RECS) to view and optionally edit the Where clause of a SQL statement that the system creates based on selection criteria that you enter on the Package Criteria page.

Navigation:

Set Up HCM > Product Related > Global Payroll & Absence Mgmt > Elements > Manage Global Payroll Packages > Create Non-Rule Package > Package Records

This example illustrates the fields and controls on the Create Non-Rule Package - Package Records page.

| Field or Control | Description |
|-------------------------|---|
| Record | Displays the record from which fields are selected. |

| Field or Control | Description |
|----------------------------|---|
| Where Clause Option | <p>Select a Where clause option. Values are:</p> <p><i>Change WHERE Clause:</i> Select to edit the SQL code on the lower part of the page.</p> <p><i>Use Default WHERE Clause:</i> Select to use the default clause or revert to it after editing the SQL code. Changes that you have made to the Where clause are lost and the field is disabled.</p> |
| Where Clause | <p>If you selected <i>Use Default WHERE Clause</i> in the Where Clause Option field, the system displays the Where clause of the SQL statement it created based on the selection criteria that you entered for the package on the Create Non-Rule Package - Package Criteria page. This WHERE clause cannot be edited.</p> <p>If you selected <i>Change Where Clause</i>, you can edit the SQL. Do not use PIN_NUM as a selection criterion or any field where PIN_NUM can be stored. (Doing so prevents renumbering during the import process.)</p> |

Create Non-Rule Package – Package Elements Page

Use the Create Non-Rule Package – Package Elements page (GP_NR_PKG_ELMTS) to view the elements of a non-rule package.

Navigation:

- **Set Up HCM > Product Related > Global Payroll & Absence Mgmt > Elements > Manage Global Payroll Packages > Create Non-Rule Package > Package Elements**
- Set Up HCM, Product Related, Global Payroll & Absence Mgmt, Elements, Manage Global Payroll Packages, Export Non-Rule Package, Package Elements

This example illustrates the fields and controls on the Package Elements page.

| Package Definition Package Criteria Package Records Package Elements | | | | | |
|---|------------------|----------------------|--------------|---------------------------|--------------------|
| Package ID CH16900 | | Package Status | | | |
| Description CHE Non-Rules - Bundle 16900 | | | | | |
| Element List | | | | | |
| Personalize Find View 100 [?] [] First 1-10 of 288 Last | | | | | |
| Source PIN | Element Name | PIN Code | Element Type | Element Owner | Action |
| 40008 | CH_ER_10000 | CH_ER_10000 CHE | Earnings | PS Delivered / Maintained | Informational Only |
| 40012 | CH_ER_11000 | CH_ER_11000 CHE | Earnings | PS Delivered / Maintained | Informational Only |
| 40013 | CH_ER_01100 | CH_ER_01100 CHE | Earnings | PS Delivered / Maintained | Informational Only |
| 40014 | CH_ER_04000 | CH_ER_04000 CHE | Earnings | PS Delivered / Maintained | Informational Only |
| 40015 | CH_ER_10100 | CH_ER_10100 CHE | Earnings | PS Delivered / Maintained | Informational Only |
| 40016 | CH_ER_13600 | CH_ER_13600 CHE | Earnings | PS Delivered / Maintained | Informational Only |
| 40017 | CH_ER_13600_RATE | CH_ER_13600_RATE CHE | Components | PS Delivered / Maintained | Informational Only |
| 40018 | CH_ER_13600_UNIT | CH_ER_13600_UNIT CHE | Components | PS Delivered / Maintained | Informational Only |
| 40021 | CH_ER_01000 | CH_ER_01000 CHE | Earnings | PS Delivered / Maintained | Informational Only |
| 40036 | CH_AH_02 | CH_AH_02 CHE | Accum | PS Delivered / Maintained | Informational Only |

Note: This display page lists the rule elements used in the records being moved to the new database. These are informational elements. The page doesn't show data in records where PIN Num is not a field.

Export Non-Rule Package – Package Records Page

Use the Export Non-Rule Package – Package Records page (GP_NR_PKG_DATA) to .

Navigation:

Set Up HCM > Product Related > Global Payroll & Absence Mgmt > Elements > Manage Global Payroll Packages > Export Non-Rule Package > Package Records

This example illustrates the fields and controls on the Export Non-Rule Package - Package Records page.

| Field or Control | Description |
|-------------------------|---|
| Script Location | <p>Specify the path to the location where you want the import/export scripts to be created when you click the Create Scripts button.</p> <p>The location of the scripts and data files must be accessible by both the import and export NT Process Scheduler for the import and export databases. You must specify the script location in the Process Scheduler configuration file (psprcs.cfg).</p> <hr/> <p>Note: We discuss how to specify the script location in the Process Scheduler configuration file in the section titled <i>The Process of Connecting UNIX and NT Directories</i>.</p> <hr/> <p>See The Process of Connecting UNIX and NT Directories.</p> <hr/> <p>Note: You can define a default script location on the Installation Settings page for all packager scripts.</p> <hr/> <p>See Installation Settings Page.</p> |
| Record | Displays the name of the record containing the data that you're exporting. |
| Where Clause | Displays the Where clause of the SQL statement that selects the data to be exported. |

| Field or Control | Description |
|-------------------------|--|
| Create Scripts | Click to create the import and export scripts for the non-rule package: xxx_elements_imp.dms, xxx_elements_exp.dms, xxx_records_exp.dms, and xxx_record_imp.dms (where xxx = name of package). The scripts will be created in the script location you specify. |
| Export | Click to export the package once you have selected a script location. |

View Script Page

Use the View Script page (GP_NR_PKG_EXPIMP) to view non-rule export and import scripts.

Navigation:

Set Up HCM > Product Related > Global Payroll & Absence Mgmt > Elements > Manage Global Payroll Packages > Export Non-Rule Package > View Script

| Field or Control | Description |
|----------------------------|--|
| Script Location | <p>Displays the script location, which must be accessible by both the import and export NT Process Scheduler for the import and export databases. You must specify the script location in the Process Scheduler configuration file (psprcs.cfg).</p> <hr/> <p>Note: We discuss how to specify the script location in the Process Scheduler configuration file in the section titled <i>The Process of Connecting UNIX and NT Directories</i>.</p> <hr/> <p>See The Process of Connecting UNIX and NT Directories.</p> <hr/> <p>Note: You can define a default script location on the Installation Settings page for all packager scripts.</p> <hr/> <p>See Installation Settings Page.</p> |
| View Package Script | Select the type of script that you want to view: either export or import scripts for the elements and records. The DataMover script appears. |

Package Status Page

Use the Package Status page (GP_NR_PKG_DTTM_SEC) to view the date and time a package was created, exported, imported, compared, and upgraded.

Navigation:

- Click **Package Status** link on Package Definition page.

- Click **Package Status** link on Package Criteria page.
- Click **Package Status** link on Package Records page.
- Click **Package Status** link on Package Elements page.
- Click **Package Status** link on View Script page.

This example illustrates the fields and controls on the Package Status page.

| Package Status | | |
|-----------------------|-----------------------|------------------------|
| Package Status | | |
| Package ID | GMXSTUP4 | Set up 4 data mex T205 |
| Created | 10/01/2001 11:28:43PM | Compared |
| Exported | 10/01/2001 11:29:50PM | Imported NR |
| Exported NR | 10/01/2001 11:31:28PM | Upgraded |
| Imported | | |

View the date and time a package was created, exported, imported, compared, and upgraded.

Importing, Comparing, and Upgrading Non-Rule Packages

Pages Used to Import, Compare, and Upgrade Non-Rule Packages

| <i>Page Name</i> | <i>Definition Name</i> | <i>Usage</i> |
|--|------------------------|---|
| Import Non-Rule Elements – Package Definition Page | GP_NR_PKG_DFN | <ul style="list-style-type: none"> • Name a non-rule package and enter a description and comments. • View the name and description of a non-rule package. |
| Compare Non-Rule Package – Package Definition Page | | |
| Import Non-Rule Records – Package Definition Page | | |
| Upgrade Non-Rule Package – Package Definition Page | | |

| Page Name | Definition Name | Usage |
|--|------------------------|--|
| <u>Import Non-Rule Elements - Package Records Page</u> <u>Import Non-Rule Records - Package Records Page</u> | GP_NR_PKG_DATA | <ul style="list-style-type: none"> • Import non-rule element information into the target database. • Import non-rule records into the target database. • View Where clause of SQL statement that the system creates based on selection criteria that you enter on the Package Criteria page. |
| <u>Upgrade Non-Rule Package – Package Records Page</u> | GP_NR_PKG_RECS | <ul style="list-style-type: none"> • View and optionally edit the Where clause of a SQL statement that the system creates based on selection criteria that you enter on the Package Criteria page. • Upgrade a non-rule package. <p>The Compare process must be successfully completed before you can upgrade the package.</p> |
| <u>Import Non-Rule Elements – Package Elements Page</u> Compare Non-Rule Package - Package Elements Page Import Non-Rule Records – Package Elements Page | GP_NR_PKG_ELMTS | <ul style="list-style-type: none"> • Compare data from the source database with the data in the target database. • View the contents of the imported package. |
| <u>Import Non-Rule Elements - View Script Page</u> Import Non-Rule Records – View Script Page | GP_NR_PKG_EXPIMP | View export/import scripts. |
| <u>Package Status Page</u> | GP_NR_PKG_DTTM_SEC | View the date and time a package was created, exported, imported, compared, and upgraded. |

Understanding How to Import, Compare, and Upgrade Non-Rule Packages

After creating and exporting a non-rule package:

1. Import the non-rule elements.

To do this, use the Import Non-Rule Elements (GP_NR_PKG_IMPORT) component.

The system imports the element information only—not the elements themselves.

2. Compare the elements in the non-rule package with those in the target database to ensure that the non-rule elements are in the target database.

To do this, use the Compare Non-Rule Package (GP_NR_PKG_COMPARE) component.

Using this component you:

- Compare the element information in the package with the element information in the target database.
- Identify any missing elements that need to be moved into the target database.

3. Import the non-rule records.

To do this, use the Import Non-Rule Records (GP_NR_PKG_IMPREGS) component.

4. Upgrade to the non-rule package.

To do this, use the Upgrade Non-Rule Package (GP_NR_PKG_UPGRADE) component.

Note: Absence Management enables you to specify a default location for the scripts used in the import non-rule package process so that you do not need to enter the same basic information each time you import a package. To do this, access the Installation Settings page for Absence Management (Set Up HCM, Product Related, Global Payroll & Absence Mgmt, System Settings, Installation Settings) and specify the script location.

Import Non-Rule Elements – Package Definition Page

Use the Import Non-Rule Elements – Package Definition page (GP_NR_PKG_DFN) to

- Name a non-rule package and enter a description and comments.
- View the name and description of a non-rule package.

Navigation:

- **Set Up HCM > Product Related > Global Payroll & Absence Mgmt > Elements > Manage Global Payroll Packages > Import Non-Rule Elements > Package Definition**
- **Set Up HCM > Product Related > Global Payroll & Absence Mgmt > Elements > Manage Global Payroll Packages > Compare Non-Rule Package > Package Definition**
- **Set Up HCM > Product Related > Global Payroll & Absence Mgmt > Elements > Manage Global Payroll Packages > Import Non-Rule Records > Package Definition**
- **Set Up HCM > Product Related > Global Payroll & Absence Mgmt > Elements > Manage Global Payroll Packages > Upgrade Non-Rule Package > Package Definition**

This example illustrates the fields and controls on the Package Definition page.

The screenshot shows the 'Package Definition' page with the following fields and values:

- Package ID: AU25318
- Package Status: (empty)
- *Description: AUS Non-Rules -Update ID 25318
- Short Description: AUS Non-Ru
- Comment: (empty text area)

Enter or view a description of the package and comments.

Import Non-Rule Elements - Package Records Page

Use the Import Non-Rule Elements - Package Records page (GP_NR_PKG_DATA) to:

- Import non-rule element information into the target database.
- Import non-rule records into the target database.
- View Where clause of SQL statement that the system creates based on selection criteria that you enter on the Package Criteria page.

Navigation:

- **Set Up HCM > Product Related > Global Payroll & Absence Mgmt > Elements > Manage Global Payroll Packages > Import Non-Rule Elements > Package Records**
- **Set Up HCM > Product Related > Global Payroll & Absence Mgmt > Elements > Manage Global Payroll Packages > Import Non-Rule Records > Package Records**

This example illustrates the fields and controls on the Package Records page.

The screenshot shows the 'Package Records' page with the following fields and values:

- Package ID: CH16900
- Package Status: (empty)
- Description: CHE Non-Rules - Bundle 16900
- *Script Location: (empty)
- Script Location example: C:\folder\
- Record: BANK_EC_TBL, Bank Table
- Where Clause: where COUNTRY='CHE'

Buttons at the bottom: Import Package, Import ADS Elements, Process Monitor.

| Field or Control | Description |
|-------------------------|--|
| Script Location | <p>Displays the script location, which must be accessible by both the import and export NT Process Scheduler for the import and export databases. You must specify the script location in the Process Scheduler configuration file (pspres.cfg).</p> <hr/> <p>Note: We discuss how to specify the script location in the Process Scheduler configuration file in the section titled <i>The Process of Connecting UNIX and NT Directories</i>.</p> <hr/> <p>See The Process of Connecting UNIX and NT Directories.</p> <hr/> <p>Note: You can define a default script location on the Installation Settings page for all packager scripts.</p> <hr/> <p>See Installation Settings Page.</p> |
| Import Package | If the button is available, click to start the import process. |

Import Non-Rule Elements – Package Elements Page

Use the Import Non-Rule Elements – Package Elements page (GP_NR_PKG_ELMTS) to .

- Compare data from the source database with the data in the target database.
- View the contents of the imported package.

Navigation:

- **Set Up HCM > Product Related > Global Payroll & Absence Mgmt > Elements > Manage Global Payroll Packages > Import Non-Rule Elements > Package Elements**
- Set Up HCM, Product Related, Global Payroll & Absence Mgmt, Elements, Manage Global Payroll Packages, Compare Non-Rule Package, Package Elements
- **Set Up HCM > Product Related > Global Payroll & Absence Mgmt > Elements > Manage Global Payroll Packages > Import Non-Rule Records > Package Elements**

This example illustrates the fields and controls on the Compare Non-Rule Package - Package Elements page.

| Package Definition | | Package Records | | Package Elements | | View Script | | |
|--|------------------|----------------------|--------------|---------------------------|--------------------|-------------|--------|------------|
| Package ID CH16900 | | | | Package Status | | | | |
| Description CHE Non-Rules - Bundle 16900 | | | | | | | | |
| Element List | | | | | | | | |
| Source PIN | Element Name | PIN Code | Element Type | Element Owner | Action | Result | Reason | Target PIN |
| 40008 | CH_ER_10000 | CH_ER_10000 CHE | Earnings | PS Delivered / Maintained | Informational Only | Successful | | 40008 |
| 40012 | CH_ER_11000 | CH_ER_11000 CHE | Earnings | PS Delivered / Maintained | Informational Only | Successful | | 40012 |
| 40013 | CH_ER_01100 | CH_ER_01100 CHE | Earnings | PS Delivered / Maintained | Informational Only | Successful | | 40013 |
| 40014 | CH_ER_04000 | CH_ER_04000 CHE | Earnings | PS Delivered / Maintained | Informational Only | Successful | | 40014 |
| 40015 | CH_ER_10100 | CH_ER_10100 CHE | Earnings | PS Delivered / Maintained | Informational Only | Successful | | 40015 |
| 40016 | CH_ER_13600 | CH_ER_13600 CHE | Earnings | PS Delivered / Maintained | Informational Only | Successful | | 40016 |
| 40017 | CH_ER_13600_RATE | CH_ER_13600_RATE CHE | Components | PS Delivered / Maintained | Informational Only | Successful | | 40017 |
| 40018 | CH_ER_13600_UNIT | CH_ER_13600_UNIT CHE | Components | PS Delivered / Maintained | Informational Only | Successful | | 40018 |
| 40021 | CH_ER_01000 | CH_ER_01000 CHE | Earnings | PS Delivered / Maintained | Informational Only | Successful | | 40021 |
| 40036 | CH_AH_02 | CH_AH_02 CHE | Accum | PS Delivered / Maintained | Informational Only | Successful | | 40036 |

After completing the first part of the export and import process, log onto the target database and perform the compare process, which verifies that the elements needed by the data you're moving exist in the target database. The compare process checks PIN code and PIN type.

If the elements don't exist or if the element types do not match, the compare process fails and you must create a rule package and move the package to the target database before continuing with the non-rule upgrade.

Element List

This group box shows the results of the comparison of the source and target databases. If the compare process reports failures, correct the errors before continuing with the upgrade process.

| Field or Control | Description |
|--|--|
| Source PIN (source pay item name) | Displays the PIN number of the element from the source database (without 50000000 added). |
| Element Name | Displays the name of the element in the source database. |
| PIN Code (pay item name code) | Displays the element's PIN code. |
| Element Type | Displays the element's type. |
| Element Owner | Identifies who created the element and who's responsible for maintaining it. Valid values are: <i>Customer</i> , <i>Modified</i> , <i>PS Mnt</i> , <i>PS NonMnt</i> , and <i>PS Secure</i> . |

| Field or Control | Description |
|-------------------------|---|
| Result | <p>Displays the results of the comparison:</p> <p><i>Not Done:</i> You haven't yet run the compare process.</p> <p><i>Success:</i> The compare process didn't encounter any errors.</p> <p><i>Failure:</i> The compare process failed. The Reason field shows why.</p> |
| Reason | <p>If the compare process failed, displays one of the following values:</p> <p><i>Not Found:</i> Create a new rule package that includes the missing elements and move the package to the target database before continuing with the non-rule upgrade.</p> <p><i>Type Cnflt</i> (type conflict): The element types do not match. Most likely this error occurred because you created an element that has the same PIN code, but a different type. Rename your element and create a new rule package that includes the element that is being used.</p> |
| Compare | <p>Click to start the compare process. Once the process is complete, the Element List group box shows, element by element, whether a match was found.</p> <p>If the process generates no errors, the following message appears: "Compare process completed successfully. You can now import non-rule records from the source database."</p> |

Import Non-Rule Records - Package Records Page

Use the Import Non-Rule Records - Package Records page to:

- Import non-rule element information into the target database.
- Import non-rule records into the target database.
- View Where clause of SQL statement that the system creates based on selection criteria that you enter on the Package Criteria page.

Navigation:

(Set Up HCM > Product Related > Global Payroll & Absence Mgmt > Elements > Manage Global Payroll Packages > Import Non-Rule Records > Package Records)

This example illustrates the fields and controls on the Import Non-Rule Records - Package Records page.

The screenshot shows the 'Package Records' tab selected. The page displays the following information:

- Package ID:** SETUP4
- Package Status:** (link)
- Description:** Set up 4 Data
- *Script Location:** (input field)
- Script Location example:** C:\folder\
- Export Scripts Table:**

| Record | Where Clause |
|-------------|--|
| GP_CALENDAR | GP Calendar Table where GP_PAYGROUP like 'K%' |

At the bottom, there are buttons for 'Import Package', 'Import ADS Elements', and a 'Process Monitor' link.

After reviewing the results of the compare process and moving any missing elements into the target database, you can import the non-rule records into the target database.

Click the **Record Import** button to import the records.

Upgrade Non-Rule Package – Package Records Page

Use the Upgrade Non-Rule Package – Package Records page (GP_NR_PKG_RECS) to

- View and optionally edit the Where clause of a SQL statement that the system creates based on selection criteria that you enter on the Package Criteria page.
- Upgrade a non-rule package.

The Compare process must be successfully completed before you can upgrade the package.

- View and optionally edit the Where clause of a SQL statement that the system creates based on selection criteria that you enter on the Package Criteria page.
- Upgrade a non-rule package.

The Compare process must be successfully completed before you can upgrade the package.

Navigation:

Set Up HCM > Product Related > Global Payroll & Absence Mgmt > Elements > Manage Global Payroll Packages > Upgrade Non-Rule Package > Package Records

This example illustrates the fields and controls on the Upgrade Non-Rule Package - Package Records page.

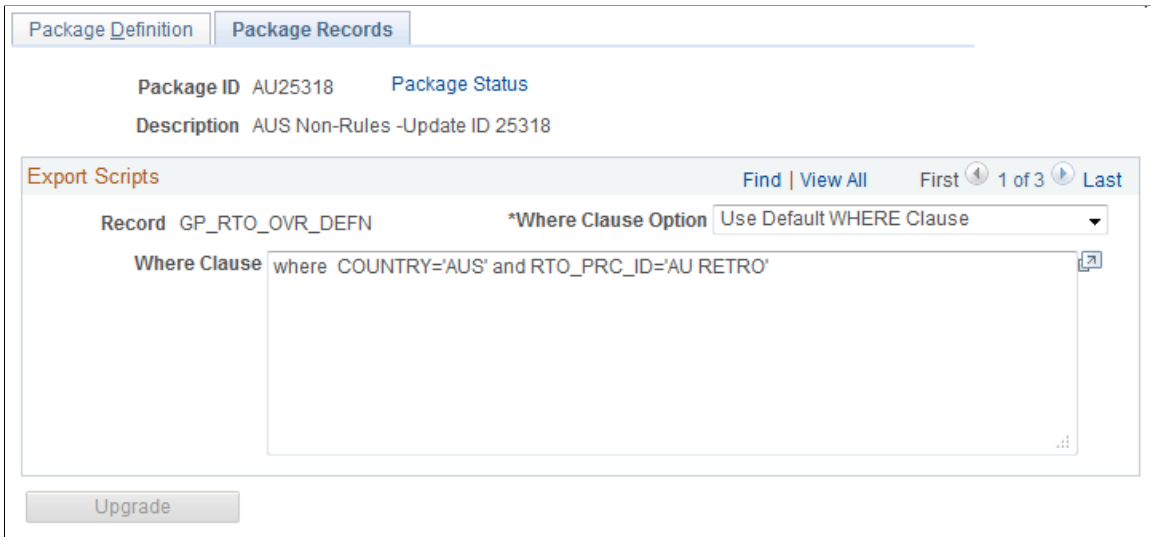

The final step is to renumber the elements on the non-rule data that you've imported so that they have the same PIN numbers as the matching elements in the target database, using the Upgrade Non-Rule Package component.

| <i>Field or Control</i> | <i>Description</i> |
|-------------------------|--|
| Upgrade | <p>Click to start the upgrade process. A message tells you when the process is complete.</p> <p>You cannot compare or upgrade the same package again unless you re-import records and elements into the target database.</p> |

Import Non-Rule Elements - View Script Page

Use the Import Non-Rule Elements - View Script page (GP_NR_PKG_EXPIMP) to view export/import scripts.

Navigation:

- **Set Up HCM > Product Related > Global Payroll & Absence Mgmt > Elements > Manage Global Payroll Packages > Import Non-Rule Elements > View Script**
- **Set Up HCM > Product Related > Global Payroll & Absence Mgmt > Elements > Manage Global Payroll Packages > Import Non-Rule Records > View Script**

This example illustrates the fields and controls on the View Script page.

| Field or Control | Description |
|----------------------------|--|
| Script Location | <p>Displays the script location, which must be accessible by both the import and export NT Process Scheduler for the import and export databases. You must specify the script location in the Process Scheduler configuration file (psprcs.cfg).</p> <hr/> <p>Note: We discuss how to specify the script location in the Process Scheduler configuration file in the section called <i>The Process of Connecting UNIX and NT Directories</i>.</p> <hr/> <p>See The Process of Connecting UNIX and NT Directories.</p> <hr/> <p>Note: You can define a default script location on the Installation Settings page for all packager scripts.</p> <hr/> <p>See Installation Settings Page.</p> |
| View Package Script | Select the type of script that you want to view: export or import. The DataMover script appears. |

Package Status Page

Use the Package Status page (GP_NR_PKG_DTTM_SEC) to view the date and time a package was created, exported, imported, compared, and upgraded.

Navigation:

- Click **Package Status** link on Package Definition page.
- Click **Package Status** link on Package Records page.
- Click **Package Status** link on Package Elements page.
- Click **Package Status** link on View Scripts page.

This example illustrates the fields and controls on the Package Status page.

| Package Status | |
|-----------------------|---------------------------|
| Package Status | |
| Package ID | SETUP4 Set up 4 Data |
| Created | Compared |
| Exported | Imported NR |
| Exported NR | Upgraded |
| Imported | |

View the date and time a package was created, exported, imported, compared, and upgraded.

Copying Packages

Note: Copying packages alone does not prepare the package for export. You must also run the create rule or non-rule process, which attaches all elements to the package.

Pages Used to Copy Packages

| <i>Page Name</i> | <i>Definition Name</i> | <i>Usage</i> |
|-----------------------------------|------------------------|---|
| <u>Copy Rule Package Page</u> | GP_PKG_COPY | Copy an existing rule package and its selection criteria. This does not copy the element information. |
| <u>Copy Non-Rule Package Page</u> | GP_NR_PKG_COPY | Copy an existing non-rule package and its selection criteria. This does not copy the element information. |

Copy Rule Package Page

Use the Copy Rule Package page (GP_PKG_COPY) to copy an existing rule package and its selection criteria.

This does not copy the element information.

Navigation:

Set Up HCM > Product Related > Global Payroll & Absence Mgmt > Elements > Manage Global Payroll Packages > Copy Rule Package > Copy Rule Package

This example illustrates the fields and controls on the Copy Rule Package.

Copy Rule Package

Package ID **GMX88RUE** Global Payroll MEX Trans 8.80

*Copy To Package ID

*Description

Copy Package Definition

| <i>Field or Control</i> | <i>Description</i> |
|--------------------------------|---|
| Copy To Package ID | Enter up to eight alphanumeric characters for the new package ID. |
| Copy Package Definition | Click to copy the package. |

Copy Non-Rule Package Page

Use the Copy Non-Rule Package page (GP_NR_PKG_COPY) to copy an existing non-rule package and its selection criteria.

This does not copy the element information.

Navigation:

Set Up HCM > Product Related > Global Payroll & Absence Mgmt > Elements > Manage Global Payroll Packages > Copy Non-Rule Package > Copy Non-Rule Package

See the field descriptions for the Copy Rule Package page.

Related Links

[Copy Rule Package Page](#)

Stamping and Packaging Elements by Version

Pages Used to Stamp and Package Elements by Version

| <i>Page Name</i> | <i>Definition Name</i> | <i>Usage</i> |
|---------------------------------------|------------------------|--|
| Version Stamping Page | GP_STAMPING | Stamp elements with a new version number, and initiate the stamping process. |

| Page Name | Definition Name | Usage |
|--|------------------------|---|
| <u>Define Version Relationships Page</u> | GP_VER_RULE_DFN | View version relationships between element definition records. Displays the Rule Definition record and the corresponding child records. |

Understanding How to Stamp and Package Elements by Version

Versioning is a way to track the elements that were delivered for each release or update and to package elements by version. For example, elements delivered with Absence Management 8.9 are labeled 8.90.00. Major releases, updates, and hot fixes typically require a new version of all or some previously delivered rules.

You can assign a version number (or label) to multiple elements and use the versioning utilities to package elements by version so that they can be moved to another database.

When you package elements by version, the system pulls the rows associated with the version that you specify. Once the elements are packaged, you can move them across databases, using the same procedures that apply to rule packages; you export the elements, compare them with existing elements in the database, and complete the upgrade.

To package elements by version:

1. Stamp the appropriate version number(s) on the elements that you want to package using the Version Stamping (GP_STAMPING) component.
2. Use the Define Criteria By Version page of the Create/Export Rule Package (GP_PKG_CREXP) component to define selection criteria for packaging the elements that you stamped in step 1.
3. Follow all other instructions presented elsewhere in this documentation for creating and exporting rule packages.

See [Creating and Exporting Rule Packages](#).

4. Follow the instructions presented elsewhere in this documentation for importing, comparing, and upgrading rule packages.

See [Importing, Comparing, and Upgrading Rule Packages](#).

Related Links

[Defining Element Names](#)

Version Stamping Page

Use the Version Stamping page (GP_STAMPING) to stamp elements with a new version number, and initiate the stamping process.

Navigation:

Set Up HCM > Product Related > Global Payroll & Absence Mgmt > Elements > Manage Global Payroll Packages > Version Stamping > Version Stamping

This example illustrates the fields and controls on the Version Stamping page.

Use this page to *stamp* a version on elements that you add or modify or to restamp an existing version of an element.

| Field or Control | Description |
|-------------------------|---|
| Used By | You can stamp elements that are applicable to all countries or limit the stamping to one country. If you select <i>All Countries</i> , the Country field defaults to <i>All</i> . If you select <i>Specific Country</i> , specify the country code in the Country field. |
| Stamp Type | Indicate the elements to stamp: <i>Blank</i> : Elements that have no existing version. <i>Existing Version</i> : Elements whose version is what you specified in the Existing Version field. <i>Blank and Existing Version</i> : Elements with no existing version and elements associated with the version that you specified in the Existing Version field. |
| Existing Version | Becomes available when you select <i>Existing Version</i> or <i>Blank and Existing Version</i> as the stamp type. Select from any existing version. The system looks for all elements associated with the version that you select. |

| Field or Control | Description |
|-------------------------------------|---|
| New Version | Enter up to 16 alphanumeric characters for the name of the new version. The system adds the prefix <i>C_</i> to the name if this is a customer installation. A package coming from the PeopleSoft system would have version numbers, preceded by <i>P_</i> . When using the User Version functionality provided on the Element Name page, the system adds the prefix <i>INT_</i> to those versions. The Element name page is documented in another section of this documentation. See Defining Element Names . |
| Stamp Global Payroll Records | Click to initiate the stamping process. The system stamps the selected elements with the new version after clearing the existing Version entries, if any. |

Note: Versioning occurs only in element definition records (records with a primary key of PIN_NUM).

Define Version Relationships Page

Use the Define Version Relationships page (GP_VER_RULE_DFN) to view version relationships between element definition records.

Displays the Rule Definition record and the corresponding child records.

Navigation:

Set Up HCM > Product Related > Global Payroll & Absence Mgmt > Elements > Manage Global Payroll Packages > Define Version Relationships > Define Version Relationships

This example illustrates the fields and controls on the Define Version Relationships page.

Define Version Relationships

Rule Definition Record GP_ACCUMULATOR

| Child Records | | | | | | Personalize Find View All | First 1-3 of 3 Last |
|----------------|--------------------------------|-------------------------------------|-------------------------------------|------------------|----------------------------------|----------------------------------|-----------------------|
| *Child Record | Record Description | Export Record | Rule Record In Buffer | PIN Number Field | | | |
| GP_ACCUMULATOR | GP Accumulator Definition | <input checked="" type="checkbox"/> | <input checked="" type="checkbox"/> | PIN_NUM | <input type="button" value="+"/> | <input type="button" value="-"/> | |
| GP_ACM_MBR | GP Accumulator Members | <input checked="" type="checkbox"/> | <input checked="" type="checkbox"/> | PIN_NUM | <input type="button" value="+"/> | <input type="button" value="-"/> | |
| GP_ACM_MBR_VW | View of Accumulator Member rec | <input type="checkbox"/> | <input type="checkbox"/> | PIN_MBR_NUM | <input type="button" value="+"/> | <input type="button" value="-"/> | |

| Field or Control | Description |
|-------------------------------|--|
| Rule Definition Record | Displays the name of the parent record that contains the field GP_VERSION. |

| Field or Control | Description |
|------------------------------|---|
| Child Record | Displays the child record whose data when changed causes GP_VERSION to be cleared from the corresponding row in parent record. (The name of the parent record is displayed here if there are no children.) |
| Export Record | <p>Selected if the child record is to be included in the version package for export and import.</p> <p>For example, when an accumulator element changes, only data in GP_ACCUMULATOR and GP_ACM_MBR needs to be moved. The child record, GP_ACM_MBR_VW, does not need to be exported and imported because it is used only to associate accumulators with earnings and deductions in the Earnings and Deductions components.</p> |
| Rule Record in Buffer | <p>Applicable to accumulators only.</p> <p>Selected if the record that has GP_VERSION is in the component buffer (for example, when an earning accumulator is changed, and needs GP_VERSION cleared). Record GP_ACCUMULATOR is not in the component buffer. Select this check box to prevent the system from looking for the record in RECNAME_RULE_DFN in the component buffer and issue a SQLEXEC instead. The child record that exists in the earnings component is GP_ACM_MBR_VW.</p> |
| PIN Number Field | Displays the name of the PIN_NUM field on the record that needs GP_VERSION cleared. Using the earlier example, the earning accumulator PIN_NUM is contained as PIN_MBR_NUM in the earnings component buffer and PIN_NUM itself contains the earning PIN. So, when updating data for GP_ACCUMULATOR, data for PIN_MBR_NUM value and not PIN_NUM value from the earnings component must be updated. |

Defining Security

Understanding Security

Security refers to the ability to restrict users from viewing or updating certain data or payees.

In Absence Management, there are two levels of security:

- Element-level security

Restricts the elements that a user can view or update, based on the User Rules Profile page and the **Used By**, **Owner**, and **Override Levels** fields on the Element Name page.

- Payee-level security

Restricts the payees that a user can view, based on the standard department-level security in PeopleSoft HR.

Note: Absence Management can also use the group security feature in PeopleSoft Time and Labor.

Element Usage Security

You set up profiles for your users that give them access to country-specific element information. For example, if your organization operates only in France, users do not need element information that is specific to the United Kingdom. *Element-usage security* limits the number of elements that appear in prompt tables to those that are relevant to the user.

Owner Security

Owner security refers to who owns and maintains an element—PeopleSoft or the customer. Certain elements can be modified only by PeopleSoft, while others can be modified by the customer.

The **Owner** field on the Element Name page identifies an element's owner.

Related Links

[Defining Element Names](#)

Override Levels

Override levels for an element vary, depending on the element type. Typical override levels include Pay Entity, Pay Group, Pay Calendar, Payee, and Via Elements. You indicate these on the Element Name page by using check boxes. These check boxes indicate whether the element can be updated through overrides or by another element.

The update Via Element security feature controls which elements can be updated by another element. You can update an element by means of another element in four places in the application:

- Arrays (through the **Map Retrieved Fields to Variable Elements** fields on the Field Map and Keys page).
- Brackets (through the **Return Columns** fields on the Bracket Search Keys/Return Columns page).
- Dates (through the **Date Extract** fields on the Date Extract page).
- Formulas (through the **Assign To** columns on the Formula Field-by-Field Definition page).

The system checks the User Rules Profile and element-usage security to ensure that the only elements that are available for access can be updated by another element.

Related Links

[Defining Element Names](#)

Common Elements Used to Define Security

| <i>Field or Control</i> | <i>Description</i> |
|---|---|
| Prompt edits | Records or views that you use as an online prompt on a specified field. |
| Query security records | Records or views that you use in PeopleSoft Query. |
| Search records and search views | Records and views that you use to access a component. |

Restricting User Access

You can control whether a user can access elements that are defined for all countries or for a specific country and whether a user can take control of PeopleSoft-delivered and maintained elements.

Page Used to Restrict User Access

| Page Name | Definition Name | Usage |
|-------------------------|------------------------|--|
| User Rules Profile Page | GP_OPR_RULE_PRF | Control whether a user has access to elements defined for all countries or a specific country. Also define if users can take control of PeopleSoft Delivered/Maintained elements. Create a user ID in PeopleTools before using this page. |

Understanding How to Restrict Access to Country-Specific Elements

When you create an element, you designate (in the **Used By** field of the Element Name page) whether it can be used by all countries or by a specific country. An element cannot use an element that is defined at a lower level. For instance, a duration element that is defined for *All Countries* cannot use a variable defined for only one country—France, for example. It can only use elements defined for *All Countries*. However, a duration that is defined for France can use variables defined for France as well as variables defined for *All Countries*.

The User Rules Profile page defines the default values that users see in the **Used By** and **Country** fields when adding an element.

This table shows how the settings on the User Rules Profile page affect the **Used By** and **Country** fields on the Element Name page:

| User Rules Profile page | Element Name page |
|--------------------------------|---|
| Used By = All Countries | Used By = All Countries is the default. Country field defaults to value <i>ALL</i> . |
| Used By = Specific Country | Used By = Specific Country and can't be changed. Country field defaults to Country and can't be changed. |

Warning! Carefully consider the consequences of changing the **Used By** field after you save an element that is defined for *All Countries*.. Problems can result if the element has been used in absence processing.

Note: The User Rule Profile in Absence Management is in addition to the User Rules Profile in HR.

User Rules Profile Page

Use the User Rules Profile page (GP_OPR_RULE_PRF) to control whether a user has access to elements defined for all countries or a specific country.

Also define if users can take control of PeopleSoft Delivered/Maintained elements. Create a user ID in PeopleTools before using this page.

Navigation:

Set Up HCM > Security > User Maintenance > Global Payroll User Profile > User Rules Profile

This example illustrates the fields and controls on the Global Payroll User Profile .

All search views refer to the information that you enter here to determine which elements to display.

Session Default

| <i>Field or Control</i> | <i>Description</i> |
|---|--|
| <p>Used By</p> | <p>Specify which elements the users with this User ID can access. Values are:</p> <p><i>All Countries:</i> Elements defined for All Countries.</p> <p><i>Specific Country:</i> Elements defined only for the country you select in the Country field.</p> <hr/> <p>Note: You associate a rule with a country when you define an element on the Element Name page.</p> <hr/> |
| <p>Allow PS Element Change (allow PeopleSoft element change)</p> | <p>Select to enable users to take control of PS Delivered/Maintained elements. Taking control of an element means that a user can edit the element's definition and change the element owner to PS Delivered-Customer Modified. Once a user takes control of an element, it cannot be changed back to PS Delivered/Maintained.</p> <p>See the product documentation for <i>PeopleTools: Security Administration</i>.</p> |

Related Links

[Defining Element Names](#)

Element Security

This topic discusses the security that governs element selection from within a component.

The following tables describe element-level security by menus and components. Following is an example of the Search page that is referred to in the tables:

This example illustrates the fields and controls on the Search page.

Variables

Enter any information you have and click Search. Leave fields blank for a list of all values.

▼ Search Criteria

Element Name:

Description:

Country: 

Include History Correct History Case Sensitive

Set Up HCM, Product Related, Global Payroll & Absence Mgmt, Elements - All Element Definition Components

| Security on the Search Page | Security Governing Element Selection From Within the Component |
|--|--|
| <p>Add Mode - When you add a new element, the system has no information about the element, so there is no security.</p> <p>Applicable to Non-Add mode.</p> <p>If User Rules Profile = <i>All Countries</i>, then Used By = <i>All Countries</i></p> <p>Or</p> <p>Used By = <i>Specific Country</i>.</p> <p>If User Rules Profile = <i>Specific Country</i>, then Used By = <i>All Countries</i></p> <p>Or</p> <p>Used By = <i>Specific Country</i>. Country must match the Country on the User Rules Profile page.</p> | <p><i>Element-usage security:</i></p> <p>If Used By = <i>All Countries</i>, then the elements it can use must also be Used By = <i>All Countries</i>.</p> <p>If Used By = <i>Specific Country</i>, then the elements it can use must also be Used By = <i>All Countries</i></p> <p>Or</p> <p>The elements it can use must be Used By = <i>Specific Country</i>, and the value in the Country field must equal the country that the element is being used by.</p> <p><i>Update by element security:</i></p> <p>For the following elements, you can update element security with the Via Element override check box on the Element Name page:</p> <ul style="list-style-type: none"> - Formula definitions/Assigned To field. - Date definitions/Date Extract fields. - Bracket definitions/Return Column field. - Array definitions/Retrieved fields. <hr/> <p>Note: If User Rules = <i>Specific Country</i>, you cannot change the Used By field on such an element.</p> |

Set Up HCM, Product Related, Global Payroll & Absence Mgmt, Framework, Organizational, Eligibility Groups

| Security on the Search Page | Security Governing Element Selection From Within the Component |
|--|--|
| <p>Security is handled inside the component.</p> | <p><i>Element usage (which element groups appear on the prompt list):</i></p> <p>If User Rules Profile = <i>All Countries</i>, then No security.</p> <p>If User Rules Profile = <i>Specific Country</i>, then Used By = <i>All Countries</i></p> <p>Or</p> <p>Used By = <i>Specific Country</i>. Country on the Element Name page must match the Country on the User Rules Profile page.</p> |

Set Up HCM, Product Related, Global Payroll & Absence Mgmt, Framework, Organizational, Pay Entities

| Security on the Search Page | Security Governing Element Selection From Within the Component |
|---|--|
| <p>Add Mode - When you add a new Pay Entity, the system has no information about the Pay Entity, so there is no security</p> <p>Applicable to Non-Add mode.</p> <p>If User Rules Profile = <i>All Countries</i>, then No security.</p> <p>If User Rules Profile = <i>Specific Country</i>, then Pay Entity Country must = User Country.</p> | <p><i>Supporting Element Overrides - element usage is based on Pay Entity Country:</i></p> <p>You must enter Pay Entity Country before entering any Supporting Element Overrides.</p> <p>Used By = <i>All Countries</i></p> <p>Or</p> <p>Used By = <i>Specific Country</i>, and Country on the Element Name page matches Country on the Pay Entity page.</p> <p>Pay Entity Override is selected on the Element Name page.</p> |

Set Up HCM, Product Related, Global Payroll & Absence Mgmt, Framework, Organizational, Pay Groups

| Security on the Search Page | Security Governing Element Selection From Within the Component |
|---|---|
| <p>Add Mode - When you add a new Pay Group, the system has no information about the Pay Group, so there is no security.</p> <p>Mode does not equal Add.</p> <p>If User Rules = <i>All Countries</i>, then No security. If User Rules Profile = <i>Specific Country</i>, then Pay Entity Country = User Country.</p> | <p><i>Rounding/Proration elements - element usage is based on Pay Entity Country:</i></p> <p>Used By = <i>All Countries</i></p> <p>Or</p> <p>Used By = <i>Specific Country</i>, and Country matches Pay Entity Country.</p> <p><i>Supporting Element Overrides - element usage is based on Pay Entity Country:</i></p> <p>Used By = <i>All Countries</i></p> <p>Or</p> <p>Used By = <i>Specific Country</i>, and Country matches Pay Entity Country.</p> <p>Pay Group Override is selected on the Element Name page.</p> |

Set Up HCM, Product Related, Global Payroll & Absence Mgmt, Framework, Processing - Run Types

| Security on the Search Page | Security Governing Element Selection From Within the Component |
|--|---|
| <p>Security is handled inside the component.</p> | <p><i>Element usage (which process list appears on the prompt list):</i></p> <p>If User Rules Profile = <i>All Countries</i>, then No security.</p> <p>If User Rules Profile = <i>Specific Country</i>, then Used By = <i>All Countries</i></p> <p>Or</p> <p>Used By = <i>Specific Country</i>, and Country matches User Country.</p> |

Set Up HCM, Product Related, Global Payroll & Absence Mgmt, Framework, Calendars, Calendars

| Security in the Search Page | Security Governing Element Selection From Within the Component |
|--|--|
| <p>Applicable to all modes (in relation to the Pay Group field).</p> <p>If User Rules Profile = <i>All Countries</i>, then No security.</p> <p>If User Rules Profile = <i>Specific Country</i>, then Pay Entity Country that is associated with the pay group must match User Country.</p> | <p><i>Supporting Element Overrides and Elements to Exclude - element usage is based on Pay Entity Country:</i></p> <p>Used By = <i>All Countries</i></p> <p>Or</p> <p>Used By = <i>Specific Country</i>, and Country matches Pay Entity Country.</p> <p>Calendar override check box must be selected.</p> |

Set Up HCM, Product Related, Global Payroll & Absence Mgmt, Framework, Calendars, Calendar Group

| Security in the Search Page | Security Governing Element Selection From Within the Component |
|---|--|
| <p>Add Mode - When you add a new calendar group, the system has no information about the calendar group, so there is no security.</p> <p>Applicable to Non-Add mode.</p> <p>If User Rules Profile = <i>All Countries</i>, then</p> <p>No security.</p> <p>If User Rules Profile = <i>Specific Country</i>, then</p> <p>Calendar Run ID Country must match User Country.</p> | <p><i>Country - Valid countries are based on User Rules Profile Country:</i></p> <p>If User Rules Profile = <i>All Countries</i>, then No security</p> <p>If User Rules Profile = <i>Specific Country</i>, then Calendar Run ID Country appears as the default in User Country and cannot be changed.</p> <p><i>Pay Entity/Pay Group/Calendar ID is based on Calendar Run ID Country:</i></p> <p>You must enter Calendar Run ID Country before entering Pay Groups, or Calendar IDs.</p> <p>Pay Group Country (Country of the Pay Entity that is associated with the Pay Group) must match Calendar Run ID Country.</p> <p>Calendar Country (of the Pay Entity Country that is associated with Pay Group for Calendar) must match Calendar Run ID Country.</p> |

Set Up HCM, Product Related, Global Payroll & Absence Mgmt, Triggers, Retro Process Definitions

| Security on the Search Page | Security Governing Element Selection From Within the Component |
|---|---|
| <p>For all modes.</p> <p>If User Rules Profile = <i>All Countries</i>, then</p> <p>No security.</p> <p>If User Rules Profile = <i>Specific Country</i>, then</p> <p>Country = User Country.</p> | <p>Security is handled by the search page security.</p> |

Set Up HCM, Product Related, Global Payroll & Absence Mgmt, Triggers, Retro Process Overrides

| Security on the Search Page | Security Governing Element Selection From Within the Component |
|---|--|
| <p>For all modes.</p> <p>If User Rules Profile = <i>All Countries</i>, then</p> <p>No security.</p> <p>If User Rules Profile = <i>Specific Country</i>, then</p> <p>Country = User Country.</p> | <p><i>Formula Element, Element, and Forward to Element - element usage is based on Retro Process Definition Country:</i></p> <p>Used By = <i>All Countries</i></p> <p>Or</p> <p>Used By = <i>Specific Country</i>, and Country matches Retro Process Definition Country.</p> |

Set Up HCM, Product Related, Global Payroll & Absence Mgmt, Triggers, Retro Event Definitions (retroactive event definitions)

| Security on the Search Page | Security Governing Element Selection From Within the Component |
|---|--|
| <p><i>Country Security (which countries appear on prompt list):</i></p> <p>If User Rules Profile = <i>All Countries</i>, then</p> <p>User is allowed to work on any country in Absence Management.</p> <p>If User Rules Profile = <i>Specific Country</i>, then</p> <p>The only valid value is the Country that matches User Country. This value is defaulted in and the field is disabled.</p> | <p><i>Retro Process Definition (for Event Process Definition) Security (which retro process definitions appear in prompt list):.</i></p> <p>The Country on the Retro Process Definition must match the selected Country.</p> |

Set Up HCM, Product Related, Global Payroll & Absence Mgmt, Triggers, Segmentation Event Definition

| Security on the Search Page | Security Governing Element Selection From Within the Component |
|---|--|
| <p><i>Country Security (which countries appear in prompt list):</i></p> <p>If User Rules Profile = <i>All Countries</i>, then</p> <p>User can work on any country in Absence Management.</p> <p>If User Rules Profile = <i>Specific Country</i>, then</p> <p>The only valid value is the Country that matches User Country. This value is defaulted in and the field is disabled.</p> | <p><i>Element usage is based on Country of Event:</i></p> <p>Used By = <i>All Countries</i></p> <p>Or</p> <p>Used By = <i>Specific Country</i>, and Country matches Event Country.</p> |

Set Up HCM, Product Related, Global Payroll & Absence Mgmt, Triggers, Trigger Definition

| Security on the Search Page | Security Governing Element Selection From Within the Component |
|---|--|
| <p><i>Country Security (which countries appear in prompt list):</i></p> <p>If User Rules Profile = <i>All Countries</i>, then</p> <p>User can work on any country in Absence Management.</p> <p>If User Rules Profile = <i>Specific Country</i>, then</p> <p>The only valid value is the Country that matches User Country. This value is defaulted in and the field is disabled.</p> | <p>In the Trigger Event ID field, the system shows only trigger event IDs that are valid for the country selected. In addition, for the trigger type of Segmentation and record = GP_PYE_OVRD, the user must select elements on the Trigger Definitions – Field Values page. Available elements are those with Used By = <i>All Countries</i> or Used By = the country of the trigger definition.</p> |

Set Up HCM, Product Related, Global Payroll & Absence Mgmt, Elements, View Element Names, Element Name

Security for the View Element Names component is based on the User Rules Profile. If a user has access to *All Countries*, the user can see elements for all countries. If the user has access to a specific country only, the user can see elements for that country only or elements defined for *All Countries*.

Set Up HCM, Product Related, Global Payroll & Absence Mgmt, Elements, Supporting Elements - Element Name and View System Elements by Source

The View System Elements by Source component shows only system elements. Because these elements are always defined for *All Countries*, any user can view them.

Payee Security

This topic discusses payee security by HR and group.

Payee payroll data is sensitive information because it often contains pay-related information. Absence Management provides payee-level security that restricts the payees that a user can view.

HR Security

Absence Management delivers the standard HR security. Payee-level security affects all Absence Management reports as well as every component, search record or view, and prompt record and view that contains the EMPLID field. All components that are entered with an employee ID contain payee-level security.

A security tree is used to limit the payees that a user can view or report on.

The following tables indicate payee-level security by menus and components.

Global Payroll & Absence Mgmt, Payee Data, Create Overrides, Supporting Elements

| <i>Security on the Search Page</i> | <i>Security Governing Element Selection From Within the Component</i> |
|---|---|
| <p>Payee-level security applies.</p> | <p>Element Usage (based on Country of Payee which is based on Pay Entity associated with Pay Group)</p> <p>To determine Payee Country, the system first retrieves the Pay Group for the Payee from the JOB record. Then the system retrieves the Pay Entity that is associated with this Pay Group and looks at the Country. If a JOB row cannot be found, the country associated with the user that has logged in is used. This is the country in the User Rules Profile data for that user.</p> <p>Used By = All Countries</p> <p>Or</p> <p>Used By = Specific Country, and Country matches Payee Country. Payee Override also needs to be selected on the Element Name page.</p> |

Group Security

Absence Management utilizes HR Direct Reports security to grant managers access in order to request absence, view absence history, and view absence balances on behalf or direct reports. Time and Labor utilizes group security to grant managers and administrators access in order to report, approve, process and view time entries for a defined group of employees. If you are using Absence Management and Time and Labor self service applications, it is important to maintain consistency between setup of HR

Direct Reports and Time and Labor's Group Security. This will provide consistency for managers when accessing the self service components in each application.

See the product documentation for *PeopleTools: Security Administration*.

Related Links

“Understanding Static and Dynamic Groups” (PeopleSoft Time and Labor)

Viewing Delivered Elements and System Data

Understanding the Delivered System Data

Absence Management delivers a set of system data consisting of predefined rules that you can use when configuring your system. You do not need to define these rules. They are part of the Absence Management core application and can be used wherever you need them.

Note: All system elements are delivered and are considered to be system data.

See [Working with System Elements](#).

Warning! Do not modify this system data. Many Absence Management calculations assume that the value of the system data remains consistent. Modifying them can jeopardize the integrity of the system.

This table lists the delivered system data:

| <i>Element Type</i> | <i>Element Name</i> | <i>Description</i> | <i>Comments</i> |
|---------------------|---------------------|--------------------------------|--|
| Array | GP AR PSLP GRP ID | Payslip message group ID. | |
| Array | GP AR PSLP MSG PBD | Payslip message active. | Array to read PLSP_MSGs managed in GP that are active. |
| Array | GP AR PSLP PLIST | Payslip message HR group list. | |
| Count | GP WORK DAY COUNT | Work day count. | Counts the number of workdays. Used with the standard proration element GP PRORATE WRK DAY. For this count element, a day is considered a workday if scheduled hours are greater than zero. |
| Count | GP WORK HRS COUNT | Work hours count. | Counts the number of workdays. Used with the standard proration element GP PRORATE WRK HRS. For this count element, count the number of scheduled hours. |

| Element Type | Element Name | Description | Comments |
|---------------------|---------------------|---------------------------|---|
| Duration | GP YEARS OF SVC | Years of service. | Calculates the years of service based on the hire date through the calendar period end date. |
| Duration | GP MONTHS OF SVC | Months of service. | Calculates the months of service based on the hire date through the calendar period end date. |
| Duration | GP DAYS OF SVC | Days of service. | Calculates the days of service based on the hire date through the calendar period end date. |
| Duration | GP AGE IN YEARS | Age in years. | Calculates the age of person in years from the birth date through the calendar period end date. |
| Duration | GP AGE IN MONTHS | Age in months. | Calculates the age of person in months from the birth date through the calendar period end date. |
| Duration | GP AGE IN DAYS | Age in days. | Calculates the age of person in days from the birth date through the calendar period end date. |
| Duration | GP CAL DAYS SLICE | Calendar days in slice. | Calculates the number of calendar days in the slice. Used in the proration element GP PRORATE CAL DAYS. |
| Duration | GP CAL DAYS SEG | Calendar days in segment. | Calculates the number of calendar days in the segment. |
| Duration | GP CAL DAYS PERIOD | Calendar days in period. | Calculates the number of calendar days in the calendar period. Used in the proration element GP PRORATE CAL DAYS. |
| Date | GP ABS BGN DT - 1 | Absence begin date - 1. | |

| Element Type | Element Name | Description | Comments |
|---------------------|---------------------|----------------------------------|---|
| Date | GP PMNT DT EXTR | Payment date, date extract. | Returns three variable elements (GP PMNT DATE YR, GP PMNT DATE MO, GP PMNT DATE DY) that will resolve to the year, month, and day of the Calendar Payment Date. |
| Date | GP PRD BGN DT EXTR | Period begin date, date extract. | Returns three variable elements (GP PRD BGN DATE YR, GP PRD BGN DATE MO, GP PRD BGN DATE DY) that will resolve to the year, month, and day of the Calendar Period Begin Date. |
| Date | GP SLICE END DT +1 | Slice end date, plus one day. | Returns the slice end date, plus one day. Used in a duration element GP CAL DAYS SLICE that calculates the number of calendar days in a slice. |
| Date | GP SEG END DT +1 | Segment end date, plus one day. | Returns the segment end date, plus one day. Used in a duration element GP CAL DAYS SEG that calculates the number of calendar days in a segment. |
| Date | GP SEG END DT EXTR | Segment end date, date extract. | |
| Date | GP SLI BGN DT EXTR | Slice begin date, date extract. | |
| Date | GP SLI END DT EXTR | Slice end date, date extract. | |
| Date | GP PRD END DT +1 | Period end date, plus one day. | Returns the period end date, plus one day. Used in a duration element GP CAL DAYS PERIOD that calculates the number of calendar days in a calendar period. |

| Element Type | Element Name | Description | Comments |
|---------------------|---------------------|-----------------------------------|---|
| Date | GP PRD END DT EXTR | Period end date, date extract. | Returns three variable elements (GP PRD END DATE YR, GP PRD END DATE MO, and GP PRD END DATE DY) that resolve to the year, month, and day of the calendar period end date. |
| Date | GP SEG BGN DT EXTR | Segment begin date, date extract. | |
| Error message | MSG PIN | Call Error Message | Triggers the writing of a message, when entered in a Formula element. Before executing this element, the same formula must populate other system elements, such as MSG_NBR, MSG_SET_NBR, and MSG_PAYMENT_ERR. |
| Formula | GP JANUARY | January. | Returns True if the month of the calendar period is January; otherwise False. |
| Formula | GP FEBRUARY | February. | Returns True if the month of the calendar period is February; otherwise False. |
| Formula | GP MARCH | March. | Returns True if the month of the calendar period is March; otherwise False. |
| Formula | GP APRIL | April. | Returns True if the month of the calendar period is April; otherwise False. |
| Formula | GP MAY | May. | Returns True if the month of the calendar period is May; otherwise False. |
| Formula | GP JUNE | June. | Returns True if the month of the calendar period is June; otherwise False. |
| Formula | GP JULY | July. | Returns True if the month of the calendar period is July; otherwise False. |

| Element Type | Element Name | Description | Comments |
|---------------------|---------------------|-------------------------|--|
| Formula | GP AUGUST | August. | Returns True if the month of the calendar period is August; otherwise False. |
| Formula | GP SEPTEMBER | September. | Returns True if the month of the calendar period is September; otherwise False. |
| Formula | GP OCTOBER | October. | Returns True if the month of the Calendar Period is October; otherwise False. |
| Formula | GP NOVEMBER | November. | Returns True if the month of the calendar period is November; otherwise False. |
| Formula | GP DECEMBER | December. | Returns True if the month of the calendar period is December; otherwise False. |
| Formula | GP COUNT WORK DAYS | Workday count. | Returns True if scheduled hours are greater than zero; otherwise False. Used in the count element GP WORK DAY COUNT to count the number of workdays. |
| Formula | GP COUNT WORK HRS | Work hour count. | Returns the number of work hours for a day. Used in the count element GP WORK HRS COUNT to count the number of work hours. |
| Formula | GP CHECK 1ST SEG | Check if first segment. | Returns True if you are in the first segment of a calendar for a payee; otherwise False. Determined by checking the value of the system element FIRST SEGMENT. |
| Formula | GP CHECK LST SEG | Check last segment. | Returns True if you are in the last segment of a calendar for a payee; otherwise False. This is determined by checking the value of the system element LAST SEGMENT. |

| <i>Element Type</i> | <i>Element Name</i> | <i>Description</i> | <i>Comments</i> |
|---------------------|---------------------|---------------------------------|--|
| Formula | GP CHK 1ST ACT SEG | Check first active segment. | Returns True if you are in the first active segment of a calendar for a payee; otherwise False. This is determined by checking the value of the system element FIRST ACT SEGMENT. |
| Formula | GP CHK LST ACT SEG | Check last active segment. | Returns True if you are in the last active segment of a calendar for a payee; otherwise False. This is determined by checking the value of the system element LAST ACT SEGMENT. |
| Formula | GP FM PSLP AR | Payslip messages duration. | (Duration formula). Calls GP FM PSLP SEL (population) when duration criteria is met. |
| Formula | GP FM PSLP SEL | Payslip messages duration. | (Population formula). Writes to the writable array If the EmplID meets the population criteria in the Message Definition. The message definition may have specified that a custom formula will be used to determine the criteria. |
| Formula | GP RETRO OVERRIDE | Retro process override formula. | |
| Generation Control | GP QTR END ONLY | Quarter end only. | Checks generation control based on the quarter-end date. The quarter-end date is based on a predefined generation control frequency of QTR END (which references a frequency with a factor of 4). Note: For generation control frequency to be True, enter the matching generation control frequency on any calendar for which you want generation control to be True. |

| <i>Element Type</i> | <i>Element Name</i> | <i>Description</i> | <i>Comments</i> |
|---------------------|---------------------|------------------------------------|---|
| Generation Control | GP YEAR END ONLY | Year end only. | <p>Checks generation control based on the year-end date. The year-end date is based on a predefined generation control frequency of YEAR END (which references a frequency with a factor of 1).</p> <hr/> <p>Note: For generation control frequency to be True, you must enter the matching generation control frequency on any calendar for which you want generation control to be True.</p> <hr/> |
| Generation Control | GP APPLY 1ST SEG | Apply once - first segment. | <p>Checks generation control based on whether the calculation is in the first segment (in a calendar). Generation control is True if you are in the first segment or False if you are not.</p> |
| Generation Control | GP APPLY LST SEG | Apply once - last segment. | <p>Checks generation control based on whether the calculation is in the last segment (in a calendar). Generation control is True if you are in the last segment or False if you are not.</p> |
| Generation Control | GP APPLY LST A SEG | Apply once - last active segment. | <p>Checks generation control based on whether the calculation is in the last active segment (in a calendar). Generation control is True if you are in the last active segment or False if you are not.</p> |
| Generation Control | GP APPLY 1ST A SEG | Apply once - first active segment. | <p>Checks generation control based on whether the calculation is in the first active segment (in a calendar). Generation control is True if you are in the first active segment or False if you are not.</p> |
| Proration Rule | GP PRORATE CAL DAY | Proration based on calendar days. | Provides basic proration logic based on calendar days. |

| Element Type | Element Name | Description | Comments |
|---------------------|---------------------|---------------------------------------|---|
| Proration Rule | GP PRORATE WRK DAY | Proration based on workdays. | Provides basic proration logic based on workdays. |
| Proration Rule | GP PRORATE WRK HRS | Proration based on work hours. | Provides basic proration logic based on work hours. |
| Rounding Rule | GP ROUND NEAR 0DEC | Round to nearest zero decimal places. | Rounds to nearest (up if greater than or equal to 5; otherwise down) zero decimal places. |
| Rounding Rule | GP ROUND NEAR 2DEC | Round to nearest two decimal places. | Rounds to nearest (up if greater than or equal to 5; otherwise down) two decimal places. |
| Rounding Rule | GP ROUND UP 0DEC | Round up to zero decimal places. | Rounds up to zero decimal places. |
| Rounding Rule | GP ROUND UP 2DEC | Round up to two decimal places. | Rounds up to two decimal places. |
| Rounding Rule | GP ROUND DOWN 0DEC | Round down to zero decimal places. | Rounds down (truncates) to zero decimal places. |
| Rounding Rule | GP ROUND DOWN 2DEC | Round down to two decimal places. | Rounds down (truncates) to two decimal places. |
| Variable | GP TEMP001 CHAR | Temporary variable - character. | For use in formulas as a <i>temporary</i> variable (to calculate intermediate results). |
| Variable | GP TEMP002 CHAR | Temporary variable - character. | For use in formulas as a <i>temporary</i> variable (to calculate intermediate results). |
| Variable | GP TEMP003 CHAR | Temporary variable - character. | For use in formulas as a <i>temporary</i> variable (to calculate intermediate results). |
| Variable | GP TEMP004 CHAR | Temporary variable - character. | For use in formulas as a <i>temporary</i> variable (to calculate intermediate results). |
| Variable | GP TEMP005 CHAR | Temporary variable - character. | For use in formulas as a <i>temporary</i> variable (to calculate intermediate results). |

| Element Type | Element Name | Description | Comments |
|---------------------|---------------------|---------------------------------|---|
| Variable | GP TEMP006 CHAR | Temporary variable - character. | For use in formulas as a <i>temporary</i> variable (to calculate intermediate results). |
| Variable | GP TEMP007 CHAR | Temporary variable - character. | For use in formulas as a <i>temporary</i> variable (to calculate intermediate results). |
| Variable | GP TEMP008 CHAR | Temporary variable - character. | For use in formulas as a <i>temporary</i> variable (to calculate intermediate results). |
| Variable | GP TEMP009 CHAR | Temporary variable - character. | For use in formulas as a <i>temporary</i> variable (to calculate intermediate results). |
| Variable | GP TEMP010 CHAR | Temporary variable - character. | For use in formulas as a <i>temporary</i> variable (to calculate intermediate results). |
| Variable | GP TEMP001 NUM | Temporary variable - number. | For use in formulas as a <i>temporary</i> variable (to calculate intermediate results). |
| Variable | GP TEMP002 NUM | Temporary variable - number. | For use in formulas as a <i>temporary</i> variable (to calculate intermediate results). |
| Variable | GP TEMP003 NUM | Temporary variable - number. | For use in formulas as a <i>temporary</i> variable (to calculate intermediate results). |
| Variable | GP TEMP004 NUM | Temporary variable - number. | For use in formulas as a <i>temporary</i> variable (to calculate intermediate results). |
| Variable | GP TEMP005 NUM | Temporary variable - number. | For use in formulas as a <i>temporary</i> variable (to calculate intermediate results). |
| Variable | GP TEMP006 NUM | Temporary variable - number. | For use in formulas as a <i>temporary</i> variable (to calculate intermediate results). |
| Variable | GP TEMP007 NUM | Temporary variable - number. | For use in formulas as a <i>temporary</i> variable (to calculate intermediate results). |

| Element Type | Element Name | Description | Comments |
|---------------------|---------------------|------------------------------|--|
| Variable | GP TEMP008 NUM | Temporary variable - number. | For use in formulas as a <i>temporary</i> variable (to calculate intermediate results). |
| Variable | GP TEMP009 NUM | Temporary variable - number. | For use in formulas as a <i>temporary</i> variable (to calculate intermediate results). |
| Variable | GP TEMP010 NUM | Temporary variable - number. | For use in formulas as a <i>temporary</i> variable (to calculate intermediate results). |
| Variable | GP TEMP001 DATE | Temporary variable - date. | For use in formulas as a <i>temporary</i> variable (to calculate intermediate results). |
| Variable | GP TEMP002 DATE | Temporary variable - date. | For use in formulas as a <i>temporary</i> variable (to calculate intermediate results). |
| Variable | GP TEMP003 DATE | Temporary variable - date. | For use in formulas as a <i>temporary</i> variable (to calculate intermediate results). |
| Variable | GP TEMP004 DATE | Temporary variable - date. | For use in formulas as a <i>temporary</i> variable (to calculate intermediate results). |
| Variable | GP TEMP005 DATE | Temporary variable - date. | For use in formulas as a <i>temporary</i> variable (to calculate intermediate results). |
| Variable | GP PRD END DATE YR | Period end date - year. | <p>Stores the calendar period year if the date element GP PRD END DT EXTR is resolved.</p> <hr/> <p>Note: The date element GP PRD END DT EXTR extracts the year from the calendar period and populates the variable GP PRD END DATE DY. For this date extract and corresponding variable to be resolved, either put this date element directly on the process list (include it in a section) or reference it in another element that is being resolved.</p> <hr/> |

| <i>Element Type</i> | <i>Element Name</i> | <i>Description</i> | <i>Comments</i> |
|---------------------|---------------------|--------------------------|--|
| Variable | GP PRD END DATE MO | Period end date - month. | <p>Stores the calendar period month if the date element GP PRD END DT EXTR is resolved.</p> <hr/> <p>Note: The date element GP PRD END DT EXTR extracts the month from the calendar period and populates the variable GP PRD END DATE DY. For this date extract and corresponding variable to be resolved, either put this date element directly on the process list (include it in a section) or reference it in another element that is being resolved.</p> <hr/> |
| Variable | GP PRD END DATE DY | Period end date - day. | <p>Stores the calendar period day, if the date element GP PRD END DT EXTR is resolved.</p> <hr/> <p>Note: The date element GP PRD END DT EXTR extracts the day from the calendar period and populates the variable GP PRD END DATE DY. For this date extract and corresponding variable to be resolved, either put this date element directly on the process list (include it in a section) or reference it in another element that is being resolved.</p> <hr/> |
| Variable | GP TRUE | True. | <p>Default is 1. Can be used in conjunction with formulas to set a value that is equal to True, which can then be used to validate against generation control or other checks.</p> |
| Variable | GP FALSE | False. | <p>Default is 0. Can be used in conjunction with formulas to set a value to False, which can then be used to validate against generation control or other checks.</p> |

| Element Type | Element Name | Description | Comments |
|---------------------|---------------------|--------------------------------|--|
| Variable | GP ACTIVE | Active. | Default is A (active). Can be used in conjunction with formulas to check and compare with an active or inactive status that is retrieved from a different table. |
| Variable | GP GL AFF INTRA1 | Affiliate Intra 1 - Chartfield | |
| Variable | GP GL AFF INTRA2 | Affiliate Intra 2 - Chartfield | |
| Variable | GP GL AFFILIATE | Affiliate - Chartfield | |
| Variable | GP GL ALT ACCOUNT | Alternate Account - Chartfield | |
| Variable | GP GL BUDGET REF | Budget Reference - Chartfield | |
| Variable | GP GL CHARTFIELD1 | Chartfield 1 - Chartfield | |
| Variable | GP GL CHARTFIELD2 | Chartifeld2 - Chartfield | |
| Variable | GP GL CHARTFIELD3 | Chartfield 3 - Chartfield | |
| Variable | GP GL CLASS | Class Field - Chartfield | |
| Variable | GP GL DEPT | GL Department - Chartfield | |
| Variable | GP GL FUND | Fund Code - Chartfield | |
| Variable | GP GL OP UNIT | Operating Unit - Chartfield | |
| Variable | GP GL PRODUCT | Product - Chartfield | |
| Variable | GP GL PROGRAM | Program Code - Chartfield | |
| Variable | GP GL PROJECT | Program Code - Chartfield | |
| Variable | GP NULL DATE | Null Date | Used within rules when a reference to a 'null' date needs to be checked (or initialized). |

| Element Type | Element Name | Description | Comments |
|---------------------|---------------------|---------------------------|---|
| Variable | GP PMNT DATE DY | Payment Date - Day | Stores the Calendar Payment Date 'Day' - if the Date GP PMNT DT EXTR is resolved. Note: The Date element GP PMNT DT EXTR will extract the 'day' from the Calendar Period and populate the variable GP PMNT DATE DY. |
| Variable | GP PMNT DATE MO | Payment Date - Month | Stores the Calendar Payment Date 'Month' - if the Date GP PMNT DT EXTR is resolved. Note: The Date Element GP PMNT DT EXTR will extract the 'month' from the Calendar Period and populate the Variable GP PMNT DATE MO. |
| Variable | GP PMNT DATE YR | Payment End Date - Year | Stores the Calendar Payment Date 'Year' - if the Date GP PMNT DT EXTR is resolved. Note: The Date Element GP PMNT DT EXTR will extract the 'year' from the Calendar Period and populate the Variable GP PMNT DATE YR. |
| Variable | GP PRD BGN DATE DY | Period Begin Date - Day | Stores the Calendar Period Begin Date 'Day' - if the Date GP PRD BGN DT EXTR is resolved. Note: The Date Element GP PRD BGN DT EXTR will extract the 'day' from the Calendar Period and populate the Variable GP PRD BGN DATE DY. |
| Variable | GP PRD BGN DATE MO | Period Begin Date - Month | Stores the Calendar Period Begin Date 'Month' - if the Date GP PRD BGN DT EXTR is resolved. Note: The Date Element GP PRD BGN DT EXTR will extract the 'month' from the Calendar Period and populate the Variable GP PRD BGN DATE DY. |

| Element Type | Element Name | Description | Comments |
|---------------------|---------------------|--------------------------------|---|
| Variable | GP PRD BGN DATE YR | Period Begin Date - Year | Stores the Calendar Period Begin Date 'Year' - if the Date GP PRD BGN DT EXTR is resolved. Note: The Date Element GP PRD BGN DT EXTR will extract the 'year' from the Calendar Period and populate the Variable GP PRD BGN DATE DY. |
| Variable | GP PSLP ASOF | Payslip Message Duration As Of | Message definition - if using date for duration- date is as of what? |
| Variable | GP PSLP CAL RUN | Payslip Message Calendar Run | Message definition calendar run only populated if Duration of message = Calendar |
| Variable | GP PSLP EMPLID | Payslip Message Employee ID | Message definition EmplID only populated if Population criteria is EmplID. |
| Variable | GP PSLP FM NUM | Payslip Message | Message definition FM NUM only populated if population criteria is 'custom formula' |
| Variable | GP PSLP FROM DT | Payslip Message From Date | Message definition From Date only populated if duration of message is as of a date |
| Variable | GP PSLP GP | Payslip Message Assign Method | Message definition - Assignment Method |
| Variable | GP PSLP GRP ID | Payslip Message Group ID | Message definition Group ID only populated if GP Group Build is Population criteria. |
| Variable | GP PSLP MSG CTRY | Payslip Message Country | Country of message definition (key to message definition) |
| Variable | GP PSLP MSG NBR | Payslip Message Number | Message number from payslip definition (key to message definition) |
| Variable | GP PSLP PLIST | Payslip Message HR Group List | Message definition HR Group List only populated if HR Group List is Population criteria. |

| <i>Element Type</i> | <i>Element Name</i> | <i>Description</i> | <i>Comments</i> |
|----------------------------|----------------------------|----------------------------|--|
| Variable | GP PSLP SEL | Payslip Message Select | Message definition - population selection criteria |
| Variable | GP PSLP STATUS | Payslip Message Status | Status of message "active or inactive" |
| Variable | GP PSLP TO DT | Payslip Message To Date | Message definition To Date optionally populated if duration of message is as of a date |
| Variable | GP SEG BGN DATE DY | Segment Begin Date - Day | |
| Variable | GP SEG BGN DATE MO | Segment Begin Date - Month | |
| Variable | GP SEG BGN DATE YR | Segment Begin Date - Year | |
| Variable | GP SEG END DATE DY | Segment End Date - Day | |
| Variable | GP SEG END DATE MO | Segment End Date - Month | |
| Variable | GP SEG END DATE YR | Segment End Date - Year | |
| Variable | GP SLI BGN DATE DY | Slice Begin Date - Day | |
| Variable | GP SLI BGN DATE MO | Slice Begin Date - Month | |
| Variable | GP SLI BGN DATE YR | Slice Begin Date - Year | |
| Variable | GP SLI END DATE DY | Slice End Date - Day | |
| Variable | GP SLI END DATE MO | Slice End Date - Month | |
| Variable | GP SLI END DATE YR | Slice End Date - Year | |
| Writable Array | GP WA GUIDE | WA Segmentation Guide | Used for integration with EPM. To use it, just add the WA to any section. The writable array will not cause the resolution of the system elements defined in the Writable Array Fields grid. |

| <i>Element Type</i> | <i>Element Name</i> | <i>Description</i> | <i>Comments</i> |
|---------------------|---------------------|--------------------|---------------------------------|
| Writable Array | GP WA PSLP MSG | Payslip Messages | Payslip Messages writable array |

Legend

This table lists the legend for the following tables listing system elements:

| <i>Abbreviation</i> | <i>Description</i> |
|---------------------|---|
| DU | Could be use during duration element process. |
| DB | The value of the Day Before is available (name = System Element + DB). |
| DA | The value of the Day After is available (name = System Element + DA). |
| OS | What day does the system element value correspond: Current day being processed in the beginning balance offset period Current day being processed in the beginning balance offset period. |
| PA | These system elements will only be populated when processing a take element that was created from the negative balance take with other absence rule (redirected to), or was created by the mapped to functionality. |
| OR | Represent the overridden system elements related work schedule and alternate work schedule. |

System Elements Related to Work Schedule

This table lists system elements that are related to a work schedule:

| <i>System Element Name</i> | <i>Description</i> | <i>Format</i> | <i>DU</i> | <i>DB</i> | <i>DA</i> | <i>OS</i> | <i>PA</i> | <i>OR</i> | <i>Comments</i> |
|----------------------------|--------------------|---------------|-----------|-----------|-----------|-----------|-----------|-----------|---|
| DAY OF WEEK | Day of the Week | Character | X | X | X | X | | | Represents the day of the week, Sunday through Saturday. The value of this system element is calculated each day absent and therefore could be different each day. Valid Values: Character '1' through '7' (Sunday through Saturday). |

| System Element Name | Description | Format | DU | DB | DA | OS | PA | OR | Comments |
|----------------------------|-------------------------------|---------------|-----------|-----------|-----------|-----------|-----------|-----------|--|
| DAY STATUS | Day Status | Character | X | X | X | X | | | Represents whether the day has been processed ('P') or not ('U'). Valid Values: Character 'P' & 'U' ('P' = Processed / 'U' = Unprocessed). |
| SCHEDED FNx | Schedule define x | Decimal | X | X | X | X | X | X | Represents the primary work schedule's x user defined field. The value of this system element could vary each day. |
| SCHEDED HRS | Scheduled Hours | Decimal | X | X | X | X | X | X | Represents the overridden work schedule's x user defined field from the daily work schedule override of the primary workday ID. The value of this system element could vary each day. |
| SCHEDED HRS OR | Scheduled Hours | Decimal | X | X | X | X | X | | Represents the overridden scheduled work hours from the daily work schedule override of the primary workday ID. The value of this system element could be different each day of the event. |
| SCHEDED HRS WK | Sched Hours without Overrides | Decimal | X | X | X | X | X | | Represents the scheduled work hours from the primary work schedule. The value of this system element could be different each day of the event. |
| SCHEDED ID | Work Schedule | Character | X | | | | | | Represents the primary work scheduled ID. The value of this system element could be different each day of the event. |
| SCHEDED OVER IND | Schedule Over. Ind | Character | X | X | X | X | X | | This system element equals 'Y' (Yes), if the day of the event being processed has a daily work schedule override for the primary work day ID, else the system element equals 'N' (No). The value of this system element is calculated each day absent and therefore could be different each day. Valid Values: Character 'Y' & 'N' ('Y' = Yes/'N' = No). |
| WORK DAY ID | Work day ID | Character | X | X | X | X | X | X | Represents the workday ID of the primary work schedule. The value of this system element could be different each day of the event. |

| System Element Name | Description | Format | DU | DB | DA | OS | PA | OR | Comments |
|----------------------------|--------------------|---------------|-----------|-----------|-----------|-----------|-----------|-----------|---|
| WORKDAY ID OR | Work day ID | Character | X | X | X | X | X | | Represents the primary workday ID of the daily work schedule override. The value of this system element could be different each day of the event. |

System Elements Related to Alternate Work Schedule

This table lists system elements that are related to an alternate work schedule:

| System Element Name | Description | Format | DU | DB | DA | OS | PA | OR | Comments |
|----------------------------|-------------------------------|---------------|-----------|-----------|-----------|-----------|-----------|-----------|--|
| SCHED DFx1 ALT | Schedule define x | Decimal | X | X | X | X | X | X | Represents the alternate work schedule's x user defined field. The value of this system element could vary each day. |
| SCHED HRS ALT | Scheduled Hours Alternate | Decimal | X | X | X | X | X | X | Represents the overridden work schedule's x user defined field from the daily work schedule override of the alternate workday ID. The value of this system element could vary each day. |
| SCHED HRS ALT OR | Scheduled Hours Alternate | Decimal | X | X | X | X | X | | Represents the overridden scheduled work hours from the daily work schedule override of the alternate workday ID. The value of this system element could be different each day of the event. |
| SCHED HRS ALT WK | Sched Hours Alt s/o Overrides | Decimal | X | X | X | X | X | X | Represents the scheduled work hours from the alternate work schedule. The value of this system element could be different each day of the event. |
| SCHED ID ALT | Alternate Work Schedule | Character | X | | | | | | Represents the alternate work scheduled ID. The value of this system element could be different each day of the event. |

| System Element Name | Description | Format | DU | DB | DA | OS | PA | OR | Comments |
|----------------------------|----------------------------|---------------|-----------|-----------|-----------|-----------|-----------|-----------|--|
| SCHED OVER ALT IND | Schedule Alt. Over. Ind | Character | X | X | X | X | X | | This system element equals 'Y' (Yes), if the day of the event being processed has a daily work schedule override for the alternate work day ID, else the system element equals 'N' (No). The value of this system element is calculated each day absent and therefore could be different each day. Valid Values: Character 'Y' & 'N' ('Y' = Yes/'N' = No). |
| WORK DAY ID ALT | Work day ID | Character | X | X | X | X | X | X | Represents the workday ID of the alternate work schedule. The value of this system element could be different each day of the event. |

System Elements Related to Holidays

This table lists system elements that are related to holidays:

| System Element Name | Description | Format | DU | DB | DA | OS | PA | OR | Comments |
|----------------------------|---------------------|---------------|-----------|-----------|-----------|-----------|-----------|-----------|--|
| HOLIDAY HRS | Holiday Hours | Decimal | X | X | X | X | X | | Represents the public holiday hours from the HR holiday table. The value of this system element could be different each day of the event. |
| HOLIDAY SCHEDULE | Holiday Schedule | Character | X | X | X | X | X | | Represents the holiday schedule code from the HR holiday table. The value of this system element could be different each day of the event. |
| HOLIDAY TYPE | Holiday Type | Character | X | X | X | X | X | | Represents the public holiday type from the HR holiday table. The value of this system element could be different each day of the event. |

System Elements Related to Take Definition

This table lists system elements that are related to take definitions:

| System Element Name | Description | Format | DU | DB | DA | OS | PA | OR | Comments |
|----------------------------|------------------------|---------------|-----------|-----------|-----------|-----------|-----------|-----------|---|
| ABSENCE REASON | Absence Reason | Character | X | X | X | X | X | X | Represents the absence reason for the absence event. The value of this system element is resolved once prior to the 1st day of each event and therefore will be the same value each day of the event. |
| ABSENCE TYPE | Absence Type | Character | X | X | X | X | X | X | Represents the absence type of the Take associated with the absence event. The value of this system element is resolved once prior to the 1st day of each event and therefore will be the same value each day of the event. |
| TAK CONFIGx PARENT | Take Configx of Parent | Character | X | | | | | | Represents the x user defined field associated with the Take element of the absence event being processed. The value of this system element is resolved once prior to the 1st day of each event and therefore will be the same value each day of the event. |
| TAKE CONFIGx | Take Config x | Character | X | X | X | X | X | | Represents the x user defined field associated with the Take element of the absence event being processed. The value of this system element is resolved once prior to the 1st day of each event and therefore will be the same value each day of the event. |

System Elements Related to the Absence Event Entry

This table lists system elements that are related to absence event entry:

| System Element Name | Description | Format | DU | DB | DA | OS | PA | OR | Comments |
|----------------------------|--------------------|---------------|-----------|-----------|-----------|-----------|-----------|-----------|--|
| ABS BGN DATE | Absence Begin Date | Date | X | X | X | X | X | | Represents the absence event begin date. The value of this system element will be the same for all days within each event. |
| ABS END DATE | Absence End Date | Date | X | X | X | X | X | | Represents the absence event end date. The value of this system element will be the same for all days within each event. |

| System Element Name | Description | Format | DU | DB | DA | OS | PA | OR | Comments |
|----------------------------|-----------------------------|---------------|-----------|-----------|-----------|-----------|-----------|-----------|---|
| ABSENCE DATE | Absence Date | Date | X | X | X | X | X | | Represents the calendar date of the day of the event being processed. The value of this system element is calculated each day absent and therefore is different each day. |
| BGN DAY IND | Begin Day Indicator | Character | X | X | X | X | X | | This system element equals '1' (Yes), if the 1st day of the event is being processed, else the system element equals '0' (No). The value of this system element is calculated each day absent and therefore could be different each day. Valid Values: Character '1' & '0' ('1' = Yes/'0' = No). |
| BGN DAY IND HLF | Begin Half Day Indicator | Character | X | X | X | X | X | | This system element equals the value entered on the absence event entry component for this event. The employee was absent a half a day on the first day of the event. What day does the system element value correspond: Current day being processed. Valid Values: Character 'Y' & 'N' ('Y' = Yes/'N' = No). |
| END DAY IND | End Day Indicator | Character | X | X | X | X | X | | This system element equals '1' (Yes), if the 1st day of the event is being processed, else the system element equals '0' (No). The value of this system element is calculated each day absent and therefore could be different each day. Valid Values: Character '1' & '0' ('1' = Yes/'0' = No). |
| END DAY IND HLF | End Half Day Indicator | Character | X | X | X | X | X | | This system element equals the value entered on the absence event entry component for this event. The employee was absent a half a day on the last day of the event. What day does the system element value correspond: Current day being processed. Valid Values: Character 'Y' & 'N' ('Y' = Yes/'N' = No). |
| EVENT ADJUSTMENT | Event Adjustment (override) | Decimal | X | X | X | X | X | | Represents the adjustment to the 'per absence' entitlement balance associated with the Absence Take of the absence event being processed. The value of this system element is resolved once prior to the 1st day of each event and therefore will be the same value each day of the event. |

| System Element Name | Description | Format | DU | DB | DA | OS | PA | OR | Comments |
|----------------------------|--------------------------------|---------------|-----------|-----------|-----------|-----------|-----------|-----------|--|
| EVENT ENTITLEMENT | Event entitlement (override) | Decimal | X | X | X | X | X | | Represents the override to the 'per absence' entitlement units for the absence event being processed. The value of this system element is resolved once prior to the 1st day of each event and therefore will be the same value each day of the event. |
| EVT CONFIGx CH | Event Config | Character | X | X | X | X | X | | Represents the absence event entry's first user defined character field for the absence event being processed. The value of this system element is resolved once prior to the 1st day of each event and therefore will be the same value each day of the event. |
| EVT CONFIGx CH UPD | Event Configx Character Update | Character | X | | | | | | Represents the first daily absence user defined character field that can be assigned a value and then stored on the absence daily results. The value of this system element will be retrieved and stored on the absence daily results only if the system element is entered in the User Defined Result Fields grid of the Absence Take definition. It is a daily system element. A common place to assign a value to this system element is the absence take day formula or the absence take unit formula. A different value could be stored each day on the absence daily results depending upon what value is assigned to the system element each day. The stored value can then be used in a take element offset formula via the system element EVT CONFIG CHx OS, or in a duration element via the system element EVT CONFIG CHx DU. |
| EVT CONFIGx DC | Event Configx | Decimal | X | X | X | X | X | | Represents the absence event entry's first user defined character field for the absence event being processed. The value of this system element is resolved once prior to the 1st day of each event and therefore will be the same value each day of the event. |

| System Element Name | Description | Format | DU | DB | DA | OS | PA | OR | Comments |
|----------------------------|---------------------------------|---------------|-----------|-----------|-----------|-----------|-----------|-----------|--|
| EVT CONFIGx DC UPD | Event Configx Decimal Update | Decimal | X | | | | | | Represents the first daily absence user defined character field that can be assigned a value and then stored on the absence daily results. The value of this system element will be retrieved and stored on the absence daily results only if the system element is entered in the User Defined Result Fields grid of the Absence Take definition. It is a daily system element. A common place to assign a value to this system element is the absence take day formula or the absence take unit formula. A different value could be stored each day on the absence daily results depending upon what value is assigned to the system element each day. The stored value can then be used in a take element offset formula via the system element EVT CONFIG DCx OS, or in a duration element via the system element EVT CONFIG DCx DU. |
| EVT CONFIGx DT | Event Config x | Date | X | X | X | X | X | | Represents the absence event entry's first user defined character field for the absence event being processed. The value of this system element is resolved once prior to the 1st day of each event and therefore will be the same value each day of the event. |
| EVT CONFIGx DT UPD | Event Configx Date Update | Date | X | | | | | | Represents the first daily absence user defined character field that can be assigned a value and then stored on the absence daily results. The value of this system element will be retrieved and stored on the absence daily results only if the system element is entered in the User Defined Result Fields grid of the Absence Take definition. It is a daily system element. A common place to assign a value to this system element is the absence take day formula or the absence take unit formula. A different value could be stored each day on the absence daily results depending upon what value is assigned to the system element each day. The stored value can then be used in a take element offset formula via the system element EVT CONFIG DTx OS, or in a duration element via the system element EVT CONFIG DTx DU. |

| System Element Name | Description | Format | DU | DB | DA | OS | PA | OR | Comments |
|----------------------------|-------------------------------|---------------|-----------|-----------|-----------|-----------|-----------|-----------|--|
| EVT CONFIGx MN | Event Config x | Monetary | X | X | X | X | X | | Represents the absence event entry's first user defined character field for the absence event being processed. The value of this system element is resolved once prior to the 1st day of each event and therefore will be the same value each day of the event. |
| EVT CONFIGx MN UPD | Event Configx Monetary Update | Monetary | X | | | | | | Represents the first daily absence user defined character field that can be assigned a value and then stored on the absence daily results. The value of this system element will be retrieved and stored on the absence daily results only if the system element is entered in the User Defined Result Fields grid of the Absence Take definition. It is a daily system element. A common place to assign a value to this system element is the absence take day formula or the absence take unit formula. A different value could be stored each day on the absence daily results depending upon what value is assigned to the system element each day. The stored value can then be used in a take element offset formula via the system element EVT CONFIG MNx OS, or in a duration element via the system element EVT CONFIG MNx DU. |
| ORIG BEGIN DATE | Original Begin Date | Date | X | X | X | X | X | | Represents the absence event original begin date. The value of this system element will be the same for all days within each event. |
| PARTIAL HOURS | Partial Hours | Decimal | X | X | X | X | X | | Represents the partial hours if any for the day of the absence event being processed. Partial hours can be entered for each event via the absence event entry component for the begin day of the event, or for the end day of the event. Partial hours can also be entered for all days of the event. The value of this system element is calculated each day absent and therefore could be different each day. |
| PIN TAKE NUM | Absence Take Element | Pointer | X | X | X | X | X | | Represents the PIN (element) number of the Take element for the day. |

System Elements Calculated during the Absence Processing

This table lists system elements that are calculated during absence processing:

| System Element Name | Description | Format | DU | DB | DA | OS | PA | OR | Comments |
|----------------------------|------------------------------|---------------|-----------|-----------|-----------|-----------|-----------|-----------|--|
| ABS BEGIN ENTL BAL | Absence Begin Entitl Balance | Decimal | X | X | X | X | X | X | Represents the entitlement period balance as of the beginning of the day. The value of this system element is calculated each day absent and therefore could be different each day. |
| ABS BEGIN WAIT BAL | Absence Begin Wait Balance | Decimal | X | X | X | X | X | X | Represents the wait period balance as of the beginning of the day. The value of this system element is calculated each day absent and therefore could be different each day. |
| ABS CUM EVT WAIT | Absence Cum Event Wait | Decimal | X | X | X | X | X | X | Represents the entitlement balance as of the beginning of the day. The value of this system element is calculated each day absent and therefore could be different each day. |
| ABS CUM LINK WAIT | Absence Cum Linked Wait | Decimal | X | X | X | X | X | X | Represents the sum of the wait count of each day of the absence event through the day of the absence event being processed including the wait counts of previously linked absence events. The value of this system element is calculated each day absent and therefore could be different each day. |
| ABS CUM PARTIAL HR | Absence Cum Partial Hours | Decimal | X | X | X | X | X | X | Represents the sum of the partial hours of Absence Takes for the same day being processed including the current Absence Take. This system element is only available when duplicates are allowed for that Absence Take. The value of this system element is calculated each day absent and therefore could be different each day. |

| System Element Name | Description | Format | DU | DB | DA | OS | PA | OR | Comments |
|----------------------------|----------------------------|---------------|-----------|-----------|-----------|-----------|-----------|-----------|--|
| ABS ELIG DATE | Absence Eligible Date | Date | X | X | X | X | X | X | The Take element's eligibility date resolves once at the beginning of each absence event. The resulting value of the eligibility date is available via this system element. The employee is not eligible to be paid prior to this date (all daily units will be considered unpaid). The value of this system element is resolved once prior to the 1st day of each event and therefore will be the same value each day of the event. |
| ABS ELIG IND | Absence Eligible Indicator | Character | X | X | X | X | X | X | This system element equals 'Y' (Yes), if the day of the event being processed is greater than or equal to the eligibility date, else the system element equals 'N' (No). (See ABS_ELIG_DATE) The value of this system element is calculated each day absent and therefore could be different each day. Valid Values: Character 'Y' & 'N' ('Y' = Yes/'N' = No). |
| ABS END ENTL BAL | Absence End Entitl Balance | Decimal | X | X | X | X | X | X | Represents the entitlement balance as of the end of the day. The value of this system element is calculated each day absent and therefore could be different each day. |
| ABS END WAIT BAL | Absence End Wait Balance | Decimal | X | X | X | X | X | X | Represents the wait period balance as of the end of the day. The value of this system element is calculated each day absent and therefore could be different each day. |
| ABS LINK IND | Absence Link Indicator | Character | X | X | X | X | X | X | This system element = 'Y' (Yes) if the event is linked to a prior event. If the current absence event is not linked, the system element will equal 'N' (No). This system element can be used in your rules to share a linked entitlement balance, or to share a linked waiting period. The value of this system element is resolved once prior to the 1st day of each event and therefore will be the same value each day of the event. Valid Values: Character 'Y' & 'N' ('Y' = Yes/'N' = No). |

| System Element Name | Description | Format | DU | DB | DA | OS | PA | OR | Comments |
|----------------------------|----------------------------|---------------|-----------|-----------|-----------|-----------|-----------|-----------|--|
| ABS LINK PRD | Absence Link Period | Decimal | X | X | X | X | X | X | The Take element's link period duration between two absences is resolved once at the beginning of each event. The resulting value of this period of time is available via this system element. This is used to help determine whether or not the current event is linked to a previous event. The value of this system element is resolved once prior to the 1st day of each event and therefore will be the same value each day of the event. |
| ABS MAP ELEMENT | Absence Map Element Number | Pointer | X | X | X | X | X | X | Represents the Take element's mapped to Take element. This system element will be populated for each day of the current event that is mapped (a mapped to Take element is generated). The value of this system element is resolved each day and therefore could have a different value each day. |
| ABS MIN IND | Absence Minimum Indicator | Character | X | X | X | X | X | X | This system element = 'Y' (Yes) if this event satisfies the minimum number of calendar days the absence must span before the event is eligible to be paid else the system element equals 'N' (No). The value of this system element is resolved once prior to the 1st day of each event and therefore will be the same value each day of the event. Valid Values: Character 'Y' & 'N' ('Y' = Yes/'N' = No). |
| ABS MIN PRD | Absence Minimum Period | Decimal | X | X | X | X | X | X | Represents the Take Element's minimum period or the minimum number of calendar days the absence must span to be considered a valid absence event. If the absence event spans fewer calendar days than the minimum period, the event is not eligible to be paid and will not be considered for linking (a future dated event will never link to this event). The value of this system element is resolved once prior to the 1st day of each event and therefore will be the same value each day of the event. |

| System Element Name | Description | Format | DU | DB | DA | OS | PA | OR | Comments |
|----------------------------|---------------------------------|---------------|-----------|-----------|-----------|-----------|-----------|-----------|--|
| ABS NEG ELEMENT | Absence Negative Element Number | Pointer | X | X | X | X | X | X | Represents the Take element's negative balance rules, take with other absence. This system element will be populated when the amount of the entitlement balance drops below zero (the day is redirected to another take element). The value of this system element is resolved once prior to the 1st day of each event and therefore will be the same value each day of the event. |
| ABS SOURCE ELEMENT | Absence Source Element Number | Pointer | X | X | X | X | X | X | Represents the PIN number of the Take element from which this Absence Take was mapped or redirected. The value of this system element could vary each day. |
| ABS WAIT COUNT | Absence Wait Count | Decimal | X | X | X | X | X | X | The Take element's wait count formula resolves each day if the wait per absence indicator is checked on. The resulting value of the wait count formula is available via this system element each day (the unit representation for each day). The value of this system element is calculated each day absent and therefore could be different each day. |
| DAY COUNT | Day Count | Decimal | X | X | X | X | X | X | The Take element's Day Formula resolves each day. The resulting value of the Day Formula is available via this system element each day (the unit representation for each day). The value of this system element is calculated each day absent and therefore could be different each day. |
| DAY COUNT UNP | Day count unpaid | Decimal | X | X | X | X | X | X | This system element equals the number of unpaid units (the unpaid portion of the day count). The value of this system element is calculated each day absent and therefore could be different each day. |
| FIRST DATE LINK | First Date Link | Date | X | | | | | | Represents the begin date of the earliest absence event linked to the absence event begin processed. If the event is not linked it represents the begin date of the absence event being processed. The value of this system element will be the same for all days within each event. |

| System Element Name | Description | Format | DU | DB | DA | OS | PA | OR | Comments |
|----------------------------|----------------------------|---------------|-----------|-----------|-----------|-----------|-----------|-----------|--|
| FIRST EVT BGN DT | First Event Begin Date | Date | X | X | X | X | X | | Represents the begin date of the earliest absence event linked to the absence event begin processed. If the event is not linked it represents the begin date of the absence event being processed. The value of this system element will be the same for all days within each event. |
| LINK YES-NO | Link Yes-No | Character | X | | | | | | This system element = 'Y' (Yes) if the event is linked to a prior event. If the current absence event is not linked, the system element will equal 'N' (No). This system element can be used in your rules to share a linked entitlement balance, or to share a linked waiting period. The value of this system element is resolved once prior to the 1st day of each event and therefore will be the same value each day of the event. Valid Values: Character 'Y' & 'N' ('Y' = Yes/'N' = No). |
| TOTAL ABS BY DAY | Total Absence hours by day | Decimal | X | | | | | | Represents the sum of the partial hours of Absence Takes for the same day being processed including the current Absence Take. This system element is only available when duplicates are allowed for that Absence Take. The value of this system element is calculated each day absent and therefore could be different each day. |

System Elements Related to the Forecasting Process

This table lists system elements related to the forecasting process:

| System Element Name | Description | Format | DU | DB | DA | OS | PA | OR | Comments |
|----------------------------|---------------------------|---------------|-----------|-----------|-----------|-----------|-----------|-----------|---|
| TXN ID | Transaction Identifier | Character | X | | | | | | Represents the transaction ID of either the Absence Forecasting or Balance Inquiry transaction being processed. When is it Available: This system element is resolved during Absence Forecasting or Balance Inquiry. It is only available during the Absence Forecasting or Balance Inquiry transaction processing. The value of this system element will not change during the processing of the transaction. |
| TXN RSLT OPTN | Transaction Result Option | Character | X | | | | | | Represents the transaction result option of either the Absence Forecasting or Balance Inquiry transaction being processed. When is it Available: This system element is resolved during Absence Forecasting or Balance Inquiry. It is only available during the Absence Forecasting or Balance Inquiry transaction processing. The value of this system element will not change during the processing of the transaction. Valid Values: Character Value. 'T' - Use Temporary Tables, 'N' - Do not write results. |
| FCST ASOF DT | Forecast As Of Date | Date | X | | | | | | Represents the as of date for which the absence balance of the specified Take element will be calculated. When is it Available: This system element is resolved during the Balance Inquiry. It is only available during the Balance Inquiry transaction processing. The value of this system element will not change during the processing of the transaction. |
| FCST BGN DT | Forecast Begin Date | Date | X | | | | | | Represents the Forecast Period Begin Date for which either Absence Forecasting or Balance Inquiry being processed. When is it Available: This system element is resolved during Absence Forecasting or Balance Inquiry. It is only available during the Absence Forecasting or Balance Inquiry transaction processing. The value of this system element will not change during the processing of the transaction. |

| System Element Name | Description | Format | DU | DB | DA | OS | PA | OR | Comments |
|----------------------------|------------------------------|---------------|-----------|-----------|-----------|-----------|-----------|-----------|---|
| FCST END DT | Forecast End Date | Date | X | | | | | | Represents the Forecast Period End Date for which either Absence Forecasting or Balance Inquiry being processed. When is it Available: This system element is resolved during Absence Forecasting or Balance Inquiry. It is only available during the Absence Forecasting or Balance Inquiry transaction processing. The value of this system element will not change during the processing of the transaction. |
| PIN FCST TAKE NUM | Forecast Pin Number | Pointer | X | | | | | | Represents the Take element for which the absence balance will be calculated. When is it Available: This system element is resolved during the Balance Inquiry. It is only available during the Balance Inquiry transaction processing. The value of this system element will not change during the processing of the transaction. Valid Values: PIN Number. |
| ABS EVT FCST VAL | Absence Event Forecast Value | Character | X | X | X | X | X | X | Represents the value of the Take element's Forecast Element resolved for an absence event during Absence Forecasting. When is it Available: This system element is resolved during Absence Forecasting. It is only available during the batch Absence Take element processing. It is a daily system element. The value of this system element will be the same for each day of the event. |

Viewing the Delivered Elements

Page Used to Access and Run the GP_ELEMENTS Query

| Page Name | Definition Name | Usage |
|--|------------------------|---|
| Query Manager Page | QRY_SELECT | Access the GP_ELEMENTS query. |
| GP_ELEMENTS – Global Payroll Elements Page | QRY_SELECT | Generate query results using the GP_ELEMENTS query. |

Understanding the GP_ELEMENTS Query

Use the GP_ELEMENTS query to view a list of elements that are defined for your system. You can view elements defined for all countries or a specific country, view elements by category or name, or a combination of these criteria. If you are using the query to view system elements, the query retrieves information about the purpose of each system element and how and when it is resolved.

Query Manager Page

Use the Query Manager page (QRY_SELECT) to access the GP_ELEMENTS query.

Navigation:

Reporting Tools > Query > Query Manager

To access the GP_ELEMENTS query, enter *GP_ELEMENTS* in the **Search By Query Name** field on the Query Manager page and click the **Search** button.

This example illustrates the fields and controls on the Query Manager page.

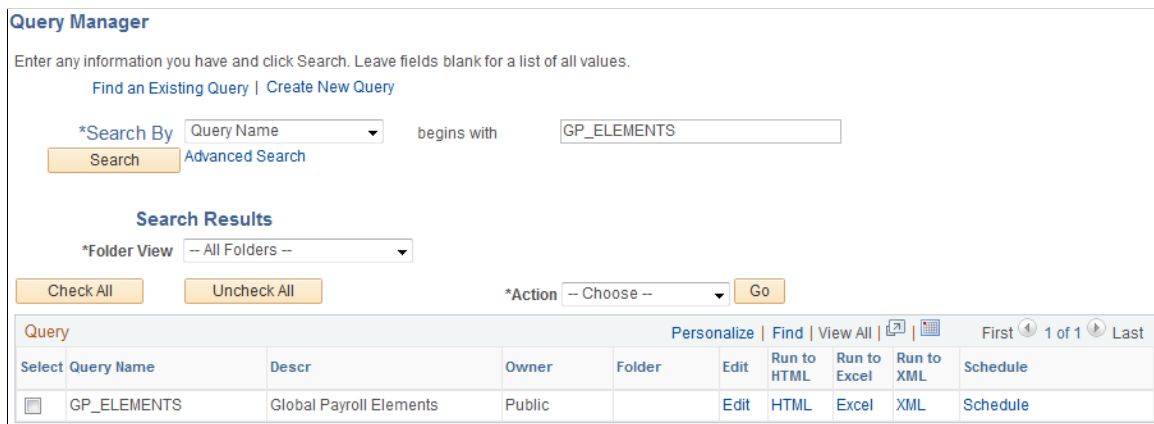

| Field or Control | Description |
|-------------------------|---|
| Edit | Click to edit field properties and sort order for your query. |
| Run to HTML | Click to run the query and generate an online view of the delivered elements. Once you've defined your search criteria for the GP_ELEMENTS query, in addition to viewing results online, you also have the option of downloading the results into a Microsoft Excel spreadsheet or a CSV text file. |
| Run to Excel | Click to run the query and publish the results in a Microsoft Excel spreadsheet. Note: If you cannot see the comment field for an element in Excel, change the format of the field, or view the output in html. |
| Schedule | Click to define criteria for scheduling a query. |

See the product documentation for *PeopleTools: Query*

GP_ELEMENTS – Global Payroll Elements Page

Use the GP_ELEMENTS – Global Payroll Elements page (QRY_SELECT) to generate query results using the GP_ELEMENTS query.

Navigation:

Click the **HTML** link under **Run to HTML** on the Query Manager page, or click the **Excel** link under **Run to Excel** on the Query Manager page for the GP_ELEMENTS query.

This example illustrates the fields and controls on the GP_ELEMENTS query.

GP_ELEMENTS - Global Payroll Elements

Used By:

Country:

Category:

Element Name:

To run the query, enter your search criteria and click the **View Results** button. Modify the query using the criteria described below.

| Field or Control | Description |
|----------------------------------|--|
| Used By | Identify whether you want to view elements for <i>All Countries</i> or <i>Specific Country</i> . |
| Country | If you select <i>All Countries</i> in the Used By field, enter <i>ALL</i> in the Country field. If you select <i>Specific Country</i> in the Used By field, enter the country code for which you want to view elements. |
| Category and Element Name | To narrow your results, you can enter a functional category code, such as ABS, for absences. You can also enter part of or all of an element name. Note: For information about category and element naming conventions, see the country extension documentation. |
| View Results | Click to view the results online or download the results to a Microsoft Excel file. |

See the product documentation for *PeopleTools: Security Administration*.

Chapter 40

Generating Report Data

Understanding Report Data Generation

This topic discusses:

- The data reporting process.
- Filters.
- Report data and segmentation.
- Output table definitions.
- User-defined parameter definition.
- Batch processing setup.
- Real-time processing setup.
- Building a transaction that uses report data.

The Data Reporting Process

Using the report data generation process, you can easily read absence results tables and use this data to populate your own reports.

The report data generation process enables you to create reports that contain:

- Retroactivity.
- Segmentation, retro-segmentation, and segmentation cancelled by retroactivity.
- Reverse calculations.
- Absence Management status, indicators, and other technical fields.
- Pay group, pay entity, and payment key changes resulting from corrective retroactivity.
- Calculation results stored in earnings, deductions, balance accumulators, accumulators stored with each calculation, absence daily data, generated positive input, supporting elements stored with each calculation, and specific result tables (writable arrays).
- Multiple selections by process run.
- Data based on a calendar group or a period of time.
- Results from finalized and unfinalized calendars.

- Payees selected from any table at the EMPLID level, adhering to HCM security.
- Appropriate absence segments.
- Selected elements.
- Any and all slices.

Steps for Creating Reports Using the Report Data Generation process

To create reports using the report data generation process:

1. Assign output and input tables for the report on the Define Report Data page.
2. Define the rules used to create the output table on the Define Report Data page.
3. Map fields and create filters used to generate the output table on the Report Data Process Details page.

Selecting Absence Results and Populating Output Tables

After you set up the input and output table details using the Define Report Data page, and map fields and define filters on the Report Data Process Details page, the system completes the following steps to select the absence results and populate the output tables:

1. Select calendar groups.
2. Select eligible payees using payee lists, group builds, security, and payee filter. If a payee filter was created, it is applied here.
3. Join the payee process status table (GP_PYE_PRC_STAT) and the payee segment status table (GP_PYE_SEG_STAT).
4. Select the original segments. If a process filter was created it is applied here.
5. Insert the original, recal, prior, and last version/revision segments into the worktable (GP_RPTW_TMP). The worktable now contains rows by payee for selected segments, recalculations, prior segments, and last version/revision segments. If a segment filter was created it is applied here.
6. Join the worktable, the primary input table, and the link table (the additional input table joined with the primary input table) according to the data on the Report Data Process Details page. The results are posted to the output table. Only the results derived from the worktable or the primary input table are populated. If an input filter was created it is applied here.
7. Update the output table with data from the additional input tables.

This diagram illustrates how the system generates the report data Worktable.

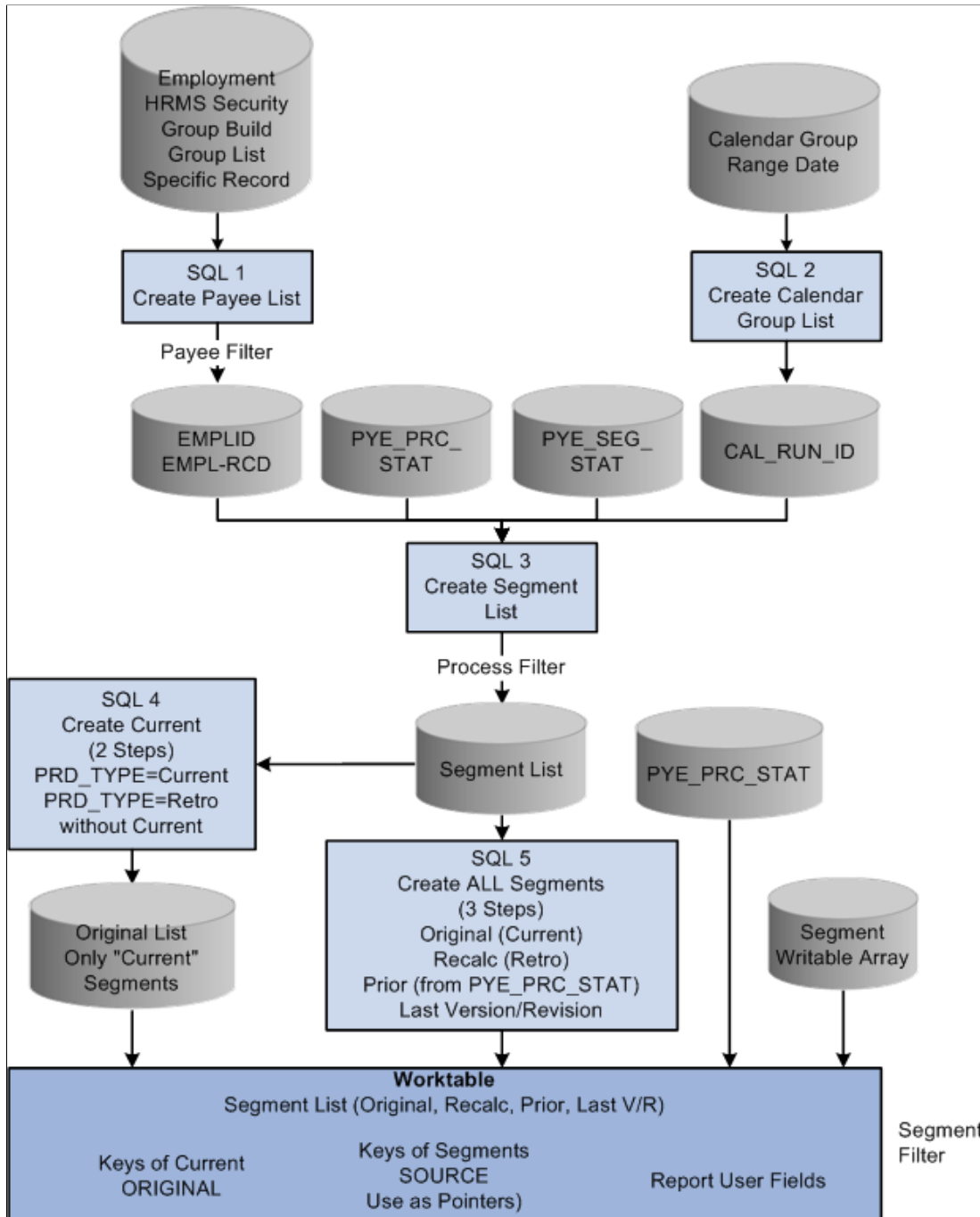

This diagram illustrates how the system combines the data in the Worktable with the data from the Primary Input Table and Additional Input Table in the process of generating report data.

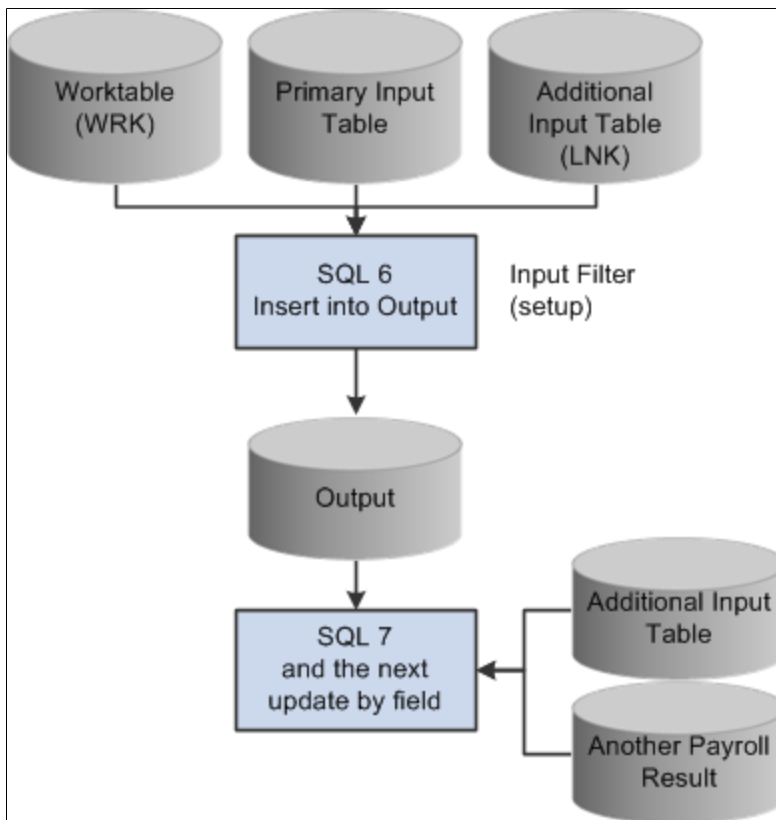

Filters

Four levels of filters exist: payee, process, segment, and input.

- Payee Filter

This SQL parameter is used to filter the population. It is applied when the selection is based on a specific record or employment table.

- Process Filter

This SQL parameter is used to filter the entire process in the original segments only. It can be based on any field in the payee process status or payee segment status tables. For example, "and COUNTRY = 'USA'" selects only U.S. absence results.

- Segment Filter

This field parameter is used to create a filter for every step of the process in every segment. It can be based on any field in the payee process status, the payee segment status, or the segment writable array table (if defined in the setup). For example, COMPANY 'GBI' makes a selection on the company GBI if COMPANY is stored in a segment writable array.

- Input Filter

This SQL filter is defined in the setup for each step used to filter the primary input table, the additional input table joined with the primary input table (the link table), or the worktable. Input filters can be used as a filter or as an additional join condition. For example, "and PRI.CALC_RSLT_VAL>0" selects only the positive results.

Report Data and Segmentation

The Report Data feature manages four kinds of segments:

- Original segments

Original segments correspond to all segments for version 1 revision 1 (V1R1) for a period. In this kind of segment, there is also a virtual segment. The virtual segment is created when there is corrective retroactivity but the pay group, run type, or payment key of the current period does not match the recalculated period.

- Recalculated segments

Recalculated segments correspond to all segments other than V1R1 that were created during a calendar group run.

- Prior segments

Prior segments correspond to the previous version/revision of all recalculated or reversal segments.

- Last version/revision

Here is how the system interprets the following situations:

- If a payee has only one calendar and only one segment, then the payee has one original segment.
- If a payee has one calendar and two segments, then the payee has two original segments.
- If a payee has two calendars and one segment, then the payee has two original segments.
- If a payee has one calendar and one segment for the current period, and a corrective retro back to the twelve previous periods (with the same pay group and two different payment keys), then the payee has two original segments even if Absence Management creates only one segment for the current period.

Related Links

[Understanding Retroactive Processing](#)

Output Table Definitions

Output tables must be defined to store your selected results. These tables must include the following key structure:

| Field Name | Type | Length | Key | Required |
|-------------------|-------------|---------------|------------|-----------------|
| PROCESS_INSTANCE | Num | 10 | KA | N |
| EMPLID | Char | 11 | KA | Y |
| CAL_RUN_ID | Char | 18 | KA | Y |
| EMPL_RCD | Num | 3 | KA | N |
| GP_PAYGROUP | Char | 10 | KA | Y |
| CAL_ID | Char | 18 | KA | Y |
| ORIG_CAL_RUN_ID | Char | 18 | KA | Y |
| RSLT_SEG_NUM | Num | 4 | KA | Y |
| GP_RPT_KEY | Char | 22 | KA | Y |
| SEQ_NUM | Num | 3 | KA | Y |

User-Defined Parameter Definitions

The user-defined parameters are defined when setting up the input filter on the Report Data Process Details page . They must follow this syntax:

`%PARM.<function>.<parameter>`

Consider the following example using the filter *And PRI.STATE in (%PARM.REPORT.STATE)* and these parameters:

| Parameter 1 | Parameter 2 | Parameter 3 |
|--------------------|--------------------|--------------------|
| REPORT | STATE | CA |
| REPORT | STATE | OR |

In this example, the generated SQL statement would include: `And PRI.STATE IN ('CA','OR')`. Below is an example of how you would use these user-defined parameters in the program:

```
&reportBatch.AddParamChar("REPORT", "STATE", "CA");
&amp_reportBatch.AddParamChar("REPORT", "STATE", "OR");
```

Batch Processing Setup

The batch process provides a public section called "EXTRACT" that can be called by an application engine process that prepares the absence results for reporting. You must prepare the list of parameters. Then the EXTRACT section generates the SQL requests based on the parameters and executes the requests.

A section called "MAIN" is provided for testing purposes. The MAIN section is used by the delivered run control Validate Report Data. The parameters are managed by the delivered application classes via an object &reportBatch defined at the component level:

```
import GP_RPT_DATA:ReportDataClasses:*;
Component ReportDataAE &reportBatch;
```

| Section | Step |
|------------------|--|
| Main | <ol style="list-style-type: none"> 1. Prepare the list of parameters based on the run control GP_RC_RPT_DTL. 2. Call EXTRACT. |
| EXTRACT (public) | <ol style="list-style-type: none"> 1. Initialization. 2. Print the parameters log file. 3. Generate the requests (call to .GenerateSQL). 4. Loop on the requests. Call to EXECUTE. |
| EXECUTE | <ol style="list-style-type: none"> 1. Print a message in the log file. 2. Execute a request. 3. Print a message in the log file. |

The application engine is based on the state record GP_RPT_AET and includes the following dedicated temporary tables: GP_RPTC_TMP, GP_RPTO_TMP, GP_RPTE_TMP, GP_RPTS_TMP, and GP_RPTW_TMP.

Below is an example of the batch processing setup:

```
import GP_RPT_DATA:ReportDataClasses:*;
Component ReportDataAE &reportBatch;
&reportBatch.AddParamChar("EXTPRC", "COUNTRY", "USA");
&reportBatch.AddParamChar("EXTPRC", "NAME", "GP_REPORT");
&reportBatch.AddParamChar("EXTPRC", "TYPE", "P");
&reportBatch.AddParamChar("SELPYE", "SECUR", "Y");
&reportBatch.AddParamChar("SELCAL", "CALGRPID", GP_REGISTER_AET.CAL_RUN_ID);
&reportBatch.AddParamChar("SELCAL", "FROMDT", GP_REGISTER_AET.FROM_DT);
&reportBatch.AddParamChar("SELCAL", "TODT", GP_REGISTER_AET.TO_DT);
```

The call section name is EXTRACT, and the program ID is GP_EXT_AE.

Real-Time Processing Setup

Below is an example of real-time processing setup:

```
import GP_RPT_DATA:ReportDataClasses:*;
Component ReportDataReal &report;
Local number &instance;
&report = create ReportDataReal();
&report.AddParamChar("EXTPRC", "COUNTRY", "USA");
&report.AddParamChar("EXTPRC", "NAME", "GP_REPORT");
&report.AddParamChar("EXTPRC", "TYPE", "P");
&report.AddParamChar("SELPYE", "SECUR", "Y");
&report.AddParamChar("SELCAL", "CALGRPID", GP_REGISTER_AET.CAL_RUN_ID);
&report.AddParamDate("SELCAL", "FROMDT", GP_REGISTER_AET.FROM_DT);
&report.AddParamDate("SELCAL", "TODT", DERIVED_GP.TO_DT);
&instance = &report.GetInstance();
&report.ExecuteNow();

/* selection from the output tables (using &instance) can be done here
in order to display results */
```

Building a Transaction That Uses Report Data

When building a transaction that uses report data, you should follow these guidelines:

- Design one or more temporary tables for transaction purposes using the same key structure as the batch process. The tables are keyed by process instance.
- The user transaction should contain inquiry parameters such as EMPLID or CAL_RUN_ID.
- Create a push button or similar feature to launch a PeopleCode program to access the report data. It should run as follows:
 - The class ReportDataReal is initiated.
 - The PeopleCode transforms the inquiry parameters into report data parameters using the method .AppParamChar/Date/Num().
 - The method .GetInstance() is triggered. This method generates a process instance number using a table designed for report data.
 - The method .ExecuteNow() is triggered.
 - The PeopleCode can then load data from the temporary tables into the page buffers (using, for example, the process instance number returned by method .GetInstance()).
 - The content of the temporary tables must then be deleted using the process instance number.
- If two users run the same transaction simultaneously, the system generates two different process instance numbers.

Common Elements Used to Generate Report Data

| <i>Field or Control</i> | <i>Description</i> |
|-----------------------------|--|
| Output Table | Name of the table to be populated. |
| Primary Input Table | The functional name of a Absence Management result table. For example, GP_RSLT_ERN_DED would be referred to as the Result Table for Earnings and Deductions. |
| Original Segment | The segment represented by version 1 and revision 1. |
| Recalculated Segment | The segment that is not version 1 and revision 1. |
| Prior Segment | The segment that the Absence Management application used to calculate deltas. |

Defining Report Data

Pages Used to Define Report Data

| <i>Page Name</i> | <i>Definition Name</i> | <i>Usage</i> |
|---|------------------------|---|
| <u>Define Report Data Page</u> | GP_RPT_TBL | Assign the output table, writable array, primary input table type, and segment options. |
| <u>Report Data Process Details Page</u> | GP_RPT_DTL_SEC | Map fields and create filters used to generate the output table. |

Define Report Data Page

Use the Define Report Data page (GP_RPT_TBL) to assign the output table, writable array, primary input table type, and segment options.

Navigation:

Set Up HCM > Product Related > Global Payroll & Absence Mgmt > Reports > Define Report Data > Define Report Data

This example illustrates the fields and controls on the Define Report Data page.

| Field or Control | Description |
|-----------------------------------|---|
| Report Data | Displays the identification code for the report data setup. |
| Generate Log | Select to generate log details when you run the report. |
| Segment Writable Array | Enter a writable array segment. The corresponding writable array table can be used throughout the report data generation process in two ways. First, any field on this writable array table can be included in the field map. Thus it is used to populate fields in the output tables. Second, any field on this writable array table can be used as a filter for the process (using the parameter "SEGFILTER" on the Validate Report Data page). For example, for a writable array that contains the Company and Establishment fields, a process can be run for a single company or establishment. |
| Row Level Security | Select to enable row level security for the report. When row level security is enabled, the Report Data process selects payee records from EMPL_SRCH_GBL where the Row Security class equals the one defined for the user. |
| Run Time Security Override | Select to allow the Row Level Security value to be overridden on the run control page of the report. |

Process Details

| Field or Control | Description |
|-----------------------------|--|
| Sequence | <p>Enter the sequence number. The same input and output tables may be used repeatedly.</p> <hr/> <p>Warning! The report data generation process uses this sequence number when generating output tables. The output table must have a SEQ_NUM field to hold the sequence number value.</p> <hr/> |
| Output Table | Enter the record name of the output table. |
| Primary Input Table | <p>Select the primary table to be read for data selection. The Primary Input Table and the Output Table have a one to one relationship; for each row selected in the Primary Input Table there will be one row selected in the Output Table. The options available are:</p> <ul style="list-style-type: none"> • <i>Absence Daily Data</i> (GP_RSLT_ABS). • <i>Accumulators</i> (GP_RSLT_ACUM). • <i>Earnings and Deductions</i> (GP_RSLT_ERN_DED). • <i>Internal Worktable</i> (GP_PYE_PRC_STAT joined with GP_PYE_SEG_STAT and a segment writable array). • <i>Positive Inputs</i> (GP_RSLT_PI_DATA). • <i>Supporting Elements</i> (GP_RSLT_PIN). • <i>Writable Array Table</i> (any writable array table). |
| Writable Array Table | When the Primary Input Table is <i>Writable Array</i> , enter the table name here. This writable array is not the same as the value in the Segment Writable Array field, which applies to the entire process. |

| Field or Control | Description |
|-------------------------|--|
| Segment Option | <p>Select which data will be selected if the process encounters retroactive information. Options are:</p> <ul style="list-style-type: none"> • <i>Original</i>: Select only original segment information (no retroactive information). • <i>Original and Retro</i>: Select information coming from recalculated segments and prior segments in addition to the original segments. • <i>Last Version/Revision</i>: Select only the segments with the latest version and revision numbers. • <i>User Defined</i>: Select this option to manually choose the segment. Selecting this field displays the Last, Retro (Prior), Retro (Recalculated), and Original Calc fields. |

Report Data Process Details Page

Use the Report Data Process Details page (GP_RPT_DTL_SEC) to map fields and create filters used to generate the output table.

Navigation:

Click the **Details** link on the Define Report Data page.

This example illustrates the fields and controls on the Report Data Process Details page (1 of 2).

Report Data Process Details

Sequence 1

Output Table GP_SEG_GDE_TMP Segment Guide WA
 GP_RPTW_TMP Primary Input Table Internal Worktable

Additional Input Tables Personalize | Find | View All | First 1 of 1 Last

| *Input Table | *Join with | Update Sequence | Join Condition Defined | | |
|--------------|------------------------------|-----------------|-------------------------------------|--|--|
| JOB | Primary Input (Many to Many) | | <input checked="" type="checkbox"/> | | |

Generate Field Map

Field Map Personalize | Find | View All | First 1-8 of 8 Last

| *Output Field | *Input Type | Input Record | Input Field | | |
|----------------|------------------|--------------|----------------|--|--|
| COMPANY | Additional Input | JOB | COMPANY | | |
| CONTRACT_NUM | Additional Input | JOB | CONTRACT_NUM | | |
| DEPTID | Additional Input | JOB | DEPTID | | |
| EMPL_CTG | Additional Input | JOB | EMPL_CTG | | |
| ESTABID | Additional Input | JOB | ESTABID | | |
| LOCATION | Additional Input | JOB | LOCATION | | |
| SETID_DEPT | Additional Input | JOB | SETID_DEPT | | |
| SETID_LOCATION | Additional Input | JOB | SETID_LOCATION | | |

This example illustrates the fields and controls on the Report Data Process Details page (2 of 2).

Input Filter Personalize | View All | First 1-6 of 6 Last

*SQL

| | | |
|---|--|--|
| and LNK.EFFDT = (SELECT MAX(A.EFFDT) FROM PS_JOB A) | | |
| where A.EMPLID = LNK.EMPLID and A.EMPL_RCD = LNK.EMPL_RCD | | |
| and A.EFFDT <= WRK.SEG_END_DT) | | |
| and LNK.EFFSEQ=(SELECT MAX(B.EFFSEQ) FROM PS_JOB B | | |
| where B.EMPLID = LNK.EMPLID and B.EMPL_RCD = LNK.EMPL_RCD | | |
| and B.EFFDT = LNK.EFFDT) | | |

Aliases Available for Filter

WRK=GP_RPTW_TMP

LNK=JOB

Additional Input Tables

Additional input tables can be used in addition to the **Primary Input Table**. To use additional tables in the process, a linking relationship must be defined on this page in order to retrieve the data. The relationship can be defined with either the primary input table or the output table.

| Field or Control | Description |
|-------------------------|--|
| Input Table | Enter an input table. Once a table is defined as an additional input, any of its fields can be used to populate a field in the output table. |

| Field or Control | Description |
|-------------------------------|--|
| Join with | <p>Select one of the following options:</p> <ul style="list-style-type: none"> • <i>Output Table:</i> This creates a one to one relationship. The additional input table will be read after the output table has been populated from the primary input table. Then the selected fields from the additional input table will be used in an update statement on the output table. • <i>Primary Input:</i> This creates a many to many relationship. The additional input table will be read during the selection of the primary input table. A join is made between these tables and thus the selected fields from the additional input table will be used in an insert statement on the output table. <hr/> <p>Note: Only one additional input table can be joined with the primary input table. This additional input table is called the link table and it can be filtered with an input filter.</p> <hr/> |
| Update Sequence | <p>You must enter a sequence number when joining an input table with an output table. This sequence number determines the order of the different accesses to the additional input tables that are triggered by some update statements. There is one update statement per additional input table. For example, the field UNION_CD is populated with data from JOBCODE_TBL based on the SETID and JOBCODE defined in the output table. Then the field DISABILITY_INS is populated with data from UNION_TBL based on the UNION_CD. In this case the JOBCODE_TBL must have an Update Sequence value of 1 and the UNION_TBL must have an Update Sequence value of 2.</p> |
| Join Condition Defined | <p>The system uses this field to indicate that a join condition is defined between the additional input table and the primary input table or the additional input table and the output table, depending on the value in the Join with field. This field is read-only.</p> |
| Generate Field Map | <p>Use this push button to generate a field mapping based on the output table definition, the primary input table, the additional input tables, the writable array segment and the worktable. Once the field mapping has been generated, the user can change it using the Field Map group box.</p> |

Field Map

Once you have clicked the **Generate Field Map** button, the system populates this group box. You may then alter these fields.

Field Map Input Record and Field Tab

| <i>Field or Control</i> | <i>Description</i> |
|-------------------------|---|
| Output Field | Displays the field name of the output table. The fields of the output table are not required. You cannot select the fields that define the mandatory key structure. |
| Input Type | <p>The following options are available:</p> <ul style="list-style-type: none"> • <i>Primary Input</i>: A field from the primary input table populates the output field. • <i>Internal Worktable</i>: A field from the worktable populates the output field. Any field from GP_PYE_PRC_STAT and GP_PYE_SEG_STAT can be selected. • <i>Additional Input</i>: A field from a specific record populates the output field. • <i>Element</i>: An element populates the output field. The as of date can be specified in the As of Field field (field present in the output table). • <i>Writable Array</i>: A field from a writable array populates the output field. The as of date is the segment retro period. • <i>Period Accum</i>: A balance accumulator element populates the output field. The balance period is defined under Period Accum. • <i>Writable Array Segment</i>: The field is populated by the corresponding field present in the segment writable array, if one is defined. |
| Input Record | Enter a record name if Input Type is <i>Additional Input</i> or <i>Writable Array</i> . For other input types, the records' technical names appear. |
| Input Field | Displays the field name of the primary input, additional input, the worktable, the writable array segment, or a writable array. |

| <i>Field or Control</i> | <i>Description</i> |
|-------------------------|---|
| Reverse Sign | Indicates if the field must take the opposite sign (+/-) when the result is attached to a prior amount. Usually, this field is selected for all the fields that can be summed. This option should not be selected for fields that do not contain values, such as PIN_NUM or INSTANCE. |

Field Map Element Tab

The following fields are required if the **Input Type** is *Element*.

| <i>Field or Control</i> | <i>Description</i> |
|-------------------------|--|
| Entry Type | Select from: <i>System Element, Variable, Formula, Bracket, Earning, Deduction, Auto-Assigned, Accumulator, Count, and Duration.</i> |
| Element | This field is required if the Input Type is <i>Element</i> . Be sure to use the correct Country field. |

Field Map Element Options Tab

| <i>Field or Control</i> | <i>Description</i> |
|--------------------------------|---|
| Element Source | Required if the Input Type is <i>Element</i> or <i>Writable Array</i> . Determines how the element is read, in the case of retroactivity. <ul style="list-style-type: none"> • <i>Original</i>: Read in the original segment. • <i>Recalculated</i>: Read in the recalculated segment. |
| As of Field | Required if the Input Type is <i>Element</i> and the Element Source is <i>Original</i> . The field name is used for the As of Date to find the element. This field is populated by the output table. |
| Period Accumulator Type | Required if the Input Type is <i>Period Accumulator</i> . Values are: <i>MTD Amount, MTD Unit, PTD Amount, PTD Unit, QTD Amount, QTD Unit, YTD Amount, and YTD Unit.</i> |

Creating Input Filters

Access the Report Data Process Details page.

| <i>Field or Control</i> | <i>Description</i> |
|-------------------------------------|--|
| SQL | <p>Write a where clause to execute during the selection of the primary input table. Aliases are available. For example:</p> <ul style="list-style-type: none"> To filter only positive amounts: "and PRI.CALC_RSLT_VAL>0". To filter for one country: "and WRK.COUNTRY='USA'". To filter on a field stored in an additional input table (if joined with the primary input table): "and LNK.PIN_TYPE='ER'". |
| Aliases available for Filter | <p>This legend shows that the aliases that can be used in the SQL field. Use the button to refresh the legend. Aliases are as follows:</p> <ul style="list-style-type: none"> WRK: Represents the worktable. PRI: Represents the primary input table. LNK: Represents the record used as the additional input table that is joined with primary input table. |

Note: You can use specific words in your SQL where clause. For example: "and WRK.PAY_ENTITY in (%PARAM.PRMARG.1)". In this statement, the report data process will replace %PARAM.PRMARG.1 with the appropriate value.

Validating Report Data

Page Used to Validate Report Data

| <i>Page Name</i> | <i>Definition Name</i> | <i>Usage</i> |
|----------------------------------|------------------------|---|
| <u>Validate Report Data Page</u> | GP_RC_RPT | Enter report data parameters. Run the report data generation process in batch mode or real time. Generate SQL requests. |

Report Validation

The Validate Report Data page enables you to test a defined report with specific parameters so that you can validate the results. With this page you can:

- Run the report data generation process in batch mode.
- Run the report data generation process in real time.
- Generate SQL requests.

- View generated report data.

Validate Report Data Page

Use the Validate Report Data page (GP_RC_RPT) to enter report data parameters.

Run the report data generation process in batch mode or real time. Generate SQL requests.

Navigation:

Set Up HCM > Product Related > Global Payroll & Absence Mgmt > Reports > Validate Report Data > Validate Report Data

This example illustrates the fields and controls on the Validate Report Data page.

| Field or Control | Description |
|-------------------------|--|
| Run Mode | <p>Select one of three options:</p> <ul style="list-style-type: none"> • <i>Batch (Application Engine)</i> • <i>Real Time (PeopleCode)</i> • <i>Script (Data Mover)</i> <p>The Run Mode determines how the SQL statements are applied.</p> |
| Script Location | <p>Enter the location of the script. Data Mover can execute the script only if you selected <i>Script (Data Mover)</i> in Run Mode. Otherwise the generated scripts can be used to debug the SQL statements.</p> |

| Field or Control | Description |
|-------------------------------|---|
| Function and Parameter | <p>Enter the functions and parameter that the system will use to select data for the report. For example, by entering SELCAL/CALGRPID you can then select which calendar group ID data to use in the report. Defined values are listed in the expandable Functions and Parameters group box.</p> <hr/> <p>Note: You can also create user-defined functions and parameters to use in the input filter.</p> <hr/> |
| Type | Indicate the field type of the Parameter . Select either <i>Char</i> , <i>Date</i> , <i>Numeric</i> , or <i>SQL</i> . |
| Character Value | Enter the value of the Function or Parameter . |
| Create Scripts | Click to create a .dms containing the SQL statements and to display them on the page. The script includes a list of parameters used to generate the statements. If a parameter is not used in the process (because of a syntax error or a missing definition) the words "Not used" appear in the list. |
| Validate Report Data | <p>Select this option to validate the report data. The process used depends on your Run Mode selection:</p> <ul style="list-style-type: none"> • <i>Batch (Application Engine)</i>: The system launches an Application Engine that runs the process in batch mode via process scheduler. • <i>Real Time (PeopleCode)</i>: The system launches a PeopleCode function that runs the process in real-time. • <i>Script (Data Mover)</i>: The system launches a Data Mover process that runs the process in batch mode via process scheduler. |

Structuring Parameters

Below is a list of predefined function and parameter values.

| Function | Parameter | Parameter Value | Comment |
|-----------------|------------------|------------------------|-----------------------------|
| EXTPRC | COUNTRY | Country Code | This parameter is required. |
| EXTPRC | NAME | Report Data | This parameter is required |

| Function | Parameter | Parameter Value | Comment |
|-----------------|------------------|------------------------|---|
| EXTPRC | TYPE | P or A or B | Select one of the following: <ul style="list-style-type: none"> • P: Payroll extraction process. • A: Absence extraction process. • B: Both payroll and absence process. |
| SELPYE | SECUR | Y/N | Use this parameter to apply security to payee selection. |
| SELPYE | RECORD | Record Name | Payee selection is based on this record. It must include EMPLID and EMPL_RCD. |
| SELPYE | SQL | SQL Statement | When the parameter value field is not long enough, the user can repeat the same parameter. The system will concatenate the different values. |
| SELPYE | GRPBUILD | Group Build Code | |
| SELPYE | GRPVER | Group Build Version | |
| SELPYE | GRPLST | Group List Name | |
| SELPYE | STREAM | Stream Number | Use this parameter to tell the system whether it must use EMPL_FROM/TO. |
| SELPYE | EMPLID | Employee ID | The same parameter can be repeated. |
| SELPYE | EMPL_RCD | Employee Record Number | |
| SELCAL | CALGRPID | Calendar Group ID | |

| Function | Parameter | Parameter Value | Comment |
|-----------------|---|------------------------|---|
| SELCAL | DATE | 1, 2, 3, or 4 | <p>Select one of the following:</p> <ul style="list-style-type: none"> • 1: Period Begin Date. • 2: Period End Date. • 3: Payment Date. • 4: Period Begin Date >= FROMDT and Period End Date <= TODT. <p>If this parameter is not defined, the system uses the period end date.</p> |
| SELCAL | FROMDT | From Date | |
| SELCAL | TODT | To Date | |
| SELCAL | CYCLE | 1, 2, or 3 | <p>Select one of the following:</p> <ul style="list-style-type: none"> • 1: All Cycles (Default). • 2: Off Cycle Only. • 3: On Cycle Only. |
| SELSEG | SQL | | This is the process filter. |
| SELSEG | BALANCES | 1 or 2 | <p>Select one of the following:</p> <ul style="list-style-type: none"> • 1: Payee Level • 2: Job Level |
| SELSEG | REPLACE | Y/N | Use this parameter to determine whether replacements are considered original. |
| SEGFILTER | Any field name on the worktable and the segment writable array (if a segment writable array is defined) | Any Value | This is the segment filter. The process adds WRK.fieldname to the report. |

Using Report Data

Absence Management delivers two reports that use the Report Data feature to extract results data:

- Absence Results Register

See “Reporting Payroll Data” (PeopleSoft Global Payroll).

- Generic Reports

See Running Generic Reports.

Setting Up and Running Generic Reports

Understanding Generic Reports

Absence Management provides the framework for you to define your own generic reports of basic absence results. With generic reports, you can set up result table queries that best suit your needs. These queries are useful for quickly viewing data. They are not a substitute for the SQRs used to create final, publishable reports.

There are three types of generic reports that show different views of the same information:

- Element List

A list of absence elements for each employee for a period. Define each column as a set of numeric elements, which are accumulated.

- Summary

A list of user-defined absence elements for the absence periods between two dates for each employee. Define each row as a set of numeric elements, which are accumulated. On the run control page you define each column with a From Date and a To Date.

- Accumulator

Displays totals of selected accumulators for each employee. On the run control page, you define the absence calendars for which the report should be printed.

All of these reports enable you to select sort options and break levels. If you define break levels, the system prints a total for each break, as the break occurs, and prints a grand total at the end of the report. If no breaks are defined, no totals are printed for the report. Depending on the break levels, an employee can appear more than once on a single report (the same employee but with different segment numbers).

For all three report types, the maximum number of columns is 12.

Break Levels

Break levels are a tool for sorting results. Use them to organize the information on the report. You can include up to three break levels in a report. For example, the first level might sort employees into business units; the second might sort members of each business unit into departments; and the third might sort the members of each department into establishments. When you select the break levels for a report, you can print each section on a separate page.

System data supplies the following standard break levels:

- Department
- Company

- Establishment

Setting Up Generic Reports

Pages Used to Set Up Generic Reports

| <i>Page Name</i> | <i>Definition Name</i> | <i>Usage</i> |
|---|------------------------|--|
| Generic Report Break Levels Page | GP_GENRPT_BRK_LVL | Define break levels. |
| Generic Reports - Definition Page | GP_GENRPT_SETUP | Define the report ID and parameters. |
| Rows or Columns Page | GP_GENRPT_ROW | Define rows or columns and the elements that are to be reported. |

Generic Report Break Levels Page

Use the Generic Report Break Levels page (GP_GENRPT_BRK_LVL) to define break levels.

Navigation:

Set Up HCM > Product Related > Global Payroll & Absence Mgmt > Reports > Generic Report Break Levels > Generic Report Break Levels

This example illustrates the fields and controls on the Generic Report Break Levels page.

Generic Report Break Levels

Break Level J1
Data Type Customer Data

*Description ALL

Element

*Entry Type

Element Name

Source and Use

Database Field Set ID Controlled

System-Computed

Record (Table) Name JOB

Field Name COMPANY

Prompt View Name COMPANY_TBL

Element Name

Note: If you sort by Department break level, we recommend that you sort by Business Unit first and then by Department.

| Field or Control | Description |
|-------------------------|---|
| Break Level | A number and/or code that identifies the break level. |
| Data Type | Values are: <i>System Data:</i> For a PeopleSoft-delivered break level. <i>Customer Data:</i> For all other break levels. |
| Description | A meaningful description for the break level. This is the heading for the break data that will appear on your report. |

Element

| Field or Control | Description |
|----------------------------|--|
| Entry Type | Select the entry type of the element that you're associating with the break level. Values are <i>System Element - Character</i> and <i>Variable - Character</i> . |
| Element Name | Select the system element or variable that you're associating with the break level. For example, if you define pay group as the break level, select the GP PAYGROUP element. Note: Any element selected must be resolved and stored. |
| Record (Table) Name | If you select <i>Variable - Character</i> as the Entry Type , enter the name of the record from which the variable was originally populated. |
| Field Name | If you select <i>Variable - Character</i> as the Entry Type , in addition to entering the name of the record from which the variable was originally populated, you must also specify the field on the record. |

Source and Use

If you select a system element, information contained on the Source and Use page of GP_PIN appears in this group box.

Related Links

[Working with System Elements](#)

Generic Reports - Definition Page

Use the Generic Reports - Definition page (GP_GENRPT_SETUP) to define the report ID and parameters.

Navigation:

Set Up HCM > Product Related > Global Payroll & Absence Mgmt > Reports > Generic Reports > Definition

This example illustrates the fields and controls on the Generic Reports - Definition page.

The screenshot shows the 'Definition' tab of the Generic Reports - Definition page. It includes the following fields and controls:

- Report ID:** JGR06
- *Description:** Absence & Overtime List
- *Report Type:** Summary (dropdown menu)
- *Currency:** USD (with a search icon) and US Dollar
- Report Break Levels:**
 - Break Level 1: (dropdown menu) Page Break for Level 1
 - Break Level 2: (dropdown menu) Page Break for Level 2
 - Break Level 3: (dropdown menu) Page Break for Level 3
- Payee Options:**
 - Sort Option: Employee ID, Employee Rcd Nbr (dropdown menu) Page Break for Employee Level
 - Hide Null Lines

| Field or Control | Description |
|-------------------------|---|
| Report Type | Values are <i>Summary</i> , <i>List</i> (element list), and <i>Accumulators</i> . |
| Currency | <p>Define the default currency for the report. Amounts are converted to this currency before processing. You can change the currency on the Create Generic Reports run control page.</p> <p>Generic reports provide a maximum of 14 print positions for currency amounts. The system changes the number of decimal places, depending on the currency code. Amounts are truncated to 1, 2, or 3 decimal places, depending on the currency. If the currency does not use decimal places, all 14 print positions are available to display amounts.</p> |

Report Break Levels

| <i>Field or Control</i> | <i>Description</i> |
|---|---|
| Break Level 1, Break Level 2, and Break Level 3 | You can use up to three break levels. If you use multiple break levels, the system sorts first by break level 1, then by break level 2, and last by break level 3. Select from the break levels that you set up on the Break Levels page. |
| Page Break for Level 1, Page Break for Level 2, and Page Break for Level 3 | Select to have a page break at the selected break level on the printed report. |

Payee Options

| <i>Field or Control</i> | <i>Description</i> |
|--------------------------------------|---|
| Sort Option | Select a default method for sorting by employee. You can sort by the employee ID and employee record number or by the name and employee record number. When you run the report, you can change the sort option on the run control page. |
| Page Break for Employee Level | (Summary type only) Select to print a separate page for each employee. |
| Hide Null Lines | (List and Summary type only). Select to prevent the printing of lines that have a value of 0. |

Rows or Columns Page

Use the Rows or Columns page (GP_GENRPT_ROW) to define rows or columns and the elements that are to be reported.

Navigation:

Set Up HCM > Product Related > Global Payroll & Absence Mgmt > Reports > Generic Reports > Rows or Columns

This example illustrates the fields and controls on the Rows or Columns page.

Different fields appear on this page depending on the report type that you selected on the Generic Reports - Definition page. For all report types, the **Column Title**, **Print Total**, **Element Name**, and **Description** fields appear.

The following additional fields appear for the specified report type:

| <i>List and Summary</i> | <i>Accumulators</i> |
|-------------------------|--|
| Entry Type | User Key |
| Add/Subtract | Label Column |
| | Label (if Label Column is selected) |
| | Do not print row if results equal zero |
| | Print Calendar ID |

Rows or Columns

The following table summarizes the type of data in the rows and columns for each report type.

| Report Type | Columns | Rows |
|--------------------|------------------------------|---------------------|
| List | Element or group of elements | Payees |
| Summary | Date ranges | Element or elements |
| Accumulator | Accumulators | Payees |

| Field or Control | Description |
|---|--|
| Column Title | Define the title for each column. Each title can be two lines with up to 30 characters in each line. |
| User Key | (Accumulator type only) Select a user key for the accumulator. A column is either a user key or an element. |
| Print Total | Select to print totals before a page break. |
| Print Field Label | This check box appears only for Accumulator report types and only for columns that are not user keys. Select to print a label instead of the values for an element in the column. The system prints the text from the Label field. |
| Do not print row if results equal zero | This check box appears only for Accumulator report types and for columns that are not user keys. Select the check box to suppress rows where an accumulator does not have an end date and therefore forwards zero results into each new calendar. Selecting this check box will prevent unwanted and meaningless rows from displaying on the report. |
| Print Calendar ID | This check box appears only for Accumulator report types and only for columns that are not user keys. Select this check box to print the calendar ID of the result row, thereby increasing the readability of the report for calendar groups in which retroactive processing has occurred. |

Elements

Select the elements that are to be reported in each row or column.

| Field or Control | Description |
|-------------------------|---|
| Entry Type | Select the entry type of the element. Values are <i>Auto Assgn</i> (auto assigned), <i>Bracket</i> , <i>Deduction</i> , <i>Earnings</i> , <i>Formula</i> , <i>SystemElem</i> (system element), and <i>Variable</i> . |
| Element Name | Select the element name. |
| Label | Replaces the Description field only for the accumulator report type when you select the Label Column check box for a column that is not a user key or calendar ID. Enter the label that is to be printed in the column when the associated element is other than 0. |
| Add/Subtract | Select whether the element should be added to or subtracted from the total for the column or row. |

Note: For Accumulator report types, some precision may be needed. The system obtains all the user keys from the accumulator result table for all the accumulators that are defined in the setup. It then prints the user keys and selects the accumulator results starting from those keys.

In addition, there are cases where accumulators continue to carry forward after an event has completed because the accumulators have not been defined with an end date. In such cases, it may be necessary to identify an accumulator where the results always carry forward as zero and use the **Do not print row if results equal zero** check box. The above also applies in cases where accumulators have been defined with a storage option of "All Calculations" and the calendar run has encountered retroactive processing. Use the **Do not print row if results equal zero** check box to suppress the extra unwanted rows.

Running Generic Reports

This topic discusses how to run generic reports.

Run the report after selecting additional run time parameters such as summary or detail payee data, sorting, and begin and end dates.

The run control page triggers:

- The GP_GENRPT Application Engine program. This program prepares parameters for Report Data, which extracts the results for the GPGENRPT SQR process based on the specified run control options and setup.
- The GPGENRPT SQR program. This program reads the absence results from the extracted Report Data results and formats the report.

Selecting Payees and Periods for List and Summary Reports

The List and Summary reports can cover multiple periods. Using the Period ID, the system establishes date and payee parameters. The system will select and report on all payees that have a segment record

with the matching Period IDs. When multiple periods are selected for the List Report, the system will sum the results of all segments selected.

Selecting Payees and Periods for Accumulators

The accumulator report covers a single period. Using the Calendar Group ID, the system establishes date and payee parameters. The Calendar Group ID may contain only one period. However, if the Calendar Group has experienced retroactive processing, then additional rows may appear on the report. For this reason we recommend you select the **Print Calendar ID** check box to help identify any retroactive row.

Page Used to Run a Generic Report

| Page Name | Definition Name | Usage |
|------------------------------------|-----------------|----------------------|
| <u>Create Generic Reports Page</u> | GP_GENRPT_RC | Run generic reports. |

Create Generic Reports Page

Use the Create Generic Reports page (GP_GENRPT_RC) to run generic reports.

Navigation:

Global Payroll & Absence Mgmt > Absence and Payroll Processing > Reports > Create Generic Reports > Create Generic Reports

This example illustrates the fields and controls on the Create Generic Reports page.

To run the report, you must first specify the calendar to include. This is done by either entering Begin and End Dates (for the List and Summary report), or entering the Calendar Group ID (for the accumulator report). Because the List and Summary reports can cover multiple periods of time, enter Period IDs.

| Field or Control | Description |
|-----------------------------|---|
| Report Type | This field affects the other fields available on this page. |
| Begin Date | Use this field in combination with the End Date field to construct the report's time frame. The period defined by these dates must match the dates of a defined absence period. Some report types use the Group ID instead. |
| End Date | Use this field in combination with the Begin Date field to construct the report's time frame. The period defined by these dates must match the dates of a defined pay period. Some report types use the Group ID instead. |
| Sort Option | This field displays the sort option defined on the Generic Reports-Definition page. You can override this value here. |
| Currency | This field displays the currency defined on the Generic Reports-Definition page. You can override this value here. |
| Detail of the Payees | Select to report the details of each payee. If this option is not selected, the report includes only summaries by break level. If you do not define breaks for the report, this option is not available. |
| Group ID | You may select a subset of payees by using the Group ID section and entering a specific Group ID. This Group ID is defined on the Group Build pages in PeopleSoft HR. |
| As Of Date | Specify the effective-date version of the group to report on. |
| Refinement Date | If the group definition includes effective-dated records, enter the date for which you want the records run. For example, to run a group with an effective date of January 1, 1990 and run the effective-dated rows in the group as of February 15, 1998, select an As of Date of January 1, 1990 and a Refinement Date of February 15, 1998. If you leave this field blank, the system runs the group as of the current date. |
| Rebuild Group | Select to recreate the group before running the generic report. |

The Rows and Columns group box appears only for a Summary Type report. The system creates a set of columns for the first 12 months in the reporting period that you define in the Report ID group box. It enters the first and last days of each month in the From Date and the To Date columns. You can manually define different columns for your summary report, up to 12 columns total.

Chapter 42

Absence Management Reports

Absence Management Reports: A to Z

The table in this topic lists the PeopleSoft Absence Management reports, sorted by report ID.

For more information about running these reports, refer to:

- The corresponding topic in this product documentation.
- *PeopleTools: Process Scheduler*
- *PeopleTools: BI Publisher for PeopleSoft*.
- *PeopleTools: SQL Language Reference for PeopleSoft*

For samples of these reports, see the [Report Samples](#) that are published with this online documentation.

Note: The following reports apply only to PeopleSoft Global Payroll: Payroll Results Register (GP000001) and Payroll Results Summary report (GP000003).

| Report ID and Report Name | Description | Navigation | Run Control Page |
|--|--|---|-------------------------|
| GP000002 Absence Results Register | Displays, by payee, the results of absence calculations. Reports results by segment. Produce after you calculate or finalize an absence run. | Global Payroll & Absence Mgmt > Absence and Payroll Processing > Reports > Absence Results Register > Absence Results Register | GP_GPSQR01_PNL |
| GP000004 Payee Messages | Displays any messages generated from an absence run. | Global Payroll & Absence Mgmt > Absence and Payroll Processing > Reports > Payroll Messages > Payroll Messages | GP_GPSQR04_PNL |
| GPGENRPT User-designed generic report, no standard report name. | Define additional runtime parameters and run generic reports. | Global Payroll & Absence Mgmt > Absence and Payroll Processing > Reports > Create Generic Reports > Generic Report | GP_GENRPT_RC |

Related Links

[Absence Results Register Page](#)

Payroll Messages Page