

---

# PeopleSoft HCM 9.2: PeopleSoft Time and Labor

---

**September 2024**

PeopleSoft HCM 9.2: PeopleSoft Time and Labor  
Copyright © 1988, 2024, Oracle and/or its affiliates.

This software and related documentation are provided under a license agreement containing restrictions on use and disclosure and are protected by intellectual property laws. Except as expressly permitted in your license agreement or allowed by law, you may not use, copy, reproduce, translate, broadcast, modify, license, transmit, distribute, exhibit, perform, publish, or display any part, in any form, or by any means. Reverse engineering, disassembly, or decompilation of this software, unless required by law for interoperability, is prohibited.

The information contained herein is subject to change without notice and is not warranted to be error-free. If you find any errors, please report them to us in writing.

If this is software, software documentation, data (as defined in the Federal Acquisition Regulation), or related documentation that is delivered to the U.S. Government or anyone licensing it on behalf of the U.S. Government, then the following notice is applicable:

U.S. GOVERNMENT END USERS: Oracle programs (including any operating system, integrated software, any programs embedded, installed, or activated on delivered hardware, and modifications of such programs) and Oracle computer documentation or other Oracle data delivered to or accessed by U.S. Government end users are "commercial computer software," "commercial computer software documentation," or "limited rights data" pursuant to the applicable Federal Acquisition Regulation and agency-specific supplemental regulations. As such, the use, reproduction, duplication, release, display, disclosure, modification, preparation of derivative works, and/or adaptation of i) Oracle programs (including any operating system, integrated software, any programs embedded, installed, or activated on delivered hardware, and modifications of such programs), ii) Oracle computer documentation and/or iii) other Oracle data, is subject to the rights and limitations specified in the license contained in the applicable contract. The terms governing the U.S. Government's use of Oracle cloud services are defined by the applicable contract for such services. No other rights are granted to the U.S. Government.

This software or hardware is developed for general use in a variety of information management applications. It is not developed or intended for use in any inherently dangerous applications, including applications that may create a risk of personal injury. If you use this software or hardware in dangerous applications, then you shall be responsible to take all appropriate fail-safe, backup, redundancy, and other measures to ensure its safe use. Oracle Corporation and its affiliates disclaim any liability for any damages caused by use of this software or hardware in dangerous applications.

Oracle®, Java, MySQL, and NetSuite are registered trademarks of Oracle and/or its affiliates. Other names may be trademarks of their respective owners.

Intel and Intel Inside are trademarks or registered trademarks of Intel Corporation. All SPARC trademarks are used under license and are trademarks or registered trademarks of SPARC International, Inc. AMD, Epyc, and the AMD logo are trademarks or registered trademarks of Advanced Micro Devices. UNIX is a registered trademark of The Open Group.

This software or hardware and documentation may provide access to or information about content, products, and services from third parties. Oracle Corporation and its affiliates are not responsible for and expressly disclaim all warranties of any kind with respect to third-party content, products, and services unless otherwise set forth in an applicable agreement between you and Oracle. Oracle Corporation and its affiliates will not be responsible for any loss, costs, or damages incurred due to your access to or use of third-party content, products, or services, except as set forth in an applicable agreement between you and Oracle.

## **Documentation Accessibility**

For information about Oracle's commitment to accessibility, visit the Oracle Accessibility Program website at <https://docs.oracle.com/pls/topic/lookup?ctx=acc&id=docacc>.

## **Access to Oracle Support**

Oracle customers that have purchased support have access to electronic support through My Oracle Support. For information, visit <https://docs.oracle.com/pls/topic/lookup?ctx=acc&id=info> or visit <https://docs.oracle.com/pls/topic/lookup?ctx=acc&id=trs> if you are hearing impaired.

# Contents

- Preface: Preface..... xxiii**
  - Understanding the PeopleSoft Online Help and PeopleBooks..... xxiii
    - Hosted PeopleSoft Online Help.....xxiii
    - Locally Installed PeopleSoft Online Help.....xxiii
    - Downloadable PeopleBook PDF Files..... xxiii
    - Common Help Documentation..... xxiii
    - Field and Control Definitions..... xxiv
    - Typographical Conventions.....xxiv
    - ISO Country and Currency Codes..... xxv
    - Region and Industry Identifiers.....xxv
    - Translations and Embedded Help..... xxvi
  - Using and Managing the PeopleSoft Online Help..... xxvi
  - PeopleSoft HCM Related Links..... xxvi
  - Contact Us.....xxvi
  - Follow Us.....xxvii
- Chapter 1: Getting Started with Time and Labor..... 29**
  - Time and Labor Overview..... 29
  - Time and Labor Business Processes..... 29
  - Time and Labor Integrations..... 30
  - Time and Labor Implementation..... 31
- Chapter 2: Navigating in Time and Labor..... 35**
  - Navigating in Time and Labor..... 35
  - Pages Used to Navigate in Time and Labor..... 35
- Chapter 3: Understanding Time and Labor..... 37**
  - Scheduling..... 37
  - Time Reporting Methods..... 38
  - Time Administration..... 38
  - Time Management Features..... 39
  - User Preferences..... 39
  - Configurable Manager Views..... 40
  - Delivered Data Archive Templates..... 40
- Chapter 4: Setting Up Basic Tables..... 49**
  - Understanding Time and Labor Implementation..... 49
    - Human Resource Tables..... 50
    - Benefits Tables..... 51
    - Time Zone Offsets Table..... 52
    - Concurrent Batch Processing..... 53
    - Concurrent Online Processing..... 53
    - Time Periods..... 54
    - Periods and Period Instances..... 56
    - Planned Overtime Features..... 57
    - Time Period Calendars..... 57
    - Manager Time Calendar View Options..... 58
    - Compensatory Time Plans..... 58
    - Exceptions..... 59
    - PeopleSoft Application Engine Sections..... 59

Validation Criteria.....	60
Setting Up System Defaults and Loading Dates.....	60
Pages Used to Set Up System Defaults and Load Dates.....	60
Time and Labor Installation Page.....	61
Configurations Page.....	79
Dates Table Load Page.....	85
The Purpose of Load Dates.....	86
Manager Search Defaults Page.....	87
Self Service Header Info Page.....	90
User Preferences Page.....	90
My Preferences_Time and Labor page.....	93
Color Settings.....	94
Setting Up the Time and Labor Mobile Applications.....	94
Pages Used to Set Up Mobile Applications in Time and Labor.....	95
Pre requisites.....	95
Workgroup - Definition Page.....	96
Workgroup — Approval / Timesheet Control Page.....	96
Configurations Page.....	97
User Preferences Page.....	98
Payroll System Options.....	99
Page Used to Establish Payroll System Options.....	99
Pay System Page.....	100
Establishing Time Periods.....	101
Pages Used to Establish Time Periods.....	101
Daily Time Period Page.....	101
Weekly Time Period Page.....	103
Monthly Time Period Page.....	104
Complex Time Period Page.....	105
Repeating Time Period Page.....	106
Setting Up Planned Overtime Features.....	107
Pages Used to Set Up Overtime Features.....	107
Prerequisites.....	107
Overtime Limit Page.....	108
Overtime TRC Value List Page.....	110
Workgroup Page.....	111
Enabling Workflow.....	111
Building and Viewing Time Period Calendars.....	113
Pages Used to Build and View Time Period Calendars.....	113
Understanding General Rules for Building Periods and Calendars.....	113
Build Time Period Calendar Page.....	118
View Time Period Calendar Page.....	121
Setting Up Manager Time Calendar View Options.....	122
Pages Used to Set Up Calendar Viewing Options.....	122
Understanding Manager Time Calendar Views.....	123
Prerequisites.....	123
Calendar View Options Page.....	123
Preview Legend Page.....	128
Establishing Compensatory Time Plans.....	128
Page Used to Set Up Compensatory Time Plans.....	128
Compensatory Time Off Plan Page.....	128
Defining Exceptions.....	130

Page Used to Define Exceptions.....	130
Exception Definition Page.....	130
Defining PeopleSoft Application Engine Sections.....	133
Page Used to Define PeopleSoft Application Engine Sections.....	133
Validation Executable Page.....	133
Using Validation Criteria.....	134
Pages Used to Define and Group Validation IDs.....	134
Validation Rule Page.....	134
Validation Set Page.....	135
Defining Override Reason Codes.....	136
Page Used to Define Override Reason Codes.....	137
Override Reason Code Page.....	137
<b>Chapter 5: Establishing Workgroups.....</b>	<b>139</b>
Understanding Workgroups.....	139
Common Elements Used in This Section.....	139
Workgroup Requirements.....	140
Workgroups and Referential Integrity.....	141
Setting Up Workgroups.....	142
Page Used to Define Workgroups.....	142
Workgroup - Definition Page.....	142
Workgroup - Approval/Timesheet Control Page.....	144
Approval Groups Page.....	152
Defining the Reporting Time Type Group Box.....	153
Defining Compensation Controls.....	153
Setting Up Rounding Options.....	154
Specifying Workgroup Defaults.....	163
Setting Up Day Breaker Options.....	166
Making Workgroup Transfers.....	174
Making Changes to a Rule Program of a Workgroup.....	177
<b>Chapter 6: Establishing Time Reporting Codes.....</b>	<b>179</b>
Understanding Time Reporting Codes.....	179
Common Elements Used in This Section.....	179
Defining Time Reporting Code (TRC) Categories.....	180
Pages Used to Define Time Reporting Code (TRC) Categories.....	180
TRC Category Page.....	180
Defining and Mapping Time Reporting Codes (TRCs).....	181
Pages Used to Define and Map Time Reporting Codes.....	184
Time Reporting Codes - Definition Page.....	185
Time Reporting Codes - Approval and Comment Page.....	197
Defining TRC Programs.....	199
Pages Used to Define a TRC Program.....	199
TRC Program Page.....	199
Copy TRC Program Page.....	201
Defining Units of Measure.....	201
Page Used to Define Units of Measure.....	202
Units of Measure Page.....	202
Working Through TRC Examples.....	203
<b>Chapter 7: Defining Task Reporting Requirements.....</b>	<b>207</b>
Understanding Task Reporting Requirements.....	207
Understanding Task Functionality.....	207
Understanding Task Reporting Tools.....	207

Understanding Types of Task Reporting.....	209
Understanding How to Create Task Values in Time and Labor.....	210
Using ChartFields in Time and Labor.....	215
Understanding Task Reporting with PeopleSoft Financials.....	218
Understanding the Sequence for Defining Task Functionality.....	219
Creating Task Templates.....	221
Page Used to Create Task Templates.....	221
Task Template Page.....	221
Uploading ChartField Combinations.....	227
Page Used to Upload ChartField Combinations.....	230
Upload ChartField Combinations Page.....	230
Defining and Viewing Task Values in Time and Labor.....	232
Pages Used to Define and View TL Entities.....	232
Project Page.....	233
Manage TL Activity Codes Page.....	234
User Field 1–5 Pages.....	234
Displaying Task Codes Defined in Project Costing and Performance Management.....	235
Pages Used to Display Task Codes in Project Costing and Enterprise Performance Management.....	235
PC Business Unit Page.....	236
PC Project Descr Page.....	237
PC Project Team Page.....	238
Resource Type Page.....	239
Resource Category Page.....	240
Business Unit PF Page.....	240
Creating Task Profiles.....	241
Page Used to Create Task Profiles.....	241
Task Profile Page.....	242
Defining Taskgroups.....	245
Page Used to Define Taskgroups.....	245
Taskgroup Page.....	245
<b>Chapter 8: Defining Work Schedules.....</b>	<b>249</b>
Understanding Work Schedules.....	249
Creating Work Schedules and Schedule Definitions.....	251
Pages Used to Create Work Schedules, and Schedule Definitions.....	252
Shift Page.....	252
(BRA) Details Bra Page.....	258
Schedule Group Page.....	259
Workday Page.....	260
Definition Page.....	260
Rotating Schedules.....	263
Schedule Shifts Page.....	264
Validating Schedules.....	268
Pages Used to Validate Schedules.....	268
Schedules to be Validated Page.....	268
Sharing Work Schedules with Global Payroll.....	269
Importing Third-Party Schedules.....	269
Managing Third-Party Schedules.....	279
<b>Chapter 9: Establishing Static and Dynamic Groups.....</b>	<b>283</b>
Understanding Static and Dynamic Groups.....	283
Understanding Group Security.....	283

Setting Group Creation Security.....	284
Understanding Group Creation Security.....	285
Page Used to Set Group Creation Security.....	285
Group Creation Security Page.....	285
Creating and Updating Static Groups.....	288
Pages Used to Create and Update Static Groups.....	288
Static Group - Selection Criteria Page.....	288
Static Group - Current Group Members Page.....	293
Static Group - Security by Group Page.....	294
Creating and Updating Dynamic Groups.....	295
Pages Used to Create and Update Dynamic Groups.....	295
Dynamic Group - Selection Criteria Page.....	295
Dynamic Group - Potential Group Members Page.....	298
Static Group - Security by Group Page.....	299
Dynamic Group - Current Group Members Page.....	299
Refresh Dynamic Groups Page.....	300
<b>Chapter 10: Setting Up Time Reporters.....</b>	<b>303</b>
Understanding Time Reporter Data.....	303
Entering and Maintaining Time Reporter Data.....	306
Pages Used to Enter and Maintain Time Reporter Data.....	307
Create Time Reporter Data Page.....	307
Maintain Time Reporter Data Page.....	313
Time Reporter Group Membership Page.....	317
Assigning and Viewing Compensatory Time Plans.....	318
Pages Used to Assign and View Compensatory Time Plans.....	318
Compensatory Plan Enrollment Page.....	319
Comp Plan History Page.....	320
Assigning Schedules to a Group.....	320
Pages Used to Assign Schedules.....	321
Assign Schedule to a Group Page.....	321
<b>Chapter 11: Time and Labor Support for Affordable Care Act.....</b>	<b>323</b>
Understanding the Time and Labor Functionality Supporting Affordable Care Act.....	323
Using PeopleSoft Time and Labor for Affordable Care Act.....	323
Setting Up ACA Time Reporting Codes.....	325
Pages Used to Set Up ACA Time Reporting Codes.....	326
ACA Time Reporting Codes Page.....	326
Time and Labor Groups Page.....	327
Creating And Maintaining ACA Materialized Views.....	329
Pages Used to Maintain The Materialized Views.....	330
Materialized View Maintenance Page.....	330
Running the ACA Eligibility Load query.....	332
Pages Used to Define the ACA Eligibility Load Query.....	332
Query Manager Page.....	332
Time and Labor WorkCenter_ACA Eligibility — Monthly Period Page.....	333
Time and Labor WorkCenter_ACA Eligibility — Weekly Period Page.....	334
Generating Reports for Analysis.....	336
Pages Used to Configure Data And Generate Reports.....	336
ACA Threshold Limits Page.....	336
ACA Employee Threshold Report Page.....	337
ACA Full/Part Time Status Page.....	339
ACA New Hire/Rehire Report Page.....	341

<b>Chapter 12: Establishing Time and Labor Security.....</b>	<b>343</b>
Understanding Row Security Permission Lists.....	343
Using Row Security Permission Lists.....	344
Pages Used for Using Row Security Permission Lists.....	345
Row Security Permission List Page.....	345
Row Security Users Page.....	350
<b>Chapter 13: Creating Rules in Time Administration.....</b>	<b>351</b>
Understanding Time Administration.....	351
Create Rules Component.....	351
Batch Processing Component.....	352
Online Processing Component.....	352
Understanding Rules.....	353
General Setup Steps.....	354
Rules from Actions and Conditions and SQL Objects.....	354
Rule Step Creation Guidelines.....	355
Creating Value Lists.....	364
Page Used to Create Value Lists.....	365
Value Lists Page.....	365
Defining Rule Elements.....	366
Page Used to Define Rule Elements.....	367
Rule Element 1 through Rule Element 5 Pages.....	367
Specifying Table Access.....	367
Page Used to Grant SQL Access to Tables.....	368
Working Tables Page.....	368
Defining Table Relationships.....	370
Page Used to Define Table Relationships.....	370
Relationship Definitions Page.....	370
Defining Template-Built Rules.....	371
Pages Used to Create Rules from a Template.....	400
Creating Rules from a Template.....	401
Template Header Page.....	401
Approval Rule Detail Page.....	405
Creating Rules with Actions and Conditions.....	410
Pages Used to Create Rules with Actions and Conditions.....	410
Action Header Page.....	410
Action Detail Page.....	413
Conditions Page.....	418
Creating SQL Objects.....	421
Pages Used to Create SQL Objects.....	424
SQL Object Page.....	425
Tables Page.....	427
Select - Fields Page.....	429
Joins Page.....	431
Where Expressions Page.....	432
Insert - Fields Page.....	434
TL SQL Insert SecPNL Page.....	435
Updating Fields Page.....	436
Expression Text Page.....	438
Working with User Exits.....	439
Defining Attendance Programs.....	440
Pages Used to Define Attendance Programs.....	440



Understanding Tracking Methods.....	441
Understanding Attendance Program Tasks.....	442
Attendance Program Page.....	442
Attendance Actions Page.....	444
Review Attendance Actions Page.....	446
Attendance History Page.....	446
Assembling Rules.....	447
Pages Used to Assemble Rules.....	448
Rules Page.....	448
Action SQL Text Resolution Page.....	452
Exporting, Importing, and Recompiling Rules.....	453
Pages Used to Export, Import, and Recompile Rules.....	453
Understanding Rules Migration.....	453
Rules Export Page.....	454
Rules Import Page.....	455
Rules Recompile Page.....	455
Adding Rules to a Rule Program.....	456
Pages Used to Add Rules to A Rule Program.....	457
Rule Programs page.....	457
<b>Chapter 14: Creating Rule Templates.....</b>	<b>461</b>
Understanding Rule Template Creation.....	461
Example: Creating a New Rule Template.....	461
Prerequisites for Creating Rule Templates.....	469
Creating Rule Templates.....	471
Pages Used to Create Rule Templates.....	471
Template Definition Page.....	471
Template Steps Page.....	475
Template Text Parameters Page.....	477
Template Step Parameters Page.....	478
<b>Chapter 15: Understanding the Batch Process in Time Administration.....</b>	<b>481</b>
Understanding the Time Administration Process Flow.....	481
Overview of the Time Administration Application Engine Processes.....	483
Understanding the Time Administration Control Table (TL_TR_STATUS).....	494
Batch Processing Terms and Concepts.....	495
Step 1: Determining Time Reporters to Process.....	495
Using Time Reporter Status in the Selection Process.....	497
Defining the Initial Period of Interest.....	500
Step 2: Combining Time Reporters Into Batches.....	502
Step 3: Resolving Pending Time Reporting Exceptions.....	503
Step 4: Building the Rule Map.....	503
Determining the Final Period of Interest.....	504
Step 5: Building Time Reporter Profiles.....	513
Step 6: Explaining the Time Administration Main Batch Loop Driver.....	514
Step 7: Explaining Batch Driver Calls of Time Administration.....	514
Step 8: Matching Punches.....	514
Step 9: Creating Intermediate Payable Time.....	516
Understanding the Data Store.....	516
Loading the IPT Tables.....	517
Step 10: Tracking Attendance.....	519
Step 11: Processing Rules.....	520
Step 12: Performing Rounding, Task Distribution and Estimated Gross.....	520

Check Leave and Comp Time Balances.....	520
Expand Task Profiles.....	524
Apply Post Rules Rounding.....	524
Calculate Estimated Gross.....	524
Step 13: Post Rule Validation.....	526
Step 14: Processing Adjustments.....	526
Understanding the Adjustment Process.....	527
Step 15: Updating Payable Time.....	529
Understanding the Difference between Payable Time and Intermediate Payable Time.....	529
Understanding How Time Administration Formats Payable Time.....	530
Step 16: Updating Time Reporter Status.....	534
Viewing and Updating Time Reporter Status.....	534
Pages Used to View Time Reporter Status.....	534
Understanding Time Reporter Status.....	534
Time Reporter Status Page.....	535
Update TA Status and ECD Page.....	536
Launching the Time Administration Process.....	540
Page Used to Start the Time Administration Process.....	540
Understanding When the Process is Called.....	540
Request Time Administration Page.....	540
Restarting Batch Processes in Time and Labor.....	544
Generating and Viewing Runtime Statistics.....	545
Pages Used to Generate and View Runtime Statistics.....	545
Time Administration Options Page.....	545
Time Administration Statistics Page.....	547
Program Statistics Page.....	549
Batch Statistics Page.....	550
Rule Statistics Page.....	551
Using Batch Processing Tips.....	553
<b>Chapter 16: Time and Labor Auto Enrollment.....</b>	<b>557</b>
Understanding Auto Enrollment.....	557
Setting Up Auto Enrollment.....	559
Pages Used to Set Up Auto Enrollment.....	559
Time and Labor - Auto Enrollment Page.....	559
Workgroup Overrides Page.....	561
Setting Up Enrollment Group.....	561
Pages Used to Set Up Auto Enrollment Group.....	562
Enrollment Group Page.....	562
Time and Labor Enrollments Page.....	564
Time Reporting Preferences Page.....	564
Schedule Assignment Group Page.....	565
Schedule Assignment Page.....	566
Process Auto Enrollments Page.....	567
Auto Enrollment Data Correct Page.....	568
<b>Chapter 17: Understanding Payable Time.....</b>	<b>571</b>
Understanding Payable Time.....	571
Payable Time Attributes.....	571
Payable Time Status and Reason Codes.....	572
Summary of System Settings that Determine Payable Time Status.....	578
Publishing Estimated and Actual Payable Time.....	579
Publishing Payable Time with Estimated Costs.....	579

Publishing Payable Time with Actual Costs.....	580
Understanding Payable Time Fields.....	580
Generating a Payable Status Report.....	584
Page Used To Generate a Payable Status Report.....	585
Payable Status Page.....	585
<b>Chapter 18: Reporting Time.....</b>	<b>589</b>
Understanding Time Reporting.....	589
Creating Time Reporting Templates.....	590
Page Used to Create Time Reporting Templates.....	591
Understanding Time Reporting Templates.....	591
Time Reporting Template Page.....	592
Punch Pattern Page.....	599
Creating Templates for Rapid Time Reporting.....	601
Page Used to Create Templates for Rapid Time Reporting.....	601
Understanding Rapid Time Reporting.....	601
Rapid Time Template Page.....	603
Reporting Time Rapidly.....	607
Pages Used to Report Time.....	607
Understanding Rapid Time Reporting.....	607
Rapid Time Page.....	608
TimeCard Page.....	612
<b>Chapter 19: Using Time Collection Devices.....</b>	<b>613</b>
Understanding TCDs.....	613
Understanding TCD Setup and Data Integration.....	613
TCD Setup Process Flow.....	615
Integration Points Used to Publish Data to Time and Labor.....	615
Understanding XML Integration.....	616
Understanding Flat File Integration.....	616
Defining TCD Setup Data in Time and Labor.....	619
Pages Used to Define TCD Setup Data in Time and Labor.....	619
TCD Type Definition Page.....	620
TCD Setup Page.....	624
TCD Taskgroup Page.....	628
TCD Supervisor Page.....	630
TCD Restriction Profile Page.....	631
TCD Group Page.....	632
Sending Setup Data to a TCD.....	633
Page Used to Send Setup Data to a TCD.....	634
Understanding Data Publishing to a TCD.....	634
Send Setup to TCD Page.....	637
Receiving Time from a TCD.....	639
Viewing and Resolving TCD Errors.....	641
Pages Used to View and Resolve TCD Errors.....	641
Review TCD Errors Page.....	642
TCD Elapsed Time Errors Page.....	643
Elapsed Time Attributes Page.....	645
TCD Punched Time Errors Page.....	646
Punched Time Error Attributes Page.....	648
<b>Chapter 20: Using Approvals and Delegations with Time and Labor.....</b>	<b>651</b>
Understanding the Approval Process in Time and Labor.....	651
Approval Framework and Time and Labor.....	651

Approval Foundation Elements.....	652
Approval Events and Actions.....	654
Prerequisites.....	658
Approving Reported Time.....	659
Pages Used to Approve Reported Time.....	659
Understanding Approval of Reported Time.....	659
Approve Reported Time - Timesheet Summary Page.....	660
Timesheet Page.....	663
Comments Page.....	665
Payable Time Detail Page.....	665
Reviewing and Entering Absence Events.....	666
Entering Absence Event Details.....	667
Forecasting Absence Events.....	672
Approving Absence Events.....	673
Approving Payable Time.....	674
Pages Used to Approve Time.....	674
Understanding Approval of Payable Time.....	675
Approve Payable Time - Approve Time for Time Reporters Page.....	675
Approve Payable Time Page.....	677
Timesheet Page.....	678
Request Batch Approval Process Page.....	679
Working with Delegations in Time and Labor.....	680
Understanding Delegation.....	680
Reviewing Delivered Time and Labor Delegation Set Up.....	681
<b>Chapter 21: Managing Time.....</b>	<b>685</b>
Understanding the Time Reporting Process.....	685
Prerequisites for Enabling Absences on Timesheets.....	686
Common Elements Used in This Section.....	686
Managing Exceptions.....	687
Pages Used to Manage Exceptions.....	687
Understanding Exceptions.....	687
Exceptions Page.....	690
Viewing Manage Exception Details.....	692
Exceptions History Page.....	693
Adjusting Time.....	695
Pages Used to Adjust Time.....	695
Understanding Adjustments to Payable Time.....	695
Adjust Paid Time Page.....	696
Auditing Time.....	700
Pages Used to Audit Time.....	700
Understanding Auditing Time.....	701
Reported Time Audit Page.....	702
Reported Time Audit - History Page.....	705
Unprocessed Reported Time Page.....	706
Unprocessed Payable Time Page.....	707
Overriding Rules for a Day.....	710
Page Used to Override Rules for a Day.....	710
Override Rules Page.....	710
Setting up and Managing Alerts.....	711
Pages Used to Set Up and Manage Alerts.....	712
Understanding Alerts Framework.....	712

Alert Criteria Page.....	713
Alert Criteria-Balances Page.....	714
Alert Criteria-Exception Page.....	715
Alert Criteria-Limit Page.....	715
Alert Criteria-Pattern Page.....	716
Alert Criteria-Status Page.....	717
Alert Criteria-Unprocessed Time Page.....	717
Alert Criteria-Data Verification Page.....	718
Alert Program Page.....	718
Alert Notification Page.....	719
Value List Page.....	720
Process Alerts Page.....	721
Administer Alerts Page.....	722
Locking Timesheets.....	722
Page Used to Lockdown Timesheets.....	723
Timesheet Lockdown Page.....	723
HCM Lockdown Framework.....	724
<b>Chapter 22: Integrating with Payroll Applications.....</b>	<b>725</b>
Overview of Payroll Integration.....	725
General Procedure for Running a Payroll with Payable Time.....	725
Labor Distribution and Dilution.....	727
Integrating Time and Labor and Payroll for North America.....	729
Processing Overview.....	730
Configuring Time and Labor for Use with Payroll for North America.....	730
Preparing Time and Labor Data for Payroll for North America.....	732
Loading Time and Labor Data.....	732
Running the Payroll Process.....	735
Reversing or Adjusting a Paycheck.....	736
Extracting Costs After a Pay Run.....	736
Adjusting Payable Time.....	738
Refreshing Data.....	739
Correcting Errors Generated During the Load and Extract Processes.....	739
Integrating Time and Labor with Global Payroll.....	740
Processing Overview.....	740
Configuring Time and Labor for Integration with Global Payroll.....	741
Loading Time and Labor Data.....	742
Correcting Errors Generated by Payable Time.....	744
Updating Payable Time After a Pay Run.....	745
Sharing Work Schedules with Global Payroll.....	746
Integrating Absence Event Data.....	746
Understanding Absence Event Integration with Time and Labor.....	746
Integrating Absence Management, Time and Labor, and Payroll for North America.....	747
Integrating the Absence Functionality of Global Payroll with Time and Labor.....	751
<b>Chapter 23: Integrating with Absence Management.....</b>	<b>755</b>
Overview of Absence Integration.....	755
Understanding the TL_GENPT PS Job.....	756
Enhanced Integration of Absence Management with Time and Labor.....	757
Page Used to Integrate Absence Management with Time and Labor.....	757
Generate Absence Payable Time Page.....	757
<b>Chapter 24: Integrating with PeopleSoft Financials and Enterprise Performance Management.....</b>	<b>761</b>

Understanding Integration.....	761
Understanding Integration Points.....	761
Integrating with Project Costing.....	766
Understanding Project Costing Integration.....	766
Setting Up Time and Labor for Integration with Project Costing.....	768
Publishing Estimated and Actual Cost Data to Project Costing.....	771
Pages Used to Send Estimated and Actual Costs Data to Project Costing.....	771
Understanding Estimated and Actual Cost Data.....	771
Publish Estimated Payable Time Page.....	775
Publish Actual Payable Time Page.....	775
Using Time and Labor with Commitment Accounting.....	776
Understanding the Commitment Accounting Interface.....	776
Setting Up Time and Labor for Use with Commitment Accounting.....	778
Distributing Costs after a Pay Run.....	779
Integrating with Performance Management.....	780
<b>Chapter 25: Using Self-Service Components.....</b>	<b>781</b>
Understanding Self-Service Components.....	781
Navigating in Time and Labor Home Pages.....	782
Using Time and Labor Launch Pad Pages for Employees.....	784
Pages Used to Specify Time and Labor Launch Pad Information for Employees.....	784
Time and Labor Launch Pad Page.....	785
Details Page.....	787
Monthly Schedule Page.....	788
Monthly Schedule - Daily Detail Page.....	789
Setting Up User Preferences.....	790
Pages Used to Set Up User Preferences.....	790
Understanding the User Preferences Page.....	790
Time Reporting Preferences Page.....	791
Understanding Task Value Defaults.....	793
Schedule Preferences Page.....	793
Send Notification Page.....	795
Setting Up Preferences Using Fluid.....	796
Pages Used to Set Up Preferences Using Fluid.....	796
Understanding the My Preferences Page.....	797
Time Reporting Preferences Page.....	797
Schedule Preferences Page.....	805
Reporting Time.....	807
Pages Used in Reporting Time.....	807
Common Elements Used in this Section.....	808
Timesheet Page.....	809
Timesheet Display: Self-Service Versus Manager Self-Service.....	812
Web Clock - Enter Punch Page.....	815
Using Mass Time.....	816
Mass Time - Select Time Reporting Method Page.....	816
Mass Time - Report Time Page.....	818
Compensatory Time Page.....	821
Viewing Time.....	823
Pages Used to View Time.....	823
Exceptions Page.....	823
Payable Time Summary Page.....	825
Payable Time Details Page.....	826

Forecasted Time Summary Page.....	827
Requesting Overtime.....	828
Pages Used to Enter, View, and Process Overtime Requests.....	829
Understanding Overtime Transactions.....	829
Request Overtime - Overtime Requests Page.....	829
Request Overtime - Request Overtime List Page.....	830
Request Overtime - Overtime Request Details (Add) Page.....	831
<b>Chapter 26: Using Manager Self-Service Workforce Availability.....</b>	<b>833</b>
Understanding the Workforce Availability.....	833
Common Elements Used In the Workforce Availability.....	834
<b>Chapter 27: Using the PeopleSoft Fluid User Interface in Time and Labor.....</b>	<b>835</b>
Using PeopleSoft Fluid User Interface for Time Reporting as an Employee.....	835
Pages Used to Perform the Tasks as an Employee.....	835
Time Tile.....	838
Time Collection — Actionable Tiles.....	839
Enter Time Tile.....	843
Enter Time Page for Elapsed Time Reporter.....	844
Enter Time Details Page.....	850
Enter Time Page for Punch Time Reporter.....	851
Legend Page.....	857
Request Absence Modal.....	858
Time Reporting Comments Page.....	859
Delete Confirmation Page.....	859
Report Time Tile.....	860
Report Time Page for Elapsed Time Reporter.....	861
Setting up Meal Break Waivers for Non-Exempt Workers.....	865
Report Time Page for Punch Time Reporter.....	866
Time Summary Tile.....	874
Time Summary Page.....	875
View Exceptions Tile.....	883
View Exceptions Page.....	883
Setup Quick-Fill Tile.....	884
Setup Quick-Fill Page.....	885
Report Time Details Page.....	889
Weekly Time Tile.....	890
Weekly Time Page.....	891
(Smartphone) Weekly Time Review Page.....	894
Weekly Time Summary Tile.....	896
Weekly Time Summary Page.....	896
Report Leave Tile.....	897
Payable Time Tile.....	897
Payable Time Page.....	898
Leave / Comp Time Tile.....	898
Leave / Comp Time Page.....	899
Leave Balances History page.....	900
Using PeopleSoft Fluid User Interface for Time Management as a Manager.....	900
Common Elements in Team Time Manager Self Service.....	901
Pages Used to Manage Time as a Manager Using the PeopleSoft Fluid User Interface.....	902
Team Time Tile.....	905
Team Time Navigation Collection.....	906
Team Time Direct Reports Tile.....	907

Team Time Directs Collection.....	908
Select Employee Page.....	910
Report Time Select Employee Filters page.....	922
Weekly Time Entry page.....	925
Weekly Time Summary page.....	928
Payable Time (Select Employees) page.....	929
Payable Time page.....	930
Leave / Comp Time page.....	931
Attendance Violations page.....	938
Manage Exceptions Page.....	940
Reporting Locations Page.....	942
Workforce Availability Page.....	943
Common Elements Used In the Workforce Availability.....	946
Scheduled Daily Page.....	948
No Show Daily Pages.....	949
Schedule Deviation Daily Pages.....	952
Not Scheduled Daily Page.....	955
Elapsed Daily Page.....	956
Away From Work Daily Category.....	958
Unapproved Absence Daily Page.....	958
Approved Absence Daily Page.....	961
Training Daily Page.....	964
Comp Time Off Page.....	966
Weekly Time Views.....	969
Workforce Availability - Scheduled Weekly Page.....	969
Schedule Deviation Weekly Page.....	974
Away From Work Daily Category.....	977
Unapproved Absence Weekly Page.....	978
Approved Absence Weekly Page.....	980
Training Weekly Page.....	982
Comp Time Off Weekly Page.....	985
Time and Labor Fluid WorkCenter Page.....	988
Maintain Scope Detail Page.....	992
Understanding the My Work Group Box.....	992
Alert Type_Balances Page.....	993
Allowable Exception Page.....	996
Fix Exception Page.....	998
Reported Time Approvals Page.....	999
Understanding the Links Group Box.....	999
Understanding the Queries Group Box.....	1000
Understanding the Reports/Processes Group Box.....	1001
Managing Time Enrollments Using Fluid.....	1002
Pages Used to Manage Time Enrollments Using Fluid.....	1003
Manage Time Reporter Data Tile.....	1003
Search Criteria Page.....	1004
Create Time Reporter Data Page.....	1007
Manage Time Reporter Data Page.....	1013
Time Reporter Group Membership Page.....	1016
Time Reporter - Badge Detail Page.....	1018
Managing Schedules Using Fluid.....	1018
Pages Used to Manage Schedules using Fluid.....	1018



Manage Schedule Tile.....	1019
Manage Schedule - Search Criteria Page.....	1020
Schedule Actions Summary Page.....	1021
Assign Schedule Page.....	1023
Schedule Assignment History Page.....	1029
Manage - Replace Schedule Page.....	1031
Manage Schedule - Swap Schedules Page.....	1036
Manage Schedule - Copy Schedules Page.....	1039
Schedule Preferences Page.....	1040
Override Schedules Page.....	1043
Managing Schedules Using Fluid for Employees.....	1051
Pages Used to Manage Schedules using Fluid.....	1052
Request Schedule Change Tile.....	1052
Request Schedule Change Page.....	1053
Give up your Shift Page.....	1053
Request Summary Page.....	1055
Trade your Shift Page.....	1055
Schedule Calendar Page.....	1057
Display Only Employees with No Conflicts.....	1058
View All.....	1059
Request Summary Page.....	1060
Using the PeopleSoft Fluid User Interface to Work with Time and Labor as an Administrator.....	1061
Pages Used to Work with Time and Labor as an Administrator Using the PeopleSoft Fluid	
User Interface.....	1061
Time and Labor Tile.....	1062
Time and Labor Dashboard.....	1062
Reported Time Audit Tile.....	1063
Reported Time Audit Page.....	1064
Time and Labor WorkCenter Tile.....	1069
Time and Labor WorkCenter Page.....	1070
Maintain Scope Detail Page.....	1073
Understanding the My Work Group Box.....	1074
Reported Time Status page.....	1075
Attendance Violations Page.....	1075
Attendance Actions Page.....	1077
Understanding the My Approvals Group Box.....	1078
Understanding the My Insights Group Box.....	1078
Understanding the Links Group Box.....	1079
Understanding the Queries Group Box.....	1080
Understanding the Reports/Processes Group Box.....	1080
Reported Time Insight Tile.....	1081
Reported Time Insight Dashboard.....	1083
Viewing Payable Time Analytics.....	1090
Pages Used to View Payable Time Analytics.....	1091
Common Elements and Controls.....	1091
Understanding How to Deploy and Access the Payable Time Analytics.....	1093
Payable Time Insight Tile.....	1094
Payable Time Insight Dashboard.....	1094
Payable Time Trend Tile.....	1101
Payable Time Trend Dashboard.....	1102
Approving Time Using Fluid Approvals.....	1103

Pages Used to Approve Time Using Fluid Approvals.....	1104
Approvals Navigation Collection.....	1104
Pending Approvals - Overtime Request.....	1105
Overtime Request Details Page.....	1107
Request History.....	1108
Approval Chain Details Page.....	1108
Pending Approvals Navigation Collection page.....	1109
Pending Approvals_Payable Time Page.....	1112
Approval Line Details Page.....	1116
Approval Chain Page.....	1118
Pending Approval- Reported Time.....	1119
Pending Approval_Reported Time Page.....	1123
Approval Chain Page.....	1129
Approval Line Detail_Comments Page.....	1129
<b>Chapter 28: Using Time and Labor Auto Enrollment Analytics.....</b>	<b>1131</b>
Using Auto Enrollment Analytics for Managing Previews and Errors.....	1131
Understanding the Time and Labor Auto Enrollment Analytics.....	1131
Common Elements Used in this Topic.....	1132
Time and Labor Auto Enrollment Tile.....	1133
Preview Time and Labor Report.....	1133
Preview Schedule Assignment Report.....	1135
Errors Time and Labor Report.....	1136
Errors Schedule Assignment Report.....	1138
<b>Chapter 29: Using Manager Self-Service Components for Time Management and Reporting.....</b>	<b>1139</b>
Understanding Manager Self-Service Components.....	1139
Navigating in Time and Labor Self-Service Pages for Managers.....	1142
Using Time and Labor Launch Pad Pages for Managers.....	1143
Pages Used to Specify Time and Labor Launch Pad Information for Managers.....	1144
Time and Labor Launch Pad.....	1144
Application Suites Page.....	1146
Application Items Page.....	1147
Application Items for Managers.....	1148
Reporting Time.....	1149
Pages Used to Report Time.....	1150
Common Elements Used in this Section.....	1150
Report Time - Timesheet Summary Page.....	1151
Timesheet Page.....	1154
Mass Time - Select Time Reporters Page.....	1156
Managing Time.....	1158
Pages Used to Manage Time.....	1158
Payable Time Summary Page.....	1159
Payable Time Detail Page.....	1160
Forecasted Time Summary Page.....	1161
Compensatory Time - Select Employee Page.....	1162
Compensatory Time Page.....	1163
Leave and Compensatory Time Page.....	1165
Leave and Compensatory Time Detail Page.....	1166
Accumulators Page.....	1167
Using Manager Time Calendar Views.....	1167
Pages Used to View Manager Time Calendars.....	1168
Understanding Manager Time Calendars.....	1168

Common Elements Used in This Section.....	1170
View Criteria Page.....	1171
Daily Time Calendar Page.....	1173
Weekly and Monthly Time Calendar Pages.....	1176
Managing Overtime Requests.....	1178
Pages Used to Manage Overtime Requests.....	1178
Understanding Overtime Request Transactions.....	1178
View Overtime Requests - Overtime Requests Page.....	1179
Overtime Request Details Page.....	1179
Overtime Balances Page.....	1180
Approve Overtime Requests - Select an Employee Request Page.....	1182
Approve Employee Overtime – Overtime Request Details Page.....	1185
<b>Chapter 30: Using Manager Self-Service for Scheduling Components.....</b>	<b>1189</b>
Understanding Manager Self-Service for Scheduling Components.....	1189
Setting Up Manager Search Options.....	1189
Page Used to Set Up Manager Search Options.....	1190
Manager Search Options - Select Default Criteria and Options Page.....	1190
Assigning Schedules.....	1192
Pages Used to Assign Schedules.....	1193
Assign Work Schedule Page.....	1193
Personal Schedule Definition Page.....	1196
Schedule Shifts Page.....	1198
Schedule Calendar Page.....	1198
Schedule Calendar Rotations Page.....	1200
Managing Schedules.....	1201
Pages Used to Manage Schedules.....	1201
Common Elements Used in This Section.....	1202
Manage Schedules Options Page.....	1202
Manage Schedule Options Page.....	1204
Schedule Detail Page.....	1208
Schedule Replacements Page.....	1212
Copy Schedules Page.....	1214
Swap Schedules Page.....	1214
Integrating Training Data from Learning Management.....	1215
Learning Management.....	1215
<b>Chapter 31: Using the Time and Labor WorkCenter.....</b>	<b>1217</b>
Understanding Workcenters.....	1217
WorkCenters.....	1217
Example: Time and Labor WorkCenter.....	1218
Common Terms Used with the PeopleSoft WorkCenter.....	1219
Pagelets and Pagelet Setup, Maintenance, and Personalization.....	1219
Using the Time and Labor WorkCenter.....	1220
Time and Labor.....	1221
Accessing the Time and Labor WorkCenter.....	1221
Understanding the Tabs in the Pagelet Area of the Time and Labor WorkCenter.....	1222
Understanding the Transaction Area of the Time and Labor WorkCenter.....	1226
Using Time and Labor WorkCenter Pivot Grids.....	1230
Understanding Time and Labor Pivot Grids.....	1230
Common Elements for Viewing Pivot Grids.....	1231
Pages Used to View Time and Labor Pivot Grids.....	1232
Timesheet by Status Pivot Grid Page.....	1234

Attendance Violations Pivot Grid Page.....	1235
Absence Type - Absence Mgmt Pivot Grid Page.....	1237
Absence Types - Benefits Pivot Grid Page.....	1239
Payable Time Trend Page.....	1241
Time Categories Comparison Page.....	1244
Labor Costs Page.....	1246
Payable Time by Status Page.....	1249
Managing the Time and Labor WorkCenter.....	1250
Understanding the Tab Application Framework.....	1250
Pages Used to Manage the Time and Labor WorkCenter.....	1251
Configure Tab Page.....	1251
Configure Tab Page Page.....	1252
Manage Tab Application Page.....	1253
Configure Tab Application Page.....	1254
<b>Chapter 32: Using Time and Labor Dashboard.....</b>	<b>1257</b>
Understanding Time and Labor Dashboard.....	1257
Time and Labor Dashboard.....	1257
Common Elements Used with Time and Labor Dashboard.....	1257
Working with Time and Labor Dashboard.....	1258
Viewing the Time and Labour Dashboard pagelets.....	1261
<b>Chapter 33: Exceptions and Validations.....</b>	<b>1267</b>
Understanding Exceptions and Validations.....	1267
Timesheets and Online Validations.....	1282
Weekly Punch Time Reporting Validations.....	1285
Time and Task Reporting Template Validations.....	1285
<b>Chapter 34: TCD Interface.....</b>	<b>1287</b>
Understanding the TCD Interface.....	1287
Input Data Sent to TCD Systems.....	1287
Output Data Produced by TCD Systems.....	1298
Objects Received by the TCD.....	1310
Objects Sent from the TCD.....	1318
Configuration of the Integration Broker and the TCD.....	1327
Outgoing Service Operations From PeopleSoft to TCD Server.....	1327
Routing Rules.....	1329
Service Operations Monitor.....	1329
Incoming Service Operations from the TCD Server to the PeopleSoft Server.....	1329
System and Integration Broker Configuration.....	1331
Node and Gateway Configuration.....	1331
Enterprise Components Configuration.....	1335
Error Handling and Resolution.....	1338
Frequently Asked Questions.....	1340
<b>Chapter 35: Referential Integrity.....</b>	<b>1343</b>
Background Processing.....	1343
Time Administration and Referential Integrity.....	1348
Time Reporting Codes and Referential Integrity.....	1349
Task Reporting and Referential Integrity.....	1351
Prevention of Inactivation or Deletion of Effective-Dated Rows.....	1351
Execute Edit Error Checking.....	1352
Nested Effective Dates.....	1352
Time Administration and Referential Integrity Triggers.....	1352
Understanding the TCD Interface and Referential Integrity.....	1356

Prevention of Inactivation or Deletion of Effective-Dated Rows..... 1356

Execute Edit Error Checking..... 1356

Nested Effective Dates..... 1357

**Chapter 36: Delivered Workflow for Time and Labor.....1359**

Delivered Workflow for Time and Labor..... 1359

Overtime Request..... 1359

**Chapter 37: Time and Labor Reports.....1361**

Time and Labor Reports: A to Z..... 1361



# Preface

---

## Understanding the PeopleSoft Online Help and PeopleBooks

The PeopleSoft Online Help is a website that enables you to view all help content for PeopleSoft applications and PeopleTools. The help provides standard navigation and full-text searching, as well as context-sensitive online help for PeopleSoft users.

### Hosted PeopleSoft Online Help

You can access the hosted PeopleSoft Online Help on the [Oracle Help Center](#). The hosted PeopleSoft Online Help is updated on a regular schedule, ensuring that you have access to the most current documentation. This reduces the need to view separate documentation posts for application maintenance on My Oracle Support. The hosted PeopleSoft Online Help is available in English only.

To configure the context-sensitive help for your PeopleSoft applications to use the Oracle Help Center, see [Configuring Context-Sensitive Help Using the Hosted Online Help Website](#).

### Locally Installed PeopleSoft Online Help

If you're setting up an on-premises PeopleSoft environment, and your organization has firewall restrictions that prevent you from using the hosted PeopleSoft Online Help, you can install the online help locally. Installable PeopleSoft Online Help is made available with selected PeopleSoft Update Images and with PeopleTools releases for on-premises installations, through the [Oracle Software Delivery Cloud](#).

Your installation documentation includes a chapter with instructions for how to install the online help for your business environment, and the documentation zip file may contain a README.txt file with additional installation instructions. See *PeopleSoft 9.2 Application Installation* for your database platform, "Installing PeopleSoft Online Help."

To configure the context-sensitive help for your PeopleSoft applications to use a locally installed online help website, see [Configuring Context-Sensitive Help Using a Locally Installed Online Help Website](#).

### Downloadable PeopleBook PDF Files

You can access downloadable PDF versions of the help content in the traditional PeopleBook format on the [Oracle Help Center](#). The content in the PeopleBook PDFs is the same as the content in the PeopleSoft Online Help, but it has a different structure and it does not include the interactive navigation features that are available in the online help.

### Common Help Documentation

Common help documentation contains information that applies to multiple applications. The two main types of common help are:

- Application Fundamentals

- Using PeopleSoft Applications

Most product families provide a set of application fundamentals help topics that discuss essential information about the setup and design of your system. This information applies to many or all applications in the PeopleSoft product family. Whether you are implementing a single application, some combination of applications within the product family, or the entire product family, you should be familiar with the contents of the appropriate application fundamentals help. They provide the starting points for fundamental implementation tasks.

In addition, the *PeopleTools: Applications User's Guide* introduces you to the various elements of the PeopleSoft Pure Internet Architecture. It also explains how to use the navigational hierarchy, components, and pages to perform basic functions as you navigate through the system. While your application or implementation may differ, the topics in this user's guide provide general information about using PeopleSoft applications.

## Field and Control Definitions

PeopleSoft documentation includes definitions for most fields and controls that appear on application pages. These definitions describe how to use a field or control, where populated values come from, the effects of selecting certain values, and so on. If a field or control is not defined, then it either requires no additional explanation or is documented in a common elements section earlier in the documentation. For example, the Date field rarely requires additional explanation and may not be defined in the documentation for some pages.

## Typographical Conventions

The following table describes the typographical conventions that are used in the online help.

<b><i>Typographical Convention</i></b>	<b><i>Description</i></b>
<b>Key+Key</b>	Indicates a key combination action. For example, a plus sign (+) between keys means that you must hold down the first key while you press the second key. For <b>Alt+W</b> , hold down the <b>Alt</b> key while you press the <b>W</b> key.
... (ellipses)	Indicate that the preceding item or series can be repeated any number of times in PeopleCode syntax.
{ } (curly braces)	Indicate a choice between two options in PeopleCode syntax. Options are separated by a pipe ( ).
[ ] (square brackets)	Indicate optional items in PeopleCode syntax.
& (ampersand)	When placed before a parameter in PeopleCode syntax, an ampersand indicates that the parameter is an already instantiated object.  Ampersands also precede all PeopleCode variables.



<b><i>Typographical Convention</i></b>	<b><i>Description</i></b>
⇒	This continuation character has been inserted at the end of a line of code that has been wrapped at the page margin. The code should be viewed or entered as a single, continuous line of code without the continuation character.

## ISO Country and Currency Codes

PeopleSoft Online Help topics use International Organization for Standardization (ISO) country and currency codes to identify country-specific information and monetary amounts.

ISO country codes may appear as country identifiers, and ISO currency codes may appear as currency identifiers in your PeopleSoft documentation. Reference to an ISO country code in your documentation does not imply that your application includes every ISO country code. The following example is a country-specific heading: "(FRA) Hiring an Employee."

The PeopleSoft Currency Code table (CURRENCY\_CD\_TBL) contains sample currency code data. The Currency Code table is based on ISO Standard 4217, "Codes for the representation of currencies," and also relies on ISO country codes in the Country table (COUNTRY\_TBL). The navigation to the pages where you maintain currency code and country information depends on which PeopleSoft applications you are using. To access the pages for maintaining the Currency Code and Country tables, consult the online help for your applications for more information.

## Region and Industry Identifiers

Information that applies only to a specific region or industry is preceded by a standard identifier in parentheses. This identifier typically appears at the beginning of a section heading, but it may also appear at the beginning of a note or other text.

Example of a region-specific heading: "(Latin America) Setting Up Depreciation"

### Region Identifiers

Regions are identified by the region name. The following region identifiers may appear in the PeopleSoft Online Help:

- Asia Pacific
- Europe
- Latin America
- North America

### Industry Identifiers

Industries are identified by the industry name or by an abbreviation for that industry. The following industry identifiers may appear in the PeopleSoft Online Help:

- USF (U.S. Federal)

- E&G (Education and Government)

## Translations and Embedded Help

PeopleSoft 9.2 software applications include translated embedded help. With the 9.2 release, PeopleSoft aligns with the other Oracle applications by focusing our translation efforts on embedded help. We are not planning to translate our traditional online help and PeopleBooks documentation. Instead we offer very direct translated help at crucial spots within our application through our embedded help widgets. Additionally, we have a one-to-one mapping of application and help translations, meaning that the software and embedded help translation footprint is identical—something we were never able to accomplish in the past.

---

## Using and Managing the PeopleSoft Online Help

Select About This Help in the left navigation panel on any page in the PeopleSoft Online Help to see information on the following topics:

- Using the PeopleSoft Online Help.
- Managing hosted Online Help.
- Managing locally installed PeopleSoft Online Help.

---

## PeopleSoft HCM Related Links

[Oracle Help Center](#)

[PeopleSoft Online Help Home](#)

[PeopleSoft Information Portal](#)

[My Oracle Support](#)

[PeopleSoft Training from Oracle University](#)

[PeopleSoft Video Feature Overviews on YouTube](#)

[PeopleSoft Business Process Maps \(Microsoft Visio format\)](#)

[HCM Abbreviations](#)

[PeopleSoft Spotlight Series](#)

---

## Contact Us

Send your suggestions to [pssoft-infodev\\_us@oracle.com](mailto:pssoft-infodev_us@oracle.com).

Please include the applications update image or PeopleTools release that you're using.

---

## Follow Us

<i>Icon</i>	<i>Link</i>
	<a href="#"><u>Watch PeopleSoft on YouTube</u></a>
	<a href="#"><u>Follow @PeopleSoft_Info on X.</u></a>
	<a href="#"><u>Read PeopleSoft Blogs</u></a>
	<a href="#"><u>Connect with PeopleSoft on LinkedIn</u></a>



## Chapter 1

# Getting Started with Time and Labor

---

## Time and Labor Overview

Time and Labor facilitates the management, planning, reporting, and approving of time, and calendar and schedule creation and usage, from one global web-based application.

With this application, you can:

- Schedule time.
- Report time.
- Administer time.
- Distribute time.

---

## Time and Labor Business Processes

Time and Labor provides these business processes:

- Report time.
- Create schedules.
- Organize employee groups.
- Approve time.
- Track compensatory time off.
- Manage security.
- Manage reported time.
- Track task data.
- Forecast payable time.
- Manage exceptions.
- Track attendance.
- Process payable time.
- Create rules for processing time.

- Distribute and dilute labor costs.

We discuss these business processes in the business process sections of this topic.

## Time and Labor Integrations

Time and Labor integrates with these PeopleSoft applications:

This example illustrates the integration between PeopleSoft Time and Labor and other PeopleSoft applications.

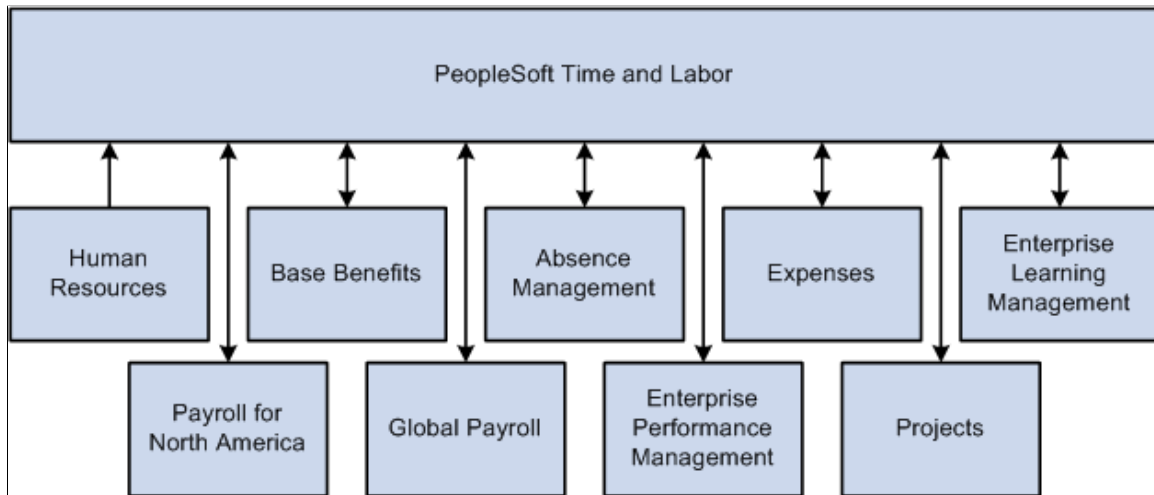

### Payroll for North America and Global Payroll

Time and Labor shares payable time information with payroll applications, such as Payroll for North America and Global Payroll.

### Absence Management

Time and Labor and Absence Management integration comprises a number of features that enable users to add, change, or delete absence events in any component that updates the Absence Event Table and to have that information display, in real time, on either the Timesheet page in Time and Labor or the Self Service Absence pages in Absence Management and Global Payroll.

These features are based on the assumption that customers have one of the following installed application combinations and that the employee is enrolled in Time and Labor:

- Absence Management, Payroll for North America (PNA), and Time and Labor, or
- Global Payroll and Time and Labor

This integration ensures that reported time in Time and Labor reflects the most up-to-date absence event information and that payable time in Time and Labor reflects the correct cost.

### Time Collection Devices

Time and Labor is designed for various types of time collection or capture devices.

## Human Resources

PeopleSoft Human Resources provides information for Time and Labor.

## PeopleSoft Performance Management

Integration between Time and Labor and the PeopleSoft Performance Management application enables data to be captured in a data warehouse, so that performance can be measured in a variety of ways.

## PeopleSoft Benefits

PeopleSoft Benefits information, such as benefit and leave plans, is used by Time and Labor.

## PeopleSoft Project Costing and Expenses

The payroll application compensates time reporters for their payable time and, at the end of the pay run, sends labor-related costs back to Time and Labor, where they are distributed across payable time and made available to the Project Costing and Expenses applications.

## Time and Labor Implementation

PeopleSoft Setup Manager enables you to generate a list of setup tasks for your organization based on the features that you are implementing. The setup tasks include the components that you must set up, listed in the order in which you must enter data into the component tables, and links to the corresponding PeopleBook documentation.

Time and Labor also provides component interfaces to help you load data from your existing system into PeopleSoft Strategic Sourcing tables. Use the Excel to Component Interface utility with the component interfaces to populate the tables.

This table lists all of the components that have component interfaces:

<b>Component</b>	<b>Component Interface</b>	<b>Reference</b>
SCH_SHIFT	SCH_SHIFT	See <a href="#">Shift Page</a> .
SCH_WRKDAY	SCH_WRKDAY	See <a href="#">Workday Page</a> .
TL_DYNAM_GRP	TL_DYNAM_GRP	See <a href="#">Creating and Updating Dynamic Groups</a> .
TL_TRCPGM_PNLGRP	TL_TRCPGM_PNLGRP	See <a href="#">Defining TRC Programs</a> .
TL_TRC_MAIN_PNLGRP	TL_TRC_MAIN_PNLGRP	See <a href="#">Defining TRC Programs</a> .
ACTIVITY_ID	ACTIVITY_ID	See <a href="#">Manage TL Activity Codes Page</a> .

<b>Component</b>	<b>Component Interface</b>	<b>Reference</b>
CUSTOMER	CUSTOMER	See <a href="#">Defining and Viewing Task Values in Time and Labor</a> .
PRODUCT1	PRODUCT1	See <a href="#">Understanding How to Create Task Values in Time and Labor</a> .
PROJECT1	PROJECT1	See <a href="#">Understanding How to Create Task Values in Time and Labor</a> .
TASK	TASK	See <a href="#">Understanding How to Create Task Values in Time and Labor</a> .
TASKGROUP	TASKGROUP	See <a href="#">Defining Taskgroups</a> .
TL_TSKPRF_TEMPLATE	TL_TSKPRF_TEMPLATE	See <a href="#">Creating Task Profiles</a> .
TL_TASK_PROFILE	TL_TASK_PROFILE	See <a href="#">Creating Task Profiles</a> .
TL_WKG_MAIN_PNLGRP	TL_WKG_MAIN_PNLGRP	See <a href="#">Creating Work Schedules and Schedule Definitions</a> .
TL_RULE_ELEM1_PNLG	TL_RULE_ELEM1_PNLG	See <a href="#">Defining Rule Elements</a> .
TL_RULE_ELEM2_PNLG	TL_RULE_ELEM2_PNLG	See <a href="#">Defining Rule Elements</a> .
TL_RULE_ELEM3_PNLG	TL_RULE_ELEM3_PNLG	See <a href="#">Defining Rule Elements</a> .
TL_RULE_ELEM4_PNLG	TL_RULE_ELEM4_PNLG	See <a href="#">Defining Rule Elements</a> .
TL_RULE_ELEM5_PNLG	TL_RULE_ELEM5_PNLG	See <a href="#">Defining Rule Elements</a> .
TL_USER_FLD1_PNLG	TL_USER_FLD1_PNLG	See <a href="#">User Field 1–5 Pages</a> .
TL_USER_FLD2_PNLG	TL_USER_FLD2_PNLG	See <a href="#">User Field 1–5 Pages</a> .
TL_USER_FLD3_PNLG	TL_USER_FLD3_PNLG	See <a href="#">User Field 1–5 Pages</a> .
TL_USER_FLD4_PNLG	TL_USER_FLD4_PNLG	See <a href="#">User Field 1–5 Pages</a> .
TL_USER_FLD5_PNLG	TL_USER_FLD5_PNLG	See <a href="#">User Field 1–5 Pages</a> .



<b>Component</b>	<b>Component Interface</b>	<b>Reference</b>
TL_TCDGRP_PNLGRP	TL_TCDGRP_PNLGRP	See <a href="#">Defining TCD Setup Data in Time and Labor</a> .
TL_TCD_PNLGRP	TL_TCD_PNLGRP	See <a href="#">TCD Group Page</a> .

Refer to the *PeopleSoft HCM 9.2 - Reorganization of Component Interface Permissions* (Doc ID [2342162.1](#)) MOS posting for a list of system-delivered CIs and their usage, the mapping of CIs and associated permission lists, and the mapping of CI permission lists and user roles.

## Other Sources of Information

In the planning phase of your implementation, take advantage of all PeopleSoft sources of information, including the installation guides, data models, business process maps, and troubleshooting guidelines.

See the product documentation for *PeopleTools: PeopleSoft Component Interfaces* and *PeopleTools: PeopleSoft Setup Manager*.

## Related Links

“PeopleSoft HCM Overview” (Application Fundamentals)



## Chapter 2

# Navigating in Time and Labor

---

## Navigating in Time and Labor

Time and Labor provides custom navigation pages that contain groupings of folders that support a specific business process, task, or user role.

---

**Note:** In addition to the Time and Labor custom navigation pages, the PeopleSoft system provides menu navigation, standard navigation pages, and PeopleSoft Navigator.

---

For more information, see *PeopleTools: PeopleSoft Applications User's Guide*

---

## Pages Used to Navigate in Time and Labor

This table lists the custom navigation pages that are used to navigate in Time and Labor:

<b>Page Name</b>	<b>Navigation</b>	<b>Usage</b>
Time and Labor Set Up Center	Main Menu, Time and Labor, Time and Labor Set Up Center	Define and maintain Time and Labor configuration, including Chartfields.
Installation Options	Click Installation Options on the Time and Labor Set Up Center page.	Define general system defaults and load dates into the system.
Time and Labor Set Up	Click Time and Labor Set Up on the Time and Labor Set Up Center page.	Access the Time Periods, Time Reporting, Rules and Workgroups, Task Elements, Configure Tasks, Schedules, Validation Criteria, Time Collection Devices, and Launch Pad Navigation Suites options.
Time and Labor Security	Click Time and Labor Security on the Time and Labor Set Up Center page.	Access the Group Creation Security, Dynamic Group, Refresh Dynamic Group, Static Group, and TL Permission List Security options.
Enroll Time Reporters	Click Enroll Time Reporters on the Time and Labor Set Up Center page	Maintain time reporter data, compensatory plans, and group schedule assignments.

<b>Page Name</b>	<b>Navigation</b>	<b>Usage</b>
Time Admin Setup and Tools	Click Time Admin Setup and Tools on the Time and Labor Set Up Center page	Access Time Admin utilities and tools to build custom rules, and analyze statistics and TCD errors.
Calendar View Options	Click Calendar View Options on the Time and Labor Set Up Center page	Define time event options for daily, weekly, and monthly time calendars.
Chartfield Set Up	Click Chartfield Set Up on the Time and Labor Set Up Center page	Define Chartfield information.

## Chapter 3

# Understanding Time and Labor

---

## Scheduling

There are three scheduling environments that an organization is likely to encounter – fixed, rotating and dynamic. In a fixed schedule environment, employees are assigned a work pattern on hire or on a change in role or situation. The planned work pattern is static and is changed only in special situations. In a rotating schedule environment, schedule rosters are established in advance and assigned to groups of employees on hire or when a new project or period begins. In a dynamic environment, an employee does not have a set schedule; a new schedule is established every period, and updates are made frequently based on a variety of factors.

In each environment, it is important for schedules to be created and maintained systematically to communicate work expectations, track adherence, and reconcile with actual work completed. Time and Labor provides capabilities to support each schedule environment.

For fixed schedule environments, a company may support centralized standard schedule definitions and ad hoc manager-specified work patterns. All schedule building blocks, including shifts, workdays, and schedule definitions, are optional. For example, an organization may want to establish only standard shifts and allow these to be assigned directly to employees.

For rotating schedule environments, a set of rotations, with relative start days, may be defined on a schedule. For example, Crew A may start its rotation on day one of the pattern and Crew B may start on day seven. Schedule patterns are not associated with specific dates until an employee is assigned to the pattern, allowing flexibility and reusability. The scheduler may choose a sample date, however, and view the resulting rotation pattern. Split shifts on one day, and off shifts that are greater or less than 24 hours can be created also. These features are particularly useful for organizations that operate on a 24-hour schedule and must rotate individuals between day shifts and night shifts.

Dynamic scheduling environments require frequent schedule changes and intelligent scheduling arrangements. Today, the schedule override capabilities are intended for infrequent ad hoc use. In Time and Labor, a generic interface to the open scheduling architecture loads optimized work schedules or data from other systems, including training data from PeopleSoft Learning Management. Managers have a graphical interface to view schedules for their employees. In addition to viewing coverage, assigned shifts, and total work hours, managers can identify individuals with planned absences or training. If updates need to be made to the schedule, managers can find replacements, swap shifts, copy schedules, and make short- and long-term schedule changes.

Employees can view their monthly schedule, including work and shift information, planned absences, holidays, and training.

### Related Links

[Understanding Work Schedules](#)

[Assigning Schedules to a Group](#)

[Understanding Manager Self-Service for Scheduling Components](#)

---

## Time Reporting Methods

There are a variety of ways in which time can be reported:

- Timesheet entry.

Both punch time and elapsed time are reported using the Timesheet page.

- Web clock.

Enables employees to enter a single punch and provide time and task detail when entering punches.

- Mass time.

Enables the employee or the manager to report time in several ways. They can report time according to their (or their employee's) schedule for a specified date or date range. They can also specify a lump sum amount to be distributed according to their schedule.

- Rapid time.

Use rapid reporting templates to design time entry pages for fast reporting.

- TCD interface.

The TCD Interface uses the PeopleSoft Publish and Subscribe communications methodology in PeopleTools to send and receive data from the TCD system. Data in Time and Labor and the TCD system are synchronized by either a full data replication or an incremental approach (changes only).

- Integration with PeopleSoft Absence Management.

Absence event data that is reported in Absence Management's self service page can be made available on Timesheet pages in Time and Labor, and vice versa.

See [Prerequisites for Enabling Absences on Timesheets](#).

### Related Links

[Timesheet Page](#)

[Using Mass Time](#)

[Understanding Rapid Time Reporting](#)

[Understanding TCDs](#)

---

## Time Administration

The foundation of Time and Labor is the Time Administration rules processing feature, which enables you to create rules for processing time. You can apply these rules online and as part of the Time Administration batch process.

Time administration provides these tools for creating rules:

- Templates for rule calculations.

- Actions and conditions for rules that are too complex to be defined within a template structure.
- SQL objects for complex rules.
- User exits for constructs that cannot be handled through templates or other tools.

### **Related Links**

[Understanding Time Administration](#)

---

## **Time Management Features**

Time management features include:

- Time management alerts.

The Time Management Alerts page displays occurrences of overtime limit reached, overtime approval required, payable time approval required, exceptions to review, or absence approval required if any occurrences exist and provides a link to a page for each type of occurrence.

- Workforce availability.

The Workforce Availability page displays a count of employees who are currently logged in, no shows for current shifts, scheduled for current shifts, reported absent for today, reported in training for today, and links to the daily and weekly manager calendar view pages.

- Time calendar views.

The time calendar view is all a manager needs to view reported time, scheduled time, payable time, exceptions and other information about an employee's time.

- Manage exceptions.

Exceptions are configurable for Time Reporting and the Time Administration process. The Time Administration process will reprocess pending time reporting exceptions and resolve exceptions, minimizing the need for manual intervention.

- Approve reported and payable time, adjust paid time, view payable time and view forecasted payable time.

### **Related Links**

[Understanding Manager Self-Service Components](#)

---

## **User Preferences**

The User Preferences page is used by employees to view and update their schedule and time related preferences, such as preferred shifts and times.

A manager self service version of this page allows managers to view the employees' schedule preferences, to be taken into account for future schedule creation and changes. The manager views only the schedule preferences of the employee; time reporting preferences are not viewable in manager self service.

**Related Links**

[Setting Up User Preferences](#)

## Configurable Manager Views

Managers can configure the **Default Search Options** page to select default criteria and options. Fields and field values can be selected to be used as search criteria, default values, or viewed in a list. This is used on the various manager self service pages to expediently select employees to view and update.

## Delivered Data Archive Templates

Data archiving is an important part of any data management system. Specific archiving dependencies exist for Time and Labor. Data should be archived in the following order of precedence:

1. Payable Time table
2. Payable Time Approval table
3. Reported Time table
4. Reported Time Approval table
5. Xref\_table
6. Xref\_Cost table

You use the same prompts to archive Payable Time and Reported Time.

The following video provides an overview of archiving payable time approval data:

Video: [Image Highlights, PeopleSoft HCM Update Image 29: Archive Payable Time Data Including Approvals](#)

<b>Base Table/Record Name</b>	<b>Archive Table/Record Name</b>	<b>Template Name</b>	<b>Input Parameter</b>	<b>Comments</b>
TL_PAYABLE_TIME	TL_PAYABLE_HST	TL_PYTM1 TL_PYTM2	Begin Date End Date	TL_PYTM1 – Archives processed Payable Time ('PD','CL','DL') TL_PYTM2 – Archives unprocessed Payable Time ('ES','NA','RP','IG')



<b>Base Table/Record Name</b>	<b>Archive Table/Record Name</b>	<b>Template Name</b>	<b>Input Parameter</b>	<b>Comments</b>
TL_PAYABLE_HIST	TL_PAYABLE_HIST	TL_PYTM1 TL_PYTM2	Begin Date End Date	
TL_RPTD_TIME	TL_RPT_TIME_HST	TL_RPDTM	No Parameter	Reported_Time table is archived based on the Payable Time rows that are archived.
TL_EXCEPTION	TL_EXCEPTN_HST	TL_EXCEP	Begin Date End Date	
TL_XREF_TBL	TL_XREF_TBL_HST	TL_XREF	No Parameter	Xref_Table is archived based on Payable Time rows that are archived.
TL_XREF_COST	TL_XREF_COST_HST	TL_XCOST	No Parameter	Xref_Cost is archived based on Xref_Table rows that are archived
TL_COMPLEAVE_TBL	TL_COMPLEAVE_HST	TL_COMP	Begin Date End Date	
TL_COMP_DAY_BAL	TL_COMP_DAY_HST	TL_CMPBA	Begin Date End Date	
TL_IPT1_CNT	TL_IPT1_CNT_HST	TL_PYTM1TL_PYTM2	Begin Date End Date	
TL_RULE_OVRD	TL_RULEOVRD_HST	TL_RLOVR	Begin Date End Date	
AUDIT_TLRPTTIME	AUDIT_TLRPT_HST	TLR_AUDT	Begin Date End Date	
SCH_MNG_SCHTBL	SCH_MNG_SCH_HST	SCH_MNG_SCH_HST	Begin Date End Date	
SCH_ADHOC_DTL	SCH_ADHODTL_HST	TL_SCADH	Begin Date End Date	

<b>Base Table/Record Name</b>	<b>Archive Table/Record Name</b>	<b>Template Name</b>	<b>Input Parameter</b>	<b>Comments</b>
SCH_EXT_DTL	SCH_EXT_DTL_HST	TL_SCXDT	Begin Date End Date	
TL_FRCS_PYBL_TM	TL_FRCSPYBL_HST	TL_FRCPA	Begin Date End Date	
TL_OT_DATA	TL_OT_DATA_HST	TL_OTDAT	Begin Date End Date	
TL_OT_STATUS	TL_OTSTATUS_HST	TL_OTDAT	Begin Date End Date	
TL_TR_COMMENTS	TL_COMMENTS_HST	TL_COMMT	Begin Date End Date	

### Archiving Payable Time Approvals

The archive Template TLPYAPPR is available for archiving Payable time approval related tables. For a list of tables that are archived as part of this template, refer the below table.

This example illustrates the fields and controls on the Manage Archive Templates page for Payable Time approval tables.

### Manage Archive Templates

Archive Template: TLPYAPPR      Description:

**Archive Template Objects** Find | View All | First 1-4 of 4 Last

Base Object	*Archive Object	Description	Link Record		
<input type="checkbox"/>	<input type="text" value="EO_SUMM"/>	EO Summary tables	<input type="text" value="TL_APP_PAY_XRF"/>	<input type="button" value="+"/>	<input type="button" value="-"/>
<input type="checkbox"/>	<input type="text" value="TL_PAY_HDR_APPR"/>	Payable Time Header Approvals	<input type="text" value="TL_APP_PAY_XRF"/>	<input type="button" value="+"/>	<input type="button" value="-"/>
<input type="checkbox"/>	<input type="text" value="TL_PAY_LINE_APPR"/>	Payable Time Line Approvals	<input type="text" value="TL_APP_PAY_XRF"/>	<input type="button" value="+"/>	<input type="button" value="-"/>
<input checked="" type="checkbox"/>	<input type="text" value="TL_PAY_TIME_EOA"/>	TL payable time EO tables		<input type="button" value="+"/>	<input type="button" value="-"/>

**Selective Archiving Queries** Find | View All | First 1 of 1 Last

*Query Name	Description		
<input type="text" value="TL_PAY_APPR_ARCHIVE_QRY"/>	Payable Time Archival Query	<input type="button" value="+"/>	<input type="button" value="-"/>

Template Allows Selective Restoring of Data From History

**Selective Restoring Queries** Find | View All | First 1 of 1 Last

*Query Name	Description		

**AE Processes** Find | View All | First 1-4 of 4 Last

*Archive Process	Pre AE Program	Post AE Program		
<input type="text" value="Archive Delete"/>	<input type="text"/>	<input type="text" value="TL_ARCHIVE"/>	<input type="button" value="+"/>	<input type="button" value="-"/>
<input type="text" value="Remove from History"/>	<input type="text"/>	<input type="text" value="TL_ARCHIVE"/>	<input type="button" value="+"/>	<input type="button" value="-"/>
<input type="text" value="Archive Rollback"/>	<input type="text"/>	<input type="text" value="TL_ARCHIVE"/>	<input type="button" value="+"/>	<input type="button" value="-"/>
<input type="text" value="Archive Selection"/>	<input type="text"/>	<input type="text" value="TL_ARCHIVE"/>	<input type="button" value="+"/>	<input type="button" value="-"/>

<b>Term</b>	<b>Definition</b>
<b>Archive Template Objects</b>	Insert from the list of archive objects previously defined in the database.
<b>Selective Archiving Queries</b>	TL_PAY_APPR_ARCHIVE_QRY is configured with this template as selective archiving query. This query fetches data from PS_TL_APP_PAY_XRF as a base table for archiving data related to approval tables for payable time. The query has two bind parameters <b>Begin Date</b> and <b>End Date</b> which are used to fetch data.
<b>AE Processes</b>	<p>The <b>Post AE Program</b> TL_ARCHIVE application engine process archives the following tables (PSWORKLIST, EOAW_WL, HCSC_AWE_TXNLOG, EOAW_USER_ESCAL and EOAW_USERINS) as part of this template.</p> <p>You can define different Application Engine (AE) programs to run for each of the archiving processes.</p>

Copyright © 1988, 2024, Oracle and/or its affiliates.

43

**Note:** This is a delivered template for archiving payable time approval related tables. If you are adding custom AE, then the logic to populate the aforesaid tables needs to be taken care of.

<b>Base Table/Record Name</b>	<b>Archive Table/Record Name</b>	<b>Archive Object</b>	<b>Comments</b>
TL_APP_PAY_XRF	TL_APP_PYXR_HST	TL_PAY_TIME_EOAPPR	Payable time XRF table and related EO tables are archived based on the rows from TL_APP_PAY_XRF for the given dates specified as input parameters.
EOAW_COMMENTS	EOAW_COMM_HST		
EOAW_HIS_COMM	EOAW_HISCOM_HST		
EOAW_TO_LOG	EOAW_TO_LG_HST		
HCSC_USTEP_ATRB	HCSC_USTPAT_HST		
EOAW_STEPINST	EOAW_STPIST_HST		
TL_APP_PAY_LINE	TL_APP_PYLN_HST	TL_PAY_LINE_APPR	Payable time Line level table is archived based on the rows from TL_APP_PAY_XRF for the given dates specified as input parameters.
TL_APP_PAY_HDR	TL_APP_PYHD_HST	TL_PAY_HDR_APPR	Payable time header level table is archived based on the rows from TL_APP_PAY_XRF for the given dates specified as input parameters.
EOAW_SUMMARY	EOAW_SUMMRY_HST	EO_SUMM	EO Summary and detail tables are archived.
EOAW_SUMM_DTL	EOAW_SUMDTL_HST		
PSWORKLIST	HCSC_WRKLIST_HST		These tables are archived using the post process AE based on the data archived in TL_APP_PYXR_HST.
EOAW_WL	EOAW_WL_HIST		
HCSC_AWE_TXNLOG	HCSC_AWETLG_HST		
EOAW_USER_ESCAL	EOAW_ESCAL_ARC		

<b>Base Table/Record Name</b>	<b>Archive Table/Record Name</b>	<b>Archive Object</b>	<b>Comments</b>
EOAW_USERINST	EOAW_USRIST_HST		

For more information, See “Using PeopleSoft Data Archive Manager” in PeopleTools: Data Management product documentation.

## Archiving Reported Time Approvals

The archive Template TLRPAPPR is available for archiving Reported time approval-related tables. The tables that are archived as part of this template, are listed below.

<b>Base Table/Record Name</b>	<b>Archive Table/Record Name</b>	<b>Archive Object</b>	<b>Comments</b>
TL_APP_RPTD_XRF	TL_APP_RPXR_HST	TL_RPT_TIME_EOAPPR	<b>Reported time XRF table and related EO tables are archived based on the rows from TL_APP_RPTD_XRF for the given dates specified as input parameters.</b>
EOAW_COMMENTS	EOAW_COMM_HST		
EOAW_HIS_COMM	EOAW_HISCOM_HST		
EOAW_TO_LOG	EOAW_TO_LG_HST		
HCSC_USTEP_ATRB	HCSC_USTPAT_HST		
EOAW_STEPINST	EOAW_STPIST_HST		
TL_APP_RPT_LINE	TL_APP_RPLN_HST	TL_APP_RPT_LINE_APPR	Reported time Line level table is archived based on the rows from TL_APP_RPTD_XRF for the given dates specified as input parameters.
TL_APP_HDR	TL_APP_HDR_HST	TL_RPT_HDR_APPR	Reported time header level table is archived based on the rows from TL_APP_RPTD_XRF for the given dates specified as input parameters
EOAW_SUMMARY	EOAW_SUMMRY_HST	EO_SUMM	EO Summary and detail tables are archived.
EOAW_SUMM_DTL	EOAW_SUMDTL_HST		

<b>Base Table/Record Name</b>	<b>Archive Table/Record Name</b>	<b>Archive Object</b>	<b>Comments</b>
PSWORKLIST	HCSC_WRKLST_HST		These tables are archived using the post process AE based on the data archived in TL_APP_RPTD_XRF.
EOAW_WL	EOAW_WL_HIST		
HCSC_AWE_TXNLOG	HCSC_AWETLG_HST		
EOAW_USER_ESCAL	EOAW_ESCAL_ARC		
EOAW_USERINST	EOAW_USRIST_HST		

This example illustrates the fields and controls on the Manage Archive Templates page for Reported Time Approval archive. You can find definitions for the fields and controls later on this page.

### Manage Archive Templates

Archive Template: TLRPAPPR      Description:

#### Archive Template Objects

Find | View All | |      First 1-4 of 4 Last

Base Object	*Archive Object	Description	Link Record		
<input type="checkbox"/>	<input type="text" value="EO_SUMM"/>	EO Summary tables	<input type="text" value="TL_APP_RPTD_XRF"/>	<input type="button" value="+"/>	<input type="button" value="-"/>
<input type="checkbox"/>	<input type="text" value="TL_APP_RPT_LINE_"/>	Reported Line Line approvals	<input type="text" value="TL_APP_RPTD_XRF"/>	<input type="button" value="+"/>	<input type="button" value="-"/>
<input type="checkbox"/>	<input type="text" value="TL_RPT_HDR_APPF"/>	Reported Time Header Approvals	<input type="text" value="TL_APP_RPTD_XRF"/>	<input type="button" value="+"/>	<input type="button" value="-"/>
<input checked="" type="checkbox"/>	<input type="text" value="TL_RPT_TIME_EOA"/>	TL Reported time EO tables		<input type="button" value="+"/>	<input type="button" value="-"/>

#### Selective Archiving Queries

Find | View All | |      First 1 of 1 Last

*Query Name	Description		
<input type="text" value="TL_RPT_APPR_ARCHIVE_QRY"/>	Reported Time Appr Archival	<input type="button" value="+"/>	<input type="button" value="-"/>

Template Allows Selective Restoring of Data From History

#### Selective Restoring Queries

Find | View All | |      First 1 of 1 Last

*Query Name	Description		

#### AE Processes

Find | View All | |      First 1-4 of 4 Last

*Archive Process	Pre AE Program	Post AE Program		
<input type="text" value="Archive Delete"/>	<input type="text" value=""/>	<input type="text" value="TL_ARCHIVE"/>	<input type="button" value="+"/>	<input type="button" value="-"/>
<input type="text" value="Remove from History"/>	<input type="text" value=""/>	<input type="text" value="TL_ARCHIVE"/>	<input type="button" value="+"/>	<input type="button" value="-"/>
<input type="text" value="Archive Rollback"/>	<input type="text" value=""/>	<input type="text" value="TL_ARCHIVE"/>	<input type="button" value="+"/>	<input type="button" value="-"/>
<input type="text" value="Archive Selection"/>	<input type="text" value=""/>	<input type="text" value="TL_ARCHIVE"/>	<input type="button" value="+"/>	<input type="button" value="-"/>

<b>Term</b>	<b>Definition</b>
<b>Archive Template Objects</b>	The archive objects related to reported time approval is configured here.
<b>Selective Archiving Queries</b>	TL_RPT_APPR_ARCHIVE_QRY is configured with this template as selective archiving query. This query fetches data from PS_TL_APP_RPTD_XRF as a base table for archiving data related to approval tables for reported time. The query has two bind parameters <b>Begin Date</b> and <b>End Date</b> which are used to fetch data.
<b>AE Processes</b>	<p>The <b>Post AE Program</b> TL_ARCHIVE application engine process archives the following tables (PSWORKLIST, EOAW_WL, HCSC_AWE_TXNLOG, EOAW_USER_ESCAL and EOAW_USERINS) as part of this template.</p> <p>You can define different Application Engine (AE) programs to run for each of the archiving processes.</p>





## Chapter 4

# Setting Up Basic Tables

---

## Understanding Time and Labor Implementation

To implement Time and Labor, you must set up the following tables, processes, and features:

- Human Resource tables.
- Benefits tables.
- Time Zone Offsets table.
- Concurrent online processing.
- Time periods.
- Periods and period instances.
- Overtime limits.
- Calendars.
- Manager time calendar views.
- Compensatory time plans.
- Exceptions.
- PeopleSoft Application Engine sections.
- Validation criteria.

This example illustrates the tables and pages required to implement PeopleSoft Time and Labor

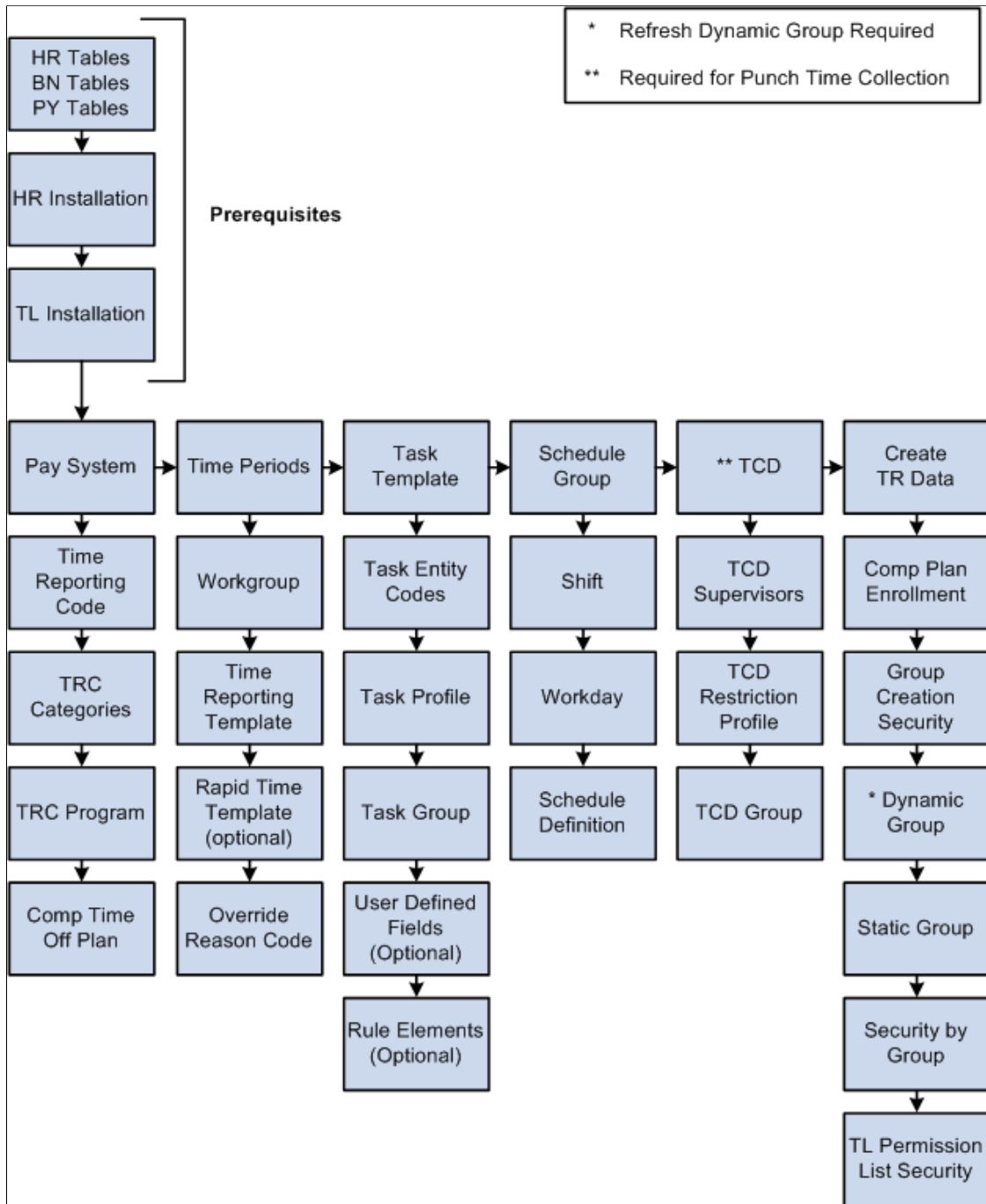

## Human Resource Tables

The Time and Labor system uses Human Resources Management (HR) tables to extract all the basic information about your company that will be used during Time and Labor processing. You must set up these tables before you establish any other tables in the system. HR tables and data used by Time and Labor include the Company, Location, Department, Compensation Rate, Job Code, and Pay Group tables.

The following table shows how Time and Labor uses data extracted from Human Resources.

<b>Term</b>	<b>Definition</b>
<b>Business Units</b>	Used for task reporting in Time and Labor and to resolve SetID for other fields.
<b>SetIDs</b>	Used to resolve values for reporting on job code, location, and department by using the business unit.
<b>Company</b>	Used for task reporting in Time and Labor.
<b>Location</b>	Used for task reporting in Time and Labor.
<b>Department</b>	Used for task reporting in Time and Labor.
<b>Job Code</b>	Used for task reporting in Time and Labor.
<b>Pay Group</b>	Used in distribution to define parameters for payment of payable time.
<b>Comp Rate Code Table</b>	Used for elapsed time reporting with time reporting codes (TRCs).
<b>Holiday Schedule</b>	Used for scheduling and rule processing.

## Related Links

- “Working with Business Units” (Application Fundamentals)
- “Working with TableSets” (Application Fundamentals)
- “Entering Company Information” (Application Fundamentals)
- “Establishing Locations” (Application Fundamentals)
- “Maintaining Departments” (Application Fundamentals)
- “Defining Job Subfunction and Job Function Codes” (Application Fundamentals)
- “Administer Compensation Overview” (PeopleSoft Human Resources Administer Compensation)
- “Setting Up and Assigning Work and Holiday Schedules” (PeopleSoft Human Resources Monitor Absence)

## Benefits Tables

Benefits tables store leave plans and accrual balances. Time and Labor uses benefits tables for determining leave accrual balances. These tables include the Benefits Plan and Leave Plan tables. Set up these tables, in the following order, before setting up your Time and Labor tables.

1. Define all benefit plans by plan type, with vendor and group information.
2. Define the accrual rules for that plan on the Leave Plan table.

## Leave Plan Table

To set up your leave plan, use the Leave Plan Table page. The Leave Plan table contains the service and accrual processing rules for a leave plan. The following steps must occur:

1. Selected Time and Labor on the Installation table.
2. If required by your organization, select the Allow Negative Balance check box on the Manual Accrual Processing section of the Leave Plan Table page.

The Max Negative Hours Allowed field becomes available.

3. Enter the number of negative hours you will allow for this plan in the Max Negative Hours Allowed field.

The Max Negative Hours Allowed field and the active association of time reporters to a leave plan is important for the Leave Validation processes within Time and Labor.

---

**Note:** Any changes you make to the Allow Negative Balance or the Max Negative Hours Allowed check boxes will trigger referential integrity processing to ensure that unpaid leave time is not invalidated. Similarly, any additions or changes you make to the plan type, coverage election, or benefit plan on the Leave Plan page will trigger referential integrity processing to ensure that unpaid leave time is not invalidated.

---

## Related Links

[Check Leave and Comp Time Balances](#)

## Time Zone Offsets Table

PeopleTools stores time/date information in only one time zone—the "Base Time Zone" you select at the time of installation. The base time zone may be set to the time zone of the company's headquarters, or perhaps to Greenwich Mean Time (GMT)—also known as UTC (Universal Coordinated Time).

When employees enter the hours they have worked in Time and Labor, they report time according to the local time zone and PeopleTools stores the information in the base time zone. The Time Administration process then converts the base time back to the local time for rules processing. To do this, it needs to know the time zone "offsets," or the differences between the local time and base time.

Two circumstances can occur when punch time is reported across a daylight saving boundary. These relate to either the transition to or from daylight saving. When transitioning to daylight saving, clocks are advanced by a fixed amount at a fixed time. Transitioning back from daylight saving clocks are put back by a fixed amount at a fixed time.

Let's look at an example:

- For the transition from daylight saving at 2:00AM, the clocks will be put back one hour. This means that an employee starting work at 11:00PM the previous day and finishing at 7:00AM on the day that daylight saving occurred, will have really worked for an elapsed period of 9 hours, not the 8 hours indicated by the clock times.
- For the transition to daylight saving at 2:00AM, the clocks will be put forward one hour. This means that an employee starting work at 11:00PM the previous day and finishing at 7:00AM on the day that

daylight saving occurred, will have really worked for an elapsed period of 7 hours, not the 8 hours indicated by the clock times.

The following procedure explains how to select the base time zone and create time zone offsets.

To select the base time zone and create time zone offsets:

1. Select the base time zone on the PeopleTools Options page.

In the Base Time Zone field, select the time zone for storing all reported time.

2. Change the default settings on the Time Zone Data page and Daylight Savings page, if applicable.

The Time Zone Data page and Daylight Savings page display the default time zone settings delivered with PeopleTools. You can change the settings on these pages if you need to customize the information for your organization.

3. Create time zone offsets using the Time Zone Data page.

Click the Generate Query Offsets button on the Time Zone Data page to populate the time zone offsets table with values that represent the differences between the local and base time zones.

## Concurrent Batch Processing

Using PeopleTools, you can control the number of batch application engine processes—such as the Time Administration batch process—that can run concurrently.

To increase the number of concurrent batch processes, use the Process Scheduler's Server Definition page to update the Max Concurrent field for Application Engine. (Navigation: PeopleTools, Process Scheduler, Servers.) You may also need to update the MAX API Aware field. The PeopleTools PeopleBook provides instructions for updating these fields.

See the product documentation for *PeopleTools PeopleSoft Process Scheduler*

## Concurrent Online Processing

In addition to the Time Administration process, which runs in batch mode, Time and Labor includes the following online processes that are invoked from PeopleCode with the Call AppEngine function:

<b>Online Process</b>	<b>Page and Button or Field That Invokes Application Engine Processing</b>
Apply Online Rules	Timesheet page; Apply Rules button
Submit Time	Rapid Time page; Submit button
Resolve Exceptions	Manage Exceptions; Clean Up Exceptions button
Load Dates	Time and Labor Installation – Configurations page; Load Dates button

<b>Online Process</b>	<b>Page and Button or Field That Invokes Application Engine Processing</b>
Comp Plan Assignment Update	Create Time Reporter Data; Workgroup field change Maintain Time Reporter Data; Workgroup field change Workgroup Page, Comp Time Plan change
Forecast Payable Time	Time and Labor Launch Pad; Forecast Payable Time button

Multiple users can run online processes concurrently. The maximum number of concurrent processes depends on how many instances or images of the temporary tables are dedicated to online processing. Using the PeopleTools Options page (navigation: PeopleTools, Utilities, Administration, PeopleTools Options), you specify:

- The total number of instances you want the system to create for each temporary table (default = 3)
- The number of temporary table instances to create for online processes (default = 3)

---

**Note:** Application Engine programs are delivered to share temp tables; online processing requires dedicated temp tables.

---

When selecting the number of temporary table instances, keep in mind that a higher number increases the number of simultaneous users, but can also increase the consumption of disk space considerably.

### Example

Assume that you use the default settings for the temporary tables, as previously described. According to these settings, three users can run online processes concurrently. So what happens if five users launch online processes simultaneously? The system runs the processes for the first three users, and as soon as temporary tables dedicated to online processing become available, runs the fourth, and then fifth processes.

## Time Periods

You can define five types of periods in Time and Labor: daily, weekly, monthly, complex, and repeating. Although all period types are defined using the same set of pages, not all period types are used in the same way. For example, daily, weekly and monthly period types are used to create time reporting periods, but complex and repeating periods have no application to time reporting—their only purpose is to define periods for rules processing. This section discusses the different uses of periods in the system, and contains important information on when you can use each period type. Periods have the following uses in the Time and Labor system:

### Time Reporting

Define periods for time reporting purposes; for example, employees in your company might report time for a day, a week, or a month at a time. Align these time periods to your pay period, billing cycle, or fiscal period. Although you can define as many as five different types of periods using the Time Period pages, only three types of periods are for time reporting purposes: daily, weekly, and monthly. Two additional periods' types—complex and repeating—are for rules creation. These time periods can be associated on

the Maintain Time Reporter Data page, or the Workgroup page to derive the time period display on the Timesheet page.

## Determining Periods to Process

Time and Labor uses time periods, identified by the time period ID on each time reporter's workgroup, to help determine the correct time periods to process (and pass to Payable Time) when you run the Time Administration process. To determine the correct weekly periods to process, Time and Labor looks to the period ID associated with the time reporter's workgroup.

## Determining Rule Application

Time periods determine the range of dates to which a rule applies. For example, for a rule program containing a daily, weekly, and monthly rule, build a calendar containing the periods to which each of these rules applies. For each rule period (daily, weekly, and monthly), define the corresponding calendar period containing the data needed to process the rule.

When defining calendar periods to correspond to rule periods, use the same period types used in time reporting (daily, weekly, monthly). In addition, define repeating and complex period types to use in connection with complex and repeating rule periods. For example, consider the following complex rule that looks at time reported on the last Sunday in April.

*Example:* If a time reporter works on the last Sunday in April, the employee will automatically receive four hours plus the time he or she actually reports for the day.

For this rule to work, identify the last Sunday in April by creating a complex period. Otherwise, the system will not know which day to look at.

## Tracking Attendance

For attendance tracking in Time and Labor, specify the time periods for which to track absences, late punches, early departures, and so forth (for example, late punches in a day, absences per week). Use the three time-reporting period types for tracking attendance.

## Determining Overtime Limits

For evaluating overtime balances, specify the time periods to track if time reporters are exceeding the amount of overtime that can be taken within a given period. Use the three time-reporting period types for tracking overtime balances.

## Determining Current and Prior Period Time

Periods help the system distinguish between prior, current and future time (time entered for periods that have been processed as opposed to time for the current period). To determine whether time reporters are entering time for the current period or a prior one, the system looks at the current date for which time reporters report time and compares this date to the current period start and end dates on the time period calendar. The system first looks for a time period on the Maintain Time Reporter Data page for the time reporter and, if one is not defined there, uses the time period on the workgroup to distinguish current from prior period time.

## Related Links

[Establishing Time Periods](#)

Understanding Time Administration

Defining Attendance Programs

Understanding the Time Administration Process Flow

## Periods and Period Instances

All time period definitions include the period length (for example, you could define a weekly period to have a length of one week, two weeks, and so on) and the frequency of the time period. The definition of time and frequency is separate from the time period calendar to make reusing time periods easy and to provide maximum flexibility during setup.

To define a time period:

1. Define the different period types to use for time reporting, tracking attendance, or processing rules.

---

**Note:** Each time you create a time period using one of the time period pages described in this section, the system generates a time period ID. This ID uniquely identifies the time period.

---

<i>Begin Date</i>	<i>End Date</i>	<i>Frequency</i>
1 July	1 July	Daily
1 July	7 July	Weekly
1 July	30 July	Monthly
1 July	15 July	Semi-Monthly
1 July	31 September	Quarterly

2. Generate period instances.

Generate actual "instances" of period types on a calendar by running the Build Time Period Calendar Process. For example, a defined weekly period begins on Monday and ends on Sunday. This period doesn't exist in the system until instances of it are generated on a calendar. To create periods based on your period definition:

- a. Define the start and end dates of your calendar. (for example, 1 February 2000 to 1 February 2001).
- b. Specify the period types to include (daily, weekly, monthly, and so on).
- c. Generate actual periods by running the Build Time Period Calendar process.

3. Define additional components.



<b><i>Time Periods Used in the Definition of:</i></b>	<b><i>Where Used:</i></b>
Workgroups	If the period is a time reporting period, link the period, by its time period ID, to a workgroup on the Workgroup page. Or, enter a time reporting period for individual time reporters on the Maintain Time Reporter Data page. If you do so, this period ID overrides the reporting period associated with the time reporter's workgroup.
Rules	If the period is used to define a time segment for rules processing, link it, by its time period ID, to the rule on the Define Rule Header page.
Attendance Tracking	If the period is an attendance-tracking period, link it, by its time period ID, to the definition of the attendance program on the Attendance Program page.

## Related Links

[Establishing Time Periods](#)

[Building and Viewing Time Period Calendars](#)

## Planned Overtime Features

The basic overtime functionality of Time and Labor requires no special setup—employees can enter requests for overtime and managers can accept or deny requests. The following optional features require setup:

- Track overtime balances by period.
- Establish overtime limits that trigger a warning, when exceeded, on the manager's approval page.
- Base overtime limits on months of service.
- Enable workflow so that employees and managers are automatically notified when overtime requests are submitted, approved, or denied.

You assign overtime limits to workgroups, consequently, the same overtime limits apply to all employees in the same workgroup.

## Time Period Calendars

After defining time periods, launch the Build Time Period Calendar process to create instances of these periods for a week, a month, or years. The Build Time Period Calendar process:

- Builds time period calendars using the specified start and end dates.  
These dates do not have to correspond to pay period begin and end dates.
- Enables you to select the time periods to be included in the calendar build process.

- Provides the option to rebuild calendars to change or delete your time period definitions.
- Enables you to update an existing calendar to expand (or contract) the calendar range (that is, to change the start and end dates of the calendar while preserving existing time period definitions).

Before running the calendar build process, define the start and end dates of the calendar that will include the periods defined earlier using the period definition pages. Specify the period types or period ID's to include in (or exclude from) the calendar build. For example, you could use all the defined period types or just one, specific period. To do this, use the Build Time Period Calendar page.

### **Related Links**

[Building and Viewing Time Period Calendars](#)

## **Manager Time Calendar View Options**

Time and Labor provides many options and combinations for viewing time management calendar information. The Calendar View Options page assists in determining what will be displayed on the time calendar pages. Use the Calendar View Options page to define the time reporting codes, using TRC Value lists, which will display on the manager time calendar views, as well as associate color coding to the TRC lists and other time related data.

Each TRC or time-related event defined on the Calendar View Options page appears on the time calendar pages when applicable. The time appears in the grid associated to the time reporter who reported the time, overlaying the color associated with the particular time event. The symbols are optional, both in defining them and also using them on the time calendar pages.

The Calendar View Options page is divided into two primary sections — the Reported/Payable Time section and the Scheduled Time and Exceptions section.

## **Compensatory Time Plans**

Time and Labor enables you to define compensatory time plans. Compensatory time plans provide the ability to administer time off instead of pay. Unlike other leave accruals, where Time and Labor uses the employee's leave balance records maintained in Human Resources, Base Benefits to determine leave availability, compensatory time is administered entirely within Time and Labor. The system maintains each instance of a time reporter's earned compensatory time and the quantity and date earned. This gives you the ability to set expiration periods for individual instances of earned compensatory time.

For example, you may have one compensatory time plan for overtime and another compensatory time plan for meeting or exceeding a deadline. You can establish as many different plans as your organization requires and you can assign a time reporter to one or more compensatory time plans. When compensatory time is entered, the system adds to or deducts from a time reporter's compensatory time balance according to the established rules. If the time entered is within allowed limits, the balance is adjusted and maintained automatically. You do not have to manually change employee's compensatory time balances. The Time Administration process processes compensatory time plans during post-rules processing.

### **Related Links**

[Understanding the Time Administration Process Flow](#)

## Exceptions

Exceptions are user- and system-defined warnings and errors to indicate a problem with a time reporter's time or a problem in the system. Exceptions are tied to the Time and Labor message sets in the message catalog. Defining exception conditions gives control over time reporting messages and warnings. You can keep an audit trail on resolved exceptions for problems, such as how many times an employee is tardy. If you choose to have the exception archived, you can run a query on resolved exceptions to track trends. By making exceptions allowable, you can track low-severity exceptions, and the system will create payable time without the need to make changes to reported time.

The system creates exceptions based on rules, which are defined in Time Administration, or errors that have been generated as a result of reporting time (specifically in the Time Validation process).

Almost all of the system-delivered exceptions have an exception severity of *High* and are defined as *Not Allowable*. These exceptions must be resolved before the Time Administration process creates payable time. You can change the severity and the allowable flag for system-delivered exceptions.

Exceptions that begin with *TLX* work with delivered attendance tracking and validations. The exceptions for attendance tracking are of a low severity, whereas the exceptions for validation are of high severity. These include validations for task reporting, time reporting codes, compensatory and leave time validations, and time reporter status validations.

The system-delivered validation sets are *ST\_SUBMIT*, *ST\_TA* and *ST\_ALL*. If you don't want to have all the validations in this set run during processing, create a validation set and define which validation definitions to include. The *ST\_TA* validation set represents all validations selected to run in Time Administration but not Submit Time. The *ST\_SUBMIT* validation set represents all validations selected to run in Submit Time, but not in Time Administration. The *ST\_ALL* validation set has all validations selected to run in both Submit Time and Time Administration. Each validation is configurable as to whether it is run in Submit Time, Time Administration, neither or both.

Establishing exceptions is the first part of setting up validation criteria so that the Time Validation process can generate exceptions correctly. You also need to set up PeopleSoft Application Engine sections and validation definitions in order for the system to generate exceptions through the Submit Time process. Validation definitions tie the SQL and exception information together to provide the system with a reference and a way to execute exceptions.

This graphic illustrates the areas that need to be set up so that the system can generate exceptions and perform validations during processing.

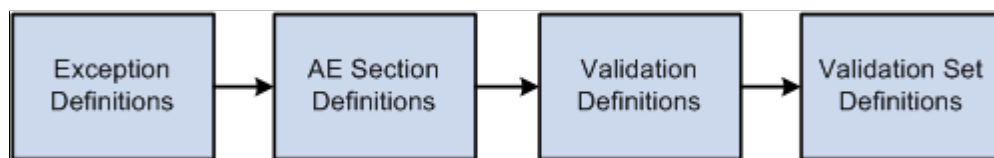

To establish user-defined exceptions, set up Time and Labor messages in the message catalog using PeopleTools. See the product documentation for *PeopleTools: PeopleSoft Application Designer Developer's Guide*.

## PeopleSoft Application Engine Sections

After you've defined exceptions, you define your PeopleSoft Application Engine sections. Application Engine is a feature of PeopleTools that allows you to write software to perform SQL and PeopleCode

processing against the data. An Application Engine program is composed of one or more Application Engine sections. Each Application Engine section typically does one discrete piece of work and is akin to a subroutine, paragraph, procedure of function in a more traditional programming language. Application Engine sections can include referential integrity or validation processing. For each Application Engine section you create, you'll specify which kind of processing should occur.

## Validation Criteria

For the validation process, the system determines the validations to be processed and retrieves the related PeopleSoft Application Engine section names. Each validation definition specifies the Application Engine section name that implements the validation. Control is returned to the Process Validations function upon completion and the system calls the next PeopleSoft Application Engine section.

### Related Links

[Defining PeopleSoft Application Engine Sections](#)

## Setting Up System Defaults and Loading Dates

This section discusses how to set up system defaults and load dates, using the TL Installation (TL\_INSTALL) component.

### Pages Used to Set Up System Defaults and Load Dates

<i>Page Name</i>	<i>Definition Name</i>	<i>Usage</i>
<a href="#">Time and Labor Installation Page</a>	TL_INSTALLATION	Set up general system defaults and to activate specific features for your Time and Labor application.
<a href="#">Configurations Page</a>	TL_INSTL_PUNCH	Set up schedule total options, schedule resolution options, punch pattern defaults and Schedule Change Limits for your Time and Labor application.  The navigation to Load Dates for GAP and Absence Management Setup is HCM, Product Related, Global Payroll and Absence Management, System Settings, Installation Settings.
<a href="#">Dates Table Load Page</a>	TL_DATE_LOAD	Load dates into your Time and Labor system when you implement the system and each time you approach the end of the load period.
<a href="#">Manager Search Defaults Page</a>	TL_INSTL_MSS_DFLT	Set up manager selection criteria fields and options that will be used for returning employee lists for all Time and Labor manager self-service pages.

<b>Page Name</b>	<b>Definition Name</b>	<b>Usage</b>
<u>Self Service Header Info Page</u>	TL_INST_SS_HDRFLD	Define the additional information shown on the Self Service page with the employee name and job title.
<u>User Preferences Page</u>	TL_INST_TR_PREF	Define default values for the user preferences set within the PeopleSoft Fluid User Interface Time page.
<u>Time and Labor - Auto Enrollment Page</u>	TL_AENRL_INSTALL	Enable the auto enrollments setting using Time and Labor installation settings.

## Time and Labor Installation Page

Use the Time and Labor Installation page (TL\_INSTALLATION) to set up general system defaults and to activate specific features for your Time and Labor application.

Navigation:

**Set Up HCM > Install > Product Specific > Time and Labor Installation > Time and Labor Installation**

This example illustrates the fields and controls on the Time and Labor Installation page. You can find definitions for the fields and controls later on this page.

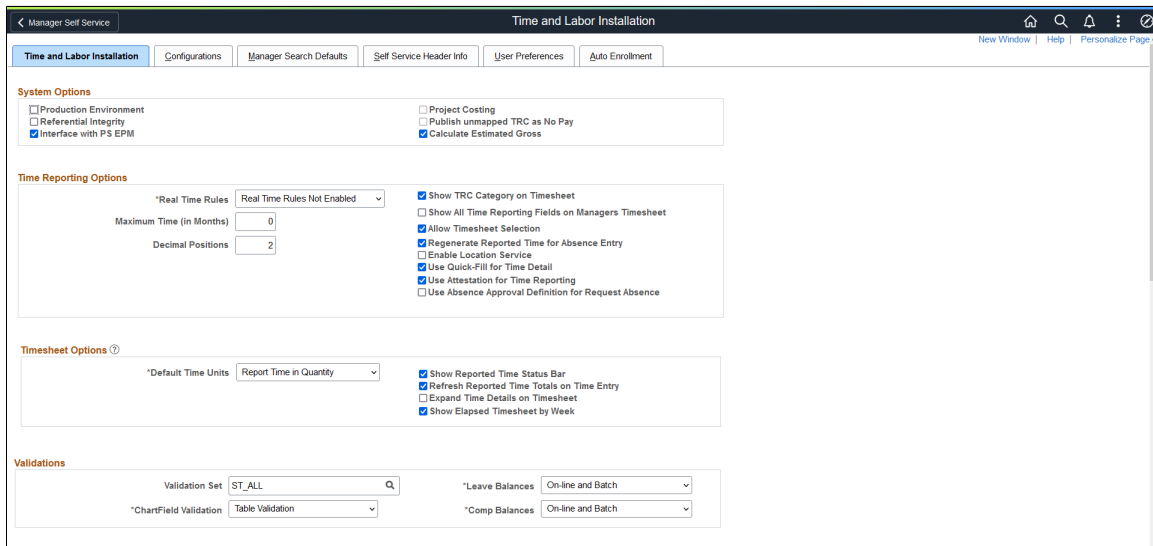

This example illustrates the fields and controls on the Time and Labor Installation page. You can find definitions for the fields and controls later on this page.

**Time Administration Options**

Max Employees in a Batch <input type="text" value="10000"/>	<input checked="" type="checkbox"/> Include All Jobs
Smart Delete Threshold <input type="text"/>	<input checked="" type="checkbox"/> Continue with Exceptions
Smart Update Stats Threshold <input type="text"/>	<input type="checkbox"/> Run As Part Of Submit Time
	<input type="checkbox"/> Use Effective Dated Value List

**Payroll Related Options**

Number of Months to Process <input type="text" value="24"/>	<input checked="" type="checkbox"/> Process Prior Paygroup Time with Current Paygroup
Concurrent Load Time and Labor Cleanup <input type="text" value="1"/>	<input checked="" type="checkbox"/> Concurrent Load Time and Labor Runs
	<input checked="" type="checkbox"/> Set Ignore Status for Not OK to Pay

**TCD File Integration**

Outbound File Directory <input type="text" value="c:\temp\"/>	<input type="button" value="📁"/>
	119 characters remaining
Inbound File Archive Directory <input type="text"/>	<input type="button" value="📁"/>
	127 characters remaining

This example illustrates the fields and controls on the Time and Labor Installation page. You can find definitions for the fields and controls later on this page.

**Comp Plan Assignment**

Default Plan From Workgroup

**Insight and Search Index Options** ⓘ

Enable Incremental Index for Payable Time

**Pivot Grid Options/Defaults**

Timesheet by Status	<input type="checkbox"/> Allow Realtime Processing	Days Backward <input type="text"/>	Days Forward <input type="text"/>
Workforce Availability	Training TRC List <input type="text" value="KUTRN"/>	<input type="button" value="🔍"/>	

Time and Labor Installation | [Configurations](#) | [Manager Search Defaults](#) | [Self Service Header Info](#) | [User Preferences](#) | [Auto Enrollment](#)

## System Options

<b>Field or Control</b>	<b>Description</b>
<b>Production Environment</b>	Select to indicate that the system is no longer in a testing environment. Use this check box to test the production functionality with the ability to change task templates and rules, and to understand exactly how the system responds in production.

The following table describes how certain processes function when the **Production Environment** check box is selected or cleared.

<b>Process</b>	<b>What Happens When the Production Environment Check Box Is Cleared or Selected</b>
Task Templates	<p>Cleared: You can change your task template elements to required, optional, or not used. These changes are allowed, but if you have live data already reported to a template, the resulting tasks may be invalidated, and there will be no validation to catch these errors.</p> <p>Selected: You can change the task template by adding optional task elements or changing required elements to optional.</p>
System Date/TL Security	<p>Cleared: You can select the system date so that it appears on the Row Security Permission List page. This option enables a testing environment in which various users access the same database and enter different system dates to test different time frames.</p> <p>Selected: The System Date field does not appear on the Row Security Permission List page.</p>
Rule Objects	<p>Cleared: All rule objects can be changed.</p> <p>Selected: No rule objects can be changed.</p>
<b>Field or Control</b>	<b>Description</b>
Project Costing	Select this field if you will interface Time and Labor with Project Costing.

<b>Field or Control</b>	<b>Description</b>
<p>Referential Integrity</p>	<p>Cleared: No referential integrity processing for changes to effective-dated tables. Normally, this involves reevaluating reported and payable time, and creating exceptions for all affected time.</p> <p>Selected: Referential integrity processing occurs as necessary.</p> <hr/> <p><b>Note:</b> During non-production times, the system doesn't need to perform referential integrity checks because setup tables will change often, and the reported time is not real.</p> <hr/> <p>The Referential Integrity Flag controls whether there are inserts in the RI_CNTRL_TBL, when a change occurs to an effective dated setup table. The rows in the RI_CNTRL_TBL are then read when the system runs the Time Administration process. This typically involves creation of exceptions for all reported time effected by the change. This flag has no dependency on the Production Environment Flag.</p>
<p>Publish unmapped TRC as No Pay</p>	<p>Two processes use this check box so set the payable time status to No Pay (NP):</p> <ul style="list-style-type: none"> <li>• The Time Administration process refers to this flag when generating payable time for TRCs or workgroups that do not require approval.</li> <li>• The payable time approval processes (online and batch) refer to this flag when setting the payable time status. If the TRC that is used to report time is not mapped to an earnings code in the pay system, or if a time reporter is not set up for payroll on the Maintain Time Reporter Data page, the payable time status is set to No Pay.</li> </ul> <p>If selected, this option creates Time and Labor No Pay Actuals rows in PS Projects.</p>
<p>Interface with PS/EPM</p>	<p>Select this field if you will interface Time and Labor with PeopleSoft Performance Management.</p>



<b>Field or Control</b>	<b>Description</b>
<p><b>Calculate Estimated Gross</b></p>	<p>Clear for the system to not calculate estimated gross for all instances of time. This check box is selected by default. If you clear this check box, all future instances of time lack the estimated gross calculated during the Time Administration process. If there is payable time with estimated gross attached that you don't want, rerun the Time Administration process.</p> <p>You can view the estimated gross by TRC for the time reporter by accessing the Payable Time pages. After a payroll is run, the system distributes the actual gross back to Time and Labor during the Labor Distribution process.</p> <p>For example, you may want to bill estimated costs before the pay cycle. Use the estimated grosses to book the estimated costs ahead of time. When the actual dollars from the Labor Distribution process are posted, you can reverse the estimates and replace them with the actual amounts.</p>

### Time Reporting Options

<b>Field or Control</b>	<b>Description</b>
<p><b>Real Time Rules</b></p>	<p>Select an option to enable the online rules feature. This feature enables you to define online rules and launch an online process (from the Timesheet page) that immediately applies the rules to a time reporter's time. The options are:</p> <ul style="list-style-type: none"> <li>• Real Time Rules Not Enabled.</li> <li>• Run on Submit button. This option launches the process automatically when the Submit button is clicked on the Timesheet page.</li> <li>• Run via separate button. This adds the Apply Rules button to the Timesheet page. The user clicks the Apply Rules button to execute the Real Time Rules process.</li> </ul> <hr/> <p><b>Note:</b> On the Timesheet page, if the user clicks the <b>Apply Rules</b> button, the user is taken to the Payable Time Details page. If there is no payable time created, and if there are exceptions, the user is taken to the Exceptions page.</p> <hr/>

<b>Field or Control</b>	<b>Description</b>
<b>Maximum Time (in Months)</b>	<p>The system uses the value in this field as an upper limit when comparing the starting date specified on a Timesheet and the Earliest Change Date (ECD) for a time reporter. If the time period that the user wants to process is too long, meaning that the ECD is older than the value specified in this field, the system disables the <b>Apply Rules</b> button. This can prevent unacceptable system response times when retroactive changes force the system to recalculate a large volume of Payable Time. To change this situation, the user can change the date on the Timesheet to a prior period and bring the ECD forward incrementally, or the time administrator can run the Time Administration process to move the ECD forward.</p>
<b>Show TRC Category on Timesheet</b>	<p>Select to display TRC categories in the Reported Hours Summary on the Timesheet page</p>
<b>Show all Time Reporting Fields on MGR Timesheet</b>	<p>Select to determine if all the time reporting fields appear on the Manager Timesheet, or only the fields that are <i>selected</i> on the Time Reporter's time reporting template.</p>
<b>Allow Timesheet Selection</b>	<p>Select to enable the user to transfer between the Elapsed and Punch Timesheets.</p>
<b>Update Reported Hours on Entry</b>	<p>Select to enable the real time update of reported hours on entry, in time entry pages.</p>
<b>Decimal Positions</b>	<p>Display the entered number of decimals for the Timesheet pages.</p> <p>Used in the PeopleSoft Fluid User Interface Report Time screen to display the entered number of decimals for the Timesheet, Report Time and Report Leave pages.</p>

<b>Field or Control</b>	<b>Description</b>
<p><b>Regenerate Reported Time for Absence Entry</b></p>	<p>If selected, when absence entries are reported or approved, the system regenerates reported time based on the employee's schedule (Reported Time source is SCH) so that the sum of reported absence and work time from other sources equals the number of scheduled hours for a day.</p> <p>This check box functions in conjunction with the Create Partial Work Hours check box on the Workgroup Defaults page in Time and Labor. If this check box is selected and the <b>Create Partial Work Hours</b> check box is cleared, the system uses full day absence logic when generating time. If the <b>Create Partial Work Hours</b> check box is selected and this check box is cleared, there is no impact on reported time.</p> <p>Select to specifically mention only Absence Management Time Reporting Codes. Time Reporting Codes designated as Leave Taken are not considered as <b>Absence</b> type codes and payable time is not created to complete the schedule. For Example, If TRC defined as <b>Leave Taken</b> is reported as 3 hours on a day the employee is scheduled for 8 hours; only 3 hours would be paid. In order to make the employee whole, you need to also report 5 hours of regular time along with the 3 hours of Leave.</p> <p>Cleared: No referential integrity processing for changes to effective-dated tables. Normally, this involves reevaluating reported and payable time, and creating exceptions for all affected time.</p> <p>Selected: Referential integrity processing occurs as necessary.</p> <hr/> <p><b>Note:</b> During non-production times, the system doesn't need to perform referential integrity checks because setup tables will change often, and the reported time is not real.</p> <hr/> <p>The Referential Integrity Flag controls whether there are inserts in the RI_CNTRL_TBL, when a change occurs to an effective dated setup table. The rows in the RI_CNTRL_TBL are then read when the system runs the Time Administration process. This typically involves creation of exceptions for all reported time effected by the change. This flag has no dependency on the Production Environment Flag.</p> <hr/> <p><b>Note:</b> The default setting for this option is cleared. The workgroup check box setting of <b>Create Partial Work Hours for Partial Absence</b> is also specific only to absence management TRC's.</p> <hr/>

<b>Field or Control</b>	<b>Description</b>
<b>Enable Location Services</b>	Check box to capture employee location when time is reported, provided the employee accepts the use of location services. This is only for Fluid User Interface and not applicable for timesheet.
<b>Use Quick-Fill for Time Detail</b>	Select to use the Quick fill facility. <hr/> <b>Note:</b> This option is available only when the quick fill is allowed at both the installation and workgroup level. By default, both <b>Show Reported Time Status Bar</b> and <b>Use Quick-Fill for Time Detail</b> are unchecked. <hr/>
<b>Use Attestation for Time Reporting</b>	Enable attestation for time reporter. <hr/> <b>Note:</b> By default, this option will be unchecked. Select this option if you want the users to attest their time. This option will work in conjunction with the acknowledgement options set up under employees Workgroup Timesheet Controls, Employee Signature Acknowledgement ID. For more details, refer “Setting Up the Acknowledgement Framework” (Enterprise Components). <hr/>
<b>Use Absence Approval Definition for Request Absence</b>	Enables a newly added absence route for approval as per the approval definition ID set for that absence in Absence Management.

See [Setting Up Workgroups](#).

---

**Note:** The Learning Management field on the Products page (Set Up HCM, Install, Installation Table), needs to be selected, in order for the user to view LM training data icons in Manage Schedules, Monthly Schedules and Calendars.

---

## Timesheet Options

<i>Field or Control</i>	<i>Description</i>
<b>Default Time Units</b>	<p>Select one among the following options to enter time:</p> <ul style="list-style-type: none"> <li>• <b>Report Time in Quantity:</b> The time reported in quantity. For example, users can enter 1.5 to report 90 minutes of time.</li> <li>• <b>Report Time in Units:</b> The reported time in time units in hours and minutes. For example users can enter 1.30 to report 90 minutes of time.</li> </ul> <hr/> <p><b>Note:</b> This option controls how the time is entered and viewed on the Enter Time page. This option will not have any impact on how the time is stored and processed.</p> <hr/>
<b>Show Reported Time Status Bar</b>	<p>Select to display the status bar for <b>Enter Time</b> and <b>View Time Summary</b> pages. Status bar displays for each day if there is schedule configured. Use the User Preferences tab to control the default color settings for this option.</p>
<b>Refresh Reported Time Totals on Time Entry</b>	<p>Select to enable the immediate update of reported hours on entry in both Employee and Manager Self Service pages. If not selected, the reported hours and status bar will not be updated until the time is either saved or submitted.</p>

<b>Field or Control</b>	<b>Description</b>
<p><b>Expand Time Details on Timesheet</b></p>	<p>Select to view the time detail values inline in the Timesheet pages for Time Administrators, Managers and Employees. This applies in both view and edit modes for punch and elapsed time reporters.</p> <p>When unselected, the time details are shown under the <b>Time Details</b> icon.</p> <p>For more details on Employee Self Service pages, refer <a href="#">Enter Time Page for Elapsed Time Reporter</a> and <a href="#">Enter Time Page for Punch Time Reporter</a>.</p> <p>For more details on Manager Self Service pages, refer <i>Time Detail values inline for Punch Time Reporter</i> under <a href="#">Select Employee Page</a> and <i>Time Detail values inline for Elapsed Time reporter</i> under <a href="#">Weekly Time Entry page</a>.</p> <p>To know more about <b>Expand Time Details on Timesheet</b>, watch this video:</p> <p>Video: <a href="#">Image Highlights, PeopleSoft HCM Update Image 34: Fluid Timesheet Fluid Details Display</a>.</p>
<p><b>Show Elapsed Timesheet by Week</b></p>	<p>Enables the timesheet to display days paginated as weeks for time periods greater than weekly. Deselecting this option will display all the days for the chosen time period in a single view.</p> <hr/> <p><b>Note:</b> By default, this option will be checked</p> <hr/>

**Validations**

<b>Field or Control</b>	<b>Description</b>
<p><b>Leave Balances</b></p>	<p>Select <i>On-line Only</i> for the system to validate leave balances only when entered during online processing.</p> <p>Select <i>Batch Only</i> for the system to validate leave balances only during batch processing of rules or validating time.</p> <p>Select <i>On-line and Batch</i> for the system to validate leave balances during online and batch processing.</p> <p>Select <i>None</i> for the system not to validate leave balances.</p> <p>If you change the validation option, all time processed prior to the change may need to be reevaluated as leave balances have been processed and exceptions created.</p>

<b>Field or Control</b>	<b>Description</b>
<b>Compensatory Balances</b>	<p>Select <i>On-line Only</i> for the system to validate compensatory balances only when entered during online processing.</p> <p>Select <i>Batch Only</i> for the system to validate compensatory balances only during batch processing of rules or when validating time.</p> <p>Select <i>On-line and Batch</i> for the system to validate compensatory balances during online and batch processing.</p> <p>Select <i>None</i> for the system not to validate compensatory balances.</p> <p>If you change these values, all time processed prior to the change may need to be reevaluated as compensatory time has already been processed, and exceptions will be created.</p>
<b>Validation Set</b>	<p>Select the validation ID to determine the validation definitions that will run during the Time Reporting validation process. This validation process is triggered by the Submit Time process and during the Referential Integrity process. The system delivered validation sets are ST_ALL, ST_TA and ST_SUBMIT.</p>
<b>Chartfield Validation</b>	<p>Select <i>Table Validation</i> for the system to validate Chartfields against the VALID_COMBO_TBL directly within HCM.</p> <p>Select <i>Sync Message</i> for the system to validate Chartfields by messaging the FMS database.</p> <p>Select <i>None</i> for the system not to validate Chartfields.</p>

## Time Administration Options

<b>Field or Control</b>	<b>Description</b>
<p><b>Max Employees in a Batch</b> (maximum employees in rules run)</p>	<p>Enter the number of employees for the system to process at a time when running rules (Time Administration process). The number controls system performance during batch processing. The default value is <i>100</i>.</p> <hr/> <p><b>Note:</b> Set this value as high as necessary, as long as your database is capable of handling a higher volume per batch. High values create fewer batches during the Time Administration process and system performance improves due to a reduction in TL_TA000410 loops during the Time Administration process.</p> <hr/> <p>See <a href="#">Understanding the Time Administration Process Flow</a>.</p>
<p>Continue with Exceptions</p>	<p>Select to enable the system to continue to run the process when exceptions are encountered. The system generates payable time for the employee, except for the days with high severity exceptions. This means that for a high severity exception, the system generates the exception and does not generate payable time for the impacted reported time. For any other exceptions, the system generates the exception and continues to generate payable time for the impacted reported time.</p> <p>Clear the field to indicate that when the system encounters any exception, no payable time is generated for the impacted reported time.</p>
<p>Include All Jobs</p>	<p>Select to process all employee record (Empl_RCD) numbers for the Employee ID, if the TA status and ECD are ready for processing. This selection overrides any Employee Record numbers specified on the Request Time Administration run control page. Employee Record numbers in different workgroups are processed in different batches.</p> <p>Clear this field to process the Employee Record numbers specified on the Request Time Administration page or all of the Employee Record numbers in the same workgroup as the Employee Record numbers listed on the Request Time Administration page. Employee Record numbers in the same workgroup are processed in the same batch.</p>
<p>Smart Delete Threshold</p>	<p>Use this impacted rows to determine whether to use truncate or delete. The default value is 3000.</p>



<b>Field or Control</b>	<b>Description</b>
Smart Update Stats Threshold	Use this impacted rows to determine whether to use Update stats or not. The default value is 3000.  <b>Note:</b> The <b>Smart Delete Threshold</b> and <b>Smart Update Stats Threshold</b> should be set to 1000 for the customised template based rules to work. Smart batches of employees benefit by decreased runtime in TL rules processing.
Run As Part Of Submit Time	Check this option to determine whether the Time Admin needs to run when Time is submitted through the Timesheet.
Use Effective Dated Value List	Select to add Effective Dating to value lists for use in rule templates and keep the original tables in place for all other value list functions.

## Understanding the Identity Column

To determine the correct number of temporary table instances for the TL\_TA\_RESEQX record, you have two options:

- You validate the Instance Count value on the TL\_TIMEADMIN Application engine program, Properties folder and add that to the number of Temp Table instances (Online) defined on the PeopleTools Options page, or
- Open the Application Designer and create the TL\_TA\_RESEQX table using the Build SQL Script option. This option creates the script to build the required number temporary table instances.

If you are using the first option above of determining the number of temp table instances, then use the script below for building each temp table instance. For each temp table instance, replace the temp table number for "n" in the script. For PS\_TMP\_TS and PS\_TMP\_TSIDX, replace with your appropriate tablespace and index tablespace, respectively, for the table TL\_TA\_RESEQX.

This displays the Base table of the TL\_TA\_RESEQX record.

```
DROP TABLE PS_TL_TA_RESEQXn;
CREATE TABLE PS_TL_TA_RESEQXn (PROCESS_INSTANCE DECIMAL (10) NOT NULL,
    EEMPLID CHAR (11) NOT NULL,
    EEMPL_RCD SMALLINT NOT NULL,
    DUR_DATE,
    SEQ_NBR DECIMAL (15) NOT NULL,
    SEQ_NBR1 DECIMAL (15) GENERATED ALWAYS
    AS IDENTITY
    (START WITH 1,
    INCREMENT BY 1,
    CACHE 72000,
    MINVALUE 1,
    MAXVALUE 10080000),
    TRC CHAR (5) NOT NULL,
    TL_QUANTITY DECIMAL (18, 6) NOT NULL) IN PS_TMP_TS INDEX IN PS_TMP_TSIDX
NOT LOGGED INITIALLY;
COMMIT;
CREATE UNIQUE INDEX PS_TL_TA_RESEQXn ON PS_TL_TA_RESEQXn
(PROCESS_INSTANCE,
```

```

EMPLID,
EMPL_RCD,
DUR,
SEQ_NBR,
SEQ_NBR1);
COMMIT;
    
```

If you are using the second option above, Building SQL Script to create the table then you would alter the generated script as follows:

Replace SEQ\_NBR1 references with:

```

SEQ_NBR1 DECIMAL (15) GENERATED ALWAYS
AS IDENTITY
(START WITH 1,
 INCREMENT BY 1,
 CACHE 72000,
 MINVALUE 1,
 MAXVALUE 10080000)
    
```

This change ensures the creation of the SEQ\_NBR1 field as an Identity column for TL\_TA\_RESEQX.

### Payroll Related Options

The setting in this group box affects integration between Time and Labor and Payroll for North America.

See [Configuring Time and Labor for Use with Payroll for North America](#).

<b>Field or Control</b>	<b>Description</b>
Number of Months to Process	Enter the maximum number of months that the Load Time and Labor process will look back for prior adjustments. Enter the number of prior months of data to process during the loading. The number entered must not be negative, or else a error message would be generated. For example, if current date is 6/30/03 and the user entered 3 to the field, it will go back to 3/30/2003 on the Frozen Date field to load payable time to Payroll.

<b>Field or Control</b>	<b>Description</b>
<p>Process Prior Paygroup Time with Current Paygroup</p>	<p>This check box controls how Payable Time is loaded into paysheets when a Prior Period Adjustments (PPA) exists and the employee had a pay group change.</p> <p>For example, an employee transferred from pay group 1 to pay group 2 on September 1. When payroll is run on August 31, all Payable Time is loaded up to August 31 and the employee has one check in pay group 1. When payroll is run on September 30, all Payable Time in September is loaded and the employee has one check in pay group 2. Then, a prior period adjustment (PPA) occurs for the August pay period:</p> <ul style="list-style-type: none"> <li>• If this check box is selected, then the PPA is loaded and paid in the September check. In this case the money is paid from the correct pay group and expenses are associated with the proper account.</li> <li>• If this check box is not selected, then the PPA is not loaded. The payroll clerk must create paysheets for the employee in pay group 1 to load the PPA and have it paid.</li> </ul>
<p>Concurrent Load Time and Labor Runs</p>	<p>Select this check box if you run the Time and Labor Load processes concurrently (that is, multiple Load processes are run simultaneously). Clear this check box if the Time and Labor Load process is never run concurrently.</p>
<p>Concurrent Load Time and Labor Cleanup</p>	<p>Set this field using the following criteria:</p> <ul style="list-style-type: none"> <li>• If you do not use concurrent processing, set this value to twice the largest number of paygroups processed in a Time and Labor load process. For example, if the largest number of paygroups your organization processes is nine, set this value to 18.</li> <li>• If you use concurrent processing, set this value to the number of concurrent processes multiplied by twice the largest number of paygroups in a Time and Labor load process. For example, for nine paygroups and 11 concurrent processes, set this value to 198.</li> </ul>

<b>Field or Control</b>	<b>Description</b>
Set Ignore Status for Not OK to Pay	<p>This check box defines the payable time status code and reason codes that Time and Labor sets during the Distribution Dilution process when a no pay other earning or pay earning are processed:</p> <ul style="list-style-type: none"> <li>• If this check box is selected, then Time and Labor sets the payable time status code to <i>Ignore (IG)</i> and the reason code to <i>Not OK to Pay (NOP)</i> for any payable time for which the payline has the <b>OK to Pay</b> check box cleared.</li> <li>• If this check box is not selected, then Time and Labor sets the payable time status code to <i>Rejected by Payroll (RP)</i> and the reason code to <i>Not Processed in Payroll (PNP)</i>.</li> </ul> <p>The default setting for this option is selected.</p>

**Note:** The Payable Time rows, that are in ignore (IG) status, generate offsets in all cases. When the original row was processed under North American Payroll, the negative row will be generated directly by Time Administration in Ignore status. This addresses any over or underpayment issues and thus properly create offsets as usual for a Global Payroll user.

See [Payable Time Status and Reason Codes](#).

### TCD File Integration

<b>Field or Control</b>	<b>Description</b>
<b>Outbound File Directory</b>	<p>Enter the directory path for the TCD outbound flat files created by Integration Broker. These files are sent to your time collection device. Your path must end with a backslash (\). This directory is for flat file TCD integration only.</p>
<b>Inbound File Archive Directory</b>	<p>Enter the path for the TCD inbound flat file data to be archived after the inbound file process reads the data. Your path must end with a backslash (\) for successful creation of the flat file. This directory is for flat file TCD integration only.</p>

<b><i>Field or Control</i></b>	<b><i>Description</i></b>
<b>Max Punches in a Batch</b>	<p>Enter the maximum size of each batch of incoming messages from a TCD server for use with the PUNCHED_TIME_ADD service operation. The value in this field only affects the batch size of messages when you activate the PUNCH_ADD_DAEMON service operation handler. This field is only available after you have activated the PUNCH_ADD_DAEMON handler.</p> <p>See <a href="#">Incoming Service Operations from the TCD Server to the PeopleSoft Server</a>.</p>

## Comp Plan Assignment

<i>Field or Control</i>	<i>Description</i>
<p><b>Default Plan From Workgroup</b></p>	<p>Select for the system to automatically populate the Comp Plan Enrollment page with the compensatory plan associated with the workgroup of a time reporter. If you select this check box, you can't:</p> <ul style="list-style-type: none"> <li>• Override the compensatory plan assignment on the Comp Plan Enrollment page.</li> <li>• Delete or inactivate the compensatory plan on the Comp Plan Enrollment page.</li> </ul> <p>The compensatory plan is controlled by the association of the workgroup to the time reporter.</p> <p>You can alter the compensatory plan association for the time reporter in two ways:</p> <ul style="list-style-type: none"> <li>• Change the workgroup associated with the time reporter on the Maintain Time Reporter data page.</li> <li>• Change the compensatory plan associated with the time reporter's workgroup.</li> </ul> <p>The system will automatically update the compensatory plan association accordingly.</p> <p>If you don't select this check box, you can enter any number of rows on the Comp Plan Enrollment page and inactivate any of the compensatory plans. You can't delete a row on the Maintain Time Reporter data page if it inactivates an association to a compensatory plan. Inactivate the association of the compensatory plan to the time reporter on the Comp Plan Enrollment page; then delete the row on the Maintain Time Reporter Data page.</p> <hr/> <p><b>Important!</b> You can only change this option once.</p> <hr/> <p>The system doesn't enable changing this value back and forth because:</p> <ul style="list-style-type: none"> <li>• When you clear this field, the system deletes compensatory plan rows on the Comp Plan Enrollment page.</li> <li>• The system derives the workgroup's compensatory plan from the association defined during the Create Time Reporter Data setup.</li> <li>• If you change this value again, any compensatory plan balances could be invalidated due to the changes in the</li> </ul>

<b>Field or Control</b>	<b>Description</b>
	compensatory plan associations and the TRCs assigned to the compensatory plan.

See the product documentation for *PeopleTools: PeopleSoft Application Designer Developer's Guide* and

## Insight and Search Index Options

<b>Field or Control</b>	<b>Description</b>
<b>Enable Incremental Index for Payable Time</b>	<p>Select this option to enable the Incremental Search for Payable Time.</p> <hr/> <p><b>Note:</b> This option requires database triggers, therefore ensure database triggers are created. Contact your database administrator to implement triggers on the database.</p> <hr/>

### Related Links

[Online Processing Component](#)  
[Adding Rules to a Rule Program](#)  
[Exceptions Page](#)  
[Understanding Workgroups](#)  
[Understanding TCDs](#)

## Configurations Page

Use the Configurations page (TL\_INSTL\_PUNCH) to set up schedule total options, schedule resolution options, and punch pattern defaults for your Time and Labor application.

Navigation:

**Set Up HCM > Install > Product Specific > Time and Labor Installation > Configurations**

This example illustrates the fields and controls on the Configurations page. You can find definitions for the fields and controls later on this page.

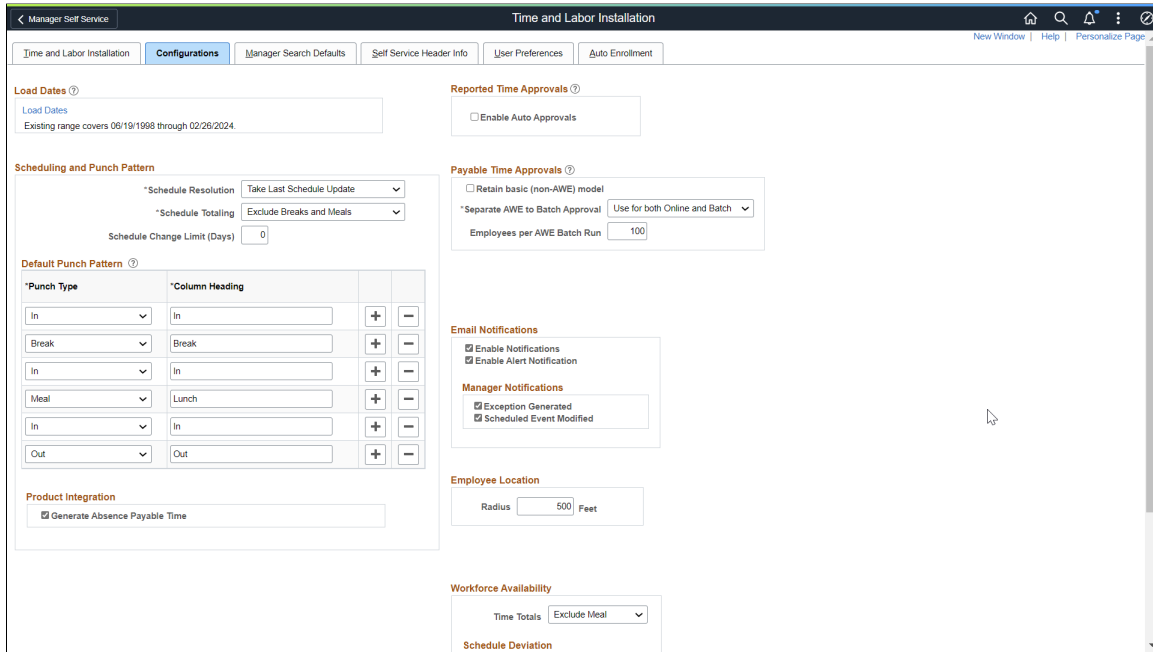

**Important!** This page (TL\_INSTL\_PUNCH) is the same as the “Schedule Settings Page” (PeopleSoft Global Payroll) for Global Payroll and Absence Management. The settings that you define on this page are shared between Time and Labor, Global Payroll, and Absence Management.

### Load Dates

<b>Field or Control</b>	<b>Description</b>
<b>Load Dates</b>	When you click this link, the system accesses the Dates Table Load page, where you can determine the range of dates to use for time-reporting and scheduling purposes. When loading the number of years for processing prior, current or future time, keep the years in sync with the years loaded in the Time Zone Offset table.

### Scheduling and Punch Pattern

**Warning!** Be careful to create a punch pattern that makes sense, without the same punch type in a row.



<b>Field or Control</b>	<b>Description</b>
Schedule Resolution Options	<p>This field specifies how to resolve schedule changes. If the <i>Take Last Schedule Update</i> field value is selected, whether the last schedule update is from a workforce scheduling third-party system, or an online override, the system will take the last update to resolve the employee's schedule. If the <i>Take Online Override</i> field value is selected, the system will look for an online schedule override for resolving the schedule for the day, if an override exists. The system will not look for any changes from a third-party workforce scheduling system.</p>
Schedule Totaling	<p>Use this option to configure whether meal and/or break times are included in Scheduled Hours totals on schedule definitions, and shift definition and Manage Schedules. Valid values are <i>Exclude Meals and Breaks</i>, <i>Include Breaks</i>, <i>Include Breaks and Meals</i>, <i>Include Meals</i>. The default is <i>Exclude Meals and Breaks</i>.</p>
Schedule Change Limit (Days)	<p>Enter days in number for setting the schedule change limit. The schedule change limit value is set as three digits number.</p> <hr/> <p><b>Note:</b> If the default installation setting is set 0, then the schedule change is not applicable. This means that the manager should be able to make retroactive schedule changes without any limitation on Manage Schedule and Assign schedule pages. Managers will not be able to make schedule changes beyond the limit set at the installation level. This validation is only for Managers. For Administrators, there is no restriction in changing the schedule anytime in the past.</p> <hr/>
Default Punch Pattern	<p>For the Time Reporting and Scheduling pages, set up the punch pattern you require to be defaulted. A total of ten punches can be entered. A label can also be specified for each punch type row. The default punch pattern set here also defaults to the Time Reporting Template page. On the Time Reporting Template page, you can override the Installation Table settings and establish a different punch pattern for specific groups of punch time reporters, rather than for all punch time reporters.</p> <hr/> <p><b>Important!</b> Be sure not to create the same punch type successively, check the order of your punch types.</p> <hr/>

## Product Integration

<i>Field or Control</i>	<i>Description</i>
<b>Generate Absence Payable Time</b>	Select the check box to enable administrators to generate absence payable time directly to Time and Labor. If you deselect this check box, the <i>Generate Absence Payable Time Page</i> doesn't display any absence management calendars and it's related buttons/links.

## Reported Time Approvals

<i>Field or Control</i>	<i>Description</i>
<b>Enable Auto Approvals</b>	<p>Auto Approvals for Enter Time Punch and Elapsed Pages.</p> <p>Any Time Entered by the Manager on behalf of their employees should be auto-approved for this approval level if the following conditions are met:</p> <ul style="list-style-type: none"> <li>• The reported time is entered or edited by the Manager</li> <li>• Only Time that is entered and edited by the manager</li> <li>• Any Time (Line or day level) only if acted on by the Manager</li> <li>• The immediate approver in the approval chain is the same person as the acting Manager or their delegates (Applies to multiple managers in the same approval level).</li> </ul>

## Payable Time Approvals

<i>Field or Control</i>	<i>Description</i>
<b>Retain Basic (non-AWE) Model</b>	Select to retain a simpler security based model for approving payable time, rather than implement the Approval Framework for payable time. This means that a manager's access and ability to approve a time reporter's payable time is based on the same security that grants the manager access to view and modify the person's time.
<b>Separate AWE to Batch Approval</b>	Select the required option to setup the AWE processing of Time Admin can either be set up as a separate process for Batch, Batch and Online or Normal AWE, while maintaining all current Time Admin processing.

<b><i>Field or Control</i></b>	<b><i>Description</i></b>
<b>Employees per AWE Batch Run</b>	<p>Number of employees per AWE Batch Run.</p> <p>Setting the Employee per AWE Batch Run creates groups or batches of employees per AWE run. These runs are concurrent depending on how many concurrent processes can be handled by the process scheduler.</p>

## Email Notifications

<b><i>Field or Control</i></b>	<b><i>Description</i></b>
<b>Enable Notifications</b>	Choose this field specify the use of email notifications.

## Manager Notifications

<b><i>Field or Control</i></b>	<b><i>Description</i></b>
Exception Generated	<p>Select this option to generate an email to a manager if exceptions are generated when:</p> <ul style="list-style-type: none"> <li>• The Time Administration process is run to create payable time.</li> <li>• The Submit Time process is run for time that has been collected by different collection devices (PeopleSoft Mass Time Component, PeopleSoft Web Clock Component, TCD's, and Absences).</li> </ul>
Schedule Event Modified	Select this option to generate an email to a manager if an external schedule event is updated or deleted. (This will be triggered with updates from Enterprise Learning Management, if the user is utilizing this application with Time and Labor).

**Note:** Oracle PeopleSoft delivers Notification Composer Framework to manage the setup and administration of all notifications in one central location.

Once you have adopted the Notification Composer feature, you must use it to create new notifications and manage your existing notifications.

Notifications delivered with HCM Image 47 or later must use Notification Composer.

For more information about Notification Composer Framework, see “Understanding Notification Composer” (Enterprise Components).

**Note:** In order for a batch process to insert a URL in an email notification to a manager, the following setup needs to be completed for the database local node. This determines the portal and node used for this process.

On the Portal page in the Nodes (IB\_NODE) component, ensure that the **Content URI Text** and the **Portal URI Text** fields are populated as per the format displayed on the screen.

See *PeopleTools Portal Technologies PeopleBook, Configuring the Portal Environment*

## Employee Location

When employees report time and have accepted the use of location services in the device which they use, and your organization has licensed and enabled Oracle Maps Service for PeopleSoft on the Installation Table - “Third Party/System Page” (Application Fundamentals), their location displays on a map on the *Reporting Location page*. For situations where a single employee is reporting time at the same location a few feet apart, the installation setting groups the reported time into a single marker on the map.

<b>Field or Control</b>	<b>Description</b>
<b>Radius</b>	Specify a radius in feet where multiple time reports in that radius are grouped into a single marker. The default setting will be 500 feet. With these settings, any reported time or elapsed time reported within 500 feet are considered as the same location.

**Note:** The map display functionality shown in the HCM features requires a separate license to Oracle Maps Cloud Service for PeopleSoft. For details see the Licensing Information User Manual (LIUM).

## Workforce Availability

<b>Field or Control</b>	<b>Description</b>
<b>Time Totals</b>	<p>There are two possible values for Time Totals:</p> <p><b>Exclude Meal:</b> This is the default value for this field. When this value is selected, Meal duration is excluded while calculating the Total Scheduled/Reported hours for an employee displayed in the right panel</p> <p><b>Include Meal:</b> When this value is selected, Meal duration is included while calculating the Total Scheduled/Reported hours for an employee</p>

<b>Field or Control</b>	<b>Description</b>
<b>Schedule Deviation</b>	<p>Select check boxes for Schedule Deviation ranging from <b>Early In</b>, <b>Early Out</b>, <b>Meal</b>, <b>Late In</b> and <b>Late Out</b>.</p> <ul style="list-style-type: none"> <li>• <b>Early In:</b> Select to flag <b>Early In</b> as schedule deviation.</li> <li>• <b>Early Out:</b> Select to flag <b>Early Out</b> as schedule deviation.</li> <li>• <b>Meal:</b> Select to flag <b>Meal</b> as schedule deviation.</li> <li>• <b>Late In:</b> Select to flag <b>Late In</b> as schedule deviation.</li> <li>• <b>Late Out:</b> Select to flag <b>Late Out</b> as schedule deviation.</li> <li>• <b>Tolerance:</b> The amount of time in minutes which a worker may clock in/clock out either early or late which is not considered as schedule deviation.</li> </ul>

## See Also

See the product documentation for:

- *PeopleTools: PeopleCode API Reference*
- *PeopleTools: Workflow Technology*
- *PeopleTools: System and Server Administration*

## Related Links

[Setting Up the Time and Labor Mobile Applications](#)

## Dates Table Load Page

Use the Dates Table Load page (TL\_DATE\_LOAD) to load dates into your Time and Labor system when you implement the system and each time you approach the end of the load period.

Navigation:

Click the **Load Dates** link on the Configurations page.

This example illustrates the fields and controls on the Dates Table Load page. You can find definitions for the fields and controls later on this page

**Dates Table Load** ✕

Existing range covers 06/19/1998 through 09/16/2020.

The 'Years' field below will determine the range of dates populated into the Dates Table. The Dates Table is used by many functional areas including Scheduling and Time Reporting. The recommended value for the 'Years' field below is 2. The value of 2 years will load the dates table from 2 years before the current date and 2 years after the current date, resulting in 4 total years.

The Dates Table is used to provide all pertinent information related to a date. This information includes: Day of Week, Day of Month, Week of Month, Week of Year, Month of Year, Calendar Year, and Julian Date.

---

Years 
Load Dates

Return

<b>Field or Control</b>	<b>Description</b>
<b>Years</b>	<p>Enter the number of years for the system to load into the database. The system will enter the dates for the number of years you entered, backward and forward. For example, if you entered 2, the system would load two years backward and two years forward. The maximum number of years to enter is 10.</p> <hr/> <p><b>Important!</b> Towards the end of the period you specify, be sure to load the next set of dates.</p>
<b>Load Dates</b>	Click to load dates into the TL_DATES_TBL and create data in the TL_TA_OFFSET record.
<b>Return</b>	Click to return to the Configurations page.

## The Purpose of Load Dates

The Load Dates link populates years of dates into two tables.

The first table is TL\_DATES\_TBL, which populates years of dates for schedule resolution, and determines the date display while reporting time in the Time and Labor Timesheet. Global Payroll, Absence Management and Time and Labor uses the Schedule resolution process. Based on the number of years entered, the system populates that number of years prior to the current date, and after the current date.

The second table populated is TL\_DSTOFFSET for Daylight Savings, which is used in Time Administration for Time and Labor. The system uses this table to calculate the duration of the transition times that occur at the beginning of daylight savings or at the ending of daylight savings per time zone.

Finally, the table, PSTZOFFSET is populated from the Time Zone Query Offsets function from the Time Zones page, and is also used in Time and Labor's Time Administration process, as well as the Scheduling process. The system uses PSTZOFFSET to convert the base time zone into the reported or scheduled time zone. (Refer to Tools page for Time Zone Query Offsets.)

All three tables, TL\_DATES\_TBL, TL\_DSTOFFSET and PSTZOFFSET should be in sync with each other, with regards to the years loaded.

## Manager Search Defaults Page

Use the Manager Search Defaults page (TL\_INSTL\_MSS\_DFLT) to set up manager selection criteria fields and options that will be used for returning employee lists for all Time and Labor manager self-service pages.

Navigation:

**Set Up HCM > Install > Product Specific > Time and Labor Installation > Manager Search Defaults**

This example illustrates the fields and controls on the Manager Search Defaults page. You can find definitions for the fields and controls later on this page

Configurations
Manager Search Defaults
Self Service Header Info
User Preferences
Auto Enrollment

**Loading of Matching Employees**

Auto Populate Results

Prompt for Results

**Default Criteria Presentation**

Show Criteria List Collapsed

Show Criteria List Expanded

**Employee Selection Criteria**

Description	Include in Criteria	*Include in List
Time Reporter Group	<input checked="" type="checkbox"/>	Do Not Include
Employee ID	<input checked="" type="checkbox"/>	Include <span style="float: right;">▼</span>
Empl Record	<input checked="" type="checkbox"/>	Include <span style="float: right;">▼</span>
Last Name	<input checked="" type="checkbox"/>	Include
First Name	<input checked="" type="checkbox"/>	Include
Business Unit	<input checked="" type="checkbox"/>	Include Code Only <span style="float: right;">▼</span>
Job Code	<input checked="" type="checkbox"/>	Include Code and Description <span style="float: right;">▼</span>
Job Description	<input checked="" type="checkbox"/>	
Department	<input checked="" type="checkbox"/>	Include Description Only <span style="float: right;">▼</span>
Supervisor ID	<input checked="" type="checkbox"/>	Include Code Only <span style="float: right;">▼</span>

**Data Loading in Time Management** ?

Folder	Portal Label	*Chunk Size
Approve Time and Exceptions	Payable Time	300
Approve Time and Exceptions	Reported Time	300
Manage Schedules	Manage Schedules	300
Report Time	Absence Request	10
Report Time	Timesheet	300
View Time	Daily Time Calendar	10
View Time	Monthly Time Calendar	10
View Time	Weekly Time Calendar	10

This page is used by managers and time administrators to set defaults that display on the Manager Search Options – Select Default Criteria and Options page. The Manager Search Options page is used for the various manager functions, to provide a consistent interface in which managers and administrators can easily identify, select and navigate through the pool of employees in whom they are interested.

You can establish preferred employee criteria and default values by configuring options on the Manager Search Defaults page. Employee lists can be pre-populated with a subset of a managers overall employee pool, criteria can be changed and data refreshed to expand or contract employee lists. When the employee pool is identified on pages that use the Manager Search page, the list persists throughout the application for easy navigation.



## Loading of Matching Employees

<i>Field or Control</i>	<i>Description</i>
AutoPopulate Results	Auto populate the employee list when entering the page.
Prompt for Results	Do not automatically populate the employee list, allowing the manager or administrator to review or change criteria values. A button is then selected and the employee list displayed.

## Default Criteria Presentation

<i>Field or Control</i>	<i>Description</i>
Show Criteria List Collapsed	Collapse the Manager Search Criteria group box when entering the Manager Search Options page.
Show Criteria List Expanded	Expand the Manager Search Criteria group box when entering the Manager Search Options page.

## Employee Selection Criteria

Use the fields in this region to choose the fields that are displayed in the Search Criteria group box when entering the Manager Search Options page.

<i>Field or Control</i>	<i>Description</i>
Include in Criteria	Select to include this field in the Manager Selection Criteria. When the Manager Selection Criteria is displayed on the Manager Search Options page, this field can be used to filter employee lists.
Include in List	<p>Include this field in the employee list that is returned on the Manager Search Options page.</p> <p>You can choose <b>Do Not Include</b> to prevent the display of the specified field in the employee list. For fields that display as a code and have a description on their definition table, you can configure the list display using the following values: <b>Include Code Only</b>, <b>Include Code and Description</b>, or <b>Include Description Only</b>.</p>

## Data Loading in Time Management

Enter the chunk size that you would like the Employee search to load. The system uses this size to determine initial row load and subsequent chunk rows.

## Self Service Header Info Page

Use the Self Service Header Info page (TL\_INST\_SS\_HDRFLD) to define the additional information shown on the Self Service page with the employee name and job title.

Navigation:

**Set Up HCM > Install > Product Specific > Time and Labor Installation > Self Service Header Info**

This example illustrates the fields and controls on the Self Service Header Info page. You can find definitions for the fields and controls later on this page

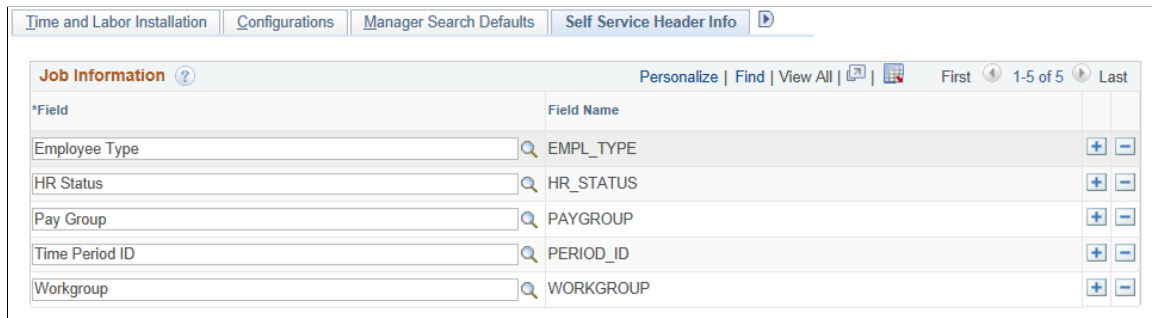

Use this list to define additional information you want to display in the Self Service page headers with the employee’s name and job title. The information is visible on the Self Service page as a pop-up window when the user moves his or her mouse over the employee’s job title.

## User Preferences Page

Use the User Preferences page (TL\_INST\_TR\_PREF) to define default values for the user preferences set within the PeopleSoft Fluid User Interface Time page.

Navigation:

**Set Up HCM > Install > Product Specific > Time and Labor Installation > User Preferences**

This example illustrates the fields and controls on the User Preferences page. You can find definitions for the fields and controls later on this page.

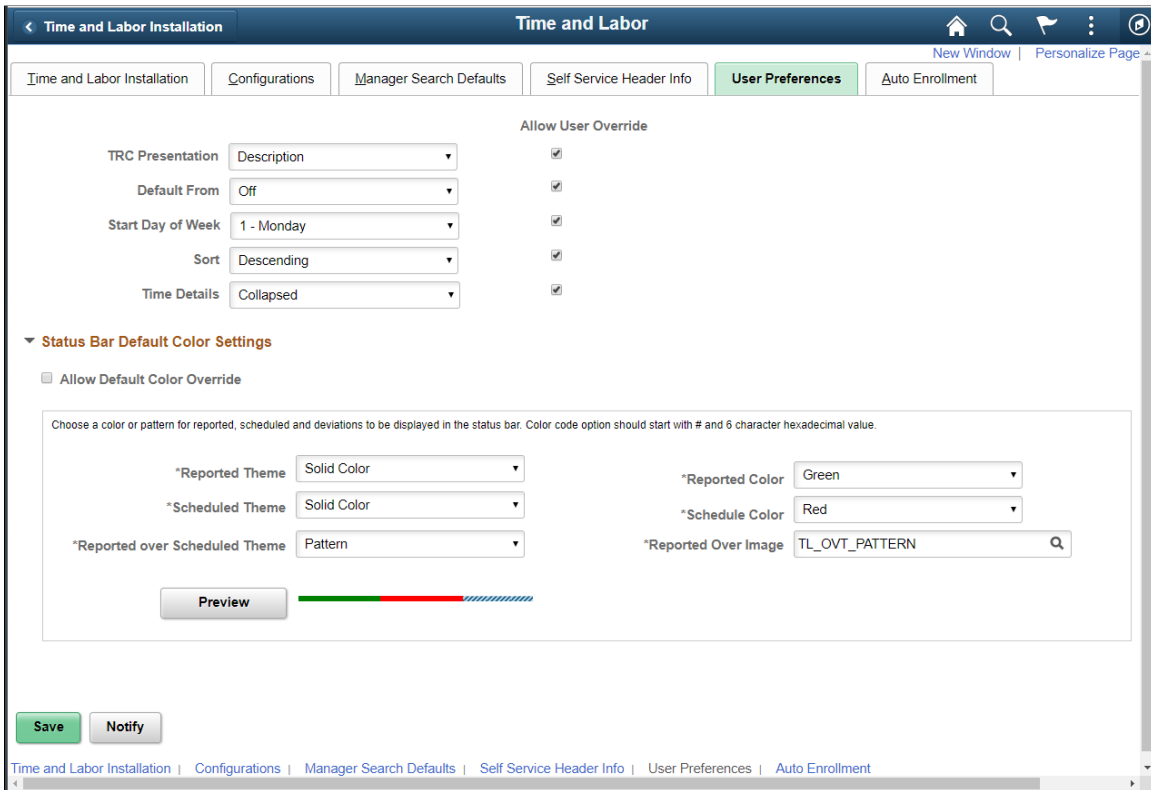

The administrator uses this page to define default user preferences for the PeopleSoft Fluid User Interface Time pages. When granted permission, users can override these options.

<b>Field or Control</b>	<b>Description</b>
<b>TRC Presentation</b>	Select the default option on how TRCs should display on the <u>Select Employee Page</u> and the <u>Weekly Time Entry page</u> in the PeopleSoft Fluid User Interface. Options are: <ul style="list-style-type: none"> <li>• <i>CODE-Description</i></li> <li>• <i>Description-CODE</i></li> <li>• <i>Description</i> (the default setting). This configuration option determines in what format the Time Reporting Code will be displayed on the Report Time, Report Leave and Weekly Time pages.</li> </ul>

<b>Field or Control</b>	<b>Description</b>
<b>Default From</b>	<p>Select the default option on how to copy elapsed time entry. The options are:</p> <ul style="list-style-type: none"> <li>• <i>Off</i></li> <li>• <i>Prior Period</i>: Enables the employee to copy the time from prior time.</li> <li>• <i>Schedule Information</i>: Enables the employee to copy the schedule from an existing schedule.</li> <li>• <i>Task Values</i>: Enables the employee to copy the task value which is already set.</li> </ul>
<b>Start Day of the Week</b>	<p>Select the default option on how to display a snapshot of the week by indicating the first day of a work week.</p>
<b>Sort</b>	<p>Select the default option on how to display punch time reported entries. Options include:</p> <ul style="list-style-type: none"> <li>• <i>Descending</i>: The last entry at the top.</li> <li>• <i>Ascending</i>: The last entry at the bottom.</li> </ul>
<b>Time Details</b>	<p>Select the display option that should be provided by default to the user when viewing the <a href="#">Report Time Select Employee Filters</a> page in fluid. Options are:</p> <ul style="list-style-type: none"> <li>• <i>Collapsed</i>: When selected, the Time Details group box will be collapsed upon accessing the page.</li> <li>• <i>Expanded</i>: When selected, the Time Details group box will be expanded upon accessing the page.</li> </ul>

### Status Bar Default Color Settings

<b>Field or Control</b>	<b>Description</b>
<b>Allow Default Color Override</b>	<p>Select this option to override the colors specified here. Users will use the fluid User Preferences page to override the preference set here.</p>
<b>Reported Theme</b>	<p>Theme selection for reported theme is given with three options of <b>Solid Color</b>, <b>Pattern</b>, and <b>color code</b>.</p>
<b>Scheduled Theme</b>	<p>Theme selection for scheduled theme is given with three options of <b>Solid Color</b>, <b>Pattern</b>, and <b>color code</b>.</p>

<b>Field or Control</b>	<b>Description</b>
<b>Reported over Scheduled Theme</b>	Theme selection for Reported over Scheduled Theme is given with three options of <b>Solid Color</b> , <b>Pattern</b> , and <b>color code</b> .
<b>Reported Color</b>	Select a color or pattern to display for reported time.
<b>Scheduled Color</b>	Select a color or pattern to display for scheduled time.

**Note:** If schedule is not configured then the status bar will not show up irrespective of whether reported time color settings are present.

### Related Links

[Setting Up the Time and Labor Mobile Applications](#)

## My Preferences\_Time and Labor page

Use the My Preferences for Time and Labor (TL\_TR\_PREF\_FLU) to set the preference for different set ups of Time and Labor.

Navigation:

Select Actions List on the header bar.

Select Time and Labor from the left pane. Select **Color Settings** from the right pane.

This example illustrates the fields and controls of the My Preferences\_Time and Labor page.

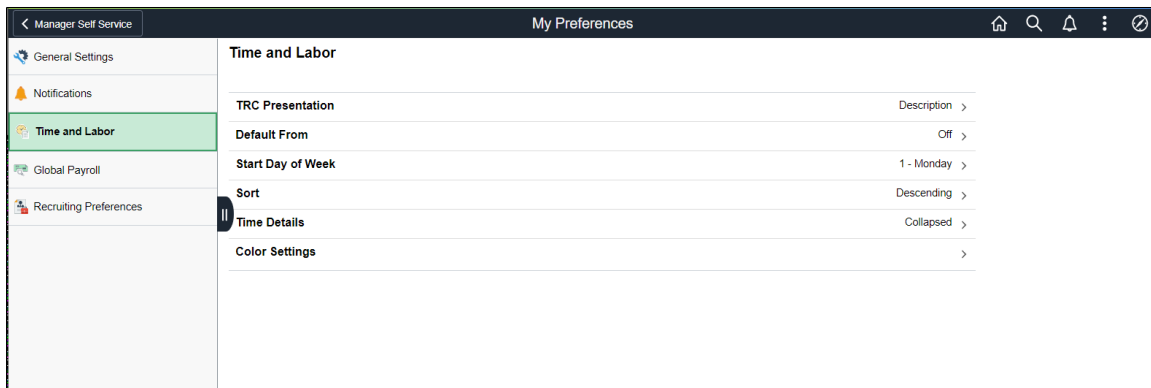

## Color Settings

This example illustrates the fields and controls of the My preferences\_Color Settings page.

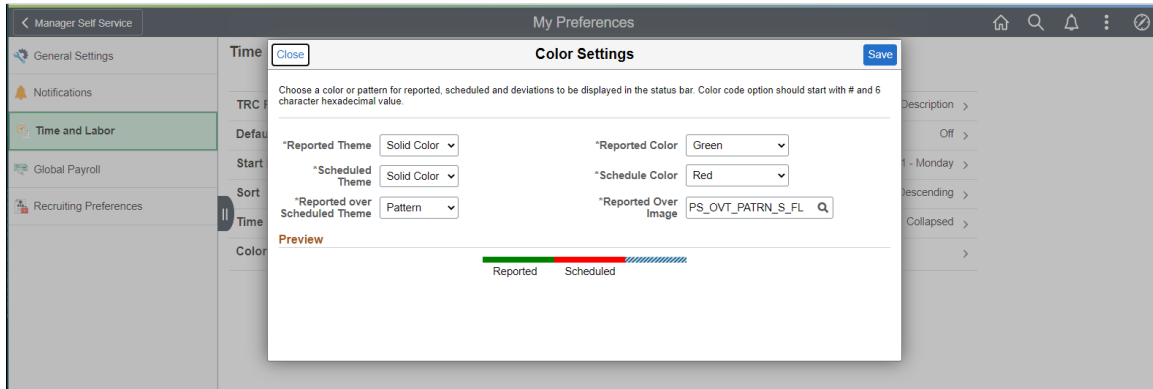

**Note:** This section will not be available for users if the "Allow Default Color Override" check-box is not selected in the TL Installation option.

## Setting Up the Time and Labor Mobile Applications

With PeopleSoft Fluid User Interface and related Mobile Applications functionality, the user can perform the Time and Labor related tasks from a smart phone or a tablet.

The Mobile Applications enable the managers to use a tablet to review time reporting exceptions for their employees. If the employee enables the Global Positioning Service (GPS) in their device, then the managers can view the physical location of their employees.

The Mobile Applications in the Time and Labor allow the managers to use the smart phone or tablet for performing the following tasks:

- View and resolve timecard exceptions
- View employee time reporting location on a map.

Using Mobile Applications, the employee can report both punch and elapsed time from a phone or a tablet. Mobile Applications facilitate the employee to report compensatory time, accrued and compensatory time taken, vacation and sick time. The employee can also view payable time and leave and compensatory balances.

The Mobile Applications in Time and Labour allow the employees to use their smart phone for performing the following tasks:

- Reporting Time
- Reporting Leave and Compensatory Time
- Viewing Reported Time by week or day
- Viewing Payable Time

- Entering User Preferences for defaulting and viewing time data

For more information, see *PeopleTools: PeopleSoft Fluid User Interface Developer's Guide* and *Working with PeopleSoft Fluid User Interface in PeopleTools: Applications User's Guide*.

## Pages Used to Set Up Mobile Applications in Time and Labor

<b>Page Name</b>	<b>Definition Name</b>	<b>Usage</b>
Time and Labor Installation Page	TL_INSTALLATION	Set up general system defaults and activate specific features for the Time and Labor application. Refer Time and Labor Installation section in <a href="#">Setting Up System Defaults and Loading Dates</a>
<a href="#">Workgroup - Definition Page</a>	TL_WRKGRP_DEF	Select Payable Time Range options to define how the time range will be displayed on the Payable Time Summary page.
<a href="#">Workgroup — Approval / Timesheet Control Page</a>	TL_WRKGRP_APPV	Select the Require Employee Sign-Off On Timesheet field to enable a legal statement on all submitted timesheets.
<a href="#">Configurations Page</a>	TL_INSTL_PUNCH	Set up schedule total options, schedule resolution options, and punch pattern defaults for the Time and Labor application.
<a href="#">User Preferences Page</a>	TL_INST_TR_PREF	Use to select the preferences to be rolled out to employees on an individual preference basis. The new User Preferences tab is added to the Time and Labor Installation Components.

## Pre requisites

The Time and Labor Installation page allows the administrators to run the real time rules on Submit when an employee reports time. The values available for the **Real Time Rules** field on the Time and Labor Installation page are:

- Real Time Rules Not Enabled
- Run from Submit button
- Run from Apply Rules button

When **Run from Apply Rules button** is selected on the Installation page, an Apply Rules button will appear on the Timesheet, but it will not appear in the PeopleSoft Fluid User Interface. Select the option **Run on Submit** to enable the run Real Time Rules in PeopleSoft Fluid User Interface, while the employees are submitting the time. When **Real Time Rules Not Enabled** is selected, the rules will not be run on submit.

## Workgroup - Definition Page

Use the Workgroup — Definition Page (TL\_WRKGRP\_APPV) to define how the time range is displayed on the Payable Time Summary screen.

Navigation:

**Main Menu > Set Up HCM > Product Related > Time and Labor > Rules and Workgroups > Workgroup > Definition**

This example illustrates the fields and controls on the Workgroup — Definition Page. You can find definitions for the fields and controls later on this page.

<b>Field or Control</b>	<b>Description</b>
<b>Payable Time Range</b>	<p>There are three options available: <b>Date Range</b>, <b>Pay Period</b> and the <b>Time Period</b>. The default values for the date fields on the Payable Time page is different in each case.</p> <p>For <b>Date Range</b> and <b>Time Period</b>, the default value is for the current Time Period. In case of <b>Pay Period</b>, the default value is for the current Pay Period,</p>

## Workgroup — Approval / Timesheet Control Page

Use Workgroup — Approval / Timesheet Control Page (TL\_WRKGRP\_APPV) to enable a legal statement on all submitted timesheets.



Navigation:

**Main Menu > Set Up HCM > Product Related > Time and Labor > Rules and Workgroups > Workgroup > Approval / Timesheet Control**

This example illustrates the fields and controls on the Workgroup — Approval / Timesheet Control Page. You can find definitions for the fields and controls later on this page.

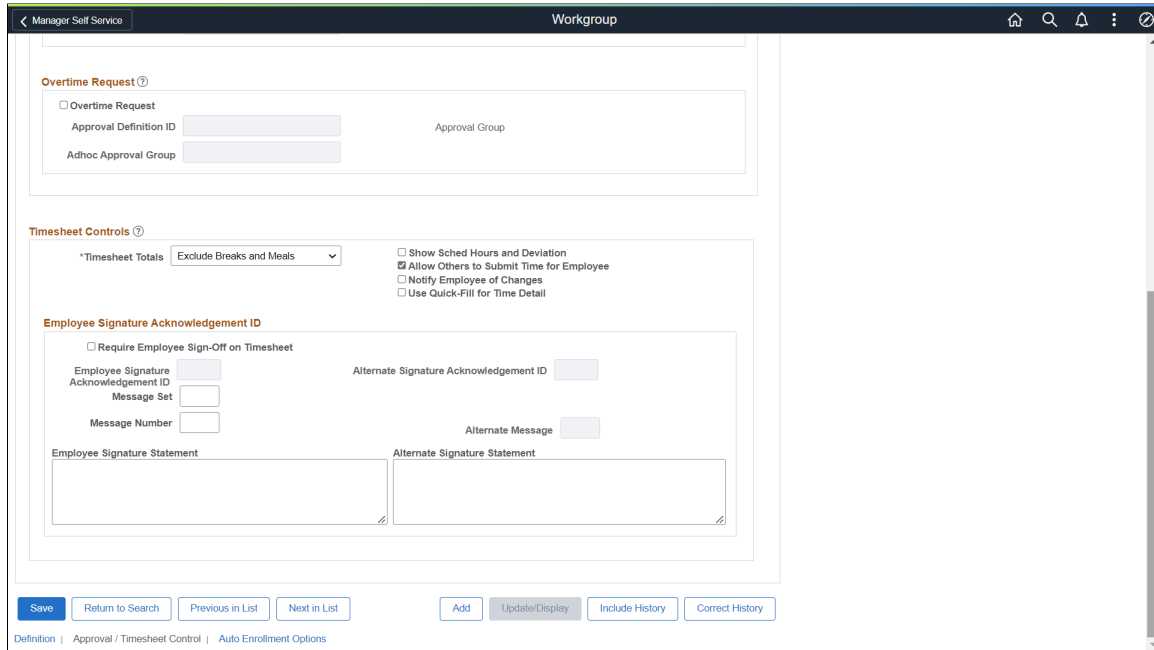

<b>Field or Control</b>	<b>Description</b>
<b>Require Employee Sign-off on Timesheet</b>	When enabled the checkbox, the Employee sign off/ View Legal Statement is enabled for an employee in the Time Reporting Page. Employee sign off is applicable for Timesheet and Report Leave pages.

**Note:** Use the checkbox for **Use Quick-Fill for Time Detail** under Timesheet Controls to enable the Quick fill for time entries. This option is available only when it is enabled at Installation level.

## Configurations Page

Use the Configurations page (TL\_INSTL\_PUNCH) to set up schedule total options, schedule resolution options, and punch pattern defaults for the Time and Labor application. Also use the page to specify the radius of the multiple time reporters from a single location marker.

Navigation:

**Set Up HCM > Install > Product Specific > Time and Labor Installation > Configurations**

This example illustrates the fields and controls on the Time and Labor Installation — Configurations page. You can find definitions for the fields and controls later on this page.

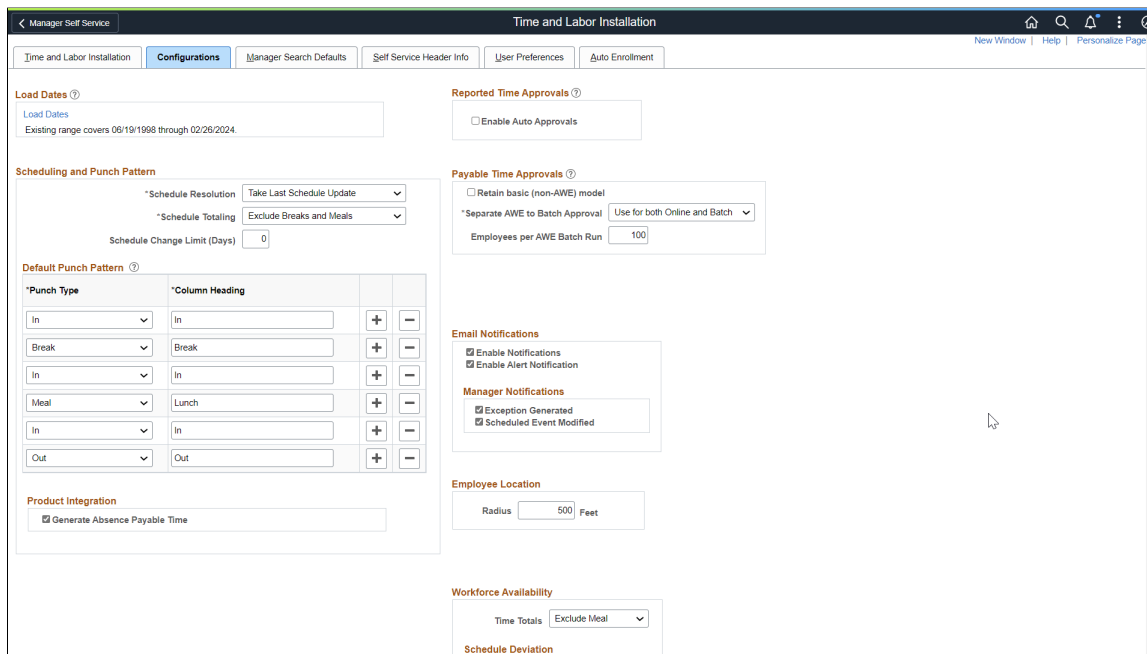

**Important!** This page (TL\_INSTL\_PUNCH) is the same as the “Schedule Settings Page” (PeopleSoft Global Payroll) for Global Payroll and Absence Management. The settings that you define on this page are shared between Time and Labor, Global Payroll, and Absence Management.

When employees report time and have accepted the use of location services in the device which they use, and the system has been enable with the Oracle Maps Service for PeopleSoft on the Installation Table, their location displays on a map on the [Reporting Locations Page](#) . For situations where a single employee is reporting time at the same location a few feet apart, the installation setting groups the reported time into a single marker on the map.

<b>Field or Control</b>	<b>Description</b>
<b>Employee Location</b>	Specify a radius in feet where multiple time reports in that radius are grouped into a single marker. The default setting will be 500 feet. With these settings, any reported time or elapsed time reported within 500 feet are considered as the same location.

**Note:** The map display functionality shown in the HCM features requires a separate license to Oracle Maps Cloud Service for PeopleSoft. For details see the Licensing Information User Manual (LIUM).

## User Preferences Page

Use the Time and Labor Installation page and the related User Preferences tab to allow the administrator to set the preference value for the users.

User Preferences on the mobile devices are made more flexible so that administrators can decide which preferences rolled out to employees on an individual preference basis. The installation settings are made available to all employees using PeopleSoft Fluid User Interface. For more details, refer User Preferences page in [Setting Up System Defaults and Loading Dates](#)

## Roles and Permissions

<i>Role Name</i>	<i>Permission List</i>	<i>Access</i>	<i>Description</i>
TL Manager Time Fluid	HCCPTLSS2000	Exceptions Page Reporting Locations Page	Provides access to the manager self service Exceptions page and the Reporting Locations page.
TL Employee Leave Fluid	HCCPTLSS1135	Report Leave Leave Balances	Provides access to the Base Benefits Leave Balances and to reporting leave for Base Benefits Leave Plan types such as Vacation and Sick.
TL Employee Time Fluid	HCCPTLSS1130	Application Start Page Report Time Weekly Time Payable Time User Preferences	Provides access to the Time and Labor components.

**Note:** In addition to the application specific roles, the Tools PeopleSoft User role is required to access PeopleSoft Fluid User Interface components.

## Payroll System Options

This section discusses how to set up the payroll options, using the Pay System (TL\_PAYSYS\_PNLGRP) component.

### Page Used to Establish Payroll System Options

<i>Page Name</i>	<i>Definition Name</i>	<i>Usage</i>
<a href="#">Pay System Page</a>	TL_PAYSYS_PNL	Establish the payroll system to use and to choose labor distribution and labor dilution.

## Pay System Page

Use the Pay System page (TL\_PAYSYS\_PNL) to establish the payroll system to use and to choose labor distribution and labor dilution.

Navigation:

**Set Up HCM > Product Related > Time and Labor > Time Reporting > Pay System > Pay System**

This example illustrates the fields and controls on the Pay System page. You can find definitions for the fields and controls later on this page

The screenshot shows the 'Pay System' page for 'Pay System NA'. It features a 'Payroll System Definition' section with the following fields and controls:

- \*Description:** Text input field containing 'North American'.
- Short Description:** Text input field containing 'NA Pay'.
- Labor Distribution Used:** A checked checkbox.
- Labor Dilution Used:** A checked checkbox.

At the bottom of the form, there are several action buttons: 'Save', 'Return to Search', 'Notify', 'Add', and 'Update/Display'.

<b>Field or Control</b>	<b>Description</b>
<b>Labor Distribution Used</b>	<p>Clear to disable Time and Labor's labor distribution. The check box is selected by default. When selected, payroll expense is distributed to all applicable Time and Labor earnings and task records. This updated time can then be extracted for additional processing by other applications.</p> <p>If you clear this check box after time has been processed, check for any time that may have currently been labor-distributed.</p>
<b>Labor Dilution Used</b>	<p>Clear to disable Time and Labor's labor dilution feature. The check box is selected by default. When selected, Time and Labor dilutes distribution to account for time that is paid at different rates, and dilutes labor distribution across all hours, regardless of whether an employee was paid for the time.</p> <p>If you clear this check box after time has been processed, check for any time that may have currently been labor diluted. This check box isn't available unless you select the Labor Distribution Used check box. Labor dilution is run within the Labor Distribution process.</p>

### Related Links

[Overview of Payroll Integration](#)

## Establishing Time Periods

To set up time periods, use the Daily Time Period (TL\_FIXED\_DAY\_PNLGR), Weekly (TL\_FIXED\_WEEK\_PNLG), Monthly (TL\_FIXED\_MNTH\_PNLG), Complex (TL\_COMPLEX\_PNLGRP), and Repeating (TL\_REPEAT\_PNLGRP) components.

This section discusses how to set up daily, weekly, monthly, complex and repeating time periods.

### Pages Used to Establish Time Periods

<i>Page Name</i>	<i>Definition Name</i>	<i>Usage</i>
<u>Daily Time Period Page</u>	TL_FIXED_DAY_PNL	Establish a fixed day-type period when building time period calendars.
<u>Weekly Time Period Page</u>	TL_FIXED_WEEK_PNL	Establish weekly periods of time when building time period calendars.
<u>Monthly Time Period Page</u>	TL_FIXED_MNTH_PNL	Establish monthly periods of time when building a time period calendar.
<u>Complex Time Period Page</u>	TL_COMPLEX_PNL	Establish complex periods of time when building a time period calendar. Use this page for periods that cannot be defined by other period definitions.
<u>Repeating Time Period Page</u>	TL_REPEATING_PNL	Establish repeating periods of time when building a time period calendar.

### Daily Time Period Page

Use the Daily Time Period page (TL\_FIXED\_DAY\_PNL) to establish a fixed day-type period when building time period calendars.

Navigation:

**Set Up HCM > Product Related > Time and Labor > Time Periods > Time Periods - Daily > Daily Time Period**

This example illustrates the fields and controls on the Daily Time Period page. You can find definitions for the fields and controls later on this page

### Daily Time Period

Time Period ID PSDAY

**Period Definition**

\*Description  Short Description

\*Period Length in Days

Days Offset from Period End

Save
 Return to Search
 Notify

Add
 Update/Display

<b>Field or Control</b>	<b>Description</b>
<b>Days Offset from Period End</b>	Enter the number of offset days. Offset days are used to derive the start date of the next period instance with respect to the end date of previous instance. Offsets can be positive or negative. The default for offset days is 1.
	<p><b>Note:</b> The only day-type periods you can enter on the Workgroup and Maintain Time Reporter Data page are those with offset days = 1.</p>

### Example: Positive Offset Days

If the offset is a positive number, the next period instance starts after that number of offset days, as the following table illustrates.

<b>Offset Days Number</b>	<b>Original End Date of the First Period</b>	<b>New Instance Start Date for Next Period</b>
1	January 24, 2006	January 25, 2006
2	January 24, 2006	January 26, 2006

### Example: Negative Offset Days

If the offset is a negative number, the system counts backwards from the end of the earlier period instance by the number of offset days to determine the start of the next period instance. Any two consecutive period instances will overlap if the offset is negative. The absolute value of offset days cannot be equal to or greater than the period length. In other words, when the offset days number is negative, the next period cannot start on or before the current period.

To avoid creating a period with an offset equal to or greater than the period length, observe the following rule: *The maximum number of negative offset days cannot exceed the period length minus two.* The

following table illustrates the results of using this rule. Note that if the offset is  $-6$ , it exceeds the maximum number of offset days and the system creates a new period identical to the prior period.

<b>Offset Days Number</b>	<b>Begin and End Dates of the First Period</b>	<b>Begin and End Dates of the Next Period</b>
-6	January 3 - January 9, 2006	January 3 - January 9, 2006
-5	January 3 - January 9, 2006	January 4 - January 10, 2006
-4	January 3 - January 9, 2006	January 5 - January 11, 2006
-3	January 3 - January 9, 2006	January 6 - January 12, 2006

### Example: Creating a Rolling Period with Negative Offset Days

The following page illustrates how to define the offset to create a 90-day, rolling period.

This example illustrates the fields and controls on the Daily Time Period page. You can find definitions for the fields and controls later on this page.

**Daily Time Period**

Time Period ID 90DAYSROLLING

**Period Definition**

\*Description  Short Description

\*Period Length in Days

Days Offset from Period End

To create a rolling period, the negative offset (the value of the **Start Offset from Period End** field) should be two less than the length of the rolling period, which in this example would be  $90 - 2$  ( $-88$ ). If you attempt to use  $-89$ , the system will generate the following error message: "Invalid Value for Offset." The system starts the new period by counting backwards from the day before the end date of the first period. If your first period instance were January 1, 2006 to March 30, 2006, the system would subtract 89 days, beginning from March 29, which would start the next period on January 1. To be a rolling period, the next instance of time should begin one day after the first period instance.

## Weekly Time Period Page

Use the Weekly Time Period page (TL\_FIXED\_WEEK\_PNL) to establish weekly periods of time when building time period calendars.

Navigation:

**Set Up HCM > Product Related > Time and Labor > Time Periods > Time Periods - Weekly > Weekly Time Period**

This example illustrates the fields and controls on the Weekly Time Period page. You can find definitions for the fields and controls later on this page.

Enter the period length in weeks and select a start day for the week.

**Monthly Time Period Page**

Use the Monthly Time Period page (TL\_FIXED\_MNTH\_PNL) to establish monthly periods of time when building a time period calendar.

Navigation:

**Set Up HCM > Product Related > Time and Labor > Time Periods > Time Periods - Monthly > Monthly Time Period**

This example illustrates the fields and controls on the Monthly Time Period page. You can find definitions for the fields and controls later on this page.

<b>Field or Control</b>	<b>Description</b>
<b>Semi-month</b>	Select semi-month for the period length to be 15 days.
<b>Semi-year</b>	Select semi-year for your period length to be 6 months.



<b>Field or Control</b>	<b>Description</b>
<b>User Defined</b>	If you select <b>User Defined</b> , the <b>Period Length in Months</b> field becomes available. Enter the length of the period in months. The maximum number of months you can enter is 999, and the minimum number is 1.

**Note:** When you define a type other than a user-defined month period, the system displays the number of days contained within the period.

## Complex Time Period Page

Use the Complex Time Period page (TL\_COMPLEX\_PNL) to establish complex periods of time when building a time period calendar.

Navigation:

**Set Up HCM > Product Related > Time and Labor > Time Periods > Complex > Complex Time Period**

This example illustrates the fields and controls on the Complex Time Period page. You can find definitions for the fields and controls later on this page.

The screenshot shows the 'Complex Time Period' page for 'Time Period ID KLMCOMPLEX'. It features a 'Period Definition' section with a description '3rd Business Day of Each Month' and a short description '3rd Busine'. Below this is a table titled 'Valid Time Period Date Ranges' with columns for 'Start Date' and 'End Date'. The table contains four rows of dates: 06/05/2000, 05/03/2000, 04/05/2000, and 03/03/2000. Each row has a calendar icon and a plus/minus button. At the bottom, there are buttons for 'Save', 'Return to Search', 'Notify', 'Add', and 'Update/Display'.

Use this page for periods that cannot be defined by other period definitions.

Use the fields on this page to enter a start and end date for the time period.

**Note:** Complex periods are not created through the standard calendar build process; instead, they are created manually when you define the period on this page.

## Repeating Time Period Page

Use the Repeating Time Period page (TL\_REPEATING\_PNL) to establish repeating periods of time when building a time period calendar.

Navigation:

**Set Up HCM > Product Related > Time and Labor > Time Periods > Repeating > Repeating Time Period**

This example illustrates the fields and controls on the Repeating Time Period page. You can find definitions for the fields and controls later on this page.

**Repeating Time Period**

Time Period ID KUTPRPT

**Period Definition**

*Description	<input type="text" value="First Tuesday Repeating"/>	Short Description	<input type="text" value="First Tue"/>
Period starts on	<input type="text" value="01st"/>		
*Start Day	<input type="text" value="2-Tuesday"/>		
*Frequency	<input type="text" value="Every Month"/>		
*Period Length in Days	<input type="text" value="7"/>		

Save
 Return to Search
 Notify

Add
 Update/Display

<b>Field or Control</b>	<b>Description</b>
<b>Period starts on</b>	<p>Repeating periods can be defined in any number of ways. To define a repeating period, follow these steps:</p> <ol style="list-style-type: none"> <li>1. In the <b>Period Starts on</b> fields, enter either a number from 1 through 31 or the designation <i>Last</i> and then a day of the week (<i>Monday</i> through <i>Sunday</i>) or the term <i>Day</i>. For example: <i>Last Sunday . . .</i></li> <li>2. In the <b>Of</b> field, enter <i>Every</i> or <i>Every Other</i>. For example: <i>Last Sunday of Every . . .</i></li> <li>3. Select <i>Month</i> or <i>Week</i> from the next drop-down list to complete the definition of your period. For example: <i>Last Sunday of Every Month</i>.</li> <li>4. Enter the duration of the period in the <b>Period Length in days</b> field. If you enter 2 in this field, the repeating period in this example would last two days beginning with the last Sunday of the month.</li> </ol> <p>To ensure that you have the expected results, check the time period calendar by selecting the View Time Period Calendar page after building the period using the Build Time Period Calendar process.</p>

<i>Field or Control</i>	<i>Description</i>
<b>Period Length in Days</b>	Enter the number of days in your period. The maximum you can enter is 999.

## Setting Up Planned Overtime Features

To set up planned overtime, use the Overtime Limit (TL\_OT\_SETUP) and the Workgroup (TL\_WKG\_MAIN\_PNLGRP) components. Use the TL\_WKG\_MAIN\_PNLGRP component interface to load data into the tables for this component.

This section discusses optional features of the overtime request transactions.

## Pages Used to Set Up Overtime Features

<i>Page Name</i>	<i>Definition Name</i>	<i>Usage</i>
<u>Overtime Limit Page</u>	TL_OT_SETUP	Define overtime limits for a set of TRCs. Also identify the TRCs for which you want to track overtime balances. You must define the value list that includes the TRCs first.
<u>Overtime TRC Value List Page</u>	TL_OT_VAL_LIST_SEC	Displays the Time Reports Codes (TRCs) that make up a selected value list.
<u>Workgroup Page</u>	TL_WRKGRP_PNL	Assign an overtime limit definition to a workgroup.

### Related Links

[Managing Overtime Requests](#)

[Understanding Manager Self-Service Components](#)

## Prerequisites

To establish overtime limits or maintain overtime balances by period, you create *value lists* to identify the sets of Time Reporting Codes (TRCs) to which the limits or balances apply. For example, to limit the combined number of overtime hours permitted for TRC1 and TRC2, you create a value list that includes these two TRCs.

Use the Value List page to create one or more value lists for your overtime TRCs.

---

**Important!** Because you assign overtime limits to workgroup, be sure that the TRCs in your value lists are also included in the workgroup's TRC program.

---

## Related Links

[Creating Value Lists](#)

[Understanding Workgroups](#)

## Overtime Limit Page

Use the Overtime Limit page (TL\_OT\_SETUP) to define overtime limits for a set of TRCs. Also identify the TRCs for which you want to track overtime balances. You must define the value list that includes the TRCs first.

Navigation:

**Set Up HCM > Product Related > Time and Labor > Time Reporting > Overtime Limit > Overtime Limit**

This example illustrates the fields and controls on the Overtime Limit page. You can find definitions for the fields and controls later on this page.

<b>Field or Control</b>	<b>Description</b>
<b>Overtime Limit ID</b>	Displays the unique ID for the overtime limit definition. IDs can contain up to eight alphanumeric characters.

## Overtime Limit and Balance Attributes

Complete the following fields to designate the TRCs for which you want to set overtime limits and/or track overtime balances.

<b>Field or Control</b>	<b>Description</b>
<b>Status</b>	<p>Select the status of the Overtime Limit ID: <i>Active</i> or <i>Inactive</i>.</p> <hr/> <p><b>Note:</b> You cannot inactivate an overtime limit definition that is associated with an active workgroup. To inactivate the limit definition, first remove it from the Workgroup page. (You can query the Workgroup table to find out which workgroups are associated with an overtime limit definition).</p> <hr/>
<b>Time Period</b>	<p>Select the time period for managing overtime limits and balances. For example, if you select monthly, the system tracks the number of overtime hours for the month. If you also set a limit of 10 hours, this limit applies to each month.</p> <p>Repeating and complex time periods are not allowed.</p> <p>See <a href="#">Establishing Time Periods</a>.</p>
<b>OT TRC List</b>	<p>Select the value list that includes the overtime TRCs for which you are defining limits and/or tracking balances.</p>
<b>View List</b>	<p>Click to view the list of TRCs that are members of the value list selected in the <b>OT TRC List</b> field.</p>

### Overtime Limits

Define the overtime limits in this group box. If you base overtime limits on months of service, add a row for each term of service that has a different overtime limit.

<b>Field or Control</b>	<b>Description</b>
<b>After Service Months</b>	<p>To base overtime limits on an employee's number of months of service, enter the number of months here. Enter whole numbers only. If you do not want to link overtime limits to months of service, leave the default value of 0 (zero) in this field.</p> <hr/> <p><b>Note:</b> The system refers to the employee's Service Date on the Employment record to determine months of service. Because service dates can be defined for employees only, the system cannot calculate overtime balances or apply overtime limits for non-employees.</p> <hr/>

<i>Field or Control</i>	<i>Description</i>
<b>Period Overtime Hours Limit</b>	Enter the maximum number of overtime hours that employees are allowed to work during the time period defined in the <b>Time Period</b> field. If you entered a non-zero value in the <b>After Service Months</b> field, the limit you enter here represents the number of overtime hours permitted for employees who have met the service requirement. If you entered zero in the <b>After Service Months</b> field, the limit you enter here applies to all employees.

### Example 1: Defining Overtime Limits without Service Dates

Assume that employees can work a maximum of 25 hours of overtime each month. The values you enter are as follows:

<i>After Service Months</i>	<i>Period Overtime Hours Limit</i>
0	25

### Example 2: Defining Overtime Limits with Service Dates

Assume that employees must complete 12 months of service before working any overtime and after that can work a maximum of 20 hours of overtime each month. After 24 months of service, employees can work a maximum of 50 hours of overtime each month. In this case, the values that you enter are as follows:

<i>After Service Months</i>	<i>Period Overtime Hours Limit</i>
12	20
24	50

## Overtime TRC Value List Page

Use the Overtime TRC Value List page (TL\_OT\_VAL\_LIST\_SEC) to displays the Time Reports Codes (TRCs) that make up a selected value list.

Navigation:

Click **All Test OT Values** on the Overtime Limit page.

This example illustrates the fields and controls on the Overtime TRC Value List page. You can find definitions for the fields and controls later on this page.

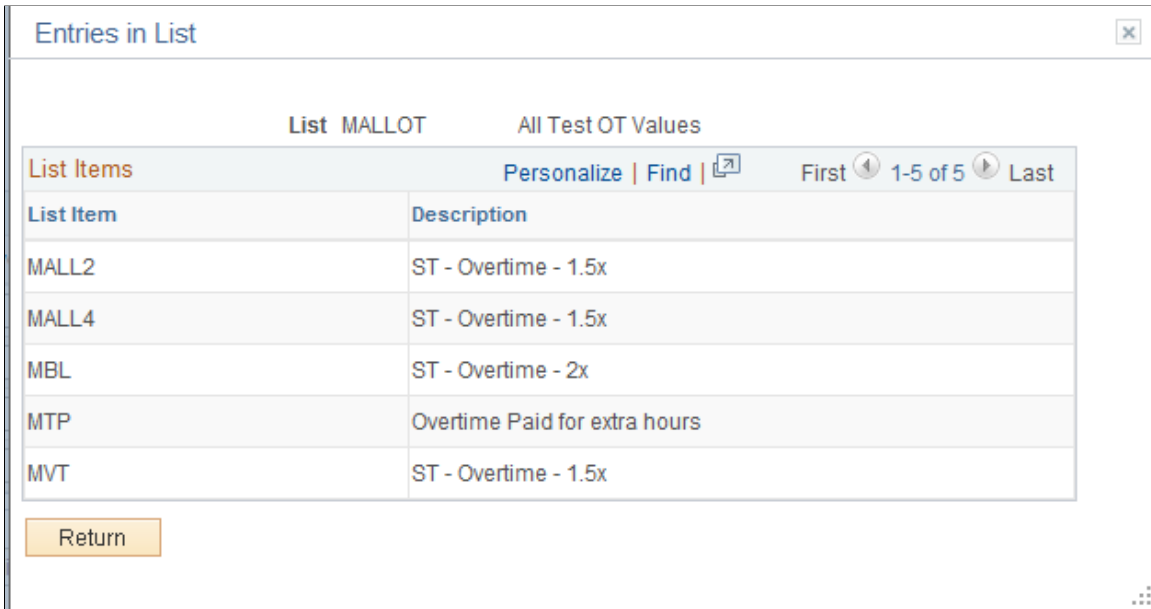

Field or Control	Description
Value Group	Displays the names of TRCs within the value list selected in the <b>OT TRC List</b> field on the <b>Overtime Limit</b> page.

## Workgroup Page

Use the Workgroup page (TL\_WRKGRP\_PNL) to assign an overtime limit definition to a workgroup.

Navigation:

**Set Up HCM > Product Related > Time and Labor > Rules and Workgroups > Workgroup > Workgroup**

In the **Overtime Limit ID** field (within the Compensation Controls group box), select the ID for the overtime limit definition that applies to the members of the workgroup.

---

**Note:** Overtime limit assignments are effective-dated. A workgroup can have more than one effective-dated row of overtime limits.

---

### Related Links

[Understanding Workgroups](#)

## Enabling Workflow

Time and Labor uses workflow functions, such as approvals workflow. Approvals workflow takes a request entered by an employee and routes it to an approver to accept or deny. If the request is denied, the

system notes that the request was denied. Employees and managers can view the approval status of some requests with self-service transactions.

---

**Note:** For Request Overtime, the employee's manager is the only person who is required to approve overtime requests.

---

To enable workflow:

1. Ensure that the appropriate roles are associated with user profiles.

Roles define what the user can and can't access in the system. Use the Roles page in the User Profiles component to review the roles and update as necessary. Manager profiles should include roles for Manager and Worklist User. Employee profiles should include an Employee role. Instructions for using the Roles page are provided in the *PeopleTools 8.52: Security Administration PeopleBook*.

2. Specify which types of routings each role user can receive.

Use the Workflow page in the User Profiles component to specify where the system can deliver work items: to a worklist or an email mailbox. For Time and Labor, worklist, email, or both are appropriate for managers; email is appropriate for employees. Instructions for using the Workflow page are provided in the *PeopleTools 8.52: Security Administration PeopleBook*.

3. Define the rules for workflow notifications by SetID.

Use the System Workflow Rules page to define how users are to receive notifications: email, worklist, both, no notification, or user-defined preference. The system can notify employees by email when a request is submitted, approved, or denied; it can notify managers by worklist, email, or both when requests are submitted for approval.

---

**Note:** Oracle PeopleSoft delivers Notification Composer Framework to manage the setup and administration of all notifications in one central location.

Once you have adopted the Notification Composer feature, you must use it to create new notifications and manage your existing notifications.

Notifications delivered with HCM Image 47 or later must use Notification Composer.

For more information about Notification Composer Framework, see “Understanding Notification Composer” (Enterprise Components).

---

Procedures are provided in the *PeopleSoft HCM Application Fundamentals PeopleBook* and the *PeopleTools 8.52: Workflow Technology PeopleBook*.

See “Using Workflow with Self-Service Transactions” (Application Fundamentals)

4. Activate workflow for the HCM system, if not already activated.

Use the Worklist System Defaults page and the Workflow User Preferences page.

Procedures are provided in the *PeopleSoft HR Application Fundamentals PeopleBook*.

See “Using Workflow with Self-Service Transactions” (Application Fundamentals).

See the product documentation for *PeopleTools: Workflow Technology*.



## Building and Viewing Time Period Calendars

To set up time and view period calendars, use the Build Time Period Calendar (TL\_RCTRL\_CAL\_PG) and the View Time Period Calendar (TL\_CALND\_VW\_PNLGRP) components.

This section discusses how to build and view time period calendars.

### Pages Used to Build and View Time Period Calendars

<i>Page Name</i>	<i>Definition Name</i>	<i>Usage</i>
<u>Build Time Period Calendar Page</u>	TL_RCTRL_CAL_PNL	Create instances of a time and labor calendar that will include each of your period start and end dates.
<u>View Time Period Calendar Page</u>	TL_CALENDAR_VW_PNL	View the time period instances for each calendar.

### Understanding General Rules for Building Periods and Calendars

This section contains important information on how to build calendars to insure that:

- The system defines the correct period of interest for rules processing.
- The data in Payable Time is what you expect it to be.

---

**Important!** To understand the information in this section, you must be familiar with the material in Understanding Batch Processing in Time Administration and Creating Rules in Time Administration.

---

#### Building Calendars

Build calendars for the following time periods:

- The entire period for which you intend to report time.
- The entire span of time on which rules may be run.

In the Time Administration process, if gaps exist in time reporting periods or the calendar connected with a rule, the system may select a much greater period of interest than necessary, and the schedule resolve process may end up resolving a larger range of dates than necessary. This can significantly reduce performance time.

The Time Administration process determines the period of interest by looking at both the time reporting period—identified by the time period ID for the workgroup—and the time period ID associated with each rule. The time reporting period establishes the initial period of interest, while the rule period helps to determine how far into the past (or into the future) the Time Administration process may need to go to capture the data needed for rules processing.

*Example:* Building Calendars

Assume that there is a rule program containing a weekly rule and a biweekly rule with the following priority ranking:

<b>Rules</b>	<b>Rule Priority</b>	<b>Periods</b>
Rule 1	Priority 1	Weekly
Rule 2	Priority 2	Biweekly

Assume that you have calendars for the following periods:

<b>Calendar Builds for the Weekly Period</b>	<b>Calendar Builds for the Biweekly Period</b>
2000	2000
2005	No Calendar Build for 2005
2006	2006

In this example, if you process rules for a period that ends on January 7, 2006 but starts December 15, 2005, you will extend the period of interest back to 2000, since no calendar exists for the biweekly rule in 2005, and both the weekly and biweekly rules must be run. Assuming that you are processing a group of exception reporters, the schedule resolve process would resolve time back to 2005 (time for exception reporters is based on time schedules unless there is an exception to the schedule).

If you have not built calendars for the periods used to determine the period of interest (the period ID connected with the workgroup and the rule), you may receive the following message when running the Time Administration process:

This example illustrates the message displayed when running the Time Administration process if you have not built calendars for the period ID connected with the workgroup and the rule.

**Explain**

**Message:**  
Please verify that all time periods have been built for all rules being processed.

**Description:**  
Some rules have not been included in the rule map. One of the reasons is due to missing entries in the time period calendar table (TL\_CALENDAR).

[Return](#)

In most cases when this message is reported, a period calendar has either not been built for a period ID or the calendar has not been built far enough into the past or future for all period IDs associated with the time reporters being processed through the Time Administration process.

## Building a Complete Calendar

To avoid the problems described in this example, do the following:

1. Determine all of the period ID's associated with the time reporters to process through the Time Administration process. Period ID's are associated with:
  - Workgroups
  - Rules
2. Determine the maximum and minimum dates among the following:
  - The Process Date on the Process Time Admin Page.
  - The DUR (date under report) in TL\_RPTD\_ELPTIME.
  - The PUNCH\_DTTM in TL\_RPTD\_PCHTIME.
3. Determine where the minimum date found in step two intersects the time reporting period for the workgroup to process.

Build the calendar at least as far into the past as the start of this period. And if this minimum date intersects a rule period belonging to a rule in the workgroup's rule program, and the rule requires time data from before the workgroup period, build the calendar as far into the past as the final period of interest start date.

4. Determine where the maximum date found in step two intersects the time reporting period for the workgroup to process.

Build the calendar at least as far forward into the future as the end of this period. And if this maximum date intersects a rule period belonging to a rule in the workgroup's rule program, and the rule requires time data from days following the workgroup period, build the calendar as far into the future as the end of the rule period.

## Override Indicator Set to OFF

If you rebuild your calendar with the override indicator set to OFF, and period instances already exist within the start and end dates of the calendar, the system will not alter the existing period instances within these dates. If you create new time periods, the system adds them to the existing ones.

---

**Note:** To change the definition of an existing period, you must set the override indicator to *ON* and rebuild the entire calendar using the new period definition.

---

To preserve your current period definitions, but change the start and end dates of the calendar, set the override indicator to *OFF*, change the begin and end dates, and rerun the Calendar Build process. The following criteria apply:

- If the new start and end dates fall within or are equal to the old dates, the system builds new period instances.
- If the new start date is less than the first calendar's start date, and the end date is the same as or less than the first calendar's start date, new period instances are built backwards in time, beginning with the old start date.

*Example 1: Override Indicator Set to OFF*

<b>Term</b>	<b>Definition</b>
<b>Original Calendar Dates:</b>	January 1, 2000 – December 31, 2000
<b>New Calendar Dates:</b>	December 15, 1999 – December 31, 2000

The end dates are identical; however, the start dates are different. The new start date is December 15, 1999; the old start date is January 1, 2000. The system will create new period instances from December 31, 1999 to December 15, 1999. If the new end date is later than the old end date, and the new start date is the same as or greater than the old start date, the system builds new period instances going forward from the last end date.

*Example 2: Override Indicator Set to OFF*

<b>Term</b>	<b>Definition</b>
<b>Original Calendar Dates:</b>	January 1, 2000 – December 31, 2000
<b>New Calendar Dates:</b>	January 1, 2000 – February 15, 2001

The start dates are identical; however, the end dates are different. The new end date is February 15, 2001; the old end date is December 31, 2000. The system builds new period instances going forward from the old end date. If both the new start and end dates are outside the range of the old start and end dates, the system builds new period instances. It will move backwards from the old start date until it reaches the new start date, and forward from the old end date until it reaches the new end date.

*Example 3: Override Indicator Set to OFF*

<b>Term</b>	<b>Definition</b>
<b>Original Calendar Dates:</b>	January 1, 2000 – December 31, 2000
<b>New Calendar Dates:</b>	December 15, 1999 – February 15, 2001

The new calendar expands the date range of the old calendar in two directions. The system builds new periods backwards from December 31, 1999 to December 15, 1999, and forwards from January 1, 2001 to February 15, 2001.

---

**Note:** For daily, weekly and monthly period types, if the override indicator is set to *OFF*, the system does not alter existing records. But for repeating periods, records are always deleted, irrespective of the value of the override indicator.

---

**Note:** Because complex periods are not created through the standard calendar build process—they are created when you define the period on the Complex Time Period page—they must be extended or shortened to change the start and end dates of these periods.

---

## Override Indicator Set to ON

If you rebuild a calendar with the override indicator set to *ON*, the system deletes all records from the new start date onwards and rebuilds the calendar as if no period instances existed for the new calendar period. No period instance for dates prior to the new start date are altered.

---

**Note:** For daily, weekly, and monthly period types, if the override indicator is set to *ON*, the system deletes all records from the new start date onwards. But for repeating periods, records are always deleted, irrespective of the value of the override indicator.

---

**Note:** Because complex periods are not created through the standard calendar build process—they are created manually when you define the period on the Complex Time Period page—they must be manually readjusted rather than "rebuilt" to change the start and end dates of these periods.

---

## Creating Payable Time

*Important!* If you are unfamiliar with the concept of payable time, review the section on Understanding Batch Processing in Time Administration before reading the following section.

Payable time is created through the interaction between the schedule calendar, time reporting periods, and rule periods. Compare the work schedule calendar to the workgroup and rule periods to ensure that the start and end dates of these periods are correctly aligned. If the periods are incorrect, you could end up creating Payable Time on different days than you expected. This is illustrated in the example below:

*Example:* Creating Payable Time

Assume the following:

- You are processing a workgroup containing exception reporters.
- The workgroup period should specify a begin date of Monday, June 5 and an end date of Sunday, June 11. By mistake, you defined a period ID for the workgroup that specifies a begin date of Tuesday, June 6 and end date of Monday, June 12.
- There are two rules defined for the workgroup—a daily rule and a weekly rule. The period ID for the weekly rule specifies that the rule period begins on Monday, June 5 and ends Sunday, June 11. The rule period is consequently out of sync with the period ID on the workgroup.
- The earliest change date is Tuesday, June 6.

This example illustrates the interaction of time reporting periods, rule periods and calendar.

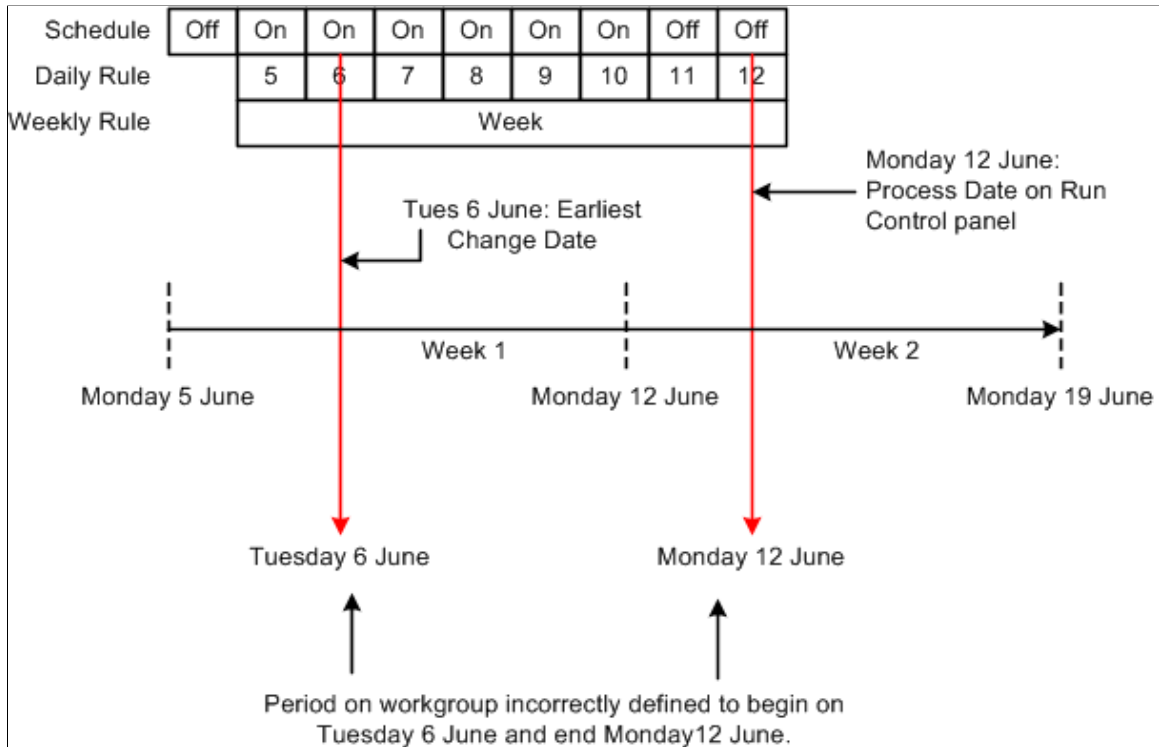

In this example the Time Administration process passes all the dates from June 6 to 12—the current workgroup period—to Payable Time. Assuming that the weekly rule in our example generates new time data for June 5—a date just outside the current workgroup period—we end up with a Payable Time date range of June 5 to 12. By contrast, the correct period ID for the workgroup would have produced a Payable Time date range of Monday June 5 to Sunday June 11. Note that the calendar schedule for these date ranges results in different data being sent to Payable Time. Using the incorrect time reporting period, the schedule indicates two days off. Using the correct time reporting period, the schedule indicates only one day off. As you can see, it is important to understand the relation between time reporting periods, rule periods, and the schedule calendar, because they all work together to create Payable Time.

See the product documentation for *PeopleTools PeopleSoft Process Scheduler*

**Related Links**

[Understanding the Time Administration Process Flow](#)

**Build Time Period Calendar Page**

Use the Build Time Period Calendar page (TL\_RCTRL\_CAL\_PNL) to create instances of a time and labor calendar that will include each of your period start and end dates.

Navigation:

**Set Up HCM > Product Related > Time and Labor > Time Periods > Build Time Period Calendar > Build Time Period Calendar**

This example illustrates the fields and controls on the Build Time Period Calendar page. You can find definitions for the fields and controls later on this page.

### Build Time Period Calendar

Run Control ID PS Report Manager
Process Monitor
Run

Calendar Build Parameters

\*Start Date  Thursday

\*End Date  Wednesday

If built beyond Start Date

Delete and Rebuild Calendar

Weekly Weekday not Start Date

Start Before Start Date

\*Time Period Selection  ▼

Save
 Notify

Add
 Update/Display

<b>Field or Control</b>	<b>Description</b>
<b>Delete and Rebuild Calendar</b>	<p>Select to enable the system to override any existing calendar with a new one containing different or redefined periods. If this field is deselected, the system leaves any existing period instances built in place and allows you to insert new ones by modifying the calendar build scope. This enables you to update the calendar created by the system during the build process without recreating the entire calendar from scratch.</p> <hr/> <p><b>Note:</b> If you change the definition of an existing period--for example, you change the start date of a weekly period from Sunday to Monday--select the <b>Delete and Rebuild Calendar</b> check box and build a new calendar. Be aware that redefining a period used in rules processing will trigger Referential Integrity and cause payable time to be reevaluated. Therefore, if the time period you rebuild alters the period instances in a rule, any reported or payable time affected by the change is recalculated in Time Administration. If Payable Time that has been frozen is affected, the Time Administration process creates offsets for the changes.</p>

<b>Field or Control</b>	<b>Description</b>
<b>Start Before Start Date</b>	This applies only to weekly time periods and allows resetting the calendar start date when the start date bisects a period instance. For example, assume the calendar start date is January 1, 2000. You've defined a weekly period that begins on Monday. January 1 falls on a Saturday, which means that the week overlaps the start date. This is illustrated below:

This example illustrates a weekly period that begins prior to the calendar start date.

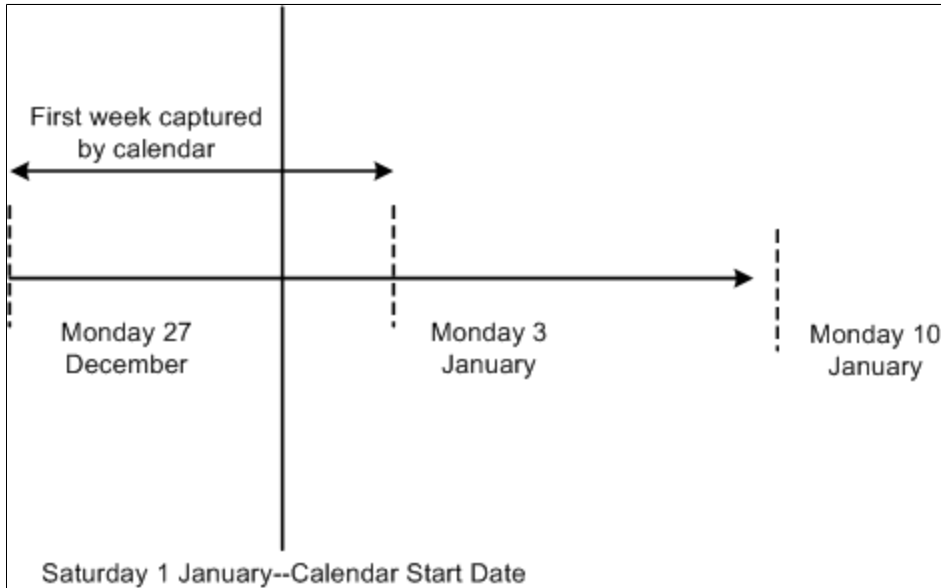

In the diagram above, the first weekly period captured by the calendar begins Monday December 27 — 4 days before the calendar start date. In this situation, specify whether the calendar should begin on the Monday before the specified calendar start date, or on the first Monday that falls within the calendar period. If you select **Use Prior Week Start Day**, the calendar begins before the initially specified start date (on December 27 in this example). If the **Use Prior Week Start Day** check box is cleared, then the calendar begins on the following Monday (January 3 in this example).

---

**Note:** You do not have to build the time period calendar at this time. Set up the rest of your time and labor system (workgroups and taskgroups), then build the time period calendar. The time period calendar must be built prior to reporting time, running the Time Administration process, or tracking attendance.

---



<b>Field or Control</b>	<b>Description</b>
<b>Time Period Selection</b>	<p>Select a time period. The scope enables you to include or exclude specific periods or period types from the calendar build process. Valid values are:</p> <p><i>All Time Periods.</i> Select to choose all time period types. The system uses all time periods entered. The time Period Type and Time Period ID are not available or displayed.</p> <p><i>Listed Period Definitions.</i> Select to indicate which periods to use on an ad hoc basis. When this is selected, the Time Period ID becomes available. Add more periods by inserting additional rows in the Time Period ID region.</p> <p><i>Listed Period Types.</i> When this field is selected, the <b>Period Type</b> field becomes available in the <b>Time Periods</b> region. You can choose from daily, weekly, monthly, or repeating period types.</p> <hr/> <p><b>Note:</b> Complex period types are never included in the <b>Time Period Selection</b> field because the calendar build process does not generate complex period instances. They are created when you define a complex period on the Complex Time Period Page.</p> <hr/>

## View Time Period Calendar Page

Use the View Time Period Calendar page (TL\_CALENDAR\_VW\_PNL) to view the time period instances for each calendar.

Navigation:

**Set Up HCM > Product Related > Time and Labor > Time Periods > View Time Period Calendar > View Time Period Calendar**

This example illustrates the fields and controls on the View Time Period Calendar page. You can find definitions for the fields and controls later on this page.

### View Time Period Calendar

**Time Period Calendar**

Time Period ID PSWEEK  
 Description Weekly Period - PS Delivered  
 Period Type Weekly

**Calendar Dates** Personalize | Find | View 100 | First 1-10 of 1409 Last

Start Date	Start Day	End Date	End Day
12/26/2016	Monday	01/01/2017	Sunday
12/19/2016	Monday	12/25/2016	Sunday
12/12/2016	Monday	12/18/2016	Sunday
12/05/2016	Monday	12/11/2016	Sunday
11/28/2016	Monday	12/04/2016	Sunday
11/21/2016	Monday	11/27/2016	Sunday
11/14/2016	Monday	11/20/2016	Sunday
11/07/2016	Monday	11/13/2016	Sunday
10/31/2016	Monday	11/06/2016	Sunday
10/24/2016	Monday	10/30/2016	Sunday

Use the scroll arrows to move up and down the list of the start and end dates on the Time and Labor View Page.

## Setting Up Manager Time Calendar View Options

To set up manager time calendar views, use the Calendar View Options (TL\_WV\_OPTIONS) component.

This section provides an overview of manager calendar views and describes how to set up manager time calendar view options.

### Pages Used to Set Up Calendar Viewing Options

<i>Page Name</i>	<i>Definition Name</i>	<i>Usage</i>
<a href="#">Calendar View Options Page</a>	TL_WV_OPTIONS	Define viewing options for calendars.

<b>Page Name</b>	<b>Definition Name</b>	<b>Usage</b>
<a href="#">Preview Legend Page</a>	TL_WV_LEGEND_SEC	View a sample of the legend that will appear at the bottom of the calendar viewing pages as defined by the current selected colors and symbols.
TRC List Page	TL_VALUE_LIST_SEC	View a list of the TRC value groups and descriptions contained in the selected TRC list.

## Understanding Manager Time Calendar Views

Manager calendar views provide assistance to managers in allocating workforce resources. The self-service manager calendar view pages enable the manager to view a group of employees and all their time-related information for a specific timeframe on one page. This calendar view offers up-to-the-minute information on group schedules and time related events. The information displayed on the manager calendar view depends on the selections made while setting up the calendar viewing options. The calendar viewing option setup applies to all calendar view pages. In designing your calendar views you decide what information managers can choose to display for work days and off days as well as training, absences, overtime and holidays. You also determine which TRCs will be associated with the calendar views.

Managers use the time calendars to determine how resources are currently allocated and how to adjust resources for maximum productivity and profitability. Managers can respond quickly to changing scheduling needs and employee requests. Managers can also view prior periods to assess past scheduling effectiveness and resource allocation.

Each calendar page displays the selected information on a grid. This information is viewable on a daily, weekly or monthly calendar schedule and provides drill down capability to view lower level details. The time calendar page displays the selected information using predetermined color codes to differentiate the data.

## Prerequisites

Before setting up Time and Labor manager calendar viewing options, you must define time reporting codes and create TRC Value lists. Employee group definitions must also be defined to enable calendar viewing.

### Related Links

[Understanding Time Reporting Codes](#)

## Calendar View Options Page

Use the Calendar View Options page (TL\_WV\_OPTIONS) to define viewing options for calendars.

Navigation:

**Set Up HCM > Product Related > Time and Labor > Calendar View Options > Calendar View Options**

This example illustrates the fields and controls on the Calendar View Options page (1 of 2). You can find definitions for the fields and controls later on this page.

### Calendar View Options

**Calendar Option Details**

Display Symbols Absence Default Workday Hours  [Preview Legend](#)

Reported/Payable Time Personalize | [?](#) First 1-5 of 5 Last

*TRC List	Description	*Priority	*Color	Symbol
<input type="text" value="KUCOMP"/>	Comp Time TRCs	<input type="text" value="76"/>	Brown	<input type="text" value="CMP"/>
<input type="text" value="KUHOLIDAY"/>	Holiday TRC	<input type="text" value="73"/>	Green	<input type="text" value="FLT"/>
<input type="text" value="KUOVERTIME"/>	Overtime TRCs	<input type="text" value="38"/>	Orange	<input type="text" value="OT"/>
<input type="text" value="KUTRCVL1"/>	Regular	<input type="text" value="75"/>	Tan	<input type="text" value="REG"/>
<input type="text" value="KUVACATION"/>	Vacation TRC	<input type="text" value="74"/>	Red-Violet	<input type="text" value="VAC"/>

**Time Option**

Time Option	*Priority	*Color	Symbol
Default Reported/Payable Time	<input type="text" value="99"/>	Violet	<input type="text" value="RPT"/>

This example illustrates the fields and controls on the Calendar View Options page (2 of 2). You can find definitions for the fields and controls later on this page.

### Scheduled Time and Exceptions

Schedule Category	Display	Priority	Color	Symbol
Workday	<input checked="" type="checkbox"/>	<input type="text" value="95"/>	Gray	<input type="text" value="WRK"/>
Off Day	<input checked="" type="checkbox"/>	<input type="text" value="90"/>	Light Gray	<input type="text" value="OFF"/>
Approved Training	<input checked="" type="checkbox"/>	<input type="text" value="40"/>	Blue	<input type="text" value="ATN"/>
Requested Training	<input checked="" type="checkbox"/>	<input type="text" value="45"/>	Light Blue	<input type="text" value="RTN"/>
Approved Absence	<input checked="" type="checkbox"/>	<input type="text" value="20"/>	Yellow	<input type="text" value="AAB"/>
Requested Absence	<input checked="" type="checkbox"/>	<input type="text" value="25"/>	Light Yellow	<input type="text" value="RAB"/>
Approved Overtime	<input checked="" type="checkbox"/>	<input type="text" value="30"/>	Green	<input type="text" value="AOT"/>
Requested Overtime	<input checked="" type="checkbox"/>	<input type="text" value="35"/>	Light Green	<input type="text" value="ROT"/>
Holidays	<input checked="" type="checkbox"/>	<input type="text" value="15"/>	Pink	<input type="text" value="HOL"/>
Exceptions	<input checked="" type="checkbox"/>	<input type="text" value="10"/>	Red	<input type="text" value="EXC"/>

Save

<b>Field or Control</b>	<b>Description</b>
Display Symbols	<p>Select the <b>Display Symbols</b> to assign symbols to TRCs and time events. If selected, the symbols overlay the color for the associated TRC or time event on the calendar. This option is selected by default. Clear the check box to deselect this option.</p> <hr/> <p><b>Note:</b> The time calendar pages allow the option of displaying symbols when this option is selected. If this box is not selected on the Calendar View Options setup page, users will not have this option on the time calendar viewing pages.</p>

<b>Field or Control</b>	<b>Description</b>
Preview Legend	Click to display an explanatory list of the colors and symbols that have been selected to display on the time calendar pages. While building the calendar viewing options, click this link to view the legend with the colors and symbols selected at the time.
Maximum Time Reporters Shown	Define the maximum number of time reporters to display on screen.  <b>Note:</b> The maximum number of time reporters shown cannot exceed fifteen.
Absence Default Workday Hours	Define the number of hours to display for a requested or approved absence when: <ul style="list-style-type: none"> <li>no hours have been reported.</li> <li>the requested/approved day is an "Off" day on the schedule.</li> <li>the employee doesn't have a schedule.</li> </ul> The system displays this number if one or more of the reasons above are valid. The system displays half the number of the defined hours if the requested/approved absence is for a half day.

### Reported/Payable Time

<b>Field or Control</b>	<b>Description</b>
TRC List	Designate which TRCs will be displayed on the time calendar pages. TRC value lists are set up in Time and Labor and designated a unique ID. Click View List to see a list of the TRCs in the selected list.  <b>Note:</b> A TRC can be included in more than one TRC List. If a TRC appears in two or more TRC lists, the list with the higher priority will display on the calendar. View the TRC lists before setting priority codes to avoid possible duplication of TRCs and minimize potential confusion while viewing calendar pages. TRC values are defined in the Time and Labor setup tables.  <b>Important!</b> A maximum of five TRC lists can be specified. The system will not allow you to save the page with more than five TRC lists designated.

<b>Field or Control</b>	<b>Description</b>
Priority	Enter a number from 1 to 99 in this field. Priority definitions enable the system to decide which information is the most important to show. The priorities assigned to the TRCs and time event options determine which color to display when more than one type of time related data is in effect for the same period. The color with the highest priority will be used to represent all of the time for the particular period. All assigned priorities need to be unique.
Color	The Calendar View Options page enables you to associate colors with TRCs and time events, such as holidays. Use the drop-down menu to view the list of sixteen color choices. This design provides easier viewing of the calendar pages. The colors and associated elements will appear on the legend at the bottom of each calendar page.
Symbol	Define symbols to designate different TRCs and time events. Use up to three characters for each symbol. If <b>Display Symbols</b> is selected, these symbols appear on the calendar along with the hours to show different types of reported time and are explained through the legend on the calendar viewing pages.
View List	Click to view the TRCs contained in the selected TRC list.
Default Reported/Payable Time	Designate the priority, color and symbol (if used) to either the payable time reported by a time reporter or the time that is defaulted from the schedule.

### Scheduled Time and Exceptions

In addition to TRCs and default reported time, select other time-related items for calendar viewing. For example, if requested overtime and exceptions are important, you can prioritize them so that they display on the calendar pages, when present.

Select the priority, color, and symbol that the system is to apply to the following types of calendar display options.

<b>Field or Control</b>	<b>Description</b>
Workday	A workday is any regularly scheduled day for which time events should be reported. When <b>Show Schedules</b> is selected on the Time Calendar pages, <i>Workday</i> and <i>Off Day</i> will be displayed.

<b>Field or Control</b>	<b>Description</b>
Off Day	Days designated as non-workdays. Off days do not include requested/approved absences or holidays.
Approved Training and Requested Training	<p>Time or days which have been either requested or approved for training. One option is to set the requested hours at a slightly lower priority than the approved hours. This option would allow the color associated to <i>Requested Training</i> to appear in the grid on the Calendar pages for that specific time. If approved, the color would change to what is associated with <i>Approved Training</i>.</p> <hr/> <p><b>Note:</b> This option requires implementation of the Human Resources Administer Training business process or PeopleSoft Learning Management.</p> <hr/>
Approved Absence and Requested Absence	<p>Time or days which have been requested or approved for absence. One option is to set the requested hours at a slightly lower priority than the approved hours. This option would allow the color associated to <i>Requested Absence</i> to appear in the grid on the Calendar pages for that specific time. If approved, the color would change to what is associated with <i>Approved Absence</i>.</p> <hr/> <p><b>Note:</b> This option requires implementation of Global Payroll or Absence Management.</p> <hr/>
Approved Overtime and Requested Overtime	Time or days which have been requested or approved for overtime. One option is to set the requested hours at a slightly lower priority than the approved hours. This option would allow the color associated to <i>Requested Overtime</i> to appear in the grid on the Calendar pages for that specific time. If approved, the color would change to what is associated with <i>Approved Overtime</i> .
Holiday	Days defined as holidays by the company or organization.
Exceptions	If employee time produces exceptions during the Time Administration process, this option will create a link on the calendar page to the Exceptions Information page for more detailed information about the exception.

## Preview Legend Page

Use the Preview Legend page (TL\_WV\_LEGEND\_SEC) to view a sample of the legend that will appear at the bottom of the calendar viewing pages as defined by the current selected colors and symbols.

Navigation:

Click **Preview Legend** on the Calendar View Options page.

This example illustrates the fields and controls on the Preview Legend page. You can find definitions for the fields and controls later on this page.

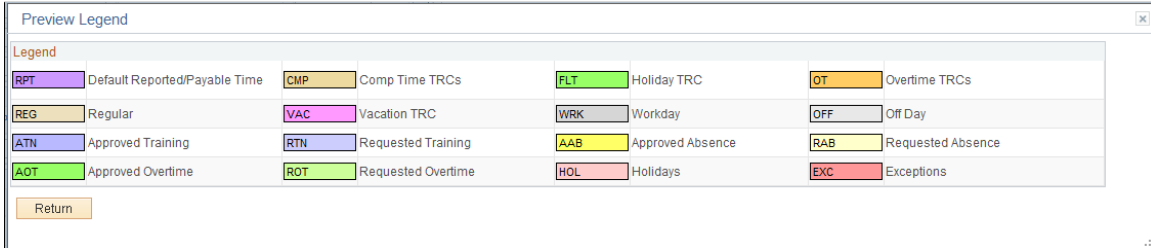

This page enables you to monitor the viewing option building process to assure the final design provides the necessary information in a readable format. You can see what symbols and colors have been designated for the various time events to be shown on the calendar. As you build your customized calendar views, check the legend periodically to review the symbols currently designated.

## Establishing Compensatory Time Plans

To set up compensatory time plans, use the Compensatory Time Off Plan (COMP\_TIME\_PLAN) component.

This section discusses how to set up compensatory time plans.

### Page Used to Set Up Compensatory Time Plans

<i>Page Name</i>	<i>Definition Name</i>	<i>Usage</i>
<u>Compensatory Time Off Plan Page</u>	TL_COMP_TIME_PLAN	Set up compensatory time plans for time reporters.

## Compensatory Time Off Plan Page

Use the Compensatory Time Off Plan page (TL\_COMP\_TIME\_PLAN) to set up compensatory time plans for time reporters.

Navigation:

**Set Up HCM > Product Related > Time and Labor > Time Reporting > Compensatory Time Off Plan > Compensatory Time Off Plan**



This example illustrates the fields and controls on the Compensatory Time Off Plan page. You can find definitions for the fields and controls later on this page.

**Note:** Adding, deleting, or updating a row in the Compensatory Time table triggers referential integrity processing. Referential integrity ensures that if changes to the compensatory time off plan have invalidated unpaid compensatory time, the time will be reevaluated and the balance updated accordingly.

<b>Field or Control</b>	<b>Description</b>
<b>Expiration Period</b>	Enter a unit of measure. Valid options are: <i>Days, Months, Years, and Never</i> . If you select <i>Never</i> , the <b>Number</b> field is unavailable. If you select any other value, enter a value in the <b>Number</b> field.
<b>Number</b>	Enter a the number of days, months, or years that the compensatory time is valid before expiry. This field defaults to a value of 9999.
<b>Limit Positive Comp Hours</b> (limit positive compensatory hours)	To limit the number of positive compensatory time hours that a time reporter can accrue, select this check box and fill in the <b>Max Positive Hours Allowed</b> field. If you do not select this check box, the <b>Max Positive Hours Allowed</b> field is unavailable.
<b>Max Positive Hours Allowed</b> (maximum positive hours allowed)	Enter the maximum number of compensatory time hours that a time reporter can accrue.
<b>Allow Negative Comp Hrs</b> (allow negative compensation hours)	To permit time reporters to have a negative compensatory time hours balance (use more compensatory time than they have accrued), select this check box and fill in the <b>Max Negative Hours Allowed</b> field. If you do not select this check box, the <b>Max Negative Hours Allowed</b> field will be unavailable.
<b>Max Negative Hours Allowed</b> (maximum negative hours allowed)	Enter the maximum negative hours of compensatory time that a time reporter can take.

## Valid Time Reporting Codes

Each compensatory time plan is linked to one or more TRCs. Add rows as necessary. If you assign more than one compensatory time plan to a time reporter and the compensatory time plans share one or more TRCs, the system creates an error. For example, a time reporter has plan A and you want to add plan B. Plan A contains TRCs REG and OVR. Plan B contains TRCs SPE and OVR. When you try to add plan B, the system creates an error. The uniqueness of the TRCs per compensatory time plan enables the system to recognize which plan's balance is affected when a time reporter has more than one plan.

<i>Field or Control</i>	<i>Description</i>
<b>Time Reporting Code</b>	Enter TRCs that are valid for this compensatory time plan. Some TRCs represent time compensatory time earned, other represent compensatory time taken.

### Related Links

[Background Processing](#)

[Understanding Time Reporting Codes](#)

## Defining Exceptions

To define exceptions, use the Exception Definition (TL\_EXCEPDEF\_PNLGRP) component.

This section discusses defining exception criteria and assigning message numbers.

### Page Used to Define Exceptions

<i>Page Name</i>	<i>Definition Name</i>	<i>Usage</i>
<a href="#">Exception Definition Page</a>	TL_EXCEPDEF_PNL	Establish exception criteria and assign message numbers.

### Exception Definition Page

Use the Exception Definition page (TL\_EXCEPDEF\_PNL) to establish exception criteria and assign message numbers.

Navigation:

**Set Up HCM > Product Related > Time and Labor > Validation Criteria > Exception Definition > Exception Definition**

This example illustrates the fields and controls on the Exception Definition page. You can find definitions for the fields and controls later on this page.

### Exception Severity

Exception severity communicates the severity of the exception during the Manage Time process. It helps determine whether time for the day is processed by the Time Administration process to create payable time.

**Note:** If selecting an exception definition with a severity of "low" or "medium," the **Allowable** check box will automatically be selected. This is because all low and medium severity exceptions will automatically allow payable time to be created by Time Administration.

<i>Field or Control</i>	<i>Description</i>
<b>High</b>	Select to give the exception a high priority. This is the default for system-defined exceptions. The Time Administration process ignores all unresolved and disallowed high-severity exceptions when calculating payable time. The system will only create payable time for these exceptions after they have been resolved or allowed.
<b>Medium</b>	Select to give the exception a medium priority. The Time Administration process will create payable time for medium severity exceptions.
<b>Low</b>	Select to give the exception a low priority. The Time Administration process will create payable time for low-severity exceptions.

## Exception Controls

<i>Field or Control</i>	<i>Description</i>
<b>Allowable</b>	<p>Select to allow payable time creation without resolving the exception during the Manage Time processes. If this is a system-defined exception, the check box is cleared by default.</p> <p>An allowable exception doesn't stop the Time Administration process. Leaving this check box cleared makes the exception disallowable, and requires the time manager to resolve the exception before it can become payable. This check box controls the exception display under Manage Exceptions. The Allow check box appears only if the exception is allowable.</p> <p>If selecting an exception definition with a severity of "low" or "medium", the Allowable check box will automatically be selected. This is because all low and medium severity exceptions will automatically allow payable time to be created by Time Administration.</p>
<b>Archive Exception</b>	<p>Select to archive exception. For example, you may want the system to store exceptions so that you can track how many times an employee is late. If this is a system-defined exception, the check box is cleared by default. Leave this check box cleared to prevent the exception from appearing on the Exceptions History page after it is resolved using the Manage Exceptions page. If you allow the exception using the Manage Exceptions page, the exception will also appear on the Exceptions History page.</p>

## Message Data

<i>Field or Control</i>	<i>Description</i>
<b>Message Set Number</b>	Select a number to establish the message set associated with the exception.
<b>Message Number</b>	Select the number of the actual message to describe the exception generated by the Time Administration process.

## Related Links

[Managing Exceptions](#)

## Defining PeopleSoft Application Engine Sections

To define application engine section, use the Validation Executable (TL\_AE\_SECTION\_PNLG) component.

This section discusses specifying the purpose of a PeopleSoft Application Engine section.

### Page Used to Define PeopleSoft Application Engine Sections

<i>Page Name</i>	<i>Definition Name</i>	<i>Usage</i>
Validation Executable Page	TL_AE_SECTION_DEFN	Define a PeopleSoft Application Engine section as a referential integrity section or a validation section.

### Validation Executable Page

Use the Validation Executable page (TL\_AE\_SECTION\_DEFN) to define a PeopleSoft Application Engine section as a referential integrity section or a validation section.

Navigation:

**Set Up HCM > Product Related > Time and Labor > Validation Criteria > Validation Executable**

This example illustrates the fields and controls on the Validation Executable page. You can find definitions for the fields and controls later on this page.

**Validation Executable**

Program Name TL\_TR0012903

Section TG00101

\*Process Type

\*Description  Short Description

Comment

<i>Field or Control</i>	<i>Description</i>
<b>Program Name</b>	Enter the name of the PeopleSoft Application Engine program in which this application engine section is included.

<b>Field or Control</b>	<b>Description</b>
<b>Process Type</b>	<p>Select the operation for the system to perform. Valid values are:</p> <p><i>Referential Integrity.</i> Select for this PeopleSoft application engine section to perform referential integrity processing.</p> <p><i>Validation.</i> Select for this PeopleSoft Application Engine section to perform validation processing.</p> <p><i>Rule (User Exit).</i> Select to use a user exit.</p>

### Related Links

[Background Processing](#)

[Managing Exceptions](#)

[Working with User Exits](#)

---

## Using Validation Criteria

To define validation criteria, use the Validation Rule (TL\_VALID\_DEFN\_PNLG) and the Validation Set (TL\_VALID\_SET\_PNLG) components.

This section discusses how to use validation criteria.

## Pages Used to Define and Group Validation IDs

<b>Page Name</b>	<b>Definition Name</b>	<b>Usage</b>
<a href="#">Validation Rule Page</a>	TL_VALID_DEFN_PNL	Define validation IDs that designate Application Engine sections as executables that can be selected for use in validation rules.
<a href="#">Validation Set Page</a>	TL_VALID_SET_PNL	Group validation IDs.

## Validation Rule Page

Use the Validation Rule page (TL\_VALID\_DEFN\_PNL) to define Validation IDs. Validation IDs designate Application Engine sections as executables that can be selected for use in validation rules. A Validation Rule combines a Validation Executable with an Exception.

Navigation:

**Set Up HCM > Product Related > Time and Labor > Validation Criteria > Validation Rule**

This example illustrates the fields and controls on the Validation Rule page. You can find definitions for the fields and controls later on this page.

**Validation Rule**

Validation ID TLX00030  PeopleSoft Delivered

---

**Validation Definition**

\*Description  Short Description

---

**Validation Executable**

Program Name  TR Empl Data validation

Section  Chk empl Time reptg status

Exception ID  Inactive Time Reporter Status

Comment  [?]

---

<b>Field or Control</b>	<b>Description</b>
<b>Program Name</b>	Specify the AE program for this validation. The available programs are limited to those referenced by a Validation Executable. Specifying a <b>Program Name</b> enables you to have like-named sections on different program libraries.
<b>Section</b> (validation application engine section)	Select the validation AE section that corresponds to this validation. The valid values depend upon your selection in the <b>Program Name</b> field. - you can only specify sections that are associated with the specified program.
<b>Exception ID</b>	Select the exception ID that should correspond to this validation. Generally, there will be a one-to-one correlation between exceptions and validations, but several validations could trigger the same exception. There will never be more than one exception per validation.

**Related Links**

[Defining PeopleSoft Application Engine Sections](#)

[Background Processing](#)

[Defining Exceptions](#)

**Validation Set Page**

Use the Validation Set page (TL\_VALID\_SET\_PNL) to group validation IDs.

Navigation:

**Set Up HCM > Product Related > Time and Labor > Validation Criteria > Validation Set**

This example illustrates the fields and controls on the Validation Set page. You can find definitions for the fields and controls later on this page.

The screenshot shows the 'Validation Set' configuration page. At the top, there are fields for 'Validation Set' (ST\_ALL), 'Description' (All Time Reporting Validations), and 'Short Description' (Validation). A checkbox for 'PeopleSoft Delivered' is checked. Below these is a 'Comment' text area. The main part of the page contains two tables. The left table, 'Rules in Set', has columns for 'Select', 'Validation ID', 'Description', 'Submit Time', and 'Time Admin'. It lists three rules: TLX00030 (Inactive Time Reporter Status), TLX00040 (Invalid Taskgroup), and TLX00060 (Invalid Task Profile ID). The right table, 'All Rules', has columns for 'Select', 'Validation ID', and 'Description', listing the same three rules. Between the tables are navigation buttons: '<<', 'Select All', and 'Deselect All'. A 'Delete' button is located below the 'Rules in Set' table.

### Rules in Set

This region displays the list of rules currently in this set. Rules can be added from the full set of rules in the group box on the right side of the page. Each rule can be configured to run against the submitted reported time and against the converted payable time produced by the Time Administration process (after rules processing).

Use the **Select** check boxes to remove validations from the validation set. After selecting the check boxes for the validations to remove from the validation set, click the **Delete** button to remove the selected items.

**Note:** If validations are not enabled which check against key reporting time tables, such as TRCs, the time is not processed and no exceptions are generated.

### All Validation Definitions

This is the list of all Validation rules defined. Select rules in this list and use the buttons between the two lists to add them into the current set.

Two ways exist to select which validations to include in a validation set: Click **Select All** and the system will select the entire column of check boxes. Or, to select particular validations that should appear in the list, select check boxes next to those validations. Use the **Clear** button to clear the entire column of check boxes. Click the >> button to transfer the selected validations to the new validation set.

Validations Sets are configured to determine if the validation is run in Submit Time, Time Administration, both batch processes or neither.

**Note:** Validation TLX0010, Invalid Leave Time Taken, cannot be enabled for the Submit Time process.

See [Understanding Exceptions and Validations](#).

## Defining Override Reason Codes

To define override reason codes, use the Override Reason Code (TL\_OVRD\_RSN\_PNLGP) component.

This section discusses establishing codes for the reasons for reporting time or for changing reported time.



## Page Used to Define Override Reason Codes

<i>Page Name</i>	<i>Definition Name</i>	<i>Usage</i>
<u>Override Reason Code Page</u>	TL_OVRD_RSN_PNL	Define codes for the reasons for reporting or for changing reported time.

### Override Reason Code Page

Use the Override Reason Code page (TL\_OVRD\_RSN\_PNL) to define codes for the reasons for reporting or for changing reported time.

Navigation:

**Set Up HCM > Product Related > Time and Labor > Time Reporting > Override Reason Code > Override Reason Code**

This example illustrates the fields and controls on the Override Reason Code page. You can find definitions for the fields and controls later on this page.

Enter comments and instances of reported time. When you enter comments, enter a reason code so that it will be easy to categorize the comments for reporting purposes. Use override reason codes for the Rapid Time and Time Reporting templates, and with the Timesheet page.



## Chapter 5

# Establishing Workgroups

---

## Understanding Workgroups

A workgroup is a group of time reporters who share identical compensation requirements. For example, a workgroup may include all time reporters:

- In the same business enterprise.
- In the same pay group.
- In the same union or union local.
- At the same work location.

Each time reporter who reports time through Time and Labor must belong to a workgroup. In addition, the Time Administration process applies rules by workgroup. A workgroup must be created before any process that uses it.

When selecting a workgroup for an employee with multiple jobs, keep in mind that you need to enroll each job in the same workgroup, in order for each job to be considered for rules that combine data for processing in the same batch.

### Related Links

[Defining Template-Built Rules](#)

## Common Elements Used in This Section

<b><i>Field or Control</i></b>	<b><i>Description</i></b>
<b>Reporting Time Type</b>	You specify the time reporting type you want the system to process for a workgroup. The two Time Types are Exception Time Reporting and Positive Time Reporting.
<b>Compensation Controls</b>	The Compensation Controls allow the system to validate the compensation criteria that is specific to your Rule Program, TRC Program, or Holiday Schedule setup.
<b>Rounding</b>	You must select Rounding Options based on your company's time reporting requirements. Selecting an option will ensure that the time the time reporters enter is properly rounded.

<b>Field or Control</b>	<b>Description</b>
<b>Day Breaker</b>	Enables you to define the point where one day crosses over to the next as the "day breaker." Although the day breaker is usually midnight—the moment when one calendar day becomes the next—you can set the day breaker to a different time to create virtual days that more closely mirror actual shifts worked. The system uses the day breaker to determine the exact "date under report" (DUR) of each punch or collection of punches that comprise the shift.
<b>Time Reporting Codes (TRCs)</b>	Enables you to define the level at which an organization actually needs to track employee time to support its administrative and compensation needs. For example, for payroll processing you establish an Earnings Code for Regular time (REG) and for time reporting you establish TRCs for all versions of regular time, such as tardy-paid, meeting-nonproductive, sick-paid, and so on.
<b>Date under report (DUR)</b>	The actual date of the time being reported for a shift as defined by the Day Breaker Options and Day Breaker Range.

## Related Links

[Understanding the Time Administration Process Flow](#)

## Workgroup Requirements

To meet the requirements for belonging to the same workgroup, a group of time reporters must:

- Be associated with the same time reporting type: Exception Time Reporting or Positive Time Reporting.
- Use the same holiday schedule if you're going to control the holiday schedule at the workgroup level.

---

**Note:** The system first checks for a holiday schedule on the JOB record. If one is not found there, it uses the pay group schedule, and if no schedule is associated with the pay group, it defaults to the workgroup schedule.

---

- Use the same TRC Program (which is composed of Time Reporting Codes).
- If the workgroup is for exception reporters, they must share work schedules for creating payable time if the default work schedule is selected for the time reporter.
- Use the same compensation rules and the same time period to assist in determining the period of interest for Time Administration.
- Use the same approval requirement.
- Use the same day breaker—the time used to determine when one day becomes the next.
- Use similar rounding rules for rounding punch and elapsed time.

- They can share the same association to a Compensatory Time Off Plan.

## Workgroups and Referential Integrity

When you make a change to one area of the application, Referential Integrity makes sure that these changes do not adversely affect another area of the application. It checks for retroactive changes to effective-dated setup data or employee related data that could invalidate related objects or values in the system.

The following tables describe Referential Integrity actions that occur when certain changes, inactivations, or deletions are made to workgroup data.

### Prevent Inactivation or Deletion of Effective-Dated Rows

You cannot inactivate a workgroup or delete effective-dated rows in the following cases:

<i>Feature</i>	<i>Action</i>
Workgroup	<p>You cannot inactivate a workgroup if the workgroup is associated to a time reporter on the Create/Maintain Time Reporter Data pages.</p> <p>You cannot delete an effective-dated row if the deletion invalidates an association to a time reporter on the Create/Maintain Time Reporter Data pages.</p>

### Execute Error Edit Checking

You cannot change the effective date of the target table to be greater than the effective date of the prompt table. This prevents an invalid association between the prompt value and the target table.

<i>Target Table</i>	<i>Prompt Table</i>
Workgroup	<p>Rule Program ID</p> <p>TRC Program ID</p> <p>Compensatory Time Off Plan</p> <p>Schedule ID</p> <p>Overtime Limit ID</p>

### Nested Effective Dates

You cannot change the effective date of the source table to be greater than the effective date of the target table. This ensures the validity of a value that acts as a prompt on another page.

<b>Source Table</b>	<b>Target Table</b>
Workgroup	Create/Maintain Time Reporter Data

## Setting Up Workgroups

To set up workgroups, use the Workgroup (TL\_WKG\_MAIN\_PNLGRP) component. Use the TL\_WKG\_MAIN\_PNLGRP component interface to load data into the tables for this component.

This section discusses how to set up workgroups.

## Page Used to Define Workgroups

<b>Page Name</b>	<b>Definition Name</b>	<b>Usage</b>
<u>Workgroup - Definition Page</u>	TL_WRKGRP_DEF	Define defaults, rounding options, and day breaker options for a workgroup.
<u>Workgroup - Approval/Timesheet Control Page</u>	TL_WRKGRP_APPV	Define approval options and timesheet control for a workgroup.
<u>Approval Groups Page</u>	TL_APP_GRP_SEC	Define the TL Group ID and instructions to help with the setup for approval usage related to an Approval Definition ID that starts with TLGroup.

## Workgroup - Definition Page

Use the Workgroup - Definition page (TL\_WRKGRP\_DEF) to define defaults, rounding options, and day breaker options for a workgroup.

Navigation:

**Set Up HCM > Product Related > Time and Labor > Rules and Workgroups > Workgroup > Definition**



**Note:** The following fields on this page trigger Referential Integrity: **Approve Payable Time, Rule Program ID, TRC Program ID, Holiday Schedule, Comp Plan, Schedule ID, Day Breaker, Day Breaker Options, Day Breaker Range, Rounding Options, Rounding Interval, and Rounding Marker.** Additionally, if the **Create Partial Work Hours for Partial Absence** or the **Exclude Holiday for Generating Time** options are changed for exception time reporting workgroups, Referential Integrity is triggered. For positive time reporting workgroups, modifying these options does not trigger Referential Integrity. For these fields, Referential Integrity ensures that if a time reporter's Earliest Change Date is less than the effective-dated change of the setup table, the Earliest Change Date will not be updated. If, however, the Earliest Change Date is null or greater than the effective date of the setup table change, the Earliest Change Date will be updated to the minimum effective date of Reported or Payable Time for the time reporter.

## Related Links

[Background Processing](#)

[Understanding the Time Administration Process Flow](#)

## Workgroup - Approval/Timesheet Control Page

Use the Workgroup - Approval/Timesheet Control page (TL\_WRKGRP\_DEF) to define approval options and timesheet control for a workgroup. Name every workgroup and define its basic parameters, approvals and status.

Navigation:

**Set Up HCM > Product Related > Time and Labor > Rules and Workgroups > Workgroup > Approval/Timesheet Control**

This example illustrates the fields and controls on the Workgroup — Approval / Timesheet Control (1\_2) Page.

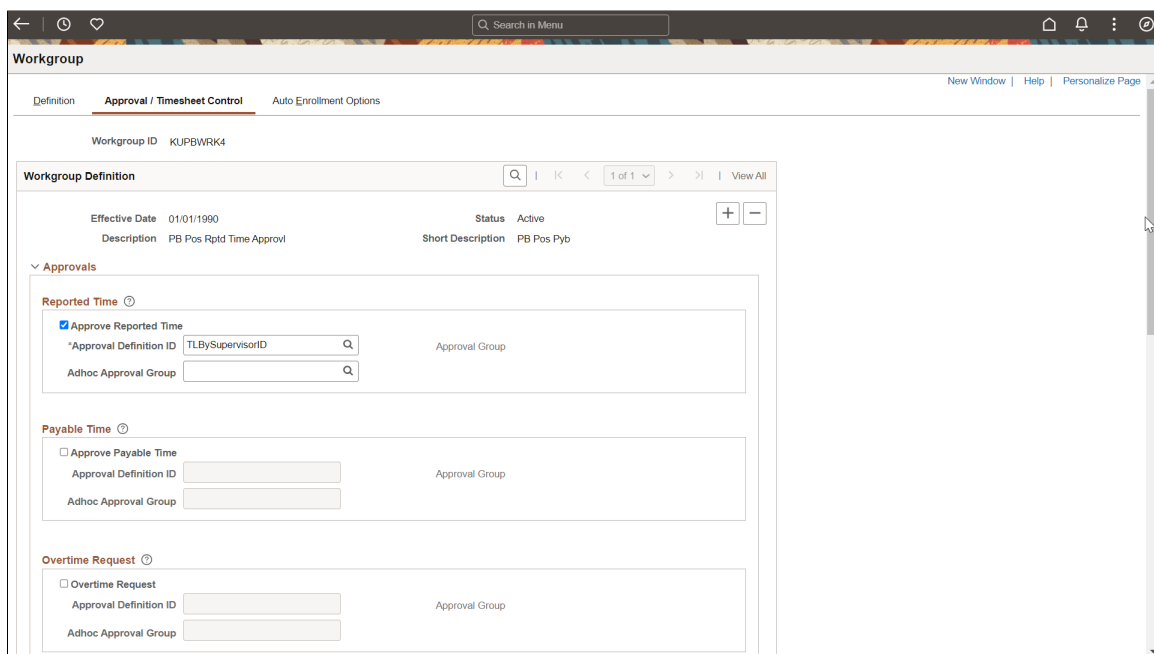



This example illustrates the fields and controls on the Workgroup - Approval (2\_2) page. You can find definitions for the fields and controls later on this page.

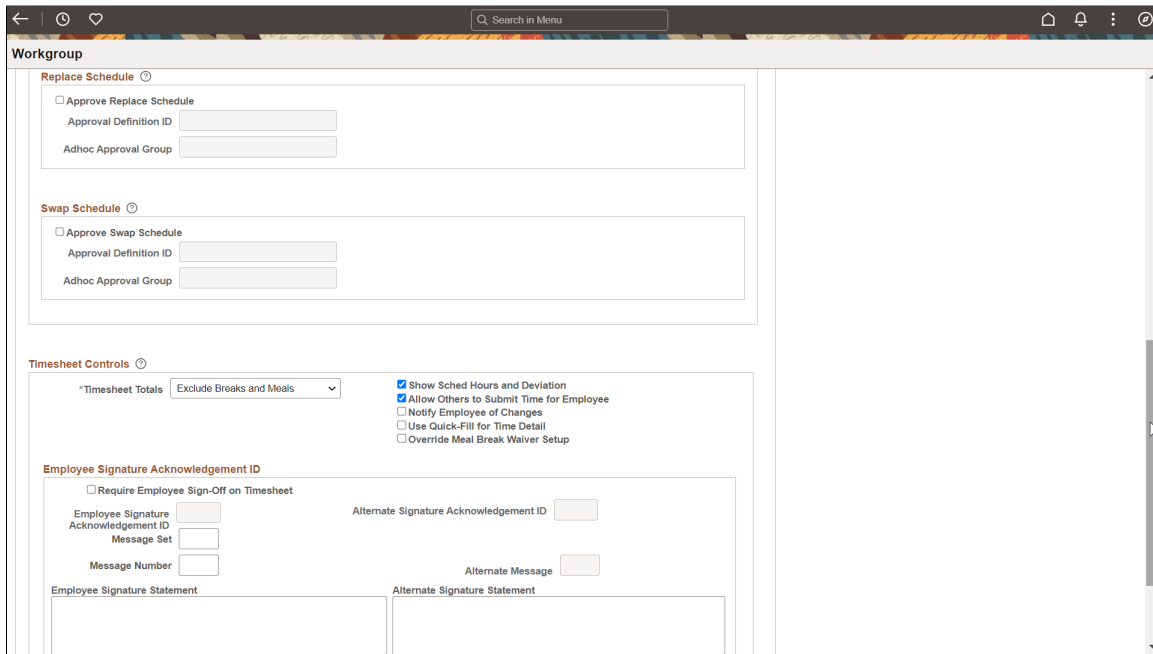

**Note:** The **Approve Payable Time** field on this page triggers Referential Integrity.

## Reported Time

The Approve Reported Time feature is an option for the approval of reported time. If selected, it requires that a manager approve the actual time reported versus payable time that has been processed by the Time Administration process. Select the Approve Reported Time field if a manager's approval is required for reported time. Then select an Approval Definition ID that has been created for Time and Labor approvals. The definition ID also identifies the appropriate approval definition. You can also select an ad hoc approval group ID that is set up for approvals. You can insert ad hoc approval group users into the approval process flow, along with the original approver.

<b>Field or Control</b>	<b>Description</b>
<b>Approve Reported Time</b>	<p>Select this check box if a manager's approval is required for reported time. Leave the check box clear if you do not want a manager to approve reported time.</p> <p>The Approve Reported Time feature is another option for approval of time. Selecting this field requires a manager to approve the actual time that was reported before the Time Administration process selects the time, processes it, and generates payable time. If time is not approved, then the reported time is not selected and run by the Time Administration process, and payable time is not generated.</p>

<b>Field or Control</b>	<b>Description</b>
<b>Approval Process ID</b>	Displays the Time and Labor process ID. The process ID identifies the approval transaction.
<b>Approval Definition ID</b>	Select the approval definition created for Time and Labor approvals. The definition ID also identifies the appropriate approval definition.
<b>Approval Group</b>	<p>Click to display the TL Approval Groups page. This link is available when the selected Approval Definition ID requires a Time and Labor approval group.</p> <hr/> <p><b>Note:</b> The Approval Group link is available when you select an Approval Definition ID that starts with TLGroup.</p> <hr/>
<b>Adhoc Approval Group</b>	Select an adhoc approval group ID that is set up for approvals. You can insert adhoc approval group users into the approval process flow, along with the original approver.

## Payable Time

Select the Approve Payable Time field if a manager's approval is required before the time reporters in this workgroup can be paid. When this field is selected and payable time is not approved by a manager, time reporters either will not be paid or their time will not be finalized. Then select an Approval Definition ID that has been created for Time and Labor approvals. The definition ID also identifies the appropriate approval definition. You can also select an ad hoc approval group ID that is set up for approvals. You can insert ad hoc approval group users into the approval process flow, along with the original approver.

<b>Field or Control</b>	<b>Description</b>
<b>Approve Payable Time</b>	<p>Select this check box if a manager's approval is required before the time reporters in this workgroup can be paid. If this check box is selected and payable time is not approved by a manager, time reporters will either not be paid or their time will not be finalized. Leave the check box clear if you do not want a manager to approve the time in order to be paid.</p> <p>If you change the value of this check box after time has been reported, the Validation process checks for any affected reported time. Affected instances of time need to be rerun through Time Administration to generate and update the status of Payable Time to either Needs Approval or Estimated, depending on the change you made. If the time reporter is recognized as not using any payroll system (based on the Send to Payroll flag on the Create/Maintain Time Reporter page), the Needs Approval status needs to remain as the only method of closing the time.</p> <hr/> <p><b>Important!</b> Selecting the <b>Retain Basic (non-AWE) Model</b> field on the Configurations page (TL_INSTL_PUNCH) causes the system to use a simpler security based model for approving payable time, rather than using the Approval Framework for payable time. This means that a manager's access and ability to approve a time reporter's payable time is based on the same security that grants the manager access to view and modify the person's time. See: <a href="#">Configurations Page</a></p>
<b>Approval Process ID</b>	Displays the Time and Labor Process ID. The Process ID identifies the approval transaction
<b>Approval Definition ID</b>	Select the approval definition created for Time and Labor approvals. The definition ID also identifies the appropriate approval definition.
<b>Approval Group</b>	<p>Click to display the TL Approval Groups page. This link is available when the selected Approval Definition ID requires a Time and Labor approval group.</p> <hr/> <p><b>Note:</b> The Approval Group link is available when you select an Approval Definition ID that starts with TLGroup.</p>
<b>Adhoc Approval Group</b>	Select an adhoc approval group ID that is set up for approvals. You can insert adhoc approval group users into the approval process flow, along with the original approver.

## Overtime Request

Select the Overtime Request field if a manager's approval is required for employee overtime requests. Then select an Approval Definition ID that has been created for Time and Labor approvals. The definition ID also identifies the appropriate approval definition. You can also select an ad hoc approval group ID that is set up for approvals. You can insert ad hoc approval group users into the approval process flow, along with the original approver.

<i>Field or Control</i>	<i>Description</i>
<b>Overtime Request</b>	Select this check box if a manager's approval is required for employee overtime requests.
<b>Approval Process ID</b>	Displays the Time and Labor Process ID. The Process ID identifies the approval transaction.
<b>Approval Definition ID</b>	Select the approval definition created for Time and Labor approvals. The definition ID also identifies the appropriate approval definition.
<b>Approval Group</b>	<p>Click to display the TL Approval Groups page. This link is available when the selected Approval Definition ID requires a Time and Labor approval group.</p> <hr/> <p><b>Note:</b> The Approval Group link is available when you select an Approval Definition ID that starts with TLGroup.</p> <hr/>
<b>Adhoc Approval Group</b>	Select an adhoc approval group ID that is set up for approvals. You can insert adhoc approval group users into the approval process flow, along with the original approver.

## Replace Schedule

Select the Replace Schedule field if a manager's approval is required for employee to give up the shift. Then select an Approval Definition ID that has been created for Time and Labor approvals. The definition ID also identifies the appropriate approval definition. You can also select an ad hoc approval group ID that is set up for approvals. You can insert ad hoc approval group users into the approval process flow, along with the original approver.

<i>Field or Control</i>	<i>Description</i>
<b>Replace Schedule</b>	Select this check box if a manager's approval is required for employee replace schedule requests.

<b>Field or Control</b>	<b>Description</b>
<b>Approval Process ID</b>	Displays the Time and Labor Process ID. The Process ID identifies the approval transaction.
<b>Approval Definition ID</b>	Select the approval definition created for Time and Labor approvals. The definition ID also identifies the appropriate approval definition.
<b>Adhoc Approval Group</b>	Select an adhoc approval group ID that is set up for approvals. You can insert adhoc approval group users into the approval process flow, along with the original approver.

## Swap Schedule

Select the Swap Schedule field if a manager's approval is required for employee to trade their schedule. Then select an Approval Definition ID that has been created for Time and Labor approvals. The definition ID also identifies the appropriate approval definition. You can also select an ad hoc approval group ID that is set up for approvals. You can insert ad hoc approval group users into the approval process flow, along with the original approver.

<b>Field or Control</b>	<b>Description</b>
<b>Swap Schedule</b>	Select this check box if a manager's approval is required for employee swap schedule requests.
<b>Approval Process ID</b>	Displays the Time and Labor Process ID. The Process ID identifies the approval transaction.
<b>Approval Definition ID</b>	Select the approval definition created for Time and Labor approvals. The definition ID also identifies the appropriate approval definition.
<b>Adhoc Approval Group</b>	Select an adhoc approval group ID that is set up for approvals. You can insert adhoc approval group users into the approval process flow, along with the original approver.

## Timesheet Controls

Select the Require Employee Sign-Off On Timesheet field to require an electronic signature on all submitted timesheets. When you select this field, you must also specify the text of the employee signature statement. Because this text is a message catalog entry, you must also specify the message set and message number.

<b>Field or Control</b>	<b>Description</b>
<b>Allow Others to Submit Time for Employee</b>	<p>Select this field to enable a user with row security access to the employee to edit the employee’s reported time on the Manager Self Service Timesheet.</p> <p>If this field is selected, you must enter a value in <b>Alternate Signature Employee ID</b> field.</p> <p>If this field is not selected, the <b>Notify Employee of Changes</b> field is not available.</p>
<b>Notify Employee of Changes</b>	<p>Select if you want the employee to receive notices when a manager enters time on behalf of an employee.</p> <p>This field is only available if the <b>Allow Others to Submit Time for Employee</b> field is selected.</p>
<b>Use Quick-Fill for Time Detail</b>	<p>Enable quick fill for time entries.</p>
<b>Override Meal Break Waiver Setup</b>	<p>Select this checkbox to override the meal break waiver definition specified in the Enter Time page for punch time reporter. For details on Enter Time page, see <a href="#">Enter Time Page for Punch Time Reporter</a>.</p> <p>This field's value is set to off by default. Employees in this workgroup will not be eligible for the meal waiver option when it is selected, or turned on.</p>
<b>Alternate Message and Alternate Signature Statement</b>	<p>Enter a message catalog ID to use as notification text. When you select this option, the contents of the <b>Alternate Signature Statement</b> display on the Manager Self Service Timesheet. The system also captures the User ID, the date, and the time.</p>

### Employee Signature Acknowledgement ID

Select the Require Employee Sign-Off On Timesheet field to require an electronic signature on all submitted timesheets. When you select this field, you must also specify the text of the employee signature statement. Because this text is a message catalog entry, you must also specify the message set and message number.

Whenever a timesheet is submitted by someone on behalf of an employee, the fields Alternate Signature Acknowledgement ID and Alternate Message are mandatory.

<b>Field or Control</b>	<b>Description</b>
<b>Require Employee Sign-Off on Timesheet</b>	<p>Select this check box to enable a user with employee sign-off on Timesheet required while entering time using Enter Time page.</p> <hr/> <p><b>Note:</b> If this field is selected, the fields Employee Signature Acknowledgement ID, Message Set, Message Number are mandatory.</p> <hr/> <p>If this field is not selected, the Notify Employee of Changes field is not available.</p>
<b>Employee Signature Acknowledgement ID</b>	<p>Select the employee signature acknowledgement ID.</p> <hr/> <p><b>Note:</b> If you do not want to set-up acknowledgement IDs and provided the installation check box is turned off, then you can provide the message catalogue and message set numbers and the acknowledgement message will appear on the fluid time sheet as in classic. This applies to Enter Time, Report Time and Weekly Time pages.</p> <hr/>
<b>Message Set</b>	Specify the message set in numbers.
<b>Message Number</b>	Specify the message number as required.
<b>Employee Signature Statement</b>	This populates an employee signature statement defined as per the fields.
<b>Alternate Signature Acknowledgement ID</b>	Select if there is a need to choosing alternate signature acknowledgement ID. You must enter a value in the Alternate Message field if a value is selected in this field.
<b>Alternate Message</b>	Alternated message characters in number.
<b>Alternate Signature Statement</b>	This populates an alternate signature statement defined as per the fields.

## Related Links

[Understanding Payable Time](#)

## Approval Groups Page

The selected Approval Definition ID generates an approval routing based on the selected definition. For example, TLGroupMultipleStageALL has two stages with one path, and one step within each stage. The request reaches final approval status when all of the Stage 1 approvers and then all Stage 2 approvers have approved the request. Based on the selected Approval Definition ID, the Approval Groups page displays the correct approval groups and instructions to help with the setup for approval usage.

Use the Approval Groups page (TL\_WRKGRP\_APPV) to define the TL Group ID and instructions to help with the setup for approval usage related to an Approval Definition ID that starts with TLGroup.

Navigation:

**Set Up HCM > Product Related > Time and Labor > Rules and Workgroups > Workgroup > Approval**

This example illustrates the fields and controls on the Approval Groups page. You can find definitions for the fields and controls later on this page.

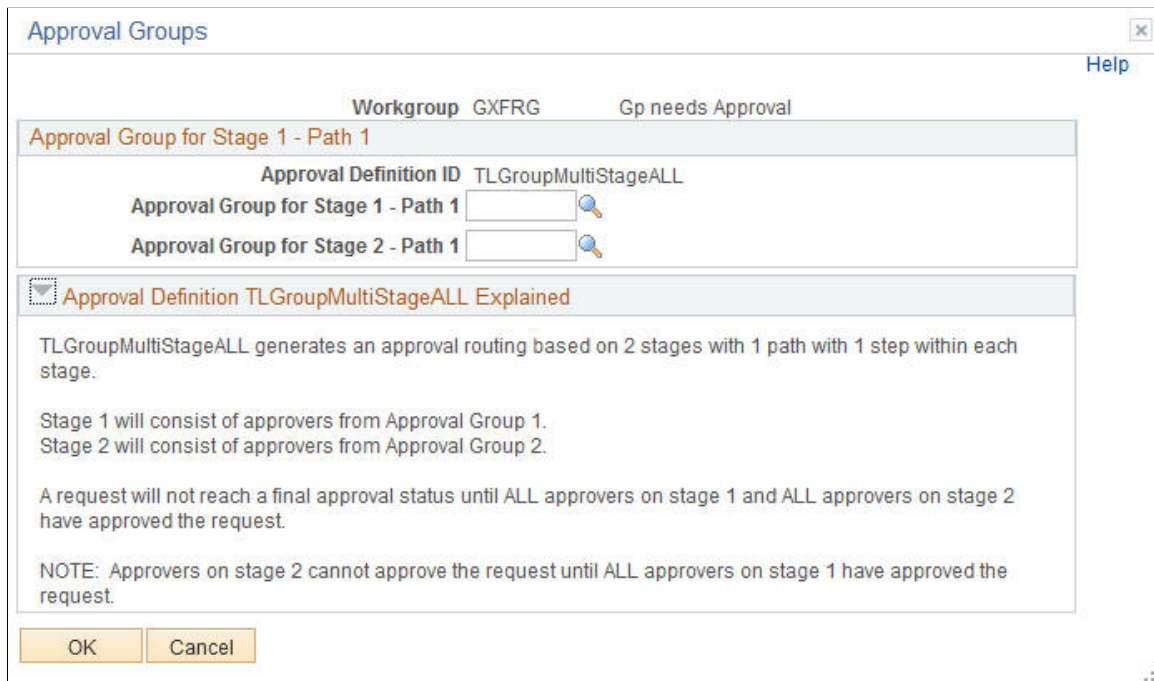

<b>Field or Control</b>	<b>Description</b>
<b>Approval Group for Stage 1 - Path 1</b>	Select the group of Stage 1 approvers.
<b>Approval Group for Stage 2 - Path 1</b>	Select the group of Stage 2 approvers.  <b>Note:</b> The Stage 2 approvers cannot approve a request until after the Stage 1 approvers have approved the request.



## Defining the Reporting Time Type Group Box

On the Workgroup - Definition page access the Time Type group box.

If you change the Time Type for the workgroup from Positive to Exception, the effect is the ability to automatically create time for a given population by turning default schedule information into Payable Time.

If you change from Exception to Positive, time cannot be created for time reporters based on schedules -- all time needs to be positively reported.

When you make a change to the Time Type, the next time the system runs Time Administration, it will take into account the new time type.

<i>Field or Control</i>	<i>Description</i>
<b>Exception Time Reporting</b>	<p>Select this option if time reporters in this workgroup do not report their time on a daily basis, but are paid regularly. Examples of exception time reporting are time reporters who only report sick, vacation, or personal days. If no time is reported by an exception time reporter, the Time Administration process creates payable time based on the time reporter's schedule.</p> <hr/> <p><b>Note:</b> No payable time is created from the schedule when Time Administration is run on days when zero hours are reported.</p> <hr/>
<b>Positive Time Reporting</b>	<p>Select this option if you want the time reporters in this workgroup to report their time on a daily basis in order to be compensated. An example of positive time reporting is time reporters who report their time on an hourly basis.</p>

---

**Note:** You should enter positive or exception time reporting into your description of each workgroup. This enables you to determine the workgroup to which you want to assign the time reporters from the Create Time Reporter Data page, or the Maintain Time Reporter Data page. It is important that you categorize your employees correctly, because Time Administration creates Payable Time differently for exception and positive time reporters.

---

## Defining Compensation Controls

On the Workgroup - Definition page, access the Compensation Controls group box.

<b>Field or Control</b>	<b>Description</b>
<b>Rule Program ID</b>	<p>Enter a Rule Program ID. To set up a rule program, you must use the Rule Program page. Although this field is not required when you create a workgroup, the Rule Program ID is needed in order for the time reporters in this group to have rules applied during Time Administration rules processing. If you try to save the page without entering a value in this field, you will get a warning message. The message will not prevent you from saving the page. You can save the page and come back to assign a Rule Program ID after you have your rule programs defined.</p> <p>If a time reporter reports time with a valid TRC, Time Administration will create payable time even if their workgroup has no rule program: Time Administration will round, distribute tasks, and validate time without running rules. If the TRC is invalid, the system will generate an exception. For elapsed time reporters, exceptions will be created for all positively reported time that doesn't have a valid TRC. If you change the rule program attached to a workgroup, the Referential Integrity process will determine the Payable Time affected by this change, and trigger Time Administration to reprocess this time.</p>
<b>TRC Program ID</b>	<p>Select a TRC Program ID. TRC programs contain the list of TRCs that the system uses to create payable time for time reporters belonging to this workgroup. When workgroup members report time through the Elapsed Timesheet, only TRCs in this TRC program will appear in the TRC field.</p> <p>If you try to change the TRC program attached to this workgroup, the Referential Integrity process will trigger Time Validation to check any reported or payable time that might be affected by this change. If there is any such time, the system creates exceptions and you will have to adjust the TRC to address the exceptions.</p> <p>If time is reported through the TCD Interface or Rapid Entry process and contains invalid TRCs, the system will create exceptions for these instances of time. If the interface includes new TRCs that should be added, you can add the new TRCs to the appropriate TRC program. When you add the new TRCs, the system should delete the exceptions.</p>
<b>Overtime Limit ID</b>	<p>Select the Overtime Limit ID (if applicable), that applies to the members of the workgroup.</p>

**Related Links**

[Understanding Time Reporting Codes](#)

[Adding Rules to a Rule Program](#)

**Setting Up Rounding Options**

On the Workgroup - Definition page, access the Rounding Options group box.

This following illustrates the controls and definitions of Rounding Options.

Rounding Options	
<b>Round Punches Before Rules</b> <input type="radio"/> Round Each Punch <input type="radio"/> Round By Day <input checked="" type="radio"/> No Rounding Rounding Interval (Minutes) <input type="text"/>	<b>Round Durations After Rules</b> <input type="radio"/> Round Each Entry <input type="radio"/> Round By Day <input checked="" type="radio"/> No Rounding Rounding Marker (Minutes) <input type="text"/>

There are three types of rounding in Time and Labor:

<i>Field or Control</i>	<i>Description</i>
<b>Round Each Punch</b>	The system rounds all reported punches before applying rules to the time in Time Administration.  Even if this option is selected, the rules that require actual punch times continue to evaluate time as it was originally reported. For example, rules that track attendance continue to evaluate the originally reported time.
<b>Round By Day</b>	For daily rounding of punch time before Time and Labor rules are processed, but after the Day Breaker is applied. Using this option, punch time is not changed, but the duration associated with the first punch (IN) for the day is adjusted.
<b>No Rounding</b>	No rounding rules are applied.

**Note:** For punch time reporters, a segment is the duration between one punch and the next punch. For elapsed time reporters, a segment is one entry of time for a specific day. For example, if a time reporter reports 4 hours of REG and 4 hours of OT on one day, each entry of 4 hours would be considered a "segment." Two segments are considered "alike" if all the information in reported time (and all relevant fields in the TL\_RPTD\_TIME table) except TL\_QUANTITY is the same.

## Rounding in Time Administration

The units of time for **Round Punches Before Rules** is hours and minutes. Since this applies to punch time only, all pre-rules rounding is exact, because the rounding logic parameters are in minutes.

For post-rules rounding, the punch time is converted from standard hours and minutes to decimal time before the rules are processed to enable the punch time and elapsed time to be combined in the rules process.

For example, 8 hours and 30 minutes converts to 8.50 hours, and 8 hours and 29 minutes converts to 8.483333 hours.

When post-rules rounding is applied, the system performs the following conversions to the time units:

1. This example illustrates the fields and controls on the Workgroup — Approval / Timesheet Control Page. You can find definitions for the fields and controls later on this page.

The punch time is converted from hours and minutes to decimal time.

2. When the post-rules rounding is applied, the time is converted into hours and minutes.
3. The time is then rounded and then converted back to decimal time.

The back-and-forth time conversion for post-rules rounding means that rounding differences occur even when the rounding rules are not applied.

The following table shows the differences that are encountered when minute values are converted to decimal time and then back to minutes:

Punch Time Minutes	Conversion to Decimal Time in TL_QUANTITY	TL_QUANTITY Rounded to Five Decimal Places	TL_QUANTITY Converted Back to Minutes	Difference Between Original Entry and Final Converted Time
1	0.0166666667	0.016670	1.000200	Plus .0002
2	0.0333333333	0.033330	1.999800	Minus .0002
3	0.0500000000	0.050000	3.000000	No Difference
4	0.0666666667	0.066670	4.000200	Plus .0002
5	0.0833333333	0.083330	4.999800	Minus .0002
6	0.1000000000	0.100000	6.000000	No Difference
7	0.1166666667	0.116670	7.000200	Plus .0002
8	0.1333333333	0.133330	7.999800	Minus .0002
9	0.1500000000	0.150000	9.000000	No Difference

---

**Note:** The values in the Difference column of this table repeat for every three minutes up through a value of 59 minutes in the Punch time Minutes column.

---

## Intervals and Markers

After you have selected a rounding option, define your option by specifying a Rounding Interval and a Rounding Marker.

<b>Field or Control</b>	<b>Description</b>
<b>Rounding Interval (Mins)</b>	<p>A rounding interval represents the number of minutes comprising a segment of an hour. For example, if you select 15 (minutes) in the Rounding Interval field, the following 4 intervals will be created for each hour:</p> <p>Interval 1: x:00 to x:15</p> <p>Interval 2: x:15 to x:30</p> <p>Interval 3: x:30 to x:45</p> <p>Interval 4: x:45 to x:00</p>
<b>Rounding Marker (Mins)</b>	<p>Rounding markers work in conjunction with rounding intervals (defined above) to define rounding rules: the rounding marker is a point in time in relation to which the system rounds either up or down within an interval. So if we return to the preceding example of four 15 minute rounding intervals, and select a rounding marker of 10 minutes, both the intervals and markers can be represented as follows:</p>

This image illustrates the example of four fifteen minute rounding intervals and a rounder marker of 10 minutes.

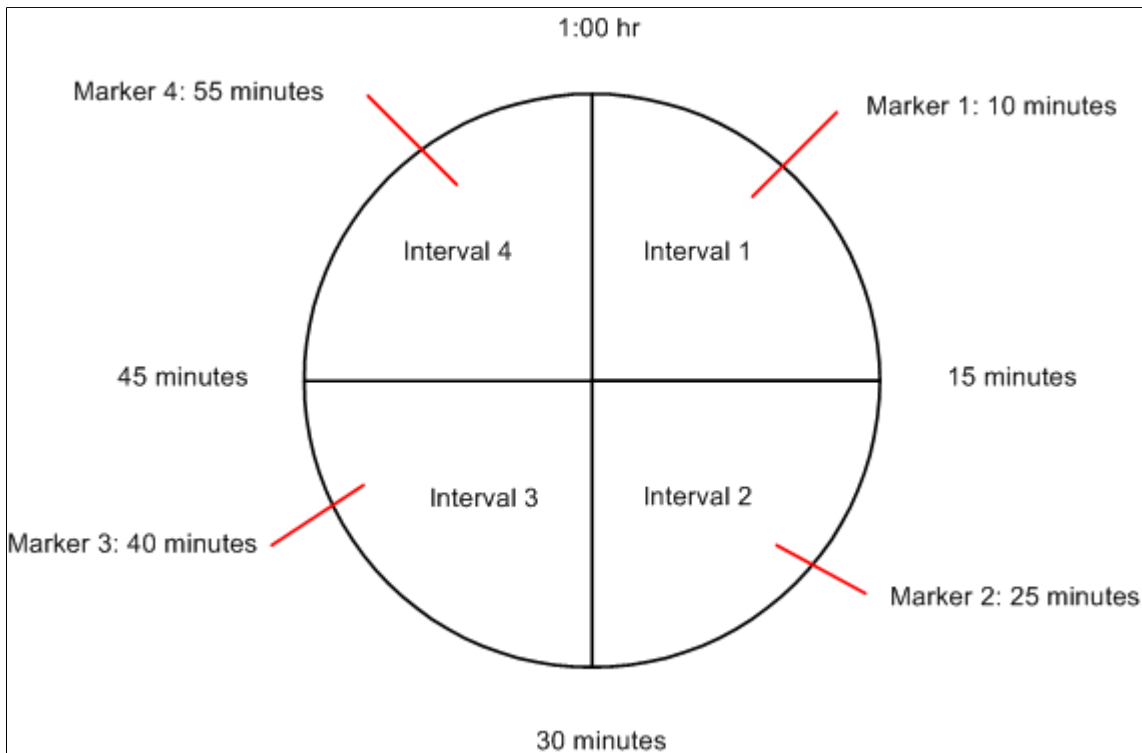

As illustrated in this example, each interval contains a corresponding rounding marker. A rounding marker cannot exceed the number of minutes in an interval, and occurs as many minutes after the start

of each interval as the value you enter in the **Rounding Marker** field. So, in this example, the rounding marker occurs 10 minutes into each interval.

The way rounding intervals and rounding markers are used depends on whether you are using pre-rules rounding or post-rules rounding:

**Pre-Rules Rounding**

If you are rounding punches (pre-rules rounding), the system uses the rounding interval together with the rounding marker to round each punch to the closest start or end point of the interval in which the punch was made. The system then calculates the difference between each in and out punch and sends the resulting duration to Time Administration for rules processing. If a punch is made prior to the rounding marker, the system rounds down to the beginning of the interval. If a punch falls either directly on or after the rounding marker, the system rounds up to the end of the interval. A rounding marker always defaults to the midpoint of a rounding interval; the rounding marker can be modified.

The following example of pre-rules rounding illustrates how the system applies a rounding rule. Let's assume that you have selected the following rounding options, and that the punch to be rounded occurs 11 minutes into the first rounding interval:

<i><b>Field or Control</b></i>	<i><b>Description</b></i>
<b>Rounding Option</b>	= Round Punches Before Rules
<b>Rounding Interval</b>	= 15 Minutes
<b>Rounding Marker</b>	= 7.5 Minutes

In this example, the system rounds the punch up to 15 minutes. This is because 11 minutes is greater than the rounding marker of 7.5 minutes.

This image illustrates the described example when the system rounds the punch up to 15 minutes.,

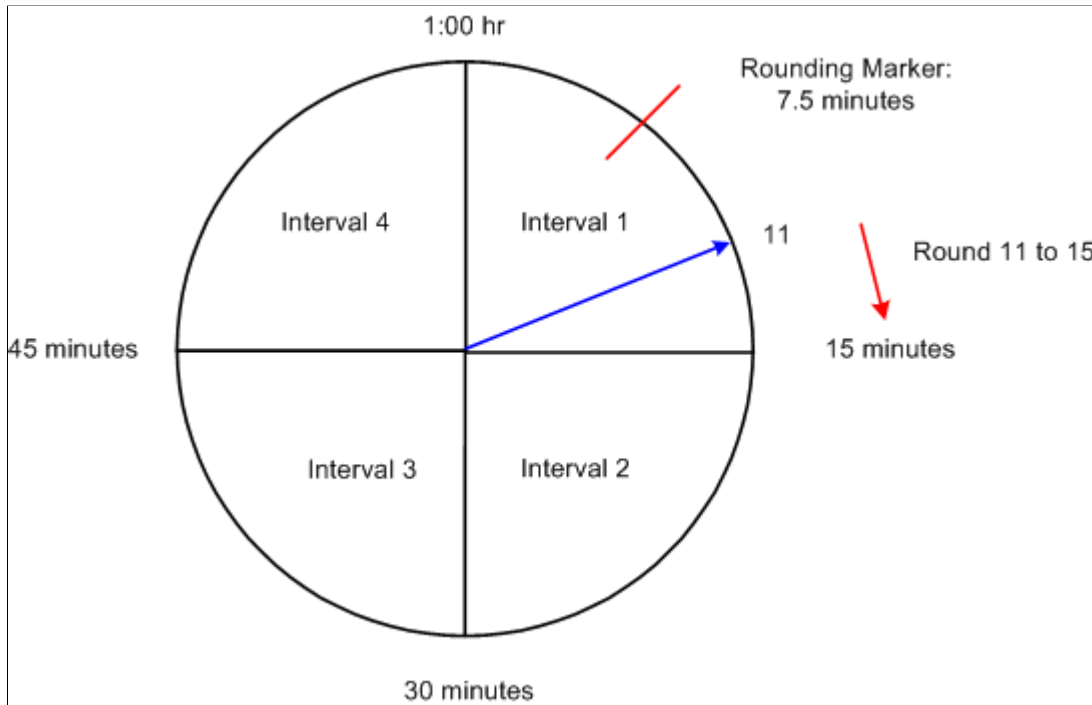

### Post-Rules Rounding

Post-rules rounding affects both punch and elapsed time. In the case of punch time, the system calculates the difference between individual consecutive punches (for example, an IN and an OUT punch) to create a duration for each set of matched punches. These durations are then rounded. In the case of elapsed time, time is reported as a duration, so the system simply rounds the reported duration up or down within its corresponding interval.

The post-rules rounding process first determines the interval (as defined previously) within which the duration falls and then rounds within that interval. If a duration falling within an interval is less than the rounding marker (for that interval), the system rounds down to the beginning of the interval. If the duration falling within the interval is equal to or greater than the rounding marker, the system rounds up to the end of the interval.

The following examples illustrate how the system applies rounding rules to both punch and elapsed time:

#### Example 1: Segment Rounding of Punch Time

Let's assume that we have selected the following rounding options, that we are rounding punch time, and that the duration to be rounded is 1 hour, 18 minutes:

<b>Field or Control</b>	<b>Description</b>
<b>Round Duration After Rules</b>	= Segment
<b>Rounding Interval</b>	= 15 Minutes

<b>Field or Control</b>	<b>Description</b>
<b>Rounding Marker</b>	= 10 Minutes

Because our *Rounding Interval* is 15 minutes and our *Rounding Marker* is 10 minutes, the system rounds 1 hour, 18 minutes to 1 hour, 15 minutes. This is illustrated in the following diagram:

This image illustrates the discussion of rounding 1 hour, 18 minutes to 1 hour, 15 minutes.

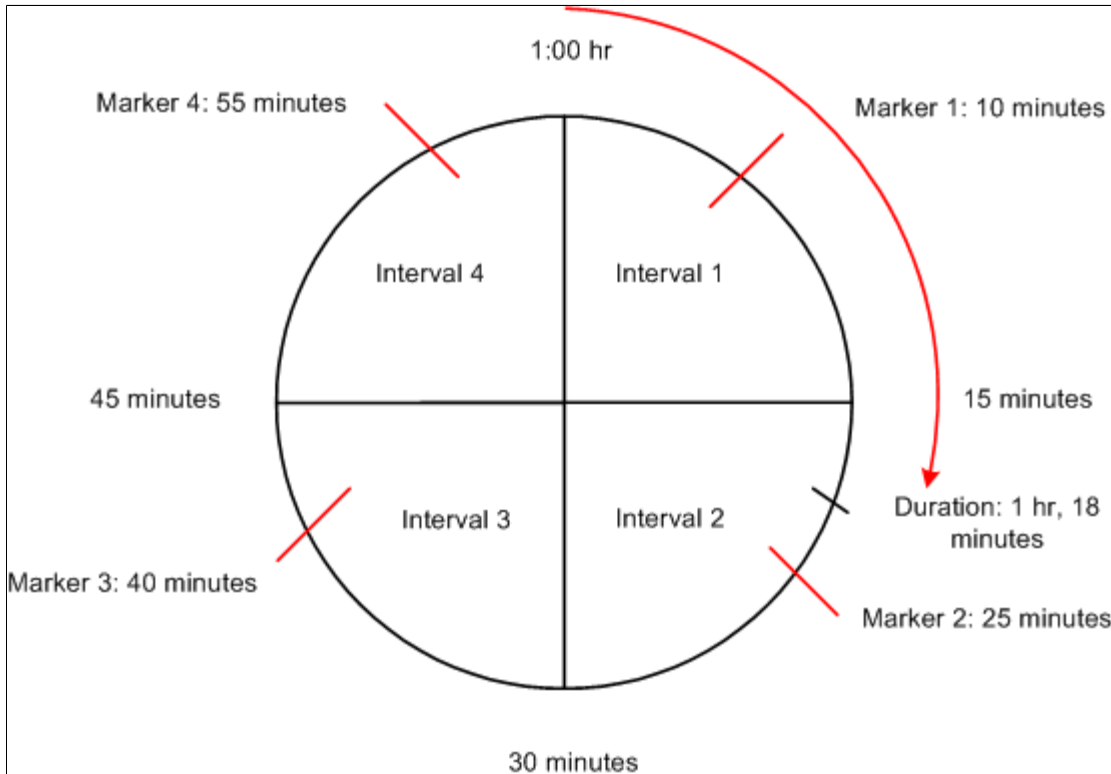

In this example, the duration to be rounded (1 hour, 18 minutes) falls within Interval 2 (00:15 to 00:30). This means that the duration must be rounded up or down within that interval. Because 18 minutes is less than the *Rounding Marker* for Interval 2 (25 minutes), the duration is rounded down to 1 hour, 15 minutes.

*Example 2: Segment Rounding of Elapsed Time*

To illustrate how the rounding process works in the case of an elapsed time reporter, let's assume that we have selected the same rounding options used in the previous example, and that our time reporter is scheduled to work 8 hours on a given day, but positively reports 4.33 hours (4 hours and 20 minutes). In this case, the system would round the time to 4.25. This is because 4.33 hours equals 4 hours and 20 minutes, and 20 minutes falls within Interval 2. The duration of 20 minutes is less than the Rounding Marker (25 minutes), so the duration is rounded down to 15 minutes, which is .25 hours. Therefore, the final time is 4.25.



**Note:** If you change your rounding options, the rounding interval, or rounding marker, the Referential Integrity process will trigger Time Administration to reprocess any affected payable time from the effective-dated change forward. Affected instances of time need to be rerun through TA in order to recreate correct durations for payable time for the correct dates under report.

*Example 3: Segment Rounding After Rules of Punch Time*

Rounding Interval = 15 minutes

Rounding Marker = 7.5 minutes

<b>Reported Time</b>					
<i>Punch Time</i>	<i>Punch Type</i>	<i>Segment</i>	<i>Rounded</i>	<i>Project</i>	<i>Department</i>
8:10 a.m.	IN	1 hour, 50 minutes	1.75	A	
10:00 a.m.	BREAK	20 minutes	.25		Y
10:20 p.m.	IN	2 hours, 40 minutes	2.75	A	
1:00 p.m.	MEAL	1 hour, 5 minutes	1.00		Y
2:05 p.m.	IN	2 hours, 55 minutes	3.00	B	
5:00 p.m.	OUT				

**Note:** All segments are rounded first, then like segments are summed.

<b>Payable Time Results</b>		
REG	3 hours	Project B
REG	4.5 hours	Project A
REG	1.25 hours	Department A

*Example 4: Day Rounding After Rules of Punch Time*

Rounding Interval = 15 minutes

Rounding Marker = 7.5 minutes

<b>Reported Time</b>				
<i>Punch Time</i>	<i>Punch Type</i>	<i>Duration</i>	<i>Project</i>	<i>Department</i>
8:10 a.m.	IN	1 hour, 50 minutes	A	
10:00 a.m.	BREAK	20 minutes		Y
10:20 p.m.	IN	2 hours, 40 minutes	A	
1:00 p.m.	MEAL	1 hours, 5 minutes		Y
2:05 p.m.	IN	2 hours, 55 minutes	B	
5:00 p.m.	OUT			

Total all like segments first, then round:

<b>Project/Dept.</b>	<b>Totalled Time by Task</b>
Project A	4 hours, 30 minutes
Project B	2 hours, 55 minutes
Department Y	1 hour, 25 minutes

<b>Payable Time Results</b>		
REG	3 hours	Project B
REG	4.5 hours	Project A
REG	1.5 hours	Department Y

**Related Links**

[Step 8: Matching Punches](#)

[Step 12: Performing Rounding, Task Distribution and Estimated Gross](#)

## Specifying Workgroup Defaults

On the Workgroup - Definition page, access the Workgroup Defaults group box.

<b>Field or Control</b>	<b>Description</b>
<b>Holiday Schedule</b>	<p>Select a Holiday Schedule from the drop-down list box. Time and Labor determines the holiday schedule by checking for the time reporter's Job record first. If no holiday schedule is listed on the Job record, the system checks this field at the workgroup level.</p> <p>If you change the holiday schedule associated with a workgroup, the Referential Integrity process will trigger Time Administration to process any time affected by the change in holiday schedule.</p>
<b>Compensatory Time Off Plan</b>	<p>If your organization tracks compensatory time, and you would like to associate time reporters with compensatory time plans at the workgroup level, select a Compensatory Time Off Plan from the drop-down list box. Compensatory time-off plans are associated with TRC programs, just like workgroups. The TRCs attached to your compensatory time off plan must be part of the TRC program associated with this workgroup, so that compensatory time is processed correctly.</p> <p>If the Default from the Workgroup field on the TL Installation Options page is selected, any Compensatory Time Off Plan entered here will be associated to all time reporters as of the date they are associated with the workgroup. If the default from the Workgroup field on the TL Installation Options page is not selected, any entry in this field is not considered for batch or online compensatory time validation.</p> <p>If you change the compensatory time-off plan on your workgroup, and the Default from Workgroup field on the TL Installation Options page is selected, the Referential Integrity process will trigger Time Administration to reprocess any compensatory time from the point of the effective date of the plan change. Time reporters' compensatory time balances may change as a result. In addition, the Comp Plan Enrollment page will be updated automatically with the plan change for the time reporters in this workgroup.</p>
<b>Time Period ID</b>	<p>Select from the drop-down list box. From a time reporting perspective, the system uses the time period on the Workgroup page to differentiate between time belonging to the current period and time that falls within a prior period.</p> <p>The only day-type periods you can enter in this field are periods with an offset of 1.</p>
<b>Schedule Group</b>	<p>Select a Schedule Group value. This value will filter the Schedule IDs available per SetID. This field is a required field if Schedule ID is selected.</p>

<b>Field or Control</b>	<b>Description</b>
<b>Schedule ID</b>	<p>Select from the drop-down list. The system uses the value you designate here as the default schedule assignment for all time reporters in this workgroup.</p> <p>If you are creating an "Exception" type workgroup, you must select a value in this field or the system cannot create payable time. If you are creating a "Positive" type workgroup, this field is optional.</p> <p>All time reporters in this group do not have to use the default schedule assignment. You can assign other schedules to each time reporter on the Assign Schedules page. This default is only for convenience. You can assign the same Schedule ID to several workgroups.</p> <p>If your time reporter is using the workgroup default Schedule ID and the Schedule ID is changed on the workgroup, the system deletes any Workday Overrides for that time reporter that are of a different type than the schedule assignment (such as Elapsed versus Punch), and have a date greater than or equal to the new schedule assignment.</p> <p>Changes to the workgroup Schedule ID will also trigger the Referential Integrity process. This means that any reported or payable time with a date greater than or equal to the date of the new assignment will be reevaluated by Time Administration. This is to allow for any corrections that may be needed if payable time was created from schedules or rules were run against schedules.</p>
<b>Timesheet Totals</b>	<p>This totalling option is used to determine total reported hours on the punch Timesheet. Select a totalling option for the workgroup default. Valid values are <i>Exclude Meals and Breaks</i>, <i>Include Breaks</i>, <i>Include Breaks and Meals</i>, or <i>Include Meals</i>.</p>
Rotation ID	<p>This field is displayed if the Schedule ID chosen is a Rotating Schedule ID.</p>
<b>Show Schedule Hours and Deviation</b>	<p>If this field is selected, additional fields appear on the Timesheet page. In the Timesheet grid, the <b>Schedule Hours</b> field appears. In the Reported Time Summary grid, the <b>Total Scheduled Hours</b> and <b>Schedule Deviation</b> fields appear.</p>

<b>Field or Control</b>	<b>Description</b>
<p>Create Partial Work Hours for Partial Absence</p>	<p>This check box affects generated or forecasted time differently depending on the method you use to generate time. When selected:</p> <ul style="list-style-type: none"> <li>• The Time Administration process creates the balance of time to sum to scheduled hours when either a partial day absence or no time has been reported. This occurs only for exception-type workgroups. This setting is ignored if the Schedule ID is defined as punch.</li> <li>• The first option on the Mass Time Reporting page creates the balance of reported time to sum to scheduled hours when either no time has been reported or if the time that has been reported from other sources is less than scheduled hours. Examples of other sources are absences, comp time taken, and leave time taken.</li> <li>• When forecasting time for both exception and positive workgroups, the system forecasts time to sum to scheduled hours when either no time has been reported or absence time has been reported.</li> </ul> <p>The reported time source code (RT_SOURCE) is set to SCH for all time that is created based on scheduled hours.</p> <hr/> <p><b>Note:</b> The default setting for the Create Partial Work Hours check box is cleared. The default setting forces the system to use full day absence logic when generating time, provided that the Regenerate Reported Time for Absence Entry check box is selected on the TL Installation page. If the Create Partial Hours check box is selected and the Regenerate Reported Time for Absence Entry check box on the TL Installation page is not selected, there is no impact on reported time.</p> <hr/>

<b>Field or Control</b>	<b>Description</b>
<p>Exclude Holiday for Generating Time</p>	<p>This check box affects generated or forecasted time differently depending on the method you use to generate time. The default setting for this option is cleared. With the default setting:</p> <ul style="list-style-type: none"> <li>• The Time Administration process creates reported or payable time on scheduled holidays for exception-type workgroups only. This setting is ignored if the Schedule ID is defined as punch.</li> <li>• The first option on the Mass Time Reporting page creates time on scheduled holidays for both exception and positive time reporters.</li> <li>• When forecasting time for both exception and positive workgroups, the system forecasts time to include scheduled holidays.</li> </ul> <p>The opposite occurs when the Exclude Holiday for Generating Time check box is selected: The system will not generate time on scheduled holidays or include holidays when forecasting time.</p> <p>The reported time source code (RT_SOURCE) is set to SCH for all time that is generated based on scheduled holidays.</p>

**Related Links**

[Setting Up System Defaults and Loading Dates](#)

“Understanding How to Compensate Employees in Global Payroll for Time Reported Through Time and Labor” (PeopleSoft Global Payroll)

[Understanding Work Schedules](#)

[Assigning Schedules](#)

[Assigning and Viewing Compensatory Time Plans](#)

[Establishing Time Periods](#)

[Establishing Compensatory Time Plans](#)

[Step 8: Matching Punches](#)

[Step 13: Post Rule Validation](#)

**Setting Up Day Breaker Options**

On the Workgroup - Definition page, access the Day Breaker Options group box.

In Time and Labor we refer to the point where one day crosses over to the next as the "day breaker." Although the day breaker is usually midnight—the moment when one calendar day becomes the next—you can set the day breaker to a different time to create virtual days that more closely mirror actual shifts worked by your time reporters. The system will then use the day breaker to determine the exact date under report (DUR) of each punch or collection of punches that comprise the shift. Based on the Day Breaker and what we refer to as the Day Breaker Options, you can:

- Assign all the time in a shift to a date based on when the first punch was logged.
- Assign the time to a date based on when the last punch was logged.

- Assign the time based on when the majority of the time in a shift was worked.
- Split the time between different dates on either side of the day breaker.

---

**Note:** Although the normal day breaker is midnight, the optimum day breaker for your company depends on your company's work hours. We recommend you choose a time when there are no shifts or time reporters scheduled to work so that you won't have to split time on either side of the day breaker. For example, if your company has two shifts, a morning and an evening shift with hours from 08:00-17:00 and 18:00-02:00 consecutively, you may want to choose 04:00 as your day breaker.

---

## Controlling the Date Under Report (DUR) of Reported Time

In Time and Labor, use the *Day Breaker* to define a "Day Breaker Range" (a virtual 24 hour day), and then choose a *Day Breaker Option* to control the DUR (date under report) assigned to reported time.

Consider the following example:

If the day breaker is 12 midnight, the virtual Day Breaker Range is a 24 hour period from 12:00:00 a.m. to 11:59:99 p.m. of a given calendar day.

To define the DUR Assigned to Reported Time:

1. Select a Day Breaker to Define a Day Breaker Range

In Time and Labor, each punch in a shift is associated with a virtual 24 hour time reporting period called the Day Breaker Range. This period begins with (includes) the Day Breaker at the beginning of the period and ends with the following Day Breaker (it does not include the next day breaker). Although you can create Day Breaker Ranges that coincide with actual calendar days (days that begin at 12:00 midnight and continue for 24 hours), the Day Breaker Range can begin whenever you want it to (because it represents a "virtual" 24 hour day rather than an actual calendar day).

Once you have defined your Day Breaker Range, you will assign punches to this range in Step 2 (below).

2. Select a Day Breaker Option to Assign Punches to a Day Breaker Range

To assign punches to one of the "ranges" you defined in Step 1, you must specify a **Day Breaker Option**.

Your options are as follows:

<b><i>Field or Control</i></b>	<b><i>Description</i></b>
<b>Begin Time of Shift</b>	Select this option if you want the system to assign all the punches in a shift to the Day Breaker Range in which the shift began.
<b>End Time of Shift</b>	Select this option if you want the system to assign all the punches in a shift to the Day Breaker Range in which the shift ended.

<i><b>Field or Control</b></i>	<i><b>Description</b></i>
<b>Majority of Shift</b>	Select this option if you want the system to assign all the punches in a shift to the Day Breaker Range in which the majority of the shift was worked.
<b>Split by Day Breaker</b>	Select this option if you want the system to split the shift between two Day Breaker Ranges on either side of the Day Breaker itself.

3. Move the DUR for the Punches Assigned to a Day Breaker Range Backwards or Forward.

For any punch (or collection of punches) assigned to a Day Breaker Range in Step 2, you can move the date under report (DUR) in two directions: towards the **Range Start Day** or towards the **Range End Day**.

<i><b>Field or Control</b></i>	<i><b>Description</b></i>
<b>Range Start Day</b>	Select this option if you want to assign punches within a Day Breaker Range to the calendar (or actual) day intersected by the start of the range.
<b>Range End Day</b>	Select this option if you want to assign punches within a Day Breaker Range to the calendar (or actual) day intersected by the end of the range.

**Establishing a DUR Example**

The following example illustrates how to use the Day Breaker and Day Breaker Options to define the date under report (DUR) of your employee's punch time. Assume the following:

- We've set the Day Breaker to 4:00 AM.
- We've chosen to assign all the punches in a shift to the Day Breaker Range on which the first punch was logged and our Day Breaker option is Begin Time of Shift.
- Our Day Breaker Range is Range End Day.
- Our shift begins at 9:00 PM on June 3 and ends at 6:00 AM on June 4. The shift therefore crosses the Day Breaker.

This scenario can be represented as follows:



This image illustrates the parameters of the example for establishing a DUR.

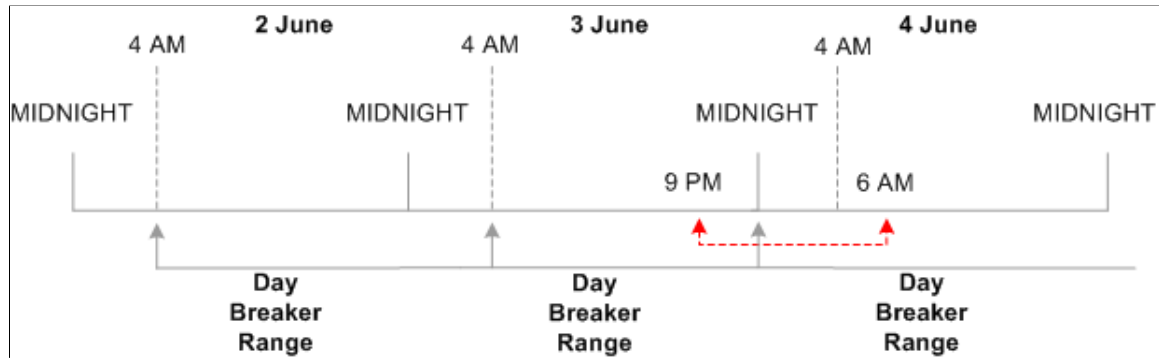

Because the first punch occurs at 9 PM on June 3, the system includes the entire shift within the Day Breaker Range in which the first punch falls—the range that begins at 4:00 AM June 3 and ends at 3:59 AM on June 4. However, the system will set the DUR for the shift as a whole to June 4. The reason for this is that the Day Breaker Range is Range End Day, and the day (the actual calendar day) intersected by end of the range is June 4.

---

**Note:** If we had set the Day Breaker Range to Range Day Start in this example, the DUR would be June 3, because the start of the range falls on the 3<sup>rd</sup> of June.

---

**Note:** If you change your Day Breaker or Day Breaker Options, the Referential Integrity process will trigger Time Administration to reprocess any affected payable time from the effective-dated change forward. Affected instances of time must be rerun through Time Administration to recreate payable time.

---

### Example 1

In this example, assume that a time reporter reports time that crosses the day breaker, which is set to 12 midnight.

The time reporter enters the following punches:

Punch IN: 18:00, December 31, 2005

Punch OUT: 07:00, January 1, 2006

Using this data, the following diagram shows the dates and day breaker ranges:

This image illustrates the dates and day breaker ranges for Example 1.

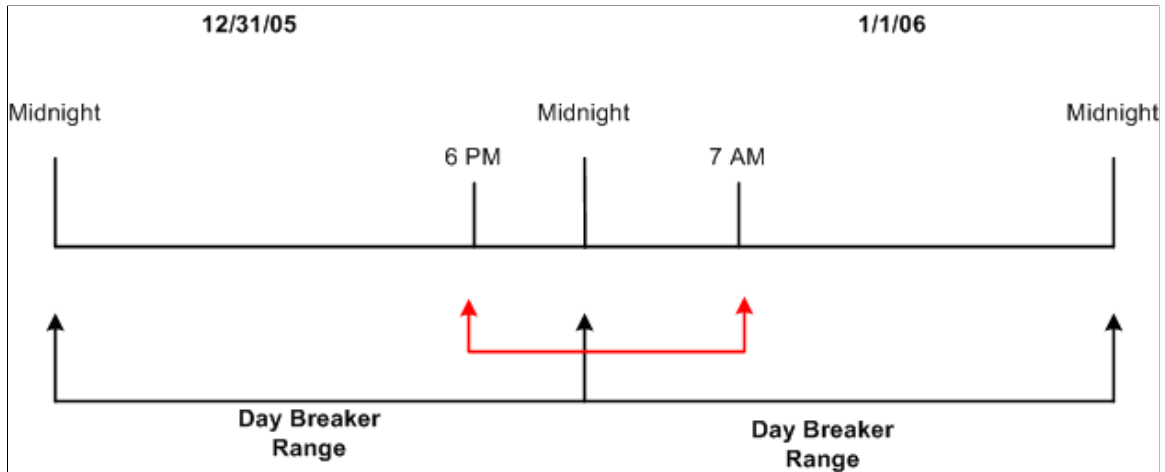

The results of applying different day-breaker options to the reported time are illustrated below:

<b>Day Breaker Option</b>	<b>Day Breaker Range</b>	<b>Resulting DUR</b>
Begin Time of Shift	Range Start of Day	December 31, 2005
End Time of Shift	Range Start of Day	January 1, 2006
Majority of Shift	Range Start of Day	January 1, 2006
Split by Daybreaker	Range Start of Day	6 hours fall on December 31, 2005 and 7 hours fall on January 1, 2006.
Begin Time of Shift	Range End of Day	December 31, 2005
End Time of Shift	Range End of Day	January 1, 2006
Majority of Shift	Range End of Day	January 1, 2006
Split by Day breaker	Range End of Day	6 hours fall on December 31, 2005 and 7 hours fall on January 1, 2006.

### Example 2

In this example, assume that the time reporter's time does not cross the day breaker. The day breaker is set to midnight.

The time reporter enters the following punches:

Punch IN: 13:00, 31 December 2005

Punch OUT: 21:00, 31 December 2005

The following diagram shows the dates and day breaker ranges, based on the data above:

This image illustrates the dates and day breaker ranges for Example 2.

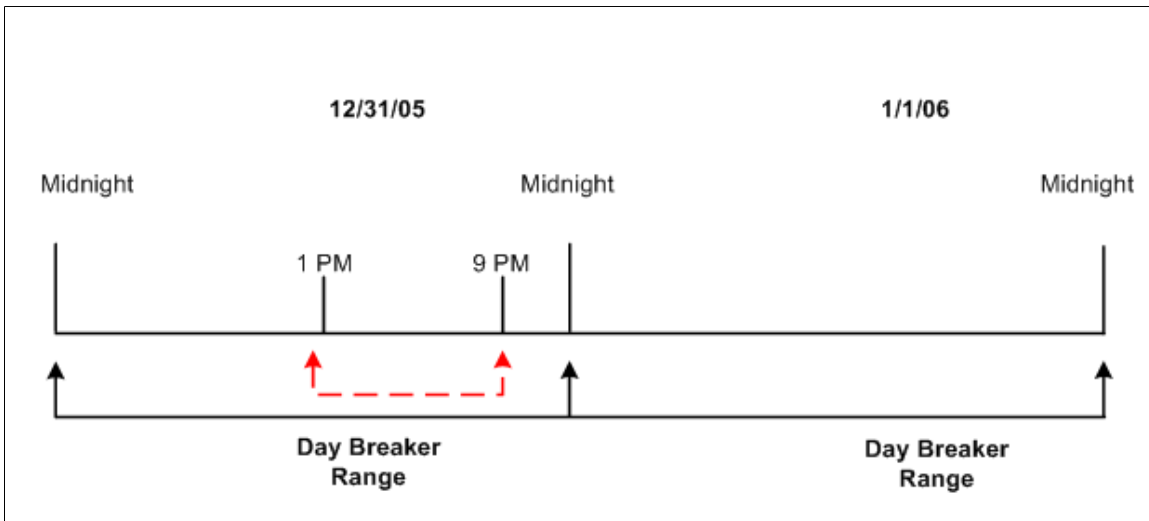

The results of applying different daybreaker options to the reported time are illustrated below:

<b>Day Breaker Option</b>	<b>Day Breaker Range</b>	<b>Resulting DUR</b>
Begin Time of Shift	Range Start of Day	Because the begin time of the shift (1:00 p.m.) is on December 31, 2005 and the Range Start of Day falls on the day of December 31, 2005, the resulting DUR is December 31, 2005.
End Time of Shift	Range Start of Day	Because the end time of the shift (9:00 p.m.) is on December 31, 2005 and the Range Start of Day falls on the day of December 31, 2005, the resulting DUR is December 31, 2005.
Majority of Shift	Range Start of Day	December 31, 2005
Split by Daybreaker	Range Start of Day	December 31, 2005
Begin Time of Shift	Range End of Day	Since the begin time of shift (1:00 p.m.) is on December 31, 2005 and the Range End of Day falls on the day of December 31, 2005, the resulting DUR is December 31, 2005.

<b>Day Breaker Option</b>	<b>Day Breaker Range</b>	<b>Resulting DUR</b>
End Time of Shift	Range End of Day	Since the end time of the shift (9:00 p.m. ) is on December 31, 2005 and the Range End of Day falls on the day of December 31, 2005, the resulting DUR is December 31, 2005.
Majority of Shift	Range End of Day	December 31, 2005
Split by Daybreaker	Range End of Day	December 31, 2005

### Example 3

In this example, assume that the time reporter's time does not cross the day breaker. The day breaker is set to 04:00.

The time reporter enters the following punches:

Punch IN: 18:00, 31 December 2005

Punch OUT: 02:00, 1 January 2006

The following diagram shows the dates and day breaker ranges, based on the data above:

This image illustrates the dates and day breaker ranges for Example 3.

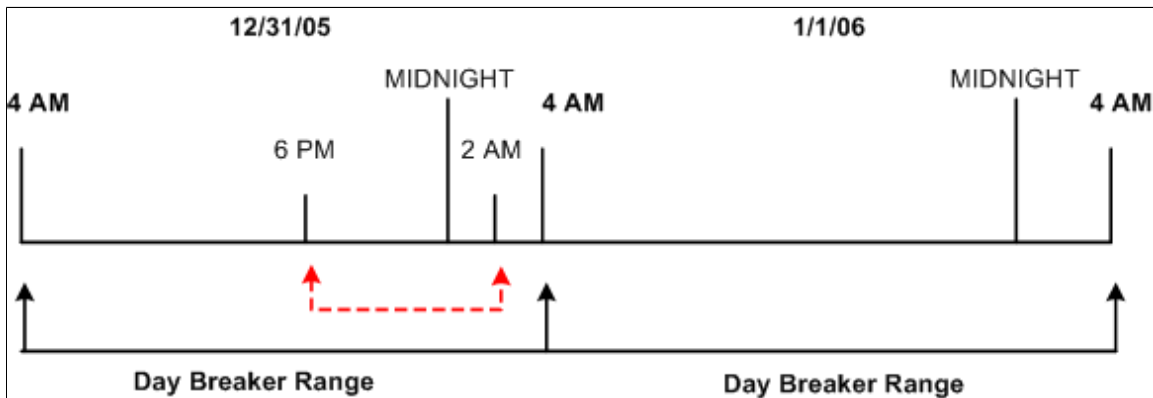

The results of applying different daybreaker options to the reported time are illustrated below:

<b>Day Breaker Option</b>	<b>Day Breaker Range</b>	<b>Resulting DUR</b>
Begin Time of Shift	Range Start of Day	December 31, 2005
End Time of Shift	Range End of Day	December 31, 2005

<b>Day Breaker Option</b>	<b>Day Breaker Range</b>	<b>Resulting DUR</b>
Majority of Shift	Range Start of Day	December 31, 2005
Split by Daybreaker	Range Start of Day	December 31, 2005
Begin Time of Shift	Range End of Day	January 1, 2006
End Time of Shift	Range End of Day	January 1, 2006
Majority of Shift	Range End of Day	January 1, 2006
Split by Daybreaker	Range End of Day	January 1, 2006

**Example 4**

In this example, assume that the time reporter reports time that crosses the day breaker, which is set to 4 AM.

The time reporter enters the following punches:

Punch IN: 18:00, December 31, 2005

Punch OUT: 07:00, January 1, 2006

The diagram below shows the dates and day breaker ranges based on the data above.

This image illustrates the dates and day breaker ranges for Example 4.

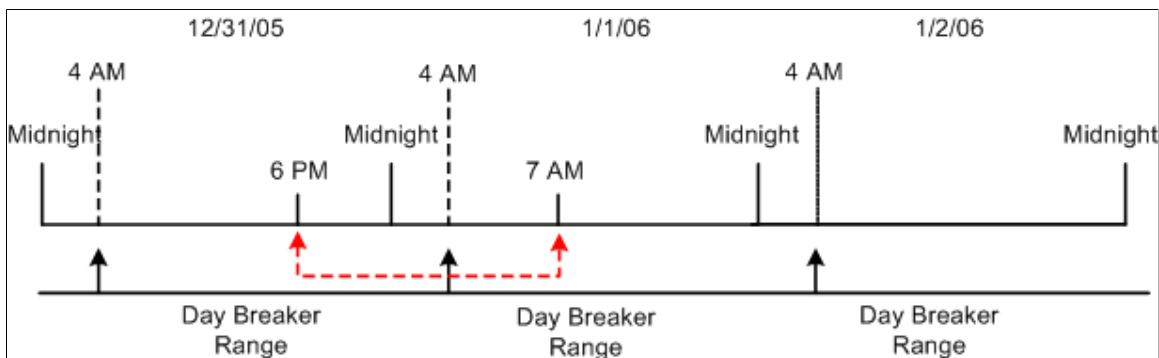

The results of applying different daybreaker options to the reported time are illustrated below:

<b>Day Breaker Option</b>	<b>Day Breaker Range</b>	<b>Resulting DUR</b>
Begin Time of Shift	Range Start of Day	Because the begin time of the shift (6:00 p.m.) is on December 31, 2005 and the Range Start of Day falls on the day of December 31, 2005, the resulting DUR is December 31, 2005..
End Time of Shift	Range Start of Day	Because the end time of the shift (7:00 a. m.) is on January 1, 2006 and the Range Start of Day falls on the day of January 1, 2006, the resulting DUR is January 1, 2006.
Majority of Shift	Range Start of Day	December 31, 2005
Split by Daybreaker	Range Start of Day	10 hours fall on December 31, 2005 and 3 hours fall on January 1, 2006.
Begin Time of Shift	Range End of Day	Because the begin time of the shift (6:00 p.m.) is on December 31, 2005 and the Range End of Day falls on the day of January 1, 2006, the resulting DUR is on January 1, 2006.
End Time of Shift	Range Start of Day	Because the end time of the shift (7:00 a. m.) is on January 1, 2006 and the Range Start of Day falls on the day of January 2, 2006, the resulting DUR is January 2, 2006.
Majority of Shift	Range End of Day	January 1, 2006
Split by Daybreaker	Range End of Day	10 hours fall on January 1, 2006 and 3 hours fall on January 2, 2006.

## Related Links

[Step 8: Matching Punches](#)

---

## Making Workgroup Transfers

This section discusses the effect of workgroup transfers on the period of interest calculation in Time Administration as well as on rules processing. Because mid-period workgroup transfers can cause rules to

be applied incorrectly, we strongly recommend that you schedule workgroup transfers to take place only at the beginning of a period.

---

**Important!** This section assumes that you have a thorough understanding of how Time Administration defines the period of interest for rules processing. If you are not familiar with the concept of the "period of interest," you should review the section on Batch Processing in Time Administration before reading the following section.

---

## Transferring in the Current Period

If an employee transfers from one workgroup to another in the current period, Time Administration processes the employee in two separate batches—one for each workgroup. When Time Administration creates the rule map for each batch, it adjusts the start and end dates of the period of interest to reflect the effective date of the transfer according to the following rule: *If the effective date of the new workgroup is greater than the initial period of interest begin date, the start date for the batch associated with the new workgroup will be set equal to the new workgroup effective date.*

### Example

In this example let's assume the following:

- A time reporter changes workgroups on 9 June—in the middle of the current workgroup period (5 to 11 June).
- The Time Period ID associated with each workgroup is weekly (the week begins on Monday and ends on Sunday).
- Each workgroup has a rule program containing 3 rules with the same rule periods (a weekly rule, a monthly rule, and a daily rule). However, the rules are different for each workgroup.

---

**Note:** To determine the initial period of interest, Time Administration uses the Time Period ID on each time reporter's workgroup to determine the start date and the end date of the period intersected by the earliest change date. Any time reporter whose Earliest Change Date is less than or equal to the through date on the run control panel will be picked up when you run time administration—as long as his or her effective dates fall within the workgroup period, or their Max (maximum) `TL_EMPL_DATA.EFFDT <=` to the earliest change date. In addition, their `TL_TR_STATUS.TA_STATUS` must equal 'Y.'

---

This image illustrates the example of transferring a workgroups in the current period.

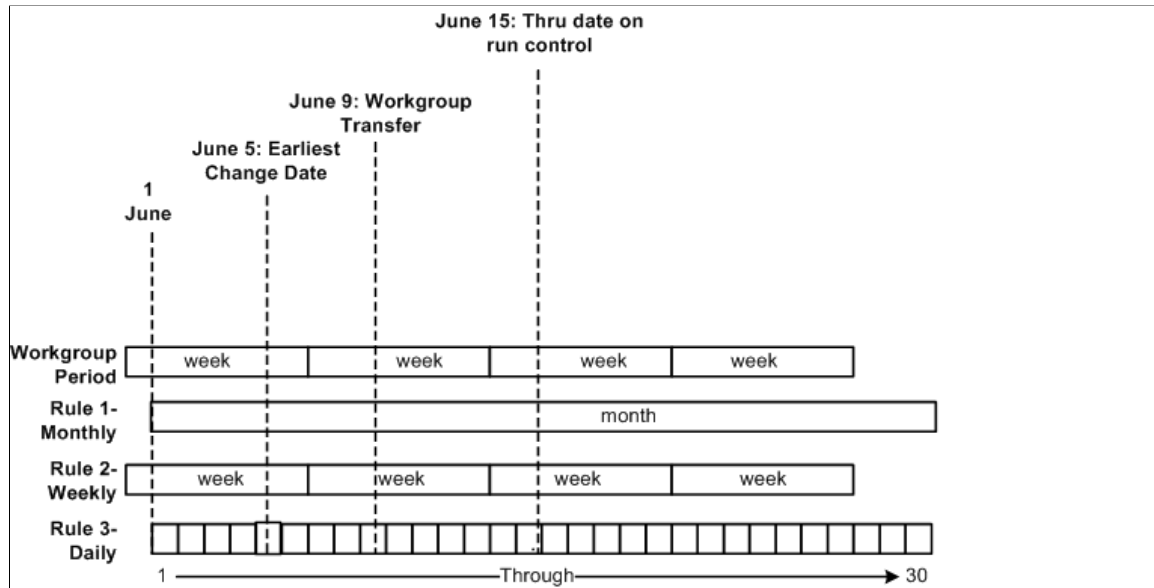

In this example Time Administration sets the end date of the period of interest associated with the old workgroup to 8 June (the last day the employee is part of the old workgroup), and the start date of the period of interest associated with the new workgroup to 9 June. The rules associated with the old workgroup are used to process all dates before and including 8 June—going back to the final period of interest start date. The rules associated with the new workgroup are used to process all dates from 9 June to the final period of interest end date. However, because the transfer occurs in mid-week, the weekly and monthly rules (for both workgroups) will not have access to data for their entire rule periods and may be applied incorrectly. (Any rule crossing the transfer date could be applied incorrectly). For this reason, we recommend that you change workgroups at the beginning of a period whenever possible. If you absolutely must change workgroups in mid-period, you will have to override rules processing and manually enter the hours to be paid during the transfer period as follows:

To report time for the transfer period:

1. Enter the time manually through the time reporting pages

Enter time manually for the transfer period exactly as the time reporter should be paid (including overtime hours). This time will go directly to Payable Time (see step 2).

2. Enter dates for the transfer period on the Override Rules page

To tell Time Administration to accept time exactly as you enter it (untouched by rules), you must enter the dates for the transfer period on the Override Rules for Time Reporters page. Time Administration will extract records from TL\_IPT1 into a working table—TL\_TA\_RUL\_OVR—before applying rules to the data stored on TL\_IPT1. Time Administration will apply rules to all records stored on TL\_IPT1 and update Payable Time as usual. But, as a final step, it uses data stored in the TL\_TA\_RUL\_OVR table (preserved, untouched by rules) to replace records found on the TL\_PAYABLE\_TIME table.

---

**Note:** Time Administration will not change hours entered as rule overrides. Rule overrides go directly to Payable Time.

---



---

**Note:** The same logic that governs workgroup transfers governs changes to Rule Program effective dates as well as TL\_EMPL\_DATA effective dates—effective dates associated with employee hires, inactivation, or job transfers. So, for example, if the rule program associated with a workgroup changes in mid-period, the start and end dates of the period of interest must be adjusted. Similarly, because a time reporter could have more than one row in TL\_EMPL\_DATA with different effective dates, multiple rows per time reporter can be pushed into the batch creation process. In this case, start dates and end dates must be adjusted for such things as the TL\_EMPL\_DATA.EFFDT falling within the period of interest. For example, if the EFFDT of a time reporter is greater than the START\_DT of the period of interest, the START\_DT will be set equal to the EFFDT.

---

### A Note on Retroactive Transfers

Retroactive workgroup transfers can also prevent rules from being applied correctly—for the same reason that transfers in the current period affect rules processing. Thus, in the previous example, if we assume that the transfer occurs during a period that has already been processed, the weekly and monthly rules may again be applied incorrectly. As in the previous example, we recommend that you change workgroups at the beginning of a period whenever possible. If you absolutely must change workgroups mid-period, you will have to manually enter the hours to be paid during the transfer period as rule overrides.

---

**Note:** In the case of retroactive transfers there is an additional factor to consider: the period you are reprocessing with new rules has already been processed, which means that offsets to the original data will be created, new data will be generated, and both the new and old results will be passed to Payable Time.

---

### Related Links

[Understanding Time Reporting](#)

---

## Making Changes to a Rule Program of a Workgroup

There may be times when you need to change the rules in the rule program associated with a workgroup. These rule changes could occur during the current processing period as well as retroactively. For example, you might need to go back in time to apply new rules to previously reported time. The time data as originally reported isn't different, but the way the data needs to be processed has changed. For this reason it is important to understand some of the implications of changing the rules in a rule program.

### Understanding the Consequences of Rule Changes

The same logic that governs mid-period workgroup transfers applies to mid-period changes to rule program effective dates. For example, if the rule program changes in mid-period, the start and end dates of the period of interest must be adjusted and rules could be applied incorrectly. For this reason, we strongly recommend that you schedule rule program changes to occur at the beginning of a period whenever possible. If you absolutely must change your rule program in mid-period, you will have to override rules processing and manually enter the hours to be paid during the transfer period. Because the effect of mid-period changes to workgroup data is discussed in the section Making Workgroup Transfers, you should review the material in that section prior to modifying your rules. There are, however, some additional precautions you should observe when changing rules:

- You should never make changes directly to rules themselves. This could result in incorrect results if you need to reprocess prior period time using the rule definitions that were valid in the prior periods.

Also, rules are part of rule programs, which are used by workgroups, and reference TRC programs. So if you change a rule this change will have multiple impacts throughout the system.

- Instead of modifying rules, you should do the following:
  - Create a new rule: modify the existing rule and save it as a new rule with a new rule ID, or create a new rule from scratch.
  - Insert a new effective-dated row in the Rule Program.
  - Remove the old rule from the new effective-dated rule program and insert the new rule.
  - If the effective date of the change is set to a prior period, data for prior periods will be reprocessed.

---

**Note:** You cannot reprocess dates for a time reporter in a workgroup prior to the effective date of the workgroup itself. In other words, if the workgroup effective date is 1/1/2006 you cannot reprocess dates prior to 1/1/2006. Similarly, you can not reprocess dates for a time reporter in a workgroup prior to the date that the time reporter was enrolled in the workgroup.

---

## **Related Links**

[Adding Rules to a Rule Program](#)

## Chapter 6

# Establishing Time Reporting Codes

## Understanding Time Reporting Codes

Time Reporting Codes (TRCs) represent the level at which an organization actually needs to track employee time to support all of its administrative and compensation needs. For example, for payroll processing you establish an Earnings Code for Regular time (REG) and for time reporting you establish TRCs for all versions of regular time, such as tardy-paid, meeting-nonproductive, sick-paid, and so on.

We define a TRC as an element of compensation or a bucket of several elements in which the system collects labor data, hours, amounts, or units worked.

There may be times when you will need to use more than one payroll system; with Time and Labor, you can establish earnings code attributes so that any payroll system can be synchronized with Time and Labor's TRCs. Also, you can copy the attributes from Payroll for North America earnings codes for ease of integration.

You assign TRCs to TRC Programs, which are ultimately assigned to workgroups. Multiple workgroups can share these TRC Programs. We also provide the ability to clone a TRC program, which makes implementing the system easier.

Since Time and Labor controls eligibility of pay through TRC programs, you may be able to reduce the number of earnings programs that must be created. The TRC program specifies valid TRCs for an employee, which are mapped to earnings codes. For example, you could create an earnings program containing all possible earnings codes for time reporters, and the TRC program controls which earnings codes are applicable to each time reporter (through TRCs).

A TRC category is used to group together TRCs for summation (viewing time online) and reporting purposes.

## Common Elements Used in This Section

<b><i>Field or Control</i></b>	<b><i>Description</i></b>
<b>Time Reporting Code (TRC)</b>	TRC is an element of compensation or a bucket of several elements in which the system collects labor data, hours, amounts, or units worked.
<b>TRC Category</b>	A TRC Category groups together TRCs for summation and reporting purposes.
<b>Units of Measure (UOM)</b>	The increments by which you measure time worked, pay periods, or other elements to be reported.

<i>Field or Control</i>	<i>Description</i>
<b>TRC Program</b>	The time reporting code program of rules usually assigned by workgroup.

## Defining Time Reporting Code (TRC) Categories

To define time reporting code categories, use the TRC Category (TL\_TRC\_CATEGORY) component.

Time and Labor enables you to group TRCs together for summation and reporting purposes. You can set up and define TRC categories that you want to use. For example, you can create a TRC category called Absence with individual TRCs of PTO, Bereavement, and Military Leave, all of which can be mapped to the TRC category of Absence.

### Pages Used to Define Time Reporting Code (TRC) Categories

<i>Page Name</i>	<i>Definition Name</i>	<i>Usage</i>
<u>TRC Category Page</u>	TL_TRC_CATEGORY	Define TRC Categories.

### TRC Category Page

Use the TRC Category page (TL\_TRC\_CATEGORY) to define TRC Categories.

Navigation:

**Set Up HCM > Product Related > Time and Labor > Time Reporting > TRC Category > TRC Category**

This example illustrates the fields and controls on the TRC Category page. You can find definitions for the fields and controls later on this page.

TRC Category						
TRC Category		Personalize   Find		First 1-24 of 24 Last		
TRC Category	Description	Short Description	Reported Time Approval Display	Payable Time Approval Display		
KNTWRK	Hours Not Worked	Hours Not	<input type="checkbox"/>	<input type="checkbox"/>	+ -	
KOVT	Overtime	Overtime	<input type="checkbox"/>	<input type="checkbox"/>	+ -	
KSCK	Sick Time	Sick Time	<input type="checkbox"/>	<input type="checkbox"/>	+ -	
KVAC	Vacation	Vacation	<input type="checkbox"/>	<input type="checkbox"/>	+ -	
KWORK	Hours Worked	Hours Work	<input type="checkbox"/>	<input type="checkbox"/>	+ -	
LEAVE	Leave	Leave	<input checked="" type="checkbox"/>	<input checked="" type="checkbox"/>	+ -	
MADHO	Holiday	Leave	<input checked="" type="checkbox"/>	<input checked="" type="checkbox"/>	+ -	
MCOMPE	Comp Earned		<input type="checkbox"/>	<input type="checkbox"/>	+ -	
MCOMPT	Comp Taken	Comp Taken	<input type="checkbox"/>	<input type="checkbox"/>	+ -	
MCPER	Comp Time - Earn		<input type="checkbox"/>	<input type="checkbox"/>	+ -	
MCPTK	Comp Time - Take		<input type="checkbox"/>	<input type="checkbox"/>	+ -	
MDBL	Doubletime 2		<input type="checkbox"/>	<input type="checkbox"/>	+ -	
MDBOVT	OVERTIME		<input type="checkbox"/>	<input type="checkbox"/>	+ -	
MLEAVE	Leave Taken	Leave	<input type="checkbox"/>	<input type="checkbox"/>	+ -	
MNONWK	Non-Worked	Non-Work	<input type="checkbox"/>	<input type="checkbox"/>	+ -	

Field or Control	Description
<b>Reported Time Approval Display</b>	Check to display the category on the Reported Time Approval page. You can only check up to 3 (three) categories to display.
<b>Payable Time Approval Display</b>	Check to display the category on the Payable Time Approval page. You can only check up to 3 (three) categories to display.

**Note:** The Timesheet configuration is still set on the TL Installation table but a note on the TRC Category page lets you know that all categories that have time reported to them will appear on the Timesheet and that you need to go to the TL Installation table to disable.

## Defining and Mapping Time Reporting Codes (TRCs)

To define and map time reporting codes, use the Time Reporting Codes (TRC) (TL\_TRC\_MAIN\_PNLGRP) component. Use the TL\_TRC\_MAIN\_PNLGRP component interface to load data into the tables for this component.

Time and Labor enables you to keep track of reporting information at the TRC level—information that's not required for payment of time. For example, Time and Labor can keep track of actual or compensation hours but will not send that information to payroll, unless you actually need to display the time on the employee's pay advice statement. In this way, your payroll system is protected from reporting detail that could potentially inhibit optimal processing performance.

In Time and Labor, you must explicitly map TRCs to payroll earnings codes. However, a TRC does not have to be mapped to an earnings code if you intend to use the TRC to collect labor information for reporting or analysis by financial systems. When a TRC is not mapped, the system does not send the information to payroll for payment.

This section discusses how to define and map Time Reporting Codes.

## Synchronizing TRCs with NA Earnings Codes

We enable you to synchronize your TRCs to Payroll for North America Earnings Codes using the Map to NA Earnings Code feature. For other pay systems, you will have to manually enter Earnings Codes in the Mapping to Earnings Code section of the TRC Setup page.

When you choose the Map To NA Earnings Code feature, and click on the Sync button, all of the effective-dated rows of that earnings code are carried over to the TRC Definition. There is no difference in effective-dated rows on the TRC and the NA Earnings Code. This enables Time and Labor to choose the right row when calculating estimated gross and keeps the system in sync with the NA Earnings codes. The field values that are carried over from the NA Earnings Code to the TRC are as follows:

- *Effective Date*
- *Multiplication Factor*
- *Rate Adjustment Factor*
- *Flat Amount* (the Flat Amount on the Earnings Code populates the Flat Amount element on the TRC)
- *Unit/Override Rate* (the Unit/Override Rate on the Earnings Code populates the Rate element on the TRC)
- *Description*
- *Short Description*
- *Add to Gross Flag* (the Add to Gross value from the NA Earnings Code initially populates the Distribute Costs Flag on the TRC, although you can change the value)

---

**Note:** When creating a new TRC, the current system date becomes the effective date. This effective-dated row will remain after synchronizing with a NA Earnings Code. This row will inherit the attributes of the maximum effective-dated row on the NA Earnings Code that is less than the effective date on the TRC.

---

The following table describes how the system handles fields based on your synchronize to NA Earnings Codes choices.

<b>Action</b>	<b>What the System Does</b>
When your TRC is not synchronized to a NA Earnings Code	The Flat Amount and Rate fields are hidden because they are only used when you map to a NA Earnings Code.
When your TRC is synchronized to a Units Earnings Code	<p>The Flat Amount element is hidden and defaults to Selected.</p> <p>The Rate field is displayed with the value from the NA Earnings Code.</p> <p>The Rate Overridable field is hidden and defaults to <i>Not Selected</i>.</p>
When your TRC is synchronized to a Flat Amount NA Earnings Code	<p>The system displays the Flat Amount value from the NA Earnings Code.</p> <p>The Per Instance Overridable field is hidden and defaults to <i>Not Selected</i>.</p> <p>The Rate and Overridable fields are hidden and default to <i>Selected</i>.</p>
When you unsynchronize a TRC from a Flat Amount or Unit Override/Rate NA Earnings Code	The Rate Overridable and Per Instance Overridable fields are hidden and default to <i>Selected</i> .
If a reported rate is different from the Rate on the TRC, and the TRC is synchronized to a NA Earnings Code	We provide a PeopleSoft delivered rule that you can include in your Rule Program that will change the reported Rate to the TRC rate in Payable Time. The rule is TL_UPDOVRR.
If a reported QTY and Currency Code do not match the Flat Amount and Currency Code on the TRC	We provide a PeopleSoft delivered rule that you can include in your Rule Program in which the reported QTY and Currency Code are changed to the QTY and Currency Code for the TRC in Payable Time. The rule is TL_UPDQTY.
If an Override Rate is reported in Time and Labor and one already exists on the Earnings Code definition	The rate on the Earnings Code definition takes precedence.
If there is an Amount Value in the Quantity field in Time and Labor, and the NA Earnings Code has a Flat Amount value defined	The Flat Amount on the Earnings Code takes precedence.

**Note:** Knowing which fields take precedence in the above table is important when setting up your TRCs and Earnings Codes in order to ensure that payment occurs the way you want it to.

## Deleting the Mapping to an Earnings Code

If you choose to delete a middle or maximum effective-dated row on a NA earnings code which is mapped to a TRC, we recommend that you unsynchronize the current mapping, then reselect the same NA earnings code and click the **Sync** button again. The system will automatically populate the mapping earnings code section of the page with the valid NA earnings code from the prior row.

If you delete the mapping to a NA earnings code for the minimum effective-dated row, we recommend that you manually map to another active NA earnings code.

## Inactivating the Mapping to a Earnings Code

If you choose to inactivate the effective-dated row on an NA earnings code that is synchronized to a TRC, we recommend that you unsynchronize the current mapping and then reselect the same NA earnings code and click on the **Sync** button again. This way you can ensure that the common attributes are being copied appropriately. In addition, we recommend that you check for inactive rows for the mappings and decide if you want to resynchronize to a different earnings code.

## Unsynchronizing a TRC From an NA Earnings Code

If you no longer want to have your TRC synchronized to your NA earnings code:

- Remove the earnings code in the **Map to NA Earnings Code** field and click the **Unsync** button:
- You will receive the following warning message: "Do you wish to unsync this TRC? If you click on *OK*, then any future changes to the North American earnings code will not be updated to the TRC Table."
- Click **OK**.
- You are then left with synchronized rows from the NA earnings code on the TRC in which the fields are no longer controlled by the NA earnings code and are ready for you to edit. The system maintains the mapping to the same NA earnings code as if you were manually mapped to that code. You can delete rows or change fields at this point. You are still mapped to the earnings code for payment of the time associated with this TRC.

## Pages Used to Define and Map Time Reporting Codes

<i>Page Name</i>	<i>Definition Name</i>	<i>Usage</i>
<a href="#">Time Reporting Codes - Definition Page</a>	TL_TRC_PNL1	Define Time Reporting Code attributes and map TRCs to earnings codes.
<a href="#">Time Reporting Codes - Approval and Comment Page</a>	TL_TRC_PNL2	Set up compensation and interface options and enter optional comments.

## Related Links

“Establishing Earnings Codes” (PeopleSoft Payroll for North America)



## Time Reporting Codes - Definition Page

Use the Time Reporting Codes - Definition page (TL\_TRC\_PNL1) to define Time Reporting Code attributes and map TRCs to earnings codes.

Navigation:

**Set Up HCM > Product Related > Time and Labor > Time Reporting > Time Reporting Codes - TRC > Definition**

This example illustrates the fields and controls on the Time Reporting Code - Definition page. You can find definitions for the fields and controls later on this page.

The screenshot displays the 'Definition' tab of the 'Time Reporting Code - Definition' page. At the top, it shows 'Time Reporting Code 100'. Below this, there are two main sections: 'Mapping Options' and 'Time Reporting Code'. The 'Mapping Options' section includes a checkbox for 'Map to Absence Management', a search field for 'Map to NA Earnings', and a 'Synchronize' button. The 'Time Reporting Code' section contains various input fields and controls:
 

- \*Effective Date: 01/01/1980
- \*Description: Regular - Productive
- \*Type: Hours
- TRC Category: (Searchable)
- Unit of Measure: (Searchable)
- Minimum Quantity: (Empty)
- Multiplication Factor: 1.0000
- Rate Adjustment Factor: (Empty)
- \*Effect On Comp/Leave: No Comp Time Effect
- \*Status: Active
- Short Description: Regular -
- Rules Only TRC: (Unchecked)
- Used In Labor Dilution: (Unchecked)
- Distribute Costs: (Checked)
- Maximum Quantity: (Empty)

 Below these are two sub-sections: 'Hours Represent' with radio buttons for 'Actual Hours' (selected) and 'Compensation Only Hours'; and 'Interface Options' with checkboxes for 'Send to Payroll' (unchecked), 'Send To TCD' (checked), and 'Publish to Projects' (checked). At the bottom, the 'Mapping To Earning Codes' section includes fields for 'Payroll System' and 'Earnings Code', along with a '\*Status' dropdown set to 'Active'.

**Note:** Before mapping a TRC to a Global Payroll Take code or earnings code, you must have a User Roles Profile that is set up in the Global Payroll system in order to view these codes.

<b>Field or Control</b>	<b>Description</b>
<b>Time Reporting Code</b>	This field displays the value that you entered to access this page.

<b>Field or Control</b>	<b>Description</b>
<b>Map to Absence Management</b>	<p>Select this check box if you want to use this TRC in absence processing. When you select this option, the system displays fields in the <b>Mapping to Earnings Codes</b> group box that correspond to the values you select in the <b>Payroll System</b> field: If <i>GP</i> is selected, the <b>Absence Take Code</b> and <b>Earnings Code</b> fields are displayed. If <i>NA</i> is selected, the <b>Absence Earnings Code</b> and <b>NA Earnings Code</b> fields are displayed. This occurs only if you have selected <b>Absence Management</b> on the General Installation Options page.</p>
<b>Map To NA Earnings</b>	<p>Select the North American earnings code from which you want to map this TRC from the drop-down list. The system derives the valid values from the Earnings Code table you set up in your Payroll for North America system. It displays values that are active. This element will only be displayed when you have selected <b>Payroll for North America</b> on the General Installation Options page.</p> <p>You can choose not to use the Map To NA Earnings Code feature. You may want to do this if you need to calculate the TRC estimated gross differently than you would calculate the associated earnings for the Payroll for North America.</p> <hr/> <p><b>Note:</b> An Absence TRC can be simultaneously used for both GP absence processing and NA absence processing. You can also map a TRC to NA Payroll and select GP as your pay system under Mapping to Earnings Codes along with an associated earnings code for this TRC. In this way, you can make use of one TRC for both pay systems. Important! You must select your TRC Type before you map and synchronize your TRC to your earnings code. The Mapping to NA Earnings Code feature will be enabled once you choose the TRC Type. This will assist you with the proper pairing of TRC Type to earnings code payment types from your earnings code.</p>

<b>Field or Control</b>	<b>Description</b>
<b>Synchronize and Unsynchronize</b>	<p>Select the <b>Synchronize</b> button if you want the system to carry over all of the effective-dated rows of that earnings code to the TRC definition from your NA Payroll system.</p> <p>The system copies over the Multiplication Factor and Rate Adjustment Factor and they retain the same names on the TRC. The Add to Gross Flag on the NA Earnings Code initially defaults to the Distribute Costs Flag on the TRC, though you can edit this field after you synchronize. If there is a Flat Amount on the NA earnings code, it defaults to the Flat Amount field on the TRC. If there is a Unit/Override Rate on the NA earnings code, it defaults to the Rate field on the TRC.</p> <p>You can choose to leave the Description and Short Description fields blank; the system will copy over these two field values from the NA earnings code.</p> <p>Before clicking the <b>Synchronize</b> button, you must select a NA earnings code. Effective-dated rows on TRC and the NA earnings code will be the same after the synchronize process is completed. In this way, Time and Labor selects the right row when calculating estimated gross, and won't be out of synch with the NA Earnings code. However, if you create the TRC after the current effective-dated row of the NA earnings code, you will have an extra row on the TRC. You can also insert an effective-dated row on the TRC between the synchronized rows from the NA Earnings Code. If you do, the elements in common from the NA earnings code are copied down to the new row on the TRC.</p> <p>If you inactivate the minimum effective-dated row of a NA earnings code that is synchronized to a TRC, you will receive the following warning message: Selected Earnings Code is Active with the following TRCs (REG, MOREG, MEG, MCREG, KUREG, KUMLO, KUCT3, KUCT2, KUCT1, KDSAD,) (13500,169) Selected Earnings Code is Active with TRCs, do you wish to inactivate the Earnings Code now? The status of the Earnings code mapping on the TRC will be set to inactive. Do you wish to update the TRCs which are mapped to this Earnings Code now?</p> <p>If you inactivate the maximum effective-dated row on the NA earnings code, you will receive the following warning message: Selected Earnings Code is in Sync with the following TRCs (%1). If you hit OK the TRCs shown will get unsynched and you have to map those TRCs to another earnings code. Do you wish to Unsync these TRCs mapped to this NA Earnings Code now? (13500, 150).</p> <p>If you delete a row on the NA earnings code which is synchronized to a TRC, you will receive the following warning message: Selected earnings code is Active with the following TRCs (%1). Make sure that you re-sync the TRC to the NA earnings code in Time and Labor (13500, 180).</p>
<b>Status</b>	<p>Select an <i>Active</i> or <i>Inactive</i> status for this TRC. The default is <i>Active</i>. A row that is synchronized with a NA earnings code always defaults to <i>Active</i> and is unavailable for entry.</p>

<b>Field or Control</b>	<b>Description</b>
<b>Type</b>	Select a TRC Type from the drop-down list. Valid values are <i>Amount</i> , <i>Hours</i> , or <i>Units</i> . If you select a Type of <i>Amounts</i> you cannot enter a rate in the Rate field; also the Rate Adjustment Factor and Multiplication Factor will become unavailable for entry. Only a TRC Type of <i>Hours</i> can be used for Labor Dilution.
<b>Rules Only TRC</b>	Select this check box to denote a TRC as being used only by Rules in Time Administration.

This table provides the valid TRC Type combinations with Earnings Types, Comp Rate Code Types, and TL Quantities.

<b>TRC Type</b>	<b>Earnings Payment Type</b>	<b>Comp Rate Code Type</b>	<b>TL Quantity</b>
H – Hours	B – Both Hours and Amounts OK	Not Allowed	
	E – Either Hours or Amounts OK	HR – Hourly Rate	
		HF – Hourly + Flat Amount	
		PC – Percent	
	H – Hours Only	HR – Hourly Rate	
		HF – Hourly + Flat Amount	
		PC – Percent	
	U – Unit/Override Rate	Not Allowed	
A – Amounts	A – Amounts Only	FA – Flat Amount	Must be zero
	B – Both Hours and Amounts OK	FA – Flat Amount	Must be zero
	E – Either Hours or Amounts OK	FA – Flat Amount	Must be zero

<b>TRC Type</b>	<b>Earnings Payment Type</b>	<b>Comp Rate Code Type</b>	<b>TL Quantity</b>
		HF – Hourly + Flat Amount	
		HR – Hourly Rate	
		PC – Percent	
	F – Flat Amount	Not Allowed	
U – Units	B – Both Hours and Amounts OK	Not Allowed	
	E – Either Hours or Amounts OK	HF – Hourly + Flat Amount	Must be zero
		HR – Hourly Rate	
		PC – Percent	
	H – Hours Only	HF – Hourly + Flat Amount	
		HR – Hourly Rate	
		PC – Percent	
	U – Unit/Overridable Rate	Not Allowed	

Additional points to consider when reporting Comp Rate codes in Time and Labor include the follow:

1. Do not select the **Base Pay** check box for any Comp Rate code that is positively reported in Time and Labor.
2. A Comp Rate Code cannot be paid if the reported TRC is mapped to earnings code that has a **Payment Type** defined as *Amounts Only* and also has a value entered in the **Earnings Adjustment Factor** field.
3. For Comp Rate Codes with an *Hourly Rate* or *Flat Amount* **Rate Code Type**, you cannot report an Override Rate.
4. For Comp Rate Codes with a Percent or Hourly Rate + Flat Amount rate code type, you can report an Override Rate.
5. Only Comp Rate Codes with a value of *None* in the **Calculated By** field are valid for Time and Labor.

<b>Field or Control</b>	<b>Description</b>
<b>TRC Category</b>	<p>Use this field to specify whether to group this TRC in a TRC category. For example, the TRC of <i>REG</i> could be assigned to a TRC Category of <i>Time Worked</i>.</p> <p>Only one category can be assigned to a TRC.</p> <hr/> <p><b>Note:</b> This field only appears if a value of <i>Hours</i> is selected for the <b>Type</b> field.                      In addition, on the TL Installation table, the <b>Display Reported Hours Summary</b> field must be selected to show TRC Categories on the Approve Payable Time page, and/or the Time Reporting page.</p>
<b>Currency Code</b>	<p>Select the Currency Code for an <i>Amount</i> TRC type. If you change the Currency Code for this TRC, all quantities in payable time from the time of the change associated with this TRC will reflect the new currency code. The Currency Code element only appears and is valid for Amount TRC types.</p>
<b>Used in Labor Dilution</b>	<p>Select the <b>Used in Labor Dilution</b> check box if you want this TRC to be used during Labor Dilution. You must select a TRC Type of Hours; otherwise this check box is unavailable for entry. If you change this field to selected, all time associated with this TRC will be diluted as of the effective date. Time that has already been distributed will not be diluted. If you select this check box, the system also selects the <b>Distribute Costs</b> check box and it will be unavailable for entry.</p>
<b>Unit of Measure</b>	<p>Select a unit of measure if you entered <i>Units</i> in the <b>Type</b> field. The <b>Unit of Measure</b> field needs to be populated if you are integrating with PS Projects and PS EPM, whether it is an Hours or Units type TRC. This field also needs to be populated as it is included with payable time when sent to PS Projects and PS EPM, for further rate processing in these other products.</p>
<b>Distribute Costs</b>	<p>Select this check box if the TRC will participate in the Labor Distribution process when costs are returned from a payroll system. During the synchronize process with a NA earnings code, the value of this field will default from the <b>Add to Gross</b> option on the NA earnings code. You can change this value after the sync process. In most cases, earnings add to gross pay. However, certain types of earnings may not. One example is an earnings that is not a monetary payment, such as the value of a company-supplied automobile. Because the company supplies the employee with a car and not the money to buy one, these earnings should not add to gross.</p>

<b>Field or Control</b>	<b>Description</b>
<b>Minimum Quantity</b>	Use this field to define your limits for time entry for any TRC type. For example, if you set the value in this field to 4, and a user reports a value of 2, the system will generate an exception stating that the amount is below the minimum for this TRC. This field should not be used if the TRC is synchronized with a Flat Amount NA earnings code.
<b>Maximum Quantity</b>	Use this field to define your maximum limits for time entry for any TRC type. For example, if you set the maximum to 8, and a user reports 10, the system will generate an exception stating that the amount is above the maximum for this TRC. This element should not be used if the TRC is synchronized with a Flat Amount NA earnings code.
<b>Multiplication Factor</b>	Use this field to calculate hourly earnings, such as overtime or double time, for which the earnings are multiplied by a specific number or factor, such as 1.5 for overtime, 2.0 for double time, and so on. If you change the value in this element, the system will display a message indicating that this change may invalidate estimates that are already calculated. This element is factored into the calculation of estimated gross for Hours and Units TRC types.
<b>Rate Adjustment Factor</b>	Use this field to establish a dollar amount to apply to adjustments in pay rates. For example, if your union negotiated a \$0.30 per hour cost of living adjustment, you would enter 0.3 in this field for any applicable earnings, such as regular, overtime, vacation, and sick. Any employee getting any one of these types of earnings will be paid \$0.30 per hour, in addition to the compensation rate specified on the job record. This element is factored into the calculation of estimated gross for Hours and Units TRC types.
<b>Flat Amount</b>	This field only displays if you are synchronizing your TRC to a NA earnings code with a Flat Amount payment type. This is to assist you in knowing how the earnings will be paid if you are using NA Payroll. If you report a quantity that differs from the defined Flat Amount, you can include a delivered rule in your rule program that will replace it with the defined Flat Amount on the TRC.  The system handles this field differently based on your synchronize selections. See the table under Synchronizing TRCs With NA Earnings Codes for a description of these differences.

<b><i>Field or Control</i></b>	<b><i>Description</i></b>
<b>Rate</b>	<p>This field only displays if you are synchronizing your TRC to a NA earnings code with a Unit/Override payment type. This is to assist you in knowing how the earnings will be paid if you are using NA Payroll. If you report an Override Rate that differs from the defined Rate, you can include a delivered rule in your rule program that will replace the Override Rate with the defined rate on the TRC.</p> <p>This element is factored into the calculation of estimated gross for Hours and Units type TRCs.</p> <p>The system handles this field differently depending on your Sync elections. See the table under Synchronizing your TRCs With NA Earnings Codes for a description of these differences.</p>



<b>Field or Control</b>	<b>Description</b>
<b>Effect on Comp/Leave</b>	<p>Valid options are <i>No Comp Time Effect</i>, <i>Comp Time Earned</i>, <i>Comp Time Taken</i>, <i>Leave Taken</i> and <i>Avoid Replacing by Rules</i>:</p> <ul style="list-style-type: none"> <li>• Select <i>Comp Time Earned</i> if you want this TRC to be used for earnings for comp time that are in lieu of overtime. You should map your Comp Time Earned TRC to a NA earnings code that does not add to gross pay.</li> <li>• Select <i>Comp Time Taken</i> if you chose to map to a NA earnings code that adds to gross pay.</li> </ul> <hr/> <p><b>Note:</b> Comp Time Earned and Comp Time Taken TRCs can be associated to a Compensatory Time Off plan in order for them to be displayed in the Weekly reporting pages. They must exist in the time reporter's TRC program and assigned Comp Plan in order for compensatory time off to be validated correctly.</p> <hr/> <ul style="list-style-type: none"> <li>• Select <i>Leave Taken</i> for TRCs such as vacation, sick, or leave time. In order for the system to process Leave Time correctly, make sure you map the Leave Taken TRC to a NA Earnings code that has one of these payment types: Either Hours or Amounts, Hours Only, or Both Hours and Amounts. You must ensure that your NA earnings code is associated to a Leave Plan type and you have selected the <b>Taken</b> check box under the Add to Accrual Balance section of the earnings code setup. Also make sure the time reporter is assigned to a Leave Plan type of Sick, Vacation, or whatever Leave Plan type you want to use, as well as having the association to a specific leave plan.</li> <li>• <i>Comp Time Earned</i>, <i>Comp Time Taken</i>, or <i>Leave Taken</i> TRCs must have a <b>TRC Type</b> of <i>Hours</i>. You cannot change these values if the TRC is attached to an active comp time plan. If the time reporter enters a negative amount for <i>Comp Time Earned</i> or <i>Comp Time Taken</i>, the system considers it an adjustment. If the Time Reporter enters a negative amount for <i>Comp Time Taken</i>, the system creates a refund for the time reporter's balance. If the time reporter enters a negative amount for <i>Comp Time Earned</i>, the system will deduct the amount from the time reporter's balance.</li> <li>• The <i>Avoid Replacing by Rules</i> value gives users control over TRCs that should or should not be reduced as a result of daily or weekly overtime rules. Users need to change the TRCs eligible for rules processing but not eligible for reduction as a result of replacing rules (overtime, holiday , jury duty and so).</li> </ul> <hr/> <p><b>Note:</b> If the TRC is an absence TRC, then the <b>Effect on Comp/Leave</b> field is set to <i>None</i>, as absences reported in Absence Management are not validated.</p>

## Hours Represent

<i>Field or Control</i>	<i>Description</i>
<b>Actual Hours</b>	Select this option to specify that the reported hours represent actual hours worked.
<b>Compensation Only Hours</b>	<p>Select this option to specify that the reported hours represent compensation only hours. For example, in administering overtime, you may define a rule stipulating that an employee is entitled to time and a half for all hours worked beyond eight. So, if employees work ten hours, they get a premium for the 2 extra hours worked—the premium being the "half" of "time and a half." In this scenario, you want to be able to report the premium hours as compensation only hours. For Units and Amount TRCs, select this option.</p> <p>These options provide information only for the time that is reported and are not used in rules processing. You can use these options for reporting purposes.</p>

## Interface Options

<i>Field or Control</i>	<i>Description</i>
<b>Send to Payroll</b>	<p>The system selects this check box if any earnings code is mapped to the TRC; if one is not, the system clears it. The system only extracts payable time for a pay system that has the Send to Payroll check box selected.</p> <p>The system uses this flag to determine what time should be closed that is not going to a payroll system. Time Administration sets the time to a Needs Approval payable time status.</p> <p>See <a href="#">Workgroup - Definition Page</a>.</p> <p>If the TRC is synchronized with a NA earnings code and you decide to inactivate or delete a row on the NA earnings code, we recommend that you re-synchronize the TRC so that the attributes such as this flag are kept correctly synchronized.</p>
<b>Send to TCD</b>	Select this flag if you want this TRC sent to your Time Collection Device (TCD). You attach a TRC Program to a TCD and if the TRC is part of that TRC Program, it will get sent to your TCD.

<b>Field or Control</b>	<b>Description</b>
<b>Publish to Project Costing</b>	Select this field if you want your TRC sent to the Project Costing application.

## Mapping TRCs to Earning Codes

Access the Mapping to Earning Codes group box.

<b>Field or Control</b>	<b>Description</b>
<b>Payroll System</b>	<p>Select the Payroll System from which you want to select an earnings code and ultimately map to the TRC. If you entered a value in the <b>Map to NA Earnings Code</b> field and synchronized, the system automatically populates this element. You can choose to map this TRC to several payroll systems by inserting a new row and entering the appropriate data. The values for the payroll system default from the values you set up on the Pay System Options page. You don't have to save the page and return to establish a TRC relationship with multiple payroll systems.</p>
<b>Earnings Code</b>	<p>If you entered a value in the <b>Map to NA Earnings Code</b> field and synchronized, the system automatically populates this field, making it unavailable for entry. The values displayed in the drop-down list depend on the Payroll System that you have selected. If you chose <i>NA</i>, the list comes from the Payroll for North America Earnings Code table, if you selected <i>GP</i>, the values come from the Global Payroll Earnings Code table.</p> <hr/> <p><b>Note:</b> When you manually map a TRC to a GP code, we only display active Earnings and Take codes. If you need to inactivate a Pin code on the payroll side after mapping a TRC, you need to look at the TRCs to which the code is attached and inactivate the mapping here. The same is true if you manually map a TRC to a NA earnings code.</p> <hr/> <p>You can also use this element to establish a TRC that calculates Estimated Gross a different way than how the NA earnings code may be paid. In this case, you would not use the synchronize feature for mapping the TRC to a NA earnings code.</p>

<b>Field or Control</b>	<b>Description</b>
<b>Status</b>	<p>Select a Status for the earnings code mapped to this TRC. Valid values are <i>Active</i> and <i>Inactive</i>. If you entered a value in the <b>Map to NA Earnings Code</b> field and synchronized, the system automatically populates this field, making it unavailable for entry. If you manually choose a payroll system and earnings code, the system populates this field with the status of the earnings code, which you can change, if necessary. If you change the status to <i>Inactive</i>, you are inactivating the relationship between the TRC and earnings code. You are not inactivating the TRC itself.</p> <p>If the status of the earnings code mapped to the TRC changes, the system automatically displays the changed status of the earnings code in this field for TRCs synchronized with NA Payroll earnings codes. You have to manually change the status for TRCs mapped to Global Payroll or other pay systems.</p>

**Global Payroll / Absence Management Field (When Map to Absence Management Is Selected)**

<b>Field or Control</b>	<b>Description</b>
<b>Absence Take Code</b> (Absence Management Take code)	<p>Select the Absence Management Take Code that you want mapped to this TRC. In Absence Management (AM), you create a Take Code for each type of valid absence. The Take element is a rule that defines the conditions that must be met in order for an absence to be paid. When entering absences, you need to enter the appropriate Take Code so the system can track absences properly and apply the correct rules for compensation.</p> <hr/> <p><b>Note:</b> An active Absence Take Code should only be mapped to one TRC.</p> <hr/>
<b>GP Earnings Code</b> (Global Payroll earnings code)	<p>Select the GP earnings code for mapping costs back to Time and Labor from GP.</p> <hr/> <p><b>Note:</b> If absence event data is entered in Absence Management or Global Payroll using a Take code that is not mapped to a TRC, it does not display in the Absence grid of the Timesheet pages in Time and Labor.</p> <hr/>

### Payroll for North America Field (When Absence Flag Is Selected)

<i>Field or Control</i>	<i>Description</i>
<b>Absence Earnings Code</b>	Select the Absence earnings code that you want mapped to this TRC.
<b>NA Earnings Code</b> (North America earnings code)	Select the North America earnings code that you want mapped to this TRC.

#### Related Links

[Integrating Time and Labor with Global Payroll](#)

### Time Reporting Codes - Approval and Comment Page

Use the Time Reporting Codes - Approval and Comment page (TL\_TRC\_PNL2) to set up compensation and interface options and enter optional comments.

Navigation:

**Set Up HCM > Product Related > Time and Labor > Time Reporting > Time Reporting Codes - TRC > Approval and Comment**

This example illustrates the fields and controls on the Time Reporting Codes - Approval and Comment page. You can find definitions for the fields and controls later on this page.

<b>Field or Control</b>	<b>Description</b>
<b>Approve Reported Time</b>	<p>Select this check box if a manager's approval is required for reported time. Leave the check box clear if you do not want a manager to approve reported time.</p> <p>The Approve Reported Time feature is another option for approval of time. If selected, it requires that a manager approve the actual time that was reported versus payable time that has been processed by the Time Administration process.</p> <p>If you have Approve Reported Time selected, then when reported time is submitted, it will require approval before the Time Administration process selects the time, processes it, and generates payable time. If time is not approved, time will not be selected and run by the Time Administration process, and payable time will not be generated.</p>
<b>Approval Level</b>	<p>Use this field to indicate if time needs approval. Valid values are</p> <p><i>Both, and None</i></p> <p><i>Payable Time, and Rule Template.</i></p> <hr/> <p><b>Note:</b> You can choose to use a based model for approving payable time or implement the Approval Framework for payable time. You select which option the system should use on the Configurations page of the Time and Labor Installation table. If you select the Retain Basic (non-AWE) model option on the Configurations page, the Payable Time group box will not display the Approval Definition ID and Adhoc Approval Group fields.</p> <hr/>
<b>Approval Definition ID</b>	<p>Select the approval definition created for Time and Labor approvals. The definition ID identifies the appropriate approval definition. Each approval process ID can have one or more definition IDs for an approval transaction. The definition ID, with the other elements on the Setup Process Definitions page, enables the Approval Framework to determine which approval process ID to initiate, and determines the stage, path, and steps the approval process uses. Time and Labor delivers these definition IDs:</p> <ul style="list-style-type: none"> <li>• TLByDeptManager</li> <li>• TLByPosnDeptMgr</li> <li>• TLByPosnSupervisor</li> <li>• TLByPosMgmt</li> <li>• TLBySupervisorID</li> <li>• TLGroupSingleStageALL</li> <li>• TLGroupMultiStageSOME</li> <li>• TLGroupMultiStageALL</li> </ul>

<b>Field or Control</b>	<b>Description</b>
<b>Approval Group</b>	Click to display the TL Approval Groups page. This link is available when the selected Approval Definition ID requires a Time and Labor User List.
<b>Adhoc Approval Group</b>	Select a group ID that is set up for approvals.
<b>Comment</b>	Enter comments to describe details about the TRC when used in reporting time. For example, you may want to record information for this TRC about why an employee was absent, or you may want to include specific information about meetings.

**Note:** Approval selections made on the TRC page override the workgroup selection, when an employee has reported or payable time against a TRC where approvals are on.

### Related Links

[Understanding TCDs](#)

## Defining TRC Programs

To define a TRC program, use the TRC Program (TL\_TRCPGM\_PNLGRP) and the Copy TRC Program (TL\_TRC\_SAVE\_PNLGRP) components. Use the TL\_TRCPGM\_PNLGRP component interface to load data into the tables for the TRC Program (TL\_TRCPGM\_PNLGRP) component.

This section discusses how to define a TRC program.

### Pages Used to Define a TRC Program

<b>Page Name</b>	<b>Definition Name</b>	<b>Usage</b>
<a href="#">TRC Program Page</a>	TL_TRC_PGM_PNL	Define TRC's that will belong to a TRC Program.
<a href="#">Copy TRC Program Page</a>	TL_TRC_SAVE_AS_PNL	Copy a Time Reporting Code Program to use when creating a new Time Reporting Code Program. You must first define your Time Reporting Codes using the TRC Setup Page, and then your TRC Programs using the TRC Program Page.

### TRC Program Page

Use the TRC Program page (TL\_TRC\_PGM\_PNL) to define TRC's that will belong to a TRC Program.

Navigation:

**Set Up HCM > Product Related > Time and Labor > Time Reporting > TRC Program > TRC Program**

This example illustrates the fields and controls on the TRC Program page. You can find definitions for the fields and controls later on this page.

**TRC Program**

TRC Program ID: GXPGM

---

**TRC Program Information** Find | View All | First 1 of 1 | Last

\*Effective Date: 01/01/2008 + -

\*Description: Global Payroll Interface Short Description: Global Pay

---

**Reporting Codes in Program** Personalize | Find | View All | First 1-5 of 14 | Last

*TRC	Description	*TRC Access	Ordering Sequence		
GXBHW	SS TRC INCLUDE B/HOL AND NWH	No Restrictions		+	-
GXBNS	Bonus	No Restrictions		+	-
GXEXC	Abs days without hol or nwd	No Restrictions		+	-
GXINC	Abs days includes hol or nwd	No Restrictions		+	-
GXNHN	SS TRC EXCLUDE HOL AND NWH	No Restrictions		+	-

<b>Field or Control</b>	<b>Description</b>
<b>TRC</b>	Select the TRCs valid for this TRC program. You will assign the TRC program to a workgroup. Keep adding rows and TRCs until you have entered all the TRCs valid for this TRC program.
<b>TRC Access</b>	<p>This field enables you to control; TRC usage on the employee and manager timesheet. Your organization may specify Some TRCs that should only be entered by managers or administrators. For example, comp time earned, or bonus TRCs. The values available in this field are : <i>Administrator Only, Manager or Administrator Only, No Restrictions.</i></p> <p>When you indicate that a TRC should only be entered by an administrator, by selecting <i>Administrator Only</i>, the TRC is not included in the selection drop-down for all time reporters and managers.</p> <p>Selecting the <i>Manager or Administrator Only</i> option indicates that the TRC can be entered by either a manager or an administrator, but the TRC is not included as an option in all Employee Self Service components, such as the timesheet, Mass Time, or the Web Clock. However, since these entries should still display on the timesheet, employees can view the entry, but the selection is disabled.</p>
<b>Ordering Sequence</b>	Use the fields in this column to specify the order in which the listed TRCs appear as options on the employee and manager timesheets.



## Copy TRC Program Page

Use the Copy TRC Program page (TL\_TRC\_SAVE\_AS\_PNL) to copy a Time Reporting Code Program to use when creating a new Time Reporting Code Program.

You must first define your Time Reporting Codes using the TRC Setup Page, and then your TRC Programs using the TRC Program Page.

Navigation:

**Set Up HCM > Product Related > Time and Labor > Time Reporting > Copy TRC Program > Copy TRC Program**

This example illustrates the fields and controls on the Copy TRC Program page. You can find definitions for the fields and controls later on this page.

### Copy TRC Program

**Source TRC Program**

TRC Program ID GXPGM  
Effective Date 01/01/2008

Description	Global Payroll Interface	Short Description	
		Global Pay	

**Target TRC Program**

TRC Program ID

Effective Date

Description

Short Description

### Source TRC Program

The Source TRC Program group box displays the **TRC Program ID**, from which you want to copy values for your target TRC program, the **Effective Date** and **Description**.

### Target TRC Program

<i>Field or Control</i>	<i>Description</i>
<b>TRC Program ID</b>	Enter a new ID for your target TRC program. After saving the page, you can return to the TRC Program page in correction mode to make changes.

---

## Defining Units of Measure

To define units of measure, use the Unit of Measure (TL\_UNITS\_PNLG) component.

We provide a Unit of Measure (UOM) page for clients who do not interface with Project Costing. You can establish your own UOMs when establishing TRC attributes.

If you interface with Project Costing, you establish Unit of Measure values directly in your Project Costing application, in your Financials database. The system displays the values from Project Costing on the Unit of Measure page in Time and Labor.

You determine whether to display the fields on the Units of Measure page by selecting or clearing the **Interface with PS/Projects** check box on the TL Installation page. If the check box is selected, the fields are unavailable for entry. If **Interface with PS/Projects** is cleared, the fields on the page are available for entry.

## Page Used to Define Units of Measure

<i>Page Name</i>	<i>Definition Name</i>	<i>Usage</i>
<u>Units of Measure Page</u>	TL_UNITS_PNL	For clients who do not interface to PeopleSoft Project Costing, use this page to establish Unit of Measure values. For clients who interface to Project Costing, use this page to view Unit of Measure values established in your Project Costing application. If you are using Project Costing, the values for Unit of Measure will automatically be populated for you through Integration Broker, with the UOM_FULLSYNC message.

### Related Links

[Setting Up System Defaults and Loading Dates](#)

## Units of Measure Page

Use the Unit of Measure page (TL\_UNITS\_PNL) to for clients who do not interface to PeopleSoft Project Costing, use this page to establish Unit of Measure values.

For clients who interface to Project Costing, use this page to view Unit of Measure values established in your Project Costing application. If you are using Project Costing, the values for Unit of Measure will automatically be populated for you through Integration Broker, with the UOM\_FULLSYNC message.

Navigation:

**Set Up HCM > Product Related > Time and Labor > Time Reporting > Unit of Measure > Unit of Measure**

<i>Field or Control</i>	<i>Description</i>
<b>Unit of Measure</b>	The system displays the Unit of Measure code you entered to access this page.

## Working Through TRC Examples

The following examples illustrate how to synchronize Time and Labor TRCs with different kinds of earnings codes.

### Synchronizing an Hours Type TRC (RGR) to a NA Earnings Code (Hours Only) of REG

To synchronize an hours type TRC (RGR) to a NA earnings code (hours only) of REG:

- Create an Earnings Code = *REG* with an effective-dated row of 1/1/1900.
- Create a new TRC called *RGR* with an effective-dated row of the current date.
- In the **Description** field, enter Regular Pay.
- In the **TRC Type** element, select *Hours*.
- Because it is an hours TRC, include it in Labor Dilution processing by selecting the **Used in Labor Dilution** check box. The system will also automatically select the **Distribute Costs** check box. The TRC will be labor distributed and diluted during processing.
- Go to **Map to NA Earnings Code** and select *REG* from the list.
- Click on the **Sync** button. You will receive the following message:
 

"Do you wish to Sync this TRC to the selected North American Earnings Code? (13500,143) If you press OK then all the effective-dated rows of the selected North American earnings code will be copied over to the TRC table. Any future changes to the North American earnings code will be automatically updated to the TRC table."
- Click **OK**.

You now have 2 rows for the TRC, one for the current date and one with the date of the NA earnings code.

The following fields and their values are inherited from the NA earnings code.

- The Description and Short Description from the NA earnings code.
- The Multiplication Factor from Earnings Table 3.
- The Default value of the Add to Gross Pay on Earnings Table 2 populates the Distribute Costs Flag.
- The Status of the TRC defaults to Active.
- The Mapping to Earnings Code section displays the pay system and earnings code this TRC is now synchronizing to.

Once you save this TRC, the Send to Payroll Flag is automatically selected for you, as this is a system-controlled element populated when a TRC is mapped to any active earnings code.

## Synchronizing a Units Type TRC (PIECE) to a NA Earnings Code (Unit/Override Rate) of PWK

To synchronize a units type TRC (PIECE) to a NA earnings code (unit/override rate) of PWK:

- Create an Earnings Code = *Piecework* with an effective-dated row of 1/1/1980
- Create a new TRC called *PIECE* with an effective-dated row of 7/17/2002
- In the **Type** field, select *Units*.
- Select *Square Mile* as the **Unit of Measure**.
- Go to **Map to NA Earnings Code** and select *PWK* from the list.
- Click on the **Synchronize** button.

You now have two rows for the TRC, one for the current date 7/17/2002 and one for date of the NA earnings code for 1/1/1980.

The following fields and their values are inherited from the NA earnings code:

- The Description and Short Description from the NA earnings code.
- The Multiplication Factor from Earnings Table 3.
- The Rate Adjustment Factor from Earnings Table 3.
- The Rate from Unit/Override Rate value on Earnings Table 1.
- The Default value of the Add to Gross Pay on Earnings Table 2 populates the Distribute Costs Flag.
- The Status of the TRC defaults to Active.
- The Mapping to Earnings Code section displays the pay system and earnings code this TRC is now synchronized to.

## Synchronizing an Amounts Type TRC On-Call to a NA Earnings Code (Flat Amount) of OCP

To synchronize an amounts type TRC on-call to a NA earnings code (flat amount) of OCP:

- Create an Earnings Code = *OCP* with an effective date of 7/17/2002.
- Create a new TRC called *ONCAL* with an effective-dated row of 7/17/2002.
- In the TRC Type element, select *Amount*, when you tab out of the field Currency Code appears.
- Select a Currency Code of *USD*.
- Go to Map to NA Earnings Code and select *OCP*.
- Click on the **Synchronize** button.

There is only one effective-dated row for 7/17/2002, because your NA Earnings Code BNS has the same effective date as the effective date you entered for your TRC.

The following fields and their values are inherited from the NA earnings code

- The Description and Short Description
- The Flat Amount is populated into the Per Instance field from Earnings Table 1.
- The Multiplication Factor from Earnings Table 3.
- The Default value of the Add to Gross Pay from Earnings Table 2 populates the Distribute Costs Flag.
- The Status of the TRC defaults to *Active*.
- The Mapping to Earnings Code section displays the Pay System and Earnings Code to which this TRC is now synchronized.

**Related Links**

[Labor Distribution and Dilution](#)



# Defining Task Reporting Requirements

---

## Understanding Task Reporting Requirements

With Time and Labor, you can track time at the level of task detail your organization requires and allocate costs accordingly. We use the term *task* to refer to a set of attributes of reported time, such as department, product, or project, that more precisely identify how or where time was spent.

You can specify the types of task information you want to capture for each time reporter. For example, you may want sales staff to account for their time by customer and product; project managers to account for their time by project and activity; and administrative staff to report their time without task detail. Task templates, task profiles, and taskgroups are the tools that make this possible.

Taskgroups serve another important function: they are the means by which you assign default time reporting templates to time reporters. So, even if you're not interested in capturing task data for time reporters, you need to create taskgroups and assign a taskgroup to each time reporter.

### Related Links

[Creating Time Reporting Templates](#)

## Understanding Task Functionality

Task reporting is a subset of time reporting. Specify the types of information you want to collect from time reporters by creating time reporting templates described in the Reporting Time section of this book. You specify the task-related data you want to collect by designating the use of either a task profile or a task template on the time reporting template.

## Understanding Task Reporting Tools

You will use a group of task oriented tools to define your organization's task reporting requirements:

<b>Term</b>	<b>Definition</b>
<b>Task Entities</b>	<p>In Time and Labor, a task represents work assigned to a time reporter, and is represented by a combination of task entities.</p> <p>Task entities, also called task elements, are the specific types of task data you can capture when time is reported: customer, task, product, project, activity, company, combo code, department, business unit, job code, position number, location code, and up to five user-defined categories. Additional task entities are available if you're using Project Costing with Time and Labor.</p>

<b>Term</b>	<b>Definition</b>
<b>Task Template</b>	<p>Task templates control the task fields that appear on the time reporting pages. They also control what task data your time collection devices (TCDs) collect from time reporters. You select the task entities you want the members of a taskgroup to report their time to—company, department, or project, for example—through the task template. You also identify whether each type of information is required or optional.</p>
<b>Task Profile</b>	<p>Task profiles enable you to select task values for the task entities defined on your task template. You select the values for each task entity that's defined on a task template. For example:</p> <p>Project: PS Payroll</p> <p>Activity: Sales</p> <p>Department: Marketing</p> <p>Business Unit: USA</p> <p>You also specify how reported time is to be allocated across tasks: by percentage, quantity, or equally.</p> <p>You can create multiple task profiles from the same task template.</p> <p>When time is entered or generated for a time reporter who uses task profile reporting, the system refers to the task profile to determine which task values to assign or allocate – limiting the data the time reporter needs to enter.</p> <hr/> <p><b>Note:</b> Task profiles provide one way to supply values for task entities. Time reporters can also positively report task values if they use task template reporting, rather than task profile reporting.</p> <hr/>
<b>Taskgroup</b>	<p>A taskgroup identifies the valid, default time reporting templates, task template, and task profile(s) for time reporters with the same task reporting requirements. Each time reporter must be associated with one taskgroup, but the taskgroup assignment can be overridden when reporting time.</p>

To summarize:

- Each time reporter is assigned to a taskgroup.
- Each taskgroup is linked to a task template that identifies the types of task information the taskgroup members can report.
- Each taskgroup also specifies one or more task profiles that taskgroup members can use.
- Taskgroup members can report time through the use of task profiles or can report time to the individual task entities that are defined on a task template.



This diagram represents the relationships between time reporters, taskgroups, task templates, and task profiles.

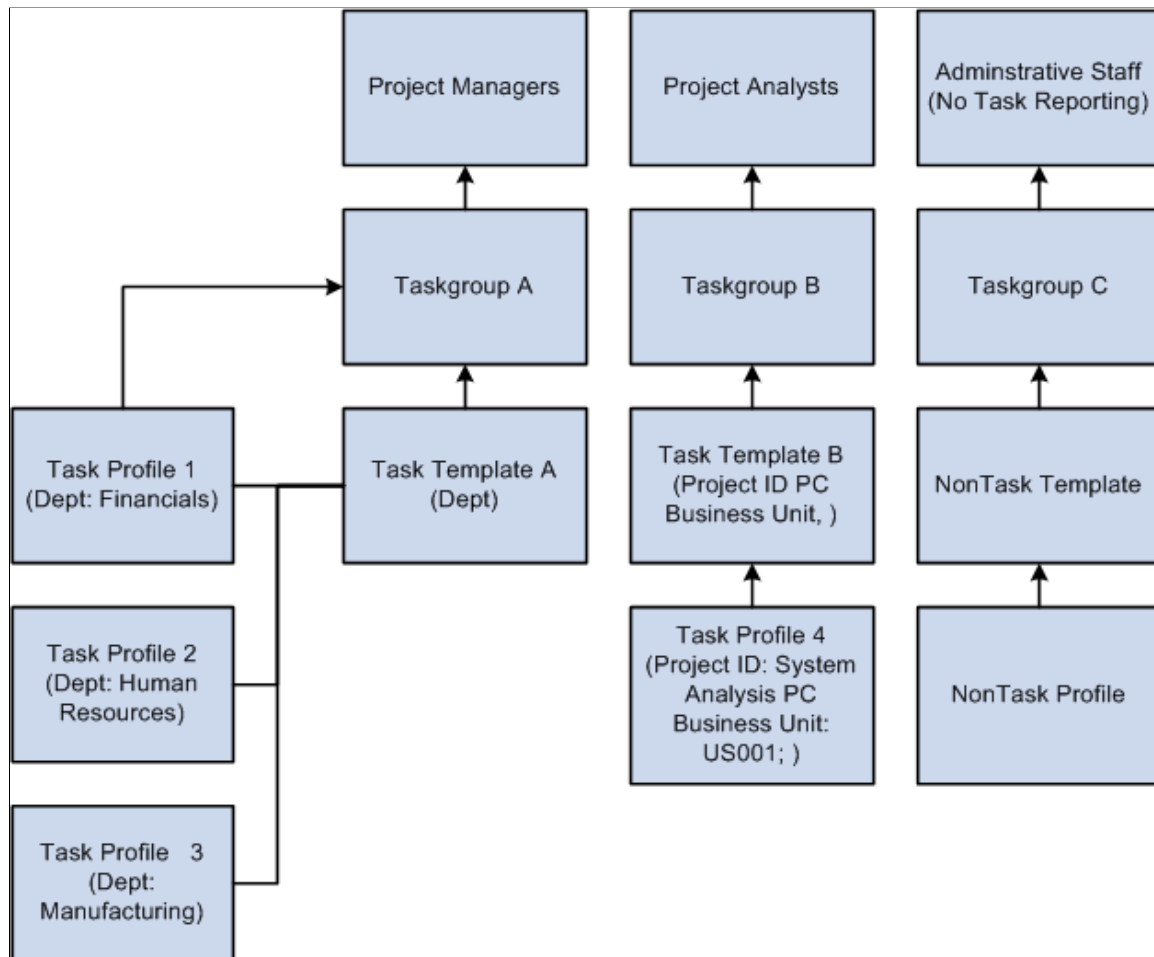

## Understanding Types of Task Reporting

Time and Labor supports two types of task reporting:

- Task profile reporting.

When a time reporter uses task profile reporting (in essence an automatic allocation), he simply reports the quantity of time worked—the system automatically determines the task entities to which time is reported and how much time is allocated to each task, based on the person's task profile. Task profile reporting is appropriate for time reporters who perform the same sets of tasks, where cost allocation is static. For example, assume a time reporter is assigned to a taskgroup that is associated with the following task profiles: Filing, Drafting, Sorting, and Etching. Each task profile represents a different set of task entities and allocations. The time reporter can use any of these task profiles to enter time, or can "borrow" a taskgroup to which he is not assigned and use the task profiles associated with that taskgroup as well. So, if our time reporter uses the Etching profile to enter 8 hours, and the profile specifies that 25% of the reported time goes to polishing and 75% of the reported time goes to buffing, the system will automatically allocate 2 hours to polishing and 6 hours to buffing.

- Task template reporting.

Use task template reporting to report time to the task entities you selected when defining the task template. Task template reporting is appropriate for time reporters who spend varied amounts of time on functions that require different cost allocations. For example, create a template called Sales, and select Customer, Product, and Task as the task entities, then use the Sales template to report the following information: 8 hours for Customer A, Product B, and Task C.

If you do not capture task data for some or all time reporters, you can use the nontask templates delivered with Time and Labor.

## Default Reporting

You can designate which task profile applies to a time reporter on more than one page. The system uses the following hierarchy to determine which task profile to use.

- The task profile entered on a time reporting page, if any, always take precedence.
- The task profile directly assigned to the time reporter on the Create Time Reporter Data page or Maintain Time Reporter Data page has second priority.
- The default task profile assigned to the time reporter's taskgroup on the Taskgroup page is used only when the system finds no other.

---

**Note:** Time and Labor enables you to override a time reporter's taskgroup when entering time. Taskgroup overrides, also referred to as taskgroup borrowing, enable time reporters to report time using the task profiles or task elements associated with the borrowed taskgroup.

---

## Related Links

[Creating Time Reporting Templates](#)

[Defining Taskgroups](#)

## Understanding How to Create Task Values in Time and Labor

For each type of task data you want to track in Time and Labor, you must set up an underlying task prompt table that defines the set of valid values that users can enter when reporting time or that the system retrieves when generating time. Some of these underlying tables are defined in Time and Labor; other tables are created in Human Resources Management, Project Costing, and PeopleSoft Performance Management.

This section discusses where the values for each task-related prompt table are defined.

## Understanding Where Prompt Tables are Defined

This table shows which PeopleSoft application you use to define task data used by Time and Labor. Notice that a few of the task elements (activity, projects, and business unit) can be defined in more than one application.

<b>Application</b>	<b>Fields</b>
HR Task Elements	Company Business Unit HR Location Department ID Jobcode Position Number
Time and Labor Elements	Customer Task TL Product TL Project TL Activity
General Ledger Elements	Combo Code <hr/> <b>Note:</b> You can view the active and inactive ChartFields by expanding the ChartFields section of the Standard ChartField Configuration. <hr/>
Performance Management Elements	Business Unit PF Activity FS
Project Costing Elements	PC Business Unit Project ID Activity Resource Type Resource Category Resource Subcategory

The following table lists where each set of task-related values is stored and tells you how to navigate to the pages where values are defined. For some task entities, this information depends on whether you're using PeopleSoft Financials (Project Costing and/or Enterprise Performance Management) and if you're using commitment accounting functionality. Values defined in PeopleSoft Financials can be viewed in Time and Labor, but can only be added or deleted in the application in which they are created.

<b>Task Element</b>	<b>Table</b>	<b>Navigation</b>
Company	COMPANY_TBL	<b>Set Up HCM &gt; Foundation Tables &gt; Organization &gt; Company</b>
HR Business Unit	BUS_UNIT_TBL_HR	<b>Set Up HCM &gt; Foundation Tables &gt; Organization &gt; Business Unit</b>
Location	TL_LOCATION_VW	<b>Set Up HCM &gt; Foundation Tables &gt; Organization &gt; Define Location</b>  Task values are based on setID for HR business unit.
Department ID	TL_DEPT_TBL_VW	<b>Set Up HCM &gt; Foundation Tables &gt; Organization &gt; Departments</b>  Not applicable when using commitment accounting. Task values are based on setID for HR business unit.
Jobcode	TL_JOBCODE_VW	<b>Set Up HCM &gt; Foundation Tables &gt; Job Attributes &gt; Define Job Code</b>  Task values are based on setID for HR business unit.
Position Number	POSITION_DATA	<b>Organizational Development &gt; Position Management &gt; Maintain Positions/Budgets &gt; Add/Update Position Info</b>
Product	TL_PRODUCT_TBL	<b>Set Up HCM &gt; Product Related &gt; Time and Labor &gt; Task Elements &gt; Task Element - Products</b>  Not applicable if combo code is enabled and product is an active ChartField
Customer	TL_CUSTOMER	<b>Set Up HCM &gt; Product Related &gt; Time and Labor &gt; Task Elements &gt; Task Element - Customers</b>

<b>Task Element</b>	<b>Table</b>	<b>Navigation</b>
Combo Code	TL_ACCTCD_BU_VW	<b>Set Up HCM &gt; Common Definitions &gt; ChartField Configuration &gt; ChartField Transaction Table</b>
Business Unit PC	TL_BUS_CA_PC_VW	<p><b>Set Up HCM &gt; Common Definitions &gt; ChartField Configuration &gt; ChartField Values</b></p> <p>Used only if Project Costing is installed and commitment accounting is used. Choices are restricted to business units that are compatible with the project ID from the Account Code table.</p> <p>The links are only available if the PC ChartFields are active. This applies to PC BU, Project (PC), Activity (PC), Resource Type, Resource Category, and Resource Subcategory.</p>
	BUS_UNIT_PC_VW	Same as above without commitment accounting.
Business Unit PF	BUS_UNIT_TBL_PF	<p><b>Set Up HCM &gt; Product Related &gt; Time and Labor &gt; Task Elements &gt; Business Unit PF</b></p> <p>Used only when Performance Management is installed and Project Costing is not.</p>
Project	PROJ_TEAM_DVW	<p><b>Set Up HCM &gt; Common Definitions &gt; ChartField Configuration &gt; ChartField Values</b></p> <p>Used when Project Costing installed, combo code is not enabled or project is not an activated ChartField, and team membership is enforced for all projects as designated on the business unit PC. Users can select only active projects to which time reporter is assigned.</p>

<b>Task Element</b>	<b>Table</b>	<b>Navigation</b>
	TL_PROJ_PC_VW	Same as above except used when team membership is not enforced. User can choose any projects within the business unit.
	TL_PROJECT	<b>Set Up HCM &gt; Product Related &gt; Time and Labor &gt; Task Elements &gt; Task Element - Projects</b>  Used when Project Costing is not installed and project is not an active ChartField.
Activity	TL_PROJ_ACTV_VW	<b>Set Up HCM &gt; Common Definitions &gt; ChartField Configuration &gt; ChartField Values</b>  Used when Project Costing is installed. Choices are restricted to active activities.
	TI_FS_ACTV_VW	<b>Set Up HCM &gt; Product Related &gt; Time and Labor &gt; Task Elements &gt; Activity ID</b>  Used when Performance Management is installed and Project Costing is not. Choices are restricted to active activities.
	TL_ACTIVITY	<b>Set Up HCM &gt; Product Related &gt; Time and Labor &gt; Task Elements &gt; Activity ID</b>  Used when neither Project Costing nor Performance Management is installed. Choices are restricted to active activities.
Resource Type	TL_PROJ_RTYPE_V	<b>Set Up HCM &gt; Common Definitions &gt; ChartField Configuration &gt; ChartField Values</b>  Used only when Project Costing is installed.

<b>Task Element</b>	<b>Table</b>	<b>Navigation</b>
Resource Category	TL_PROJ_CATG_V2	<b>Set Up HCM &gt; Common Definitions &gt; ChartField Configuration &gt; ChartField Values</b>  Used only when Project Costing is installed. If the resource category is related to resource type as defined on the Business Unit PC field.
	TL_PROJ_CATG_VW	Same as above, except table used when the resource category is not related to the resource type as defined on the Business Unit PC field.
Resource Subcategory	TL_PROJ_SUB_V2	<b>Set Up HCM &gt; Common Definitions &gt; ChartField Configuration &gt; ChartField Values</b>  Used only when Project Costing installed. Table used when the resource subcategory is related to the resource category as defined on the Business Unit PC field.
	TL_PROJ_SUB_V	Same as above, except table used when the resource subcategory not related to the resource category as defined on the Business Unit PC field.
Task	TL_TASK	<b>Set Up HCM &gt; Product Related &gt; Time and Labor &gt; Task Elements &gt; Task</b>
User Fields 1 - 5	TL_USER_FIELD_1-5	<b>Set Up HCM &gt; Product Related &gt; Time and Labor &gt; Task Elements &gt; User Field1-5</b>

**Note:** If you are not using Project Costing or Performance Management with Time and Labor, you may want to define your PeopleSoft security so that users see only the applicable menu items. See the *PeopleTools 8.52: Security Administration PeopleBook* for more information.

## Using ChartFields in Time and Labor

This section provides a brief overview of ChartFields and discusses the:

- Configuration and integration.
- Impact on task templates.
- Impact on time reporting pages.
- ChartField storage in reported time and task profile.
- ChartField storage in payable time.
- Time and Labor validation options.

ChartFields are fields used to report General Ledger charts of accounts with transactional data. These accounts determine the logging of transactions and the tracking of information for General Ledger purposes. ChartFields enable you to report up to 21 chart of accounts when entering transactional data. Both Commitment Accounting and Non-Commitment Accounting customers can utilize the ChartField functionality for their business processes.

## Configuration and Integration

You can configure and activate all or a subset of the 21 ChartFields using the Standard ChartField Configuration page. The Standard ChartField Configuration page enables you to activate, change the order of display, relabel the fields, and change the field length displayed for individual ChartFields.

If you integrate your HCM database with PeopleSoft General Ledger (GL), then you also set up the Standard ChartField Configuration that is owned by PeopleSoft Financial Management Systems (FMS). This configuration is defined and sent to HCM via Integration Broker. Any changes must be made directly in the FMS database and then sent to HCM.

If the HCM database is not integrated with PeopleSoft General Ledger, but you still want to enter ChartField values, then the Standard ChartField Configuration is accessible and can be updated directly. This may be used to capture chart of account values to send to a third party GL application or to just capture these details for HCM purposes. No matter where the configuration is entered, once you press the **Apply** button and the application engine runs, the pages displaying ChartFields will reflect the configured display.

See “Understanding PeopleSoft ChartFields” (Application Fundamentals).

## Impact on Task Template

After you press the **Apply** button on the Standard ChartField Configuration page, the impact to Time and Labor (TL) begins with the task template. The task template reflects the activated ChartField values when combo code is an enabled field. For example, if the Standard ChartField Configuration has activated GL account, department and project, and the application engine (using the **Apply** button) has been run, then the enabling of combo code field on the task template also enables the GL account, department and project as individual ChartField values.

When the system enables the combo code on the task template, the HR business unit is also enabled. The reason is in order to validate the combination of individual ChartField values, associated with a new or existing combo code, a GL business unit is required. HR business units are mapped to GL business units through the GL/HR Business Unit Mapping page (Setup HCM, Common Definitions, ChartField Configuration, GL/HR Business Unit Mapping). With this mapping, when a HR business unit is reported then the GL business unit can be derived and validation performed. If a HR business unit is not mapped



to a GL business unit, the system displays an error message. This error message is triggered online, at the point of validation, or during validation in the Submit Time application process.

The **TL Product**, **TL Project**, and **TL Activity** fields can be enabled on the task template depending on the Standard ChartField Configuration and the integration with PS/Projects and PS/EPM. The chart below describes when the fields are available and when they are not.

<b>PRODUCT</b>	<b>TL_Product Available</b>
Combo Code is enabled and Product is an active ChartField.	N
Combo Code enabled and Product is an inactive ChartField.	Y
Combo Code is not enabled.	Y

<b>PROJECT</b>	<b>TL_Project Available</b>
Combo Code is enabled and Project is an active ChartField. Integrate with PS/Projects is either enabled or NOT enabled	N
Combo Code enabled and Project is an inactive ChartField. Integrate with PS/Projects is enabled.	N
Combo Code enabled and Project is an inactive ChartField. Integrate with PS/Projects is NOT enabled.	Y
Combo Code is not enabled and Integrate with PS/Projects is enabled.	N

<b>ACTIVITY</b>	<b>TL_ACTIVITY Available</b>
PS/Project installed	N
PS/EPM installed	N
PS/EPM and PS/Projects are not installed	Y

## Impact on Time Reporting Pages

In Time and Labor, the system prepopulates the HR business unit on the transaction pages based on the User ID and the default HR business unit from the JOB record. This value can be overwritten to reflect the user preference when entering transactional details, but to ensure that a HR business unit is reflected for combo code validation, the system performs the prepopulation process.

Task reporting, on transaction rows, is driven by the taskgroup selected (either through default or borrowing). When reporting time you have the option of entering or selecting the Combo Code on the page or using the ChartFields link to search for ChartField combinations or add new ChartField combinations.

See “Understanding PeopleSoft ChartFields” (Application Fundamentals).

### Chartfield Storage on Reported Time and Task Profile

Reported time (TL\_RPTD\_TBL) and the task profile (TL\_TSKPRF\_DETL) only store the combo code, they do not store the values for individual chartfields.

### ChartField Storage on Payable Time

Payable Time table (TL\_PAYABLE\_TIME) stores both the combo code and individual ChartField values because ChartField integration with Global Payroll and Payroll for North America are handled differently.

### Time and Labor Validation Options

On the Time and Labor Installation page there are three options for ChartField validation.

<b>Term</b>	<b>Definition</b>
<b>Sync Message</b>	This option sends a message with ChartField data to FMS and receives a response of valid or not.
<b>Table Validation</b>	This option uses the Valid Combo Table to allow or deny a combination of individual ChartField values.
<b>None</b>	<p>This options allows you to turn off validation for Time and Labor transactions.</p> <hr/> <p><b>Note:</b> If you set the validation option to <i>None</i>, then only individual ChartField values will be validated and not the combination. If a combo code is generated without an associated GL Account, and this combo code is used in the integration with Payroll for North America, the associated transaction will fail when sent to General Ledger. In this case users that are integrating with Payroll for North America should always enter a <i>GL_Account</i> value even if the validation option is set to <i>None</i>.</p> <hr/>

GL Account is a required field when sending transactional data to General Ledger from any feeder system. Validations performed using Integration Broker or the Table Validation always require you to enter a GL Account value (at minimum).

## Understanding Task Reporting with PeopleSoft Financials

PeopleSoft Financials enables task reporting in the following areas:

## Project Costing

When you integrate Time and Labor with Project Costing, you have additional options for tracking time at the task level. You can track time by business unit, by the projects and activities defined in Project Costing, and by resource type, resource category, and resource subcategory. Valid values for these task entities come directly from Project Costing through Integration Broker and can be viewed through the ChartField Value page.

### Related Links

[Understanding Integration](#)

## Understanding the Sequence for Defining Task Functionality

This flowchart illustrates the sequence of steps necessary to define your task reporting requirements. We discuss each of these steps briefly in this section.

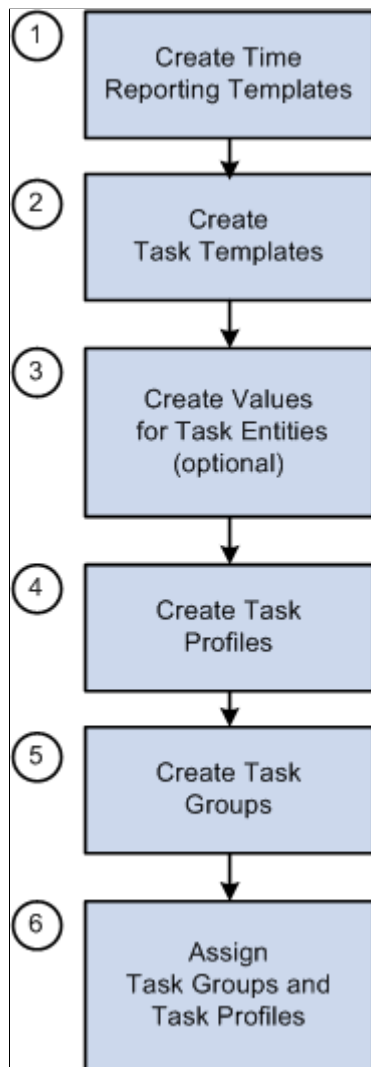

To define task reporting requirements for your organization:

1. Create time reporting templates.

Use the Time Reporting Template page to create templates for elapsed time and punch time reporting. On the template, select the Task Profile or Task Template check box to indicate the type of task reporting for which the template is designed. You must create time reporting templates before you can create taskgroups.

2. Create task templates.

Use the Task Template page to select the task entities that you want to appear on the time reporting pages or that you want your time collection devices (TCDs) to capture from time reporters.

You can create task templates before or after you create values for task entities.

3. Create values for task entities (optional).

If you want employees to report time by customer, product, activity, task, project, and/or up to five user-defined task categories, define the set of valid values that can be used for time reporting. For example, if you want to account for time by customer, set up a code for each customer.

If Project Costing is integrated with Time and Labor, the Project Costing application uses Integration Broker technology to publish the valid values for additional task entities.

4. Create task profiles.

Use the Task Profile page to select the values for the task entities you selected on the task template. Also indicate whether time is to be allocated across tasks equally, allocated by percentage, or allocated by quantity.

5. Create taskgroups.

Use the Taskgroup page to identify the default time reporting templates, task template, and task profile(s) that are valid for time reporters with the same task reporting requirements.

Before you can define taskgroups, you must create time reporting templates for elapsed and punch time reporting.

6. Assign taskgroup and task profiles.

- Assign a taskgroup to each time reporter via the Create Time Reporter Data page or Maintain Time Reporter Data page. You can also assign a task profile to each time reporter. The task profile you select will take precedence over the default task profile assigned to the time reporter's taskgroup.
- If you're using time collection devices, assign the appropriate taskgroups to each TCD via the TCD Setup page. The taskgroup determines what profiles and templates will be available to send to the TCD. You can also specify whether to send task profiles, task templates, and/or task values to the TCD.

---

**Note:** Before you begin to define task templates, task profiles, and taskgroups, spend some time analyzing your organization's task-reporting requirements. Determine which time reporters share the same or similar reporting requirements, perhaps based on the kind of work they perform, and what those specific requirements are. One taskgroup can include both elapsed and punch-time employees—employees and non-employees—as long as the same task entities apply to everyone in the taskgroup.

---

## Related Links

[Entering and Maintaining Time Reporter Data](#)

[Understanding TCDs](#)

## Creating Task Templates

To create task templates, use the Task Template (TL\_TSKPRF\_TMPLATE) component.

Use task templates to select the types of task information you want taskgroup members to provide when reporting time.

For example, if a group of time reporters does project work, such as developing software, you might want to create a task template that captures the project and product they're working on, the department, and individual tasks. If you're creating a task template for a group of account managers, you may want to include customer, company, department, and account code. Each task template should represent a distinct set of task-related elements.

A task template must be assigned to each taskgroup. You can assign the same task template to more than one taskgroup or you can create a separate task template for each taskgroup. The task template assigned to a taskgroup controls which task profiles you can associate with the taskgroup.

## Page Used to Create Task Templates

<i>Page Name</i>	<i>Definition Name</i>	<i>Usage</i>
<a href="#">Task Template Page</a>	TL_TSKPRF_TMPLATE	Select the types of task-related data you want a group of employees to report their time to such as company, business unit, department.

## Related Links

[Background Processing](#)

## Task Template Page

Use the Task Template page (TL\_TSKPRF\_TMPLATE) to select the types of task-related data you want a group of employees to report their time to such as company, business unit, department.

Navigation:

**Set Up HCM > Product Related > Time and Labor > Task Configurations > Task Template > Task Template**

This example illustrates the fields and controls on the Task Template page (1 of 2). You can find definitions for the fields and controls later on this page.

### Task Template

**Task Template Definition**

Task Template ID KUTSKTMP01	<input type="checkbox"/> Production Environment
*Description <input type="text" value="GL Combo Code"/>	<input checked="" type="checkbox"/> Used by Taskgroup(s)
Short Description <input type="text" value="GL Combo C"/>	<input checked="" type="checkbox"/> General Ledger
<input type="checkbox"/> Commitment Accounting	<input type="checkbox"/> Project Costing
	<input checked="" type="checkbox"/> Interface with PS EPM

HR Task Elements	Time and Labor Elements																																
<table style="width: 100%; border-collapse: collapse;"> <tr><td>*Company</td><td><input type="text" value="Not Used"/></td></tr> <tr><td>*Business Unit HR</td><td><input type="text" value="Optional"/></td></tr> <tr><td>*Location</td><td><input type="text" value="Not Used"/></td></tr> <tr><td>*Department ID</td><td><input type="text" value="Not Used"/></td></tr> <tr><td>*Jobcode</td><td><input type="text" value="Not Used"/></td></tr> <tr><td>*Position Number</td><td><input type="text" value="Not Used"/></td></tr> </table>	*Company	<input type="text" value="Not Used"/>	*Business Unit HR	<input type="text" value="Optional"/>	*Location	<input type="text" value="Not Used"/>	*Department ID	<input type="text" value="Not Used"/>	*Jobcode	<input type="text" value="Not Used"/>	*Position Number	<input type="text" value="Not Used"/>	<table style="width: 100%; border-collapse: collapse;"> <tr><td>*Customer</td><td><input type="text" value="Not Used"/></td></tr> <tr><td>*Task</td><td><input type="text" value="Not Used"/></td></tr> <tr><td>*TL Product</td><td><input type="text" value="Not Used"/></td></tr> <tr><td>*TL Project</td><td><input type="text" value="Not Used"/></td></tr> <tr><td>*TL Activity</td><td><input type="text" value="Not Used"/></td></tr> <tr><td>*User Field 1</td><td><input type="text" value="Not Used"/></td></tr> <tr><td>*User Field 2</td><td><input type="text" value="Not Used"/></td></tr> <tr><td>*User Field 3</td><td><input type="text" value="Not Used"/></td></tr> <tr><td>*User Field 4</td><td><input type="text" value="Not Used"/></td></tr> <tr><td>*User Field 5</td><td><input type="text" value="Not Used"/></td></tr> </table>	*Customer	<input type="text" value="Not Used"/>	*Task	<input type="text" value="Not Used"/>	*TL Product	<input type="text" value="Not Used"/>	*TL Project	<input type="text" value="Not Used"/>	*TL Activity	<input type="text" value="Not Used"/>	*User Field 1	<input type="text" value="Not Used"/>	*User Field 2	<input type="text" value="Not Used"/>	*User Field 3	<input type="text" value="Not Used"/>	*User Field 4	<input type="text" value="Not Used"/>	*User Field 5	<input type="text" value="Not Used"/>
*Company	<input type="text" value="Not Used"/>																																
*Business Unit HR	<input type="text" value="Optional"/>																																
*Location	<input type="text" value="Not Used"/>																																
*Department ID	<input type="text" value="Not Used"/>																																
*Jobcode	<input type="text" value="Not Used"/>																																
*Position Number	<input type="text" value="Not Used"/>																																
*Customer	<input type="text" value="Not Used"/>																																
*Task	<input type="text" value="Not Used"/>																																
*TL Product	<input type="text" value="Not Used"/>																																
*TL Project	<input type="text" value="Not Used"/>																																
*TL Activity	<input type="text" value="Not Used"/>																																
*User Field 1	<input type="text" value="Not Used"/>																																
*User Field 2	<input type="text" value="Not Used"/>																																
*User Field 3	<input type="text" value="Not Used"/>																																
*User Field 4	<input type="text" value="Not Used"/>																																
*User Field 5	<input type="text" value="Not Used"/>																																
Performance Mgmt Element																																	
<table style="width: 100%; border-collapse: collapse;"> <tr><td>*Business Unit PF</td><td><input type="text" value="Not Used"/></td></tr> <tr><td>Activity FS</td><td><input type="text" value="Not Used"/></td></tr> </table>	*Business Unit PF	<input type="text" value="Not Used"/>	Activity FS	<input type="text" value="Not Used"/>																													
*Business Unit PF	<input type="text" value="Not Used"/>																																
Activity FS	<input type="text" value="Not Used"/>																																

This example illustrates the fields and controls on the Task Template page (2 of 2). You can find definitions for the fields and controls later on this page.

**General Ledger Elements**

\*Combo Code Required ▼

▼ **ChartFields**

ChartField Name	ChartField Status
Account	Active ChartField
Department	Active ChartField
Project/Grant	Active ChartField
Product	Active ChartField
Fund Code	Active ChartField
Program Code	Active ChartField
Class Field	Active ChartField
Affiliate	Active ChartField
Operating Unit	Active ChartField
Alternate Account	Active ChartField
Budget Reference	Active ChartField
Chartfield 1	Active ChartField
Chartfield 2	Active ChartField
Chartfield 3	Active ChartField
Resource Category	Inactive ChartField

<b>Field or Control</b>	<b>Description</b>
<b>Task Template ID</b>	This field displays the name of the task template.
<b>Commitment Accounting</b>	<p>This is a display field. When selected, it indicates that your organization uses commitment accounting. In addition, the <b>Combo Code</b> field is enabled, and the <b>Product</b> and <b>Project ID</b> fields are unavailable.</p> <hr/> <p><b>Note:</b> A task template that is defined for commitment accounting can only be attached to taskgroups set up for commitment accounting.</p> <hr/>
<b>Production Environment</b>	Displays the setting from the TL Installation page. When the environment is specified as a Production Environment you cannot remove a task element previously marked as required, or add a previously unused element required.

<b>Field or Control</b>	<b>Description</b>
<b>Used by Taskgroup(s)</b>	<p>This is a display field. When selected, it indicates that the task template has been assigned to a taskgroup and the modifications you can make to the template are limited.</p> <p>If the system has been configured to use referential integrity (the Referential Integrity option on the Time and Labor Installation page is selected) you can add optional fields to the template and change required fields to optional.</p> <p>If the system is not using referential integrity, you can make any changes to the template except change the commitment accounting option.</p>
<b>General Ledger</b>	Displays the setting from the Installation page.
<b>Project Costing</b>	Displays the setting from the Installation table. Impacts whether Project Costing fields are presented on the page.
<b>Interface with PS EPM</b>	Displays the setting from the TL Installation page.

In the **HR Task Elements, Time & Labor Elements, Performance Mgmt Element, and General Ledger Elements** group boxes, select each type of task data you want time reporters associated with this taskgroup to report. For each field you choose, select either *Required*, *Optional*, or *Not Used* in the drop-down list to the right.

If your organization uses commitment accounting, Project Costing (PS/Projects) or Enterprise Performance Management (PS/EPM), some of the task fields may be selected automatically or made unavailable. The field descriptions below indicate when each field is available and the corresponding default values for selected fields.

### HR Task Elements

<b>Field or Control</b>	<b>Description</b>
<b>Company</b>	Always available.
<b>Business Unit HR</b>	<p>Selected automatically when you select <b>Location, Department ID, Jobcode or Combo Code</b>. If you make any of these fields required, Business Unit HR is also required.</p> <p>The Business Unit HR is required to derive the GL Business Unit for validation of combo code.</p>
<b>Location</b>	Always available. Location is dependent on <b>Business Unit HR</b> . When you select Location, the system automatically selects <b>Business Unit HR</b> with the same default value.



<b>Field or Control</b>	<b>Description</b>
<b>Department ID</b>	Not available when using commitment accounting. (Time and Labor automatically determines the correct HR department based on the combo code.) Department ID is dependent on <b>Business Unit HR</b> . When you select Department ID, the system automatically selects <b>Business Unit HR</b> with the same default value.
<b>Jobcode</b>	Always available. Jobcode is dependent on <b>Business Unit HR</b> . When you select Jobcode, the system automatically selects <b>Business Unit HR</b> with the same default value.
<b>Position Number</b>	Available only if using the Position Management feature and you have selected either <i>Full</i> or <i>Partial</i> on the HR Core Installation table.

### Performance Mgmt Element

<b>Field or Control</b>	<b>Description</b>
<b>Business Unit PF</b>	Available only when <b>Interface with PS/EPM</b> is selected on the Time and Labor Installation page.
Activity FS	Controlled by the setting for Business Unit PF.

### Time and Labor Elements

<b>Field or Control</b>	<b>Description</b>
<b>Customer</b>	Always available.
<b>Task</b>	Always available.
TL Product	Available if Product is not an active ChartField or if combo code is not selected.
TL_Project	Mutually exclusive with PC Project when Project Costing is installed. Mutually exclusive with Combo Code if Project is an active ChartField.

<b>Field or Control</b>	<b>Description</b>
TL Activity	Mutually exclusive with EPM Elements if Performance Management is installed. Mutually exclusive with Project fields if Project Costing is installed. Mutually exclusive with Combo Code if Project Costing fields are active ChartFields.
User Field 1 to 5	Always available.

### General Ledger Elements

<b>Field or Control</b>	<b>Description</b>
Combo Code	Automatically selected as an enabled field when commitment accounting is in use. In all other cases, Combo Code is available.

### Project Costing Elements

<b>Field or Control</b>	<b>Description</b>
PC Business Unit	Available only when Project Costing is selected on the Installation page. In this case, the system automatically selects <b>PC Business Unit</b> and defaults to <i>Optional</i> , though you can change it to <i>Not Used</i> . Exceptions are as follows:  If you make <b>Resource Type, Resource Category, or Resource Subcategory</b> a <i>Required</i> field, <b>PC Business Unit, Project ID and Activity ID</b> become <i>Required</i> fields.
Activity ID	Activity is controlled by and inherits the setting from PC Business Unit.
Resource Type	Available only when the <b>PC Business Unit</b> field is selected.

**Note:** The dependencies between **Resource Type, Resource Category, and Resource Subcategory** check boxes are dynamic.

<b>Field or Control</b>	<b>Description</b>
Resource Category	Available only when the <b>Business Unit PC</b> field is selected.

<i>Field or Control</i>	<i>Description</i>
<b>Resource Subcategory</b>	Available only when the <b>Business Unit PC</b> field is selected.

## Modifying a Task Template

Once you save a task template, the types of changes you can make to it depend on whether the template has been associated with a taskgroup and/or if the system has referential integrity selected on the Time and Labor Installation page. The table below shows the restrictions that are in place to enforce referential integrity.

<i>Referential Integrity?</i>	<i>Template Assigned to Taskgroup?</i>	<i>Changes Permitted</i>
Yes	Yes	You can add optional fields and change required fields to optional.  If you unintentionally included or excluded task entities when creating the task template, you can create a new template and change the task template assignment on the Taskgroup page. Changing the template will trigger referential integrity if time has already been reported for the taskgroup.
Yes	No	All changes are permitted.
No	Yes	All changes are permitted, with the exception of changing the commitment accounting option. Changes may trigger referential integrity.
No	No	All changes are permitted.

## Related Links

[Using Time and Labor with Commitment Accounting](#)

---

## Uploading ChartField Combinations

The Upload ChartField Combinations feature enables you to insert data into Combo Code task elements. The system loads the contents of a file that contains combination code information into the ACCT\_CD\_TBL\_TMP temporary table. Then use the TL\_ACCT\_CD Application Engine program to read the temporary table, validate the data, and insert the data into the ACCT\_CD\_TBL and

ACCT\_CD\_TBL\_GL tables. The system generates two reports: an upload summary report and a detail report that lists any bypassed records, and the reason for discarding the records.

The data file must be a comma-separated value (CSV) file with the chartfield information for each combination code listed in a specific order. If you do not use all of the available chartfields in a specific combination code, you should leave the unused columns empty and keep the formatted sequence of chartfields. The following table lists each chartfield name in the correct order for the data file, and provides a brief description of the contents of each column of chartfield information:

<b>ChartField Label</b>	<b>Description</b>
General Ledger Unit	Enter the General Ledger Business Unit for each combination code in this column of the data file. For example: BUXYZ
Combination Code	Enter an optional name for each combination code in this column of the data file. For example: NEW COMBO ABC
Description	Enter an optional description of each chartfield combination in this column of the data file.
Account	Enter the Account ChartField account information for each combination code in this column of the data file. For example: 123456-88
Department	Enter the Department ChartField information for each combination code in this column of the data file. For example: DEPT X
Business Unit PC	Enter the Project Costing Business Unit ChartField information for each combination code in this column of the data file. For example: BUABC
Project ID	Enter the Project Identification ChartField information for each combination code in this column of the data file. For example: LOAD CFS
Activity ID	Enter the Activity ChartField information for each combination code in this column of the data file. Activities are the specific tasks that make up a project. For example: VIEW SAMPLE
Resource Type	Enter the Source Type ChartField information for each combination code in this column of the data file. Source types identify the purpose or origin of a transaction.
Resource Category	Enter the Category ChartField information for each combination code in this column of the data file. Use categories to further define source types.

<b>ChartField Label</b>	<b>Description</b>
Resource Sub-Category	Enter Subcategory ChartField information for each combination code in this column of the data file. Use subcategories to further define categories.
Product	Enter Product ChartField information for each combination code in this column of the data file. The Product ChartField captures additional information useful for profitability and cash flow analysis by product sold or manufactured.
Fund Code	Enter Fund Code ChartField information for each combination code in this column of the data file. Fund Codes are the primary structural units of Education and Government accounting.
Program Code	Enter Program Code ChartField information for each combination code in this column of the data file. Program codes can be used to identify groups of related activities, cost centers, revenue centers, responsibility centers and academic programs.
Class Field	Enter Class Field ChartField information for each combination code in this column of the data file. Can be used to identify specific appropriations.
Affiliate	Enter Affiliate ChartField information for each combination code in this column of the data file. Affiliate is used to map transactions between Business units when using a single interunit account.
Operating Unit	Enter Operating Unit ChartField information for each combination code in this column of the data file. Operating Unit can be used to indicate a location, such as a distribution warehouse or a sales center.
Alternate Account	Enter Alternate Account ChartField information for each combination code in this column of the data file. Alternate accounts classify the nature of a transaction for regulatory authorities.
Budget Reference	Enter Budget Reference ChartField information for each combination code in this column of the data file. Use budget references to identify unique budgets, when individual budgets share budget keys and overlapping budget periods.
Chartfield 1	Enter customizable ChartField information for each combination code in this column of the data file. Generic expansion ChartFields can be configured for use, hidden, or deleted

<b>ChartField Label</b>	<b>Description</b>
Chartfield 2	Enter customizable ChartField information for each combination code in this column of the data file. Generic expansion ChartFields can be configured for use, hidden, or deleted
Chartfield 3	Enter customizable ChartField information for each combination code in this column of the data file. Generic expansion ChartFields can be configured for use, hidden, or deleted
Fund Affiliate	Enter Fund Affiliate ChartField information for each combination code in this column of the data file. Use fund affiliates to correlate transactions between funds when using a single intraunit account.
Operating Unit Affiliate	Enter Operating Unit Affiliate ChartField information for each combination code in this column of the data file. Use operating unit affiliates to correlate transactions between Operating Units when using a single intraunit account.

**Important!** The order of the fields in the file is fixed and independent of the configured order of chartfields according to the Standard Configuration.

## Page Used to Upload ChartField Combinations

<b>Page Name</b>	<b>Definition Name</b>	<b>Usage</b>
<a href="#">Upload ChartField Combinations Page</a>	TL_CF_RUNCTL	Upload chartfield date into Combo Code task elements.

## Upload ChartField Combinations Page

Use the Upload ChartField Combinations page (TL\_CF\_RUNCTL) to upload chartfield date into Combo Code task elements.

Navigation:

**Set Up HCM > Product Related > Time and Labor > Task Elements > Upload ChartField Combinations**

This example illustrates the fields and controls on the Upload ChartField Combinations page. You can find definitions for the fields and controls later on this page.

### Upload ChartField Combinations

Run Control ID PS

**Select and Upload .CSV File**

Select File
No file selected
File Requirements

Upload File Content
 **File Content Uploaded**

**Update Transaction Table**

Run
 **Transaction Table Updated**

**Review**

[Process Monitor](#)

[Report Manager](#)

The Update process validates the individual ChartFields as well as the combination. It will discard rows that contain invalid data. After the process completes use the Report Manager hyperlink to check the result of the process. Select the Administration tab. Find the TL\_ACCT\_CD report for your jobs Process Instance. Select Details.

The Summary Report.csv breaks down the transactions by processing status. Transaction Detail.csv shows each individual entry. If a row was discarded, the status will indicate the reason.

<b>Field or Control</b>	<b>Description</b>
<b>Select File</b>	Click to select a file that contains chartfield information that you want to insert into Combo Code task elements. The data file must be a CSV file with the chartfield information for each combination code listed in a specific order. After you select a file, a link appears next to the <b>Select File</b> button indicating the name of the file you want to upload. Click on the link to manually verify the data you are about to upload to the system.
<b>File Requirements</b>	Click this link to open the ChartField File Requirements page. This page displays the required order of combo code information in a CSV file that you want to upload to the system.
<b>Upload File Content</b>	Click to load the contents of the select CSV-formatted file into the ACCT_CD_TBL_TMP temporary table.
<b>File Content Uploaded</b>	Indicates whether or not a file with combo code information has been uploaded to the system.
<b>Run</b>	Click to start the TL_ACCT_CD Application Engine program. This process validates the data and writes the information for each valid row into the ACCT_CD_TBL.

<i>Field or Control</i>	<i>Description</i>
<b>Transaction Table Updated</b>	Indicates that the process has completed and that the data from the file has been uploaded to the ACCT_CD_TBL. It does not reflect whether all entries from the file were valid or if any were discarded by the process. Review the process logs for full details.

Use the links in the **Review** group box to view the status of the TL\_ACCT\_CD process and to locate the Summary Report.csv and the Transaction Detail.csv report files. The system creates these reports as the process completes. The Summary Report.csv file indicates the status of each row of data from the uploaded file. The Transaction Detail.csv report file shows the status of each row of data, including the reason for failure for any row.

## Defining and Viewing Task Values in Time and Labor

To define or view task values, use the Customer (CUSTOMER), Task (TASK), Product (PRODUCT1), Project (PROJECT1), Activity ID (ACTIVITY\_ID), and User Field 1 (TL\_USER\_FLD1\_PNLG) components. Use the CUSTOMER, TASK, PRODUCT1, PROJECT1, ACTIVITY\_ID, and TL\_USER\_FLD1\_PNLG component interfaces to load data into the respective tables for these components.

As noted earlier, task values for Time and Labor prompt tables can be defined in Time and Labor as well as in Human Resources, Project Costing, and Performance Management. This sections discusses how to define and view task values.

## Pages Used to Define and View TL Entities

<i>Page Name</i>	<i>Definition Name</i>	<i>Usage</i>
Customer Page	TL_CUSTOMER	Use the Customer page to create and view codes for customers. For example, employees such as account managers may need to account for their time based on the customers with whom they spend it.
Task Page	TL_TASK	Use the Task page to create and view codes for specific tasks. For example, employees such as software developers may need to account for their time based on the tasks (coding, meetings and so on) they perform.



<b>Page Name</b>	<b>Definition Name</b>	<b>Usage</b>
Product Page	TL_PRODUCT_TBL	Use the Product page to create and view codes for products. For example, employees such as software developers may need to account for their time based on the products they spend time developing.
<u>Project Page</u>	TL_PROJECT	If you're using Time and Labor without Project Costing, use the Project page to create and view codes for projects.
<u>Manage TL Activity Codes Page</u>	TL_ACTIVITY	If you are using Time and Labor without Project Costing or Performance Management, use the Activity page to establish codes for activity IDs.
<u>User Field 1–5 Pages</u>	TL_USER_FIELD1_PNL TL_USER_FIELD2_PNL TL_USER_FIELD3_PNL TL_USER_FIELD4_PNL TL_USER_FIELD5_PNL	Use the User Fields page to create your custom task-reporting elements.

## Project Page

Use the Project page (TL\_PROJECT) to create and view codes for projects, if you're using Time and Labor without Project Costing.

Navigation:

**Set Up HCM > Product Related > Time and Labor > Task Elements > Project > Project**

This example illustrates the fields and controls on the Project page. You can find definitions for the fields and controls later on this page.

The screenshot shows the Oracle HCM Cloud interface for the 'Project' page. At the top, the title 'Project' is displayed in blue. Below it, the project name 'Project KUCONV' is shown. A navigation bar includes 'Find | View All', 'First', '1 of 1', and 'Last'. The main section is titled 'Project Information' and contains several fields:
 

- \*Effective Date:** A date field with the value '01/01/1980' and a calendar icon.
- \*Status:** A dropdown menu currently set to 'Active', with '+' and '-' buttons.
- \*Description:** A text input field containing 'Data Conversion'.
- Short Description:** A text input field containing 'Conversion'.

The page you use to create project codes depends on whether Project Costing is integrated with Time and Labor:

- If you're using Time and Labor without Project Costing, use the Project page to create project codes.
- If you're using Project Costing, define project codes in the Project Costing application. You can then use the PC Project Descr page in Time and Labor to view the codes but not to change them.

## Manage TL Activity Codes Page

Use the Manage TL Activity Codes page (TL\_ACTIVITY), if you are using Time and Labor without Project Costing or Performance Management, to establish codes for activity IDs.

Navigation:

**Set Up HCM > Product Related > Time and Labor > Task Elements > Manage TL Activity Codes**

This example illustrates the fields and controls on the Manage TL Activity Codes page. You can find definitions for the fields and controls later on this page.

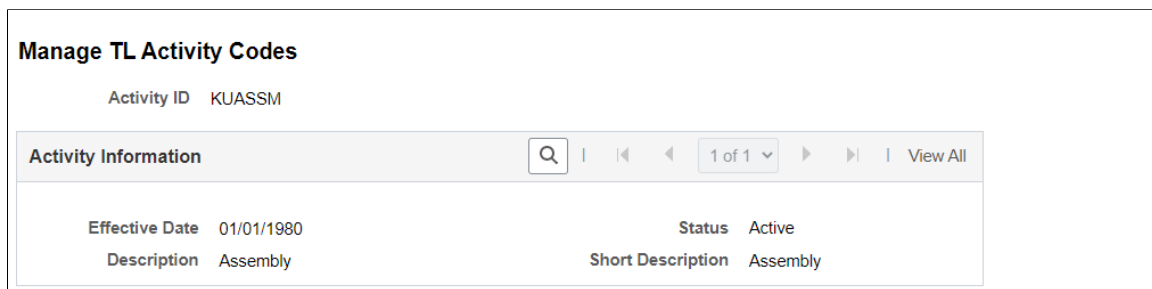

The page you use to create activity codes depends on whether Project Costing and/or Performance Management are integrated with Time and Labor.

- If you're using Time and Labor without Project Costing or Performance Management, use the Activity page to create activity codes.
- If you're using Project Costing, you define activity codes in that application. You can then use the PC Activity pages in Time and Labor to view the codes but not to change them.
- If you're using Performance Management (without Project Costing) you define activity codes in the Enterprise Performance Management application. You can then use the View FS Activity page in Time and Labor to view the codes but not to change them.

## User Field 1–5 Pages

Use the User Field 1-5 page (TL\_USER\_FIELD1\_PNL, TL\_USER\_FIELD2\_PNL, TL\_USER\_FIELD3\_PNL, TL\_USER\_FIELD4\_PNL, TL\_USER\_FIELD5\_PNL) to create your custom task-reporting elements.

Navigation:

**Set Up HCM > Product Related > Time and Labor > Task Elements > Task Element - User Field 1 > User Field 1**

If you'd like to report time against task elements that are not delivered with Time and Labor, you can define values for up to five user fields. The maximum length varies by user field:

- User Field 1: 10 alphanumeric characters.
- User Field 2: 10 alphanumeric characters.
- User Field 3: 15 alphanumeric characters.
- User Field 4: 20 alphanumeric characters.
- User Field 5: 20 alphanumeric characters.

---

**Note:** If you want to re-label the user fields, see the instruction in your *PeopleTools PeopleBook*.

---

**Note:** When values are entered in user fields, the Time Administration process attempts to process the entries in the user-definable elements.

---

## Displaying Task Codes Defined in Project Costing and Performance Management

To display task codes for Project Costing and Performance Management, use the PC Business Unit (TL\_BUS\_UNIT\_TBL\_PC), PC Project (PROJECT1\_PC), PC Activity ID (PC\_PROJ\_ACTIVITY), Resource Type (PROJ\_RES\_TYPE), Resource Category (PROJ\_CATG\_DEFN), Resource Sub-Category (PROJ\_SUBCAT\_DEFN), Business Unit PF (TL\_BUS\_UNIT\_TBL\_PF), and FS Activity (FS\_ACTIVITY\_TBL) components.

Prompt tables defined in Project Costing and/or Performance Management are available to Time and Labor through our Publish and Subscribe technology. If you're using Project Costing or Performance Management, you can view the prompt values in Time and Labor but not change them. To add or delete values, you must update the appropriate Project Costing or Performance Management page.

### Pages Used to Display Task Codes in Project Costing and Enterprise Performance Management

<b>Page Name</b>	<b>Definition Name</b>	<b>Usage</b>
<a href="#">PC Business Unit Page</a>	HMCF_PROJ_BUS_UNIT	Display business unit criteria defined through Project Costing.
<a href="#">PC Project Deser Page</a>	HMCF_PROJECT_PC	Display project codes defined through Project Costing.
<a href="#">PC Project Team Page</a>	HMCF_PROJECT_TEAM	Display project information created through Project Costing.

<b>Page Name</b>	<b>Definition Name</b>	<b>Usage</b>
PC Activity ID Page	HMCF_PROJ_ACT	View the activity codes defined in Project Costing.
<u>Resource Type Page</u>	HMCF_PROJ_RSRCE	View resource type codes defined in Project Costing,
<u>Resource Category Page</u>	HMCF_PROJ_CATG	View resource category codes defined in Project Costing,
Resource Sub-Category Page	HMCF_PROJ_SUBCAT	View resource subcategory codes defined in Project Costing,
<u>Business Unit PF Page</u>	TL_BUS_UNIT_TBL_PF	View business unit codes defined in Performance Management.
View FS Activity Page	FS_ACTIVITY_TBL1	View activity codes defined in Performance Management.

## Related Links

[Understanding Integration](#)

## PC Business Unit Page

Use the PC Business Unit page (HMCF\_PROJ\_BUS\_UNIT) to display business unit criteria defined through Project Costing.

Navigation:

**Set Up HCM > Common Definitions > ChartField Configuration > ChartField Values > PC Business Unit**

This example illustrates the fields and controls on the PC Business Unit page. You can find definitions for the fields and controls later on this page.

### PC Business Unit

Business Unit JPN01

PC Business Unit Definition	
Description JAPAN OPERATIONS	Short Desc JAPAN OPS
Currency Code	Rate Type

Dynamic Edit Tables	
Category Edit Option Independent	Category Edit Table PROJ_CATG_TBL
SubCategory Edit Option Independent	SubCategory Edit Table PROJ_SUBCAT_TBL

Accounting Periods
Calendar ID

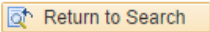
 Return to Search

The PC Business Unit pages display business unit information defined in Project Costing, if this application is installed.

For more information, see *PeopleSoft Project Costing*

## PC Project Descr Page

Use the PC Project Descr page (HMCF\_PROJECT\_PC) to display project codes defined through Project Costing.

Navigation:

**Set Up HCM > Common Definitions > ChartField Configuration > ChartField Values > Project > PC Project Descr**

This example illustrates the fields and controls on the PC Project Descr page. You can find definitions for the fields and controls later on this page.

The screenshot shows the 'PC Project Descr' page with the following details:

- Navigation:** PC Project Descr | PC Project Team
- Project Summary:** Business Unit: US003, Project: FACTORY, Factory
- PC Project Definition:**
  - Project Type: 00000
  - Enforce Project Team?
- Date / Time:**
  - Find | View All | First | 1 of 1 | Last
  - Fields: Date/Time Stamp, User ID
  - Long Description: [Empty text area]
- Project Resource:**
  - Find | View All | First | 1 of 1 | Last
  - Effective Date: 09/30/2014, Sequence: 0, Start Date: [Empty]
  - Status: [Empty], End Date: [Empty]
  - Percent Complete: [Empty], Priority: 0
- Buttons:** Return to Search

For more information, see *PeopleSoft Project Costing*

## PC Project Team Page

Use the PC Project Team page (HMCF\_PROJECT\_TEAM) to display project information created through Project Costing.

Navigation:

**Set Up HCM > Common Definitions > ChartField Configuration > ChartField Values > Project > PC Project Team**

This example illustrates the fields and controls on the PC Project Team page. You can find definitions for the fields and controls later on this page.

PC Project Descr		PC Project Team				
<b>Team Members</b>						
Business Unit: US003		Project: FACTORY		Factory		
<span>Team Members</span> <span style="float: right;">Personalize   Find       First 1-14 of 14 Last</span>						
Team Member Indicator	Team Member	Name	Project Role	Email Notify for Status Change	Start Date	End Date
Employee	IXHEEE140		PROJ CONSULTANT	<input checked="" type="checkbox"/>	05/14/2002	06/11/2002
Employee	IXHEEE154		PROJ CONSULTANT	<input checked="" type="checkbox"/>	05/14/2002	06/11/2002
Employee	IXHEEE160		PROJ CONSULTANT	<input checked="" type="checkbox"/>	05/14/2002	06/11/2002
Employee	KU0012	Allan Martin	PROJ CONSULTANT	<input checked="" type="checkbox"/>	05/14/2002	06/11/2002
Employee	KU0015	Carmichael Espinosa	PROJ CONSULTANT	<input type="checkbox"/>	05/14/2002	06/11/2002
Employee	KU0022	Fred Giles	PROJ CONSULTANT	<input type="checkbox"/>	05/14/2002	06/11/2002
Employee	KU0035	James Fung	PROJ CONSULTANT	<input type="checkbox"/>	05/14/2002	06/11/2002
Employee	KU0037	Richard Morgan	PROJ CONSULTANT	<input type="checkbox"/>	05/14/2002	06/11/2002
Employee	KU0042	Danny Johnson	PROJ CONSULTANT	<input checked="" type="checkbox"/>	05/14/2002	06/11/2002
Employee	KU0048	Brenton Francisco	PROJ CONSULTANT	<input type="checkbox"/>	05/14/2002	06/11/2002
Employee	KU0056	Edward Ng	PROJ CONSULTANT	<input type="checkbox"/>	05/14/2002	06/11/2002
Employee	KU0062	Rosa Benigo	PROJ CONSULTANT	<input type="checkbox"/>	05/14/2002	06/11/2002
Employee	KU0089	Sandy Cerruit	PROJ CONSULTANT	<input type="checkbox"/>	05/14/2002	06/11/2002
Employee	KU0095	Samish Patel	PROJ CONSULTANT	<input type="checkbox"/>	05/14/2002	06/11/2002
<span> Return to Search</span> <span> Previous in List</span> <span> Next in List</span>						
PC Project Descr		PC Project Team				

For more information, see *PeopleSoft Project Costing*

## Resource Type Page

Use the Resource Type page ( HMCF\_PROJ\_RSRCE ) to view resource type codes defined in Project Costing.

Navigation:

**Set Up HCM > Common Definitions > ChartField Configuration > ChartField Values > Source Type**

This example illustrates the fields and controls on the Resource Type page. You can find definitions for the fields and controls later on this page.

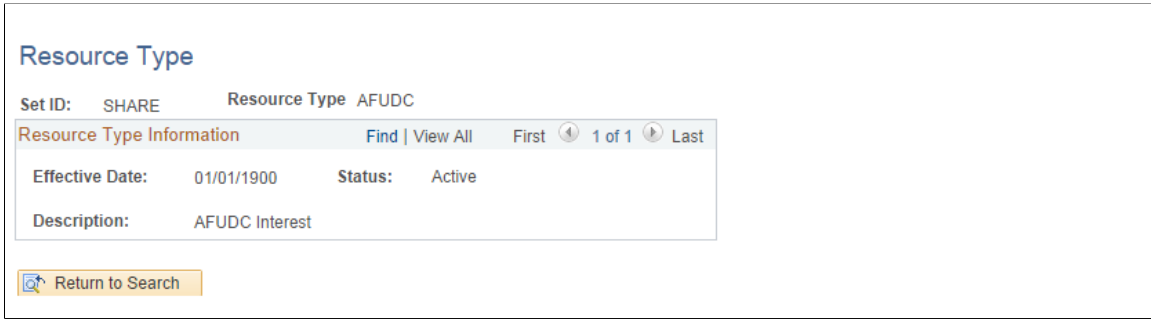

Resource type codes are applicable only if you are using Project Costing. You can use the Resource Type page to view any resource codes defined in Project Costing but not to update them.

For more information, see *PeopleSoft Project Costing*

## Resource Category Page

Use the Resource Category page (HMCF\_PROJ\_CATG) to view resource category codes defined in Project Costing.

Navigation:

**Set Up HCM > Common Definitions > ChartField Configuration > ChartField Values > Category**

This example illustrates the fields and controls on the Resource Category page. You can find definitions for the fields and controls later on this page.



Resource category codes are applicable only if you're using Project Costing. You can use the Resource Category page to view any resource category codes defined in Project Costing.

For more information, see *PeopleSoft Project Costing*

## Business Unit PF Page

Use the Business Unit PF page (TL\_BUS\_UNIT\_TBL\_PF) to view business unit codes defined in Performance Management.

Navigation:



## Set Up HCM > Product Related > Time and Labor > Task Elements > Business Unit PF > View Business Unit PF

This example illustrates the fields and controls on the Business Unit PF page. You can find definitions for the fields and controls later on this page.

The screenshot shows the 'Business Unit PF' page with the following fields and values:

- Business Unit: CORP1
- Description: CORP1
- Short Description: CORP1
- Base Currency: USD
- As of Date: 01/01/1900
- Rate Type: CRRNT
- Calendar ID: 01 Monthly
- Last Batch Number: 23

Business Unit PF codes are applicable only if you are using Performance Management and you are not using People Soft Project Costing. You can use the Business Unit PF page to view any business units defined in Enterprise Performance Management but not to update them.

For more information, see *PeopleSoft ePerformance*

## Creating Task Profiles

To create task profiles, use the Task Profile (TL\_TASK\_PROFILE) component. Use the TL\_TASK\_PROFILE component interface to load data into the tables for this component.

Task profiles enable you to specify default values for the task elements on the task template. You select the specific companies, departments, projects, and other tasks to which you want to allocate a person's reported time. You also specify how to distribute reported time across tasks: by quantity, by percentage, or by distributing time equally across all tasks.

This section discusses how to create task profiles.

### Page Used to Create Task Profiles

<b>Page Name</b>	<b>Definition Name</b>	<b>Usage</b>
<u>Task Profile Page</u>	TL_TASK_PROFILE	<p>Define task profiles.</p> <p>Use this page to select values for the task entities you selected on the task template. Also indicate whether time is to be allocated across tasks equally, allocated by percentage, or allocated by quantity.</p>

## Task Profile Page

Use the Task Profile page (TL\_TASK\_PROFILE) to define task profiles.

Use this page to select values for the task entities you selected on the task template. Also indicate whether time is to be allocated across tasks equally, allocated by percentage, or allocated by quantity.

Navigation:

**Set Up HCM > Product Related > Time and Labor > Task Configurations > Task Profile > Task Profile**

This example illustrates the fields and controls on the Task Profile page. You can find definitions for the fields and controls later on this page.

<b>Field or Control</b>	<b>Description</b>
<b>Task Template ID</b>	Select the task template associated with this task profile. If you are not interested in task-level reporting, you can select the value <i>PS Non Task</i> in this field.
<b>Send to TCD</b>	Select this check box if you want to make the profile available to one or more time collection device (TCD). (You must also select the Send Task Profiles option on the TCD Type Definition page. The <b>Taskgroup</b> field on the TCD Setup page determines which profiles are sent to the TCD.)

**Warning!** If you clear the task profile detail, you may invalidate any validated and paid time that has been reported using this task profile.

### Allocation Type

Time and labor can be reported in quantities of hours, units, or amounts. Define how you want the reported quantity to be allocated to tasks. (Each task is represented by a row of task entities on the **Allocation Detail** tabs.)

<b>Field or Control</b>	<b>Description</b>
<b>Allocation by Quantity</b>	Select to enter a quantity (hours, units, or amount) for each task. The system will convert the number you enter into a percentage, based on the total quantity you enter for all tasks. This option is similar to the <b>Allocation by Percentage</b> option, but rather than entering a percentage you enter a number that the system converts to a percentage.
<b>Allocation by Percentage</b>	Select this option to specify the percentage of hours, units or amounts the system should allocate to each reported task.
<b>Allocation Equally All Tasks</b>	Select this option to automatically allocate hours, units, or amounts equally among all the tasks you report. The system determines the allocation when time is reported or created.

## Allocation Detail

Insert a row for each task (that is, the combination of task-related entities) to which you want to allocate time. For example, specify that 50 percent of a time reporter's time will be allocated to the product, customer, and task identified on the first row, and 50 percent of the time will be reported to the combination of tasks reported on the second row.

---

**Note:** The template you select in the **Task Template ID** field determines the tabs and fields that appear in the **Allocation Detail** section of this page.

---

<b>Field or Control</b>	<b>Description</b>
<b>Allocation Amount</b> (allocation amount)	<p>The number you enter in this field depends on the option you selected in the <b>Allocation Type</b> field.</p> <p>If you selected the <b>Allocation by Quantity</b> option, enter the number the system should use to determine how to allocate the reported quantity (hours, units, or amount) to the task row you're about to define. The system will convert the number into an allocation percentage.</p> <p>For example, say you enter 2 on the first task row and 6 on the second task row. When time reporters enter their time, the system will automatically assign 2/8 (or 25%) of the reported time to the first set of tasks and 6/8 (or 75%) of the reported time to the second set of tasks.</p> <p>If you selected the <b>Allocation by Percentage</b> option, enter the percentage of hours, units, or amounts that should be allocated to the task row you're about to define.</p> <p>If you selected the <b>Allocation Equally All Tasks</b> option, the <b>Allocation Amt</b> field doesn't appear. The system will automatically distribute the reported quantity equally across all task rows.</p>

Select the appropriate value for each of the task-related fields in the row. The system will dynamically adjust the prompt tables for some fields based on commitment accounting and the presence of other PeopleSoft applications.

The following table lists all tabs that can appear on the Task Profile page, along with all fields that can appear on each tab.

<b>Tab Name</b>	<b>Fields</b>
HR / TL Fields	Company, Business Unit, Location, HR Department, Jobcode, and Position Number, Customer, Task, TL Activity.
ChartFields	Combo code, and related ChartFields.
PC / EPM Fields	PC Business Unit, Project/Grant, Activity ID, Resource Type, Resource Category, Resource Subcategory, Business Unit PF, Activity FS depending on which Financials and Performance Management products are integrated with Time and Labor.
User Fields	User Field 1, User Field 2, User Field 3, User Field 4, User Field 5.

## Related Links

[Understanding TCDs](#)

[Defining and Viewing Task Values in Time and Labor](#)

[Understanding Integration](#)

## Defining Taskgroups

To define taskgroups, use the Taskgroup (TASKGROUP) component. Use the TASKGROUP component interface to load data into the tables for this component.

A taskgroup represents a group of time reporters with similar time and task reporting requirements. Taskgroups identify the default time reporting template, task template, and task profiles that are valid for members of the taskgroup. The task template you link to the taskgroup determines which task profiles you can attach.

Every time reporter must be associated with a valid taskgroup. You assign an individual to a Taskgroup using the Create Time Reporter Data page or Maintain Time Reporter Data page.

### Creating a Taskgroup for Non-task Reporting

To simplify the set up required for non-task reporting, Time and Labor is delivered with a taskgroup, task template, and task profile, each named PSNONTASK.

If you're not interested in collecting task data, you can create a taskgroup and select PSNONTASK for both the task template and the default task profile. Then select the time reporting templates that identify the additional time elements you're interested in.

### Modifying a Taskgroup

Once you save a taskgroup, you cannot change the commitment accounting option. You can change the time reporting templates, the task template ID, and inactivate task profiles associated with the taskgroup; however, these changes will trigger the Referential Integrity process when you run Time Administration.

## Page Used to Define Taskgroups

<i>Page Name</i>	<i>Definition Name</i>	<i>Usage</i>
<a href="#">Taskgroup Page</a>	TL_TASKGROUP_TBL	Define taskgroups.

## Related Links

[Defining and Viewing Task Values in Time and Labor](#)

[Background Processing](#)

## Taskgroup Page

Use the Taskgroup page (TL\_TASKGROUP\_TBL) to define taskgroups.

Navigation:

**Set Up HCM > Product Related > Time and Labor > Task Configuration > Taskgroup > Taskgroup**

This example illustrates the fields and controls on the Taskgroup page. You can find definitions for the fields and controls later on this page.

<b>Field or Control</b>	<b>Description</b>
<b>Status</b>	The status of the taskgroup appears in this field. If you change the status to <i>Inactive</i> , and the taskgroup is already assigned to time reporters, you will not be able to inactivate the effective-dated row.
<b>Commitment Accounting</b>	Select this check box if your organization uses commitment accounting for this taskgroup. Selecting this option restricts the task templates you can select from in the <b>Task Template ID</b> field.  <b>Note:</b> Once you save the taskgroup, you cannot change the commitment accounting option.
<b>Clear Task Profile Detail</b>	Click this button if you've already attached task profiles to this taskgroup (in the <b>Valid Task Profiles</b> group box) and now want to change the task template ID.  If you're in update or correction mode, the system will change the status of all task profiles listed in the <b>Task Profile ID</b> grid to <i>Inactive</i> . When you add new task profiles, the inactive profiles will be displayed after the active profiles when you access the page after saving the data.  The Referential Integrity process will be triggered, if the system has the <b>Referential Integrity</b> option on the Time and Labor Installation page selected, when you click the <b>Clear Task Profile Detail</b> button.

<b>Field or Control</b>	<b>Description</b>
<b>Task Template ID</b>	<p>Specify the task template you want to associate with this taskgroup. This is a required field. If you selected the <b>Commitment Accounting</b> check box on this page, the prompt table will list only those task templates defined for commitment accounting. The template you select will determine which task profiles you can attach to this taskgroup.</p> <p>If you're not using task reporting, select <i>PSNONTASK</i>.</p>
<b>Default Task Profile</b>	<p>This field displays the name of the task profile that has been selected as the default for this taskgroup. (You select the default using the Task Profile ID grid.)</p> <p>During the Time Administration process, the system will use this task profile if you have not selected a task profile ID on the time reporter's Create Time Reporter Data page or Maintain Time Reporter Data page.</p>

## Time Reporting Template ID

Both **Elapsed** and **Punch** are required fields. Use these fields to specify which time reporting templates apply to members of this taskgroup.

<b>Field or Control</b>	<b>Description</b>
<b>Elapsed Reporting Template</b>	<p>Select the time reporting template for reporting elapsed time. This is a required field.</p> <p>If a time reporting template for elapsed time doesn't apply to the time reporters who will be assigned to this taskgroup, select <i>PSELP_NONE</i> from the prompt table.</p>
<b>Punch Reporting Template</b>	<p>Select the time reporting template employees in this taskgroup are to use when reporting punch time. This is a required field.</p> <p>Select <i>PSPCH_NONE</i> from the prompt table if a time reporting template for punched time doesn't apply to the time reporters who will be assigned to this taskgroup, for example, elapsed time reporters who will never need to enter punch time.</p>

## Valid Task Profiles

Use the grid to attach one or more task profiles to the taskgroup. You will also select the default task profile for members of the taskgroup.

<b>Field or Control</b>	<b>Description</b>
<b>Task Profile ID</b>	<p>Select the default task profile(s) you want to associate with this taskgroup. The prompt table lists only those task profiles created with the template you selected in the <b>Task Template ID</b> field.</p> <p>During the Time Administration process, the system will use the default task profile if you have not selected a task profile ID on the time reporter's Create Time Reporter Data page or Maintain Time Reporter Data page.</p>
<b>Description</b>	The description of the taskgroup you selected in the <b>Task Profile ID</b> field automatically displays here.
<b>Status</b>	When you add a task profile ID to the grid, the status automatically defaults to <i>Active</i> . The status changes to <i>Inactive</i> if you change the task template. You cannot delete a task profile ID from the grid; however, you can change the status to <i>Inactive</i> .
<b>Set As Default</b>	You must select one task profile as the default for the taskgroup. This is the profile the system will use for any taskgroup members who don't have their own individual task profile defined on the Create Time Reporter Data page. Select this check box if you want this task profile to be the default profile.



## Chapter 8

# Defining Work Schedules

---

## Understanding Work Schedules

In Time and Labor you can define three main types of schedules: punch, elapsed, and flex. Punch schedules include punch detail such as In, Out, Meal, Break, and Transfer. Elapsed schedules show the duration of time to be worked—for example, eight hours on Monday. Flex schedules are practical when a time reporter has some flexibility to begin and end the workday. Creating schedules for time reporters is a two-part process: creating a schedule definition and assigning time reporters to it.

Work schedules have several functions:

- To provide a facility to create, view, and manage a time reporter's schedule.
- To communicate and manage work expectations.
- To enable estimates of labor costs.
- To provide data that Time Administration can use to evaluate reported time.
- To provide schedule information that Time Administration can use to create payable time for exception reporters
- To accept time reporters' schedules from external systems.
- To provide punch schedule information that can be sent to time collection devices.

### Schedules

To create schedules:

1. Create shifts (optional).

You can create elapsed, flex, and punch shifts. Shifts are either created on the Shift component or as part of the Schedule Definition.

2. Create workdays (optional).

You can create workdays as labels for the type of day, to be associated in the schedule definition.

3. Create schedule definitions.

Schedule definitions are the basic building blocks of work schedules and are used to create a series of short term or long term workdays.

See also: [Assigning Schedules](#)[Assigning Schedules to a Group](#)

## Shifts

A shift is the main building block for the workday and an aggregate for the set of punch types from which it is built. Create a shift by entering a shift type and the detail in the shift. You can create three types of shifts: elapsed, punch, and flex.

---

**Note:** Shifts can be created on the Shift page, or within schedule definitions.

---

### Elapsed Shifts

Define a single elapsed punch entry for the shift. For example, you create an elapsed shift of 8 hours. The 8 hours is nonclock time. Elapsed shifts cannot exceed 24 hours.

### Punch Shifts

Use punch shifts when you want to create shifts that define specific work times. Punch shifts are defined by an In punch and the first subsequent instance of an Out punch. There can be other punches, such as Break, Meal, or Transfer, between the In and Out punches. Punch times are associated with each punch. Enter the duration of a punch, or the system can calculate the duration when the time for the next punch is entered.

### Flex Shifts

A flex shift is a working arrangement with latitude for when the time reporter begins and ends the shift. Enter the core hours, the required hours of work, according to your organization's business rules and the weekly number of hours that the flexible shift requires. Flex shifts cannot exceed 24 hours.

*Example:* Flex Shifts

<b>Type of Flex Shift</b>	<b>In Punch</b>	<b>Out Punch</b>	<b>Scheduled Hours</b>	<b>Flex Start</b>	<b>Flex End</b>	<b>Flex Weekly Hours</b>
1 Flex Band	06:00	18:00	8	09:00	15:00	40
2 Flex Range	06:00	19:00	8			40
3 Flex Core	00:00	23.59	8 (daily average)	09:00	15:00	40
4 Flex Core Plus	00:00	23.59	8	09:00	15:00	40

1. Time reporters may begin and end their workdays within a range of flexible hours (begin any time between 06:00 and 09:00 and end any time between 15:00 and 18:00). Time reporters know that they must work 8 hours a day, 40 hours a week, and that they must work during the company-established core hours of 09:00-15:00. Time reporters can vary their begin and end times on a daily basis, within the established flexible hours.

2. Time reporters may work any 8 hours during the day, within a range of flexible hours (any time between 06:00 and 19:00). There is no company-defined core period. They must work 40 hours a week.
3. Time reporters may work any time during the week, provided that they work 40 hours during the company-established core hours (09:00-15:00). They can vary their begin and end times on a daily basis within the established flexible hours and may vary the length of the workday, provided that they meet the weekly 40 hour requirement.
4. Time reporters must work 40 hours a week during the company-established core hours (09:00-15:00). Time reporters can vary their begin and end times on a daily basis within the established flexible hours, but may not vary the length of the 8 hour workday. This method effectively limits the time reporter to starting work between 07:00 and 09:00 and ending between 15:00 and 17:00.

## Workdays

A workday is an optional component of the schedule definition that adds descriptive information. Additionally a workday may be used by Global Payroll Rules as a code to identify the type of day.

## Schedule Definitions

Schedule definitions define a work schedule. Use schedule definitions to produce a single schedule of work expectations over a period of time including rotating work schedule.

For instance, the schedule definition could be composed of shifts representing a five-day, 08:00 to 17:00 workweek and shifts representing a five-day, 08:00 to 18:00 workweek. In addition, these shifts can be set up to repeat a specified number of times. We could specify that we will work four of the five-day, 08:00 to 17:00 workweek shifts followed by one of the five-day, 08:00 to 18:00 workweek templates.

Using the example above, some of your time reporters might always work the five-day, 08:00 to 17:00 workweek. Some of your time reporters might always work the five-day, 08:00 to 18:00 workweek, and some of your time reporters might work a combination of the two workweeks. This can all be set up as part of the schedule definition.

After creating a schedule definition, assign a time reporter, or group of time reporters, to it.

## Schedule Calendars

While creating or completing a schedule definition, view the schedule calendar by selecting the **Show Calendar** link on the Schedule Shifts page. A schedule calendar is derived and calculated from the schedule definition and shift definitions (if used).

## Related Links

[Assigning Schedules](#)

[Assigning Schedules to a Group](#)

---

# Creating Work Schedules and Schedule Definitions

To create work schedules and schedule definitions, use the Shifts (SCH\_SHIFT), Shifts BRA (SCH\_SHIFT\_BRA), Workdays (SCH\_WRKDAY) and Schedule Definition (SCH\_DEFINITION)

components. Use the SCH\_SHIFT, SCH\_WRKDAY and SCH\_DEFINITION component interfaces to load data into the tables for these components.

This section discusses how to create work schedules and schedule definitions.

## Pages Used to Create Work Schedules, and Schedule Definitions

<i>Page Name</i>	<i>Definition Name</i>	<i>Usage</i>
<u>Shift Page</u>	SCH_SHIFT SCH_SHIFT_DTL_BRA	Set up elapsed, flex, and punch shifts.
<u>(BRA) Details Bra Page</u>	SCH_SHIFT_BRA	(BRA) Specify shift types.
<u>Schedule Group Page</u>	SCH_GROUP	Set up schedule groups to categorize schedules.
<u>Workday Page</u>	SCH_WRKDAY	Define shifts.
<u>Definition Page</u>	SCH_DEFINITION	Set up schedule definitions.
<u>Schedule Shifts Page</u>	SCH_DEFINITION_2	Set up shift information, or enter shifts setup on the Shift page, for the schedule definition.
Schedule Calendar Page	SCH_CLND_VW_SEC	View a schedule calendar.

### Shift Page

Use the Shift page (SCH\_SHIFT) to set up elapsed, flex, and punch shifts.

Use the Shift page (SCH\_SHIFT\_DTL\_BRA) to set up elapsed, flex, and punch shifts for Global Payroll for Brazil.

Navigation:

- **Set Up HCM > Product Related > Time and Labor > Schedule Configurations > Schedule Shifts > Shift**
- **Set Up HCM > Product Related > Time and Labor > Schedule Configurations > Shifts BRA > Shift**

This example illustrates the fields and controls on the Shift page. You can find definitions for the fields and controls later on this page.

The screenshot shows the 'Shift' page with the following details:

- Set ID:** SHARE (Table Set shared across Corp)
- Shift ID:** KU36HR
- Shift Elements:**
  - \*Effective Date: 01/01/1990
  - \*Shift Type: Punch
  - \*Description: 36 hour punch shift
  - Short Description: 36 hour pu
  - Sched Hrs: 36.00
  - Start Time: 7:00AM
  - End Time: 7:00PM
- Taskgroup for Time Reporting:**
  - Taskgroup: [Searchable]
  - Task Template ID: [Searchable]
  - TR Template: [Searchable]
- Schedule Configuration Totals:**
  - Total 1: 0.00
  - Total 2: 0.00
  - Total 3: 0.00
  - Total 4: 0.00
- Shift Details:**
  - \*Punch Type: In, Out
  - Time: 7:00:00AM, 7:00:00PM
  - Time Zone: [Searchable]
  - Duration: 36.00, 0.00
  - Task Profile ID: [Searchable]
  - Cfg 1, Cfg 2, Cfg 3, Cfg 4: [Checkboxes]

The Shift page (SCH\_SHIFT\_DTL\_BRA) is cloned from the Shift page (SCH\_SHIFT) and is used to set up shifts primarily for Global Payroll for Brazil

<b>Field or Control</b>	<b>Description</b>
<b>Shift ID</b>	Shift ID is keyed by SetID. The SetID is used to filter shifts for display, for association to schedules.
<b>Effective Date</b>	<p>Enter an effective date for this shift. If you modify previously-saved schedule definition detail, these limitations apply to the effective date on the Shift page:</p> <ul style="list-style-type: none"> <li>You cannot change the shift's effective date to a date earlier than the earliest effective date of all schedules containing that shift.</li> <li>You cannot change the shift's effective date to a date later than the earliest effective date of all workgroups or Global Payroll pay groups with default schedule IDs containing that shift.</li> </ul>

<b>Field or Control</b>	<b>Description</b>
<b>Shift Type</b>	<p>If the value is <i>Elapsed</i>, only the elapsed punch types will display in the Shift Details grid. An elapsed shift can contain only one punch entry.</p> <p>If the value is <i>Punch</i>, In, Out, Break, Meal, and Transfer punch types can be entered unless the <b>Off Shift</b> check box is selected, in which case only In and Out can be entered. The <b>Flex Shift Information</b> group box does not appear on the page. Punch shifts require an In and Out punch to be saved.</p> <p>If the value is <i>Flex</i>, only In and Out punches can be entered. The <b>Flex Shift Information</b> group box appears and is available. Flex shifts require an In and Out punch to be saved.</p>
<b>Off Shift</b>	<p>Select to designate a shift as being non-work time. This field cannot be changed once the shift has been saved.</p> <hr/> <p><b>Note:</b> (Global Payroll for Brazil) Shifts that are indicated as off shifts (with the <b>Off Shift</b> check box selected) are not processed by eSocial.</p>
<b>Sched Hrs</b> (scheduled hours)	<p>This field displays the total amount of work time for the shift. For example, you may require a time reporter to punch in at 09:00 and punch out at 17:00 each workday, but the shift includes a one-hour lunch break for which the time reporter isn't required to punch.</p> <p>The calculation of <b>Total Scheduled Hours</b> for the shift including meal and break is derived from the <b>Schedule Total Options</b> field on the Time and Labor Installation — Configurations page or the Schedule Settings on the System Settings page of Global Payroll/Absence Management setup.</p> <p>You can also manually edit this number for punch and flex shifts. For an elapsed shift, the value in the <b>Scheduled Work Hours</b> field will always equal the duration of the elapsed punch entry. The field cannot be changed.</p> <p>If you modified a shift, the system, at save time, checks if the shift is used in any schedules. If it is, then the schedule will need refreshing. Use the Schedules to be Validated page to learn if the changes will affect an existing schedule.</p> <p>If you make any changes that affect punch time or punch duration, the system updates the value in the Scheduled Hours field. Review the Scheduled Hours field before saving changes to be sure the field contains the correct data.</p>
<b>Start Time</b>	Enter the time the shift starts.
<b>End Time</b>	Enter the time the shift finishes.

## Taskgroup for Time Reporting

<i>Field or Control</i>	<i>Description</i>
<b>Taskgroup</b>	<p>If required, select a taskgroup for the <b>Taskgroup</b> field.</p> <p>The <b>Taskgroup</b> and <b>Time Reporting Template ID</b> fields determine which reporting elements should be available for the Shift Detail rows on the Shift page. No elements are visible if these fields are blank. Otherwise, the default punch or elapsed time reporting template (depending on the definition type) from the taskgroup definition will be used to determine which time reporting elements will be visible.</p> <p>If Task Profile Reporting is selected on the Time Reporting Template, the Task Profile ID element will be available, but no task elements. If <b>Task Element Reporting</b> is selected, the task reporting template from the taskgroup definition will be used to determine the task elements that display.</p> <p>The task and time reporting elements will not be available for <i>OUT</i> punches, or for <i>Off Shifts</i>.</p>
<b>TR Template</b> (Time Reporting Template)	<p>If a taskgroup is selected for the Default Taskgroup field, a Time Reporting Template may default. The Time Reporting Template may also be overridden manually.</p>

## Schedule Configuration Totals

Global Payroll, Absence Management and Time and Labor share schedule setup pages and records. However, these fields are only used by the Global Payroll and Absence Management systems. These totals are derived for the shift from the Schedule Configuration Indicators which can be associated to each punch or scheduled duration. There are four Schedule Configuration Indicators and four related Schedule Configuration Totals.

The labels for the Schedule Configuration Indicators and Schedule Configuration Totals fields are set using values from the Text Catalogue, and can be relabeled as needed.

## Flex Shift Information

<i>Field or Control</i>	<i>Description</i>
<b>Core Begin</b>	<p>Enter the begin time for the core period, the time that time reporters are expected to be present at work, excluding meal and break time. This time must be later than the time of the In punch for the shift.</p>

<b>Field or Control</b>	<b>Description</b>
<b>Core End</b>	Enter the end time for the core period, the time that time reporters are expected to be present at work, excluding meal and break time. This time must be earlier than the time of the Out punch for the shift.
<b>Weekly Hours</b>	Enter the weekly number of hours that this shift requires.

### Shift Details

<b>Field or Control</b>	<b>Description</b>
<b>Type</b>	<p>The terms <i>punch</i> and <i>punch type</i> are interchangeable. You cannot have consecutive type (except the value Transfer) of the same value. Valid types are:</p> <p><i>In</i>: An In punch marks the start of a work period—either the beginning of a shift, or a return to work after a break or meal. The first punch of a punch or flex shift must be an In punch. Punch or flex shifts cannot be saved if an In punch does not have a punch time and duration.</p> <p><i>Transfer</i>: Start of a work period that generally denotes a change in task and compensation-related characteristics.</p> <p><i>Break</i>: Start of a break period. If you enter a Break punch, an In or a Transfer punch must immediately follow it to save the page. You can't have a Break punch followed by a Meal or Out punch.</p> <p><i>Meal</i>: Start of a meal period. If you enter a Meal punch, an In punch or Transfer punch must immediately follow it to save the page. For example, a Meal punch cannot be followed by a Break or Out punch.</p> <p><i>Out</i>: The last punch of a punch or flex shift must be an Out punch. An Out punch marks the start of nonwork time. For punch periods with a punch type of <i>Out</i>, the <b>Duration</b> field is unavailable. An Out punch cannot be entered without an In punch preceding it somewhere in the shift (edit at save time). Punch or flex shifts cannot be saved if an Out punch isn't entered or does not have a punch time. No additional punches can be added to a shift after the Out punch row.</p> <p><i>Elapsed</i>: This punch type is used only if you create an elapsed shift. The duration associated with this entry reflects the elapsed duration of the shift. An elapsed shift cannot be saved if an Elapsed punch does not have a punch duration.</p>



<b>Field or Control</b>	<b>Description</b>
<b>Time</b>	<p>This field is used only for punch and flex shifts; all punches (except the Out punch) in punch and flex shifts must have a time and a duration. Enter the time that this punch is scheduled. The first punch time of a shift must always be entered. Subsequent punch times can be entered, or the system can calculate punch times based on the duration of the preceding punch.</p> <p>Change the time of a punch other than the last punch and the duration changes accordingly, based on the new and the subsequent punch times. In addition, if the punch is not the first, the duration of the previous punch changes based on the changed punch's new time.</p> <p>Enter a punch time and the system calculates the duration, based on the punch time of the previous row. Enter a duration and the system calculates the value in this field on the next punch row.</p>
Time Zone	<p>Enter a time zone value if required. All punch times are converted to the Base time zone when stored on the database and converted when displayed/entered on the pages (this is done automatically by PeopleTools). When a punch time is entered, the duration of the previous punch is calculated. When a duration is entered, the time of the next punch is calculated. Those calculations are changed to take into account time zones. All times will be converted to the Base Timezone before calculating.</p>
<b>Duration</b>	<p>This field displays the duration of the punch period in hours. A user can enter it or the system can calculate it when the next punch time is entered.</p> <p>Change the time of a punch, other than the last punch and the duration changes, based on the new and the subsequent punch time. If it is not the first punch, the duration of the previous punch changes, based on the new punch time.</p> <p>If you delete a row, the duration of the punch above the deleted row changes to the difference between the punch time of that row and the punch time of the row that followed the deleted row.</p> <p>The system displays a warning if a punch or flex shift is longer than 24 hours.</p>

<b>Field or Control</b>	<b>Description</b>
<b>Cfg 1-4</b> (configuration 1-4) or <b>Sch Cfg 1-4</b> (schedule configuration 1-4)	These Schedule Configuration fields are for use with Global Payroll and Absence Management.

### Related Links

“Understanding Work Schedules” (PeopleSoft Global Payroll)

## (BRA) Details Bra Page

Use the Details Bra page (SCH\_SHIFT\_BRA) to specify shift types.

Navigation:

**Set Up HCM > Product Related > Time and Labor > Schedule Configurations > Shifts BRA > Detail Bra**

This example illustrates the fields and controls on the Details Bra page.

<b>Field or Control</b>	<b>Description</b>
<b>Work Shift type</b>	Specify the work shift type. Values are:  <i>Others</i>  <i>Regular</i>  <i>Regular Except Sunday Off</i>  <i>Regular Periodic Sunday Off</i>  <i>Regular Sunday Off</i>  <i>Rotating Shift</i>  <i>Scale of work 12x36</i>  <i>Scale of work 24x72</i>  <i>Uninterrupted Rotation Shift</i>

## Schedule Group Page

Use the Schedule Group page (SCH\_GROUP) to set up schedule groups to categorize schedules.

Navigation:

**Set Up HCM > Product Related > Time and Labor > Schedule Configurations > Schedule Groups > Schedule Group**

This example illustrates the fields and controls on the Schedule Group page. You can find definitions for the fields and controls later on this page.

The screenshot shows the 'Schedule Group' page with the following fields and values:

- Schedule Group:** KUUSA
- \*Description:** United States Schedule Group
- Short Description:** United Sta
- Default Record Group Set IDs:**
  - Default Set ID:** SHARE (with a tooltip: Table Set shared across Corp)
  - Clone Existing Schedule Group:** (empty field)

A schedule group can be thought of as a schedule organization unit, similar to a business unit both in idea and design. Shifts, Workdays and Schedule Definitions are created based on a SetID value, and Schedule Groups group these together by way of the Set Control value.

Schedule groups are specified on the Workgroup and Paygroup pages, and selected on the Schedule Assignment page. The label for Schedule Group is also set using values from the Text Catalog, and can be relabeled as needed.

<b>Field or Control</b>	<b>Description</b>
<b>Default SetID</b>	Select a SetID.
<b>Clone Existing Schedule Group</b>	<p>If an existing Schedule Group is entered, the SetID will be copied from its definition. The SetID must either already be defined on the SetID table, or be the same as the Schedule Group code. If it's the same as the Schedule Group, it will be inserted in the SetID table when the page is saved.</p> <hr/> <p><b>Note:</b> The Default SetID field must be blank in order to enter or select a value for the Clone Existing Schedule Group field.</p>

## Workday Page

Use the Workday page (SCH\_WRKDAY) to define shifts.

Workday is keyed by SetID, for further filtering when building a schedule.

Navigation:

**Set Up HCM > Product Related > Time and Labor > Schedule Configurations > Schedule Workdays > Workday**

This example illustrates the fields and controls on the Workday page. You can find definitions for the fields and controls later on this page.

<b>Field or Control</b>	<b>Description</b>
<b>Effective Date</b>	Enter an effective date for this workday.

## Definition Page

Use the Definition page (SCH\_DEFINITION) to set up schedule definitions.

Navigation:

**Set Up HCM > Product Related > Time and Labor > Schedule Configurations > Schedules > Definition**

This example illustrates the fields and controls on the Definition page. You can find definitions for the fields and controls later on this page.

The screenshot shows a web-based form for defining a schedule. At the top, there are tabs for 'Definition' and 'Schedule Shifts'. Below the tabs, the system identifies the 'Set ID' as 'SHARE' (Table Set shared across Corp) and the 'Schedule ID' as 'KU36HRSCH'. The 'Schedule Details' section includes:
 

- Effective Date: 01/01/1990
- \*Description: 36 hour schedule
- \*Definition Type: Punch
- \*Status: Active
- Short Description: 36 hour sc
- Days in Schedule: 3
- Rotating Schedule
- \*Daylight Saving Rule: Fixed Time

 Below this is a section titled 'Taskgroup for Time Reporting' with three input fields: Default Taskgroup, Task Template ID, and Time Reporting Template ID, each with a search icon.

Schedule Definitions contain a list of shifts to be worked on each day of the schedule. Schedule Definitions are keyed by SetID for further filtering, and associated to a schedule group for filtering when assigning to an employee.

<b>Field or Control</b>	<b>Description</b>
<b>Effective Date</b>	The effective date is used as the starting point of the Schedule Definition. Day one of the schedule starts from the effective date. When a new effective dated row is entered, the Day Numbers assigned to each row of the Schedule Shifts page are recalculated. The system uses the previous active effective dated row of the Schedule Definition to calculate which Day number the Schedule would be up to on the new effective date. That Day will be made Day number 1. Days following this will be adjusted accordingly.

<b>Field or Control</b>	<b>Description</b>
<b>Definition Type</b>	<p>Select the type of shift you are creating. Valid options are: <i>Elapsed, Flex, Punch</i>.</p> <p>If the schedule definition is saved as a particular type, it cannot be changed to another type. Prior to saving for the first time, the field can be changed in add mode. If the field is changed, any shifts from the Shift Details grid on the Shift page, that do not match the new type, are deleted.</p> <p>If you do change this field while in Add mode, and punch detail has already been entered, you receive a warning that punch detail will be deleted if the <b>Shift Type</b> field is changed. The system deletes the punch details for all effective-dated rows. This field is updated, for all effective-dated rows, to the new type.</p> <p>Once a shift is saved as one type, you cannot change it to another type of shift (you can't change an elapsed shift to a punch shift).</p> <p>If the value is <i>Elapsed</i>, only the elapsed punch types will display on the Shift page. An elapsed shift can contain only one punch entry.</p> <p>If the value is <i>Punch</i>, In, Out, Break, Meal, and Transfer punch types can be entered on the Shift page. The <b>Flex Shift Information</b> group box does not appear on the page. Punch shifts require an In and Out punch to be saved.</p> <p>If the value is <i>Flex</i>, only In and Out punches can be entered.</p>
<b>Num Days in Schedule (number of days in schedule)</b>	<p>Enter the number of days in this schedule. When the number of days is changed, the system automatically inserts or deletes the appropriate number rows from the Schedule Shifts page to ensure there is one row for each day of the schedule. There will always be at least one row for each day in the schedule.</p>
<b>Rotating Schedule</b>	<p>Select this field if the schedule is to be used as a rotating schedule. The Rotation Details group box appears on the page. See Rotating Schedules later in this section.</p>

<b>Field or Control</b>	<b>Description</b>
<b>Daylight Saving Rule</b>	<p>This field caters for two issues that may arise from the use of Time Zones:</p> <ol style="list-style-type: none"> <li>1. Where the shift starts and ends in different time zones, and those time zones have different daylight savings begin and end dates. The <i>Fixed Time</i> value is the default and is used to indicate that Fixed Time takes precedence. The Shift Duration will be recalculated in the Schedule Resolution process so that Duration = End Time – Start Time.</li> <li>2. Where the shift start and end time crosses the date time where daylight savings begins or ends. If <i>Fixed Duration</i> is selected, punch times will be recalculated in the Schedule Resolution process so that End Time = Start Time + Duration.</li> </ol> <hr/> <p><b>Note:</b> These calculations will be done only if different time zones are involved, or, the date is the beginning or end of daylight savings.</p>
<b>Default Taskgroup</b>	<p>If required, select a taskgroup for the Default Taskgroup field. The Task and Time Reporting Templates determine which reporting elements should be available on the detail rows on the Shift page. If the Taskgroup and Time Reporting Template are blank, no elements will be visible. Otherwise, the default Punch or Elapsed Time Reporting Template (depending on the Definition Type) from the Taskgroup definition will be used to determine which Time Reporting elements will be visible.</p> <p>If Task Profile Reporting is selected on the Time Reporting Template, the Task Profile ID element will be available, but no Task elements. If Task Element Reporting is selected, the Task Reporting Template from the Taskgroup definition will be used to determine the Task Elements that display.</p> <p>The Task and Time Reporting elements will not be available for <i>OUT</i> punches, or for <i>Off Shifts</i>.</p>
<b>Time Reporting Template ID</b>	<p>If a taskgroup is selected for the Default Taskgroup field, a Time Reporting Template may default. The Time Reporting Template may also be overridden manually.</p>

## Rotating Schedules

Select the Rotating Schedule field if the schedule is to be used as a rotating schedule. The **Rotation Details** grid appears on the page.

Each Rotation uses the same pattern of Shifts defined in the Schedule Definition, but has a different Relative Day number. The Relative Day number of the Rotation is used in the schedule resolution process when determining the Shifts to be worked on a specific date.

Each Rotation has an Offset Day number assigned. The Offset is used when the Schedule Calendar is derived, by adding it to the calculated Day Number. Therefore each Rotation follows the same pattern of Shifts, but will be at a different point in that pattern on any given day.

Define multiple rotations of a schedule by inserting each rotation manually or using the **Add Rotations** button. Click the **Add Rotations** button to automatically divide your schedule into rotations based on the number of days you specify for each rotation.

Once saved, you cannot clear the Rotating Schedule field and Rotation ID's cannot be changed or deleted. However, an Effective Status at the rotation details level allows a rotation row to be inactivated.

When an employee is assigned to a rotating schedule, the Schedule ID and Rotation ID fields on the Schedule Assignment record identifies which Schedule ID and Rotation ID the employee is assigned.

## Schedule Shifts Page

Use the Schedule Shifts page (SCH\_DEFINITION\_2) to set up shift information, or enter shifts setup on the Shift page, for the schedule definition.

Navigation:

**Set Up HCM > Product Related > Time and Labor > Schedule Configurations > Schedules > Definitions > Schedule Shifts**

This example illustrates the fields and controls on the Schedule Shifts page. You can find definitions for the fields and controls later on this page.

The screenshot displays the 'Schedule Shifts' page for a schedule definition. At the top, it shows 'Set ID SHARE' and 'Table Set shared across Corp'. The 'Schedule ID' is 'KU36HRSCH' and the '\*Punch Pattern' is 'Default'. The 'Schedule Details' section includes 'Effective Date' (01/01/1990), 'Description' (36 hour schedule), 'Taskgroup', 'Status' (Active), and 'Total Hours' (36.00). The 'Shift Details' section contains a table with the following data:

Select	Day	Workday ID	Shift ID	Off Shift	In	Break	In	Lunch	In	Out	Time Zone	Sched Hrs	More
<input type="checkbox"/>	1		KU36HR	<input type="checkbox"/>	7:00:00AM					7:00:00PM		36.00	More
<input type="checkbox"/>	2		OFF	<input checked="" type="checkbox"/>								0.00	More
<input type="checkbox"/>	3		OFF	<input checked="" type="checkbox"/>								0.00	More

Below the table, there are controls for 'Working with Shift Details' including 'Select All', 'Deselect All', 'Copy', 'Paste', and 'Clear Shifts'. The 'Days in Schedule' is set to 3. An 'Instructions' section provides guidance on how to use these controls.



<b>Field or Control</b>	<b>Description</b>
Punch Pattern	<p>On this page, if the <b>Definition Type</b> chosen on the Definition page is set to <i>Punch</i>, the <b>Punch Pattern</b> field will display with a value of <i>Default</i>, which is the punch pattern defined on the Time and Labor Installation — Configurations tab. If not all of the punch types are displayed that are needed, the user can change that from a value of <i>Default</i> to a value of <i>All Punches</i>, to see all punch types visible for use.</p> <hr/> <p><b>Note:</b> There are two navigation paths for this tab: Setup HCM, Install, Product Specific, Time and Labor Installation, Configurations tab, and the Global Payroll/Absence Management navigation path: Setup HCM, Product Related, Global Payroll and Absence Management, System Settings, Installation Settings, Schedule Settings Folder tab.</p>
Effective Date	<p>Enter an effective date for this shift. When a new effective dated row is entered, the day numbers assigned to each row of the Schedule Shifts page are recalculated. The system uses the previous active effective dated row of the schedule definition to calculate which day number the schedule would be up to on the new effective date. That day will be made day number 1. Days following this will be adjusted accordingly.</p>
Total Hours	Sums the scheduled hours of the schedule.
Show Calendar	Click this link to view the derived Schedule Calendar page as you design your schedule definition.

**Note:** You can also access the Schedule Calendar link from the Assign Work Schedule page.

## Shift Details

In the Shift Details grid, the Shift Time tab, Time Reporting Elements tab (if a time reporting template is chosen), Task Reporting Elements tab (if the time reporting template has task template selected instead of task profile), a Chartfields tab, if Chartfields are listed on the task template and finally a Configurable Totals tab.

The Configurable Totals tab will display the total of the Schedule Configuration Indicators that make up the scheduled day. There are four configuration totals, which can be used by Global Payroll or Absence Management users within their rules processing.

<b>Field or Control</b>	<b>Description</b>
Shift ID	<p>The user can enter shifts to complete the schedule pattern. Shifts are optional, as start and end times for a punch schedule can be entered (if the Shift ID field is blank), or scheduled hours for an elapsed schedule for a day. If there are two shifts in one day, the user can use the + button at the end of each row, to add another shift for the day.</p> <p>If Shift ID is blank, the <b>Shift Details</b> grid fields can be entered. All processing and validation of Shift Details entered here is the same as the standard Shift page. If Shift ID is entered, the details from the Shift definition are displayed, and the fields are display only.</p> <p>For an Off Shift, the user can choose an off shift that has been created, or specify a specific start and end time for the off time and select the Off Shift check box.</p>
Workday	<p>The user can enter workdays to complete the schedule pattern. Workdays are optional, and used to label the actual day.</p>

Click the More link beside a Shift Details row to be taken to the Shift definition page to update a shift if required. This view of the shift detail is important if there are changing elements within a shift, such as different timezones, task elements or time reporting elements.

Next to the **More** link, there is a column that displays a **Changing Elements in a Shift** icon. This icon represents a shift that has a different task or time reporting elements scheduled for different punch times. For more detail of the changing elements, you can click on the **More** link for Shift detail.

The column for **Changing Elements per Shift** also appears on the Schedule Calendar page (click the **Show Calendar** link on the Schedule Shifts page):

Use the Schedule Calendar page (SCH\_CLND\_VW\_SEC) to view a schedule calendar.

Navigation:

Click the **Show Calendar** link on the Schedule Shifts page.

This example illustrates the fields and controls on the Schedule Calendar page (1 of 2). You can find definitions for the fields and controls later on this page.

**Schedule Calendar**

Set ID: MBGEN      System Test Generic SetID  
 Schedule ID: MSCHPUNCHTSK      Punch with Task

From Date:    
 Workgroup:

Load Calendar
Previous Period
Next Period

**Schedule Calendar**

Shift Time		Time Reporting Elements		Task Reporting Elements		Configurable Totals		
Day	Date	Day Nbr	Workday ID	Shift ID	In	Break	In	Lunch
Monday	01/01/1990	1		MSCHPCH	8:00:00AM	11:00:00AM	11:20:00AM	1:00:00PM
Tuesday	01/02/1990	2		MSCHPCH	8:00:00AM	11:00:00AM	11:20:00AM	1:00:00PM
Wednesday	01/03/1990	3		MSCHPCH	8:00:00AM	11:00:00AM	11:20:00AM	1:00:00PM
Thursday	01/04/1990	4		MSCHPCH	8:00:00AM	11:00:00AM	11:20:00AM	1:00:00PM
Friday	01/05/1990	5		MSCHPCH	8:00:00AM	11:00:00AM	11:20:00AM	1:00:00PM
Saturday	01/06/1990	6		MSCHPCH	8:00:00AM	11:00:00AM	11:20:00AM	1:00:00PM
Sunday	01/07/1990	7		MFF				

This example illustrates the fields and controls on the Schedule Calendar page (2 of 2). You can find definitions for the fields and controls later on this page.

[Personalize](#) | [Find](#) | |

First 1-14 of 14 Last

In	Out	Time Zone	Sched Hrs	Taskgroup	More	Shift has changing elements
2:00:00PM	4:00:00PM		6.67	MSCHTSK2	<a href="#">More</a>	
2:00:00PM	4:00:00PM		6.67	MSCHTSK2	<a href="#">More</a>	
2:00:00PM	4:00:00PM		6.67	MSCHTSK2	<a href="#">More</a>	
2:00:00PM	4:00:00PM		6.67	MSCHTSK2	<a href="#">More</a>	
2:00:00PM	4:00:00PM		6.67	MSCHTSK2	<a href="#">More</a>	
2:00:00PM	4:00:00PM		6.67	MSCHTSK2	<a href="#">More</a>	
					<a href="#">More</a>	

To reuse days in the schedule, select the days to copy (by selecting the **Select** check box next to the appropriate rows), then click the **Copy** link. Next, select the day to restart the pattern, and click the **Paste** link. The **Select All** link will select all of the rows. The **Clear Shifts** link will clear all of the shift details entered on the selected rows. The **Clear All Boxes** link will clear all selected boxes. The **Click for Instructions** link is a collapsible section of instructional text on how to use the links.

There is a Scheduled Hours total for each day and also a Total Hours for the whole schedule at the top of the page.

When the schedule definition is saved, the system checks that any punch or flex shifts in the schedule do not overlap with a shift on the same, or a following day. The last shift of the schedule will also be checked for an overlap with the first shift.

---

**Note:** When setting up longer shifts, such as a 48 hour shift, you need a break between the shift and then an *Off* day, since the 48 hour shift spans over two days. It is up to the user how many off days there are in between.

---

**Related Links**

[Understanding Manager Self-Service for Scheduling Components](#)

---

## Validating Schedules

To validate schedules, use the Schedules to be Validated (SCH\_CLND\_REFRESH) component.

For punch type schedules, when a change is made to a shift, the related schedule(s) may need to be re-validated.

---

**Note:** New schedules do not require validation.

---

## Pages Used to Validate Schedules

<i>Page Name</i>	<i>Definition Name</i>	<i>Usage</i>
<a href="#">Schedules to be Validated Page</a>	SCH_CLND_REFRESH	Schedules may need to be re-validated when a change is made to a shift.

## Schedules to be Validated Page

Use the Schedules to be Validated page (SCH\_CLND\_REFRESH) to schedules may need to be re-validated when a change is made to a shift.

Navigation:

**Set Up HCM > Product Related > Time and Labor > Schedules > Review and Validate Schedules > Schedules to be Validated**

This page contains a list of schedules that need validating because a related shift was modified for punch type schedules. The system displays a schedule ID, description and status for each schedule that needs validating.

Click the Validate button to validate the schedule or click the Show Schedule link to access the Schedule Definition page.

---

**Note:** If an employee does not have a row in the Assign Work Schedule page, and is enrolled in a Global Payroll pay group on the Job Data page, the system uses the default schedule ID from the pay group to resolve the schedule. If the employee is not enrolled in a Global Payroll pay group on the Job Data page, but is enrolled in Time and Labor, the system uses the schedule ID from the employee's workgroup as the default schedule when resolving the schedule.

---

**Note:** When Time Administration creates payable time for an exception time reporter, who has a punch schedule, it applies daybreaker logic from the employee's workgroup when creating this time. When Time Administration creates forecasted payable time for an employee with a punch schedule, it also applies daybreaker logic from the employee's workgroup for this time. Time Administration's use of the daybreaker, daybreaker options and daybreaker ranges are applied to the schedule in the same way as employees who had reported punch time resolved into payable time or forecasted payable time.

---

---

## Sharing Work Schedules with Global Payroll

Time and Labor and Global Payroll use many of the same pages and records for schedule setup and assignment. In some cases, the page names vary slightly. If you're using both applications, you need to create and assign schedules only once. However, the information displayed on the scheduling pages may vary somewhat, depending on which application you access them with:

- The payees you can access through the Assign Work Schedule page or Manage Schedules page may vary depending on whether the page is opened through Global Payroll or Time and Labor.

The security options set up for each system determine which population of payees a user can work with.

- The schedule that appears when accessing the Assign Work Schedule page or Manage Schedule page in Time and Labor may differ from the schedule that appears when accessing the same pages in Global Payroll.

If an employee is in a Global Payroll pay group, the default schedule is based on the GP pay group, regardless of whether Time and Labor is used. If not a Global payroll employee and Time and Labor is installed, it will be derived from the Time and Labor workgroup assigned to the employee.

### Related Links

[Assigning Schedules](#)

[Creating Work Schedules and Schedule Definitions](#)

[Understanding Manager Self-Service for Scheduling Components](#)

---

## Importing Third-Party Schedules

Time and Labor has the ability to accept schedules created outside of the system, either from a third-party workforce scheduling system or another source. The data should be mapped to the SCH\_EXT\_TBL, which is the record behind the Scheduled Time Sync and Fullsync messages. The SCH\_ADHOC\_DTL and SCH\_MNG\_SCH\_TBL records serve as the final repository for this schedule override information. Process these schedules in Time Administration by setting up rules that run against this scheduled

information. Reported time can be created from this scheduled time, and payable time or forecasted payable time can also be created from this scheduled time.

When importing third-party schedule information, populate the Sched Source field with a value of *I* so that the system recognizes the data as an import. This ensures the correct precedence processing.

This diagram shows how Time and Labor accepts external scheduling information

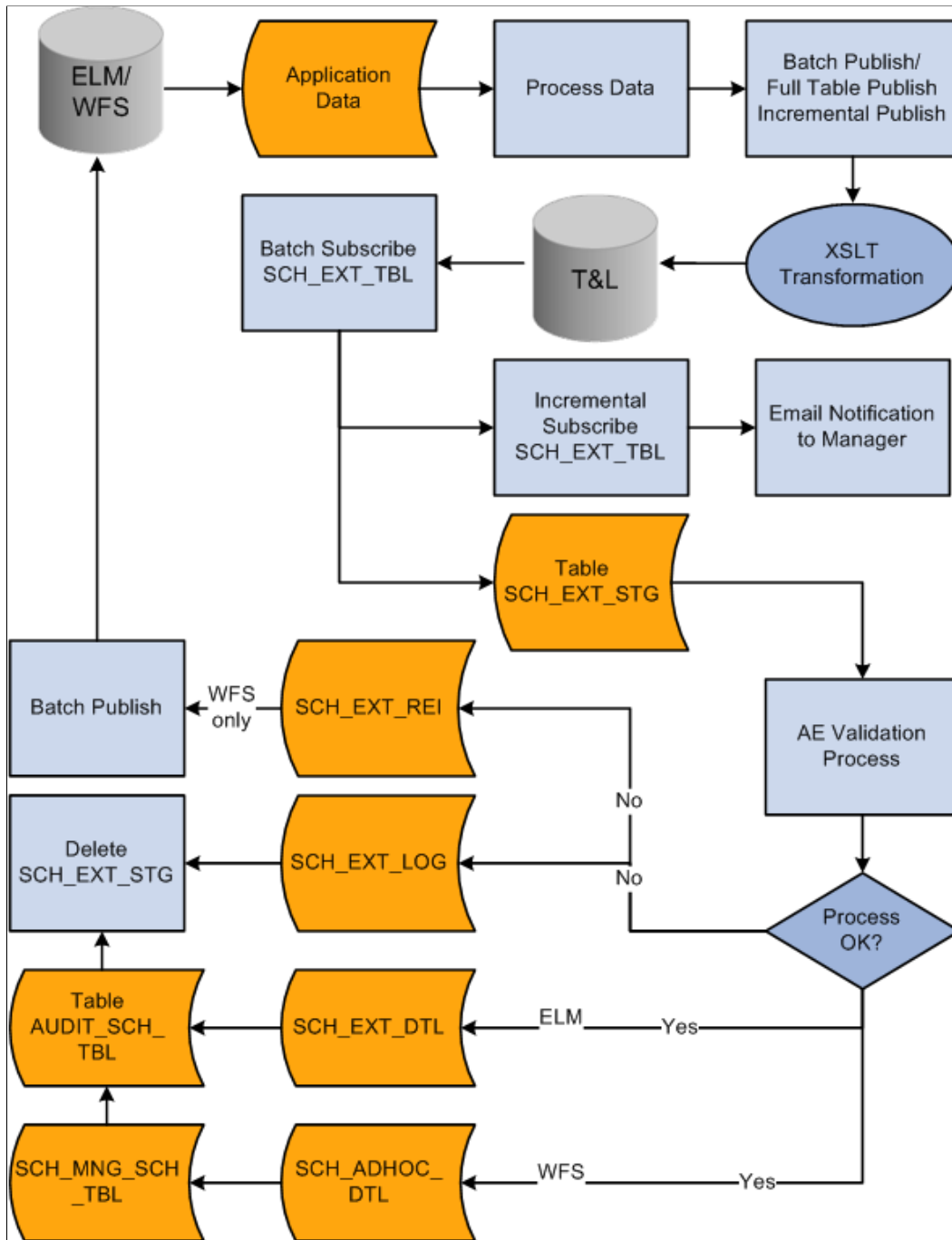

Time and Labor will create a common staging record structure (SCH\_EXT\_STG) so that it can subscribe information from various sources (LM, and Workforce Scheduling). The data subscribed is stored in the staging table. A validation application engine process (SCH\_EXTVALID) is invoked to process all

the data in the staging table before loading the final data into the application tables. After the validation process, the staging table will be deleted.

The staging and the application tables have exactly the same fields and key fields. Additional fields such as `PROCESS_INSTANCE`, `AUDIT_ACTION` are also included in the staging table for AE processing. Depending on the source, validated data will be inserted into the appropriate tables. For Workforce Scheduling information, the data will be inserted into `SCH_ADHOC_DTL` table, which carries the detailed scheduling information. It will also be inserted into the `SCH_MNG_SCH_TBL` for summarization purposes. .

If the `SCH_EXTVALID` validation process runs and finds rows of scheduled time from a workforce scheduling system that either do not pass validations, or are missing key values or are duplicate rows, the `SCHEDULED_TIME_ERROR` batch message gets triggered. This message publishes these rows back to the scheduling system with a `REJECTED_REASON` code defined in the `SCH_EXT_REJ` table. The `SCHEDULED_TIME_ERROR` message is based on the `SCH_EXT_REJ` record structure. The data which does not pass validations will first be staged in the `SCH_EXT_REJ_STG` table. Once the message has been published, the system clears the staging table, and the rejected rows will ultimately be stored in the `SCH_EXT_LOG` table. The fields validated are `EmplID`, `Empl Rcd` and `SCHED_SOURCE`. In order to use the `SCHEDULED_TIME_ERROR` message, its batch publish rule must be activated

Any other information such as Training, and so on, will be inserted into `SCH_EXT_DTL` table. Additionally, the `AUDIT_SCH_TBL` is an audit trail to track all transactions that are added, changed or deleted successfully into `SCH_ADHOC_DTL` table. A new field has been introduced `SCH_CATEGORY` to identify the category of the schedule. The category can be training information, absence, work, or other. The same category can come from different sources. For instance, absence is a category that can come from Workforce Scheduling or Absence systems. In the current application, ELM does not send to Time and Labor this schedule category field due to the new field has just been introduced. Therefore, Time and Labor will derive the data coming from ELM being categorized under "training data."

---

**Note:** Scheduled Time Fullsync messaging is used to transmit data from third-party scheduling systems to Time and Labor. The Scheduled Time Sync message for integration with third-party scheduling systems is not used.

Both the Scheduled Time Fullsync and Scheduled Time Sync messages are used for integration with Enterprise Learning Management.

The Scheduled Time Fullsync message never deletes what exists in the `SCH_EXT_TBL` or the corresponding application tables. For that reason, the Fullsync message should be run once for integration with ELM, to bring over the training information, such as activity and session information. For use with a third-party scheduling system, the Scheduled Time Fullsync should send over new scheduling information. However, if the user would like to change the schedule for a day that has already been published from a third-party scheduling system, they would need to send that same data over with the `DELETE_IND` equal to *Y* for that data and then send over the data they want added for that day with the `DELETE_IND` equal to *N*.

Also, for sending punch time schedule information, if the third-party scheduling system is transmitting data with `START_TIME` and `END_TIME` on one row of data, when it gets converted to two rows in the application table, with an *In* and an *Out* punch for the rows, with the appropriate times updated in the `PUNCH_DTTM` field.

Scheduled Time Sync messaging can also trigger a notification to the manager that an external schedule event has changed, if you setup the notifications for External Schedule Event on the Time and Labor Installation page. For example, an employee has enrolled in training, or the training session was cancelled, or the employee dropped the training. Both the Scheduled Time Fullsync and the Scheduled Time Sync messages insert into the `AUDIT_SCH_TBL` to track schedule audit changes for external scheduling events.

---

**Note:** The main record that is used to map data to is SCH\_EXT\_TBL. This is the record used for Scheduled Time Fullsync and Scheduled Time Sync messages.

The ELM flag on the General Installation page, needs to be checked, in order for the user to view ELM training data icons in Manage Schedules, Monthly Schedules and Calendars.

**Note:** Scheduling does not administer workforce scheduling, as it does not run rules to balance resources and constraints.

The following table describes the fields for SCH\_EXT\_TBL for the Scheduled Time Fullsync and Scheduled Time Sync messages:

**Note:** The fields marked as "not validated" are not part of the validation application engine, the system accepts the values as they are sent.

<b>Field Name</b>	<b>Type</b>	<b>Validation Process</b>	<b>Description</b>
EMPLID	Char 11	EmplID must exist in HR database. Also, the person must have an active row in Job record.	Employee ID
EMPL_RCD	Nbr 3	EmplID must have valid employee record.	Employee Record Number
SCHED_SOURCE	Char 2	Source must be from a valid source defined.	Source AB – Absence LM – Learning Management GP – Global Payroll OT – Other TR – HR Training Administration WF – Workforce Scheduling
SEQ_NO	Nbr 2	Number to define each shift per day. For multiple shifts, must use the next number in sequence to specify a different shift. If there is one row per scheduled punch, then each row will have the same number for each shift. Example: All rows for Shift 1 will have "1", all rows for Shift 2 will have "2".	Sequence Number for multiple shifts (WFS only)



<b>Field Name</b>	<b>Type</b>	<b>Validation Process</b>	<b>Description</b>
SEQNUM	Nbr 3	Each number should be unique for each shift. If there is one row per scheduled punch, each row SEQNUM must be unique and in order. If more than one shift per day, the numbering must start over again.	Sequence Number
SCH_CATEGORY	Char 2	Field must have value when getting inserted into the application table.	Schedule Category AB: Absence MT: Meeting OT: Other TR: Training WK: Work
PUNCH_TYPE	Char 2	Punch type must be from a valid punch type defined depending on the source. Not applicable for LM.	Type of Punch 0 – Elapsed 1 – In 2 – Out 3 – Meal 4 – Break 5 - Transfer
DUR	Date 10	No validation on this field.	Workday Start Date  For WFS - For Punch Shifts, DUR is the Date part of PUNCH_DTTM for the first IN Punch of a Punch Shift.  For Elapsed Shifts, DUR should be coming in on the WFS message. PUNCH_DTTM would not be used.  For LM – DUR is equal to Session Date
SCH_PRIM_ALT_IND	Char 1	No validation on this field.	Default to "P" (Primary), Values are "P" for Primary and "A" for Alternate.

<b>Field Name</b>	<b>Type</b>	<b>Validation Process</b>	<b>Description</b>
PUNCH_DTTM	DfTm 26	No validation on this field.	Date From WFS - PUNCH_DTTM for the first IN Punch of a Punch Shift.
SCHEDULE_GRP	Char	No validation on this field.	Schedule Group
SETID	Char 5	No validation on this field.	Set ID
WRKDAY_ID	Char 10	No validation on this field.	Workday ID
OFFDAY_IND	Char 1	No validation on this field.	Off Day Indicator Y: Yes N: No
SHIFT_ID	Char 10	No validation on this field.	Shift ID
DELETE_IND	Char 1	No validation on this field.	Delete Schedule Detail Y: Yes N: No
TL_TR_SBR	SubRecord		
TRC	Char 5	No validation on this field.	Time Reporting Code
TL_QUANTITY	Sign 12.6	No validation on this field.	Quantity
CURRENCY_CD	Char 3	No validation on this field.	Currency Code
COUNTRY	Char 3	No validation on this field.	Country
STATE	Char 6	No validation on this field.	State
LOCALITY	Char 10	No validation on this field.	Locality
COMP_RATECD	Char 6	No validation on this field.	Comp Rate Code
BILLABLE_IND	Char 1	No validation on this field.	Billable Indicator
OVERRIDE_RATE	Sign 12.6	No validation on this field.	Override Rate

<b>Field Name</b>	<b>Type</b>	<b>Validation Process</b>	<b>Description</b>
TL_TASK_SBR	SubRecord		
COMPANY	Char 3	No validation on this field.	Company
BUSINESS_UNIT	Char 5	No validation on this field.	Business Unit
SETID_LOCATION	Char 5	No validation on this field.	Location SetID
LOCATION	Char 10	No validation on this field.	Location Code
SETID_DEPT	Char 5	No validation on this field.	Department SetID
DEPTID	Char 10	No validation on this field.	Department
SETID_JOBCODE	Char 5	No validation on this field.	Jobcode SetID
JOBCODE	Char 6	No validation on this field.	Jobcode
POSITION_NBR	Char 8	No validation on this field.	Position Number
PRODUCT	Char 6	No validation on this field.	Product
CUSTOMER	Char 10	No validation on this field.	Customer
ACCT_CD	Char 25	No validation on this field.	Account Code
BUSINESS_UNIT_PC	Char 5	No validation on this field.	PC Business Unit
BUSINESS_UNIT_PF	Char 5	No validation on this field.	Perf Business Unit
PROJECT_ID	Char 15	No validation on this field.	Project/Grant
SETID_ACTIVITY	Char 5	No validation on this field.	Activity SetID
ACTIVITY_ID	Char 15	No validation on this field.	Activity ID
RESOURCE_TYPE	Char 5	No validation on this field.	Resource Type
SETID_RESOURCE	Char 5	No validation on this field.	Resource SetID

<b>Field Name</b>	<b>Type</b>	<b>Validation Process</b>	<b>Description</b>
RESOURCE_CATEGORY	Char 5	No validation on this field.	Resource Category
RESOURCE_SUB_CAT	Char 5	No validation on this field.	Resource Sub category
TASK	Char 5	No validation on this field.	Task
USER_FIELD_1	Char 10	No validation on this field.	User Field 1
USER_FIELD_2	Char 10	No validation on this field.	User Field 2
USER_FIELD_3	Char 15	No validation on this field.	User Field 3
USER_FIELD_4	Char 20	No validation on this field.	User Field 4
USER_FIELD_5	Char 20	No validation on this field.	User Field 5
RULE_ELEMENT_1	Char 10	No validation on this field.	Rule Element 1
RULE_ELEMENT_2	Char 10	No validation on this field.	Rule Element 2
RULE_ELEMENT_3	Char 10	No validation on this field.	Rule Element 3
RULE_ELEMENT_4	Char 10	No validation on this field.	Rule Element 4
RULE_ELEMENT_5	Char 10	No validation on this field.	Rule Element 5
SCH_CONFIG_IND1	Char 1	No validation on this field.	Schedule Config Indicator 1
SCH_CONFIG_IND2	Char 1	No validation on this field.	Schedule Config Indicator 2
SCH_CONFIG_IND3	Char 1	No validation on this field.	Schedule Config Indicator 3
SCH_CONFIG_IND4	Char 1	No validation on this field.	Schedule Config Indicator 4
SCH_EXT_FLD1	Char 10	No validation is done as different sources can send different values.	Key Field 1 used from Source. ELM - Session ID
SCH_EXT_FLD2	Char 10	No validation is done as different sources can send different values.	Additional key Field 2 from Sources

<b>Field Name</b>	<b>Type</b>	<b>Validation Process</b>	<b>Description</b>
SCH_EXT_FLD3	Char 10	No validation is done as different sources can send different values.	Additional key Field 3 from Sources
SCH_EXT_ACT_STATUS	Char 1	No validation is done. LM sends this value.	Schedule Activity Status
SCH_EXT_ACT_TYPE	Char 3	No validation is done. LM sends this value.	Schedule Activity Type
ACTIVITY_NAME	Char 200	No validation is done. LM sends this value.	Description of activity
SCH_EXT_EVENT_TYPE	Char 4	No validation is done. LM sends this value.	Schedule Event Type
START_DATE	Date 10	Start Date of the Schedule.	LM: Start Date of Session WFS: Determine the day of the shift
END_DATE	Date 10	End Date of the Schedule	LM: End Date of Session WFS: End Date of the Schedule
START_TIME	Time 15	No validation done.	LM: Start Time of Session WFS: Convert to IN Punch
END_TIME	Time 15	No validation done.	LM: End Time of Session WFS: Convert to OUT Punch Time

<b>Field Name</b>	<b>Type</b>	<b>Validation Process</b>	<b>Description</b>
TIMEZONE	Char 9	No validation done. Time Zone to be populated for scheduled times. Use this field to convert the time to the base time zone.	Time Zone
FACILTY_DESCR	Char 50	No validation done.	Facility Description
ADDRESS1	Char 55	No validation is done. LM sends this value.	Address1
ADDRESS2	Char 55	No validation is done. LM sends this value.	Address2
ADDRESS3	Char 55	No validation is done. LM sends this value.	Address3
ADDRESS4	Char 55	No validation is done. LM sends this value.	Address4
CITY	Char 30	No validation is done. LM sends this value.	City
NUM1	Char 6	No validation is done. LM sends this value.	Number 1
NUM2	Char 4	No validation is done. LM sends this value.	Number 2
HOUSE_TYPE	Char 2	No validation is done. LM sends this value.	Type of House AB: House Boat Reference WW: House Trailer Reference
ADDR_FIELD1	Char 2	No validation is done. LM sends this value.	Address Field 1
ADDR_FIELD2	Char 4	No validation is done. LM sends this value.	Address Field 2
ADDR_FIELD3	Char 4	No validation is done. LM sends this value.	Address Field 3
COUNTY	Char 30	No validation is done. LM sends this value.	County

<b>Field Name</b>	<b>Type</b>	<b>Validation Process</b>	<b>Description</b>
POSTAL	Char 12	No validation is done. LM sends this value.	Postal Code
GEO_CODE	Char 11	No validation is done. LM sends this value.	Geographical Code
IN_CITY_LIMIT	Char 1	No validation is done. LM sends this value.	In City Limit
ORIGINATORID	Char 30	No validation done.	Original operator ID who creates the record
DATETIME_CREATED	DfTm 26	No validation is done. LM sends this value.	Date and Time first created
OPRID_LAST_UPDT	Char 30	No validation is done. LM sends this value.	Last person who updates the record
DATETIME_UPDATED	DfTm 26	No validation is done. LM sends this value.	Date and Time last updated

## Managing Third-Party Schedules

This section presents tips for addressing:

- Rejected schedule records.
- Field requirements for transmitting schedule data.

### Rejecting Schedule Records

SCH\_EXT\_LOG is the table containing rows of all rejected scheduled time that did not make it into the PeopleSoft Application tables SCH\_EXT\_REJ\_STG is the staging table for rejected rows that would get sent back to a third party scheduling system.

For both the SCH\_EXT\_LOG and SCH\_EXT\_REJ\_STG tables, there is a SCH\_REJECT\_REASON field which explains why the scheduled time is rejected.

SCH\_REJECT\_REASON codes :

<b>Code</b>	<b>Description</b>
01	Invalid Employee and Employee Record Number
02	Invalid Schedule Source

<b>Code</b>	<b>Description</b>
03	Invalid Schedule Category
04	Invalid Punch Type
05	Invalid Activity
06	Invalid Activity Type
07	Invalid Event
08	Invalid Time Zone
09	Transaction already exists
10	Cannot add, transaction exists
11	Cannot change or delete, transaction exists

### Field Requirements for Transmitting Schedule Data

These are tips for working with some field requirements for transmitting schedule data:

- **Multiple Shifts**  
To send multiple shifts per day, ensure the fields SEQ\_NO and SEQNUM are correctly populated.
- **SEQ\_NO**  
Should be populated with the same number for the same shift for the day.
- **SEQNUM**  
Should be populated with an incremented number for each row for the same shift for the day, and then start over again if another shift exists on the same day.
- **Multiple Punch Rows for Punch Shift**  
For a punch schedule, if sending PUNCH\_TYPE and PUNCH\_DTTM fields, do not need to populate START\_DATE, END\_DATE, START\_TIME and END\_TIME
- **One row for Punch Shift**  
To send a summarize row for punch schedule for the day, the fields START\_DATE, END\_DATE, START\_TIME and END\_TIME need to be populated, and the system will then split the time into an IN and OUT punch into SCH\_ADHOC\_DTL table.



Total punch scheduled hours will be summarized based on the Schedule Total option (INCL\_ML\_BRK\_FLG) on the Configuration tab of the TL Installation component or the Schedule Settings page on the System Settings of Global Payroll and Absence Management. The inclusion of meal and break punches to determine total scheduled hours are the options for this configuration.

- DUR

DUR should always be populated with the date, whether sending Elapsed or Punch Schedule

- TL\_QUANTITY

Should be populated if sending Elapsed Scheduled Hours.

The following table illustrates field format examples

<b>Field</b>	<b>Format</b>	<b>Example</b>
START_TIME	HH:MM:SS.ssssss	07:00:00.000000
END_TIME	HH:MM:SS.ssssss	13:30:00.000000
START_DATE	YYYY-MM-DD	2004-06-11
END_DATE	YYYY-MM-DD	2004-06-11



# Establishing Static and Dynamic Groups

---

## Understanding Static and Dynamic Groups

Several online and batch processing functions in Time and Labor use groups of time reporters that meet selection criteria that you define. Groups can be static or dynamic:

<i>Term</i>	<i>Definition</i>
<b>Static group</b>	Comprises users who meet the selection criteria defined on the Selection Criteria page. Membership does not change unless you add or remove members or change the selection criteria.
<b>Dynamic group</b>	<p>The system updates membership automatically when you run a batch process or use the system's refresh feature. The process uses the date that the program runs to determine which time reporters satisfy the group selection criteria.</p> <p>Dynamic groups are resolved at run time for batch processes, but the group detail tables are not permanently updated. Refreshing dynamic groups within the group or using the Refresh Dynamic Group batch process will update the group detail tables.</p> <p>Time Administration and other batch processes call and refresh the group population as of start date that you specify on the run control page. If you do not enter a start date, they system uses current data for processing, but does not refresh the group details for other processes.</p>

Time reporters can belong to several groups simultaneously, depending on your reporting needs. For example, a time reporter may belong to a group of people on the fourth floor and to a group of managers.

Use the refresh feature to update group membership so that many online processes can use these groups.

---

## Understanding Group Security

Time and Labor provides two security features that protect sensitive time reporter data:

- Group Creation Security.

Prevents users who are associated with particular row-security permission lists from creating groups based on records and fields that contain personal time reporter data.

- Group Security.

Defines which row-security permission lists have access to the time reporters in each group. If you choose to use group security rather than HCM data permission security for a particular permission list, everyone who uses Time and Labor must belong to a group.

## Task Group Borrowing

When you create a static or dynamic group, you can choose a task group for group members. The system uses the selected task group when time is reported for group members on the Mass Time Reporting page. The task group assigned to the group takes precedence over a task group assigned directly to a time reporter on the Maintain Time Reporter Data page.

## Time and Labor Functions That Use Groups

These online functions use groups:

- Mass time reporting.
- Group schedule assignment.
- Approve payable time (this uses the Manager Search filter feature which includes Group ID).
- Manage exceptions (this uses the Manager Search filter feature which includes Group ID).
- View TR Status page (uses Group ID).
- Manager Search filter used on Manager Self-Service pages.

These batch processes use groups:

- Time administration.
- Batch approval.

When generating a TimeCard report or Scheduled Hours report, you can select the groups to include.

---

**Note:** A basic knowledge of SQL is helpful when defining groups.

---

## Related Links

[Understanding Row Security Permission Lists](#)

[Understanding Time Reporter Data](#)

---

## Setting Group Creation Security

To set up group creation security, use the Group Creation Security (TL\_GROUP\_FIELD\_SEC) component.

This section provides an overview of group creation security and discusses how to set group creation security.

## Understanding Group Creation Security

You can prevent users associated with particular row-security permission lists from creating dynamic and static groups that are based on sensitive data. Use the Group Creation Security page to identify the records and fields that are available to users associated with a given row-security permission list when creating and viewing groups. You can designate which of up to six records users can access to define the selection criteria for group membership and the fields within the six accessible records.

### Accessible Records

You can grant access to fields within the six records such as JOB, EMPLOYMENT, PERSONAL\_DT\_FST, SCH\_ASSIGN, TL\_EMPL\_DATA (available only when the Time and Labor option is selected on the Installation Table - Products page) and GP\_PYGRP (available only when Global Payroll Core is selected on the Installation Table - Products page).

## Page Used to Set Group Creation Security

<i>Page Name</i>	<i>Definition Name</i>	<i>Usage</i>
<u>Group Creation Security Page</u>	TL_GRP_FLD_SEC	Prevent row-security classes from creating groups that are based on sensitive data.

## Group Creation Security Page

Use the Group Creation Security page (TL\_GRP\_FLD\_SEC) to prevent row-security classes from creating groups that are based on sensitive data.

Navigation:

**Set Up HCM > Security > Time and Labor Security > Group Creation Security > Group Creation Security**

This example illustrates the fields and controls on the Group Creation Security page. You can find definitions for the fields and controls later on this page.

### Group Creation Security

Row Security Permission List HCDPALL
Refresh Record Security

Allow Full Access
Remove All Access

---

Record
Find | View All
First 1 of 6 Last

Record Name EMPLOYMENT
Allow Record Access
Remove Record Access

---

Record Field Accessibility
Personalize | Find | 
First 1-20 of 20 Last

Field Name	Accessible
BENEFIT_RCD_NBR	<input checked="" type="checkbox"/>
BUSINESS_TITLE	<input checked="" type="checkbox"/>
CMPNY_SENIORITY_DT	<input checked="" type="checkbox"/>
EMPLID	<input checked="" type="checkbox"/>
EMPL_RCD	<input checked="" type="checkbox"/>
EXPECTED_RETURN_DT	<input checked="" type="checkbox"/>
HIRE_DT	<input checked="" type="checkbox"/>
HOME_HOST_CLASS	<input checked="" type="checkbox"/>
LAST_DATE_WORKED	<input checked="" type="checkbox"/>
LAST_INCREASE_DT	<input checked="" type="checkbox"/>
LAST_VERIFICATN_DT	<input checked="" type="checkbox"/>
NEE_PROVIDER_ID	<input checked="" type="checkbox"/>
OWN_5PERCENT_CO	<input checked="" type="checkbox"/>
PROBATION_DT	<input checked="" type="checkbox"/>
PROF_EXPERIENCE_DT	<input checked="" type="checkbox"/>

<i>Field or Control</i>	<i>Description</i>
<b>Refresh Record Security</b>	<p>Click to retrieve all records and fields that you have authority to access. The system clears previously defined access instructions for the row-security permission list identified on this page.</p> <p>This refresh feature is appropriate when:</p> <ul style="list-style-type: none"> <li>You've added fields to the selected six records and want to grant access to the new fields.</li> <li>You install Global Payroll after using this page to define security.</li> </ul> <p>When you click the button, the system retrieves the GP_PYGRP record.</p> <hr/> <p><b>Warning!</b> If you refresh record security after granting access to certain records and fields, the system clears all access definitions.</p> <hr/>
<b>Allow Full Access</b>	<p>Click to enable users associated with the row-security permission list to access all six records when creating and viewing groups. The system automatically selects all fields for all records that users have authority to access, according to the assigned row-security permission list.</p>
<b>Remove All Access</b>	<p>Click to prevent all users associated with the row-security permission list from using any of the six records and related fields as selection criteria when creating groups. Users are also prevented from viewing groups with membership based on these records. The system clears all check boxes for all six records.</p>

## Record

<i>Field or Control</i>	<i>Description</i>
<b>Allow Record Access</b>	<p>Click to allow access to all fields in the record that is currently displayed. The system automatically selects the <b>Accessible</b> check box to the right of each field name.</p>
<b>Remove Record Access</b>	<p>Click to disallow access to all fields in the record that is currently displayed. The system automatically clears the <b>Accessible</b> check box to the right of each field name.</p>

## Record Field Accessibility

<i>Field or Control</i>	<i>Description</i>
<b>Accessible</b>	Indicates whether users have the ability to include the field within the selection criteria that they specify when creating groups.

## Creating and Updating Static Groups

To create or update static groups, use the Static Group (TL\_STATIC\_GRP) component.

This section discusses how to specify criteria for static group members, view and update static group members and set up static group security

## Pages Used to Create and Update Static Groups

<i>Page Name</i>	<i>Definition Name</i>	<i>Usage</i>
<u>Static Group - Selection Criteria Page</u>	TL_GROUP_S1	Specify the criteria for selecting group members.
<u>Static Group - Current Group Members Page</u>	TL_GROUP_S2	View, update, and add comments to a list of the members of a static group.
<u>Static Group - Security by Group Page</u>	TL_GRP_SECURITY	Specify which row-security permission lists can view and edit time reporting data for this group of time reporters.

## Static Group - Selection Criteria Page

Use the Static Group - Selection Criteria page (TL\_GROUP\_S1) to specify the criteria for selecting group members.

Navigation:

**Set Up HCM > Security > Time and Labor Security > Static Group > Selection Criteria**



This example illustrates the fields and controls on the Static Group – Selection Criteria page. You can find definitions for the fields and controls later on this page.

<b>Field or Control</b>	<b>Description</b>
<p><b>Taskgroup for Time Reporting</b></p>	<p>Select a task group for the system to apply when a user enters time for the members of this group through the Mass Time Reporting page. Use this feature when a group of time reporters is working on a temporary project or assignment.</p> <p>The task group in this field takes precedence over the task group assigned to time reporters on the Maintain Time Reporter Data page.</p>
<p><b>TL Approval Group</b></p>	<p>Select to indicate that this group is used for Time and Labor approvals. When you select the <b>TL Approval Group</b> field, the Security by Group Tab is not available for use.</p> <p>Approval groups define a list of approvers. Selecting this field enables you to use the group ID to set up approvals on the Workgroup or Time Reporting Code component when the Approval Definition ID is TLGroupMultiStageALL, TLGroupMultiStageSOME, or TLGroupSingleStageALL. You can also use an approval group to set up adhoc approval groups to filter available approvers designated as an ad hoc approver. Row security is not applicable to approval groups since they are not used to grant row security access.</p> <p>See <a href="#">Understanding the Approval Process in Time and Labor</a>.</p>

### Group Parameters

Complete the **Group Parameters** group box fields for a new group that you want to include:

- Members from an existing static group.
- Members from an existing static group plus members of another static group.

- Members from an existing static group minus members of another static group.

<b>Field or Control</b>	<b>Description</b>
<b>Group 1</b>	<p>Select the name of the group to include its membership in the new group.</p> <p>In the field to the right, indicate whether to include or exclude members of a second group:</p> <p>Select <i>Minus</i> to exclude all members of the group in the Group 2 field.</p> <p>Select <i>Plus</i> to include all members of the group in the Group 2 field.</p>
<b>Group 2</b>	<p>If you selected <i>Minus</i> or <i>Plus</i> in the field to the left, select the name of the group for which to include or exclude membership.</p>
<b>Add to Group</b>	<p>Click to add members to the group, based on the criteria you've selected.</p> <hr/> <p><b>Note:</b> You must select the <b>Add to Group</b> button to add time reporters to the group.</p> <hr/>

### Select Parameters

Use the fields in this group box to define the selection criteria for adding members to the group. For example, you may want to add only those people who work in a particular location or job. The system uses the criteria to generate the WHERE clause of a SQL select statement.

Complete the **Group 1** or **Group 2** field for the system to include all time reporters who fit the group parameters and all time reporters who meet the criteria defined in these fields:

<b>Field or Control</b>	<b>Description</b>
<b>*()</b>	<p>Select a bracket type. The system processes the statement in brackets before it processes the rest of the SQL WHERE clause. Select up to five open brackets: ((((((.</p>
<b>Record</b>	<p>Select a record name. Only records with access given on the Group Creating Security page are available. You can choose any field from this record.</p>

<b>Field or Control</b>	<b>Description</b>
<b>Field Name</b>	Select a field name. Only fields with access given on the Group Creation Security page are available. You can now define this field with any valid value as part of your selection criteria.
<b>SetID</b>	<p>If you select <i>Job</i> in the <b>Record</b> field and one of the following fields listed in the <b>Field Name</b> field, select the setID with which the field is associated. In all other cases, the <b>SetID</b> field is unavailable.</p> <p>SAL_ADMIN_PLAN</p> <p>GRADE</p> <p>STEP</p> <p>SALARY_MATRIX_CD</p> <p>DEPTID</p> <p>JOBCODE</p> <p>LOCATION</p>
<b>Operator</b>	<p>To perform a mathematical operation, select the appropriate symbol. Valid entries are: &lt;, &lt;=, &lt;&gt;, =, &gt;, &gt;=, and <i>LIKE</i>.</p> <p>If you select <i>LIKE</i>, you can enter a partial value in the <b>Value</b> field. For example, <i>S</i>.</p>
<b>Value</b>	<p>Select a value for the field name.</p> <p>If you selected <i>LIKE</i> as the operator, do not enter quotation marks or the percent sign in the <b>Value</b> field.</p> <p>This field is case-sensitive. Enter the value exactly as it is defined in the database.</p> <p>If entering a date, be sure to enter the proper date format for your environment.</p>
*)	Select the closing bracket type.
(unlabeled)	If you want to add another parameter to your selection criteria (the WHERE clause), select <i>AND</i> or <i>OR</i> .

<i>Field or Control</i>	<i>Description</i>
<b>Add to Group</b>	Click <b>Add to Group</b> to add the time reporters that fit the criteria created to this static group. This button also updates the meta-SQL in the <b>SQL Object</b> field.
<i>Field or Control</i>	<i>Description</i>
<b>View SQL</b>	Click to view the SQL code generated by the WHERE clause.

## Prompts with Dependencies

In some cases, the **Value** field does not provide a list of valid values from which to choose. This is because the selected field name, by itself, does not give the system enough information to retrieve the appropriate set of values. That is, the values for the selected field are dependent on the values for one or more other fields. Although you can type a value for any field in the **Value** field, the system may not return the expected results if the value is not unique. This table lists the fields whose values are dependent on other fields.

<i>Record</i>	<i>Field Name</i>	<i>Table</i>	<i>Dependencies</i>
EMPLOYMENT	TIME_RPT_LOC	TIMERPT_LOC_TBL	COMPANY
JOB	ACTION_REASON	ACTN_REASON_TBL	ACTION
JOB	CONTRACT_NUM	CNT_ACTIVE_VW	EMPL_ID
JOB	HOLIDAY_SCHEDULE	HOLIDAY_VW	REG_REGION
JOB	PAYGROUP	PAYGROUP_TBL	COMPANY
JOB	EMPL_TYPE	PAYGRP_EMPLTYPE	COMPANY, EMPL_TYPE, PAYGROUP
JOB	GRADE	SAL_GRADE_TBL	SAL_ADMIN_PLAN, SETID
JOB	STEP	SAL_STEP_TBL	GRADE, SAL_ADMIN_PLAN, SETID
JOB	REG_REGION	REG_STANDARD_VW	OPRCLASS

<b>Record</b>	<b>Field Name</b>	<b>Table</b>	<b>Dependencies</b>
PERSONAL_DT_FST	BIRTHSTATE	BIRTHSTATE_VW	BIRTHCOUNTRY
TL_EMPL_DATA	TASK_PROFILE_ID	TL_TASKGRP_PRFL	TASKGROUP

### Related Links

[Understanding Task Reporting Requirements](#)

## Static Group - Current Group Members Page

Use the Static Group - Current Group Members page (TL\_GROUP\_S2) to view, update, and add comments to a list of the members of a static group.

Navigation:

**Set Up HCM > Security > Time and Labor Security > Static Group > Current Group Members**

This example illustrates the fields and controls on the Static Group – Current Group Members. You can find definitions for the fields and controls later on this page.

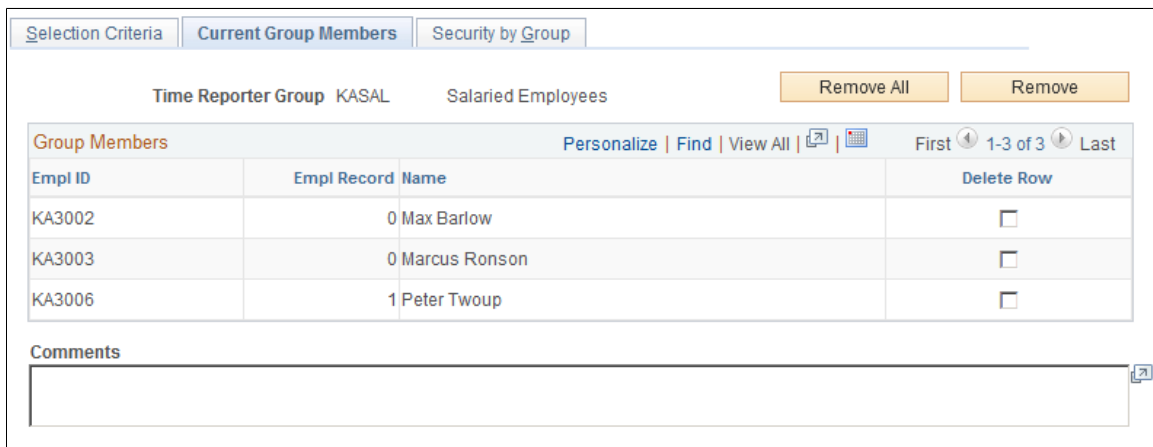

<b>Field or Control</b>	<b>Description</b>
<b>Sort By</b>	Select <i>EmplID</i> (employee ID) to sort members by employee ID or select <i>Name</i> to sort members alphabetically by last name.
<b>Delete Row</b>	To remove a member from the group, select the <b>Delete Row</b> check box to the right of the member's name.
<b>Remove All</b>	Click to remove all time reporters from the group.

<b>Field or Control</b>	<b>Description</b>
<b>Remove</b>	To remove selected time reporters from the group, select the <b>Delete Row</b> check box to the right of the time reporter's name and click this button.

## Static Group - Security by Group Page

Use the Static Group - Security by Group page (TL\_GRP\_SECURITY) to specify which row-security permission lists can view and edit time reporting data for this group of time reporters.

Navigation:

**Set Up HCM > Security > Time and Labor Security > Static Group > Security by Group**

This example illustrates the fields and controls on the Static Group – Security by Group page. You can find definitions for the fields and controls later on this page.



**Note:** The Security by Group page is not available if you select the **TL Approval Group** field on the Static Group - Selection Criteria page.

**Note:** You use the same Security by Group page to define security access to a static group and a dynamic group.

<b>Field or Control</b>	<b>Description</b>
<b>Row Security Permission List</b>	Select the row-security permission list to associate with this group. In doing so, you grant users who are associated with the row-security permission list the authorization to edit and view data for the time reporters in the group.
<b>Permission List Description</b>	The description of the row security permission list that you selected is displayed.

## Creating and Updating Dynamic Groups

To create or update dynamic groups, use the Dynamic Group (TL\_DYNAM\_GRP) and the Refresh Dynamic Group(s) (TL\_RUN\_GRP\_REFRESH) components. Use the TL\_DYNAM\_GRP component interface to load data into the tables for this component.

This section discusses how to create and update dynamic groups.

### Pages Used to Create and Update Dynamic Groups

<i>Page Name</i>	<i>Definition Name</i>	<i>Usage</i>
<a href="#">Dynamic Group - Selection Criteria Page</a>	TL_GROUP_D1	Define the criteria to select members of the group.
<a href="#">Dynamic Group - Potential Group Members Page</a>	TL_GROUP_D2	Preview the list of time reporters who currently meet the selection criteria for a dynamic group. Also, ensure that you've defined the correct selection criteria.
<a href="#">Static Group - Security by Group Page</a>	TL_GRP_SECURITY	Specify which row-security permission lists can view and edit time reporting data for this group of time reporters.
<a href="#">Dynamic Group - Current Group Members Page</a>	TL_GROUP_LIST	View the current members of a dynamic group. Refresh group membership.
<a href="#">Refresh Dynamic Groups Page</a>	TL_RUN_GRP_REFRESH	Refresh membership in multiple dynamic groups at once.

### Dynamic Group - Selection Criteria Page

Use the Dynamic Group - Selection Criteria page (TL\_GROUP\_D1) to define the criteria to select members of the group.

Navigation:

**Set Up HCM > Security > Time and Labor Security > Dynamic Group > Selection Criteria**

This example illustrates the fields and controls on the Dynamic Group - Selection Criteria page. You can find definitions for the fields and controls later on this page.

<b>Field or Control</b>	<b>Description</b>
<p><b>Taskgroup for Time Reporting</b></p>	<p>Select a task group for the system to apply when a user enters time for the members of this group on the Mass Time Reporting page. Use this feature when a group of time reporters is working on a temporary project or assignment.</p> <p>The task group in this field takes precedence over the task group assigned to time reporters on the Maintain Time Reporter Data page.</p>
<p><b>TL Approval Group</b></p>	<p>Select to indicate that this group is used for Time and Labor approvals. When you select the <b>TL Approval Group</b> field, the Security by Group Tab is not available for use. Approval groups cannot use row security permission lists.</p> <p>Approval groups define a list of approvers. Selecting this field enables you to use the group ID to set up approvals on the Workgroup or Time Reporting Code component when the Approval Definition ID is TLGroupMultiStageALL, TLGroupMultiStageSOME, or TLGroupSingleStageALL. You can also use an approval group to set up adhoc approval groups to filter available approvers designated as an ad hoc approver. Row security is not applicable to approval groups since they are not used to grant row security access.</p> <p>See <a href="#">Understanding the Approval Process in Time and Labor</a>.</p>

### Select Parameters

Use the fields in the **Select Parameters** grid to define the selection criteria for adding members to the group. For example, add only those people who work in a particular location or job. The system uses the criteria to generate the WHERE clause of the SQL select statement. A WHERE clause can contain up to 254 characters.



<b>Field or Control</b>	<b>Description</b>
*(	Select a bracket type. The system processes the statement in brackets before it processes the rest of the SQL WHERE clause. Select up to five open brackets ((((((.
<b>Record</b>	Select a record name. Only records with access given in the Group Creation Security page are available. This is the record from which to choose any field.
<b>Field Name</b>	Select a field name. Only fields with access given in the Group Creation Security pages are available. This field can now be defined with any valid value as part of your selection criteria.
<b>SetID</b>	<p>If you select <i>Job</i> in the <b>Record</b> field, and one of the following fields listed in the <b>Field Name</b> field, select the setID with which the field is associated. In all other cases, the <b>SetID</b> field is unavailable.</p> <p>SAL_ADMIN_PLAN</p> <p>GRADE</p> <p>STEP</p> <p>SALARY_MATRIX_CD</p> <p>DEPTID</p> <p>JOBCODE</p> <p>LOCATION</p>
<b>Operator</b>	If you want to perform a mathematical operation, select the appropriate symbol. Valid entries are: <, <=, <>, =, >, >=, and <i>LIKE</i> . If you select <i>LIKE</i> , you can enter a partial value in the <b>Value</b> field. For example, <i>S</i> .
<b>Value</b>	<p>Select a value for the field name.</p> <p>If you selected <i>LIKE</i> as the operator, do not enter quotation marks or the percent sign in the <b>Value</b> field.</p> <p>This field is case-sensitive. Enter the value exactly as defined when added to the database.</p> <p>If entering a date, be sure to enter the proper date format for your environment.</p>

<b>Field or Control</b>	<b>Description</b>
*)	Select the closing bracket type.
(unlabeled)	If you want to add another parameter to your selection criteria (the WHERE clause), select <i>AND</i> or <i>OR</i> .
<b>Create SQL</b>	Click the <b>Create SQL</b> button to update the SQL code that selects group members.
<b>View SQL</b>	Click the <b>View SQL</b> link to access the View SQL page, where you can see the SQL code generated by the WHERE clause.

### Related Links

[Understanding Task Reporting Requirements](#)

## Dynamic Group - Potential Group Members Page

Use the Dynamic Group - Potential Group Members page (TL\_GROUP\_D2) to preview the list of time reporters who currently meet the selection criteria for a dynamic group.

Also, ensure that you've defined the correct selection criteria.

Navigation:

**Set Up HCM > Security > Time and Labor Security > Dynamic Group > Potential Group Members**

This example illustrates the fields and controls on the Dynamic Group - Potential Group Members page. You can find definitions for the fields and controls later on this page.

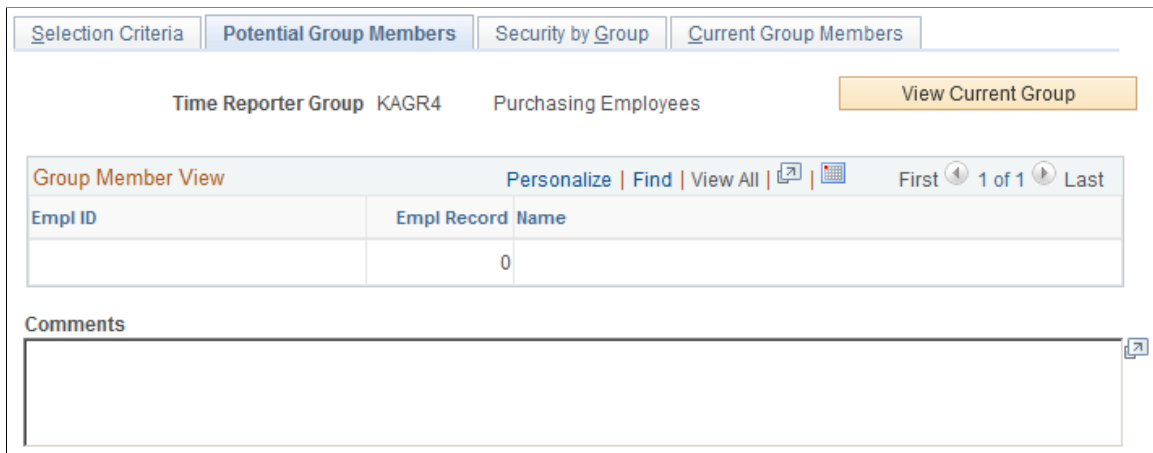

<b>Field or Control</b>	<b>Description</b>
<b>Sort By</b>	Select <i>EmplID</i> (employee ID) to sort time reporters by employee ID or select <i>Name</i> to sort alphabetically by last name.
<b>View Current Group</b>	Click to view a list of all time reporters who currently meet the selection criteria.

When you're ready to create and save the group, use the Current Group Members page or the Selection Criteria page.

## Static Group - Security by Group Page

Use the Static Group - Security by Group page (TL\_GRP\_SECURITY) to specify which row-security permission lists can view and edit time reporting data for this group of time reporters.

Navigation:

**Set Up HCM > Security > Time and Labor Security > Dynamic Group > Security by Group**

The Static Group - Security by Group page for dynamic groups is the same as the page for static groups.

### Related Links

[Static Group - Security by Group Page](#)

## Dynamic Group - Current Group Members Page

Use the Dynamic Group - Current Group Members page (TL\_GROUP\_LIST) to view the current members of a dynamic group and refresh group membership.

Navigation:

**Set Up HCM > Security > Time and Labor Security > Dynamic Group > Current Group Members**

This example illustrates the fields and controls on the Dynamic Group - Current Group Members page. You can find definitions for the fields and controls later on this page.



The refresh feature enables you to update membership in a dynamic group. When you start the process, the system removes time reporters who don't fit the group selection criteria and adds time reporters who do. Use the Refresh Dynamic Group feature before accessing any online page on which you access time reporters. This ensures an up-to-date group member list when the page is displayed. It's not necessary to refresh dynamic groups before batch processing. Time and Labor automatically refreshes group membership before processing time.

**Note:** The Security by Group page is not available if you select the **TL Approval Group** field on the Dynamic Group - Selection Criteria page.

Field or Control	Description
<b>As Of Date</b>	If you entered an as of date on the Refresh Dynamic Groups page when you last refreshed this group, that date appears here.
<b>Sort By</b>	Select <i>EmplID</i> (employee ID) to sort group members by employee ID or select <i>Name</i> to sort members alphabetically.
<b>Refresh Dynamic Group</b>	Click to refresh immediately. The system refreshes and displays the dynamic group membership.

## Refresh Dynamic Groups Page

Use the Refresh Dynamic Groups page (TL\_RUN\_GRP\_REFRESH) to refresh membership in multiple dynamic groups at once.

Navigation:

**Set Up HCM > Security > Time and Labor Security > Refresh Dynamic Group > Refresh Dynamic Group(s)**

The refresh process uses today's date or a specified as of date to determine which time reporters meet the group selection criteria.

<b>Field or Control</b>	<b>Description</b>
<b>Use Current Date</b>	Select for the system to retrieve all time reporters who meet the selection criteria today.
<b>As of Date</b>	<p>The <b>As of Date</b> field appears only if you clear the <b>Use Current Date</b> check box. Enter the date for which you want the group refreshed.</p> <p>Enter a previous date to refresh the population of a group or groups for a previous date.</p>



# Setting Up Time Reporters

---

## Understanding Time Reporter Data

Employees and non-employees do not automatically participate in the Time and Labor system when added to the Human Resources database. You must enroll, as a time reporter, each person for whom time will be reported or created. When enrolling a time reporter, specify how the person will report time and how the system will process that time. You must assign the following:

- A task group that identifies:
  - The default time reporting templates.
  - The task template.
  - The task profiles for time reporting.
- A workgroup that defines:
  - The type of reporting (exception or positive).
  - The rule program.
  - The time reporting code (TRC) program.
  - The default time period.
  - Schedules.
  - Rounding rules.
  - Day-breaker options.
  - The compensatory time plan assigned to the time reporter.

In addition, you can:

- Assign a time collection device (TCD) group that identifies the TCDs that the time reporter can use.
- Assign a restriction profile ID that identifies which TCD punches are acceptable.
- Select a time reporter's time zone if it is different from the base time zone.
- Enter up to five rule elements to associate with the time reporter.
- Select a specific task profile, time reporting templates, and time period ID that take precedence over those associated with the time reporter's default task group and workgroup.

---

**Note:** A time reporter is any employee or non-employee whose time is reported or generated through Time and Labor

---

## Preventing Inactivation or Deletion of Effective-Dated Rows

The system disallows the inactivation or deletion of effective-dated rows on the Maintain Time Reporter Data page under the following conditions:

- A time reporter can be inactivated as long as there is no time reported in *Approved Status* and when payable time is not in *Approved*, *Taken by Payroll*, *Sent to Payroll*, *Rejected by Payroll*, *Paid*, *Diluted*, *Closed*, or *No Pay* that is the same or after the effective date.
- If the Default from Workgroup check box on the Time and Labor Installation page is cleared.

You cannot delete an effective-dated row that invalidates a compensatory time plan association on the Comp Plan Enrollment page. You must inactivate the compensatory time off plan associated with the time reporter on the Comp Plan Enrollment page before you delete the row on the Maintain Time Reporter Data page.

---

**Note:** If the Default from Workgroup check box is selected, you can delete a row on the Maintain Time Reporter Data page.

---



---

**Note:** Time that is reported for an inactive time reporter through Rapid, Mass or TCD creates high severity exceptions that the time reporter is inactive (for elapsed or punch time). The reported time is still populated for those days that the Mass Time, Rapid Time or TCD interface is submitted. The manager is able to delete the reported time using the Timesheet pages.

---



---

**Note:** If you terminate an employee in the Job Data pages without inactivating the employee on the Maintain Time Reporter Data page, the employee may still be able to enter time on the Timesheet pages.

---

## Execute Edit Error Checking

On the Create/Maintain Time Reporter Data page, you cannot change the minimum effective date to a date less than the minimum effective date of the following fields:

- Workgroup
- Taskgroup
- TCD Group
- Rule Element 1
- Rule Element 2
- Rule Element 3
- Rule Element 4
- Rule Element 5



## Nested Effective Dates

You cannot change the effective date of the following prompt tables to be greater than the effective date of the Create/Maintain TR Data target table:

- Workgroup
- TCD Group
- Taskgroup
- Rule Element 1
- Rule Element 2
- Rule Element 3
- Rule Element 4
- Rule Element 5

## Compensation Plans

There are two ways to enroll time reporters into the compensatory time plans in Time and Labor. You choose a method on the TL Installation page:

- Select the Default from Workgroup check box.

Time and Labor assigns time reporters to the compensatory time plan linked to their workgroup. The compensatory time plan and its status appear on the Comp Plan Enrollment page; however, you cannot make changes on this page. If you change the compensatory time plan associated with the time reporter's workgroup or assign the time reporter to a different workgroup (through the Maintain Time Reporter Data page), resulting in a new compensatory time plan assignment, the system updates the Comp Plan Enrollment page.

- Clear the Default from Workgroup check box on the TL Installation page and assign a time reporter directly to one or more compensatory time plans using the Comp Plan Enrollment page.

View active and inactive compensatory time plans for a time reporter on the View Comp Plans pages.

---

**Note:** Enrollment records are not affected if you clear the Default from Workgroup check box after compensatory time plans are assigned to time reporters. However, you will gain the ability to edit the Comp Plan Enrollment page.

---

## Schedules

All time reporters have a schedule assignment that is either the workgroup default schedule or a custom schedule. When a person is hired, they use the workgroup default schedule.

For a time reporter to have a custom schedule assignment, there are two ways to change the assignment:

- Assign a custom schedule on the Assign Schedules page.

You can also designate that the system should use the time reporter's workgroup default schedule. Depending on your access security, you can view a time reporter's schedule history on this page.

- Use the Group Schedule Assignment process.

You can assign a schedule to multiple time reporters simultaneously, to a static or dynamic group, or to selection of individual time reporters (solely for the purpose of assigning the same schedule.) After running the Group Schedule Assignment process, view the time reporters' new schedule assignment using the Assign Schedules page.

When you assign a schedule to a time reporter, the system deletes workday overrides that:

- Are of different types than the schedule assignment (for example, elapsed instead of punch).
- Have a date greater than or equal to the new assignment.

This is to retain the data integrity of the work schedule.

New schedule assignments trigger the Referential Integrity process. Reported or payable time with a date greater than or equal to the date of the new assignment is reevaluated by Time Administration. This is to make corrections where necessary:

- Due to payable time being created from scheduled time.
- Where rules are run against scheduled time.

Time reporters with multiple jobs can have a schedule assignment for each job. However, check the assignments to verify that you are not scheduling the time reporter to concurrent hours. The system does not check for overlapping hours from multiple schedule assignments.

To assign a schedule to a group of time reporters, most of whom are in a static or dynamic group, select that group ID and then selectively exclude time reporters to whom the schedule assignment does not apply. You can also selectively include time reporters who share the same schedule assignment, but do not belong to the group ID. If the group of time reporters sharing the schedule assignment have nothing in common, select them individually by employee ID.

---

**Note:** To assign schedules, the Workforce\_Sync Message must be active on the PERSON\_DATA queue, which is delivered with PeopleSoft Integration Broker. This message inserts a row into the SCH\_ASSIGN record when an employee is hired.

---

See the product documentation for *PeopleTools Integration Broker Testing*

## Related Links

[Understanding Work Schedules](#)

---

## Entering and Maintaining Time Reporter Data

To enter and maintain time reporter data, use the Create Time Reporter Data (TL\_EMPL\_DATA\_C) and Maintain Time Reporter Data (TL\_EMPL\_DATA\_M) components.

This section discusses how to enter and maintain time reporter data.

## Pages Used to Enter and Maintain Time Reporter Data

<i>Page Name</i>	<i>Definition Name</i>	<i>Usage</i>
<u>Create Time Reporter Data Page</u>	TL_EMPL_DATA1	Enroll a time reporter into the Time and Labor system.  The <b>Time Reporter Data</b> link appears on pages in the Human Resources Workforce menu only if you've selected Time and Labor on the General Installation Table.
Time Reporter - Badge Detail Page	TL_BADGE_SEC	Display badge information for a time reporter.
<u>Maintain Time Reporter Data Page</u>	TL_EMPL_DATA1	Update enrollment information for time reporters in Time and Labor.  The <b>Time Reporter Data</b> link appears on pages in the Human Resources Workforce menu only if you've selected Time and Labor on the General Installation Table.
<u>Time Reporter Group Membership Page</u>	TL_GRP_MEMBERSHIP	To view the list of groups that the time reporter is assigned to.

---

**Note:** Pages for creating and maintaining time reporter data have been replaced by the Create Time Reporter Data page and Manage Time Reporter Data page respectively in Fluid. For more information, see [Managing Time Enrollments Using Fluid](#).

---

### Create Time Reporter Data Page

Use the Create Time Reporter Data page (TL\_EMPL\_DATA1) to enroll a time reporter into the Time and Labor system.

Navigation:

- **Time and Labor > Enroll Time Reporters > Create Time Reporter Data > Create Time Reporter Data**
- Click the **Time Reporter Data** link on various pages accessible on the Workforce Administration menu.

This example illustrates the fields and controls on the Create Time Reporter Data page. You can find definitions for the fields and controls later on this page.

### Create Time Reporter Data

**Laura Jones**
ID K0W005
Employment Record 0

Organizational Relationship Employee
Badge Detail

Payable Time Start Date

---

**Time Reporter Data**
Find | View All
First 1 of 1 Last

\*Effective Date

\*Time Reporter Type

Elapsed Time Template  ETime Rptg Template/Profile

Punch Time Template

Time Period ID  Weekly Period - PS Delivered

\*Workgroup  Exception Time Rptg/Flex Sched

\*Taskgroup  Project Data with Charfields

Task Profile ID

TCD Group

Restriction Profile ID

Rule Element 1

Rule Element 2

Rule Element 3

Rule Element 4

Rule Element 5

Time Zone  Pacific Time (US)

\*Status

---

Payroll

Send Time to Payroll

---

Commitment Accounting

For Taskgroup

For Department

**Note:** Use the Maintain Time Reporter Data page to make changes to data entered on the Create Time Reporter Data page.

**Note:** As the Person Type and Personnel Status fields no longer exist in the database, the fields for the organizational relationship are displayed. These fields include **Employee, Contingent Worker and Person of Interest.**

<b>Field or Control</b>	<b>Description</b>
	Click for the system to refresh the fields in the Commitment Accounting Flags group box.
<b>Badge Detail</b>	Click to access the Time Reporter - Badge Detail page and view the badge information for this time reporter. You enter badge information in Workforce Administration as a part of the hiring or data maintenance process for time reporters.  Badge information is important for punch time reporters, who need this information to report time to the TCD.

<b>Field or Control</b>	<b>Description</b>
<b>Payable Time Start Date</b>	<p>Enter the date for the system to start creating payable time for the time reporter. This date is important for time reporters in a workgroup defined for exception time reporting who will have payable time created from schedules.</p> <p>The date you enter in this field updates the Earliest Change Date (EARLIEST_CHGDT) field on the time reporter's TL_TR_STATUS record. This is the date that the Time Administration process uses to determine the initial creation of payable time.</p> <p>For example, if you enroll your time reporter with an effective date of 01/01/2000, but you don't want the system to start creating payable time for the time reporter until 02/01/2000, enter <i>02/01/2000</i> in this field.</p> <p>If you do not select a date, the first time you run the Time Administration process for the exception time reporter, the process creates payable time as of the Time and Labor enrollment date (the first effective date for the time reporter).</p> <p>The payable start date cannot be earlier than the date that the time reporter is enrolled in Time and Labor.</p> <hr/> <p><b>Note:</b> The <i>Payable Start Date</i> field does not appear on the Maintain Time Reporter Data page because it is used once. If you change the first effective date for the time reporter on the Maintain Time Reporter Data page, the Referential Integrity process triggers the update of the Earliest Change Date field.</p>
<b>Effective Date</b>	The effective date must be the same as or after the hire date or, for non-employees, the add date.
<b>Status</b>	When you enroll a time reporter, the time reporting status is <i>Active</i> by default. Time can be reported and generated for the time reporter.
<b>Send Time to Payroll</b>	<p>Select this check box to integrate Time and Labor with, and send this time reporter's payable time to, a payroll system.</p> <p>If cleared, the Time Administration process converts the time reporter's reported time to payable time and sets the payable time reason code to Not Sent to Payroll (NSP).</p> <p>If selected, and the time reporter's workgroup or the TRC that is used to report time does not need approval, reported time is converted to payable time with a status code of <i>Closed</i>.</p> <p>See <a href="#">Setting Up System Defaults and Loading Dates and Payable Time Status and Reason Codes</a></p>

## Time Reporter Type

Time reporter type identifies how the time reporter will enter time. It does not affect the assignment of schedules. For example, you can assign a punch schedule to a time reporter designated as an elapsed time reporter.

<i>Field or Control</i>	<i>Description</i>
<b>Elapsed</b>	Select if your time reporter will be reporting time in hours or partial hours.
<b>Punch</b>	Select if your time reporter will be reporting start and stop times in precise entries of date and time, recorded in seconds, minutes, hours, day, month, year, and time zone.

## Time Reporting Template

Time reporting templates define the types of information time reporters supply when reporting time. If you leave the **Elapsed** and **Punch** fields cleared, the system uses the time reporting templates assigned to the time reporter's task group.

<i>Field or Control</i>	<i>Description</i>
<b>Elapsed Time Template</b>	Select the elapsed time reporting template to use for this time reporter, if different from the one assigned to the time reporter's task group.
<b>Punch Time Template</b>	Select the punch time reporting template to use for this time reporter, if different from the one assigned to the time reporter's task group.

For more information on reporting templates, see: [Creating Time Reporting Templates](#)

## Commitment Accounting Flags

These check boxes are display-only and are applicable when you integrate PeopleSoft's commitment accounting functionality with task reporting.

<i>Field or Control</i>	<i>Description</i>
<b>For Taskgroup</b>	Selected automatically if the task group for the time reporter (in the <b>Taskgroup</b> field) is defined for commitment accounting.

<b>Field or Control</b>	<b>Description</b>
<b>For Department</b>	<p>Selected automatically if the time reporter's department is defined for commitment accounting in People Soft Human Resources. When the <b>For Department</b> check box is selected, assign the task reporter a task group that is also defined for commitment accounting.</p> <p>Both flags must be selected or cleared before you can save the Create Time Reporter Data page.</p> <hr/> <p><b>Note:</b> If you change the effective date or the task group on this page, click the button to the right of either field to refresh the commitment accounting flags.</p> <hr/>

**Additional Elements**

<b>Field or Control</b>	<b>Description</b>
<b>Time Period ID</b>	<p>The system uses time periods to differentiate between reported time that falls within the current period and time that falls within a prior period.</p> <p>Select a time period ID only if you want the system to use a different time period ID than that assigned to the time reporter's workgroup.</p>
<b>Workgroup</b>	<p>Select a workgroup for the time reporter. Workgroup is a required field. It identifies the default TRC program, rule program, holiday schedule, time reporting period, and other information that the system uses when processing reported time for this person.</p> <p>If you change the workgroup, and the Assign Workgroup Schedule field is set to <i>Yes</i> on the time reporter's Assign Schedules page, the system deletes any workday overrides for the time reporter that are of a different type than the assigned schedule (that is, elapsed versus punch).</p> <p>If you change the workgroup when the Default from Workgroup check box is selected on the TL Installation page, the system updates compensatory time plan enrollment when there is a change in a compensatory time plan. The dormant compensatory time plan is inactivated and the new compensatory time plan becomes active as of the effective-dated change of the workgroup on the Maintain Time Reporter Data page.</p>

<b>Field or Control</b>	<b>Description</b>
<b>Taskgroup</b>	<p>A required field. It identifies the default task template, task profile, and time reporting templates that the system uses when collecting and processing reported time for this time reporter.</p> <p>If the time reporter's department is set up for commitment accounting (the <b>For Department</b> check box under <b>Commitment Accounting Flags</b> is selected), you must assign a task group that's defined for commitment accounting. When you do so, the system selects the <b>For Taskgroup</b> check box.</p> <p>Choose <i>PSNONTASK</i> if this time reporter will never be reporting task information. Choose <i>PSNONCATSK</i> for time reporters not reporting task information in a Commitment Accounting Department. (The system can still collect all the time reporting elements such as country, state, locality, badge ID, and time zone.)</p>
<b>Task Profile ID</b>	<p>Select a task profile ID for the system to use a different default task profile ID than that assigned to the time reporter's task group. Task profiles define the tasks to which a person's reported time is allocated automatically if task information is not reported.</p>
<b>TCD Group</b> (time collection device group)	<p>If the time reporter uses a TCD, such as a time clock or badge scanner to report time, select the appropriate TCD group. The TCD group identifies the TCDs that the time reporter is authorized to use.</p> <hr/> <p><b>Note:</b> When you set up a TCD, you associate it with one or more task groups. Select one of the task groups that is associated with the TCD as the time reporter's default task group in the <b>Taskgroup</b> field. If your default task group is not associated with a TCD in your TCD group, you receive a warning message when saving the page. In addition, all reported task information is associated with a borrowed task group.</p> <hr/>
<b>Restriction Profile ID</b>	<p>This field applies only if the time reporter uses a time clock device to report time. A restriction profile identifies when to allow or disallow punches in conjunction with the time reporter's schedule.</p> <p>Select a restriction profile ID in this field to apply a different restriction profile than that assigned to the time reporter's TCD group.</p>



<b>Field or Control</b>	<b>Description</b>
<b>Rule Elements 1-5</b>	Assign up to five rule elements to a time reporter. When you run the Time Administration process, the system retrieves the values of the time reporter's rule elements and makes the values available for rules processing. This feature enables you to tailor rules to a specific population of time reporters.
<b>Time Zone</b>	Select the time zone in which the time reporter enters time.  The system automatically populates the field with the base time zone defined with PeopleTools Utilities.

### **Related Links**

[Creating Task Profiles](#)

[Time Zone Offsets Table](#)

[Defining Rule Elements](#)

[Understanding Workgroups](#)

[Understanding Time Reporting](#)

[Understanding Payable Time](#)

[Understanding the Time Administration Process Flow](#)

[Understanding TCDs](#)

“Understanding the Commitment Accounting Business Process” (PeopleSoft Human Resources Manage Commitment Accounting)

## **Maintain Time Reporter Data Page**

Use the Maintain Time Reporter Data page (TL\_EMPL\_DATA1) to update enrollment information for time reporters in Time and Labor.

Navigation:

- **Time and Labor > Enrollment Time Reporters > Maintain Time Reporter Data > Maintain Time Reporter Data**
- Click the **Time Reporter Data** link on various pages accessible on the Workforce Administration menu.

This example illustrates the fields and controls on the Maintain Time Reporter Data page. You can find definitions for the fields and controls later on this page.

### Maintain Time Reporter Data

**Laura Jones**

Organizational Relationship Employee

ID K0W005

Badge Detail

Employment Record 0

Group Membership

**Time Reporter Data** Find | View All First 1 of 1 Last

\*Effective Date  B ↻

\*Time Reporter Type

Elapsed Time Template  🔍 ETime Rptg Template/Profile

Punch Time Template  🔍

Time Period ID  🔍 Weekly Period - PS Delivered

\*Workgroup  🔍 Exception Time Rptg/Flex Sched

\*Taskgroup  🔍 ↻ Project Data with Charfields

Task Profile ID  🔍

TCD Group  🔍

Restriction Profile ID  🔍

Rule Element 1  🔍

Rule Element 2  🔍

Rule Element 3  🔍

Rule Element 4  🔍

Rule Element 5  🔍

Time Zone  🔍 Pacific Time (US)

\*Status  + -

Payroll

Send Time to Payroll

Commitment Accounting

For Taskgroup

For Department

<b>Field or Control</b>	<b>Description</b>
<b>Group Membership</b>	Click to access the Time Reporter Group Membership page, where you can see the list of groups in which the time reporter is currently enrolled.

Most of the elements on the Maintain Time Reporter Data page are identical to those on the Create Time Reporter Data page. Descriptions are provided for changes to elements that trigger referential integrity and that affect the system generally.

The Earliest Change Date (ECD) will be reset to the effective date upon rehiring or when reactivating a time reporter. ECD will not be reset if there are previous pending rows to be processed.

314

Copyright © 1988, 2024, Oracle and/or its affiliates.

## Changes That Affect the System

<b>Field or Control</b>	<b>Description</b>
<b>Time Reporter Status</b>	<p>If you change a time reporter's status to <i>Inactive</i>, time cannot be reported or generated for the time reporter.</p> <p>Updating a person's status in Human Resources has no effect on the time reporter status. If a time reporter is terminated, update the employee status through Human Resources and then process any reported time for which the time reporter has not been paid. After the time is processed, change the time reporter status to <i>Inactive</i> on the Maintain Time Reporter Data page to prevent additional time from being reported or generated.</p>
<b>Send Time to Payroll</b>	<p>Changing the Send Time to Payroll check box after payable time has been created for this time reporter may impact the payable time. See "Impact of Changing the Send Time to Payroll Check Box" for details.</p>
<b>Workgroup</b>	<p>If you change the workgroup value assigned to the time reporter, the next time you run the Time Administration process, the system will verify that the TRCs associated with the reported time belong to the TRC program associated with the new workgroup for the date reported.</p> <hr/> <p><b>Note:</b> Limit changes in workgroup assignments to the start date of a new period. Changes made in the middle of a period may cause weekly or biweekly rules associated with a time reporter to produce unpredictable results.</p> <hr/>
<b>Taskgroup</b>	<p>If you change the task group value assigned to the time reporter, the next time you run the Time Administration process, Referential Integrity validates that any task entities reported on or after the change date are associated with the new task group.</p> <hr/> <p><b>Note:</b> If you change the task group after you report and submit time (through the Rapid Time Reporting page, Mass Time pages, or TCD interface) during the period of the change, you must update the task group in the weekly reporting pages to reflect the change.</p> <hr/>

<b>Field or Control</b>	<b>Description</b>
<b>Task Profile ID</b>	If you change the task profile ID assigned to the time reporter, the next time you run the Time Administration process, the system verifies that the task profile reported through the weekly elapsed time page is associated with the employee's default task group as of the date reported.
<b>TCD Group</b> (time collection device group)	If you change the TCD group assigned to the time reporter, use the TCD interface to resend the employee information setup data to the time collection devices.
<b>Restriction Profile</b>	If you change the restriction profile ID assigned to the time reporter, use the TCD interface to resend the employee information setup data to the time collection devices.

### Changes That Trigger Referential Integrity

Updates to the **Workgroup**, **Taskgroup**, **Task Profile ID**, and **Rule Element** fields trigger a referential integrity check when you run the Time Administration process. Referential Integrity triggers the Time Validation process, which reevaluates reported or payable time that may be invalidated by a change in workgroup, task group or task profile ID. Exceptions are generated for invalid time.

### Impact of Changing the Send Time to Payroll Check Box

<b>Payable Status of Payable Time</b>	<b>Impact of Clearing the Send Time to Payroll Check Box</b>	<b>Impact of Selecting the Send Time to Payroll Check Box</b>
<i>Estimated</i>	Time remains in <i>Estimated</i> status. It is not picked up by a payroll system, set to <i>Closed</i> status, or published to Project Costing.  Use SQL to change the payable status to Needs Approval (NA).	Not applicable.
<i>Needs Approval</i>	Payable status is set to <i>Closed</i> or <i>No Pay</i> during online or batch approval.	Payable status is be set to <i>Approved – Goes to Payroll</i> when time is approved to be picked up by a payroll system.
<i>Approved – Goes to Payroll</i>	The payable status is not set to <i>Closed</i> nor is the time published to Project Costing. Use SQL to change the payable status and publish the time to Project Costing.	Not applicable.

<b>Payable Status of Payable Time</b>	<b>Impact of Clearing the Send Time to Payroll Check Box</b>	<b>Impact of Selecting the Send Time to Payroll Check Box</b>
<i>Closed or No Pay</i>	Time remains in <i>Closed</i> or <i>No Pay</i> status. If the time has been closed as a result of being paid but not labor-distributed, make desired adjustments within your payroll system. Make a record-only adjustment in Time and Labor to keep the data in both applications synchronized.	The Time Administration process does not set the payable status to <i>Approved – Goes to Payroll</i> , therefore the time cannot be sent to a payroll system. Use SQL to change the status to <i>Approved – Goes to Payroll</i> .  If you change the status to <i>Approved – Goes to Payroll</i> , and the time is picked up by a payroll system, it can be published to Project Costing a second time. If there's a difference between the original estimated gross amount and the new amount, only the difference is published.
<i>Rejected by Payroll</i>	Time Administration does not set the payable status to <i>Closed</i> ; therefore, another payroll system can retrieve the time. Use SQL to set the status to <i>Closed</i> .	Not applicable.
<i>Sent to Payroll</i> <i>Taken – Used by Payroll</i> <i>Paid – Labor Distributed</i> <i>Paid – Labor Diluted</i> <i>No Pay</i> <i>Ignore</i>	Time has already been accepted by your payroll system; however, if payment has not been issued and you need to make adjustments, enter adjustments through your payroll system. Be sure to make record-only adjustments in Time and Labor to keep the date in both applications synchronized.	Not applicable.

## Related Links

[Time Administration and Referential Integrity](#)

[Sending Setup Data to a TCD](#)

[Understanding Payable Time](#)

[Making Workgroup Transfers](#)

## Time Reporter Group Membership Page

Use the Time Reporter Group Membership page (TL\_GRP\_MEMBERSHIP) to view the list of groups that the time reporter is assigned to.

Navigation:

Click the **Group Membership** link on the Maintain Time Reporter Data page.

This example illustrates the fields and controls on the Time Reporter Group Membership page. You can find definitions for the fields and controls later on this page.

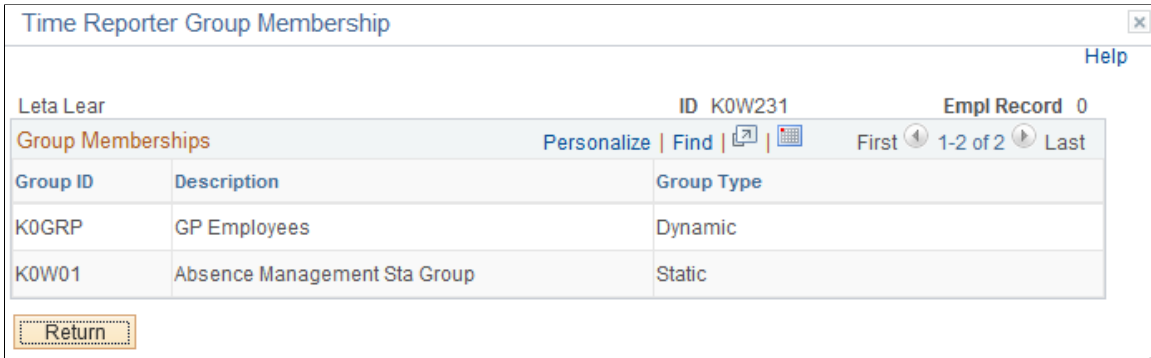

Field or Control	Description
Group Type	<p>The group type can be either <i>Dynamic</i> or <i>Static</i>.</p> <p>Dynamic groups comprise time reporters who met the group selection criteria at the time you last refreshed the dynamic group. Time reporters are automatically added and removed from dynamic groups as their ability to match the selection criteria changes.</p> <p>Static groups comprise time reporters who met a specific set of criteria at the time the group was established. Time reporters stay assigned to a static group unless you remove them.</p>

**Related Links**

[Understanding Static and Dynamic Groups](#)

---

## Assigning and Viewing Compensatory Time Plans

This section discusses how to assign and view Compensatory Time Plans.

### Pages Used to Assign and View Compensatory Time Plans

Page Name	Definition Name	Usage
<a href="#">Compensatory Plan Enrollment Page</a>	TL_EMPL_COMP	<ul style="list-style-type: none"> <li>To enroll a time reporter in one or more compensatory plans.</li> <li>View compensatory time plans that have the same effective date.</li> </ul>

<b>Page Name</b>	<b>Definition Name</b>	<b>Usage</b>
<u>Comp Plan History Page</u>	TL_TR_COMP_PLAN_VW	View the history of compensatory time plan assignments for a specific time reporter.

## Compensatory Plan Enrollment Page

Use the Compensatory Plan Enrollment page (TL\_EMPL\_COMP) to enroll a time reporter in one or more compensatory plans and view compensatory time plans that have the same effective date..

Navigation:

**Time and Labor > Enroll Time Reporters > Compensatory Plan Enrollment > Compensatory Plan Enrollment**

This example illustrates the fields and controls on the Compensatory Plan Enrollment page. You can find definitions for the fields and controls later on this page.

<b>Field or Control</b>	<b>Description</b>
<b>Effective Date</b>	If the compensatory time plan was assigned to the time reporter's workgroup, the date that the workgroup was assigned to the time reporter appears in this field. If you subsequently change the plan assigned to the workgroup, or change the time reporter's workgroup assignment, the field reflects the date on which the new plan takes effect.
<b>Compensatory Time Off Plan</b>	Select the compensatory time plan to assign to the time reporter. You can assign more than one compensatory time plan to a time reporter if the plans do not share any of the same compensatory time TRCs (TRCs that have the Effect on Comp/Leave option set to CT Earned or CT Taken.)  This field is unavailable if the Default from Workgroup check box is selected on TL Installation page. In this case, the following message appears at the bottom of the page: "Comp Plan Entry Defaults from Time Reporter's Workgroup and cannot be changed or added".

<b>Field or Control</b>	<b>Description</b>
<b>Status</b>	<p>Indicates if the time reporter is currently associated with the compensatory time plan. Valid values are <i>Active</i> and <i>Inactive</i>.</p> <p>The system changes the status to <i>Inactive</i> if the compensatory time plan associated with the task reporter's workgroup changes to inactive. The system also changes the status to <i>Inactive</i> if the time reporter's workgroup assignment is changed on the Maintain Time Reporter Data page and the change results in a different compensatory time plan for the time reporter.</p>

## Comp Plan History Page

Use the Comp Plan History (compensatory plan history) page (TL\_TR\_COMP\_PLAN\_VW) to view the history of compensatory time plan assignments for a specific time reporter.

Navigation:

**Time and Labor > Enroll Time Reporters > Comp Plan History > Comp Plan History**

This example illustrates the fields and controls on the Comp Plan History page. You can find definitions for the fields and controls later on this page.

<b>Comp Plan History</b>			
<b>Christelle Stevenson</b>		<b>Empl ID</b> KU0020	<b>Empl Record</b> 0
<b>Comp Time Off Plan Participation</b>			
<b>Effective Date</b>	<b>Status</b>	<b>Compensatory Time Off Plan</b>	<b>Description</b>
09/01/2011	Active	KUCTOP1	No Limit Pos/Never Expire
09/25/1982	Active	KUCTOP2	Allow Negative Hours/Expire

If a time reporter switches compensatory time plans, the change is represented by three rows of data:

- A row for the original plan, with a status of *Active*.
- A row for the original plan, with a status of *Inactive*.
- A row for the new plan, with a status of *Active*.

---

## Assigning Schedules to a Group

This section discusses how to assign group schedules.



## Pages Used to Assign Schedules

<i>Page Name</i>	<i>Definition Name</i>	<i>Usage</i>
<u>Assign Schedule to a Group Page</u>	SCH_GRP_ASSIGN	Assign a group of time reporters or a single time reporter to a schedule.

### Assign Schedule to a Group Page

Use the Assign Schedule to Group page (SCH\_GRP\_ASSIGN) to assign a group of time reporters or a single time reporter to a schedule.

Navigation:

- **Set Up HCM > Product Related > Time and Labor > Schedule Configurations > Assign Schedule to Group > Assign Schedule to Group**
- **Time and Labor > Enroll Time Reporters > Assign Schedule to Group > Assign Schedule to Group**

This example illustrates the fields and controls on the Assign Schedule to Group page. You can find definitions for the fields and controls later on this page.

<i>Field or Control</i>	<i>Description</i>
Schedule Group	Select the schedule group you require.
<b>Schedule ID</b>	Select the schedule that you are assigning. The system only displays related values based on the Schedule Group selected.
Rotation ID	If you select a rotating schedule, as well as assigning the Schedule ID, you also need to assign a Rotation ID.
<b>EmplID</b> (employee ID)	Select the time reporter to include or exclude from this group schedule assignment.

<b>Field or Control</b>	<b>Description</b>
<b>Empl Rcd Nbr</b> (employee record number)	Select the appropriate value for this time reporter.
<b>Group ID</b>	Select the dynamic or static group for which you want to assign a schedule.
<b>Include/Exclude Indicator</b>	Select whether to include or exclude the time reporter indicated in this row. If you create a row to exclude a time reporter and then enter a row with the group that includes that time reporter, the time reporter is excluded from the group schedule assignment. The order in which you add rows does not affect the result.

### **Related Links**

[Creating Work Schedules and Schedule Definitions](#)

[Assigning Schedules](#)

# Time and Labor Support for Affordable Care Act

---

## Understanding the Time and Labor Functionality Supporting Affordable Care Act

The PeopleSoft Human Resource Time and Labor support for ACA (Affordable Care Act) functionality assists you to determine if the employee is eligible for benefits under the Affordable Care Act. The functionality assists in the accumulation of service hours for all employee types that are salaried, hourly, and exception hourly employees. This accumulation process relies on the ACA Time Reporting Codes table to determine which TRCs to include in accumulating the hours as service hours.

The materialized views are used in the accumulation of service hours. It is a virtual table that contains the summarized data from a SQL statement. The materialized view stays static until you refresh it. These views calculate average hours for all employees of the Employee statuses (EMPL\_STATUS) which include Active, Leave with Pay, Retired with Pay, and Terminated with Pay.

The ACA Eligibility Load Queries are used to retrieve data from the materialized views along with other HR Core tables, and output the results. You can download the results to an Excel spreadsheet. The system also enables you to track payable hours which are counted for service hours under Affordable Care Act and provide analytics by calendar week or month.

The section provides an overview of the following features that is required in PeopleSoft Time and Labor to support the Affordable Care Act (ACA) requirements.

- Setting Up ACA Time Reporting Codes.
- Creating and refreshing ACA materialized views.
- Generating Reports for the Analysis of data and the determination of the eligibility status.
- Running the ACA Eligibility Load query.

---

## Using PeopleSoft Time and Labor for Affordable Care Act

PeopleSoft Time and Labor allows you to track payable hours that are counted for ACA service hours. The enhancements also provide ACA analytical reports that assist in monitoring the hours of the employees. For implementing Affordable Care Act, once the configuration is complete you can start the eligibility process. There are two variations of the process, one for new hires and one for ongoing employees.

You need to decide whether a rehire to treat like a new hire or like an ongoing employee and populate their ACA Employee Eligibility record accordingly.

The following architecture diagram represents the process flow for new hires employees.

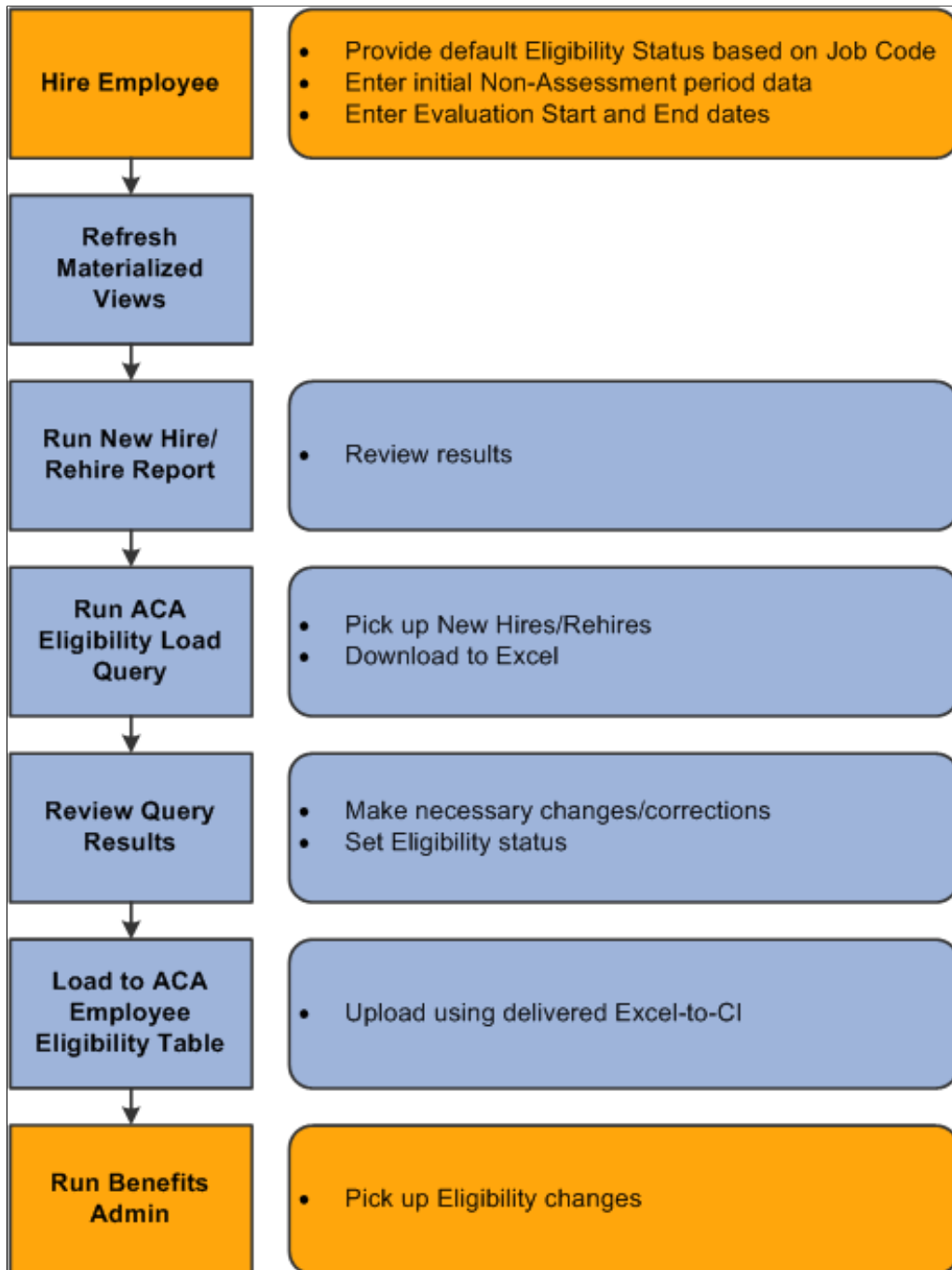

The following architecture diagram represents the process flow for ongoing employees.

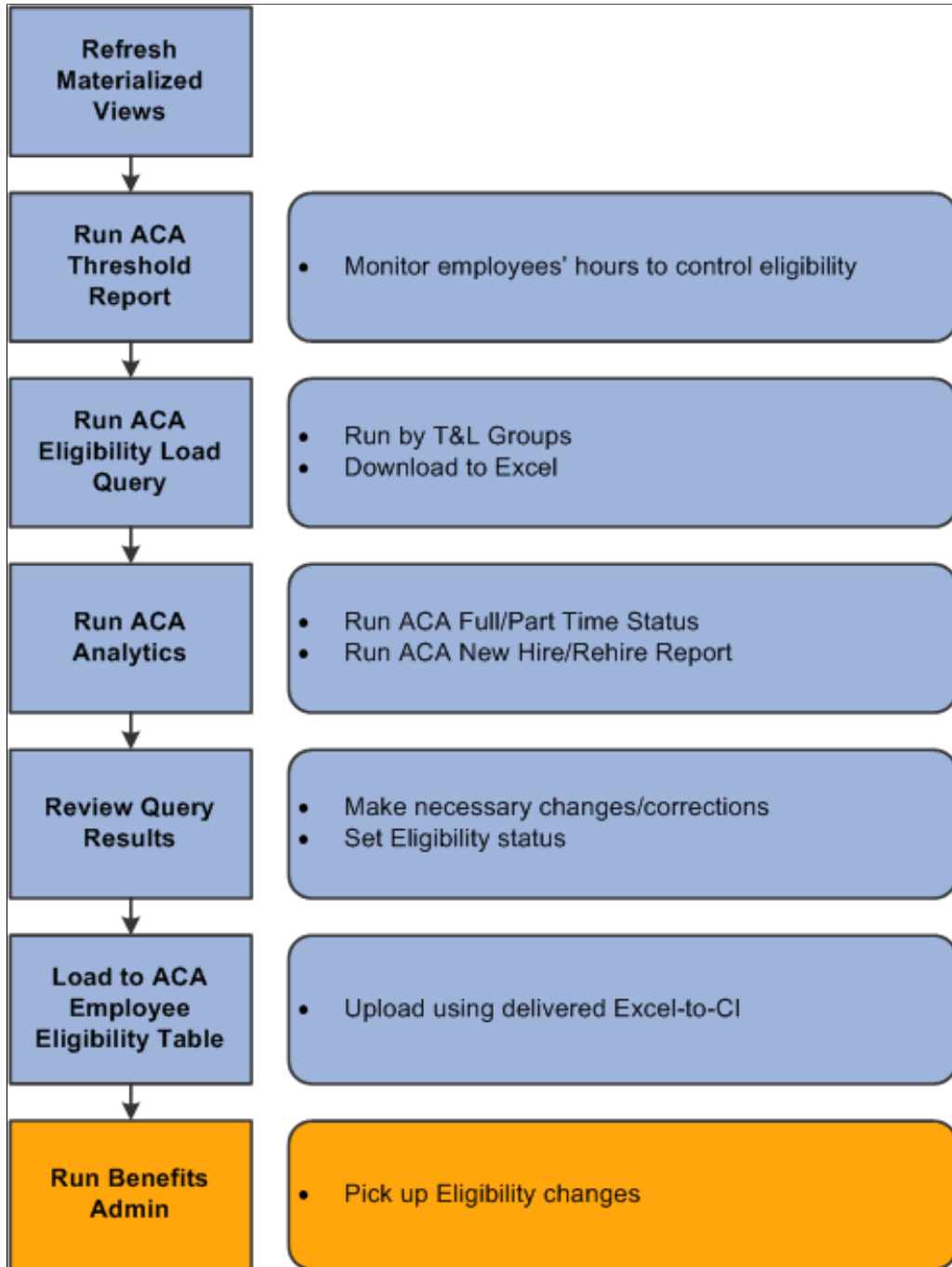

## Setting Up ACA Time Reporting Codes

The employer can use the Time Reporting Codes table to capture the Time Reporting Codes (TRCs) to be used to calculate the average service hours. Enter the following data in the table:

- Workgroup
- Effective Date

and

- Time Reporting Codes.

## Pages Used to Set Up ACA Time Reporting Codes

<i>Page Name</i>	<i>Definition Name</i>	<i>Usage</i>
<u>ACA Time Reporting Codes Page</u>	ACA_TL_TBL	Define the TRCs for workgroups within the employee population subject to the ACA.
<u>Time and Labor Groups Page</u>	TL_GROUP_D1	Define the criteria to select the members of the group.

### ACA Time Reporting Codes Page

Use the ACA Time Reporting Codes page (ACA\_TL\_TBL) to define the Time Reporting Codes (TRCs) that are used to calculate the average number of hours for ACA eligibility.

Navigation:

**Set Up HCM > Common Definitions > Affordable Care Act > ACA TRC Table**

This example illustrates the fields and controls on the ACA Time Recording Codes Page. You can find definitions for the fields and controls later on this page.



<b>Field or Control</b>	<b>Description</b>
<b>Workgroup</b>	Specify a workgroup that the employee population uses which is subject to the ACA regulations.  You need to define TRCs for all applicable workgroups.
<b>Effective Date</b>	The effective date of the defined group of TRCs.
<b>Time Reporting Code</b>	Specify all of the TRCs for calculating ACA eligibility for employees belonging to the workgroup.

## Time and Labor Groups Page

Use the Time and Labor Groups (TL\_GROUP\_D1) page to segregate your employee categories to which different measurement and stability periods are applied.

**Note:** Both static and dynamic groups have to be set up according to the need. This page description explains how to set up the dynamic groups.

Navigation:

**Set Up HCM > Security > Time and Labor Security > Dynamic Group**

This example illustrates the fields and controls on the Dynamic Group - Selection Criteria page.

*Operand	{	*Record	*Field Name	Set ID	*Operator	Field Value	}
		JOB	FULL_PART_TIME		=	P	
AND		TL_EMPL_DATA	EMPLID		=		
AND		JOB	PAID_HRS_FREQ		=		
AND		JOB	REG_REGION		=	USA	

```

Where Clause
FROM %SQL(TL_GRP_FROM_BASE)%SQL(TL_GRP_FROM_TL) WHERE
%SQL(TL_GRP_BATCH_WHERE_BASE,%P(1)) AND %SQL(TL_GRP_BATCH_WHERE_TL,%P(1))
AND ( JOB.FULL_PART_TIME = 'P' AND TL_EMPL_DATA.EMPLID = '' AND
JOB.PAID_HRS_FREQUENCY = '' AND JOB.REG_REGION = 'USA')
    
```

<b>Field or Control</b>	<b>Description</b>
<b>Group ID</b>	Specify a workgroup that the employee population uses which is subject to the ACA regulations.  You need to define TRCs for all applicable workgroups.
<b>Taskgroup for Time Reporting</b>	The effective date of the defined group of TRCs.

This allows the separation of employee populations using the following categories:

- salaried employees and hourly employees
- employees whose primary places of employment are in different states
- collectively bargained employees
- non-collectively bargained employees
- each group of collectively bargained employees covered by a separate collective bargaining arrangement.

**Related Links**

[Creating and Updating Dynamic Groups](#)

[Understanding Static and Dynamic Groups](#)



## Creating And Maintaining ACA Materialized Views

The ACA Materialized Views are used to create summary data stores which are used in reporting and the ACA Eligibility Load Query. The materialized views take the results of complex SELECT statements and saves them to the database.

There are six materialized views delivered as part of this feature. These six views are broken into two sets of three which vary by time period, monthly or weekly.

<b>Record Name</b>	<b>Record Title</b>	<b>Description</b>
ACA_MONTH	ACA Year Monthly Totals View	To deliver data for the export to Excel for the monthly period. This view contains the summarized hours and calculated average by month. The ACA_MONTHLY_TOT column reflects the total hours for all employee records under the same common id.
ACA_MONTHLY_JOB	ACA Monthly Total JOB	The view contains salaried hours by month. Salaried and non-salaried employees are contained in this view to facilitate the joining of this record in queries. Non-salaried employee types have zero in the ACA_MONTHLY_TOT column.
ACA_MONTHLY_TL	ACA Monthly Total TL	The view contains the payable time information for all employees for those TRCs set up in the ACA Time Reporting Codes table. These hours are summed by month.
ACA_WEEK	ACA Weekly Totals View	The view is used to deliver data for the export to Excel for the weekly period. This view contains the summarized hours and calculated average by week. The ACA_WEEKLY_TOT column reflects the total hours for all employee records under the same common id.
ACA_WEEKLY_JOB	ACA Monthly Total JOB	The view contains salaried hours by week. Salaried and non-salaried employees are contained in this view to facilitate the joining of this record in queries. Non-salaried employee types have zero in the ACA_WEEKLY_TOT column.

<b>Record Name</b>	<b>Record Title</b>	<b>Description</b>
ACA_WEEKLY_TL	ACA Weekly Total TL	The view contains the payable time information for all employees for those TRCs set up in the ACA Time Reporting Codes table. These hours are summed by week.

## Creating the ACA Materialized Views

Before creating the materialized views, the Administrator has to complete the following tasks:

- The ACA Company Table must be populated. The most current effective date on this table controls the earliest date for which rows are created. For instance, if the most current effective dated row in the ACA Company table is dated 1/1/2014, then the materialized views will be created with the earliest row encompassing 1/1/2014.
- An initial row of basic data must be populated in the ACA Employee Eligibility page.

The basic data includes:

- ACA Common ID
- Effective Date
- Effective Sequence
- Work Period

---

**Note:** If you are on a database other than Oracle, please refer to your system documentation regarding creation of materialized views for more information.

---

## Pages Used to Maintain The Materialized Views

<b>Page Name</b>	<b>Definition Name</b>	<b>Usage</b>
<u>Materialized View Maintenance Page</u>	PTMAT_MAINT	Refresh the materialized views.

## Materialized View Maintenance Page

Use the Materialized View Maintenance Page (PTMAT\_MAINT) for ongoing maintenance of the ACA materialized views.

Navigation:

**PeopleTools > Utilities > Administration > Oracle Materialized Views > Materialized View Maintenance**

This example illustrates the fields and controls on the Materialized View Maintenance Page

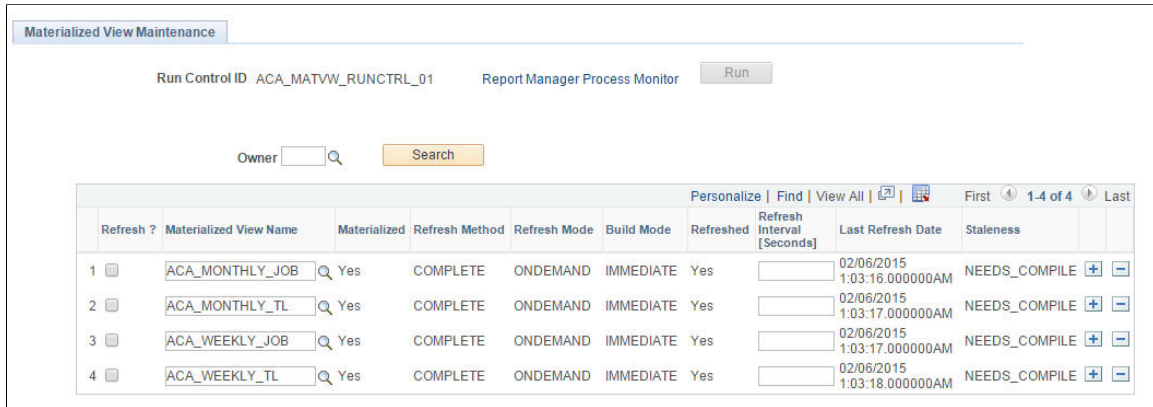

Field or Control	Description
<b>Owner</b>	To limit the grid to records that belong to a specific owner, enter the name and click Search. The owner of the ACA materialized views is HTL.
<b>Refresh?</b>	Click to schedule a refresh for the record.
<b>Materialized View Name</b>	Lists the name of the record. You can change the value in this field.
<b>Materialized</b>	A display-only field that indicates if the record is materialized <b>Yes</b> or not <b>No</b> .
<b>Refresh Method</b>	Lists the refresh method, either complete or fast.
<b>Refresh Mode</b>	Lists the refresh mode, either on demand or on commit.
<b>Build Mode</b>	Lists the build mode, either immediate or deferred.
<b>Refreshed</b>	Indicates if the record is refreshed <b>Yes</b> or not <b>No</b> .
<b>Refresh Interval</b>	The time interval in seconds for the refresh procedure to run. Enter the interval in seconds to refresh the record.
<b>Last Refresh Date</b>	List the date and time the record was last refreshed.
<b>Staleness</b>	Indicates if the record is stale or fresh based on the Oracle System Catalog.
<b>Run</b>	Click to execute the PTMATREFVW Application Engine program that will refresh the selected records.

## Running the ACA Eligibility Load query

Use ACA Eligibility Load Queries to retrieve data from the data store, along with other HR Core tables, and output the results. The queries are of two types: ACA\_MONTH and ACA\_WEEK. Using ACA\_MONTH and ACA\_WEEK , an organization can calculate monthly average and weekly average hours for eligibility respectively.

### Pages Used to Define the ACA Eligibility Load Query

Page Name	Definition Name	Usage
<a href="#">Query Manager Page</a>	QUERY_MANAGER	Access the Affordable Care Act related queries.
<a href="#">Time and Labor WorkCenter_ACA Eligibility — Monthly Period Page</a>	TL_MSS_EE_SRCH_PRD	View the results of ACA Monthly query.
<a href="#">Time and Labor WorkCenter_ACA Eligibility — Weekly Period Page</a>	TL_MSS_EE_SRCH_PRD	View the results of ACA weekly query.

### Query Manager Page

Use the Query Manager page to (QRY\_MANAGER) to access the ACA related queries.

Navigation:

**Main Menu > Reporting Tools > Query > Query Manager**

This example illustrates the fields and controls on the Query Manager page.

The screenshot shows the 'Query Manager' interface. At the top, there is a search section with the text 'Enter any information you have and click Search. Leave fields blank for a list of all values.' Below this, there are links for 'Find an Existing Query' and 'Create New Query'. The search criteria are set to '\*Search By' 'Query Name' and 'begins with' 'ACA'. There are 'Search' and 'Advanced Search' buttons. Below the search section is the 'Search Results' area, which includes a '\*Folder View' dropdown set to '-- All Folders --', 'Check All' and 'Uncheck All' buttons, and an '\*Action' dropdown set to '-- Choose --' with a 'Go' button. The main part of the interface is a table with the following columns: 'Select', 'Query Name', 'Descr', 'Owner', 'Folder', 'Edit', 'Run to HTML', 'Run to Excel', 'Run to XML', 'Schedule', and 'Definitional References'. The table contains seven rows of query results:

Select	Query Name	Descr	Owner	Folder	Edit	Run to HTML	Run to Excel	Run to XML	Schedule	Definitional References
<input type="checkbox"/>	ACA_FULL_PART_TIME	ACA Full time/Part time Status	Public		Edit	HTML	Excel	XML	Schedule	Lookup References
<input type="checkbox"/>	ACA_HIRE_REHIRE_QRY	ACA Hire/Rehire Query	Public		Edit	HTML	Excel	XML	Schedule	Lookup References
<input type="checkbox"/>	ACA_MONTH	ACA Months Query	Public		Edit	HTML	Excel	XML	Schedule	Lookup References
<input type="checkbox"/>	ACA_MONTHLY_THRESHOLD	ACA Monthly Threshold Report	Public		Edit	HTML	Excel	XML	Schedule	Lookup References
<input type="checkbox"/>	ACA_WEEK	ACA Week	Public		Edit	HTML	Excel	XML	Schedule	Lookup References
<input type="checkbox"/>	ACA_WEEKLY_THRESHOLD	ACA Weekly Threshold Report	Public		Edit	HTML	Excel	XML	Schedule	Lookup References

<b>Field or Control</b>	<b>Description</b>
<b>Edit</b>	Click to edit field properties and sort order for your query.
<b>Run to HTML</b>	Click to run the query and generate an online view of the delivered elements. Once you've defined your search criteria for the ACA_MONTH and ACA_WEEK query, in addition to viewing results online, you also have the option of downloading the results into a Microsoft Excel spreadsheet or a CSV text file.
<b>Run to Excel</b>	Click to run the query and publish the results in a Microsoft Excel spreadsheet.
<b>Schedule</b>	Click to define criteria for scheduling a query.

Both of the load queries can either be found in Query Manager or on the Time and Labor WorkCenter, on the Reports/Processes tab, in the Queries pagelet.

See the product documentation for *PeopleTools: Query*

## Time and Labor WorkCenter\_ACA Eligibility — Monthly Period Page

Use the Time and Labor WorkCenter\_Queries Pagelet page (TL\_MSS\_EE\_SRCH\_PRD) to view the results of the ACA Months query.

Navigation:

**Main Menu > Manager Self Service > Time Management > Time and Labor WorkCenter > Reports/Processes > Queries > ACA Eligibility — Monthly Period**

This example illustrates the fields and controls on the Time and Labor WorkCenter\_Queries Pagelet ACA Eligibility — Monthly Period page.

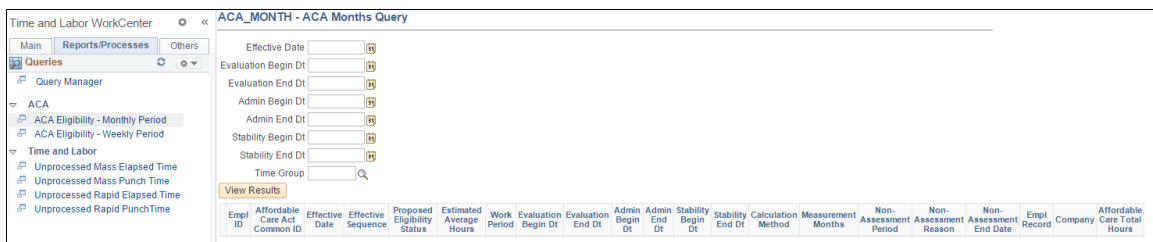

<b>Field or Control</b>	<b>Description</b>
<b>Effective Date</b>	Enter the date that the ACA Eligibility record should be effective. This date populates the upload spreadsheet.

<b>Field or Control</b>	<b>Description</b>
<b>Evaluation Begin Dt</b>	Enter the start date of the Look Back period to be used to determine the employee’s average service hours. This date determines which hours are accumulated to calculate the average hours.
<b>Evaluation End Dt</b>	Enter the end date of the Look Back period to be used to determine the employee’s average service hours. The evaluation period cannot be less than three months or more than 12 months. This date determines which hours are accumulated to calculate the average hours.
<b>Admin Begin Dt</b>	If an Administration Period is used, enter the next date after the evaluation period end date. This date populates the upload spreadsheet.
<b>Admin End Dt</b>	If an Administration Period is used, enter a date within 90 days from the administration period begin date. This date populates the upload spreadsheet.
<b>Stability Begin Dt</b>	Enter the start date of the stability period in which the ACA eligibility status determined during the Evaluation period is effective. The ACA stability period begin date must be after the evaluation period end date  This date populates the upload spreadsheet
<b>Stability End Dt</b>	Enter the minimum end in which the ACA eligibility status determined during the Evaluation period is effective. The date must be later than six months after the ACA stability begin date.
<b>Time Group</b>	Dynamic or Static Time and Labor groups should be set up to segregate your employee population into groups that you want to work with for ACA eligibility processing.  Enter the group which defines the employee population that you want to calculate eligibility for and upload their eligibility record into PeopleSoft.

## Time and Labor WorkCenter\_ACA Eligibility — Weekly Period Page

Use the Time and Labor WorkCenter\_Queries Pagelet page (TL\_MSS\_EE\_SRCH\_PRD) to view the results of ACA weeks query.

Navigation:

**Main Menu > Manager Self Service > Time and Labor WorkCenter > Time Management > Reports/Processes > Queries > ACA Eligibility — Weekly Period**

This example illustrates the fields and controls on the Time and Labor WorkCenter\_Queries Pagelet ACA Eligibility — Weekly Period page.

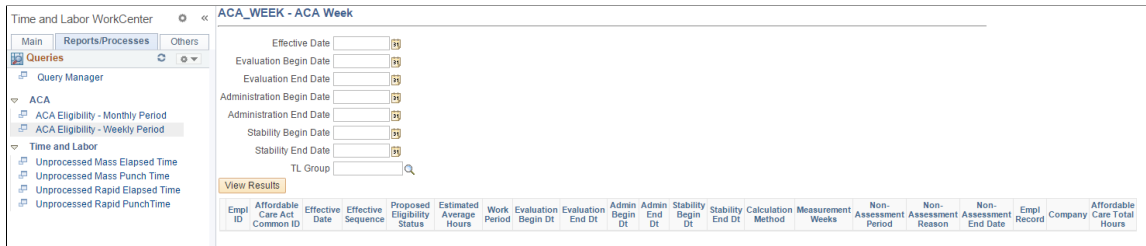

<b>Field or Control</b>	<b>Description</b>
<b>Effective Date</b>	Enter the date that the ACA Eligibility record should be effective. This date populates the upload spreadsheet.
<b>Evaluation Begin Date</b>	Enter the start date of the Look Back period to be used to determine the employee’s average service hours. This date determines which hours are accumulated to calculate the average hours.
<b>Evaluation End Date</b>	Enter the end date of the Look Back period to be used to determine the employee’s average service hours.
<b>Administration Begin Date</b>	If an Administration Period is used, enter the next date after the evaluation period end date. This date populates the upload spreadsheet.
<b>Administration End Date</b>	If an Administration Period is used, enter a date within one week from the administration period begin date. This date populates the upload spreadsheet.
<b>Stability Begin Date</b>	Enter the start date of the stability period in which the ACA eligibility status determined during the Evaluation period is effective. The ACA stability period begin date must be after the evaluation period end date  This date populates the upload spreadsheet
<b>Stability End Date</b>	Enter the minimum end date in which the ACA eligibility status determined during the Evaluation period is effective.
<b>Time Group</b>	Dynamic or Static Time and Labor groups should be set up to segregate your employee population into groups that you want to work with for ACA eligibility processing. Enter the group which defines the employee population that you want to calculate eligibility for and upload their eligibility record into PeopleSoft.

## Generating Reports for Analysis

The analytic reports provide assistance to do the analysis of data and determine eligibility for Affordable Care Act. You can also do the analysis on where the data is missing or inaccurate.

### Pages Used to Configure Data And Generate Reports

<i>Page Name</i>	<i>Definition Name</i>	<i>Usage</i>
<u>ACA Threshold Limits Page</u>	ACA_THRESHOLD_INST	Configure the threshold levels. The configurations are found at this page.
<u>ACA Employee Threshold Report Page</u>	ACA_THRESHOLD	Displays the analytics that is used to monitor variable (hourly) employees who have payable hours within a set number of 'threshold' hours (employer defined on run control).
<u>ACA Full/Part Time Status Page</u>	ACA_FULL_PART_TIME	Displays employees with a full/part time status change whose effective date falls within the date parameters in the run control.
<u>ACA New Hire/Rehire Report Page</u>	ACA_HIRE_REHIRE	Displays those employees who have an action of hire or rehire in Job with an effective date that falls within the date parameters in the run control.

### ACA Threshold Limits Page

Use the ACA Threshold Limits page (ACA\_THRESHOLD) to enter the monthly and weekly limits for payable hours used in calculating the threshold value for each level – Low, Medium and High

Navigation:

**Set Up HCM > Common Definitions > Affordable Care Act > ACA Threshold Limits**



This example illustrates the fields and controls on the ACA Threshold Limits Page. You can find definitions for the fields and controls later on this page.

### ACA Threshold Limits

ACA Monthly Limits		
Threshold Level	ACA Monthly Lower Limit	ACA Monthly Upper Limit
Low	1	<input style="width: 80px;" type="text" value="50"/>
Medium	51	<input style="width: 80px;" type="text" value="90"/>
High	91	

ACA Weekly Limits		
Threshold Level	ACA Weekly Lower Limit	ACA Weekly Upper Limit
Low	1	<input style="width: 80px;" type="text" value="22"/>
Medium	23	<input style="width: 80px;" type="text" value="28"/>
High	29	

Save
 Refresh

<i><b>Field or Control</b></i>	<i><b>Description</b></i>
<b>ACA Monthly Lower Limit</b>	The lowest amount of Monthly average hours for a threshold level.
<b>ACA Monthly Upper Limit</b>	The highest amount of Monthly average hours for a threshold level.
<b>ACA Weekly Lower Limit</b>	The lowest amount of Weekly average hours for a threshold level.
<b>ACA Weekly Upper Limit</b>	The highest amount of Monthly average hours for a threshold level.

## ACA Employee Threshold Report Page

Use the ACA Employee Threshold Report page (ACA\_THRESHOLD) to display variable (hourly) employees who have payable hours within a set number of ‘threshold’ hours defined on the ACA Threshold Limits table.

Navigation:

**Time and Labor > Reports > Interactive Reports > ACA Employee Threshold Report**

This example illustrates the fields and controls on the ACA Employee Threshold Report Page (1 of 2). You can find definitions for the fields and controls later on this page.

### ACA Employee Threshold Report

**View By**

From Date

Thru Date

\*Work Period

<i><b>Field or Control</b></i>	<i><b>Description</b></i>
<b>From Date</b>	Enter the start date of the period which should be analyzed.
<b>Thru Date</b>	Enter the end date of the period which should be analyzed
<b>Work Period</b>	The work period from the ACA Employee Eligibility record. Possible values are Monthly or Weekly. This determine which employees are being brought into the results.

This example illustrates the fields and controls on the ACA Employee Threshold Report Page (2 of 2). You can find definitions for the fields and controls later on this page.

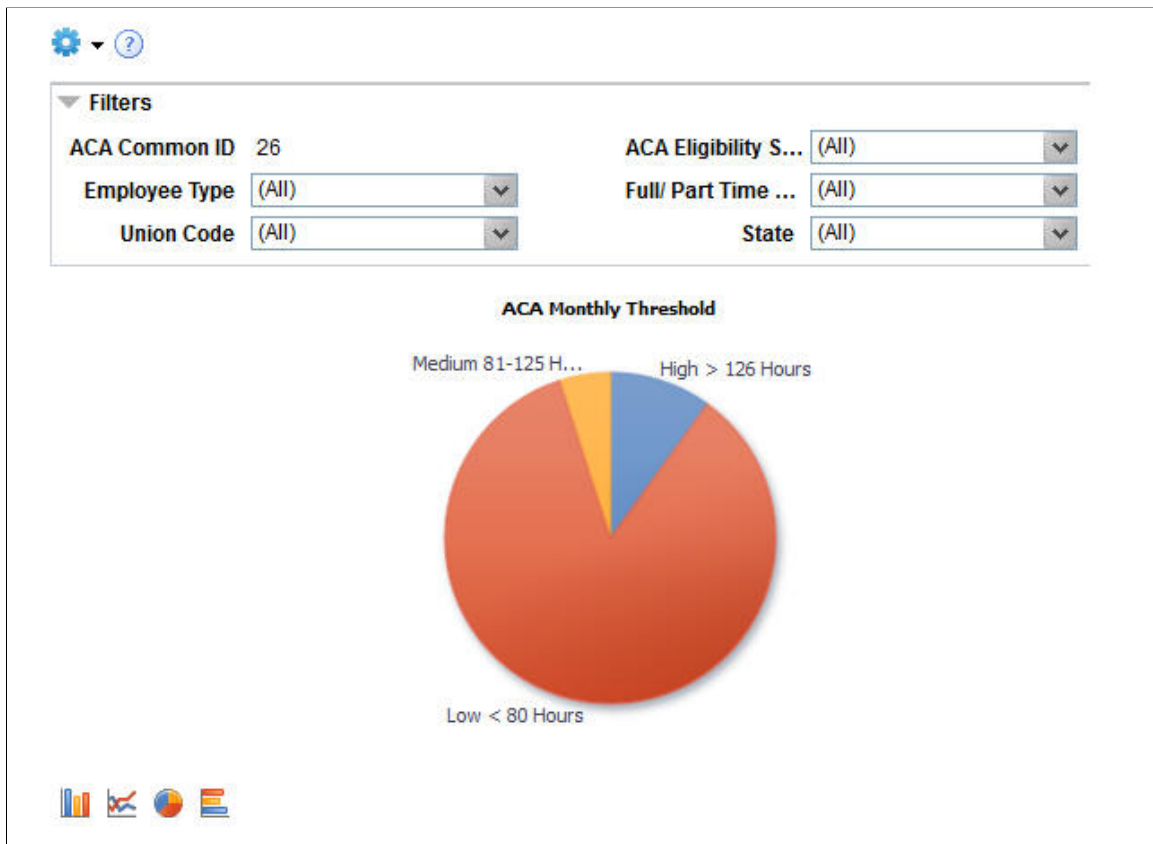

By default, the pivot grid displays a pie chart displaying the percentage of units per ACA Employee threshold.

Examples of what administrator can use this pivot grids to determine are:

- The ACA Eligibility status of each employee for a given Threshold level.
- The ACA Monthly or Weekly Average for a given threshold level.
- The Location of the employee with the Company Name.

## ACA Full/Part Time Status Page

Use the ACA Full/Part Time Status page (ACA\_FULL\_PART\_TIME) to displays those employees who went between Full-Time and Part-Time within the specified time period.

Navigation:

**Time and Labor > Reports > Interactive Reports > ACA Full/Part Time Status**

This example illustrates the fields and controls on the ACA Full/Part Time Status Page ( 1 of 2). You can find definitions for the fields and controls later on this page.

**ACA Full / Part Time status**

**View By**

From Date  31      Thru Date  31

<i>Field or Control</i>	<i>Description</i>
<b>From Date</b>	Enter the start date of the period which should be analyzed.
<b>Thru Date</b>	Enter the end date of the period which should be analyzed

This example illustrates the fields and controls on the ACA Full/Part Time Status Page ( 2 of 2). You can find definitions for the fields and controls later on this page.

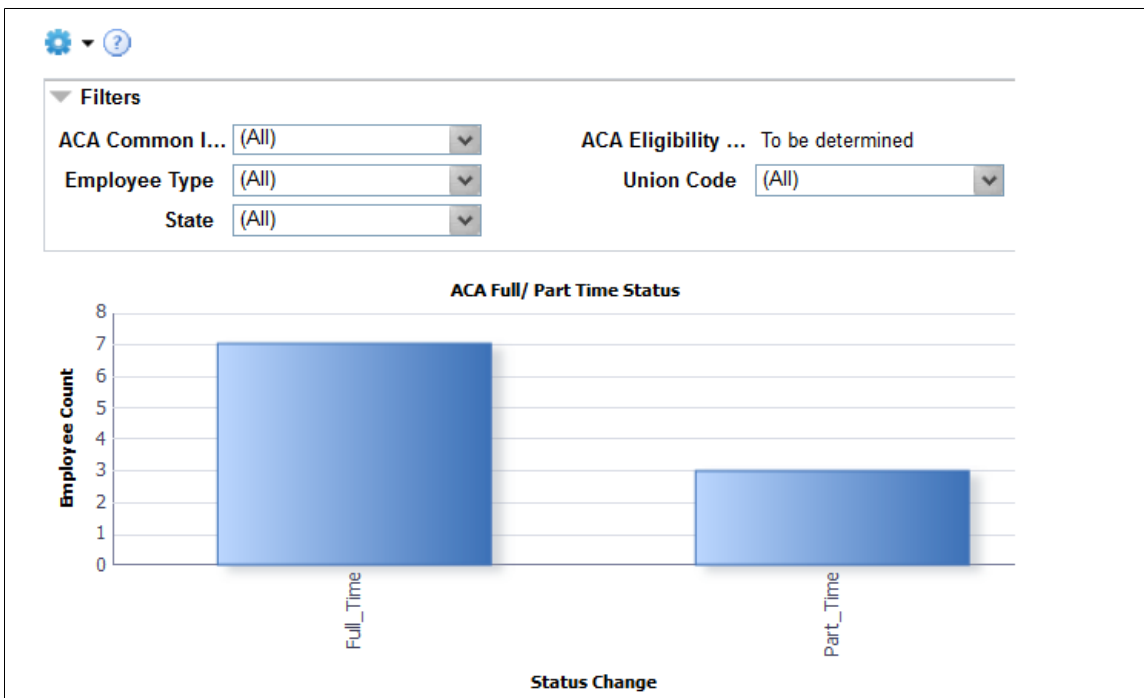

By default, the pivot grid displays a bar chart of the Employee Count for the employee status of full time and part time.

Examples of what administrator can use this pivot grids to determine are:

- The status of an employee and the corresponding effective date.
- The current standard hours and the previous standard hours.

## ACA New Hire/Rehire Report Page

Use the ACA New Hire/Rehire Report page(ACA\_HIRE\_REHIRE) to display those employees who have an action of hire or rehire in Job with an effective date that falls within the date parameters in the run control.



Navigation:

**Time and Labor > Reports > Interactive Reports > ACA New Hire/Rehire Report**

This example illustrates the fields and controls on the ACA New Hire/Rehire Report Page (1 of 2). You can find definitions for the fields and controls later on this page.

**ACA New Hire/ Rehire Report**

**View By**

From Date        Thru Date  

<i>Field or Control</i>	<i>Description</i>
<b>From Date</b>	Enter the start date of the period which should be analyzed.
<b>Thru Date</b>	Enter the end date of the period which should be analyzed

This example illustrates the fields and controls on the ACA New Hire/Rehire Report Page (2 of 2). You can find definitions for the fields and controls later on this page.

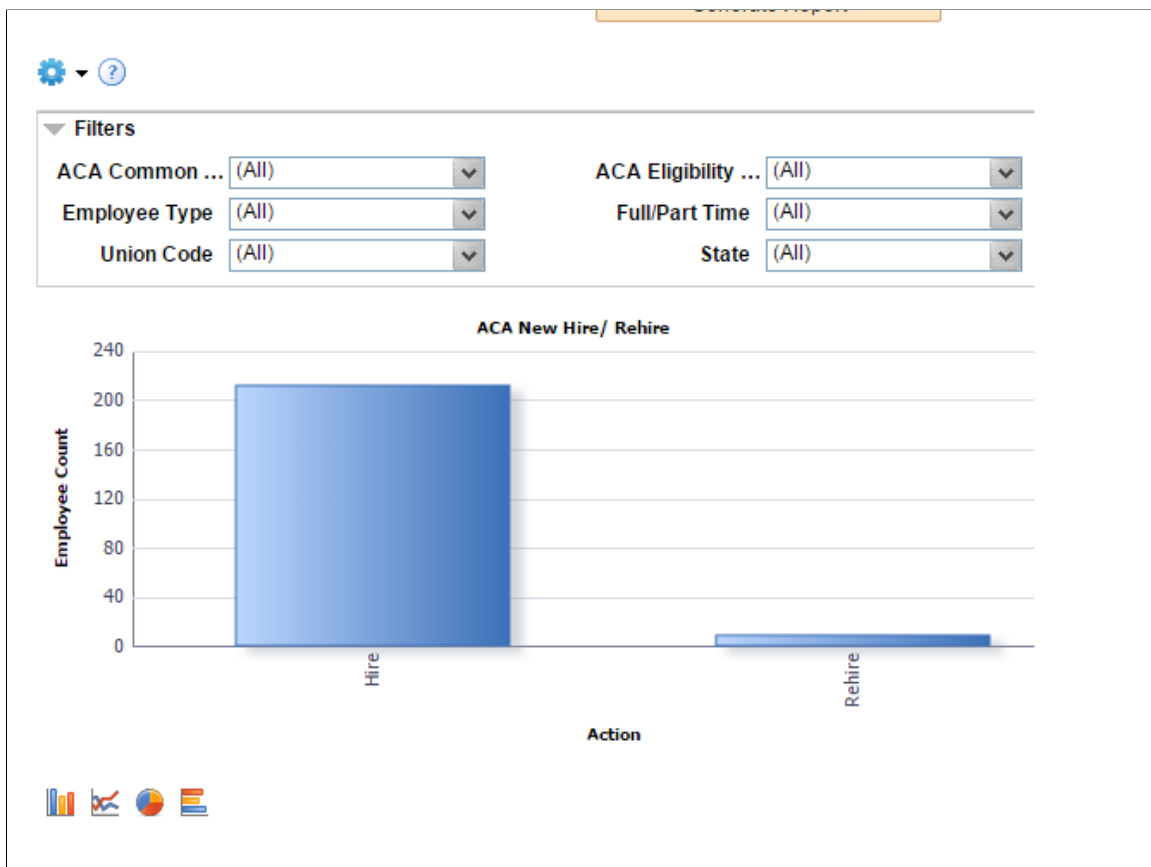

By default, the pivot grid displays a bar chart of the Employee Count for the new Hire and Rehire.

Examples of what administrator can use this pivot grids to determine are:

- The Employee Job Title and the corresponding Pay Group.
- The standard hours and the corresponding Business Unit of the employee.

# Establishing Time and Labor Security

---

## Understanding Row Security Permission Lists

Permission lists, which are created with PeopleTools and assigned to user profiles, define user sign-on times, page access, PeopleTools access, and a variety of other authorizations. Row security permission lists define the set of data permissions for users who are associated with a particular permission list. You can define row security permission lists that enable users to:

- Enter or update time reported in a previous period.
- Use the system date if the system is not in production mode.
- View and enter data for time reporters who belong to specific static or dynamic groups.

We refer to this feature as *group security*.

### Group Versus HCM Data Permission Security

If you plan to use group security, you can create groups before or after you define the other data permissions for a row security permission list. If you choose to create groups first, follow the procedures in the "Establishing Static and Dynamic Groups" section of this book.

When you open the Mass Time, TL Launch Pad, or any other page to enter or display time, the list of available time reporters depends on whether you are using group or HCM data permission security.

- If you use group security, you can view and enter time for all group members assigned to the row security permission list.

You can assign groups to the row security permission list on the Row Security Permission List page, described in this section, or the Security by Group page, described in "Establishing Static and Dynamic Groups".

- If you do not have groups assigned to a row security permission list, the system automatically uses HCM data permission security.

This diagram shows the system criteria for using group or data permission security to determine the accessible time reporters

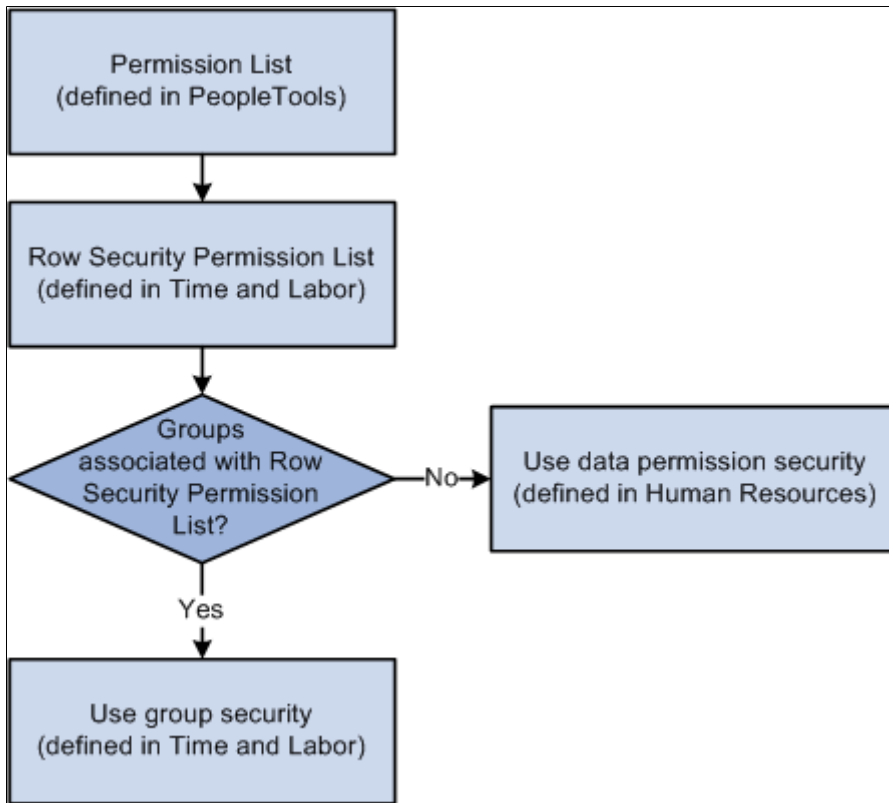

Use the Row Security Permission List page to define whether users who are associated with a selected permission list can:

- Make prior period adjustments.
- Make future time entries.
- Make prior period adjustments within a limited time frame.
- Edit data for certain groups of time reporters.

### Related Links

[Understanding Static and Dynamic Groups](#)

“Understanding PeopleSoft Security” (Application Fundamentals)

---

## Using Row Security Permission Lists

To create row security permission lists, use the TL Permission List Security (TL\_GRP\_SECURITY) component.

This section discusses how to use row security permission lists.



## Pages Used for Using Row Security Permission Lists

<i>Page Name</i>	<i>Definition Name</i>	<i>Usage</i>
<a href="#">Row Security Permission List Page</a>	TL_SECURITY_PNL	Create security that limits a user's ability to access and update data for groups of time reporters.
<a href="#">Row Security Users Page</a>	TL_ROWSEC_MEMBERS	View the user IDs associated with a particular row security permission list.

### Row Security Permission List Page

Use the Row Security Permission List page (TL\_SECURITY\_PNL) to create security that limits a user's ability to access and update data for groups of time reporters.

Navigation:

**Set Up HCM > Security > Time and Labor Security > TL Permission List Security > Row Security Permission List**

This example illustrates the fields and controls on the Row Security Permission List page. You can find definitions for the fields and controls later on this page.

## Security by Permission List

<i>Field or Control</i>	<i>Description</i>
<p><b>Allow Prior Period Time Entry</b></p>	<p>Select to give users associated with this permission list the ability to enter prior period adjustments for members of the groups identified in the <b>Group Access</b> grid.</p> <p>A prior period adjustment is a time entry for a date that falls before the begin date of the time reporter's current period.</p> <p>To determine if the time you're entering is a prior period adjustment, the system references the time reporter's time period ID. Then the system references the time period calendar to determine the begin and end date of the time period in which the adjustment falls. Any entry made for a date that's before the begin date of the current period is a prior period adjustment.</p> <p>For example, assume that today is August 16, 2004, and you want to enter time for August 1, 2004. The time reporter is assigned a weekly time period. The system references the time period calendar to determine that today's date falls within the weekly time period with the dates August 16 to 22. Any time reported before August 16 (the begin date of the current period) is a prior period adjustment.</p> <hr/> <p><b>Note:</b> You assign time period IDs to time reporters on the Maintain Time Reporter Data page. If none is specified, the system uses the time period ID assigned to the time reporter's workgroup.</p> <hr/>

<b>Field or Control</b>	<b>Description</b>
<b>Days Grace Allowed</b>	<p>Use this field to limit the period of time during which users can enter prior period adjustments.</p> <p>Enter the number of days that the system uses to calculate the earliest date for which users can enter adjustments. During time reporting, the system subtracts this number from the current date and compares the resulting date to the time period calendar to find the start date of the time period in which the calculated date falls.</p> <p>For example, assume the following:</p> <ul style="list-style-type: none"> <li>• Days grace allowed = 30</li> <li>• Current date = June 23, 2004</li> <li>• Time period = weekly</li> <li>• Date for which time is to be reported = May 15, 2004</li> </ul> <p>First, the system subtracts the grace period from the current date: June 23, 2004 – 30 days = May 25, 2004. Next, it looks at the time period calendar to determine the start date of the weekly time period in which May 25, 2004, occurs, which is May 23, 2004. Therefore, users can enter or edit time for any date greater than or equal to May 23, 2004.</p> <p>If you leave the <b>Days Grace Allowed</b> field cleared, users can enter or edit time in any previous period.</p>

<b>Field or Control</b>	<b>Description</b>
<b>Allow Future Time Entry</b>	<p>Select to give users associated with this permission list the ability to enter future time entries for members of the groups identified in the <b>Group Access</b> grid.</p> <p>A future time entry is a time entry for a date that falls after the end date of the time reporter's current period.</p> <p>To determine if the time you're entering is for a future period, the system references the time reporter's time period ID. Then, the system references the time period calendar to determine the begin and end date of the time period in which the entry falls. Any entry made for a date following the end date of the current period is a future period.</p> <p>For example, assume that today is August 16, 2004, and you want to enter time for September 1, 2004. The time reporter is assigned a weekly time period. The system references the time period calendar to determine that today's date occurs within the weekly time period August 16 to 22. Any time reported after August 22 (the end date of the current period) occurs in a future period.</p> <hr/> <p><b>Note:</b> You assign time period IDs to time reporters on the Maintain Time Reporter Data page. If none is specified, the system uses the time period ID assigned to the time reporter's workgroup.</p> <hr/>

<b>Field or Control</b>	<b>Description</b>
<b>Future Days Grace Allowed</b>	<p>Use this field to limit the period of time during which users can enter future period entries.</p> <p>Enter the number of days that the system uses to calculate the latest date for which users can enter future period entries. During time reporting, the system adds this number to the current date and compares the resulting date to the time period calendar to find the end date of the time period in which the calculated date occurs.</p> <p>For example, assume the following:</p> <ul style="list-style-type: none"> <li>• Days grace allowed = 30</li> <li>• Current date = June 21, 2004</li> <li>• Time period = weekly</li> <li>• Date for which time is to be reported = July 15, 2004</li> </ul> <p>First, the system adds the grace period to the current date: June 21, 2004 + 30 days = July 21, 2004. Next, it looks at the time period calendar to determine the end date of the weekly time period in which July 21, 2004 occurs, which is July 24, 2004. Therefore, users can enter or edit time for any date less than or equal to July 24, 2004.</p> <p>If you leave the <b>Days Grace Allowed</b> field cleared, users can enter or edit time in any future period.</p>
<b>Restrict Prior Year Time Entry</b>	<p>Select to give users associated with this permission list the ability to enter prior period adjustments as far back as the beginning of the year for members of the groups identified in the <b>Group Access</b> grid.</p>
<b>Prior Year Ends In</b>	<p>If the Prior Year Ends In field is selected, chose the month that the year ends in. The system will restrict time entry access, prior to and including the selected month end date.</p>
<b>Use TL System Date</b>	<p>This field is available for testing purposes and appears only when the system is not in production mode. It enables you to select a date that the system considers as the current date to test the defined functionality for prior period adjustments.</p>
<b>TL System Date</b>	<p>The <b>TL System Date</b> field appears only when you select the <b>Use TL System Date</b> check box. Enter the date for the system to consider as the current date for testing purposes.</p>

## Group Access

The **Group Access** grid identifies the time reporter groups that users associated with this permission list can access—the set of time reporters for whom users can view, update, and delete time reporting data. If you do not select any groups, access to time reporter data is controlled by department security. Users will be able to enter and update time reporting information for those people within their own department and any subsidiary departments.

<i>Field or Control</i>	<i>Description</i>
<b>Group ID</b>	Select the dynamic or static group of time reporters for users associated with this permission list to access.
<b>Group Type Indicator</b>	This field indicates whether the selected group is dynamic or static.

### Related Links

[Creating and Updating Dynamic Groups](#)

## Row Security Users Page

Use the Row Security Users page (TL\_ROWSEC\_MEMBERS) to view the user IDs associated with a particular row security permission list.

Navigation:

**Set Up HCM > Security > Time and Labor Security > TL Permission List Security > Row Security Users tab**

The system displays the user ID and description of each member of this row security permission list.

---

**Note:** Assign row security permission lists to user IDs in the User Profiles component on the PeopleTools menu.

---

# Creating Rules in Time Administration

---

## Understanding Time Administration

This section discusses:

- The create rules component
- The batch processing component
- The online processing component

Although the Time Administration processes are complex and varied, the Time Administration business process has these main components:

<b>Term</b>	<b>Definition</b>
<b>Create Rules</b>	The Create Rules component consists of the online tools that enable you to create, compile, and apply rules to reported and scheduled time. You can create rules for the batch process only or for both batch and online rules processing.
<b>Batch Processing</b>	The Time Administration batch processing component applies the rules to time reporter data and generates payable time from reported and scheduled time.
<b>Online Processing</b>	From the Timesheet, the Apply Online Rules process immediately applies your online rules to the time for a specific time reporter.

## Create Rules Component

The Create Rules component has these online tools for defining rules:

<b>Term</b>	<b>Definition</b>
<b>Templates</b>	Use templates to create a variety of rules for the Time Administration program to execute when processing reported and scheduled time. Create compensation rules for overtime and holidays, notification rules for irregular attendance, and rules for other time reporting that requires special processing. There are more than 40 delivered rule templates.

<b>Term</b>	<b>Definition</b>
<b>Actions and Conditions</b>	Use Actions and Conditions to define actions and conditions independently of one another and then join them to create rules. You cannot perform select actions or subqueries with Actions and Conditions, so if your rule requires either of these, use SQL objects.
SQL Objects	SQL objects are the most flexible Time and Labor rule creation tool. You can use SQL objects to create rules using Select statements, Insert statements, Update statements, Delete statements, table joins, and subqueries.
User Exits	<p>With delivered rule templates and rule objects (Actions, Conditions, and SQL objects), you can build rules that address most business needs. Use a user exit when a particular business rule cannot be accommodated by delivered rule templates or rule objects.</p> <p>With user exits, you can add PeopleCode and PeopleSoft Application Engine (AE) sections to regular processing. Also, to build a complex Time and Labor rule, you can create the rule in AE and add a user exit that calls the rule during processing.</p> <p>When you write user exits, you must add AE sections to the AE program TL_TA_RULES. You can use all the AE constructs supported by PeopleTools (SQL, PeopleCode, looping constructs like Do When, Do While, and so on).</p>

**Related Links**

- [Defining Template-Built Rules](#)
- [Creating Rules with Actions and Conditions](#)
- [Creating SQL Objects](#)

**Batch Processing Component**

The batch process in Time and Labor generates payable time. It executes the rules defined using the Time and Labor online tools for rule creation, selects the appropriate time reporters for processing, combines time reporters into batches for efficient processing, determines the period to process, and calculates prior period adjustments.

**Related Links**

- [Understanding the Time Administration Process Flow](#)

**Online Processing Component**

Time and Labor enables you to define online rules and immediately estimate the effect of applying these rules to weekly elapsed and punch time. You can invoke the Apply Online Rules process from the Timesheet page. When you do, the system executes an abbreviated version of the Time Administration process for a selected time reporter, applying only those rules that are defined for both batch *and* online



processing. (You specify the maximum number of online rules that can be added to a rule program when you complete the Time and Labor Installation page during implementation.)

The system begins by looking at the transactions entered on the Time Reporting page. Depending on your rule definitions, it may pull in and process time for a day, week, or specified time period and will display the results accordingly.

When you define a rule for both online and batch use, be sure the time period that the rule evaluates will handle day, week and time periods that may be defined on the timesheet. Templates for attendance rules, such as templates 360, 360A, 360B as well as templates for exception rules 300, 310, and 320 may be better suited for batch processing.

To create actual payable time, run your rules as part of the Time Administration batch process; however, online processing enables you to preview the effect of weekly elapsed and punch time rules directly, online, in advance of the batch run. In addition, you can detect and resolve user-defined exceptions that result from the application of online rules.

## Online Processing Steps

The Apply Online Rules process bypasses these phases of processing, which are executed during the batch Time Administration run:

- Attendance processing.
- Offset processing.
- Compensatory time balance validation.
- Calculation of estimated gross for rule override transactions.
- Update of TA\_STATUS and EARLIEST\_CHGDT.

---

## Understanding Rules

This section discusses:

- General setup steps.
- Rules from actions and conditions and SQL objects.
- Rule step creation guidelines.

All rules in Time and Labor are written in SQL. You don't have to be a SQL expert to create rules because you will probably create most rules using templates, and the templates contain the basic logic, underlying structures, and necessary SQL objects. However, an understanding of SQL is helpful, particularly if you use actions and conditions, or SQL objects to define your rules, since these tools give direct access to SQL logic and language. In addition, to properly create, test, and troubleshoot rules, you should understand the structure of a SQL statement and the basic procedures for converting business rules into SQL rules.

## General Setup Steps

Perform these two setup steps before creating rules if you are using either actions and conditions, or SQL objects to define the rules:

- Specify which tables (or records) to access and which SQL actions rule's developers can access.

You'll do this using the Working Tables page.

- If you create a condition that references a field that is not part of the record being updated, define a relationship definition (or join) between the record you are updating and the external record.

To do this, use the TL Relationship Definitions page. Setting up a relationship definition eliminates the need to code this relationship. If you are creating rules using actions and conditions, set up this relationship definition beforehand (if you must refer to external tables). You cannot define a table join within the rule itself. If you are using SQL objects, create a table join directly in the rule.

### Related Links

[Specifying Table Access](#)

[Creating SQL Objects](#)

## Rules from Actions and Conditions and SQL Objects

When you use the Actions and Conditions or the SQL Objects pages, you won't create complete rules, but the building blocks of rules: rule components. To define a complete rule, you must:

- Link the components to other components.
- Place the components in the proper order for processing (define rule steps).
- Specify the period of interest for the resulting rule.
- Group rules into rule programs and then link these rules to time reporters through workgroups.

---

**Note:** Template-built rules are fully defined rules. This means that you don't need to define the rule steps that make up a template-built rule. However, you do need to add template-built rules to rule programs on the Rule Programs page, and assign the rule program to a workgroup.

---

To complete a rule definition:

1. Define the rule components.

Use Actions and Conditions or SQL Objects.

2. Define the rule period.

Specify the period of interest for the rule using the Define Rule Header page. Valid periods include PeopleSoft-delivered periods and any time periods created using the Time Period pages. The system uses time periods to determine the data for a particular span of time on which the rule will act. The Time Administration program also uses the time period to determine which reported time to load into the working tables during processing.

### 3. Define rule steps.

Once you define the individual building blocks that make up a rule using actions and conditions or SQL objects, you must combine these components into complete rules and place them in the correct processing order by arranging them into rule steps. Each rule can have one or multiple steps. You'll order individual rule components into rule steps on the Define Rule Steps pages. SQL processes the records in sets. Rule steps must be properly ordered for set processing. Review delivered rule templates (with the rule ID prefix of TEMPLATE) to see how rule steps are organized for set processing. Test the SQL statement for each rule step with the database query tool to ensure that it produces the desired results before continuing with the next step. You may need to replace meta-SQL with platform-specific SQL before testing the SQL statement.

### 4. Assign the rule to a rule program.

Add your rules to a rule program using the Rule Program and Program Detail pages. The rule program specifies the set of rules and the order in which the Time Administration process executes them.

---

**Note:** The number of online rules you can include in a rule program is determined by the entry in the Maximum Online Rules field on the TL Installation page.

---

**Note:** Rule programs are effective-dated, but the individual rules contained within them are not. You cannot modify a rule once you assign it to a rule program. However, you can remove the rule from the rule program and replace it, if appropriate, with a new rule. This feature ensures the referential integrity of rules processing.

---

### 5. Attach the rule program to a workgroup.

Use the Workgroup page. The rule program determines which rules are processed for the time reporters in the workgroup. If a rule does not exist in the rule program associated with a workgroup, no member of the workgroup is processed using that rule.

## Related Links

[Creating Rules with Actions and Conditions](#)

[Creating SQL Objects](#)

[Understanding Workgroups](#)

[Assembling Rules](#)

## Rule Step Creation Guidelines

When you create rules in Time Administration, you translate the organization's business rules into SQL statements for the system. The Time Administration pages enable you to implement rules, but they are not design tools. Before you enter any information in these pages, design and organize your rule steps, consider the SQL involved, and decide which Time Administration options to use. This section provides guidelines for understanding, designing, and organizing rule steps. The end of this section provides an example that outlines more explicitly how to enter rule steps into the system.

---

**Note:** Use the simplest building blocks when creating rules. Whenever possible, use or modify the delivered rule templates rather than creating new actions and conditions or SQL objects to define rules.

---

## Design and Organize Rule Steps

Determine whether you can use one of the delivered rule templates or if you must create either actions and conditions or SQL objects. Consider which rules or parts of rules to reuse. If you can use part of a rule repeatedly or in many ways, create an action or condition or a SQL object so that you can reuse that part of the rule.

Think about dependencies: what should be checked or processed first. If you want to act on a subset of data or the results of a query, define that data or subquery first. If you want to act only if a certain condition exists, create the statement to determine if the condition is true before inputting the action. If you want to perform multiple actions on a single row, think about processing order. For example, if you must compare daily reported time to daily scheduled hours, sum the daily reported time and scheduled time first. Although the comparison and summation could be a single step, keep each step relatively simple for maintenance and troubleshooting. Specify and order rule steps on the Define Rule Steps page.

Avoid broad or redundant querying or processing. For optimal performance, create conditions that retrieve the fewest possible records and still satisfy your data needs. For example, specifying certain column names in your Select statements is more efficient than selecting all columns. Use the logical operator IN instead of OR, since IN is processed faster than OR.

If you want to create a rule that concerns a certain period of time, define a valid rule period ID for that rule.

Use all the tools available to you. When possible, use PeopleSoft-delivered objects. Create value lists instead of multiple conditions. Several working tables are delivered within rules, but you can create your own working tables. They must be temporary tables.

---

**Warning!** Do not modify delivered working tables. If any of the delivered working tables are modified, template-built rules do not function properly and may generate unexpected results. Also consider copying delivered SQL objects into your own, using your individual naming prefix. This ensures that your rules are affected by future, delivered, modifications to SQL objects.

---

## Translate Business Rules into SQL Rules

Before you create rules in Time and Labor, have a clear idea of how you manage both time and time reporters, and have the business rules in front of you when you begin. Certain terminology in these documents has counterparts in particular SQL conditions and actions. Words such as *update*, *replace*, and *substitute* frequently imply the SQL action *update*. Words such as *where*, *if*, *when*, and *in case of* imply dependencies and conditions.

## Use Working Tables within Rules

Before Time Administration can execute a rule, it moves the time reporter data needed to run the rule from scheduled and reported time into a data store known as Intermediate Payable Time. Rules are applied to information in the data store rather than to data in scheduled or reported time to protect the integrity of the source data. The Intermediate Payable Time data store comprises these five tables:

- TL\_IPT1
- TL\_IPT2
- TL\_IPT3
- TL\_IPT4

- TL\_IPT5

In addition to the Intermediate Payable Time tables, you can access a number of other working tables in the system. Most of these working tables start with the prefix TL\_WRK.

---

**Note:** You can create your own working tables to store data temporarily, but they must be temporary tables.

---

## Rules for Using Working Tables

When you create rules in Time Administration, remember that:

- Time Administration automatically loads much of the data for executing rules into the Intermediate Payable Time table TL\_IPT1.

In the rules, you can move data back and forth between this table and the other Intermediate Payable Time tables. For example, the rule can move time data from TL\_IPT1 to TL\_IPT2, apply a specific TRC to this time, and then update the original row of data in TL\_IPT1 with the new TRC-associated data.

- You must decide when and how to move data from TL\_IPT1 to other working tables.

After the rules process and modify the data in other tables, return any processed data to send to Payable Time back to TL\_IPT1, which is the table containing the original, raw data. That is, push the data in its final form—the form in which to the data to Payable Time—back to TL\_IPT1. If the data does not exist in TL\_IPT1, it will not become part of Payable Time.

- You must always truncate (or clear) working tables before moving data into them.

This ensures that the data that remains in those tables from previous rules processing does not interfere with or corrupt the new data. To truncate any working table, use the %TruncateTable command, which is included in the list of meta-SQL commands supported by PeopleSoft. However, never truncate or delete the data in TL\_IPT1; it contains raw time data to execute the rules. If you delete this data, the rules have nothing to process.

- You can move data from external tables (nonworking tables) into working tables.

If you do not plan to process or modify this data, but you must verify it (in a condition statement, for example), consider reading the external tables directly rather than moving large quantities of information into the working tables. Moving large quantities of data into TL\_IPT1 can affect processing speed.

## Example: Translating Business Rules into SQL Rules

This example illustrates how to translate a business rule into a SQL rule, and how the resulting SQL rule moves data from TL\_IPT1 to other working tables in the system. Suppose that your business rule states: All hours worked in excess of 40 hours in any one week shall be paid at the rate of 1.5 times the employee's applicable hourly rate.

The first step is to rewrite the business rule in a simpler sentence. If possible, translate business concepts into Time and Labor terms. For example, you recognize that the rate of 1.5 times the normal rate implies a different (overtime) TRC. Rewrite this business rule as: Replace all hours in excess of 40 in a week with TRC *OT 1.5*.

Next, determine what type of action the system will take. Most business rules require an insert or update and may require subqueries to determine more precisely which rows to affect. This example requires the update action.

---

**Note:** If your business rules require you to store the original rows and add rows only where the TRC changes, you would create an insert action.

---

Next, consider what conditions exist in the statement. In our example, *in excess of 40 hours* and *in one week* are conditions.

To accomplish this rule, you need seven steps. Steps one through two are actions; steps three through seven are SQL objects:

1. Delete TL\_IPT2 (truncate working table).
2. Delete TL\_IPT3 (truncate working table).
3. Insert affected row (Friday, 10, 46, REG) into TL\_IPT2 with hours over threshold and new TRC.
4. Insert rows after affected row (Saturday, 6, 52, REG) into TL\_IPT3.
5. Calculate TL\_QTY-TL\_QTY in work record (TL\_IPT2) and update row (Friday, 10, 46, REG becomes Friday, 4, 40, REG) in TL\_IPT1.
6. Insert new row (Friday, 6, 46, OT1.5) into TL\_IPT1 with new sequence number.
7. Update TL\_IPT1 TRC with 'ot1.5' where exists in TL\_IPT3.

The shaded rows in these tables represent Intermediate Payable Time created by these rule steps. Changes to the original TL\_IPT1 data are in italics:

### Data in IPT1

This table lists the data in IPT1:

<b>Day</b>	<b>Hours</b>	<b>Total Week Hours</b>	<b>TRC</b>
Monday	8	8	REG
Tuesday	10	18	REG
Wednesday	8	26	REG
Thursday	10	36	REG
Friday	10	46	REG
Saturday	6	52	REG

## Data in IPT2

This table lists the data in IPT2:

<i>Day</i>	<i>Hours</i>	<i>Total Week Hours</i>	<i>TRC</i>
Friday	4	40	REG
Friday	6	46	<i>OT 1.5</i>

## Data in IPT3

This table lists the data in IPT3:

<i>Day</i>	<i>Hours</i>	<i>Total Week Hours</i>	<i>TRC</i>
Saturday	6	52	<i>OT 1.5</i>

## Data in IPT1 After Processing

This table lists the data in IPT1 after processing:

<i>Day</i>	<i>Hours</i>	<i>Total Week Hours</i>	<i>TRC</i>
Monday	8	8	REG
Tuesday	10	18	REG
Wednesday	8	26	REG
Thursday	10	36	REG
Friday	4	40	REG
Friday	6	46	OT1.5
Saturday	6	52	OT1.5

---

**Note:** This simple example ignores the TRC. A more complicated example could also include a daily rule run before this and might also create overtime.

---

## Using Value Lists within Rules

When you want the condition or action clause of a rule to apply to multiple values—such as multiple TRC codes, multiple shifts, or multiple task groups—create value lists rather than defining multiple conditions.

For example, you have a rule that tells the system to create premium time when a time reporter reports more than 40 hours to time reporting codes *Regular, Sick, Vacation, and Holiday*. Before you create this rule, you set up a TRC value list and add the TRCs for *Regular, Sick, Vacation, and Holiday*. When Time Administration executes the rule, it will refer only to the four TRCs in your list. For another example, you want to restrict the punch types that can follow an In punch. You can create a value list that includes only those punch types you deem valid. You can then use Rule Template240 to create a rule that generates an exception when an invalid punch type follows an In punch. Value lists are used within template-built rules.

This table shows each type of list you can create and where the values are defined:

<b>Type of Value List</b>	<b>Where Values Are Defined</b>
Companies	PS_COMPANY_TBL
Dept IDs	PS_DEPT_TBL
Employee Statuses	Translate Values for EMPL_STATUS
Employee Types	Translate Values for EMPL_TYPE
Grades	PS_SAL_GRADE_TBL
Jobcodes	PS_JOBCODE_TBL
Paygroups	PS_PAYGROUP_TBL
Position numbers	PS_POSITION_DATA
Punch Types	Translate Values for PUNCH_TYPE
Steps	PS_SAL_STEP_TBL
Shifts	PS_SCH_SHIFT_TBL
TCD Groups	PS_TL_TCDGRP_TBL
Taskgroups	PS_TL_TASKGRP_TBL



<i>Type of Value List</i>	<i>Where Values Are Defined</i>
TRCs	PS_TL_TRC_TBL
Union Codes	PS_UNION_TBL
Workgroups	PS_TL_WRKGRP_TBL

## Rule Elements within Rules

To control how and when rules are applied to different groups of time reporters, use rule elements. You can define up to five rule elements to represent any type of data, and then use these elements within the conditions for your rules.

Rule elements are associated with time reporters by:

- Assigning rule elements directly to time reporters on the Create Time Reporter Data page or the Maintain Time Reporter Data page.
- Positively reporting rule elements when entering time.

### Example: Defining and Using Rule Elements

You define a rule element called Jobs. You also create these values for Jobs: HOST, CASHIER, ASST MGR, WAITER. Next, you build a rule that creates a premium if a worker positively reports the value ASST MGR for rule element 1. As an alternative, you might build your rule so that the system creates a premium whenever time is reported by a person for whom the value ASST MGR is entered in the Rule Element 1 field on the Create Time Reporter Data page or the Maintain Time Reporter Data page.

---

**Note:** Both the Time Reporting Template page and the Rapid Time Template page include options to override rule elements.

---

## Meta-SQL within Rules

Use meta-SQL as an alternative to creating complex SQL commands on your own. Meta-SQL enables you to perform many SQL functions by giving you access to complex SQL operations in a shorthand form. Meta-SQL functions expand to platform-specific SQL statements. Time and Labor uses meta-SQL to interface with different database platforms. A meta-SQL operand begins with a percent (%) sign and returns a scalar value. Almost all meta-SQL constructs that are visible in Time and Labor are PeopleTools meta-SQL constructs that are processed at run time.

## Common HR Data in Rules

To use Human Resources or Time and Labor employee data within your rules, check whether the data exists in TL\_PROF\_WRK before creating multiple joins to tables in Human Resources. TL\_PROF\_WRK is a temporary table created at the beginning of the Time Administration batch run. It contains employee-related data retrieved from various HCM and Time and Labor source tables, effective as of the current run. Instead of accessing the various source tables to create a rule, you can create a single join to this table to retrieve information relating to all the time reporters you must process.

---

**Warning!** Do not alter the structure of TL\_PROF\_WRK. Time Administration references this table at different times during the batch run. If you need field values that are not present in TL\_PROF\_WRK, it is better to create a new record that stores those values, and insert one row for each effective dated row in TL\_PROF\_WRK. This protects you from any future delivered changes in this area, and means that you will not need to perform custom maintenance on the SQL statements loading TL\_PROF\_WRK.

---

TL\_PROF\_WRK contains fields derived from these source tables:

#	Field Name	Source	Description
1	EMPLID	TL_EMPL_DATA	Employee identification number.
2	EMPL_RCD	TL_EMPL_DATA	Employee record number.
3	NAME	PERSONAL_DATA	Employee name.
4	EFFDT	BADGE_TBL	Effective date of the badge.
5	BADGE_NBR	BADGE_TBL	Badge number.
6	HIRE_DT	EMPLOYMENT	Hire date.
7	REHIRE_DT	EMPLOYMENT	Rehire date.
8	CMPNY_SENIORITY_DT	EMPLOYMENT	Seniority date.
9	SUPERVISOR_ID	EMPLOYMENT	Supervisor ID.
10	WORKGROUP	TL_EMPL_DATA	Workgroup ID.
11	PAYGROUP	JOB	Paygroup.
12	EMPL_STATUS	JOB	Employee status.
13	REG_TEMP	JOB	Regular or temporary indicator.
14	FULL_PART_TIME	JOB	Full-time or part-time indicator.

#	Field Name	Source	Description
15	EMPL_TYPE	JOB	Employee type indicator (hourly, salaried, and so on).
16	PER_TYPE	PERSONAL_DATA	Personnel type indicator.
17	COMPANY	JOB	Company.
18	JOBCODE	JOB	Job code.
19	LOCATION	JOB	Location.
20	COMPRATE	JOB	Compensation rate.
21	UNION_CD	JOB	Union code.
22	DEPTID	JOB	Department ID.
23	BUSINESS_UNIT	JOB	Business unit.
24	POSITION_NBR	JOB	Position number.

**Note:** This table contains data on the employees in each batch of time reporters for the period of interest defined by the Build Rule Map process. Because it only contains data for the period of interest defined by the rule map process, you cannot use it as a source of human resources data for periods extending beyond the period of interest.

## Prioritizing Rules in Rule Programs

Consider rule priority when dependencies exist among the rules in a rule program. For example, you've defined these rules for the organization:

- Default TRC: Set any blank TRC to REG.
- Daily 8: Pay overtime (OT1.5) for hours worked in excess of 8.0 per day.
- Daily 12: Pay double time (OT2.0) for hours in excess of 12 per day.
- Weekly 40: Pay overtime (OT1.5) for hours worked in excess of 40 per week.

In this example, the second, third, and fourth rules evaluate time with a TRC of REG. In addition, they are replace-type rules, for which REG is reduced to the threshold number and a new TRC is created for the excess hours. Based on this information, order your rule program as follows:

1. Default TRC

Other rules must evaluate TRC REG.

## 2. Daily 12

This must execute before the Daily 8 rule because REG is set to 12 if hours are over 12. If the Daily 8 rule runs first, the Daily 12 rule does not generate double time because all records with hours over 12 are set to 8.

## 3. Daily 8

Daily 12 reduces hours in excess of 12 to 12.

## 4. Weekly 40

Executed last because it needs to capture all the REG hours (including REG hours that are reduced by daily rules and REG hours that are not altered by daily rules).

## Time Period Selection for A Rule

When creating rules, carefully analyze the time period to use. For rules that apply to punch time reporters, evaluate your daybreaker and the relationship between the out punch of one day and the in punch of the next day. In many cases, you may need to apply a time period greater than a day for the proper evaluation of a daily rule.

## Rules Testing

Always test any rule you create using an interactive SQL tool. Otherwise, the system could generate incorrect results when it processes the rules.

---

**Note:** When testing a template-built rule, you may need to replace meta-SQL with platform specific code and enter values for variables that users would normally insert into the template's condition and action statements through the template pages.

---

## Related Links

[Understanding Time Reporter Data](#)

[Creating Rules with Actions and Conditions](#)

[Step 5: Building Time Reporter Profiles](#)

[Establishing Time Periods](#)

[Setting Up Day Breaker Options](#)

[Creating Rules from a Template](#)

---

## Creating Value Lists

To create value lists, use the Value List (TL\_VALUE\_LST\_PNL) component.

This section discusses how to group codes into value lists.

## Page Used to Create Value Lists

<b>Page Name</b>	<b>Definition Name</b>	<b>Usage</b>
<u>Value Lists Page</u>	TL_VALUE_LST_PNL	Group codes for rules processing.

## Value Lists Page

Use the Value Lists page (TL\_VALUE\_LST\_PNL) to group codes for rules processing.

Navigation:

**Set Up HCM > Product Related > Time and Labor > Rules and Workgroups > Value Lists > Value Lists**

The following video provides an overview of Effective Dated Value Lists:

Video: [Image Highlights, PeopleSoft HCM Update Image 37: Effective Dates for Time and Labor Value Lists](#)

This example illustrates the fields and controls on the Value Lists page. You can find definitions for the fields and controls later on this page.

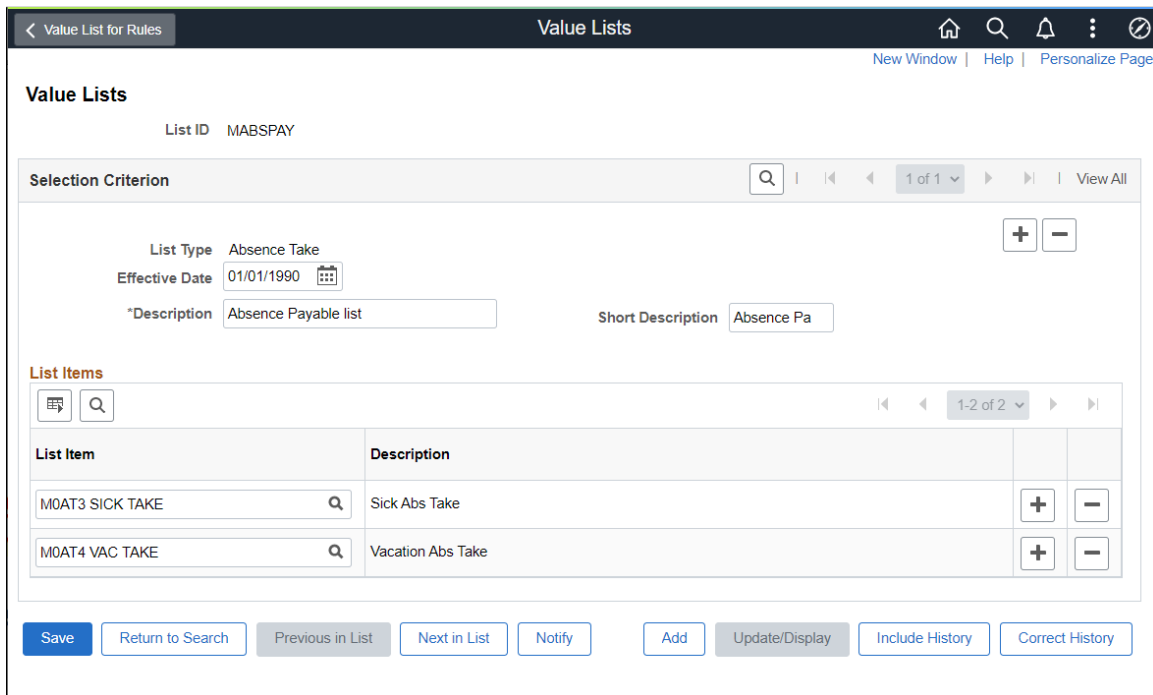

This example illustrates the fields and controls on the Value Lists page for work vs Non work items.

**Value Lists**

List ID WRKTRC

---

**Selection Criterion** 1 of 1 View All

List Type Time Reporting Codes + -

Effective Date 10/23/2021

\*Description  Short Description

TRC Category

---

**List Items** 1-6 of 6

List Item	Description		
<input type="text" value="GXWRK"/>	TRC for WRK hours	+	-
<input type="text" value="KUOVT"/>	Overtime	+	-
<input type="text" value="KUREG"/>	Regular	+	-
<input type="text" value="MEG"/>	Regular	+	-
<input type="text" value="MVT"/>	ST - Overtime - 1.5x	+	-
<input type="text" value="REG"/>	Regular	+	-

<b>Field or Control</b>	<b>Description</b>
<b>Effective Date</b>	Select to include Effective Dated Changes for Time and Labor Template built rules for the list types.

## Defining Rule Elements

To define rule elements, use the Rule Element 1 through Rule Element 5 (TL\_RULE\_ELEM1\_PNL, TL\_RULE\_ELEM2\_PNL, TL\_RULE\_ELEM3\_PNL, TL\_RULE\_ELEM4\_PNL and TL\_RULE\_ELEM5\_PNL) components. Use the TL\_RULE\_ELEM1\_PNL, TL\_RULE\_ELEM2\_PNL, TL\_RULE\_ELEM3\_PNL, TL\_RULE\_ELEM4\_PNL and TL\_RULE\_ELEM5\_PNL component interfaces to load data into the tables for these components.

This section discusses how to create user-defined rule elements.

## Page Used to Define Rule Elements

<i>Page Name</i>	<i>Definition Name</i>	<i>Usage</i>
<u>Rule Element 1 through Rule Element 5 Pages</u>	TL_RULE_ELEM1_PNL TL_RULE_ELEM2_PNL TL_RULE_ELEM3_PNL TL_RULE_ELEM4_PNL TL_RULE_ELEM5_PNL	Create user-defined values that the system can evaluate during the Time Administration process.

## Rule Element 1 through Rule Element 5 Pages

Use the Rule Element 1 through Rule Element 5 pages (TL\_RULE\_ELEM1\_PNL, TL\_RULE\_ELEM2\_PNL, TL\_RULE\_ELEM3\_PNL, TL\_RULE\_ELEM4\_PNL, TL\_RULE\_ELEM5\_PNL) to create user-defined values that the system can evaluate during the Time Administration process.

Navigation:

**Set Up HCM > Product Related > Time and Labor > Time Reporting > Rule Element 1 through Rule Element 5 > Rule Element 1 through Rule Element 5**

This example illustrates the fields and controls on the Rule Element 1 page. You can find definitions for the fields and controls later on this page.

The screenshot shows the 'Rule Element 1' configuration page. At the top, it displays 'Rule Element 1 KWORK'. Below this is the 'Element Information' section, which contains several fields and controls:

- Effective Date:** A date field set to 01/01/1980 with a calendar icon.
- Status:** A dropdown menu currently set to 'Active', with '+' and '-' icons for expansion.
- Description:** A text input field containing 'Store Closing Work'.
- Short Description:** A text input field containing 'Store Clos'.

Navigation controls at the top right of the 'Element Information' section include 'Find | View All', 'First', '1 of 1', and 'Last'.

**Note:** If you want to relabel the rule element fields, see the instructions in your PeopleTools PeopleBook.

## Specifying Table Access

To specify table access, use the Working Tables (TL\_TA\_WORK) component.

Before creating rules using actions and conditions or SQL Objects, identify the tables (or records) to access and the actions to allow or prevent on these tables. This task consists of granting access to tables in Time and Labor and Human Resources.

## Page Used to Grant SQL Access to Tables

<i>Page Name</i>	<i>Definition Name</i>	<i>Usage</i>
<u>Working Tables Page</u>	TL_TA_WORK_PNL	Grant SQL access to tables in the Time and Labor and Human Resources systems.

## Working Tables Page

Use the Working Tables page (TL\_TA\_WORK\_PNL) to grant SQL access to tables in the Time and Labor and Human Resources systems.

Navigation:

**Set Up HCM > System Administration > Utilities > Build Time and Labor Rules > Working Tables > Working Tables**

This example illustrates the fields and controls on the Working Tables page. You can find definitions for the fields and controls later on this page.

Working Tables								Personalize	Find	View 100	First	1-6 of 316	Last
*Record (Table) Name	Allow Deletes	Allow Inserts	Allow Select	Allow Updates	AE State Record	Time Admin Runtime Table	Clear in Program						
EMPLOYMENT	<input type="checkbox"/>	<input type="checkbox"/>	<input checked="" type="checkbox"/>	<input type="checkbox"/>	<input type="checkbox"/>	<input type="checkbox"/>							
HOLIDAY_TBL	<input type="checkbox"/>	<input type="checkbox"/>	<input checked="" type="checkbox"/>	<input type="checkbox"/>	<input type="checkbox"/>	<input type="checkbox"/>							
INSTALLATION	<input type="checkbox"/>	<input type="checkbox"/>	<input checked="" type="checkbox"/>	<input type="checkbox"/>	<input type="checkbox"/>	<input type="checkbox"/>							
JOB	<input type="checkbox"/>	<input type="checkbox"/>	<input checked="" type="checkbox"/>	<input checked="" type="checkbox"/>	<input type="checkbox"/>	<input type="checkbox"/>							
PERSONAL_DT_FST	<input type="checkbox"/>	<input type="checkbox"/>	<input checked="" type="checkbox"/>	<input type="checkbox"/>	<input type="checkbox"/>	<input type="checkbox"/>							
SCH_ADHOC_DTL	<input type="checkbox"/>	<input type="checkbox"/>	<input checked="" type="checkbox"/>	<input type="checkbox"/>	<input type="checkbox"/>	<input type="checkbox"/>							

The tables listed in the **Record (Table) Name** column are the records and tables to which you can grant (or deny) SQL access. Although we have predefined access to many tables in the Time and Labor system, you can change the delivered settings and can insert new rows for additional tables that you must access within your rules. All tables in the HCM system are available for rules development. The only tables you do not have access to are PeopleTools tables.

## SQL Action Elements

<i>Field or Control</i>	<i>Description</i>
SQL Access Delete	<p>Select to delete a field or row in the table listed in the <b>Record (Table) Name</b> field.</p> <hr/> <p><b>Note:</b> If you use an Expression Text field to write free-form SQL, you can delete a table even though the table is defined with <b>SQL Access Delete</b> turned off on the Working Tables page.</p>



<i>Field or Control</i>	<i>Description</i>
SQL Access Insert	Select to insert rows in the table listed in the <b>Record (Table) Name</b> field.
SQL Access Select	Select to select fields in the table listed in the <b>Record (Table) Name</b> field.
SQL Access Update	Select to update rows in the table listed in the <b>Record (Table) Name</b> field.

## Additional Elements

<i>Field or Control</i>	<i>Description</i>
<b>AE State Record</b> (application engine state record)	<p>The check boxes in the <b>AE State Record</b> column enable you to specify which AE state records rules developers can access when they create SQL objects. If a state record does not exist on the Working Tables page, it won't be available in the edit tables on the SQL Objects pages.</p> <hr/> <p><b>Note:</b> The Working Tables page is delivered with many AE state records already available for use in SQL objects. If you create new AE state records, enter rows for these records on the Working Tables page and specify those to make available in your SQL objects.</p> <hr/>
<b>Time Admin Runtime Table</b> (time administration runtime table)	<p>The check boxes in the <b>Time Administration Runtime</b> column enable you to specify temporary (working) tables used by the Time Administration batch process and enable you to use the Truncate step within a rule to clear out the content of the table. Only tables defined as temporary tables in Application Designer allow activation of this setting.</p> <hr/> <p><b>Note:</b> The Working Tables page is delivered with the runtime tables for Time Administration preselected for deletion. If you create new runtime tables, you must enter rows for these tables on the Working Tables page.</p> <hr/>
<b>AE Program</b> (application engine program)	<p>This legacy product setting identifies the tables that are being cleared, or truncated, at the start of processing for each rule program used in a single Time Administration run. There is generally no need to enter an application engine program name as long as each rule correctly clears the temporary run time tables.</p>

<i><b>Field or Control</b></i>	<i><b>Description</b></i>
<b>Load Record Fields</b>	<p>If you add new records (tables) to the Working Tables page, click the <b>Load Record Fields</b> button to access specific fields in these records when creating rules in actions and conditions or SQL objects. If you enter new records on the Working Tables page but forget to click <b>Load Record Fields</b>, the fields won't appear in the prompt tables on the Actions and Conditions or SQL Objects pages.</p> <hr/> <p><b>Warning!</b> If you create new records in Time Administration, you must add them to the Working Tables page and grant the appropriate level of access. Otherwise, the system does not know that they exist, and you can't access them in the rules.</p>

### Working Tables

All working tables that are truncated during batch processing must be identified on the Working Tables page and marked as Time Administration Runtime tables. If a runtime table is not listed in the Working Tables page and is not defined for deletion, it isn't truncated during the batch run. The Working Tables page is delivered with the PeopleSoft-delivered runtime tables for Time Administration preselected for deletion (truncation). If you create new runtime tables, enter rows for these tables on the Working Tables page and specify the AE program that they belong to.

## Defining Table Relationships

To define table relationships, use the Relationship Definitions (TL\_RELATIONSHIP) component.

Defining table relationships consists of joining fields on different record tables.

### Page Used to Define Table Relationships

<i><b>Page Name</b></i>	<i><b>Definition Name</b></i>	<i><b>Usage</b></i>
<u>Relationship Definitions Page</u>	TL_RELATIONSHIP	Create relationships between tables.

### Relationship Definitions Page

Use the Relationship Definitions page (TL\_RELATIONSHIP) to create relationships between tables.

Navigation:

**Set Up HCM > System Administration > Utilities > Build Time and Labor Rules > Relationship Definitions > Relationship Definitions**

This example illustrates the fields and controls on the Relationship Definitions page. You can find definitions for the fields and controls later on this page.

**Relationship Definitions**

---

**Relationship Information**

<p>Left Record: <b>JOB</b></p> <p>Record Description: <b>EE Job History</b></p> <p>Join Field 1: <input type="text" value="UNION_CD"/> </p> <p>Join Field 2: <input type="text"/> </p> <p>Join Field 3: <input type="text"/> </p> <p>Join Field 4: <input type="text"/> </p> <p>Join Field 5: <input type="text"/> </p>	<p>Right Record: <b>UNION_TBL</b></p> <p>Record Description: <b>Unions</b></p> <p>To Field 1: <input type="text" value="UNION_CD"/> </p> <p>To Field 2: <input type="text"/> </p> <p>To Field 3: <input type="text"/> </p> <p>To Field 4: <input type="text"/> </p> <p>To Field 5: <input type="text"/> </p>
---	--

## Fields

<i><b>Field or Control</b></i>	<i><b>Description</b></i>
<b>Join Fields 1-5</b>	Enter the fields from each table that the system must use to create a relationship between the tables.

Define a relationship definition when you use a condition that references a field that is not part of the updated record.

## Example

If a time reporter belongs to Union 'ABC' and reports more than eight hours per day under TRC REG, change REG to DBL.

The action for this statement is:

```
UPDATE PS_TL_IPT1
SET TRC = 'DBL'
```

The two conditions for this statement are:

```
WHERE PS_TL_IPT1.TRC = 'REG'
AND PS_JOB.UNION_CD = 'ABC'
```

To identify the correct effective-dated row and sequence from the JOB table, we would need several additional lines of code comparing the employee IDs, employee record numbers, and dates in the TL\_IPT1 and JOB tables. Setting up a relationship definition eliminates the need to code this relationship individually.

---

## Defining Template-Built Rules

To define template-built rules, use the Template-Built Rules (TL\_TA\_RULE\_TMPLT) component.

Time and Labor delivers more than 40 rule templates. Use templates to create a variety of rules for the Time Administration program to execute when processing reported or scheduled time. You can create compensation rules for overtime and holidays, notification rules for irregular attendance, and rules for other time-reporting situations that require special processing.

Rules consist of condition and action statements. When using a template to create a rule, enter values for the variables within the template's condition and action statements. For example, to pay overtime when a time reporter reports more than 40 hours per week, you might use one of the Period Threshold templates to create the rule. The rule text of Template020 says:

"When a time reporter reports time under time reporting code *a* and the sum of hours is greater than *b* in the specified period *c*, then all hours in excess of *b* will be paid using TRC *d*."

To create a rule, open Template020, enter values for variables *a*, *b*, *c*, and *d*, and then save the new rule with a unique rule ID. Add the rule to a rule program on the Rule Programs page and assign the rule program to a workgroup.

## Rules Created with Templates

After you save a template-built rule and include it in a rule program, you cannot change the values in the action or condition statements. However, you can modify rules by changing the actions or conditions (not simply the values within the conditional clauses), or by defining your own SQL Objects.

Before you modify a template-built rule, you need to understand how the values you have defined are stored and accessed. When you save your rule with a unique rule ID, the rule is compiled and the values you entered are stored in the record TL\_TMPLT\_RULE2, replacing a generic *rule parameter* in the template called %RuleTemplate(), which acts as a placeholder for each variable you defined. (A rule parameter is a variable that is substituted with a user-defined value when a template-built rule is compiled.) The record TL\_TMPLT\_RULE2 tracks the values that will be resolved in each rule step by rule ID. Because the same rule parameter represents all the values you define in a template-built rule, and there may be multiple instances of %RuleTemplate() in a single rule and in a single rule step, the record TL\_TMPLT\_RULE2 identifies the different occurrences of %RuleTemplate by step and sequence number.

You have several options for modifying a rule you have defined using the Define Template-Built Rules component:

1. Copy the rule and name a new rule using the Copy Rules page. When you copy the rule, however, you need to change the AE section to represent the new rule. In addition, for every occurrence of %RuleTemplate(), you need to substitute actual values by defining your own SQL Objects. The reason for this is that the connection is broken between the original rule ID and the values stored in the record TL\_TMPLT\_RULE2.
2. Modify the existing rule using the Define Rules component by changing one of the rule steps, or by adding a new step or substituting a different SQL object or action and condition in place of one originally created from the rule template. You must then compile this new rule. However, if you customize a rule in this way, the only way to view or make future changes to the rule is to use the Define Rules component; you can no longer access the rule through the Define Template-Built Rules component.

Although this modification may not break the connection between the rule and the values contained in TL\_TMPLT\_RULE2, we recommend that you do not rely on this connection, but instead do the following:

- To add a new step to a rule or change an existing step or object, hard code the values you want to use in that step (replace %RuleTemplate() with actual values), and recompile the rule.
- To delete a step, recompile the rule; you do not need to worry about the connection being broken.

---

**Note:** When modifying a rule, always test the rule to make sure that it functions as you expect.

---

3. Create a new rule ID from the same rule template, modify this rule using the Define Rules component, and compile the new rule. In this way, you retain the original rule, and have a newly modified rule to work with.

---

**Note:** To change a rule that is already in a rule program, temporarily remove the rule from the rule program before changing it. After changing the rule, reassociate the rule to a rule program. This safeguard protects the integrity of the data generated by the original rule. After saving the new rule, be sure to update the appropriate rule program.

---

### Example: Multiple Jobs and Rules

This example shows a Daily Overtime Rule and a Period Threshold rule, and shows how the overtime hours for *all* jobs are calculated:

Daily Overtime: The system totals the overtime for the day, checks where the threshold falls, and applies it to the job accordingly.

---

**Note:** In this example, overtime is defined as any time over eight hours.

---

<i>Empl Rcd #</i>	<i>Reported Hours</i>	<i>Overtime</i>
0	0	0
1	5	0
2	2	0
3	3	2

Weekly Overtime:

---

**Note:** In this example, overtime is defined as any time over 40 hours.

---

<i>Empl Rcd #</i>	<i>Monday</i>	<i>Tuesday</i>	<i>Wednesday</i>	<i>Thursday</i>	<i>Friday</i>
0			2	8	

<b>Empl Rcd #</b>	<b>Monday</b>	<b>Tuesday</b>	<b>Wednesday</b>	<b>Thursday</b>	<b>Friday</b>
1			8	2	
2	5	5		5	
3	3	3			9
Total Hours	8	8	10	15	9

### Delivered Templates

The following tables list the rule templates delivered with Time and Labor. They are presented alphabetically by template type. The possible variables are in uppercase letters.

The *Combine Data?* heading identifies whether the Time Administration process combines the results for time reporters with multiple jobs. Results are combined only if each job (employee record) is in the same workgroup. (The employee records do not need to be in the same run of the Time Administration process to be combined.)

The Punch, Elapsed or Both Column indicates whether the rule template applies to punch time reporters, elapsed time reporters or both types of time reporters.

### Accumulator Templates

<b>Name</b>	<b>Description or Example</b>	<b>Rule</b>	<b>Combine Data?</b>	<b>Punch, Elapsed, or Both</b>
Template 510	<p>Determines if overtime hours exceeds a specified value. (Create or Replace.)</p> <p>This template is not available for online rules.</p>	<p>When a time reporter reports time under TRC (s) (1)SPECIFIED _TRCs and the sum of hours from ((1)SPECIFIED _TRCs + Accumulator TRC (2)SPECIFIED _ACCUMULATOR) is in the (3)SPECIFIED _PERIOD period, and is greater than (4)SPECIFIED _HOURS hours, then all hours in excess of (4)SPECIFIED _HOURS will be paid under (5)SPECIFIED _TRC TRC.</p>	Y	Both

<b>Name</b>	<b>Description or Example</b>	<b>Rule</b>	<b>Combine Data?</b>	<b>Punch, Elapsed, or Both</b>
Template 520	<p>Inserts the sum of selected TRCs into the Accumulator table (TL_IPT1_CNT). If you include more than one rule that updates the same TRC in the same rule program, the system overwrites the accumulator value each time it is resolved.</p> <p>On the Template Header page, the default setting for the Time Period ID field is "NONE."</p> <p>This template is not available for online rules.</p>	<p>When a time reporter reports time under TRC (s) (1)SPECIFIED _TRCs, then store the sum of hours into the (2)SPECIFIED _ACCUMULATOR Accumulator TRC.</p>	Y	Both
Template 540	<p>Loads a value from the Accumulator table to the specified TRC (see Template 520 for more information). Rules created with this template should not be used alone. For example, you might execute the rule before applying a rule created with template 020.</p> <p>On the Template Header page, the default setting for the Time Period ID field is "NONE."</p> <p>This template is not available for online rules.</p>	<p>Load (1)SPECIFIED _ACCUMULATOR Accumulator TRC from the Accumulator Table (TL_IPT1_CNT) into the Rules working table (TL_IPT1) for processing.</p>	N	Both

<b>Name</b>	<b>Description or Example</b>	<b>Rule</b>	<b>Combine Data?</b>	<b>Punch, Elapsed, or Both</b>
Template 550	<p>Similar to Period Threshold Template 020, but the threshold is determined by another TRC List.</p> <p>This template is not available for online rules.</p>	<p>When the hours of Accumulator TRC (1)SPECIFIED_ACCUMULATOR are greater than the hours of Accumulator TRC (2)SPECIFIED_ACCUMULATOR, in the specified period (3)SPECIFIED_PERIOD, then all hours in excess of Accumulator TRC (2)SPECIFIED_ACCUMULATOR will be paid under (4)SPECIFIED_TRC TRC. The value of Accumulator TRC (2)SPECIFIED_ACCUMULATOR is the threshold for comparison.</p>	Y	Both

### Approval Required Template

<b>Name</b>	<b>Description or Example</b>	<b>Rule</b>	<b>Combine Data?</b>	<b>Punch, Elapsed or Both</b>
Template 180	<p>All time reported to specific TRC or TRC list requires manager approval before being paid.</p> <p>This template is not available for online rules.</p>	<p>All time reported to TRCs (1)SPECIFIED_TRC or (2)SPECIFIED_TRC_LIST requires manager approval prior to being paid.</p> <p>Use this template to require approval for time reported to a specific TRC or list of TRCs, rather than for an entire workgroup.</p>	N	Both



## Attendance Templates

<b>Name</b>	<b>Description or Example</b>	<b>Rule</b>	<b>Combine Data?</b>	<b>Punch, Elapsed or Both</b>
Template 360	If a time reporter doesn't report SICK for x number of days, create y hours of compensatory time.	If an elapsed time reporter doesn't report time to TRC (1)SPECIFIED_TRC for (2)SPECIFIED_DURATION days, create (3)SPECIFIED_HOURS hours of TRC (4)SPECIFIED_TRC.  Use this template to compensate employees reporting elapsed time for perfect attendance.	N	Elapsed
Template 360A	If a time reporter doesn't report any attendance violations for x number of days, create y hours of a TRC.	If a punch time reporter doesn't record an attendance violation for (1)SPECIFIED_NUMBER_OF_DAYS days, then create (2)SPECIFIED_HOURS hours of TRC (3)SPECIFIED_TRC for perfect attendance compensation.  Use this template to compensate employees reporting punch time for perfect attendance.	N	Punch

<b>Name</b>	<b>Description or Example</b>	<b>Rule</b>	<b>Combine Data?</b>	<b>Punch, Elapsed or Both</b>
Template 360B	If a time reporter doesn't report any attendance violations or report SICK for x number of days, create y hours of a TRC.	If a time reporter doesn't report time to TRC (1)SPECIFIED_TRC for (2)SPECIFIED_DURATION days, create (3)SPECIFIED_HOURS hours of TRC (4)SPECIFIED_TRC.  Use this template to compensate employees reporting elapsed time or punch time for perfect attendance.	N	Both

### Consecutive Days Templates

<b>Name</b>	<b>Description or Example</b>	<b>Rule</b>	<b>Combine Data?</b>	<b>Punch, Elapsed or Both</b>
Template 110	If a time reporter works x consecutive days, then all hours on day x pay specific TRC. (Create or replace.)	When a time reporter reports more than (1)SPECIFIED_HOURS hours under TRCs (2)SPECIFIED_TRC_LIST in a day for (3)SPECIFIED_DURATION consecutive days, then all time reported for day (3)SPECIFIED_DURATION will be paid under TRC (4)SPECIFIED_TRC.	Y	Both

<b>Name</b>	<b>Description or Example</b>	<b>Rule</b>	<b>Combine Data?</b>	<b>Punch, Elapsed or Both</b>
Template 111	If a time reporter works x consecutive days, then all hours < 8 on the seventh day are paid specific TRC, while all hours > 8 on the seventh day are paid another specified TRC. (California 7 Day Rule.) (Create or replace.)	When a time reporter works seven consecutive days in the state of California and reports time under TRCs (1)SPECIFIED_TRC_LIST in a given workweek, the first 8.0 hours worked on the seventh day are paid as overtime (time and a half) under TRC (2)SPECIFIED_TRC1, while hours worked on the seventh day in excess of 8.0 are paid as double time under TRC (3)SPECIFIED_TRC2.	Y	Both
Template 120	If a time reporter works x consecutive days, then all hours on days >= x pay specific TRC. (Create or replace.)	When a time reporter reports more than (1)SPECIFIED_HOURS hours in a day under TRCs (2)SPECIFIED_TRC_LIST for (3)SPECIFIED_DURATION consecutive days, then all time reported for day (3)SPECIFIED_DURATION is paid under TRC (4)SPECIFIED_TRC.	Y	Both

### Daily Threshold Template

<b>Name</b>	<b>Description or Example</b>	<b>Rule</b>	<b>Combine Data?</b>	<b>Punch, Elapsed or Both</b>
Template 010	Pay overtime for all hours in a day > x. (Create or replace.)	When a time reporter reports time under TRCs (1)SPECIFIED_TRCs and the sum of hours is greater than (2)SPECIFIED_HOURS hours in a day, then all hours in excess of (2)SPECIFIED_HOURS are paid under (3)SPECIFIED_TRC TRC.	Y	Both
Template 015	Pay Overtime for all hours worked before the 24 hrs cycle with yesterday's first IN punch (Puerto Rico overtime) (Create or replace)	When a Time Reporter reports the first IN Punch for the day, earlier than the day before, the time difference that makes up to a 24 hrs day cycle will be paid under the specified TRC.	Y	Only IN Punch

### Default Template

<b>Name</b>	<b>Description or Example</b>	<b>Rule</b>	<b>Combine Data?</b>	<b>Punch, Elapsed or Both</b>
Template 130	Replace all hours reported without a time reporting code to x.	Assigns any hours without a TRC to TRC (1)SPECIFIED_TRC.	N	Both
Template 135	Replace or remove the Time Reporting Code for the indicated punch types with the specified TRC. Only an hours type TRC can be chosen for this rule.	Replaces the Time Reporting Code (TRC) entered with the specified hours type TRC: (1) PUNCH_TYPE:SPECIFIED_TRC	N	Punch

### Exception Templates

<b>Name</b>	<b>Description or Example</b>	<b>Rule</b>	<b>Combine Data?</b>	<b>Punch, Elapsed or Both</b>
Template 140	If a time reporter reports hours > x, then create an exception.	<p>Create exception (1)SPECIFIED_EXCEPTION when a time reporter reports more than (2)SPECIFIED_HOURS total hours of TRCs (3)SPECIFIED_TRC_LIST for a day.</p> <p>Use this template to warn a manager when time reporters are reporting an excessive number of hours.</p> <p>The results for multiple jobs combine to Empl Rcd 0 for rule evaluation.</p>	Y	Both
Template 150	If a time reporter reports x overtime hours for a period, then create an exception.	<p>Create exception (1)SPECIFIED_EXCEPTION when a time reporter reports more than (2)SPECIFIED_HOURS total hours of (3)SPECIFIED_TRC_LIST during the rule period.</p> <p>Use this template to warn that a time reporter is approaching overtime for the specified period.</p> <p>The results for multiple jobs combine to Empl Rcd 0 for rule evaluation.</p>	Y	Both

<b>Name</b>	<b>Description or Example</b>	<b>Rule</b>	<b>Combine Data?</b>	<b>Punch, Elapsed or Both</b>
Template 210	If a time reporter reports x minutes past scheduled start time, create an exception.	When a time reporter punches IN more than (1)SPECIFIED_MINUTES minutes after their scheduled IN punch, generate exception (2)SPECIFIED_EXCEPTION_ID.	N	Punch
Template 230	Create an exception when time is reported and the employee's status is in the following list ('Deceased', 'Terminated', 'Suspended',...)	Create exception (1)SPECIFIED_EXCEPTION_ID when time is reported and the employee status is in the following list (2)SPECIFIED_EMPLOYEE_STATUS_LIST.	N	Both
Template 240	Valid punch types to follow a punch type.*	<p>When a punch type of (1)SPECIFIED_PUNCH_TYPE is followed by one of the following punch types (2)SPECIFIED_LIST_OF_PUNCH_TYPES, generate exception (3)SPECIFIED_EXCEPTION_ID.</p> <p>This rule ensures that time reporters report their clock time in correct punch type sequence. (For example, an IN punch must always follow an OUT punch, and so on. ) You could use this rule in conjunction with Exception Template 250.</p>	N	Punch

<b>Name</b>	<b>Description or Example</b>	<b>Rule</b>	<b>Combine Data?</b>	<b>Punch, Elapsed or Both</b>
Template 250	Create an exception if a time reporter reports x minutes > threshold for specified PUNCH_TYPE.*	<p>When a time reporter reports more than (2)SPECIFIED_HOURS hours for the following punch types (3)SPECIFIED_PUNCH_TYPE, create exception (1)SPECIFIED_EXCEPTION.</p> <p>This rule ensures that a time reporter has no missing punches. For example, if time reporters never have more than 10 hours associated to an IN punch (because of meals, breaks, and so on), then create a rule that creates an exception when an IN punch &gt; 10 hours.</p>	N	Punch
Template 280	If a time reporter works x number of hours without a break, create an exception.	<p>When a time reporter works more than (1)SPECIFIED_DURATION hours without a break, create exception (2)SPECIFIED_EXCEPTION.</p> <p>Use this template to inform managers if time reporters are working too many hours without a break.</p>	Y	Punch

<b>Name</b>	<b>Description or Example</b>	<b>Rule</b>	<b>Combine Data?</b>	<b>Punch, Elapsed or Both</b>
Template 300	Average hours per week threshold. Weekly rolling period.	<p>When a time reporter reports time under TRCs (1)SPECIFIED _TRC_LIST more than (2)SPECIFIED_AVERAGE_HOURS hours per week during the last (3)SPECIFIED _NUMBER_OF _WEEKS weeks, create exception (4)SPECIFIED_EXCEPTION_ID.</p> <p>Template 300 must have a weekly rolling period ID assigned. (For example, first period is week 1 through week 10, second period is week 2 through week 11, and so on).</p>	Y	Both



<b>Name</b>	<b>Description or Example</b>	<b>Rule</b>	<b>Combine Data?</b>	<b>Punch, Elapsed or Both</b>
Template 310	Average hours per week threshold. Daily rolling period.	<p>When a time reporter reports time under TRCs (1)SPECIFIED _TRC_LIST more than (2)SPECIFIED_AVERAGE_HOURS hours per week during the last (3)SPECIFIED _NUMBER_OF _WEEKS weeks, create exception (4)SPECIFIED_EXCEPTION_ID.</p> <p>This template will have a Daily rolling period ID assigned. For example, first period is day one of week 1 through day seven of week 10; second period is day two of week 1 through day one of week 11 and so on.</p>	Y	Both
Template 320	Night work limits.	<p>When the average number of hours worked per day between (1)SPECIFIED_START_TIME and (2)SPECIFIED_END_TIME reported under TRCs (3)SPECIFIED _TRC_LIST is greater than (4)SPECIFIED_HOURS hours during the last (5)SPECIFIED _NUMBER_OF _WEEKS weeks, create exception (6)SPECIFIED_EXCEPTION_ID.</p>	Y	Punch

<b>Name</b>	<b>Description or Example</b>	<b>Rule</b>	<b>Combine Data?</b>	<b>Punch, Elapsed or Both</b>
Template 330	Weekly rest period.	When the number of hours for an uninterrupted rest period in a period is less than (1)SPECIFIED_HOURS hours, create exception (2)SPECIFIED_EXCEPTION_ID.	N	Punch
Template 340	Daily rest period.	When the number of hours between shifts (daily rest period) is less than (1)SPECIFIED_HOURS hours, create exception 2)SPECIFIED_EXCEPTION_ID..	N	Punch
Template 350	In-work rest period.	When a time reporter worked at least (1)SPECIFIED_HOURS hours per day and did not take at least a total of (2)SPECIFIED_MINUTES minutes break, then create exception (3)SPECIFIED_EXCEPTION_ID.	N	Punch

<b>Name</b>	<b>Description or Example</b>	<b>Rule</b>	<b>Combine Data?</b>	<b>Punch, Elapsed or Both</b>
Template 400	Minors may not work hours > 18 in a week or hours > three in a day when school is in session. Minors may not work hours > 40 in a week or hours > 8 in a day when school is not in session.	<p>Create exception (1)SPECIFIED_EXCEPTION when minors between the ages of 14 and 16 work more than (2)SPECIFIED_HOURS hours in the period (3)SPECIFIED_PERIOD (day, week, month) and school is in or out of session between (4)SPECIFIED_DATE1 and (5)SPECIFIED_DATE2.</p> <p>Use this FLSA rule for minors when school is in and out of session. The period for the rule is defined in the template header. When using this template, it is recommended that an In Session rule and an Out of Session rule are created and added to the rule program to provide the system with the school in session dates required to properly evaluate minors' reported time.</p> <hr/> <p><b>Note:</b> Update this rule annually for traditional schools and possibly quarterly for year-round schools.</p> <hr/>	N	Both

<b>Name</b>	<b>Description or Example</b>	<b>Rule</b>	<b>Combine Data?</b>	<b>Punch, Elapsed or Both</b>
Template 430	<p>If a time reporter reports vacation time on a day that is in a future period, create an exception.</p> <p>This template is not available for online rules.</p>	<p>Create exception (1)SPECIFIED_EXCEPTION when a time reporter reports TRCs (2)SPECIFIED_TRC for a future period.</p>	N	Both

\*When an OUT punch is missing for a day, the system does not know if the current shift should extend into the next day or end on the current day. As a result, the following work day cannot be processed correctly in Time Administration, as it does not know how to process the following day. It can look as if there is an improper order of punches (IN from the last work day, and an IN on the current work day, without an OUT, BREAK or MEAL punch in the middle.) Use Exception Rule Template 250 to trigger an exception when a particular punch type exceeds a certain number of hours, such as an IN punch. Use Exception Rule Template 240 to trigger an exception for an invalid order of punch types. Alternatively, you can create a custom rule to insert an OUT punch for a day in Reported Time, if one is missing, after "x" hours has passed.

### Guaranteed Hours Templates

<b>Name</b>	<b>Description or Example</b>	<b>Rule</b>	<b>Combine Data?</b>	<b>Punch, Elapsed or Both</b>
Template 030	<p>If a time reporter reports hours on a nonscheduled day, then they are guaranteed x number of hours.</p>	<p>When a time reporter reports hours to TRCs (1)SPECIFIED_TRCs on an unscheduled day, and the sum of reported hours is (2)SPECIFIED_OPERATOR (3)SPECIFIED_HOURS hours, then replace the reported number of hours with (4)SPECIFIED_HOURS hours.</p> <p>Use this template for Guaranteed Hours rules.</p>	Y	Both

<b>Name</b>	<b>Description or Example</b>	<b>Rule</b>	<b>Combine Data?</b>	<b>Punch, Elapsed or Both</b>
Template 031	If a time reporter reports a specific number of hours to a specific TRC, then they are guaranteed x number of hours.	When a time reporter reports hours to TRCs (1)SPECIFIED_TRCs, and the sum of reported hours is (2)SPECIFIED_OPERATOR_OPERATOR (3)SPECIFIED_HOURS hours, then replace the reported number of hours with (4)SPECIFIED_HOURS hours.  You can use this template to pay a guaranteed number of hours to a time reporter.	Y	Both

### Holiday Templates

For proper evaluation of all holiday rules, use a time period that is greater than one day for the rule.

**Note:** For all "create" holiday rules, the system will create holiday pay in addition to reported or scheduled time. For all "replace" construct holiday rules, only scheduled time will be replaced with holiday pay. Any reported time will not be replaced with holiday pay.

<b>Name</b>	<b>Description or Example</b>	<b>Rule</b>	<b>Combine Data?</b>	<b>Punch, Elapsed or Both</b>
Template 060	Pay all time reporters HOL for a holiday (Create or replace).  <b>Note:</b> Use the Always option in a Template 060 rule to ensure that the system creates payable time for the employee, whether or not the employee has reported time for a holiday.	Pay the following time reporters (1)SPECIFIED_EMPLOYEE_TYPE (2)SPECIFIED_HOURS hours of TRC (3)SPECIFIED_TRC for holiday pay.  Use this template to pay holiday pay to all time reporters.	N	Both

<b>Name</b>	<b>Description or Example</b>	<b>Rule</b>	<b>Combine Data?</b>	<b>Punch, Elapsed or Both</b>
Template 061	<p>Pay all time reporters HOL for a holiday. (Create or replace.)</p> <hr/> <p><b>Note:</b> Note: Use the Always option in a Template 061 rule to ensure that the system creates payable time for the employee, whether or not the employee has reported time for a holiday.</p> <hr/>	<p>Pay the following Time Reporters                      (1)SPECIFIED_EMPLOYEE_TYPE (2)Holiday Calendar hours of TRC                      (2)SPECIFIED_TRC for holiday pay.</p>	N	Both
Template 070	<p>Pay HOL for a holiday only if a time reporter worked the day before and the day after the holiday. (Create or replace.)</p>	<p>Pay the following time reporters                      (1)SPECIFIED_EMPLOYEE_TYPE                      (2)SPECIFIED_HOURS hours of TRC                      (3)SPECIFIED_TRC for holiday pay if they work the day before AND the day after the holiday.</p> <p>Use this template to pay holiday pay to all time reporters based on their attendance around the holiday.</p>	N	Both

<b>Name</b>	<b>Description or Example</b>	<b>Rule</b>	<b>Combine Data?</b>	<b>Punch, Elapsed or Both</b>
Template 071	<p>Pay HOL for a holiday only if a time reporter worked the day before or the day after the holiday. (Create or replace.)</p> <hr/> <p><b>Note:</b> For all "create" holiday rules, the system will create holiday pay in addition to reported or scheduled time. For all "replace" construct holiday rules, only scheduled time will be replaced with holiday pay. Any reported time will not be replaced with holiday pay.</p> <hr/>	<p>Pay the following time reporters                      (1)SPECIFIED_EMPLOYEE_TYPE                      (2)SPECIFIED_HOURS hours of TRC                      (3)SPECIFIED_TRC for holiday pay if they work the day before OR the day after the holiday.</p> <p>Use this template to pay holiday pay to all time reporters based on their attendance around the holiday.</p>	N	Both
Template 080	<p>If a time reporter works on a holiday, create X pay premium for each hour reported. (Create or replace.)</p>	<p>When the following time reporters                      (1)SPECIFIED_EMPLOYEE_TYPE report hours on a holiday, pay an additional                      (2)SPECIFIED_HOURS hour(s) of TRC (3)SPECIFIED_TRC for premium pay, based on each hour reported to (4)TRC .</p> <p>Use this template to pay a premium for hours worked to all time reporters who work on a holiday.</p>	N	Both

<b>Name</b>	<b>Description or Example</b>	<b>Rule</b>	<b>Combine Data?</b>	<b>Punch, Elapsed or Both</b>
Template 420	Pay part-time time reporters x hours of holiday pay where x is = AVG (hours worked per day) for specified period.	<p>Pay part-time time reporters the average hours worked per day during the specified period using TRC (1)SPECIFIED_TRC.</p> <p>The period ID selected for this rule should have an end date that falls on the holiday. For example, to pay holiday pay for 1/1/2005 based on average hours worked for the past two months, the period ID should be 11/1/2004 through 1/1/2005.</p>	N	Both



### Meal Template

<b>Name</b>	<b>Description or Example</b>	<b>Rule</b>	<b>Combine Data?</b>	<b>Punch, Elapsed or Both</b>
Template 160	If a punch time reporter works more than x number of hours, then deduct y hours for meal.	<p>When a punch time reporter reports at least (1)SPECIFIED_HOURS hours in a day and no meal is reported, create a (2)SPECIFIED_DURATION hour meal with TRC (3)SPECIFIED_TRC.</p> <p>The punch type of <i>MEAL</i> must be selected on the primary page for this rule to work properly. Use this template for automatic meal deductions. If two automeal deduct rules are created for one rule program, only one applies.</p> <p>If Meal Waiver is enabled then this rule will not replace the regular hours for meal.</p> <p>Example for Meal Waiver Calculation:</p> <p>In a typical work shift of 6 hours, from 10 AM to 4 PM, employees are entitled to a 30-minute legally mandated lunch break. If the meal break waiver option is turned off in the primary page, the payable time is calculated as 5.5 hours of regular work and 0.5 hours for the meal break.</p> <p>However, if the meal break waiver option is turned on, the payable</p>	Y	Punch

<b>Name</b>	<b>Description or Example</b>	<b>Rule</b>	<b>Combine Data?</b>	<b>Punch, Elapsed or Both</b>
		time is considered the full 6 hours of the shift, as the employee has waived their right to the 30-minute meal break. This ensures that the employee is compensated for the entirety of their scheduled work time.		

### Miscellaneous Templates

<b>Name</b>	<b>Description or Example</b>	<b>Rule</b>	<b>Combine Data?</b>	<b>Punch, Elapsed or Both</b>
Template 530	<p>Remove (1)SPECIFIED_TRC TRC from Rules working table (TL_IPT1) to ensure the TRC is not included in Payable Time.</p> <p>On the Template Header page, the default setting for the Time Period ID field is "NONE."</p> <p><i>WARNING!</i> Any TRC used in this template is not included in Payable Time and is not sent to a payroll system. This rule template is often used to clean up Accumulators that are loaded into TL_IPT1.</p> <p>This template is not available for online rules.</p>	Remove (1)SPECIFIED_TRC TRC.	N	Not applicable

<b>Name</b>	<b>Description or Example</b>	<b>Rule</b>	<b>Combine Data?</b>	<b>Punch, Elapsed or Both</b>
Template 560	<p>Performs calculations (add, subtract, multiply, or divide) between a TRC and a specified value.</p> <p>On the Template Header page, the default setting for the Time Period ID field is "NONE."</p> <p>This template is not available for online rules.</p>	Update the quantity associated with TRC (1)SPECIFIED_TRC to be equal to TRC (1)SPECIFIED_TRC (2)SPECIFIED_CALCULATION (3)SPECIFIED_VALUE.	N	Not applicable

### Missing Punch Templates

<b>Name</b>	<b>Description or Example</b>	<b>Rule</b>	<b>Combine Data?</b>	<b>Punch, Elapsed or Both</b>
Template 260	Update duration for specified PUNCH_TYPE with user-specified duration.	When a time reporter reports more than (1)SPECIFIED_DURATION hours for a (2)SPECIFIED_PUNCH_TYPE punch, then update time reported to (3)SPECIFIED_DURATION hours.	N	Punch
Template 270	Update duration for specified PUNCH_TYPE with scheduled Out punch.	When a time reporter works more than (1)SPECIFIED_DURATION hours for a (2)SPECIFIED_PUNCH_TYPE punch, then update time worked to scheduled hours.	N	Punch

### Period Threshold Templates

<b>Name</b>	<b>Description or Example</b>	<b>Rule</b>	<b>Combine Data?</b>	<b>Punch, Elapsed or Both</b>
Template 020	Pay overtime for all hours in a week > x. (Create or replace.)	When a time reporter reports time under TRCs (1)SPECIFIED_TRCs and the sum of hours is greater than (2)SPECIFIED_HOURS hours in the specified period, then all hours in excess of (2)SPECIFIED_HOURS will be paid under (3)SPECIFIED_TRC TRC.	Y	Both
Template 021	Overtime hours will be assigned to days with daily reported time greater than daily scheduled time. (Create or replace.)	When the sum of hours reported under TRC(s) (1)SPECIFIED_TRC_LIST is greater than the sum of scheduled hours in a specified period, all reported hours in excess of the period total scheduled hours will be paid as overtime under TRC (2)SPECIFIED_TRC.	Y	Both

### Premium Zone Templates

<b>Name</b>	<b>Description or Example</b>	<b>Rule</b>	<b>Combine Data?</b>	<b>Punch, Elapsed or Both</b>
Template 100	If a time reporter works between x and y o'clock, then pay premium.	When a time reporter works between (1)SPECIFIED_START_TIME and (2)SPECIFIED_END_TIME, create a shift premium only for those hours worked within the specified time, to be charged to TRC (3)SPECIFIED_TRC.	N	Punch

<b>Name</b>	<b>Description or Example</b>	<b>Rule</b>	<b>Combine Data?</b>	<b>Punch, Elapsed or Both</b>
Template 101	<p>If a time reporter works between x and y o'clock, then pay premium.</p> <p>Shift Premium Rule.</p> <p>Use this Template when you want Overtime logged to the day it occurred and you use periods with gaps in the Rule. For example, weekend only .</p>	<p>When a Time Reporter worked between (1)SPECIFIED_START_TIME and (2)SPECIFIED_END_TIME, create a shift premium for only those hours worked within the specified time, using the (3)SPECIFIED_TRC TRC. Shift premiums are assigned to the physical days when the work occurred, regardless of all Workgroup Daybreaker settings.</p>	N	Punch
Template 090	<p>If a time reporter clocks in between x and y o'clock, then pay premium.</p>	<p>When a time reporter punches IN between (1)SPECIFIED_START_TIME and (2)SPECIFIED_END_TIME, create a shift premium for all hours worked, to be charged to TRC (3)SPECIFIED_TRC.</p> <p>If the time reporter punches in within the specified time period, this rule creates a TRC for all hours worked, even when the time reporter punches out after the specified time period.</p>	N	Punch

### Schedule Deviation Templates

<b>Name</b>	<b>Description or Example</b>	<b>Rule</b>	<b>Combine Data?</b>	<b>Punch, Elapsed or Both</b>
Template 050	If a time reporter works outside of scheduled workweek, pay premium.	<p>When a time reporter reports hours on an unscheduled day, replace all reported hours with TRC (1)SPECIFIED_TRC.</p> <p>Use this template to pay a premium to employees for working outside of their regular work week.</p>	N	Both
Template 290	If a time reporter works shift other than home shift, then pay specific TRC.	<p>When a time reporter reports hours to a shift that is not their home shift, and the hours are reported to TRCs (1)SPECIFIED_TRC_LIST, then replace all the hours worked that day to TRC (2)SPECIFIED_TRC.</p> <p>When the In punch is more than (3)SPECIFIED_GRACE_EARLY minutes early or (4)SPECIFIED_GRACE_LATE minutes late, based on assigned schedule, all hours for that day's shift are assigned to TRC (2)SPECIFIED_TRC.</p> <p>The time reporter must also work at least the scheduled number of hours for this rule to be enacted.</p>	N	Punch

<b>Name</b>	<b>Description or Example</b>	<b>Rule</b>	<b>Combine Data?</b>	<b>Punch, Elapsed or Both</b>
Template440	Replace with nearest schedule.	If a time reporter reported an In punch more than (1)SPECIFIED_GRACE_EARLY minutes early or (2)SPECIFIED_GRACE_LATE minutes late, then change their schedule for the day to the schedule with the closest start time to the reported In punch, using the following list of shifts: (3)SPECIFIED_SHIFTS (with respective SetID).	N	Punch

### Shift Template

<b>Name</b>	<b>Description or Example</b>	<b>Rule</b>	<b>Combine Data?</b>	<b>Punch, Elapsed or Both</b>
Template 190	Create premium if a time reporter works specified shift.	When a time reporter is scheduled to work in one of these shifts (1)SPECIFIED_SHIFTS (with respective SetID), create a shift premium of (2)SPECIFIED_AMOUNT for each full hour worked with TRC (3)SPECIFIED_TRC.	N	Both

### Specific Day Template

<b>Name</b>	<b>Description or Example</b>	<b>Rule</b>	<b>Combine Data?</b>	<b>Punch, Elapsed or Both</b>
Template 040	If hours exist on a specific day, then replace all hours with another TRC. (Create or replace.)	When a time reporter reports hours that exceed (1)SPECIFIED_HOURS hours on (2)SPECIFIED_DAY, then replace the reported TRC with TRC (3)SPECIFIED_TRC.	Y	Both

### Task Template

<b>Name</b>	<b>Description or Example</b>	<b>Rule</b>	<b>Combine Data</b>	<b>Punch, Elapsed or Both</b>
Template 170	If a time reporter reports time for a specific TRC, then change tasks to x	When a time reporter reports time under TRC (1)SPECIFIED_TRC, then charge time to task profile (2)SPECIFIED_TASK_PROFILE  Use this template to change how time is charged when reporting a specific TRC.	N	Both

### Pages Used to Create Rules from a Template

<b>Page Name</b>	<b>Definition Name</b>	<b>Usage</b>
<u>Template Header Page</u>	TL_TEMPLATE_PNL	Define or view general information for a rule.



<b>Page Name</b>	<b>Definition Name</b>	<b>Usage</b>
<a href="#">Approval Rule Detail Page</a>	TL_TEMPLATE180_PNL	<p>Define or view what the rule does (the condition and the action).</p> <p>The page name and the object name have the suffix XXX, where XXX represents the number of the template. For example TL_TEMPLATE190_PNL. The page name is dynamic and will change depending on the template accessed.</p>

## Related Links

[Adding Rules to a Rule Program](#)

## Creating Rules from a Template

This section discusses how to:

1. Define and view general information for a rule.
2. Define the condition and action for the rule.

## Template Header Page

Use the Template Header page (TL\_TEMPLATE\_PNL) to define or view general information for a rule.

Navigation:

**Set Up HCM > Product Related > Time and Labor > Rules and Workgroups > Template-Built Rules > Template Header**

This example illustrates the fields and controls on the Template Header page. You can find definitions for the fields and controls later on this page.

The screenshot shows the 'Template Header' page for 'Approval Required' template 'TEMPLATE180'. The 'Template-Rule Information' section contains the following fields:

- \*Rule ID: KABONAPP
- \*Description: Bonus Approval KABON
- \*Period ID: PSDAY
- Short Description: Bonus App.
- \*AE Section: KABONAPP

The 'Punch Type' section includes the following options:

- Include IN Punch
- Include OUT Punch
- Include BREAK Punch
- Include MEAL Punch
- Include XFER Punch
- Include Elapsed Time

**Note:** Template-built rules are not effective-dated; however, they are associated with an effective-dated rule program.

<b>Field or Control</b>	<b>Description</b>
<b>Time Period ID</b>	<p>The time period ID determines the date range for the selection criteria of the rule. The Time Administration program also uses the time period to determine which reported time to load into the working tables during processing. (Values for the <b>Time Period ID</b> field are defined on the Time Period pages.)</p> <hr/> <p><b>Note:</b> Select the appropriate time period ID for a rule. For example, suppose that a period rule is to evaluate seven days worth of data. Ensure that the specified time period ID contains exactly seven days to produce accurate results.</p>
<b>AE Section</b>	<p>Create a name for the application engine section to assign to this rule. You can enter up to eight alphanumeric characters. The Time Administration program requires a section name for processing.</p>

## Punch Type

Select one or more punch types to apply the rule to, and select **Include Elapsed Time**, when applicable. For example, if you're creating an overtime rule, select **Include IN Punch**, **Include BREAK Punch**, and **Include XFER Punch**. When a template applies only to punch time reporters, the option to include elapsed time is unavailable.

<b>Field or Control</b>	<b>Description</b>
<b>Include IN Punch</b>	Apply this rule to In punches.
<b>Include OUT Punch</b>	Apply this rule to Out punches.
<b>Include BREAK Punch</b>	Apply this rule to Break punches.
<b>Include MEAL Punch</b>	Apply this rule to Meal punches.
<b>Include XFER Punch</b>	Apply this rule to Xfer punches.
<b>Include Elapsed Time</b>	Apply this rule to Elapsed Time.

### Use Task Profile Indicator

When defining a rule that creates rows of time, select a task profile indicator to tell the system which task-related data to associate with the new row. This feature applies only to rules that create data. The options in this region are unavailable if a rule replaces data or generates an exception.

Template020 is an example of a rule that *creates* data. It states: "When a time reporter reports time under TRCs  $x$  and the sum of hours is greater than  $y$  in a specified period  $z$ , then all hours in excess of  $y$  will be paid under TRC  $z$ . A new TRC is created for each reported TRC affected by this rule."

Template110 is an example of a rule that *replaces* data. It states: "When a time reporter reports more than  $a$  hours under TRCs  $b$  in a day for  $c$  consecutive days, then all time reported for day  $c$  will be paid under TRC  $d$ ."

We'll use Template020 and the following reported times to illustrate how each option in this region works. Assume we're creating an overtime rule that states if a person reports more than 40 hours in a week, create all hours over 40 with the TRC named OT. (The last row in this table represents the created time.)

<b>Day</b>	<b>Hours</b>	<b>Task Profile Reported</b>	<b>TRC</b>
Monday	8	A	REG
Tuesday	8	A	REG
Wednesday	10	A	REG
Thursday	8	B	REG
Friday	10	B	REG

<b>Day</b>	<b>Hours</b>	<b>Task Profile Reported</b>	<b>TRC</b>
Friday	4	Varies per your selection	OT

In this example, the time reporter crosses the 40-hour boundary on Friday, so the system creates four hours as OT. The task data that it associates with the four hours (in this case, department), depends on the selected task profile indicator:

<b>Field or Control</b>	<b>Description</b>
<b>Use Previous Row Tasks</b>	<p>Select for the system to use the task profile associated with the row of data where the condition was met.</p> <p>Example: The four hours of OT are associated with task profile B since this was the profile to which the 40<sup>th</sup> hour was reported.</p>
<b>Use Default Task Profile</b>	<p>If you select this option, the system looks at the time reporter's default task profile to determine which task-related data to associate with the new time.</p> <p>For example, suppose that the default task profile states that time should be reported to department C. In this case, the four hours of overtime are associated with department C.</p>
<b>Use Specified Task Profile</b>	<p>If you select this option, a <b>Task Profile ID</b> field appears. You can select the task profile for the system to use to determine which task-related data to associate with the new time.</p> <p>For example, suppose that we select a task profile that states that time should be reported to department A. In this case, the four hours of overtime are associated with department A.</p>
<b>Distribute Tasks Equally</b>	<p>Select for the system to first determine the percentage of time the time reporter reported to each task profile, and then use the same percentages to allocate the created time across the reported task profiles. The system distributes the tasks equally to the newly created time, based on the task profiles reported for the rule period.</p> <p>For example, of the 44 hours reported, 26 (or 60 percent) were reported to task profile A and 18 (or 40 percent) were reported to task profile B. The system allocates 60 percent of the four overtime hours (or 2.40 hours) to task profile A and 40 percent of the four overtime hours (or 1.60 hours) to task profile B.</p>

<b>Field or Control</b>	<b>Description</b>
<b>Task Profile ID</b>	This field appears only when you select the <b>Use Specified Task Profile</b> option. Select the task profile to use.

**Related Links**

[Understanding Time and Labor Implementation](#)

[Adding Rules to a Rule Program](#)

[Understanding Task Reporting Requirements](#)

**Approval Rule Detail Page**

Use the Approval Rule Detail page (TL\_TEMPLATE180\_PNL) to define or view what the rule does (the condition and the action).

Navigation:

**Set Up HCM > Product Related > Time and Labor > Rules and Workgroups > Template-Built Rules** Then, select Approval Rule Detail.

This example illustrates the fields and controls on the Approval Rule Detail page. You can find definitions for the fields and controls later on this page.

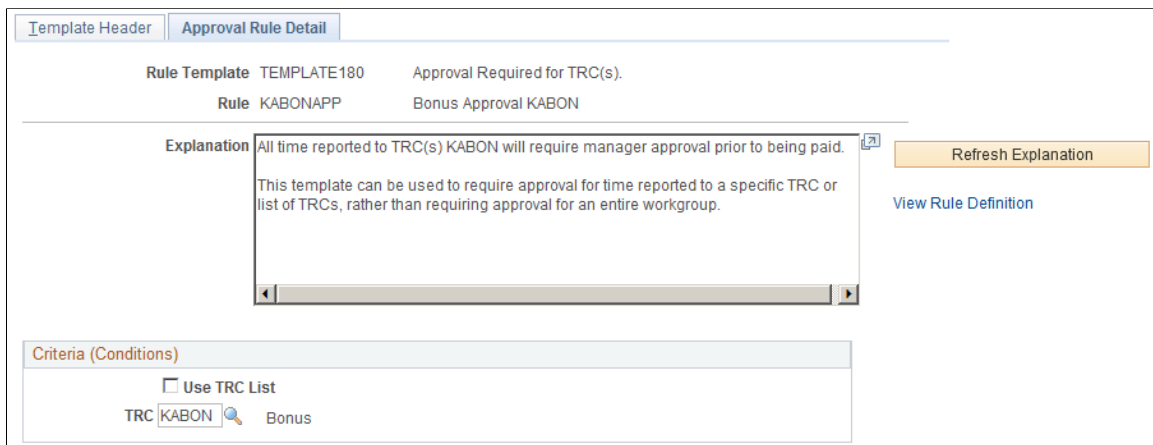

<b>Field or Control</b>	<b>Description</b>
<b>Explanation</b>	Describes the action of the rule when you run the Time Administration process. The description includes both a condition and an action.
<b>Refresh Explanation</b>	Click to see the values entered on this page inserted in the explanation of the rule as it appears in the <b>Explanation</b> field.

<b>Field or Control</b>	<b>Description</b>
<b>View Rules Definition</b>	<p>This link is available once a template-built rule is saved. It takes you to the Entering Basic Information About a Rule, which you can use to modify the conditional clause of the rule. This feature is for SQL users.</p> <p>If you use the Entering Basic Information About a Rule to modify the condition within a template-built rule, you cannot view the rule or change its values in the Template-Built Rules component. All future changes must be made on the Define Rules page.</p>

### Criteria (Conditions)

Use the fields in this region to define the exact conditions that must be met to trigger the rule. Enter a value for each of the numbered variables in the conditional clause of the explanation. The conditional clause (known as the *Where* clause in SQL), often begins with *if* or *when*. For example, the conditional clause shown contains two variables labeled (1) and (2):

If an elapsed time reporter doesn't report time to TRC (1)SPECIFIED\_TRC for (2)SPECIFIED\_DURATION days, create (3)SPECIFIED\_HOURS hours of TRC (4)SPECIFIED\_TRC. Use this template to compensate employees reporting elapsed time for perfect attendance.

<b>Variable in If Clause</b>	<b>Enter Value in This Field</b>
(1)SPECIFIED TRC	TRC or TRC List field
(2)SPECIFIED DURATION	Days

**Note:** The fields that appear in the Criteria (Conditions) region vary by template. All possible fields are listed alphabetically and described:

<b>Field or Control</b>	<b>Description</b>
<b>Conditional Operator</b>	<p>This field appears only when using a template type of Guaranteed Hours. You can select one of the following values:</p> <p>&lt; (less than)</p> <p>&lt;= (less than or equal to)</p> <p>= (equal to)</p> <p>&gt; (greater than)</p> <p>&gt;= (greater than or equal to)</p>

<b>Field or Control</b>	<b>Description</b>
<b>Daily Threshold</b>	This field appears only when using a Daily Threshold template. Enter the number of hours in the day over which the rule is triggered. For example, if you want the rule to be applied when a person reports more than 10 hours a day, enter <i>10</i> in this field. You can enter partial hours, in decimal format, in this field.
<b>Day of the Week</b>	Select the desired day of the week or enter the number that represents the day you want: Sunday = 1, Monday = 2, and so on.
<b>Days</b>	Enter a number of days in this field.
<b>Duration</b>	Enter a number of hours in this field. Use decimals for partial hours.
<b>Employee Type</b>	Select the type of time reporter to which to apply the condition. Valid values are <i>Exception Hourly</i> , <i>Hourly</i> , <i>Salaried</i> , or <i>Not Applicable</i> . (This field applies to both employees and non-employees.)
<b>Grace Minutes</b>	This field appears only when using a Schedule Deviation template. Enter a grace period, in minutes, for punching in early.
<b>Grace Minutes Late</b>	This field appears only when using a Schedule Deviation template. Enter a grace period, in minutes, for punching in late.
<b>Hours</b>	Enter a number of hours. Use decimals for partial hours.
<b>Minutes</b>	Enter a number of minutes.
<b>Number of Days</b>	Enter a number of days.
<b>Period End Date</b>	Enter an end date.
<b>Period Start Date</b>	Enter a start date.
<b>Period Threshold</b>	Enter a number or hours, units, or an amount, as applicable.

<b>Field or Control</b>	<b>Description</b>
<b>Premium Zone End</b>	Enter a start time.
<b>Premium Zone Start</b>	Enter an end time.
<b>Punch Type</b>	Enter the punch type to which the condition applies. Valid entries are <i>Elapsed, In, Out, Meal, Break, Transfer</i> .
<b>Punch Type List</b>	This field works in conjunction with the <b>Punch Type</b> field. Select a punch type list that defines which punch types can follow the punch type selected in the <b>Punch Type</b> field. For example, a punch type list may specify that only Meal and Out punches can follow an In punch. Punch type lists are defined on the Define Values List page. After you select a list, click the <b>View List</b> button to see the list of punch types included in the list.
<b>Shift List</b>	Select the appropriate shift list. Shift lists are defined on the Define Value List page. After you select a list, you can click the <b>View List</b> button to see the shifts included in the list.
<b>Time Period ID</b>	Select the appropriate time period.
<b>TRC</b>	Select the TRC that the condition applies to.
<b>TRC List</b>	If the condition applies to more than one TRC, select the TRC list that defines the set of TRCs. After you select a list, you can click the <b>View List</b> button to see which TRCs are included in the list.
<b>Use Value List</b>	Select the value list to which the condition applies. Value lists, such as shift lists, TRC lists, and employee status lists, identify a predefined set of valid codes. You can define up to 15 different types of value lists.
<b>View List</b>	The <b>View List</b> button is available only when the page contains an option for punch type list, shift list, TRC list, or use value list. Clicking it displays the contents of the selected list.

### Result (Action)

Use the fields in this region to define the action for the system to take when the condition is met. Enter a value for each of the numbered variables in the action clause of the explanation. For example, the action clause shown contains two variables labeled (3) and (4):



If an elapsed time reporter doesn't report time to TRC (1)SPECIFIED\_TRC for (2)SPECIFIED\_DURATION days, create (3)SPECIFIED\_HOURS hours of TRC (4)SPECIFIED\_TRC. Use this template to compensate employees reporting elapsed time for perfect attendance.

<b>Variable in If Clause</b>	<b>Enter Value in this Field</b>
(3)SPECIFIED HOURS	Hours
(4)SPECIFIED TRC	Time Reporting Code

**Note:** The fields that appear in the Result (Action) region vary by template. All possible fields are listed alphabetically and described:

<b>Field or Control</b>	<b>Description</b>
<b>Accumulator</b>	Select the TRC to which to assign the accumulated results of other TRCs.
<b>Doubletime TRC</b>	Select the time reporting code for double-time pay.
<b>Exception ID</b>	Select the type of exception for the system to generate when the rule is executed. Define exception IDs on the Define Exception page.
<b>Guaranteed Hours</b>	Enter a number of hours.
<b>Hours</b>	Enter a number of hours.
<b>Overtime TRC</b>	Select the TRC for overtime.
<b>Quantity</b>	Enter the number of hours or units.
<b>Rate</b>	Enter a monetary amount.
<b>Shift List</b>	Select the appropriate shift list. After you select a list, you can click the <b>View List</b> button to see the shifts included in the list.
<b>Task Profile ID</b>	Select the appropriate task profile ID.
<b>TRC</b>	Select the TRC.

<b>Field or Control</b>	<b>Description</b>
<b>View List</b>	The <b>View List</b> button is only available when the page contains an option for punch type list, shift list, TRC list, or use value list. It displays the contents of the selected list.

You can click the links at the bottom of the template page to access other pages within this component.

## Creating Rules with Actions and Conditions

To create rules with actions and conditions, use the Actions and Conditions (TL\_ACTION and TL\_CONDITIONS) components.

When you define actions and conditions in Time and Labor, you define them independently of one another, which enables you to reuse the same actions or conditions in more than one rule without having to define them again. Using actions and conditions does not require a mastery of SQL.

This section discusses how to create rules with actions and conditions.

### Pages Used to Create Rules with Actions and Conditions

<b>Page Name</b>	<b>Definition Name</b>	<b>Usage</b>
<u>Action Header Page</u>	TL_ACTION_PNL1	Define or view general information for a SQL action. Specify the action to perform (delete, insert, or update) and identify the target record (table) to perform the action on. If action type is <i>insert</i> (from another table), specify the source record (table).
<u>Action Detail Page</u>	TL_ACTION_PNL2	Create the text of your SQL action.
<u>Conditions Page</u>	TL_CONDITION2_PNL	Define or view general information for a SQL condition and create the text of a SQL condition.

### Action Header Page

Use the Action Header page (TL\_ACTION\_PNL1) to define or view general information for a SQL action.

Specify the action to perform (delete, insert, or update) and identify the target record (table) to perform the action on. If action type is insert (from another table), specify the source record (table).

Navigation:

**Set Up HCM > System Administration > Utilities > Build Time and Labor Rules > Manage Rule Actions > Action Header**

This example illustrates the fields and controls on the Action Header page. You can find definitions for the fields and controls later on this page.

Some fields on the Action Header page always appear; others appear only in connection with the action type of *Insert*. These elements always appear:

<b>Field or Control</b>	<b>Description</b>
<p><b>Save As ...</b></p>	<p>Select to duplicate an action by giving it a different name, or create an action that is similar to an existing action or a PeopleSoft-delivered action. This function replaces the Copy Actions page from previous releases of PeopleSoft Time and Labor.</p> <hr/> <p><b>Important!</b> When you use the <b>Save As...</b> button to create the copy, the system saves the source object with any modifications prior to selecting the <b>Save As ...</b> button. You should always create the copy first, and then make changes to the object.</p> <hr/> <p><b>Note:</b> You cannot modify individual actions or conditions after they are part of a rule and the system is in production (that is, after <i>Production Environment</i> is selected on the Installation Options page).</p>

<b>Field or Control</b>	<b>Description</b>
<b>Action Type</b>	<p>Specify the SQL action to perform. Valid values are:</p> <ul style="list-style-type: none"> <li>• <i>Update</i>: Select to change an existing row of data. Identify a table to update in the <b>Target Record (Table) Name</b> field. In addition, define the type and source of the data to use to update the target record on the Action Details pages.</li> <li>• <i>Delete</i>: Select to delete the data in a table. Identify a table to delete in the <b>Target Record (Table) Name</b> field.</li> <li>• <i>Insert</i>: Select to insert a row of data into a table. Identify a table into which to insert data in the <b>Target Record (Table) Name</b> field, and the source of the data in the <b>Source Record (Table) Name</b> field. If the action type is <i>Insert</i>, further define the data to be inserted into the target record using the Action Details pages.</li> </ul>
<b>Core Component</b>	<p>This field is display-only and system-maintained. Several SQL objects are delivered with the Time and Labor application. These objects are used in templates. If the object you are viewing was created by the PeopleSoft system, this check box is selected; if you created this object, this check box is cleared. You cannot modify or save this object, but you can copy it and modify the copy.</p>
<b>Target Record (Table) Name</b>	<p>Enter the record (table) you want to delete, update, or perform the insert on. The records contained in the prompt table are those made available for deletion, insertion, or updating on the Working Tables page.</p>
<b>Explanation</b>	<p>Use this expression text box to explain the action you are defining.</p>

These fields appear only if you select an action type of *Insert*:

<b>Field or Control</b>	<b>Description</b>
<b>Source Record (Table) Name</b>	<p>The source record (table) from which you are taking data to perform the insert.</p>

<b>Field or Control</b>	<b>Description</b>
<b>Insert Source Indicator</b>	<p>The field that enables you to specify the exact source of the data used to perform the <i>Insert</i>. Valid values are:</p> <p><i>From Another Table:</i> If you select this value, the <b>Source Record (Table) Name</b> field is available. Enter the source record from which you are taking data to perform the insert. Go to the Action Details pages to specify the source of the data to enter into the Target Record (Table) fields.</p> <p><i>From a List of Values:</i> If you select this value, the <b>Source Record (Table) Name</b> field is unavailable. Enter the target record into which you are inserting the list of values. To define the exact values to insert in each field contained in this record, go to the Action Details pages.</p>

**Note:** Click the links at the bottom of this page to access other pages in this component.

## Action Detail Page

Use the Action Detail page (TL\_ACTION\_PNL2) to create the text of your SQL action.

Navigation:

**Set Up HCM > System Administration > Utilities > Build Time and Labor Rules > Action Detail > Action Detail**

This example illustrates the fields and controls on the Action Detail page. You can find definitions for the fields and controls later on this page.

If the action type on the Action Header page is *Update* or *Insert*, provide additional information about the fields in the target record (table) on which you are performing the action. For example, answer these questions: what fields are you updating or inserting data into and what are the sources (and types) of data that you are using to perform the insert or update?

The specific information to enter depends on the type of action specified on the Action Header page and the value entered in the **Insert Source Indicator** field.

Enter the action details on the Action Details 1 and Action Details 2 tabbed grids. These grids work in combination; when you select a value on the Action Details 1 grid, related fields become available on the Action Details 2 grid.

**Note:** The Action Detail page is not available if your action type is *Delete*. Because you are deleting the contents of an entire record (table), do not enter field-level information on the Action Detail page.

<b>Field or Control</b>	<b>Description</b>
<b>Field Name</b>	<ul style="list-style-type: none"> <li>• If the action type is <i>Update</i>, use this field to identify the fields in the target record (table) to update. Define the type and source of the data to use to perform the update in the <b>Source Field Indicator</b> field.</li> <li>• If the action type is <i>Insert - From a List of Values</i>, the <b>Field Name</b> column displays the fields belonging to the target record (table) identified on the Action Header page. These are the fields for which you are creating a new row. By default, if you are inserting from a list of values, the <b>Source Field Indicator</b> field is set to <i>Constant</i>. Enter the constant values to use for the insert action in the <b>Constant</b> field on the Action Details 2 page.  You can override the default and select one of these options:  <i>Expression</i>  <i>Meta-SQL</i>  <i>RuleTplt</i>  <i>State Var</i> <hr/><b>Note:</b> <i>RecField</i> is not available when you insert from a list of values.<hr/></li> <li>• If the action type is <i>Insert - From Another Table</i>, the <b>Field Name</b> column displays the fields belonging to the target record (table) identified on the Action Header page. These are the fields for which you are creating a new row. By default, if you are inserting <i>From Another Table</i>, the <b>Source Field Indicator</b> is set to <i>RecField</i>. Enter the RecFields that are the source of the insert in the <b>SRC (source) FieldName</b> column of the Action Details 2 page. You can override the default and select one of these options:  <i>Constant</i>  <i>Expression</i>  <i>Meta-SQL</i>  <i>State Var</i></li> </ul>

<b>Field or Control</b>	<b>Description</b>
<b>Source Field Indicator</b>	<ul style="list-style-type: none"> <li>• If the action type is <i>Update</i>: <p>For each field in the target record (table) that you update, identify the type and source of the data to use to perform the update in the <b>Source Field Indicator</b> field. Valid values are:</p> <ul style="list-style-type: none"> <li>• <i>Constant</i>: If the source field indicator is <i>Constant</i>, the <b>Constant</b> field on the Action Detail 2 page is available. Enter the constants to insert in the Target Record (Table) fields.</li> <li>• <i>Expression Text</i>: If the source field indicator is <i>Expression</i>, the <b>Expression Text</b> field on the Action Detail 2 page is available. Create an expression text. For example, this could be a subquery that updates a row of data in the target record (table).</li> <li>• <i>Meta-SQL</i>: If the source field indicator is <i>Meta-SQL</i>, the <b>Meta-SQL</b> field on the Action Detail 2 page is available. Enter the meta-SQL to use to update a field or a row of data in the target record (table).</li> <li>• <i>RecField</i>: If the source field indicator is <i>RecField</i>, the <b>SRC Field Name</b> field on the Action Detail 2 page is available. Enter another field from the target record (table) to use as the source of the update (the source and target records are always the same when the action is <i>Update</i>). For example, if you use one of the Intermediate Payable Time tables as both the source and target of the update, you could set the ORIG_TRC to TRC in a rule that changes the TRC.</li> <li>• <i>State Variable</i>: If the source field indicator is <i>State Var</i>, the <b>State Variable</b> field on the Action Detail 2 page is available. Enter the state variable from any Time and Labor state record to use as the source of the update.</li> </ul> </li> <li>• If the action type is <i>Insert - From a List of Values</i>: <p>By default, if you insert from a list of values, the <b>Source Field Indicator</b> field is set to <i>Constant</i>. Enter the constant values to use for the insert action in the <b>Constant</b> field on the Action Detail 2 page. You can override the default and select one of these options:</p> <ul style="list-style-type: none"> <li>• <i>Expression Text</i>: If the source field indicator is <i>Expression</i>, the <b>Expression Text</b> field on the Action Detail 2 page is available. Create an expression text. For example, this could be a subquery that generates data for the insert into the target record (table).</li> <li>• <i>Meta-SQL</i>: If the source field indicator is <i>Meta SQL</i>, the <b>Meta-SQL</b> field on the Action Detail 2 page is available. Enter the meta-SQL to use as the source of the insert into the target record (table).</li> </ul> </li> </ul>



<b>Field or Control</b>	<b>Description</b>
	<ul style="list-style-type: none"> <li>• <i>State Variable</i>: If the source field indicator is <i>State Var</i>, the <b>State Variable</b> field on the Action Detail 2 page is available. Enter the state variable from any Time and Labor state record to use as the source of the insert.</li> </ul> <hr/> <p><b>Note:</b> <i>RecField</i> is not available when you insert from a list of values.</p> <hr/> <ul style="list-style-type: none"> <li>• If the action type is <i>Insert - From Another Table</i>:  By default, if you insert from another table, the <b>Source Field Indicator</b> field is set to <i>RecField</i>. Enter the RecFields that are the source of the insert in the <b>SRC (source) FieldName</b> column on the Action Detail 2 page. You can override the default and select one of these options:             <ul style="list-style-type: none"> <li>• <i>Constant</i>: If the source field indicator is <i>Constant</i>, the <b>Constant</b> field on the Action Detail 2 page is available. Enter the constants to insert in the Target Record (Table) fields.</li> <li>• <i>Expression Text</i>: If the source field indicator is <i>Expression</i>, the <b>Expression Text</b> field on the Action Detail 2 page is available. Create an expression text. For example, this could be a subquery that generates data for the insert.</li> <li>• <i>Meta-SQL</i>: If the source field indicator is <i>Meta-SQL</i>, the <b>Meta-SQL</b> field on the Action Detail 2 page is available. Enter the meta-SQL to insert data into the target record (table).</li> <li>• <i>State Variable</i>: If the source field indicator is <i>State Var</i>, the <b>State Variable</b> field on the Action Detail 2 page is available. Enter the state variable from any Time and Labor state record to use as the source of the insert into the target record (table).</li> </ul> </li> </ul>



## Action Detail

<i>Field or Control</i>	<i>Description</i>
<b>Field Name</b>	<p>This column contains the fields in the target record (table) that you are updating or performing the insert action on.</p> <ul style="list-style-type: none"> <li>• If the action is <i>Update</i>, this column displays the same fields you entered in the <b>Field Name</b> column on the Action Detail 1 page. These fields belong to the target record (table) that you have chosen to update.</li> <li>• If the action is <i>Insert - From a List of Values</i>, this column displays the Target Record (Table) fields on which you are performing the insert.</li> <li>• If the action is <i>Insert - From Another Table</i>, this column displays the Target Record (Table) fields on which you are performing the insert.</li> </ul>

This page displays additional fields, depending on the source field indicator selected on the Action Detail 1 page:

<i>Field or Control</i>	<i>Description</i>
<b>Constant</b>	<p>Displays if the source field indicator is <i>Constant</i>.</p> <p>Enter the constant to use for the update or insert.</p>
	<p>Displays if the source field indicator is <i>Expression</i>.</p> <p>Click the button to access the <b>Expression Text</b> field.</p>
<b>Meta-SQL</b>	<p>Displays if the source field indicator is <i>Meta-SQL</i>.</p> <p>Enter the meta-SQL to use for the insert or update action.</p>
	<p>Displays if the source field indicator is <i>Meta-SQL</i>.</p> <p>Click the button to set parameters within the meta-SQL.</p>

<b>Field or Control</b>	<b>Description</b>
<p><b>SRC FieldName</b> (source fieldname)</p>	<p>The system displays this field if the source field indicator is <i>Rec Field</i> (Record.Field) and the action type is <i>Update</i> or <i>Insert - From Another Record</i>.</p> <ul style="list-style-type: none"> <li>If the action type is <i>Update</i>, enter the fields in the source record (table) that contain the data to perform the update.</li> </ul> <hr/> <p><b>Note:</b> In the case of an update, the source record (table) is identical to the target record (table) identified on the Action Header page.</p> <hr/> <ul style="list-style-type: none"> <li>If the action type is <i>Insert - From Another Record</i>, enter the fields belonging to the source record (table) that you want to use as the source of the insert. The source record (table) is the source record you identified on the Action Header page.</li> </ul>
<p><b>State Variable</b></p>	<p>The system displays this field if the source field indicator is <i>State Var</i>(state variable).</p> <p>Enter the state variable from any Time and Labor state record to use as the source of the update or insert.</p>

## Conditions Page

Use the Conditions page (TL\_CONDITION2\_PNL) to define or view general information for a SQL condition and create the text of a SQL condition.

Navigation:

**Set Up HCM > System Administration > Utilities > Build Time and Labor Rules > Conditions > Conditions**

This example illustrates the fields and controls on the Conditions page. You can find definitions for the fields and controls later on this page.

**Note:** Template-built rules are not effective-dated; however, they are associated with an effective-dated rule program.

To define a condition on the Conditions page, specify the exact relationship that must occur between the elements before an action occurs. The action occurs only if the defined relationship is true. For example, you can specify that an action occurs only if a field equals a certain value or you can specify that an action occurs only if a field value is greater than another defined value. You specify the kinds of elements to compare (for example, a field value to a constant) in the **Left Side** and **Right Side** group boxes in the **Expression Type** fields. You define the precise relationship to occur between these elements (before an action can occur) in the **Operator** field.

The Conditions page contains several fields that appear permanently, and others that display or hide depending on the left and right condition expression type. The following fields always appear:

<b>Field or Control</b>	<b>Description</b>
<b>Save As ...</b>	<p>Select to duplicate a condition by giving it a different name, or create a condition that is similar to an existing condition or a PeopleSoft-delivered condition. This function replaces the Copy Conditions page from previous releases of PeopleSoft Time and Labor.</p> <hr/> <p><b>Important!</b> When you use the <b>Save As...</b> button to create the copy, the system saves the source object with any modifications prior to selecting the <b>Save As ...</b> button. You should always create the copy first, and then make changes to the object.</p> <hr/> <p><b>Note:</b> You cannot alter individual actions or conditions after they are part of a rule and the system is in production (that is, after <i>Production Environment</i> is selected on the Installation Options page).</p>

<b>Field or Control</b>	<b>Description</b>
<b>Core Component</b>	This field is display-only and system-maintained. Time and Labor delivers many SQL objects that are used in templates. If the object you are viewing was created by PeopleSoft, this check box is selected; if you created this object, this check box is cleared. You cannot modify or save this object, but you can copy it and modify the copy.
<b>Expression Type</b>	Specify the types of elements to compare in the <b>Left Side</b> and <b>Right Side</b> group boxes to define the condition. Establish the correct relationship between these elements using the <b>Operators</b> field. Valid values are: <i>Constant, Expression, Meta-SQL, Record Field, Rule Template</i> and <i>State Variable</i> .
<b>Operator</b>	This field always appears, regardless of the left side or right side expression type. Use the operator to define the relationship between the elements on the left and the right halves of the page. Select one of these values:  < (less than) <= (less than or equal to) <> (Less than or greater than = (equal to) > (greater than) >= (greater than or equal to)  <i>EXISTS</i>  <i>IN</i>  <i>NOT EXISTS</i>  <i>NOT IN</i>
<b>Explanation</b>	Use this expression text box to explain the condition you are defining.

Depending on the values in the **Expression Type** fields, these additional fields appear:

<b>Expression Type</b>	<b>Additional Fields</b>
<i>Constant</i>	The <b>Left Constant</b> or <b>Right Constant</b> field appears. Enter a constant to define the condition.
<i>Expression Text</i>	The <b>Left Condition Expr Type</b> (left condition expression type) or <b>Right Condition Expr Type</b> (right condition expression type) field appears. Enter an expression to define your condition. The expression text can be any length.

<b>Expression Type</b>	<b>Additional Fields</b>
<i>Meta-SQL</i>	The <b>Left Meta-SQL</b> or <b>Right Meta-SQL</b> field appears. Enter the appropriate meta-SQL to define the condition.
<i>Record Field</i>	<p>If the left or right condition expression type is <i>RecField</i>, these fields appear:</p> <ul style="list-style-type: none"> <li>• <b>Left Record (Table) Name</b> or <b>Right Record (Table) Name</b>. Enter the left or right record that you will use to define the condition.</li> <li>• <b>Left Aggr Func</b> (left aggregate function) or <b>Right Aggr Func</b> (right aggregate function). The valid values for this field are: <i>Avg</i> (average), <i>Count</i>, <i>Count (*)</i>, <i>Max</i> (maximum), <i>Min</i> (minimum), <i>Sum</i>.</li> <li>• <b>Left Field Name</b> or <b>Right Field Name</b>. Enter the name of the field belonging to the left or right record (table) name.</li> </ul>
<i>State Variable</i>	The <b>Left State Variable</b> or <b>Right State Variable</b> field appears. Enter the state variable to use to define the condition.

---

## Creating SQL Objects

To create SQL objects, use the SQL Objects (TL\_SQL\_OBJECT) component.

SQL objects are the most complex Time and Labor rule objects that PeopleSoft delivers. Use them to define rules that are more complicated than those accommodated by templates or actions and conditions.

SQL objects are complete SQL statements that consist of an action and may consist of one or more conditions. They can include select statements, insert statements, table joins, and subqueries. If you prefer to write free-form SQL statements, use an expression text box within the SQL object pages to enter and format the SQL statements. If you do not want to use free-form SQL statements, the SQL object pages provide guidance for each aspect of an action and condition.

If you create a SQL statement, modify a PeopleSoft-delivered object using the Copy SQL Object page to create and modify a copy. Or, use the SQL Object component to build the statement.

We use this example for discussing most pages in the SQL Object component. This SQL statement applies to the SQL Objects, Tables, Automatic Joins, Select Fields, and Where Expressions pages. It does not apply to the Expression Text, Insert, or Update pages.

```
INSERT INTO PS_TL_WRK02
    (DUR
    , EMPLID
    , TL_QUANTITY)
SELECT
    A.DUR
    , A.EMPLID
    , SUM(A.TL_QUANTITY) - %RuleTemplate()
FROM PS_TL_IPT1 A
    , PS_TL_WRK01 B
WHERE A.EMPLID = B.EMPLID
    AND A.DUR = B.DUR
    AND A.SEQ_NBR <= B.SEQ_NBR
    AND A.PUNCH_TYPE IN %RuleTemplate()
    AND A.TRC IN %RuleTemplate()
GROUP BY A.DUR, A.EMPLID
```

---

**Note:** PeopleSoft recommends that you have adequate SQL training before attempting to use these pages. Use templates, actions, and conditions whenever possible.

---

## Defining SQL Objects

For any SQL object you create, designate a name, several descriptions, and the type of object you are building. Although this component has eight pages, you see a maximum of five. The visible pages depend on the type of SQL object you are building. Here are some questions to consider when defining a SQL object:

- What type of SQL statement do I want to create?
- What is the driver table for the statement?
- What is the result table for the SQL Select statement?
- What do I want to name the resulting SQL statement?
- What other tables do I want to join to the driver table?
- For each table added, how do I want to join this table to the driver table?

Do I want to do this later?

- What fields do I want to select?

- What fields on the driver table do I want to update?
- How do I want to determine the scope of the Where clause statement?

In the example, we want to create a select with Insert statement. We select from TL\_IPT1 and insert the results of the query into TL\_TA\_RESULTS. Entries on the SQL Object page provide this clause of the original example:

```
INSERT INTO PS_TL_WRK02
(DUR
, EMPLID
, TL_QUANTITY)
```

## Setup Tasks

Creating SQL objects comprises the following tasks:

1. Selecting the type of action and creating descriptions of the SQL statement.
2. Creating free-from SQL text.
3. Entering values in the record field of a particular table.
4. Defining meta-SQL parameters.
5. Creating expression text.
6. Updating a record field.
7. Designating which tables you will use in this SQL object.
8. Creating expression text for tables.
9. Joining tables.
10. Creating the first clause of a Select statement.
11. Creating expression text for the first clause of a Select statement.
12. Creating the Where clause of your SQL statement.
13. Creating expression text for the Where clause of a SQL statement.
14. Copying a SQL object.

## SQL Object Component

The SQL Object component changes according to the type of SQL statement you are building. Use this table to determine which pages are visible for each type of SQL statement:

<b>Statement Type</b>	<b>SQL Object</b>	<b>Tables</b>	<b>Automatic Joins</b>	<b>Select Fields</b>	<b>Where Exp.</b>	<b>Exp. Text</b>	<b>Insert Fields</b>	<b>Update Fields</b>
Delete	X				X			
Expression	X					X		
Insert	X						X	
Select	X	X	X	X	X			
Update	X				X			X

### Pages Used to Create SQL Objects

<b>Page Name</b>	<b>Definition Name</b>	<b>Usage</b>
<u>SQL Object Page</u>	TL_SQL_OBJECT_PNL	Select the type of action and create descriptions of the SQL statement you are creating.
<u>Expression Text Page</u>	TL_SQL_EXPRESS_PNL	Enter free-form SQL text.
<u>Insert - Fields Page</u>	TL_SQL_INSERT_PNL	Enter values in the record field of a table.
<u>TL SQL Insert SecPNL Page</u>	TL_SQL_INSMSQL_SEC	Enter meta-SQL parameters.
Expression Text Sec Panel Page	TL_SQL_OBJ_SECPNL4	Enter expression text.
<u>Updating Fields Page</u>	TL_SQL_UPDATE	Update a record field.
<u>Tables Page</u>	TL_SQL_OBJ_TABLES	Designate which tables to use in this SQL object.
Tables - Expression Text Page	TL_EXPRESN_SEC	Enter expression text for tables.
<u>Select - Fields Page</u>	TL_SQL_SELECT_PNL	Create the first clause of a Select statement.
<u>Joins Page</u>	TL_SQL_JOINS_PNL	Join tables.



<b>Page Name</b>	<b>Definition Name</b>	<b>Usage</b>
Select Tables - Expression Text Page	TL_SQL_EXPRESS_PNL	Enter expression text for the first clause of a Select statement.
<u>Where Expressions Page</u>	TL_SQL_WHERE_PNL	Create the Where clause of the SQL statement.
SQL Bind Mapping Page	TL_SQL_BINDS_PNL	Enter expression text for the Where clause of a SQL statement.

## SQL Object Page

Use the SQL Object page (TL\_SQL\_OBJECT\_PNL) to select the type of action and create descriptions of the SQL statement you are creating.

Navigation:

**Set Up HCM > System Administration > Utilities > Build Time and Labor Rules > SQL Objects > SQL Object**

This example illustrates the fields and controls on the SQL Object page. You can find definitions for the fields and controls later on this page.

---

**Note:** SQL objects are not effective-dated, but they are associated with rules that are included in effective-dated rule programs.

---

<b>Field or Control</b>	<b>Description</b>
<b>Save As ...</b>	<p>Select to duplicate an SQL object by giving it a different name, or create an SQL object that is similar to an existing object or a PeopleSoft-delivered SQL object. This function replaces the Copy SQL Object page from previous releases of PeopleSoft Time and Labor.</p> <hr/> <p><b>Important!</b> When you use the <b>Save As...</b> button to create the copy, the system saves the source object with any modifications prior to selecting the <b>Save As ...</b> button. You should always create the copy first, and then make changes to the object.</p> <hr/>
<b>SQL Type</b>	<p>Select the SQL action that this SQL object should perform. Valid options are:</p> <p><i>Delete:</i> Use to create a Delete statement. If you select this option, the component displays only the SQL Object and Where Expressions pages. If you create a Delete statement to clear a table, we recommend that you create a truncate action step on the Define Rule Steps page instead.</p> <p><i>Expression:</i> Use to enter free-form SQL expression text. If you select this option, the component displays only the SQL Object and Expression Text pages.</p> <p><i>Insert:</i> Use to create an Insert statement. If you select this option, the component displays only the SQL Object and Insert Fields pages.</p> <p><i>Select:</i> Use to create a Select statement. You use a Select statement to query. If you select this option, the component displays the SQL Object, Tables, Automatic Joins, Select Fields, and Where Expressions pages. Also, the <b>Select Type</b> field appears.</p> <p><i>Update:</i> Use to create an Update statement. If you select this option, the component displays only the SQL Object, Update Fields, and Where Expressions pages.</p>

<b>Field or Control</b>	<b>Description</b>
<b>Select Type</b>	<p>This field appears if you chose <i>Select</i> in the <b>SQL Type</b> field. Select the type of action to use. Valid values are: <i>State</i>, <i>Subquery</i>, <i>w/Insert</i>.</p> <p><i>State</i>: Use to select fields into a state record. A state variable is from the AE State records. Use to retrieve an exception description to be used in multiple locations within the AE program. Store the exception description in a state record so that you don't have to issue a SELECT every time you need it. A state record field is equivalent to a variable in a procedural language.</p> <p><i>Subquery</i>: Use to use the Select statement you create as a subquery in another query.</p> <p>A subquery must be bound to an outer query. Time and Labor does not limit the number of nested subqueries, but the database platform might have constraints.</p> <p><i>w/Insert</i>: This option is like a SQL insert with select. It is only visible if <i>Select</i> is chosen.</p> <p>Use a SQL insert to insert a list of values into a table. Select <i>w/Insert</i> to select fields from a source table to insert into a target table.</p>
<b>Table Name</b>	<p>This field appears if you selected <i>w/Insert</i> in the <b>Select Type</b> field. Choose the table against which the statement is made. The drop-down list box contains all tables loaded on the Working Tables page.</p>
<b>Core Component</b>	<p>This field is display-only and system-maintained. Time and Labor delivers several SQL objects that are used in templates. If the PeopleSoft system created the object that you are viewing, the system selects this check box to signify that you did not build the object. If you created this object, the system clears this check box. You cannot modify or save this object, but you can copy it and modify the copy.</p>
<b>Explanation</b>	<p>Enter a detailed description of the SQL Object.</p>

Click the links at the bottom of this page to access other pages within this component.

## Related Links

[Adding Rules to a Rule Program](#)

## Tables Page

Use the Tables page (TL\_SQL\_OBJ\_TABLES) to designate which tables to use in this SQL object.

Navigation:

**Set Up HCM > System Administration > Utilities > Build Time and Labor Rules > SQL Objects > Tables**

You must select *Select* from the SQL Type field menu for the Tables tab to appear.

In our example, TL\_IPT1 is assigned an alias of *A* and TL\_WRK01 is assigned an alias of *B*. The clause covered by this page is:

```
FROM PS_TL_IPT1 A
      , PS_TL_WRK01 B
```

This example illustrates the fields and controls on the Tables page. You can find definitions for the fields and controls later on this page.

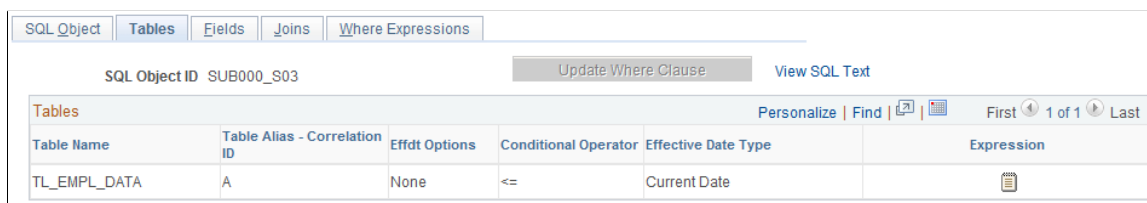

<b>Field or Control</b>	<b>Description</b>
<b>Update Where Clause</b>	Click to update the Where clause of the SQL statement. The system automatically generates a SQL Where clause based on the effective date option.

**Tables**

<b>Field or Control</b>	<b>Description</b>
<b>Table Name</b>	Select the name of the table to act upon.
<b>Table Alias – Correlation ID</b>	Select an alias for this table. An alias is used as another table name. It is generally shorter than the actual table name to save typing time.
<b>Conditional Operator</b>	This field is available if you are working with an effective-dated table and selecting an effective date option.

<b>Field or Control</b>	<b>Description</b>
<b>Effdt Options</b> (effective date options)	<p>This field provides predefined effective date logic to append to the join conditions. Valid values are: <i>First, Join, Last, None</i>.</p> <p><i>First</i>: Select this value to select the first effective-dated row.</p> <p><i>Join</i>: Select this value for the system to select the current dated row for this table.</p> <p><i>Last</i>: Select this value to select the last effective-dated row, even if that date is in the future.</p> <p><i>None</i>: Select this value for the system to not use any effective date logic in the query.</p>
<b>Conditional Operator</b>	This field is available if you are working with an effective-dated table and selecting an effective date option of <i>Join</i> .
<b>Effective Date Type</b>	Select either <i>Current</i> or <i>Expression</i> . If you select <i>Expression</i> , the system enables the <b>Expression Text</b> button.
Expression 	Click to enter expression text. The Expression Text Secondary page appears.

Click the links at the bottom of this page to access other pages within this component.

## Select - Fields Page

Use the Select - Fields page (TL\_SQL\_SELECT\_PNL) to create the first clause of a Select statement.

Navigation:

**Set Up HCM > System Administration > Utilities > Build Time and Labor Rules > SQL Objects > Fields**

You must select *Select* from the SQL Type field menu for the Select Fields tab to appear.

This example illustrates the fields and controls on the Fields page. You can find definitions for the fields and controls later on this page.

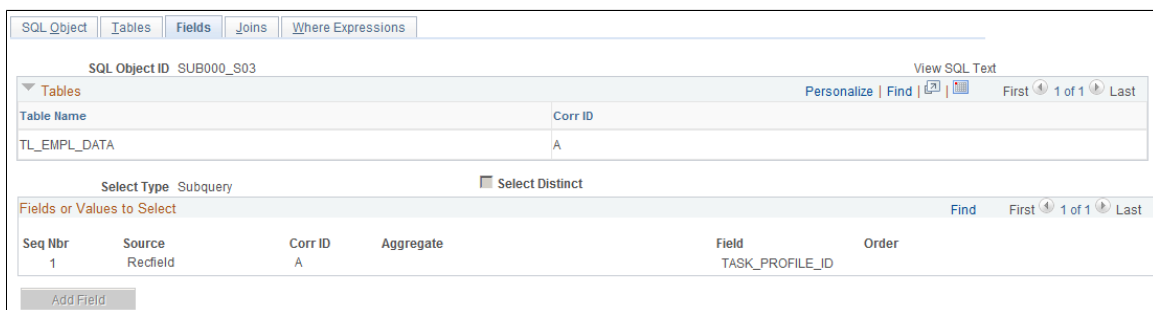

All the options that you include in the text of the statement are available as field values. Using this page, you can create the SQL text for this part of the example:

```
SELECT
    A.DUR
    , A.EMPLID
    , SUM(A.TL_QUANTITY) - %RuleTemplate()
GROUP BY A.DUR, A.EMPLID
```

<b>Field or Control</b>	<b>Description</b>
<b>Select Distinct</b>	<p>Select to exclude duplicate results of the query. Selecting this check box is a method of using the SQL DISTINCT command.</p> <p>DISTINCT is not valid with some aggregates (COUNT (*), MIN, MAX), but is valid with COUNT if you specify columns.</p>
<b>Group By</b>	<p>This value is automatically generated when there is an aggregate function.</p>
<b>Seq Nbr</b> (sequence number)	<p>Enter a sequence number for this row. The system reorders all entries on this page according to this field.</p>
<b>Source</b>	<p>Select the source of the fields to include in this statement. The value in the <b>Source</b> field determines which other fields are visible. Valid options are:</p> <p><i>Constant:</i> Select this value to specify a constant. The <b>Order by</b> and <b>Field Name</b> fields appear on the page.</p> <p><i>Expression:</i> Select this value to enter expression text. The flashlight button appears.</p> <p><i>Recfield:</i> Select this value to specify a record field.</p> <p><i>Statevar:</i> Select this value to specify a state variable.</p> <p><i>Template:</i> Select this value to specify a template.</p>
<b>Aggregate</b>	<p>To perform an aggregate function, select that option here. Valid options are: <i>(none)</i>, <i>AVG</i>, <i>COUNT</i>, <i>COUNT(*)</i>, <i>MAX</i>, <i>MIN</i>, and <i>SUM</i>.</p>
<b>Corr ID</b> (correlation ID)	<p>Select the alias of the table to specify for this sequence number.</p>
<b>Field</b>	<p>Select the column from which to select.</p>

<b>Field or Control</b>	<b>Description</b>
<b>Order</b>	The order field can be used to control the order of the data returned. It is applicable only to statements with a sub-query Select Type.
<b>Field Name</b>	This field is only applicable to statements with a Select.Insert Select Type. This field refers to the target field on the table that is receiving data.
<b>State Variable</b>	This field only applies to the Select Type of Into State. This field indicates the State Variable that the selected field should go into.

Click the links at the bottom of this page to access other pages within this component.

## Joins Page

Use the Joins page (TL\_SQL\_JOINS\_PNL) to join tables.

Navigation:

**Set Up HCM > System Administration > Utilities > Build Time and Labor Rules > SQL Objects > Joins**

You must select *Select* from the SQL Type field menu for the Automatic Joins tab to appear.

This example illustrates the fields and controls on the Joins page. You can find definitions for the fields and controls later on this page.

The screenshot shows the 'Joins' page interface. At the top, there are navigation tabs: SQL Object, Tables, Fields, Joins, and Where Expressions. The 'Joins' tab is active. Below the tabs, the SQL Object ID is 'SUB000\_S03' and there is a 'View SQL Text' link. A table list shows 'TL\_EMPL\_DATA' with 'Corr ID' set to 'A'. Below this is the 'Specify Join Criteria' section, which has two columns: 'Tables' and 'Fields'. The 'Tables' column has fields for 'Left Table', 'Right Table', and 'Join On'. The 'Fields' column has five fields labeled 'Field Name 1' through 'Field Name 5'. At the bottom, there is a 'SQL Join Text' text area and an 'Add Join' button.

You can only create inner joins in Time and Labor. You can join on any fields using custom-selecting or by selecting the key fields option. Because of platform constraints, you cannot perform three-way joins or unions using the Automatic Joins page, but you can make several selects into a working table and use the data from there. You can also use the Expression Text page to write free-form SQL text that can include three-way joins or unions.

We want to join the TL\_IPT1 table to the TL\_WRK01 on the EMPLID and DUR columns in the following clauses:

```
WHERE A.EMPLID = B.EMPLID
      AND A.DUR = B.DUR
```

<b>Field or Control</b>	<b>Description</b>
<b>Left Table</b>	Select (by alias) the first table in your join. Valid options are: <i>(none), A, B, C, D, E, F, G, H, I, J.</i>
<b>Join Type</b>	You can join in various ways. Valid options are: <i>Fields</i> and <i>Key Fields</i> .  Select <i>Fields</i> to select any record fields in the five drop-down list boxes that appear.  Select <i>Key Fields</i> to select from the key fields that appear in the drop-down list box.
<b>Right Table</b>	Select (by alias) the second table in the join. Valid options are: <i>(none), A, B, C, D, E, F, G, H, I, J.</i>
<b>SQL Join Text</b>	This field displays the text of the join. The system uses the meta-SQL construct %JOIN.

Click the links at the bottom of this page to access other pages within this component.

## Where Expressions Page

Use the Where Expressions page (TL\_SQL\_WHERE\_PNL) to create the Where clause of the SQL statement.

Navigation:

**Set Up HCM > System Administration > Utilities > Build Time and Labor Rules > SQL Objects > Where Expressions**

You must select *Delete*, *Select*, or *Update* from the SQL Type field menu for the Where Expressions tab to appear.



This example illustrates the fields and controls on the Where Expressions page. You can find definitions for the fields and controls later on this page.

In the example, the statement is true where the date under report is greater than or equal to itself.

```
AND A.SEQ_NBR <= B.SEQ_NBR
    AND A.PUNCH_TYPE IN %RuleTemplate()
    AND A.TRC IN %RuleTemplate()
```

The system displays the record and correlation ID you selected for reference while creating the Logical Operator/Where clause.

<b>Field or Control</b>	<b>Description</b>
<b>Logical Operator</b>	Select an operator in this field. Valid values are: <i>(none)</i> , <i>AND</i> , <i>HAVING</i> , <i>NONE</i> , <i>OR</i> , and <i>WHERE</i> .
<b>Use Conditional Prompts</b>	Select to build the clause in the page instead of entering expression text for this clause. The system selects this check box automatically.
<b>Expression Text</b>	This field holds 254 characters. Only a small SQL expression or subquery can be entered into this field.
<b>Left Expr Type</b> (left expression text)	Valid values are: <i>(none)</i> , <i>Binding</i> , <i>Constant</i> , <i>Meta-SQL</i> , <i>Recfield</i> , <i>SubQuery</i> , <i>Template</i> , and <i>Variable</i> .  If you select <i>Meta-SQL</i> , the %SQL button appears on the page.
<b>Corr ID</b> (correlation ID)	Select the alias of the table to use. This field appears only when <i>Recfield</i> is selected for the left expression type.
<b>Left Field Name</b>	Select a column name of the table to use for the left expression.

<b>Field or Control</b>	<b>Description</b>
<b>Aggregate</b>	If you select <i>Recfield</i> , the <b>Aggregate</b> field appears. Valid values are: <i>NONE, MIN, MAX, AVG, SUM, COUNT, and COUNT(*)</i> .
<b>Operator</b>	Enter an operator. Valid values are: <i>(none), &lt;, &lt;=, &lt;&gt;, =, &gt;, &gt;=, EXISTS, IN, NOT EXIST, and NOT IN</i> .
<b>Right Expr Type</b> (expression type)	Enter a right expression type. Valid values are: <i>(none), Binding, Constant, Meta-SQL, Recfield, SubQuery, Template, and Variable</i> .
<b>Corr ID</b> (correlation ID)	Select the alias of the table to use. This field appears only when <i>Recfield</i> is selected for the right expression type.
<b>Right Field Name</b>	Select a column name of the table to use for the right expression.
	Click the icon to access the SQL Bind Mapping page, where you can enter data for a bind. This icon is available when the left or right expression type select is MetaSQL or Subquery. For MetaSQL, it presents a page where Meta SQL parameters can be entered. For subquery, it presents a page where SQL Bind variables can be given values.

## Insert - Fields Page

Use the Fields page (TL\_SQL\_INSERT\_PNL) to enter values in the record field of a table.

Navigation:



**Set Up HCM > System Administration > Utilities > Build Time and Labor Rules > SQL Objects > Fields**

You must select Insert from the SQL Type field menu for the Fields tab to appear.

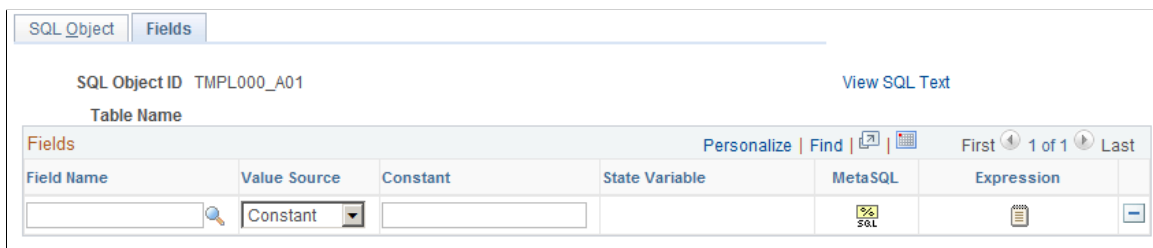
This example illustrates the fields and controls on the Insert Fields page. You can find definitions for the fields and controls later on this page.



Complete both the SQL Object and Insert Fields pages to create a complete Insert statement.

<b>Field or Control</b>	<b>Description</b>
<b>Field Name</b>	Select the column in which you want to enter the value.
<b>Insert Value Source</b>	Select the source of the value. Valid values are: <i>Constant</i> , <i>Expression</i> , <i>Meta-SQL</i> , <i>Template</i> , and <i>Variable</i> . The page is modified according to the option you select.
<b>Constant</b>	If you selected <i>Constant</i> in the <b>Insert Value Source</b> field, this field becomes available. Enter a constant in this field.
<b>State Variable</b>	Enter the variable to use. This field is available if you selected <i>Variable</i> in the <b>Insert Value Source</b> field.
 (MetaSQL)	This icon is displayed for the Insert type of SQL statement, when the <b>Value Source</b> is <i>Meta-SQL</i> . Click it to select a meta-SQL option. The Insert Value using MetaSQL page is displayed.
 (Expression)	This icon is displayed for the Expression type of SQL statement, when the <b>Value Source</b> is <i>Expression</i> . Click it to enter expression text. The Insert Expression page appears.

Click the links at the bottom of this page to access other pages within this component.

This page does not allow you to remove a field from the list that can have a null value. PeopleTools does not allow the insertion of data into a table without specifying a value for numeric and character fields. Therefore, fields that can have a null value cannot be removed from the list.

## TL SQL Insert SecPNL Page

Use the TL SQL Insert SecPNL page (TL\_SQL\_INSMSQL\_SEC) to enter meta-SQL parameters.

Navigation:

Click the Meta-SQL button on the Fields page.

<b>Field or Control</b>	<b>Description</b>
<b>MetaSQL</b>	Select the meta-SQL variable to include in the Insert statement.
<b>Parameter (X)</b>	<p><b>Note:</b> (X) represents the number of the <b>Parameter (X)</b> field. The system assigns successive numbers to each Parameter field that appears.</p> <p>Enter the data that the system should use to calculate the value of the meta-SQL variable. For example, if you selected the meta-SQL %DateDiff, enter the two dates for which the system should calculate the difference.</p>

## Updating Fields Page

Use the Update Fields page (TL\_SQL\_UPDATE) to update a record field.

Navigation:

**Set Up HCM > System Administration > Utilities > Build Time and Labor Rules > SQL Objects > Update Fields**

You must select Update from the SQL Type field menu for the Update Fields tab to appear.

You can update a field with a constant, the result of a subquery, or an other value. You can perform basic mathematical functions on this constant before the final update of the field.

```
UPDATE PS_TL_IPT1
  SET TL_QUANTITY = TL_QUANTITY -
    (SELECT DISTINCT A.TL_QUANTITY
     FROM PS_TL_WRK02 A,
          PS_TL_WRK01 B
     WHERE A.EMPLID = B.EMPLID
           AND A.DUR = B.DUR
           AND A.EMPLID = PS_TL_IPT1.EMPLID
           AND A.DUR = PS_TL_IPT1.DUR), TL_RULE_ID = %RuleTemplate()
 WHERE PS_TL_IPT1.SEQ_NBR = (SELECT DISTINCT B.SEQ_NBR
                             FROM PS_TL_WRK01 B
                             WHERE B.EMPLID = PS_TL_IPT1.EMPLID
                                   AND B.DUR = PS_TL_IPT1.DUR)
 AND EXISTS (SELECT 'X'
             FROM PS_INSTALLATION I
             WHERE 'R' = %RuleTemplate())
```

This example illustrates the fields and controls on the Update Fields page. You can find definitions for the fields and controls later on this page.

<b>Field or Control</b>	<b>Description</b>
<b>Field</b>	Select the record field to update. The result of the subquery or math operation is placed in the specified field.
<b>Value Source and Value Source 2</b>	Select the source of the value to act upon. Valid options are: <i>Constant, Another Field, Meta-SQL, Subquery, Template, Variable.</i>  Only one of the <b>Value Source</b> fields can be set to <i>Subquery</i> at a time. When you choose <i>Subquery</i> , the <b>SQL Object Bind Variables</b> link becomes available.
<b>Field Name</b>	Select the record field you want as the basis.
<b>Math. Operator</b>	To perform a mathematical function, select the operator. If you do not want to perform any mathematical functions, select ( <i>none</i> ). Valid options are: -, +, *, /.
<b>SQL Object ID</b>	This field is used to add a subquery to a Set clause.
<b>SQL Object Bind Variable</b>	Link to the SQL Bind Mapping page, this is available when <b>Value Source</b> is set to <i>Subquery</i> .
<b>Constant and Constant 2</b>	This field is available when you set the <b>Value Source</b> or <b>Value Source 2</b> field to <i>Constant</i> .
<b>Variable (2)</b>	you can enter a state variable in this field when the <b>Value Source 2</b> is set to <i>Variable</i> .

<b>Field or Control</b>	<b>Description</b>
MetaSQL	You can enter a value in this field when the <b>Value Source</b> field is set to <i>MetaSQL</i> . This field is not available for any values in the <b>Value Source 2</b> field.
	This icon links to the MetaSQL Parameters page, it is available when the <b>Value Source</b> field is set to <i>MetaSQL</i> .

## Expression Text Page

Use the Expression Text page (TL\_SQL\_EXPRESS\_PNL) to enter free-form SQL text.

Navigation:

**Set Up HCM > System Administration > Utilities > Build Time and Labor Rules > SQL Objects > Expression Text**

**Expression** must be entered in the \*SQL Type field for the Expression Text tab to appear at the top of the page.

<b>Field or Control</b>	<b>Description</b>
<b>Format Expression Text</b>	Click to format the SQL text in the <b>Expression</b> field. You must enter your statement before clicking the button.
<b>Expression</b>	This field is an expression text box in which to type SQL statements. You can also paste text from other applications. The system stores anything you enter and does not check for errors. Before entering your statement and saving the page, run the SQL statements through an interactive SQL tool.

Access the Expression Text page (**Set Up HCM > System Administration > Utilities > Build Time and Labor Rules > SQL Objects > Expression Text**).

Enter up to 254 characters in the expression text box.

This example illustrates the fields and controls on the Expression Text page. You can find definitions for the fields and controls later on this page.

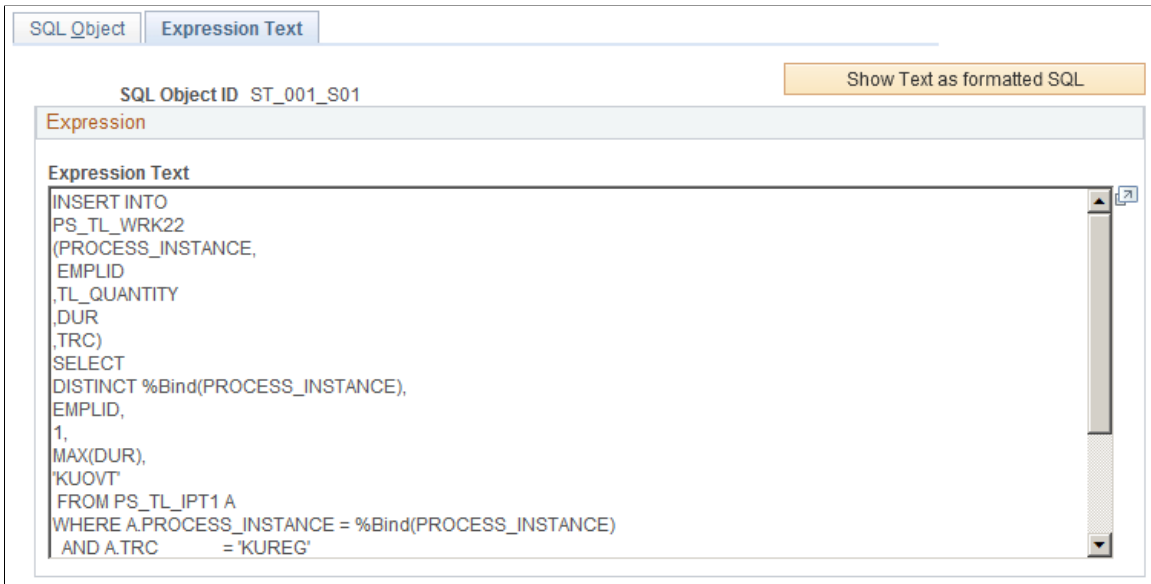

<i>Field or Control</i>	<i>Description</i>
<b>Show Text as Formatted SQL</b>	You can click this button to view the formatted SQL statement. The formatted text is shown on the same page as view-only text. The name of this button then changes to <b>Show Entered Text</b> , which enables you to view and edit the text as it was originally entered.

**Related Links**

[Rule Step Creation Guidelines](#)

## Working with User Exits

User exits are an optional feature that can add PeopleCode and AE sections to regular Time and Labor processing. When you write user exits, add AE sections to the AE program TL\_TA\_RULES. Use all the AE constructs supported by PeopleTools (SQL, PeopleCode, looping constructs like Do When, Do While, and so on).

Once the user exit Rule is coded and saved in the TL\_TA\_RULES program as a separate section, you must save that rule online as a user exit, so that the definition is recorded in the rules repository. You can only utilize the rule, and attach it to a Rule program after performing this step. To save the user exit rule online in the TL\_RULE\_DEFN table, navigate to **Setup HCM > System Administration > Utilities > Build Time and Labor Rules**. Add a new rule, and select the user exit field. The prompt for the required AE section name present your AE section name, because it is already saved in App Designer in TL\_TA\_RULES.

**Note:** If you create AE sections, they must have eight-character names. This is a PeopleSoft Application Engine requirement.

---

**Note:** Have adequate Application Engine and PeopleCode training before creating AE sections.

---

## Defining Attendance Programs

To define attendance programs, use the Attendance Programs (TL\_ATTEND\_PGM\_PNLG) component.

PeopleSoft Attendance Tracking is an optional feature that enables you to control time and administer attendance. You can track when punch-time reporters are late for work, leaving work early, or taking long lunches and breaks. The Attendance subfeature tracks punch-related attendance infractions. You do not have to create Time Administration rules to track attendance, which would be extremely cumbersome. This is a PeopleSoft-delivered set of rules to use if your business requires attendance tracking.

Attendance tracking prevents a time reporter from taking advantage of rounding rules. For example, suppose your organization rounds clock punches to the nearest quarter hour. If a time reporter clocks in late and clocks out early for every scheduled punch, this can result in paying the time reporter for almost 2.5 hours of nonwork time every week. Moreover, if you are paying overtime to this time reporter, the overtime rate will begin before the employee has worked 40 hours.

Attendance tracking compares punch-time, scheduled time, and attendance settings. Attendance infractions include tardiness, long lunches, early outs, and long breaks. The tracking can occur by three methods: fixed period, rolling period, and step period. The purpose for tracking punch-related infractions is to report user-defined recommended actions to be taken when tracking thresholds are met. This type of tracking provides a history of time reporters' attendance habits. We store this history information even when the period changes. Attendance processing occurs after IPT tables are loaded, but before rule are run.

A point system weights the severity of each infraction. While taking a long break might be a minor infraction, arriving at work late and clocking out early at the end the day might be major infractions. After you set up the recommended actions, the system automatically monitors a time reporter's behavior according to the information from the TCD.

A time manager can override or cancel any action scheduled by the system, and you can change the settings of attendance tracking any time the business rules or union regulations change. Although the system is delivered with standard actions, you can create custom actions.

Attendance tracking enables you to define the attendance characteristics and maintain those changes. When setting up, specify the tracking method, period ID, tracking items (tardies, long lunches, early outs, and long breaks), and points associated with each tracking item. Define the recommended actions and threshold of each action. You can choose a recommended action from a predefined list of actions or create a custom action. If you choose to create custom actions, choose *Other* and enter comments that describe the action.

## Pages Used to Define Attendance Programs

<b>Page Name</b>	<b>Definition Name</b>	<b>Usage</b>
<u>Attendance Program Page</u>	TL_ATTEND_PGM_PNL	Specify infractions to track, grace periods to allow, and the severity of each infraction.



<b>Page Name</b>	<b>Definition Name</b>	<b>Usage</b>
<a href="#">Attendance Actions Page</a>	TL_ATTEND_ACT_PNL	Specify which actions occur when infractions are committed and when these actions occur.
<a href="#">Review Attendance Actions Page</a>	TL_ATTENDANCE_PNL	View, by employee ID, the action thresholds that a time reporter has crossed.
<a href="#">Attendance History Page</a>	TL_ATTEND_HIST_PNL	View a time reporter's violation history.

## Related Links

[Understanding the Time Administration Process Flow](#)

## Understanding Tracking Methods

You can choose from three tracking method types: fixed period, rolling period, and step period. Each method is described in this table:

<b>Tracking Method</b>	<b>Description</b>
Fixed Period	<p>Based on a period ID for a fixed period of time. Fixed period is commonly represented by month, quarter, semi-year, or year. Attendance is tracked for the duration of the fixed period and is reset at the start of the next fixed period. For example, if you track attendance monthly, a time reporter's attendance record is cleared at the beginning of each monthly period.</p> <p>The attendance infractions are retained in the TL_ATTEND_HIST table. You can view them with the View Attendance History page. Information for current and previous tracking periods is differentiated by the IN_PERIOD flag.</p>
Rolling Period	<p>Based on the current date and the period of interest. Define a rolling period by specifying the length of days for the period of interest. The system subtracts the duration from the current date and uses the result as a start date. For example, if you define a rolling period of 90 days and the current date is July 12, 2000, then the system tracks attendance from April 16, 2000. It compiles all relevant attendance data to the present to determine if a time reporter's infractions require action. The next day, July 13, 2000, the system uses data from April 17, 2000, to the present date. It ignores attendance data for April 16, 2000, because this date is outside the period of interest.</p>

<b>Tracking Method</b>	<b>Description</b>
Step Period	<p>Based on specified successive increments of time periods. You determine a series of periods of interest. Unlike the rolling period, the system uses the date that an action is triggered, not the current system date. When a time reporter's infractions trigger an action, the period of interest begins. If the time reporter does not reach another threshold in the period of interest, the attendance record is cleared and attendance tracking reverts to the first step. If another threshold is reached, a new step is invoked and a new period of interest applies.</p> <p>You define a step period by specifying steps of time. For example, if you define a step period as three steps and each step is equivalent to 30 days, then step one is 30 days, step two is 60 days, and step three is 90 days. Each time an employee violates a predefined threshold, a step period is incremented. If a time report is currently being tracked for a 30-day period and violates the attendance rule, the tracking period is extended to 60 days from the date of the most current violation, not the original tracking time. If the time reporter violates the attendance rule a second time, it is extended to 90 days.</p>

## Understanding Attendance Program Tasks

Defining attendance programs and tracking attendance violations comprises the following tasks:

1. Specifying infractions to track, grace periods to allow, and the severity of each infraction.
2. Specifying which actions and when actions occur when infractions are committed.
3. Adding attendance programs to a rule program on the Program page.
4. Viewing, by employee ID, the action thresholds that a time reporter has crossed.
5. Viewing a time reporter's violation history.

---

**Note:** You must link your attendance programs to rule programs, and then associate both to workgroups.

---

## Attendance Program Page

Use the Attendance Program page (TL\_ATTEND\_PGM\_PNL) to specify infractions to track, grace periods to allow, and the severity of each infraction.

Navigation:

**Set Up HCM > Product Related > Time and Labor > Rules and Workgroups > Attendance Programs > Attendance Program**

This example illustrates the fields and controls on the Attendance Program page. You can find definitions for the fields and controls later on this page.

The screenshot shows the 'Attendance Program' configuration page for 'KUATTEND1'. It includes sections for 'Attendance Program Information' and 'Attendance Tracking Detail'. The 'Attendance Program Information' section contains fields for '\*Effective Date' (01/01/1980), '\*Description' (Attendance Program 1), and 'Short Description' (Attend1). The 'Attendance Tracking Detail' section features a '\*Tracking Method' dropdown set to 'Fixed Period' and a 'Time Period ID' field set to 'PSMONTH'. Below these are four checked options: 'Track Tardies', 'Track Long Lunch', 'Track Early Out', and 'Track Long Break'. Each option has associated 'Grace (Minutes)' and 'Points' input fields. For example, 'Track Tardies' has a grace of 5 minutes and 1.00 points. 'Track Long Lunch' also has a 5-minute grace and 1.00 point, but includes a 'Meal Duration (Minutes)' field set to 60. 'Track Early Out' has a 5-minute grace and 1.00 point. 'Track Long Break' has a 5-minute grace, 1.00 point, and a 'Break Duration (Minutes)' field set to 15.

### Attendance Tracking Detail

Use this group box to specify the particular rules and limits of your attendance program.

<b>Field or Control</b>	<b>Description</b>
<b>Tracking Method</b>	Select the type of time period to use for this attendance program. Valid values are: <i>Fixed</i> , <i>Rolling</i> , <i>Step</i> . If you select <i>Fixed</i> or <i>Rolling</i> , the <b>Time Period ID</b> field appears. If you select <i>Step</i> , the <b>Time Period ID</b> field is unavailable.
<b>Time Period ID</b>	Select the time period ID that applies to the attendance program. You can select a period delivered by the PeopleSoft system or a custom period. This field does not apply if you are creating a step-based attendance program.  For Fixed Period attendance programs, you can select from day, week, or month-type periods only. For day-type periods, the offset can only be 1. For rolling period attendance programs, you can only choose a day-type time period that has an offset of less than or greater than 1.
<b>Track Tardies</b>	Select to track when time reporters clock in late to work at the beginning of a workday. The system compares the time of the first In punch of the workday with the scheduled punch time.
<b>Grace (Minutes)</b>	Enter the grace period (in whole minutes). You can enter a value from 1 to 99.
<b>Points</b>	Enter the value of this infraction. The value you enter can be up to 999 and can have up to two decimal places.

<b>Field or Control</b>	<b>Description</b>
<b>Track Long Lunch</b>	Select to track when time reporters take a long lunch. The system compares the duration of the meal punches with the meal duration that you enter on this page.
<b>Meal Duration (Minutes)</b>	Enter a maximum duration for a meal punch.
<b>Track Early Out</b>	Select to track when time reporters clock out early from the workday. The system compares the time of the Out punch with the scheduled end of the workday.
<b>Track Long Break</b>	Select to track when time reporters take a long break. The system compares the punch duration with the break duration that you enter on this page.
<b>Break Duration</b>	Enter a maximum duration for a break.

**Related Links**

[Understanding Time and Labor Implementation](#)

**Attendance Actions Page**

Use the Attendance Actions page (TL\_ATTEND\_ACT\_PNL) to specify which actions occur when infractions are committed and when these actions occur.

Navigation:

**Set Up HCM > Product Related > Time and Labor > Rules and Workgroups > Attendance Programs > Attendance Actions**

This example illustrates the fields and controls on the Attendance Actions page. You can find definitions for the fields and controls later on this page.

The screenshot shows the 'Attendance Actions' page for program 'KUATTEND1'. It includes a table of actions with the following data:

*Attendance Action	*Points	Comment
Verbal Warning	1.00	
Written Warning 1	2.00	
Written Warning 2	3.00	
Suspension	4.00	

<b>Field or Control</b>	<b>Description</b>
<b>Action #</b> (action number)	<p>The system populates this column with the next consecutive sequence number. Although the numbers are automatic, enter actions in any order. Lower-numbered items occur first, so enter the least severe actions at the top of this list.</p> <hr/> <p><b>Note:</b> The order in which you enter attendance actions is crucial to system accuracy and data integrity. If you enter actions in the wrong sequence, the system does not reorder or re-prioritize them.</p>
<b>Attendance Action</b>	<p>Select the recommended action for this sequence number. Valid values are: <i>Letter, Other, Suspension, Terminate, Verbal 1, Written 1, Written 2, Written 3.</i></p> <p>Letters are placed on file without the employee's knowledge. Written warnings are signed by the employee and manager as an acknowledgement that the employee was notified of the infraction. You can write an API to send a message when an action occurs, but the system only identifies infractions and displays the recommended action—it does not take any action. You cannot publish warnings or messages back to the TCD. The process does not progress if a manager excuses a step.</p>
<b>Points</b>	<p>Select when you want this action to occur. The system invokes this action when the time reporter's total number of points for the current tracking period is equal to or greater than the value in this field. The entry does not have to be a whole number; you can enter a three-digit number with up to two decimal places. The value must be a multiple of the highest point value on the Attendance Program page to prevent recommended actions from being skipped.</p>

<b>Field or Control</b>	<b>Description</b>
<b>Comment</b>	This 30-character, alphanumeric field is available only if you selected <i>Other</i> in the <b>Attendance Action</b> field. Enter a description of, or comment about, the action. You can create custom actions. For example, you might dock a time reporter's pay.

## Review Attendance Actions Page

Use the Review Attendance Actions page (TL\_ATTENDANCE\_PNL) to view, by employee ID, the action thresholds that a time reporter has crossed.

Navigation:

**Time and Labor > View Exceptions and Attendance > Attendance Actions > Review Attendance Actions**

<b>Field or Control</b>	<b>Description</b>
<b>Date Under Report</b>	The date that applies to this row of data.
<b>Description</b>	The system displays a description of the exception that occurred.
<b>Action Required</b>	The system displays the recommended action that you entered on the Attendance Actions page.
<b>Date Cleared</b>	This field displays the date that the time manager cleared the action.

## Attendance History Page

Use the Attendance History page (TL\_ATTEND\_HIST\_PNL) to view a time reporter's violation history.

Navigation:

**Time and Labor > View Time > Attendance History > Attendance History**

This example illustrates the fields and controls on the Attendance History page. You can find definitions for the fields and controls later on this page.

Attendance History	
Antonio Santos <span style="float: right;">Empl ID KU0010</span>	
Attendance Violations <span style="float: right;">Personalize   Find   View All     First 1-7 of 48 Last</span>	
Date	Description
01/03/2000	Late IN Punch
01/06/2000	Long Meal
01/10/2000	Late IN Punch
01/11/2000	Long Meal
01/17/2000	Long Break
01/18/2000	Early Out
01/20/2000	Long Meal

Field or Control	Description
<b>Date Under Report</b>	This field displays the date that applies to this row of data.
<b>Description</b>	The system description of the exception that occurred.
<b>In Period</b>	The system selects this check box if this row is in the current period. The system clears this check box for all history rows (archived data).

## Assembling Rules

To assemble rules, use the Rules (TL\_RULES) component.

Once you have defined the individual building blocks that make up a rule using actions and conditions or SQL objects, you need to combine these components into complete rules and place them in a logical order by arranging them into *rule steps* using the pages described in this section.

You'll also use these pages to modify existing rules or copies of rules. For example, you can take an existing rule (whether template built or of another type), open it within the Define Rules component, modify or add new actions or conditions to it, and then recompile the rule.

### Rule Assembly Tasks

Assembling rules comprises of entering basic information about a rule, defining the steps of the rule, creating descriptions for each rule step, viewing the SQL text of the rule step you are adding to a rule, and copying rules.

## Pages Used to Assemble Rules

<i>Page Name</i>	<i>Definition Name</i>	<i>Usage</i>
<a href="#">Rules Page</a>	TL_RULE_PNL1	Enter basic information about a rule and enter descriptions for each rule step.
<a href="#">Action SQL Text Resolution Page</a>	TL_RULE_TEXT_SP	View the SQL text of the rule step you are adding to a rule.

## Rules Page

Use the Rules page (TL\_RULE\_PNL1) to enter basic information about a rule and enter descriptions for each rule step.

Navigation:

**Set Up HCM > System Administration > Utilities > Build Time and Labor Rules > Rules > Rules**

This example illustrates the fields and controls on the Rules page. You can find definitions for the fields and controls later on this page.

**Rules**

Rule ID: KUPREMZONE      Rule SQL Text      [Compile Rule](#)      [Save As...](#)

**Rule Definition**

\*Description: Premium Zone Punch Rule       User Exit  
 Short Description: PremZone       Custom(ized) Rule  
 \*Time Period ID: PSWEEK       Compiled  
 \*AE Section: KUPREM      Last Compiled: 12/10/2012 9:15:22.158693PM

**Define Rule Steps**      Personalize | Find | View All | First 1-5 of 8 Last

*Step	AE Action	*Statement Type	SQL Object ID	SQL Object	SQL Text	Record (Table) Name
1	SQL - Standard	SQL Object	TMPLO90_S01	SQL		
2	SQL - Standard	SQL Object	TMPLO90_S02	SQL		
3	SQL - Standard	Update Statistics				TL_IPT4
4	SQL - Standard	SQL Object	TMPLO90_S04	SQL		
5	SQL - Standard	Update Statistics				TL_IPT2



<b>Field or Control</b>	<b>Description</b>
<b>Save As...</b>	<p>Select to duplicate a rule by giving it a different name, or create a rule that is similar to an existing rule or a PeopleSoft-delivered rule object.</p> <p>This function replaces the Copy Rules page from previous releases of PeopleSoft Time and Labor.</p> <hr/> <p><b>Important!</b> When you use the <b>Save As...</b> button to create the copy, the system saves the source object with any modifications prior to selecting the <b>Save As ...</b> button. You should always create the copy first, and then make changes to the object.</p> <hr/>
<b>Compiled</b>	<p>The system populates this field automatically to signify whether the rule was compiled. When this field is selected, the rule was compiled and hasn't changed since that compilation.</p>
<b>Time Period ID</b>	<p>Select the time period of interest that applies to this rule. Values include the values delivered by the PeopleSoft system and any time periods that you created using the Time Period pages. The system uses the time period to determine the date range for the selection criteria of the rule. The Time Administration program also uses the time period to determine which reported time to load into the working tables during processing.</p>
<b>Run Location</b>	<p>You can update this field only if you activate the Run Online Rules option on the TL Installation page. Valid values are:</p> <p><i>Batch Only:</i> Select for the system to apply this rule when you run the Time Administration batch process.</p> <p><i>Online and Batch:</i> Select for the system to apply this rule when you run the Time Administration batch process or the Apply Online Rules process that you start from the elapsed timesheet or the punch timesheet.</p>
<b>User Exit</b>	<p>Select if the components of the rule are written in PeopleSoft Application Engine or in PeopleCode. If you select this option, the <b>Compiled</b> and <b>Last Compiled</b> fields are unavailable and the Define Rule Steps page is unavailable. The system locates the created section in the TL_TA_RULES library.</p> <p>Create a user exit by creating a new AE section within the TL_TA_RULES library. Add the AE section name to the AE section list on the AE Section page.</p>
<b>AE Section</b> (application engine section)	<p>Select the AE section to use to process this rule. This section is inserted into TL_TA_RULES library when you compile the rule.</p> <hr/> <p><b>Note:</b> Do not modify Time and Labor objects in the AE library. Use the Time and Labor pages.</p> <hr/>

<b>Field or Control</b>	<b>Description</b>
<b>Core Component</b>	This field is display-only and is system-maintained. Many rules are delivered with Time and Labor. These rules are used in rule templates. If the rule you are viewing was created by the PeopleSoft system, then this field is set to <i>Y</i> . If you created this object, the system sets this field to <i>N</i> . When you add a new rule, the system sets the Core Component field to <i>N</i> .
<b>Last Compiled</b>	The system-maintained field that displays the last date and time that this rule was compiled.
<b>Explanation</b>	Enter a detailed description of the rule. You can include examples of how this rule is used and how it affects data in different scenarios.

### Define Rule Steps - Rule Step Details Tab

Use this grid to enter the steps of the rule.

---

**Note:** Multiple views of this portion of the Define Rule page are available by selecting the tabs in the scroll area. We document fields that are common to all views first.

---

Rules usually begin with steps to truncate working tables (TL\_IPT2-5 and other working tables) to create spaces within the working tables for processing steps in the rule.



---

**Warning!** Never truncate TL\_IPT1. Doing so destroys the data.

Generally, order the rules by period. For example, if you have daily rules and weekly rules, the system should resolve the daily rules first.

---

<b>Field or Control</b>	<b>Description</b>
<b>Step</b>	Enter a value in this column to determine the processing order of the rule steps. Lower numbers indicate higher priority. Numbers can be up to three digits. Each number within this column must be unique. We suggest assigning numbers in increments of 10 so that you can insert steps later without renumbering the entire rule. The processing order is extremely important because it can directly affect payable time calculations.

<b>Field or Control</b>	<b>Description</b>
<b>Step Type</b>	<p>Select a value from the list. Valid values are:</p> <p><i>(none)</i>: Select for the system not to use any effective date logic.</p> <p><i>SQL Obj</i>: Select to add a SQL object in this rule step. If you select this option, the Record (Table) Name column is unavailable.</p> <p><i>Action</i>: Select to add an action in this rule step. If you select this option, the Record (Table) Name column is unavailable.</p> <p><i>Expr Text</i>: Select to add expression text in this rule step. If you select this option, the component changes and the Expression Text page is visible.</p> <p><i>Truncate</i>: Select to truncate a table in this rule step. If you select this option, the SQL ID, Page Transfer, and Rule Step SQL Text button columns in the grid are unavailable.</p>
<b>SQL Object ID</b>	Select the object to include in this rule step.
<b>Action</b>	Select the action to include in this rule step.
<b>SQL Object</b> 	To view the SQL text of the object you are adding to the rule, click the <b>Rule Text</b> button to access the Action SQL Text Resolution secondary page. You will not see the SQL text of other objects in the step list. To view the entire rule text, click the button at the top of the page.
<b>SQL Text</b> 	Click to view the details of the SQL object that you are adding to the rule step. You cannot modify the object.
<b>Record (Table) Name</b>	Select the table that you want to truncate, if applicable.

## Define Rule Steps - Description Tab

Access the Description tab on the Define Rule page.

<b>Field or Control</b>	<b>Description</b>
<b>Description</b>	Enter a short description of what this rule step should accomplish.

## Related Links

[Understanding the Time Administration Process Flow](#)

[Establishing Time Periods](#)

[Building and Viewing Time Period Calendars](#)

[Rule Step Creation Guidelines](#)

[Rule Step Creation Guidelines](#)

## Action SQL Text Resolution Page

Use the Action SQL Text Resolution page (TL\_RULE\_TEXT\_SP) to view the SQL text of the rule step you are adding to a rule.

Navigation:

Click the **Compile Rule** button on the Rules page.

This example illustrates the fields and controls on the Action SQL Text Resolution page. You can find definitions for the fields and controls later on this page.

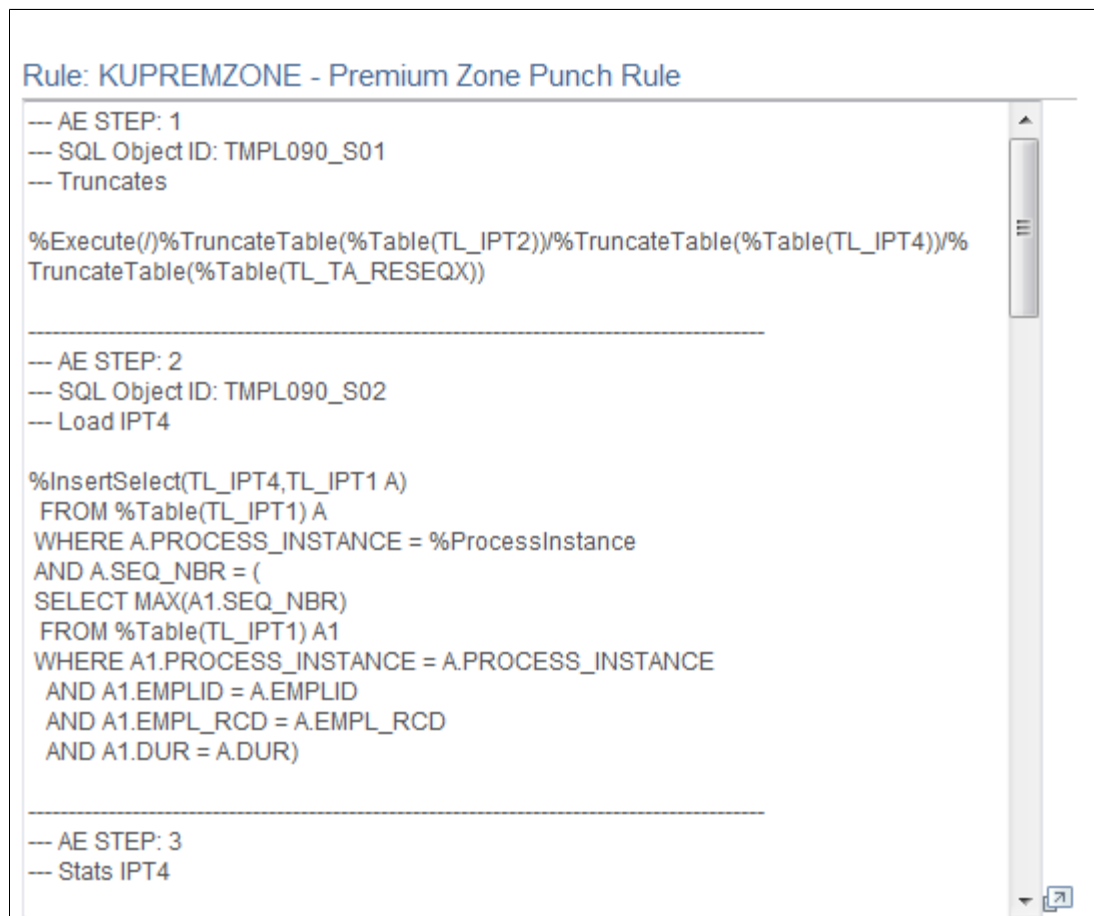

```

Rule: KUPREMZONE - Premium Zone Punch Rule
-----
-- AE STEP: 1
-- SQL Object ID: TMPL090_S01
-- Truncates

%Execute(/)%TruncateTable(%Table(TL_IPT2))/%TruncateTable(%Table(TL_IPT4))/%
TruncateTable(%Table(TL_TA_RESEQX))

-----
-- AE STEP: 2
-- SQL Object ID: TMPL090_S02
-- Load IPT4

%InsertSelect(TL_IPT4,TL_IPT1 A)
  FROM %Table(TL_IPT1) A
 WHERE A.PROCESS_INSTANCE = %ProcessInstance
 AND A.SEQ_NBR = (
  SELECT MAX(A1.SEQ_NBR)
  FROM %Table(TL_IPT1) A1
 WHERE A1.PROCESS_INSTANCE = A.PROCESS_INSTANCE
   AND A1.EMPLID = A.EMPLID
   AND A1.EMPL_RCD = A.EMPL_RCD
   AND A1.DUR = A.DUR)

-----
-- AE STEP: 3
-- Stats IPT4

```

## Exporting, Importing, and Recompiling Rules

To move rules from one database to another, use the Rules Export (TL\_EXP\_RULE) component to export rules and the Rules Import (TL\_IMP\_RULE) component to import rules. Use the Rules Recompile (TL\_RULE\_RCMP) component to recompile Time and Labor rules.

Time and Labor enables you migrate rules across databases, which means that you can easily transfer rules created in an isolated testing environment into your production database.

### Pages Used to Export, Import, and Recompile Rules

<i>Page Name</i>	<i>Definition Name</i>	<i>Usage</i>
<u>Rules Export Page</u>	TL_EXP_RULE	Lists all of the rules that are to be exported from a source database and initiates the processes that select the listed rules and create a DataMover DAT file for exporting the rules.
<u>Rules Import Page</u>	TL_IMP_RULE	Initiates the TL_IMP_RULE Application Engine process which imports DataMover DAT files created by the Export process.
<u>Rules Recompile Page</u>	TL_RULE_RCMP	Recompile rules in the database.

### Understanding Rules Migration

Moving Time and Labor Rules from one environment to another uses three distinct phases:

- Selecting rules for export and exporting all of the required rule elements.
- Importing rules from a rules export file.
- Recompiling rules for PeopleSoft templates.

Time and Labor uses PeopleTools DataMover and two DataMover scripts to complete the migration of Time and Labor rules from one environment to another. The system uses an Application Engine (AE) process to create the DataMover scripts required to export and then import the selected rules. The AE process then packages the rules and scripts into a DataMover DAT file in a location you specify from the run control page.

Execute the Import and Recompile rules processes when the processes do not conflict with existing Time Administration processes. This is because the Import rules process transfers shared objects from records where a separation from the rule itself was not possible. In addition, any template modified during the Recompile rules process can affect existing rules, and a conflict with a Time Administration batch process would cause the batch process to crash.

You should execute the Import and Recompile rules processes in your Production environment when you run the existing Refresh Dynamic Groups process. This is because the Refresh Dynamic groups process is run daily and has the same potential conflicts.

The Export process does not change any existing structures in the environment. You can safely select rules and export the required rule elements at any time.

## Rules Export Page

Use the Rules Export page (TL\_EXP\_RULE) to lists all of the rules that are to be exported from a source database and initiates the processes that select the listed rules and create a DataMover DAT file for exporting the rules.

Navigation:

**Set Up HCM > System Administration > Utilities > Build Time and Labor Rules > Rules Export**

This example illustrates the fields and controls on the Rules Export page. You can find definitions for the fields and controls later on this page.

The screenshot shows the 'Rules Export' page with the following elements:

- Run Control ID:** 1
- Buttons:** 'Create Scripts' and 'Run'
- Script Location:** A text input field with a search icon. Below it, an example path is shown: 'Script Location example: C:\folder\'. A checkbox labeled 'Include related Rule programs' is present.
- List of Rules to be Exported:** A table with columns: Rule, Template ID, Template Type, and two small icons (+ and -).

Rule	Template ID	Template Type		
KAPUB	TEMPLATE010	Shift Premium	+	-

<b>Field or Control</b>	<b>Description</b>
<b>Include related Rule programs</b>	Select this check box to include the most current effective-dated rows for the Rule Programs associated with the selected rules in the export file. If you do not select this field, then you must manually associate each imported rule to the corresponding rule program.
<b>Create Scripts</b>	Click to perform the following steps: <ol style="list-style-type: none"> <li>1. Verify that the indicated script location path is correct, and Process Scheduler has write access to the desired output location.</li> <li>2. Analyze the content of each row in the Rules Export area of the page, resolve the selection of rules and store the results.</li> <li>3. Write the DataMover scripts for both the Export and Import rules processes.</li> </ol>

<b>Field or Control</b>	<b>Description</b>
<b>Run</b>	Click to perform the following steps: <ol style="list-style-type: none"> <li>1. Initiate a DataMover process scheduler request to generate the rules DAT file based on the Export script created by the Create Scripts process.</li> <li>2. List each rule that is selected and processed in the message log file and indicate the completion of the DataMover process.</li> </ol>
<b>Script Location</b>	Enter the location used by the system to store the DataMover scripts and DAT file created by the Export process.
<b>Rule ID</b>	Enter a specific rule to include in the exported rules file.
<b>Template ID</b>	Enter a Rules Template name to select all of the rules associated with that template for export
<b>Template Type</b>	Select a Template Type to specify that all of the rules associated with all of the rules templates for the specified template type are selected for export.

## Rules Import Page

Use the Rules Import page (TL\_IMP\_RULE) to initiate the TL\_IMP\_RULE Application Engine process which imports DataMover DAT files created by the Export process.

Navigation:

**Set Up HCM > System Administration > Utilities > Build Time and Labor Rules > Rules Import** and enter the location of the DataMover DAT file created by the Export rules process in the **Script Location** field.

## Rules Recompile Page

Use the Rules Recompile page (TL\_RULE\_RCMP) to recompile rules in the database.

Navigation:

**Set Up HCM > System Administration > Utilities > Build Time and Labor Rules > Rules Recompile**

This example illustrates the fields and controls on the Rules Recompile page. You can find definitions for the fields and controls later on this page.

<i>Field or Control</i>	<i>Description</i>
<b>Recompile All Rules</b>	Select to recompile all existing rule templates. Clearing this check box enables you to view the Rules Recompile region of the page.
<b>Rule ID</b>	Enter a specific rule to recompile.
<b>Template ID</b>	Enter a Rules Template name to select all of the rules associated with that template for recompiling
<b>Template Type</b>	Select a Template Type to specify that all of the rules associated with all of the rules templates for the specified template type are recompiled.

## Adding Rules to a Rule Program

To add rules to a program, use the Rule Programs (TL\_RULE\_PGM) component.

After you organize the components of your rules in the proper order, you need to add your rules to a rule program using the Rule Program and Program Detail pages. The rule program specifies the set of rules the Time Administration process executes and the order in which it executes the rules. Rules programs are also the method by which you assign attendance programs to time reporters.

If you have elected to use online rule processing, the number of online rules you can include in a rule program is determined by your entry in the **Maximum Online Rules** field on the TL Installation page.

This section discusses how to add rules to a Rule Program.

---

**Note:** To activate a rule program (and its associated attendance program), you must link the program to a workgroup on the Workgroup page.

---



---

**Note:** Rule programs are effective-dated, but the individual rules contained within them are not. You cannot modify a rule once you assign it to a rule program. However, you can remove the rule from the rule program and replace it, if appropriate, with a new rule. This feature ensures the referential integrity of rules processing.

The prompt values presented for the possible rules to be added to a rule program are: template built rules, rules you have created online in the Rules component by clearly spelling out each step and SQL used, or user exit rules where you have indicated and saved the rule, in the Rules component.

---

## Pages Used to Add Rules to A Rule Program

<i>Page Name</i>	<i>Definition Name</i>	<i>Usage</i>
<a href="#">Rule Programs page</a>	TL_RULE_PGM_PNL	Name and enter a description of the rule program. To link an attendance program to a rule program.

### Rule Programs page

Use the Rule Programs page (TL\_RULE\_PGM\_PNL) to name and enter a description of the rule program. Also To link an attendance program to a rule program and select the rules to be included in the program and the order in which the Time Administration program is to execute them.

Navigation:

**Set Up HCM > Product Related > Time and Labor > Rules and Workgroups > Rule Programs**

This example illustrates the fields and controls on the Rule Programs page. You can find definitions for the fields and controls later on this page.

### Rule Programs

Rule Program ID: KURULEPGM1

**Program Description** Find | View All | First 1 of 1 Last

\*Effective Date: 01/01/1980 + -

\*Description: Rule Program w/ Attendance 1 Short Description: Rule Pgm1

Attendance Program: KUATTEND1 Attendance Program 1

Explanation:

**Rules in Program** Personalize | Find | View All | First 1-2 of 2 Last

*Process Order	*Rule ID	Description	Explanation	
10	KUDFLTREG	Default Reg KUREG	Defaulting TRC Rule. This rule will assign any hours without a Time Reporting Code (TRC) to the KUREG TRC.	+ -
20	KUSUNOT	Sunday Overtime Rule	Specific Day Rule. When a Time Reporter reports more than 0 hours on Sunday, then replace the reported TRC with the KUOVT TRC. Payable time will be generated for the target TRC in place of the incoming TRC for quantities that exceed the defined limit.	+ -

<b>Field or Control</b>	<b>Description</b>
<b>Attendance Program</b>	Select the attendance program to associate with this rule program, if applicable. Attendance programs contain rules that track various attendance issues.
<b>Description</b>	Enter a complete description of the rule program in this field.

<b>Field or Control</b>	<b>Description</b>
<b>Process Order</b>	<p>Assign a sequence number to each rule to specify its processing order. The lower the number, the higher the priority. Numbers can be up to three digits and each number within the program must be unique. It's a good idea to assign numbers in increments of 10 or some other factor. If you do this, you will not need to renumber if you insert a row later.</p> <p>The processing order is important because it directly affects payable time calculations. In general, rules with a shorter time period should be processed first. For example, assign daily rules a lower number than weekly and monthly rules.</p> <p>Place rules that consider thresholds (such as overtime rules) and rules that use default TRCs after those that resolve regular hours and defaults. For example, a rule created with Template440 is always placed at the beginning of a rule program because other rules may need to act on the scheduled IN punch time. This rule says: "If a time reporter clocks in outside of normal schedule, assign schedule with the closest start time to the time reporter's IN punch."</p> <hr/> <p><b>Note:</b> This field triggers the Referential Integrity process. Referential integrity ensures that if a time reporter's earliest change date is less than the effective-dated change of the setup table, the earliest change date will not be updated. If, however, the earliest change date is null or greater than the effective date of the setup table change, the earliest change date is updated to the minimum effective date of reported or payable time for the time reporter.</p>
<b>Rule ID</b>	<p>Select the rule to include in the program.</p> <hr/> <p><b>Note:</b> This field triggers the Referential Integrity process. Referential integrity ensures that if a time reporter's earliest change date is less than the effective-dated change of the setup table, the earliest change date is not updated. If, however, the earliest change date is null or greater than the effective date of the setup table change, the earliest change date is updated to the minimum effective date of reported or payable time for the time reporter.</p>
<b>Description</b>	<p>The description of the rule you selected in the <b>Rule ID</b> field displays for reference.</p>
<b>Explanation</b>	<p>Full text description of the rule.</p>

**Note:** The maximum number of online rules you can add to a rule program is determined by the entry in the Maximum Online Rules field on the Time and Labor Installation page.

## Related Links

[Defining Attendance Programs](#)



# Creating Rule Templates

---

## Understanding Rule Template Creation

Time Administration in the Time and Labor application is a rules engine that executes the rules you specify to process reported and scheduled time. The system enables you to build custom, or non-template-based rules using SQL. However, many users prefer to create rules using templates that contain the basic logic, underlying structures and necessary SQL objects for a rule. Templates enable users that are not experts in SQL to create a variety of rules for the Time Administration program to execute when processing reported and scheduled time.

Rule templates define the set of SQL statements that are required to enact a particular type of rule. The template is very similar to a rule, except that the SQL objects contain pre-defined variables where values can be inserted. The template also defines and controls the user interface where users who may not have extensive rule-building skills can input the functional criteria that make up the rule. The template continues to list the rule steps and the SQL objects upon which the parameters entered by the user are applied to generate the executable code specific to each rule. A template also defines how the information, or parameters, from the user interface fit into the template's explanation and the template's executable steps, or SQL objects.

SQL objects that are subject to customization have placeholders, specifically `%RuleTemplate()`, that are replaced with information specific to the rule in order to create the executable Application Engine (AE) section and its SQL steps.

## Example: Creating a New Rule Template

The following steps illustrate the creation of a new template that tracks a TRC and the number of days reported.

### Creating Message Catalog Entries

Creating or selecting a message catalog entry as a template for the rule explanation is a prerequisite for creating a Rule Template. For this template, two entries are added to the *Time and Labor Time Admin* message set using the Message Catalog page. The messages in this example are numbered 5000 and 5001 to place the messages into the customer range of messages.

1. Create a message for the rule description

This example illustrates the fields and controls on the Message Catalog page showing the information used for the Cust\_600 Rule Template. You can find definitions for the fields and controls later on this page.

**Message Catalog**

Message Set Number: 13507

Description: Time & Labor Time Admin

Short Description: TL TA Msgs

Messages Find | View 100 First 1 of 379 Last

\*Message Number: 5000

\*Severity: Message

\*Message Text: Cust 600 Template Rule

Description: Exception Rule: Excessive Days Reported  
 (Create exception (1)SPECIFIED\_EXCEPTION when a Time Reporter reports more than (2)SPECIFIED\_DAYS of (3)SPECIFIED\_TRC\_LIST

2. Create a second message for the exception that rules using this template can generate.

This example illustrates the fields and controls on the Message Catalog page showing the information for the tracked TRC exception. You can find definitions for the fields and controls later on this page.

**Message Catalog**

Message Set Number: 13507

Description: Time & Labor Time Admin

Short Description: TL TA Msgs

Messages Find | View 100 First 1 of 379 Last

\*Message Number: 5001

\*Severity: Message

\*Message Text: Tracked TRC limit reached by employee

Description: Employee has reported the tracked TRC the number of days tracked or more

In addition to the message for the generated exception, you also need to create the Time and Labor exception on the Exception Definition page.

This example illustrates the fields and controls on the Exception Definition page, illustrating the set up for the exception generated by the example temple. You can find definitions for the fields and controls later on this page.

### Exception Definition

Exception ID CUST5001

**Exception Details** Find | View All    First 1 of 1 Last

\*Effective Date

\*Description  Short Description

**Exception Controls**

\*Exception Severity

Allowable

Archive Exception

**Message Data**

Message Set   Time & Labor Time Admin

Message Number   Tracked TRC limit reached by employee

## Creating a New Presentation Page

Creating or selecting a page used to present the detail parameters that are specific to a rule from the Template-Built Rules component is a prerequisite for creating a new rule template. For this example, create a new page called TL\_CUST\_600\_PNL using the Application Designer to present the detail parameters that are specific to the new rules created by the template.

This example illustrates the fields and controls on the Partial image of the Application Designer screen showing information for the TL\_CUST600\_PNL page. You can find definitions for the fields and controls later on this page.

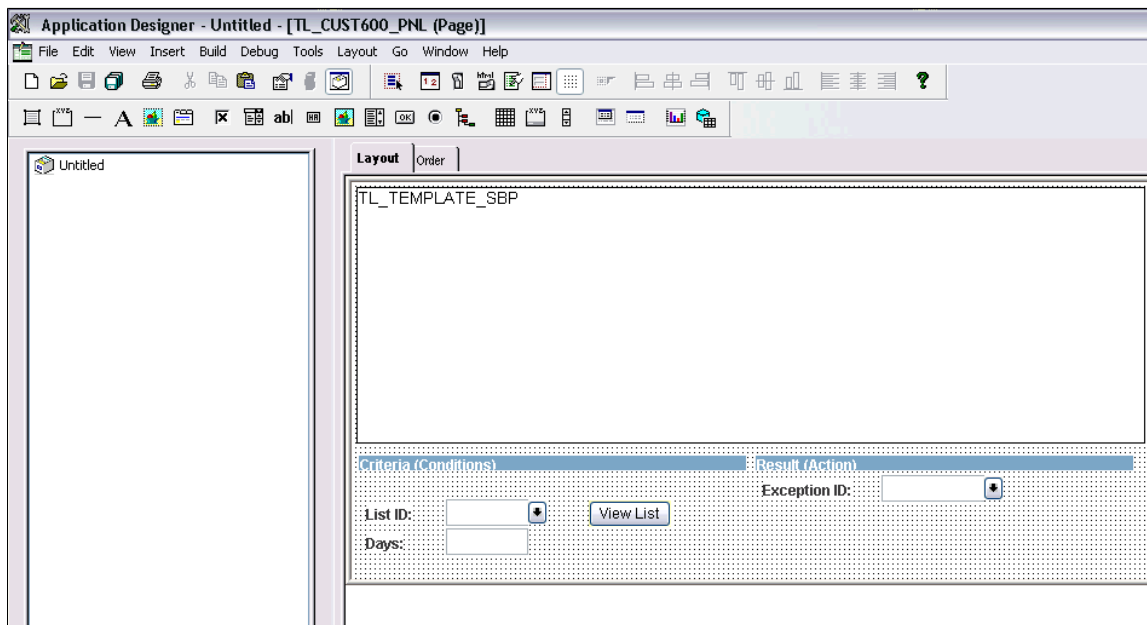

### Creating New SQL Objects

Another prerequisite for most rule templates is an SQL object or an action. For this example, create two new SQL objects: CUST600\_S01 and CUST600\_S02, using the Copy SQL Objects process. In this case, you make the modifications to the final version of the SQLs directly in the Rule Template definition. So it does not matter which SQL object you use as source for creating your copies.

This example illustrates the fields and controls on the Copy SQL Objects page showing how to copy an existing SQL object to the CUSTOMER600\_S01 SQL object. You can find definitions for the fields and controls later on this page.

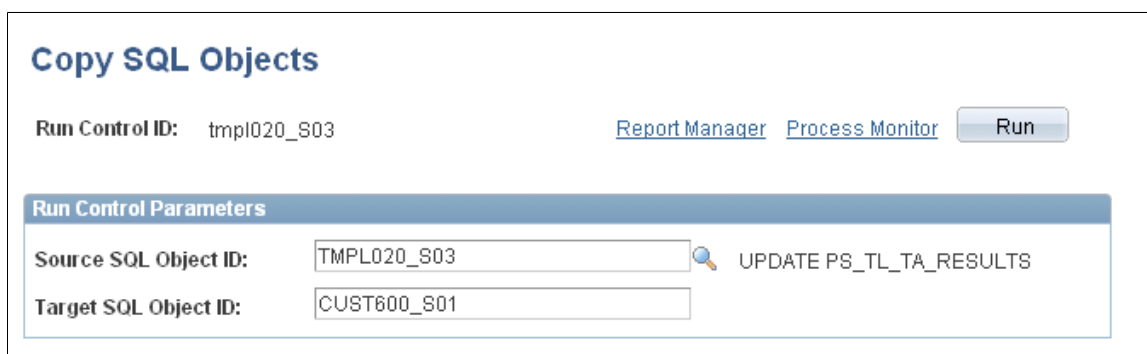

### Creating a New Rule Template

Using the Template Definition page, create a new template called CUST\_600. When completing the information in the fields, in the Period Filter field, indicate that the period filter is not applicable by selecting *TL\_PERIOD\_NA\_VW*. Also be sure to indicate the TL\_CUST600\_PNL detail page that you created earlier.



This example illustrates the fields and controls on the Template Definition page showing the information entered for this example template. You can find definitions for the fields and controls later on this page.

The screenshot shows the 'Template Definition' page with the following details:

- Rule Template:** CUST\_600
- \*Description:** Days with TRC Tracking
- \*Short Description:** Days w TRC
- \*Template Type:** Exception
- Core Component:**
- Header Page Controls:**
  - \*Time Selection: Required, No Out Punch
  - \*Profile Selection: Not Applicable For Template
  - Period Filter: TL\_PERIOD\_NA\_VW
- Detail Page Controls:**
  - Detail Page: TL\_CUST600\_PNL
  - List Type: Time Reporting Codes
  - \*Action: Not Applicable
  - Message Set: 13507
  - Message Number: 5000
- Template Controlling Code:**
  - Use Dedicated App Class
  - Root Package ID: [Empty]
  - Package Name: [Empty]
  - Explanation: [Empty]

Then, on the Template Steps page, enter the SQL objects you created earlier, as well as the TMPL000\_S01E SQL object.

This example illustrates the fields and controls on the Template steps page showing the three SQL objects used in this example. You can find definitions for the fields and controls later on this page.

The screenshot shows the 'Template Steps' page with the following details:

- Rule Template:** CUST\_600
- Description:** Days with TRC tracking
- Short Description:** Days w TRC
- Core Component:**
- Define Rule Steps:**

Rule Step	'AE Action'	'Statement Type'	SQL Object ID	Edit Object	Parameter Count	Parameters
1	SQL - Standard	SQL Object	TMPL000_S01E	Edit SQL	1	Parameters
2	SQL - Standard	SQL Object	CUST600_S01	Edit SQL	2	Parameters
3	SQL - Standard	SQL Object	CUST600_S02	Edit SQL	2	Parameters

Click the **Edit SQL** button for each SQL object and enter your planned syntax for each object.

Once you have defined the syntax for each object, specify the template step parameters for each SQL object by clicking the **Parameters** link for each object.

For Rule Step 1, the parameter you need to fill is the Exception type, field EXCEPTION\_ID or record DERIVED\_TL\_TMPL.

**Note:** If your template calls for fields that are not present in the application, you should create a new derived record to contain those fields.

Access the Template Step Parameters page for Rule Step 1:

This example illustrates the fields and controls on the Template Step Parameters page showing the information for Rule Step 1 of the CUST\_600 template. You can find definitions for the fields and controls later on this page.

**Template Step Parameters**

Template ID: CUST\_600  
 Rule Step: 1  
 AE Action: SQL - Standard

Step Parameters ? Personalize | Find | First 1 of 1 Last

Parameter List Information

Sequence Number	Required Field	Record Name	Field Name	Field Format
1	<input checked="" type="checkbox"/>	DERIVED_TL_TMPL	EXCEPTION_ID	Character

SQL Object ID: TEMPL000\_S01E  
 Expression Text: %Select(TL\_EXC\_RULE\_AET.DESCR)  
 SELECT  
 A.DESCR  
 FROM PS\_TL\_EXCEPT\_DEFN A  
 WHERE A.EXCEPTION\_ID = %RuleTemplate()  
 AND A.EFFDT = (SELECT MAX(A1.EFFDT)  
 FROM PS\_TL\_EXCEPT\_DEFN A1  
 WHERE A1.EXCEPTION\_ID = A.EXCEPTION\_ID  
 AND A1.EFFDT <= %Bind(TL\_TA\_MAIN\_AET.TL\_SYSTEM\_DT))

OK Cancel

For Rule Step 2, both of the fields are list values. Do not specify a field name, but use the List Information tab to provide the list name.

Fill the parameters in order, according to the SQL presented. In this example, the first parameter is a TRC, so the first TRC listed is the DERIVED\_TL\_TMPL field TRC, which is delivered on second page of the rule. The second field is a PUNCH\_TYPE list, so the parameter is TL\_TMPLT\_RULE, type "Punch List".

Access the Template Step Parameters page for Rule Step 2:

This example illustrates the fields and controls on the Template Step Parameters page showing the information for Rule Step 2 of the CUST\_600 template. You can find definitions for the fields and controls later on this page.

**Template Step Parameters**

Template ID: CUST\_600 Exception  
 Rule Step: 2  
 AE Action: SQL - Standard

Step Parameters ? Customize | Find | First 1-2 of 2 Last

Parameter List Information

Sequence Number	Required Field	Record Name	Field Name	Field Format
1	<input checked="" type="checkbox"/>	DERIVED_TL_TMPL		Character
2	<input checked="" type="checkbox"/>	TL_TMPLT_RULE		Character

SQL Object ID: CUST600\_S01  
 Expression Text: %InsertSelect(TL\_WRK01\_TL\_IPT1 A  
 , PROCESS\_INSTANCE = %PROCESSINSTANCE, SEQ\_NBR = MAX(A.SEQ\_NBR))  
 FROM %TABLE(TL\_IPT1) A  
 WHERE A.PROCESS\_INSTANCE = %PROCESSINSTANCE  
 AND A.TRC IN %RuleTemplate()  
 AND A.PUNCH\_TYPE IN %RuleTemplate()  
 GROUP BY A.PROCESS\_INSTANCE, A.EMPLID, A.DUR

For Rule Step 3, the DERIVED\_TL\_TMPL field name and field format are completed as you did for Rule Step 1. The TL\_TMPLT\_RULE record uses the DAYNUM field, which has a Numeric field format. Access the Template Step Parameters page for Rule Step 3:

This example illustrates the fields and controls on the Template Step Parameters page showing the information for Rule Step 3 of the CUST\_600 template. You can find definitions for the fields and controls later on this page.

**Template Step Parameters**

**Template ID:** CUST\_600      Exception  
**Rule Step:** 3  
**AE Action:** SQL - Standard

**Step Parameters** Customize | Find | First 1-2 of 2 Last

Parameter List Information

Sequence Number	Required Field	Record Name	Field Name	Field Format	
1	<input checked="" type="checkbox"/>	DERIVED_TL_TMPL	EXCEPTION_ID	Character	+ -
2	<input checked="" type="checkbox"/>	TL_TMPLT_RULE	DAYNUM	Numeric	+ -

**SQL Object ID:** CUST600\_S02  
**Expression Text:**

```

%InsertSelect(TL_EXCEPT_WRK
,TL_WRK01 A
, ACTION_DTTM = %CurrentDateTimeln
, VALID_INST_ID = 0
, ALLOW_IND = 'Y'
, DUR = MIN(A.DUR)
, EMPL_RCD = 0
, END_DT = MAX(A.DUR)
, EXCEPTION_ID = %RuleTemplate()
, EXCEPTION_SOURCE = 'TA'
, EXCEPTION_STATUS = 'U'
, MSG_DATA1 = %NUMTOCHAR(A.TL_QUANTITY)
, SEQ_NBR = MIN(A.SEQ_NBR)
, START_DT = MAX(A.DUR)
, UPDATE_FLAG = 'N')
FROM %TABLE(TL_WRK01) A
WHERE A.PROCESS_INSTANCE = %PROCESSINSTANCE
GROUP BY A.PROCESS_INSTANCE, A.EMPLID
HAVING %RuleTemplate() >= (SELECT COUNT(*) FROM %TABLE(TL_WRK01) B
WHERE B.PROCESS_INSTANCE = A.PROCESS_INSTANCE
AND B.EMPLID = A.EMPLID)

```

**Note:** You will not be able to save the template until you fill out the complete number of parameters for each step.

## Creating a Template Built Rule Using the Sample Template

After you successfully save the CUST\_600 rule template, you can create new template-built rules using the Template Header page:

This example illustrates the fields and controls on the Template Header page showing information based on the CUST\_600 Template. You can find definitions for the fields and controls later on this page.

Template Header **TI Cust600 Pnl**

**Template Type:** Exception **Template:** CUST\_600

**Template-Rule Information**

**\*Rule ID:**

**\*Description:**  **Short Description:**

**\*Time Period ID:**  **\*AE Section:**

**Punch Type**

- Include IN Punch
- Include OUT Punch
- Include BREAK Punch
- Include MEAL Punch
- Include XFER Punch
- Include Elapsed Time

**Run Location**

- Batch Only
- On-line and Batch

The TI\_CUST600\_PNL appears as an additional tabbed page in the Template-Built Rules component:

This example illustrates the fields and controls on the TL\_CUST600\_PNL page as created for the CUST\_600 Rule Template. You can find definitions for the fields and controls later on this page.

Template Header **TI Cust600 Pnl**

**Rule Template:** CUST\_600 **Rule ID:** ADD600 **test--**

**Explanation:** Exception Rule: Excessive days reported.  
 (Create exception (1)SPECIFIED\_EXCEPTION when a Time Reporter reports more than (2)SPECIFIED\_DAYS of (3)SPECIFIED\_TRC\_LIST during the rule period .

[Update Rule Text](#)  
[Modify Conditions](#)

**Criteria (Conditions)** **Result (Action)**

**List ID:**  [View List](#) **Exception ID:**

**Days:**

Based on the configuration specified in the sample pages shown above, the content of the newly-created rule is:

```

--- AE STEP: 1
--- SQL Object ID: TMPL000_S01E
---

%Select(TL_EXC_RULE_AET.DESCR)
SELECT
  A.DESCR
  FROM PS_TL_EXCEPT_DEFN A
 WHERE A.EXCEPTION_ID = 'CUST5001'
       AND A.EFFDT = (SELECT MAX(A1.EFFDT)
                      FROM PS_TL_EXCEPT_DEFN A1
                      WHERE A1.EXCEPTION_ID = A.EXCEPTION_ID
                      AND A1.EFFDT <= %Bind(TL_TA_MAIN_AET.TL_SYSTEM_DT))

-----

--- AE STEP: 2
--- SQL Object ID: CUST600_S01
---

%InsertSelect(TL_WRK01 ,TL_IPT1 A
, PROCESS_INSTANCE = %PROCESSINSTANCE, SEQ_NBR = MAX(A.SEQ_NBR))
  FROM %TABLE(TL_IPT1) A
 WHERE A.PROCESS_INSTANCE = %PROCESSINSTANCE
       AND A.TRC IN ('KOMCK', 'KUSIK', 'MAMSK', 'SCK')
       AND A.PUNCH_TYPE IN ('0', '1', '4', '5')
 GROUP BY A.PROCESS_INSTANCE, A.EMPLID, A.DUR

-----

--- AE STEP: 3
--- SQL Object ID: CUST600_S02
---

%InsertSelect(TL_EXCEPT_WRK
,TL_WRK01 A
, ACTION_DTTM = %CurrentDateTimeIn
, VALID_INST_ID = 0
, ALLOW_IND = 'Y'
, DUR = MIN(A.DUR)
, EMPL_RCD = 0
, END_DT = MAX(A.DUR)
, EXCEPTION_ID = 'CUST5001'
, EXCEPTION_SOURCE = 'TA'
, EXCEPTION_STATUS = 'U'
, MSG_DATA1 = %NUMTOCHAR(A.TL_QUANTITY)
, SEQ_NBR = MIN(A.SEQ_NBR)
, START_DT = MAX(A.DUR)
, UPDATE_FLAG = 'N')
 FROM %TABLE(TL_WRK01) A
 WHERE A.PROCESS_INSTANCE = %PROCESSINSTANCE
 GROUP BY A.PROCESS_INSTANCE, A.EMPLID
 HAVING 3 >= (SELECT COUNT(*) FROM %TABLE(TL_WRK01) B
 WHERE B.PROCESS_INSTANCE = A.PROCESS_INSTANCE
 AND B.EMPLID = A.EMPLID)

```

---

**Note:** Notice the value entered for the EXCEPTION\_ID in steps one and three, and the values for the TRC IN in step two.

---

## Prerequisites for Creating Rule Templates

Before you can create a rule template, you must create or select the following rule template components:

- Rule Objects.
- A presentation page.
- An explanation message.
- A derived record, or parameter holder.

## Creating or Selecting Rule Objects

Most working steps in a template require a SQL object or an action. For any SQL object you create, designate a name, several descriptions, and the type of object you are building.

Template-serving objects are typically named for the template they support, for example *TMPL030\_U10*.

See [Creating SQL Objects](#).

## Creating or Selecting a Presentation Page

This is the page used to present the detail parameters that are specific to a rule from the Template-Built Rules component. Oracle delivered templates use a number of different pages on the `TL_TA_RULE_TMPLT` component that may cater to the parameters required for your new template. However, rather than adding pages to the Oracle delivered and maintained component, you may prefer to use a generic user interface. Oracle provides the `TL_TEMPLATE_GEN` and `TL_TEMPLATE_GRID`, pages for those users that may not want to modify the delivered component object. Selecting either `TL_TEMPLATE_GEN` or `TL_TEMPLATE_GRID` as a presentation page means that you do not need to create a new page.

See *PeopleTools 8.52: PeopleSoft Application Designer Developers Guide PeopleBook, Creating Page Definitions*

## Creating or Selecting an Explanation Message

This is the text that is displayed as the explanation for the rule, and is updated and stored along with each rule created based on this template. Select or create the message catalog entry as a template for the rule explanation. The message catalog entries for Oracle delivered templates all reside in the 13507 message set.

---

**Note:** The messages typically contain placeholders where rule-specific parameters are entered for each new rule. Each placeholder starts with a placeholder number, (*n*), and contains an uninterrupted text string that is intended to guide the user in creating the new rule. A space, period, comma, or semi-colon are all recognized as characters that define the end of the placeholder text.

---

See the product documentation for *PeopleTools: System and Server Administration*

## Creating or Selecting a Derived Record

Oracle delivered templates use the record `DERIVED_TL_TMPL`, which contains fields that are suited for most templates. You should create your own record and place all parameters linked to a given template on the same record.

## Creating Rule Templates

Time and Labor provides a component for creating and maintaining template definitions. The component enables validation of the data entered and provides full isolation of any template-specific PeopleCode from PeopleSoft delivered updates.

### Pages Used to Create Rule Templates

<i>Page Name</i>	<i>Definition Name</i>	<i>Usage</i>
<u>Template Definition Page</u>	TL_TMPLT_DEFN	Create and review the contents of rule templates.
<u>Template Steps Page</u>	TL_TMPLT_STEPS	Create the template rule steps, which define the logic of any rules created by a template.
Rules Built From Template Page	TL_TMPLTRULE_REF	Lists the rules that are created from the template based on a view against the TL_TMPLT_RULE table.
<u>Template Text Parameters Page</u>	TL_TMPLT_TEXT_SP	Specify the parameters for each placeholder in the pre-defined message that the system generates for rules when you specify a rule explanation message.
<u>Template Step Parameters Page</u>	TL_TMPLT_PARM_SP	Lists the name of the record holding the parameter in the rule component interface and displays the template SQL defined for the step with the %RuleTemplate() place-holders where the parameters fit.

### Template Definition Page

Use the Template Definition page (TL\_TMPLT\_DEFN) to create and review the contents of rule templates.

Navigation:

**Set Up HCM > System Administration > Utilities > Build Time and Labor Rules > Rule Template Definition > Template Definition**

This example illustrates the fields and controls on the Template Definition page. You can find definitions for the fields and controls later on this page.

<b>Template Definition</b>		<b>Template Steps</b>	
<b>Rule Template</b> TEMPLATE010	<a href="#">List of Rules</a>		<a href="#">Save As...</a>
<b>Description</b> Daily Threshold	<b>Short Description</b> Threshold		
<b>Template Type</b> Daily Threshold	<input checked="" type="checkbox"/> <b>Core Component</b>		
<b>Header Page Controls</b>			
<b>Time Selection</b> Required, No Out Punch	<b>Profile Selection</b> Enable Selection		
<b>Period Filter</b> TL_DLY_RULE_VW	Daily Period Calendars		
<b>Detail Page Controls</b>			
<b>Detail Page</b> TL_TEMPLATE010_PNL	<b>Message Set</b>	13507	
<b>List Type</b> Time Reporting Codes	<b>Message Number</b>	1010	
<b>Action</b> Create As Replacement	<a href="#">Text Parameters</a>		
<b>Template Controlling Code</b> ?			
<input type="checkbox"/> <b>Use Dedicated App Class</b>			
<b>Root Package ID</b>	<b>Package Name</b>		
<b>Explanation</b>	Enables creation of rules to convert or add payable time when the quantity reported within a given day exceeds a set limit. A rule from this template can for example convert any regular hours reported in excess of 8 into overtime hours. The overtime hours may replace or be created in addition to the regular hours.		

<b>Field or Control</b>	<b>Description</b>
<b>Save As ...</b>	Select to duplicate a template definition by giving it a different name, or create a template definition that is similar to an existing definition or a PeopleSoft-delivered template definition.  <b>Important!</b> When you use the <b>Save As...</b> button to create the copy, the system saves the source object with any modifications prior to selecting the <b>Save As ...</b> button. You should always create the copy first, and then make changes to the object.
<b>List of Rules</b>	Click to access the Rules Built From Template page in order to view a list of the rules that have been created from this template.
<b>Template Type</b>	Select an option to filter the search results returned when the user accesses the template built rules component.
<b>Core Component</b>	Select to mark this template as a core component. The Time and Labor application makes any core components read-only when they are saved.

**Note:** To understand the effects of different time selections and period filters, review the existing templates and rules and observe how the Template Header page behaves for templates that use the different settings.



## Header Page Controls

<b>Field or Control</b>	<b>Description</b>
<b>Time Selection</b>	<p>Select the punch types available when creating a rule, and whether a selection is required. The values are:</p> <ul style="list-style-type: none"> <li>• <i>Controlled by Code</i></li> <li>• <i>In Punch Only</i></li> <li>• <i>Not Applicable (Disable)</i></li> <li>• <i>Out Punch Only</i></li> <li>• <i>Require Punch, Except Out</i></li> <li>• <i>Required, No Elapsed</i></li> <li>• <i>Required, No Out Punch</i></li> <li>• <i>Required, No Restriction</i></li> </ul> <p>Select <i>Controlled By Code</i> when the list of enabled, defaulted, and required punch types does not fit within any of the other field values. When you select this option you must provide explicit logic in an application class to display and validate the appropriate combination of selectors.</p>
<b>Profile Selection</b>	<p>Select the Task Profile Assignment options for any rules created by this template. This selection only applies to rules that add new Intermediate Payable Time (IPT) and needs to fill in the task information on the new row and has no impact on rules that generate exceptions or alter content on existing rows.</p> <p>Select <i>Not Applicable for Template</i> to disable the Task Profile Assignment during the creation of rules.</p> <p>The values are: <i>Enable Selection, Not Applicable for Template, and Use Previous Row Tasks.</i></p>
<b>Period Filter</b>	<p>Enter the calendar table name to specify the calendars that the user can select in the <b>Period ID</b> field on the Template Header page. For example, you generally would not want to enable a user to enter a weekly calendar for a daily threshold rule. For templates where the calendar is not applicable, enter the TL_PERIOD_NA_VW table.</p>

## Detail Page Controls

<b>Field or Control</b>	<b>Description</b>
<b>Detail Page</b>	Specify the page to use for entering and displaying parameters. Two generic pages, TL_TEMPLATE_GEN and TL_TEMPLATE_GRID, support custom template development and provide more options if you do not want to modify the delivered component object.
<b>Message Set (Optional)</b>	Enter the Message Set Number for the translatable text that the system uses to generate explanations for rules created by this template. Use with the <b>Message Numbers</b> field.
<b>List Type (Optional)</b>	Select the list of values, if any, from which the user selects. Templates normally use only one List field.
<b>Message Number (Optional)</b>	Enter the Message Number for the translatable text that the system uses to generate explanations for rules created by this template. Use the Template Text Parameters page to specify the parameters for each placeholder in the pre-defined message. Use with the <b>Message Set</b> field.
Text Parameters	Click to access the Template Text Parameters page. Use the Template Text Parameters page to specify the parameters for each placeholder in the pre-defined message specified by the <b>Message Set</b> and <b>Message Number</b> fields
<b>Action</b>	Specify whether the default setting for rules created by this template is to replace the incoming reported time or add an extra IPT entry. The values are: <i>Create as Replacement</i> , <i>Create in Addition</i> , and <i>Not Applicable</i> .

## Template Controlling Code

The fields in this section enable you to create separate application classes that isolate your custom code from the delivered code. This means that future Time and Labor upgrades will not overwrite your custom templates.

<b>Field or Control</b>	<b>Description</b>
<b>Use Dedicated App Class (Use Dedicated Application Class)</b>	Select to enable you to enter values in the <b>Root Package ID</b> and <b>Package Name</b> fields.

<b>Field or Control</b>	<b>Description</b>
<b>Root Package ID</b>	Enter the name of the application package for this template. All delivered templates use the TL_RULETEMPLATES Root Package ID.
<b>Package Name</b>	For custom packages the <b>Package Name</b> is optional and the application class can be placed under the root package. The package name must be identical to the template ID. All delivered templates use the TL_RULETEMPLATES Root Package ID with a default Package Name of <i>PSFT</i> .

See the product documentation for *PeopleTools: PeopleCode Developer's Guide*

## Template Steps Page

Use the Template Steps page (TL\_TMPLT\_STEPS) to create the template rule steps, which define the logic of any rules created by a template.

Navigation:

**Set Up HCM > System Administration > Utilities > Build Time and Labor Rules > Rule Template Definition > Template Steps**

This example illustrates the fields and controls on the Template Steps page. You can find definitions for the fields and controls later on this page.

Rule Step	AE Action	Statement Type	Record (Table) Name	SQL Object ID	Edit Object	Parameter Count	Parameters
1	SQL - Standard	Truncate Work Table	TL_IPT1_TMP				
2	SQL - Quit If No Rows	SQL Object		TMPL000_S102	Edit SQL	2	Parameters
3	SQL - Standard	Update Statistics	TL_IPT1_TMP				
6	SQL - Standard	Truncate Work Table	TL_TA_RESULTS				
7	SQL - Standard	Truncate Work Table	TL_IPT2				
8	SQL - Standard	Truncate Work Table	TL_IPT3				
9	SQL - Standard	Truncate Work Table	TL_WRK_P_1				
11	SQL - Standard	SQL Object		TMPL000_U01	Edit SQL	2	Parameters
15	SQL - Standard	SQL Object		TMPL020_S02N	Edit SQL		
16	SQL - Standard	Update Statistics	TL_TA_RESULTS				
19	SQL - Standard	SQL Object		TMPL010_I01D	Edit SQL		
20	SQL - Standard	SQL Object		TMPL010_I02D	Edit SQL		
21	SQL - Standard	SQL Object		TMPL020_S04N	Edit SQL		
22	SQL - Standard	Update Statistics	TL_IPT2				
26	SQL - Standard	SQL Object		TMPL020_S04C	Edit SQL		

<b>Field or Control</b>	<b>Description</b>
<b>AE Action</b>	<p>Select the type of step based on basic Application Engine technology. If you select <i>Do Select</i>, <i>Do When</i>, or <i>Do While</i> you must also add a SQL statement in the same rule step. <i>SQL-Standard</i> and <i>SQL-Quit If No Rows</i> are both single action steps. Selecting <i>SQL-Quit If No Rows</i> produces a SQL step with attributes that skip the remaining steps in the rule section unless this statement produced or returned any rows.</p> <p>The values are: <i>SQL-Standard</i>, <i>Do Select</i>, <i>Do When</i>, <i>Do While</i>, and <i>SQL-Quit If No Rows</i></p>
<b>Statement Type</b>	<p>Select the type of SQL statement. You must also indicate the table to update or truncate, or the SQL object or action. A typical rule truncates, or deletes the content of its work tables, and then defines the actual rule logic by copying relevant information into its work tables. There may be intermediate steps that update the statistics on these tables for better performance.</p> <p>The values are: <i>Action</i>, <i>SQL Object</i>, <i>Truncate Work Table</i>, <i>Update Statistics</i>.</p>
<b>Record (Table) Name and SQL Object ID</b>	<p>Depending upon the selected <b>Statement Type</b> value, you must indicate either a table or SQL object. You must indicate a table to update or truncate when you select <i>Truncate Work Table</i> or <i>Update Statistics</i> in the <b>Statement Type</b> field. You must indicate an SQL object or action when you select <i>Action</i> or <i>SQL Object</i> in the <b>Statement Type</b> field.</p>
<b>Edit SQL</b>	<p>Click to access the SQL Object page to edit the SQL for the specified rule step.</p>
<b>Parameters</b>	<p>Click to access the Template Step Parameters page.</p>

### Defining Template Rule Steps

Define template rule steps in the following manner:

1. Number the steps in execution order.
2. Indicate the Action type.
3. Indicate the Statement Type and the related object. Depending upon the selected Action type, you need to indicate at least one of the following:
  - The table to update or truncate.
  - The SQL object or action to run.
4. Review and edit the SQL object or action using the **Edit SQL** button for each rule step.

**Note:** The interface automatically detects the number of parameters required by the rule object and updates the template step. However, if you change the number of parameters in a rule object you have used within a Rule Template, the number of parameters displayed is not updated automatically, due to caching reasons. You will need to go into the Rule Template again.

- Specify the parameter mapping for each statement that requires parameters using the link in the Parameters column.

## Template Text Parameters Page

Use the Template Text Parameters page (TL\_TMPLT\_TEXT\_SP) to specify the parameters for each placeholder in the pre-defined message that the system generates for rules when you specify a rule explanation message.

Navigation:

Click the **Text Parameters** link on the Template Definition page.

This example illustrates the fields and controls on the Template Text Parameters page. You can find definitions for the fields and controls later on this page.

Sequence Number	Record Name	Field Name	List Type
1	DERIVED_TL_TMPL		Time Reporting Codes
2	DERIVED_TL_TMPL	TL_QUANTITY	
3	DERIVED_TL_TMPL	TRC	

**Description** Daily Threshold Rule.  
When a Time Reporter reports time under TRC(s) (1)SPECIFIED\_TRCs for a total of more than (2)SPECIFIED\_HOURS hours in a day, then all hours in excess of (2)SPECIFIED\_HOURS will be paid under the (3)SPECIFIED\_TRC TRC.

<b>Field or Control</b>	<b>Description</b>
<b>Sequence Number</b>	The system automatically assigns the value of this field, and links the specified parameters in each row with each placeholder in the template message. In the <b>Description</b> field, each placeholder is numbered, based on this sequence number.
<b>Record Name and Field Name</b>	Enter the source of the parameter for each placeholder in the template message
<b>List Type</b>	Select the type of list. Use this field when the specified field is not a single value item, but a List ID for multiple values that must be expanded from the value list definition.

<b>Field or Control</b>	<b>Description</b>
<b>Description</b>	Displays the message text from the selected Message Catalog entry. Use the text in this field as a guide for defining the necessary parameters on this page.

**Note:** Enter a single TRC using the TRC field, or a list of TRCs using the LIST\_ID field. When entering a list of TRCs, enter *TRC* in the **Field Name** and the **List Type** for that parameter.

## Template Step Parameters Page

Use the Template Step Parameters page (TL\_TMPLT\_PARM\_SP) to map parameters within a step while viewing the template SQL. This page lists the name of the record holding the parameter in the rule component interface and displays the template SQL defined for the step with the %RuleTemplate() placeholders where the parameters fit.

If the defined parameter occurs on the first page of a Rule definition, the common page, then the record hosting the parameter is TL\_TMPLT\_RULE. If the defined parameter is on the detail page, the record hosting the parameter is either DERIVED\_TL\_TMPL, or your custom record of choice.

Navigation:

Click the **Parameters** link in the **Text Parameters** column on the Template Steps page.

This example illustrates the fields and controls on the Template Step Parameters page. You can find definitions for the fields and controls later on this page.

Template Step Parameters

Template ID: TEMPLATE010    Daily Threshold

Rule Step: 11

AE Action: SQL - Standard

Step Parameters

Sequence Number	Required Field	Record Name	Field Name	Field Format
1	<input checked="" type="checkbox"/>	TL_TMPLT_RULE	PERIOD_ID	Character
2	<input checked="" type="checkbox"/>	TL_TMPLT_RULE	PERIOD_ID	Character

SQL Object ID: TMPL000\_U01

Expression Text: UPDATE PS\_TL\_IPT1\_TMP SET PERIOD\_INSTANCE = (SELECT MIN(C.PERIOD\_SEQUENCE) FROM PS\_TL\_CALENDAR C WHERE C.PERIOD\_ID = %RuleTemplate() AND PS\_TL\_IPT1\_TMP.DUR BETWEEN C.START\_DT AND C.END\_DT) WHERE PROCESS\_INSTANCE = %ProcessInstance AND EXISTS (SELECT 'X' FROM PS\_TL\_CALENDAR C WHERE C.PERIOD\_ID = %RuleTemplate() AND PS\_TL\_IPT1\_TMP.DUR BETWEEN C.START\_DT AND C.END\_DT)

OK    Cancel

<b>Field or Control</b>	<b>Description</b>
<b>Required Field</b>	Select to indicate that the parameter must have a value. Deselect this field to allow a zero numeric value or an empty character field for this parameter.

<b>Field or Control</b>	<b>Description</b>
<b>Field Format</b>	<p>Select the format of the field, based on the definition of the selected field. The selected value in this field deals with the formatting of the parameter into the SQL statement.</p> <p>Select <i>Character without Quotes</i> to allow a character value that does not have quote wrappers. For example, in the statement “ ...AND TRC = ‘KUREG’...” <i>KUREG</i> has quote wrappers that identify the character value for the time reporter code. However, when you have logical or mathematical operators, such as &gt;, or &lt;, you do not want the character value surrounded by quote wrappers.</p> <p>The values are: <i>Character</i>, <i>Character without Quotes</i>, <i>Date</i>, <i>Date and Time</i>, <i>Numeric</i>, <i>Signed Numeric</i>, and <i>Time</i>.</p>





# Understanding the Batch Process in Time Administration

---

## Understanding the Time Administration Process Flow

The batch process in Time Administration converts reported and scheduled time into payable time. It executes the rules you defined using Time and Labor's online tools, selects time reporters for processing, combines time reporters into batches, determines the period to process, and calculates prior period adjustments before passing time reporter data to your payroll system or other applications.

The programs that make up the batch process are listed in the following table in the order in which they are run:

<b><i>Program Name (Technical)</i></b>	<b><i>Function</i></b>
TL_TIMEADMIN	Main Module
TL_TA000200	Step 1: Determining Time Reporters to Process
TL_TA000300	Step 2: Combining Time Reporters into Batches
TL_TA000400	Step 4: Building the Rule Map
TL_TA000501	Step 5: Batch Process Driver
TL_ABS_RSVL	Resolve Absence Data
TL_TA000600	Step 8: Matching Punches
TL_SCHRES_AE	Schedule resolve callable routine.
TL_TA000700	Step 9: Creating Intermediate Payable Time
TL_TA000750	Step 10: Tracking Attendance
TL_TA000850	Step 11: Apply Rounding
TL_TA_RULES	Rules Processing

<b><i>Program Name (Technical)</i></b>	<b><i>Function</i></b>
TL_TA000900	Step 12: Validate Data and Perform Estimated Gross
TL_VALD_MAIN	Step 13: Time Validation
TL_TA001000	Step 14: Processing Offsets
TL_TA001100	Step 15: Updating Payable Time
TL_TA001200	Approvals and Notifications
TL_TA001300	Step 16: Updating TR Status

The following sections present detailed information about each of these steps.

This diagram illustrates the Time Administration process flow

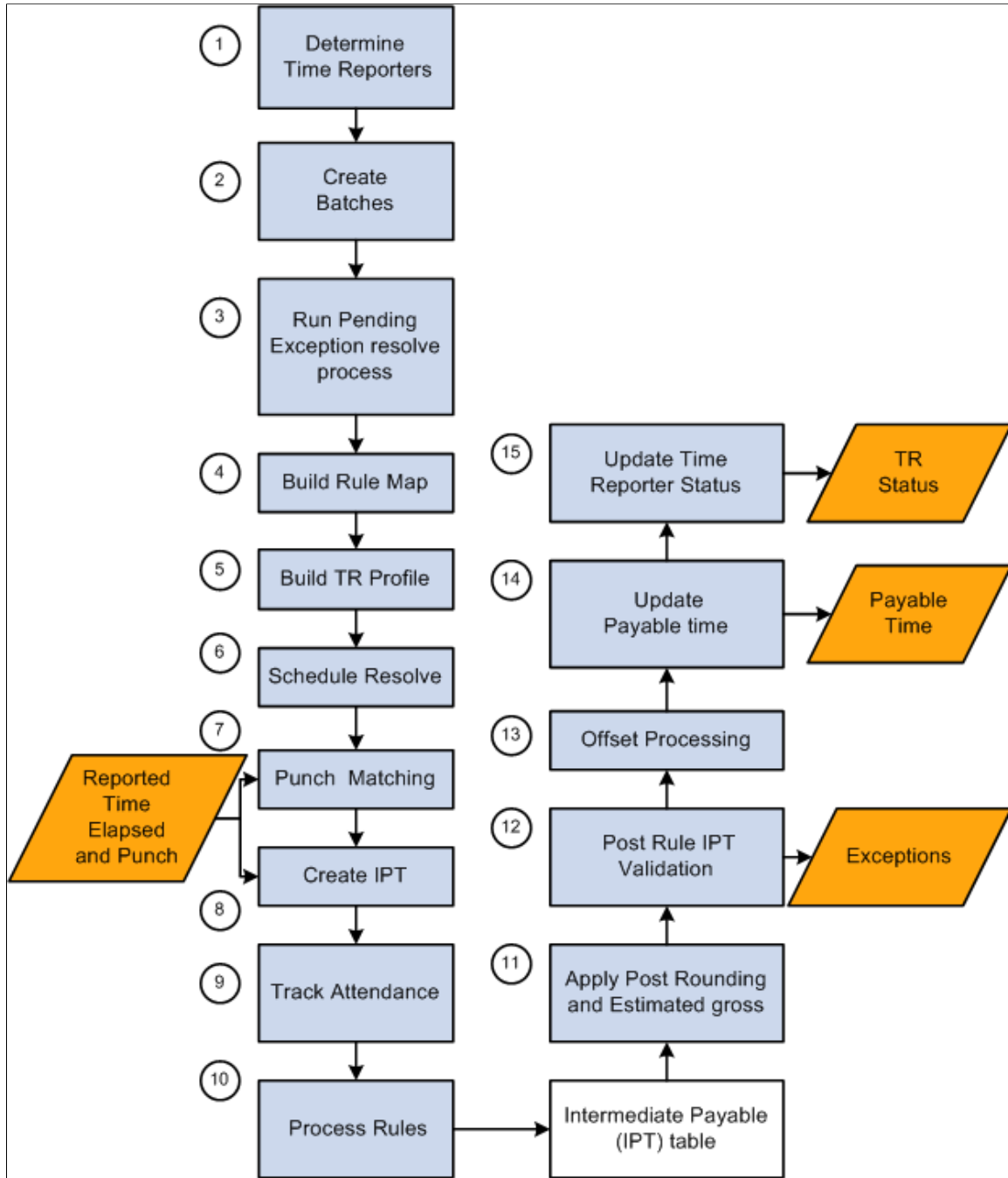

### Overview of the Time Administration Application Engine Processes

Time Administration, the core process in Time and Labor, produces payable time that is passed to other applications such as Payroll and Project Costing. It is critical that this process produces accurate results and successfully completes within a certain processing window. Time Administration is an iterative process that only processes records that need processing. Depending on the size of the population at your installation, you may need to configure Time Administration to run concurrently to reduce clock time in order to fit your processing window.

Time Administration is a complex process comprised of many Application Engine (AE) programs. The main driver for the Time Administration process is TL\_TIMEADMIN. When invoked, TL\_TIMEADMIN calls other Application Engine processes to perform various tasks. Most of these subprograms contain the prefix of TL\_TA followed by a six-digit number starting from 000200 to 001300. Subprograms that do not contain a number have been added to increase performance.

This diagram illustrates the subprograms called by TL\_TIMEADMIN

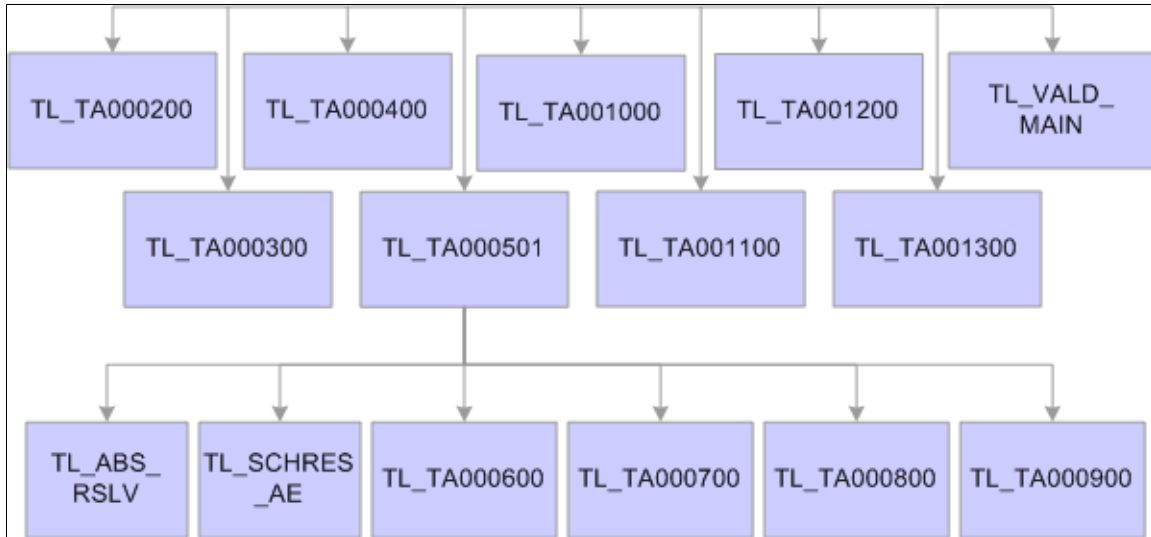

The following table lists the Application Engine processes associated with Time Administration and describes:

- The function of each Application Engine.
- Tables accessed during the Application Engine process.
- Tables updated during the Application Engine process.

<i>Application Engine</i>	<i>Function</i>	<i>Tables Accessed/Updated</i>
TL_TIMEADMIN	This is the main Time Administration driver program. It performs initialization tasks, calls other AE programs to perform various tasks, and performs finalization tasks.	<b>Note:</b> The following table names listed ending with XX are temporary tables. You will need to replace XX with the correct temp table instance number before accessing them. Temp table instance number can be found in your AET log file or the Temp Tables tab of the Process Monitor while the process is running.

<b>Application Engine</b>	<b>Function</b>	<b>Tables Accessed/Updated</b>
TL_TA000200	<ul style="list-style-type: none"> <li>• Calls TL_RCTRL_AE to resolve population specified on the run control as group(s).</li> <li>• Selects all multiple jobs regardless of the Time Administration status and earliest changed date even if multiple jobs are not specified on run.</li> </ul>	<p>Tables Accessed:</p> <p>TL_TR_STATUS – selects records with TA_STATUS of Y or X and EARLIEST_CHGDT &lt;= Process Date.</p> <p>Tables Updated:</p> <p>TL_TA_TRLISTXX – contains a list of time reporters to be processed in subsequent steps of Time Administration.</p>

<b>Application Engine</b>	<b>Function</b>	<b>Tables Accessed/Updated</b>
<p>TL_TA000300</p>	<ul style="list-style-type: none"> <li>• Groups time reporters into batches according to their workgroup, rule program, and start date.</li> <li>• Sets period of interest (POI) for each batch.</li> </ul> <p>Sets TA_STATUS to X for time reporters being processed.</p> <ol style="list-style-type: none"> <li>1. Identifies employee workgroups.</li> <li>2. Checks if multiple jobs are in the same workgroup. If so, multiple jobs are included in the same batch of the EmplID/Rcd specified on the run control or resolved from the group population. At this stage POI for these jobs is based on the minimum earliest change date of all the jobs where TA_STATUS = 'Y'. If one of the jobs has a TA_STATUS = 'N' that job is included.</li> <li>3. If multiple jobs are not in the same workgroup, the code checks the TL installation option to include multiple jobs.</li> <li>4. If the TL installation option is configured to include these jobs, they are placed in another batch and these batches are based on the earliest change date and TA status.</li> <li>5. If the installation options is configured not to run multiple jobs, then multiple jobs are removed from further processing when they are not in the same workgroup.</li> <li>6. Batches are further broken up based on the employee workgroup changes, and any effective date change in a workgroup, and any effective date change in the rule program.</li> <li>7. The TL_EXC_RESL process occurs at this point to resolve pending time reporting exceptions (see the next row in this table).</li> </ol>	<p>Tables Accessed:</p> <ul style="list-style-type: none"> <li>• TL_INSTALLATION – contains Batch Size.</li> <li>• TL_TA_TRLISTXX – contains list of time reporters to be processed.</li> <li>• TL_TR_STATUS – sets TA_STATUS to X for all time reporters being processed.</li> </ul> <hr/> <p><b>Note:</b> You can adjust the batch size (Max Employees In Rules Run) on the Installation Options page to increase or decrease the number of batches.</p> <p>Tables Updated:</p> <hr/> <p>TL_TA_BATCH%XX – contains batches of time reporters.</p> <hr/> <p><b>Note:</b> There are many temp tables with the prefix TL_TA_BATCH that hold batch related data. TL_TR_STATUS – sets TA_STATUS to X for all time reporters being processed.</p> <hr/> <p><b>Note:</b> The Time Administration process deletes a batch when there is no reason to process the employees in the batch. The rows that are deleted from TL_TA_BATCH result in gaps in the table.</p> <hr/> <p>If there still are high severity exceptions that are not resolved (from source TVP / TVE) and if the <b>Continue with Exceptions</b> check box is cleared in the <b>Time Administration Options</b> group box on the TL Installation page, TimeAdmin will remove those employees from the current batch.</p>

<b>Application Engine</b>	<b>Function</b>	<b>Tables Accessed/Updated</b>
	<p>After all the above, the TA_STATUS is set to 'X' to restrict the same employee being processed in another Time Admin process in case of concurrent runs.</p>	
<p>TL_TA000400</p>	<p>Creates rule maps – contains rules to be executed in priority order for each batch.</p>	<p>Tables Accessed:</p> <p>TL_TA_BATCHXX – contains batches of time reporters.</p> <p>Tables Updated:</p> <ul style="list-style-type: none"> <li>• TL_TA_BAT_SUMXX – contains high-level rule information to be executed for each batch.</li> <li>• TL_RULE_MAPXX – contains detailed rule information to be executed in priority order for each batch.</li> </ul>

<b>Application Engine</b>	<b>Function</b>	<b>Tables Accessed/Updated</b>
<p>TL_TA000501</p>	<p>Calls TL_TRPROFILE – to create time reporter profiles.</p> <p>If Time and Labor is integrated with Global Payroll or Payroll for North America using Absence Management, or both, this step loads the Workgroup, PNA pay group and GP pay group attributes, including holiday configurations.</p> <ul style="list-style-type: none"> <li>• Truncates temporary tables contained in TL_WORK_TABLES.</li> <li>• Updates Run Time Statistics.</li> <li>• Calls TL_SCHRES_AE – to resolve schedules.</li> <li>• Calls TL_ABS_RSLV – to resolve absences.</li> <li>• Calls TL_TA000600 – to match punches, pre-rule punch rounding and applies day breaker options.</li> <li>• Calls TL_TA000700 – to create intermediate payable time (IPT).</li> <li>• Calls TL_TA000750 – to process attendance data.</li> <li>• Calls TL_TA000850 – to apply rules.</li> <li>• Calls TL_TA000900 – to apply post rule rounding, and to distribute the task profile.</li> </ul>	<p>Tables Accessed:</p> <p>TL_TA_BATCH%XX – contains batches of time reporters.</p> <p>Tables Updated:</p> <ul style="list-style-type: none"> <li>• TL_TA_BATCH%XX – contains batches of time reporters. Start date and end date get adjusted when there are changes.</li> <li>• TL_PROF_LISTXX – contains a list of time reporters for all batches being processed.</li> <li>• TL_PROF_WRKXX – contains a list of time reporters with JOB, EMPLOYMENT, PERSONAL, BADGE, and Time and Labor data.</li> </ul> <hr/> <p><b>Note:</b> TL_PROF_WRKXX can be used in custom rules to improve performance.</p>
<p>TL_SCHRES_AE</p>		<p>Tables Accessed:</p> <p>TL_PROF_WRK – contains time reporter data.</p> <p>Tables Updated:</p> <p>WRK_ADHOC_TAOXX</p>



<b>Application Engine</b>	<b>Function</b>	<b>Tables Accessed/Updated</b>
TL_ABS_RSLV		<p>Tables Accessed:</p> <ul style="list-style-type: none"> <li>• WRK_ADHOC_TAOXX, TL_RPTD_TIME</li> <li>• GP_ABS_EVENT – contains absence data.</li> <li>• GP_RSLT_ABS – contains processed absence data</li> </ul> <p>Tables Updated:</p> <ul style="list-style-type: none"> <li>• TL_ABS_WRKXX – contains absence data by DUR.</li> <li>• TL_TOTAL_QTYXX – contains employees quantity of reported time, scheduled time, absence by DUR.</li> </ul>
TL_TA000600	<p>Converts punch time into elapsed time by calculating duration between two consecutive punches. Applies day breaker options and applies pre-rule punch rounding.</p> <p>Before inserting schedule punch time into the punch match table, the system checks for absence data for the days.</p>	<p>Tables Accessed:</p> <ul style="list-style-type: none"> <li>• TL_RPTD_TIME – contains punch time entries.</li> <li>• WRK_ADHOC_TAOXX – contains schedule details and applies day breaker options to schedule punch time.</li> </ul> <p>Tables Updated:</p> <p>TL_MTCHD_1XX – contains matched punches.</p>
TL_TA000700	<p>Load absences (if integrated).</p> <p>Creates intermediate payable time (IPT) from matched punches (created by TL_TA000600), and reported elapsed time. Scheduled time is only created for workgroups with exceptions.</p>	<p>Tables Accessed:</p> <ul style="list-style-type: none"> <li>• TL_MTCHD_1XX – contains matched punches.</li> <li>• TL_RPTD_TIME – contains reported elapsed time.</li> <li>• WRK_ADHOC_TAOXX – contains scheduled time.</li> <li>• TL_TOTAL_QTYXX</li> <li>• TL_ABS_WRKXX – contains absence events reported in Global Payroll and Absence Management.</li> </ul> <p>Tables Updated:</p> <p>TL_IPT1XX – contains intermediate payable time data for all time reporters in the current batch.</p>

<b>Application Engine</b>	<b>Function</b>	<b>Tables Accessed/Updated</b>
TL_TA000750	Processes attendance data.	<p>Tables Accessed:</p> <ul style="list-style-type: none"> <li>• TL_IPT1– contains intermediate payable time data for all time reporters in the current batch.</li> <li>• WRK_ADHOC_TAOXX – contains scheduled time.</li> <li>• TL_ATTEND_PGMXX – contains attendance program data.</li> </ul> <p>Tables Updated:</p> <ul style="list-style-type: none"> <li>• TL_IPT1– contains intermediate payable time data for all time reporters in the current batch.</li> <li>• TL_ATTEND_HIST – contains attendance history data.</li> <li>• TL_ATTENDANCE – contains current attendance data.</li> </ul>
TL_TA000850	Calls TL_TA_RULES to apply rules in the order specified on the rule program for each batch.	<p>Tables Accessed:</p> <ul style="list-style-type: none"> <li>• TL_IPT1XX– contains intermediate payable time data for all time reporters in the current batch.</li> <li>• WRK_ADHOC_TAOXX – contains scheduled time.</li> <li>• TL_PROF_WRKXX – contains time reporter profiles.</li> </ul> <p>Tables Updated:</p> <p>TL_IPT1XX– contains intermediate payable time data for all time reporters in the current batch.</p>

<b>Application Engine</b>	<b>Function</b>	<b>Tables Accessed/Updated</b>
TL_TA000900	<ul style="list-style-type: none"> <li>Calculates estimated gross amounts.</li> <li>Applies rounding rules.</li> </ul>	<p>Tables Accessed:</p> <ul style="list-style-type: none"> <li>TL_IPT1XX– contains intermediate payable time data for all time reporters in the current batch.</li> <li>WRK_ADHOC_TAOXX – contains scheduled time.</li> <li>TL_PROF_WRKXXX – contains time reporter profiles.</li> </ul> <p>Tables Updated:</p> <p>TL_IPT1XX– contains intermediate payable time data for all time reporters in the current batch.</p>
TL_VALD_MAIN	<p>Post rule validation</p> <ul style="list-style-type: none"> <li>Validates data and issues exceptions based on the validation and exception configuration. (Validations are not run on absence rows.)</li> <li>Deletes resolved exceptions (no longer exists in TL_EXCEPT_WRK) from TL_EXCEPTION.</li> <li>Inserts new exceptions into TL_EXCEPTION.</li> <li>Updates unresolved exceptions with current date/time stamp.</li> </ul>	<p>Tables Accessed:</p> <ul style="list-style-type: none"> <li>TL_VALID_DATAxx — join of TL_RPTD_TIME and TL_IPT1 tables. All validations executed on this one record.</li> </ul> <p>Multiple exceptions can exist for each day.</p> <ul style="list-style-type: none"> <li>TL_EXCEPT_WRKXXX – contains a list of exceptions in the current batch.</li> <li>TL_EXCEPTION – contains updated exceptions.</li> </ul>
TL_TIMEADMIN.JB000	<ul style="list-style-type: none"> <li>Calculate Absence PT for NA employees</li> <li>Inserts into IPT1</li> </ul>	<p>Table Accessed:</p> <p>GP_PI_GEN_DATA — contains processed absence Positive Inputs</p>

<b>Application Engine</b>	<b>Function</b>	<b>Tables Accessed/Updated</b>
<p>TL_TA001000</p>	<p>Creates offsets.</p> <p>Creates offsets for absence rows that are from Global Payroll only.</p> <hr/> <p><b>Note:</b> Payroll for North America processes offsets for absences created and passes negative absence rows into TL_PAYABLE_TIME.</p> <hr/>	<p>Tables Accessed:</p> <ul style="list-style-type: none"> <li>• TL_IPT1XX– contains intermediate payable time data for all time reporters in the current batch.</li> <li>• TL_PAYABLE_TIME – contains payable time previously created.</li> <li>• TL_TA_BATCHXX – contains a list of time reporters in the current batch.</li> </ul> <p>Tables Updated:</p> <ul style="list-style-type: none"> <li>• TL_TA_SE_DATEXX – contains a list of employees in the current batch with start date and end date.</li> <li>• TL_TA_PAY_TMXX – contains payable time records for the current batch within start date and end date.</li> <li>• TL_TA_OFFST01XX – contains payable time rows from TL_PAYABLE_TIME.</li> <li>• TL_TA_OFFST02XX – contains intermediate payable time rows from TL_IPT1. Excludes rows if the RT_SOURCE is 'AM' or if the PAY_SYSTEM is 'NA.'</li> <li>• TL_TA_OFFSETXX – contains offset rows to be inserted into TL_PAYABLE_TIME.</li> <li>• TL_IPT1XX – contains intermediate payable time for the current batch. IN_BATCH field gets set to 'N' in TL_TA001000 for previously processed payable time rows that have not changed.</li> </ul>

<b>Application Engine</b>	<b>Function</b>	<b>Tables Accessed/Updated</b>
<p>TL_TA001100</p>	<ul style="list-style-type: none"> <li>• Deletes existing payable time or forecasted payable time.</li> <li>• Inserts new rows of payable time or forecasted payable time.</li> <li>• Updates Payable_Status on TL_PAYABLE_TIME.</li> <li>• Calls TL_PTCOMPB – to process Comp Time.</li> <li>• Deletes absence rows from TL_IPT1 if PNA is the payroll system and online rules are not run.</li> <li>• Does not delete absence rows if online rules are run, regardless of the payroll system (GP or PNA).</li> </ul>	<p>Tables Accessed:</p> <ul style="list-style-type: none"> <li>• TL_TA_SE_DATEXX – contains a list of employees in the current batch with start date and end date.</li> <li>• TL_PAYABLE_TIME – contains payable time previously created.</li> <li>• TL_TA_BATCHXX – contains a list of time reporters in the current batch.</li> <li>• TL_TA_OFFSETXX – contains offset rows to be inserted into TL_PAYABLE_TIME.</li> </ul> <p>Tables Updated:</p> <ul style="list-style-type: none"> <li>• TL_TA_PAYW_TMXX – contains payable time records for the current batch within start date and end date.</li> <li>• TL_TA_PAY_TMXX – contains sequenced payable time records for the current batch within start date and end date.</li> <li>• TL_PAYABLE_TIME – contains updated payable time.</li> </ul>
<p>TL_TA001200</p>	<ul style="list-style-type: none"> <li>• Notifies exception reviewers</li> <li>• AWE approvals</li> <li>• Direct approvals</li> <li>• Non-AWE approvals</li> </ul>	<p>Tables Updated:</p> <ul style="list-style-type: none"> <li>• TL_MGR_NOTIFY</li> <li>• TL_PAYABLE_TIME</li> <li>• TL_APP_PAY_HDR</li> <li>• TL_APP_PAY_LINE</li> </ul> <hr/> <p><b>Note:</b> TL_TA001200 is where Time Administration interacts with the AWE application.</p> <hr/>

<b>Application Engine</b>	<b>Function</b>	<b>Tables Accessed/Updated</b>
TL_TA001300	<ul style="list-style-type: none"> <li>• Sets TA_STATUS to <i>N</i> and ECD to Null for positive time reporters without exceptions.</li> <li>• Sets TA_STATUS to <i>Y</i> and ECD to the first day of the next period for exception time reporters without exceptions</li> <li>• Sets TA_STATUS to <i>Y</i> and ECD to the first instance of unresolved exception for all time reporters with exceptions.</li> </ul>	<p>Tables Accessed:</p> <ul style="list-style-type: none"> <li>• TL_TA_BATCHCXX – contains a list of time reporters in the current batch.</li> <li>• TL_EXCEPTION – contains all exceptions.</li> <li>• TL_TRSTAT_BFRXX – contains a list of time reporters for the current batch.</li> <li>• TL_TR_STATUS – contains a row for each time reporter enrolled in Time and Labor.</li> </ul> <p>Tables Updated:</p> <p>TL_TR_STATUS – contains an updated row for each time reporter enrolled in Time and Labor.</p>

## Understanding the Time Administration Control Table (TL\_TR\_STATUS)

TL\_TR\_STATUS is a control table in Time and Labor that is regularly updated by Time Administration and other processes. It is important to understand how and when this record gets created and updated, since it essentially controls the behavior of Time Administration.

When time reporters are enrolled in Time and Labor, the system creates a TL\_TR\_STATUS control record for each distinct time reporter. This control table is updated when certain changes are made to time related data. Specifically, there are two fields that tell Time Administration how much data to process for each time reporter:

- TA\_STATUS
- EARLIEST\_CHGDT

For exception and positive time reporters, TA\_STATUS is initially set to *Y* and EARLIEST\_CHGDT is set to the Time and Labor enrollment date.

When changes are made to reported time, EARLIEST\_CHGDT gets updated if EARLIEST\_CHGDT is later than the change date and TA\_STATUS is set to *Y*.

Time Administration selects records with TA\_STATUS = *Y* or *X* and EARLIEST\_CHGDT is earlier or equal to the Process Date specified on the run control to be processed.

At the beginning of Time Administration (TL\_TA000300), TA\_STATUS gets set to *X* to indicate to other processes that it is being processed.

At the end of Time Administration (TL\_TA001300), TA\_STATUS and EARLIEST\_CHGDT get updated as follows:

- For positive time reporters without exceptions, TA\_STATUS gets set to *N* and EARLIEST\_CHGDT gets set to the latest date of payable time. If no changes are made to reported time, positive time reporters will not be selected for processing in subsequent Time Administration runs.
- For exception time reporters without exceptions, TA\_STATUS gets set to *Y* and EARLIEST\_CHGDT gets set to the first day of the next time period (specified on work group). Exception time reporters will always be selected for processing in subsequent Time Administration.
- For all time reporters with exceptions, TA\_STATUS gets set to *Y* and EARLIEST\_CHGDT gets set to the first day of the exception. This way, exceptions will be processed and resolved.

---

**Note:** The Earliest Change Date (ECD) will be reset to the effective date upon rehiring or when reactivating a time reporter. ECD will not be reset if there are previous pending rows to be processed.

---

## Batch Processing Terms and Concepts

The following terms and concepts are used throughout the documentation on batch processing, and are defined:

<b>Term</b>	<b>Definition</b>
<b>Date Under Report (DUR)</b>	The actual date of the time being reported for a shift as defined by the Day Breaker Options and Day Breaker Range.
<b>Earliest Change Date (EARLIEST_CHGDT)</b>	<p>The date-under-report of the earliest addition or update to time-related data for a time reporter since the last Time Administration run.</p> <p>The earliest change date helps determine both the range of dates and the amount of data that will be processed for each time reporter.</p>
<b>TA Status (TA_STATUS)</b>	This field is used to determine whether a time reporter should be processed through Time Administration. Valid values are <i>Y</i> (the time reporter should be processed) and <i>N</i> (the time reporter should not be processed).
Process Instance	Has a process instance value when the TL_TR_STATUS was last updated by a batch process, such as Time Admin or Submit Time.

---

## Step 1: Determining Time Reporters to Process

This process can be divided into two phases.

<b>Field or Control</b>	<b>Description</b>
<p><b>Phase 1: Select Time Reporters for Processing</b></p>	<p>This process is initiated when you select groups or individuals to process on the Time Administration run control page. Among the groups or individuals you select, Time Administration processes those meeting the following criteria:</p> <p>If you are creating Payable Time, the system processes only time reporters whose TA_STATUS is Y and whose EARLIEST_CHGDT (earliest change date) is less than or equal to the current date or process date specified on the Time Administration run control page.</p> <p>All multiple jobs are loaded even if not specified on the run control page, irrespective of TL installation option. The TL installation option is used later on in the TL_TA000300 routine.</p> <hr/> <p><b>Note:</b> If you are forecasting Payable Time, the system does not use TA_STATUS or EARLIEST_CHGDT to select time reporters for processing. The only time it uses these fields to select time reporters is when creating actual Payable Time.</p> <hr/> <p>After the system has applied its selection criteria to the time reporters you entered on the Time Administration run control page, Time Administration populates the TL_TA_TRLIST Table with a final list of time reporters to be processed (it only processes time reporters in this list).</p> <hr/> <p><b>Note:</b> The system processes time reporters whose TA_STATUS is set to Y or whose EARLIEST_CHGDT is less than or equal to the current or process date specified on the Time Administration Run Control page.</p>
<p><b>Phase 2: Define Initial Period of Interest</b></p>	<p>This step determines the start (START_DT) and end dates (END_DT) of the initial period of interest for batch processing.</p> <p>The initial period of interest represents the minimum amount of time that must be processed for each time reporter you run through Time Administration. This data is stored in the TL_TA_TRLIST Table along with each time reporter's EMPLID and EMPL_RCD. Regardless of whether you are creating Payable Time or Forecasting Payable Time, the initial period of interest is defined (for each time reporter) as the workgroup period intersected by the EARLIEST_CHGDT. The end date of this period can extend beyond the workgroup period (as far out as the last date of reported time) if time is reported for future dates (that is, dates following the workgroup period).</p> <p>The initial period of interest start (START_DT) and end (END_DT) dates contained in the TL_TA_TRLIST table are referenced in Step 2—Combining Time Reporters into Batches, and are used to help group the population you are processing into batches.</p>

In what follows we discuss:



- How Time Administration uses the TA\_STATUS and EARLIEST\_CHGDT fields to narrow the time reporters you've entered on the Time Administration run control page to those who actually meet the criteria for processing.
- The TL\_TA\_TRLIST Table, which contains the final list of time reporters for processing and the start and end dates of the initial period of interest—information that is used in Step 2—Combining Time Reporters Into Batches.
- How Time Administration defines the initial period of interest.

## Related Links

[Launching the Time Administration Process](#)

[Understanding Workgroups](#)

[Understanding General Rules for Building Periods and Calendars](#)

## Using Time Reporter Status in the Selection Process

To understand how the system selects time reporters for processing, you must know how the application uses the TA\_STATUS and EARLIEST\_CHGDT fields on the TL\_TR\_STATUS table. This table stores information about who is eligible for processing and what the earliest addition or update to time-related data is for each time reporter since the last Time Administration run.

### Critical TL\_TR\_STATUS Record Fields

<i>Field Name</i>	<i>Description</i>
EMPLID	The time reporter's employee ID number.
EMPL_RCD	The time reporter's employee record number.
TA_STATUS	Indicates whether the time reporter should be run through Time Administration. Valid values are <i>Y</i> (the time reporter should be run) and <i>N</i> (the time reporter should not be run).
EARLIEST_CHGDT	The date-under-report of the earliest addition or update to time-related data for a time reporter since the last Time Administration run.  The earliest change date helps determine both the range of dates and the amount of data that will be processed for each time reporter.

---

**Note:** When forecasting Payable Time, the system does not check TA\_STATUS. It also uses the date you enter in the Process Period with this Date field on the Starting the Time Administration Process as the EARLIEST\_CHGDT for all selected time reporters.

---

As a rule, the system processes only time reporters whose TA\_STATUS is *Y* or whose EARLIEST\_CHGDT is less than or equal to the current or process date specified on the TA Run Control page. You set the run control date to either the current date or another date (the process date) depending on who you want to process and what periods you want to process.

The system processes time reporters whose TA\_STATUS is set to *Y* or whose EARLIEST\_CHGDT is less than or equal to the current or process date specified on the Time Administration Run Control page.

The TA\_STATUS and EARLIEST\_CHGDT fields in the TL\_TR\_STATUS table are updated at different times and for different reasons:

## Updating TL\_TR\_STATUS When There Are New Enrollments

When a time reporter is enrolled in Time and Labor, the system inserts a new row in the TL\_TR\_STATUS record.

For newly hired time reporters, the system sets TA\_STATUS to *Y* and the EARLIEST\_CHGDT to the date entered as the Payable Time Start Date on the Create Time Reporter Data page. If this date field is not completed, then the EARLIEST\_CHGDT is set to the TL enrollment date.

## Updating TL\_TR\_STATUS When There Is New or Modified Data

In the case of positive time reporters, when data is changed or new data is added that might affect payable time, TA\_STATUS is set to *Y* (if it was previously set to *N*) and the EARLIEST\_CHGDT is set to reflect the earliest date for which new time was reported or the earliest date for which existing time data was modified—even if the modification extends into prior periods.

In the case of exception time reporters, TA\_STATUS always equals *Y*, and the EARLIEST\_CHGDT is automatically reset, after processing, to the first day of the next workgroup period (this is the period immediately following the one intersected by the current date or process date used in the current Time Administration run). This enables the system to know which period to process in the subsequent run (the period to be processed is the one intersected by the earliest change date).

---

**Note:** After a time reporter has been processed, the time reporter is not reprocessed unless new data is entered that causes the EARLIEST\_CHGDT field to be reset in the period that was just processed or in a prior period.

---

There are three sources of new or modified data that can cause the TL\_TR\_STATUS record to be updated:

- The report by Time Period or Week views on the Timesheet page (for punch and elapsed time), and the Web Clock – Enter Punch page can cause the EARLIEST\_CHGDT to be set to the earliest date of reported time and the TA\_STATUS to be set to *Y*.
- Batch time entered through the TCD Interface, Rapid Time pages, or Mass Time pages goes through Submit Time and starts the Validation process, which causes TL\_TR\_STATUS to be updated.
- Changes to effective-dated rows of information using the online system initiates Referential Integrity and starts the Validation process. The Validation process updates TL\_TR\_STATUS.

**Note:** The Validation process resets the EARLIEST\_CHGDT to reflect retroactive changes in data. If a time reporter is affected by these changes, but does not have data going back as far as the earliest change date, the system recognizes this and sets the EARLIEST\_CHGDT to coincide with the first actual instance of reported or scheduled time. For example, suppose that employee A has time data going back to 5 January 2002. This is also the day he joined Workgroup A. Now suppose that the Time and Labor administrator finds that all time reporters in Workgroup A should have been in Workgroup B beginning on 1 January 2000. Because time reporter A only has time date going back to 5 January 2002, his earliest change date will be set to 5 January 2002.

The following table describes the conditions that update the Earliest Change Data and TA Status:

<b>Condition</b>	<b>ECD (Earliest Change Date)</b>	<b>TA Status</b>
1. Upgrade: When Payable time exists	Maximum Date of Payable Time + 1 date in Payable Time	Y
2. Upgrade: When no payable time exists	Current Datetime	Y
3. When Employee Enrolled in T&L	Either TL Enrollment Date or Date > Effective Date entered in (Payable Time Start field on Create Time Reporter Data)	Y
4. When Employee changes from Positive to Exception Workgroup, or Workgroup type is changed from Positive to Exception	All Employees impacted are determined, and ECD becomes the Effective date of the change, if current ECD > Effective date of the change	Y (Changed from N to Y)
5. Positive Workgroup: When Out Punch is missing for Max Date processing	ECD will remain on missing out punch date	N
6. Positive Workgroup: When Out Punches are reported or time for Elapsed Reporter is processed	Next Period Begin Date	N
7. Positive Workgroup: When Exceptions are generated	Minimum date of Exception Generated	Y
8. Exception Workgroup: When time is processed for the current period	Next Period Begin Date	Y
9. Exception Workgroup: Exceptions are generated	Minimum date of Exception Generated	Y

<b>Condition</b>	<b>ECD (Earliest Change Date)</b>	<b>TA Status</b>
10. In case of Holiday: If the maximum date of payable time generated, is less than the End date of the Period of Interest (POI). ECD will be adjusted to the holiday date to trigger holiday template rules.	To the date of Holiday date.	TA Status will depend on positive or exception workgroup

### Resetting TL\_TR\_STATUS at the End of a Time Administration Run

At the end of a Time Administration run, the system resets the values in the TL\_TR\_STATUS record as described in step 16, Updating TR Status.

### Updating Status as a Result of a Processing Exception

When an exception of high severity is generated (one that prevents a time reporter from being fully processed), the time reporter's TA\_STATUS and EARLIEST\_CHGDT is not reset in the usual way. Instead, TA\_STATUS will remain Y and the EARLIEST\_CHGDT is changed to the earliest Exception date, so that the time reporter can be processed again after the exception is resolved. For example, suppose that time is originally reported for September 7, 2004 through September 21, 2004, where TA\_STATUS = Y and EARLIEST\_CHGDT = September 7, 2004. After Time Administration is run, an exception is created for September 15, 2004. TA\_STATUS remains Y and EARLIEST\_CHGDT is reset from September 7 to September 15.

#### Related Links

[Launching the Time Administration Process](#)

[Defining Exceptions](#)

[Using Validation Criteria](#)

[Viewing and Updating Time Reporter Status](#)

## Defining the Initial Period of Interest

After you have specified the population you want to process, Time Administration determines the start (START\_DT) and end dates (END\_DT) of the initial period of interest for batch creation. This initial period represents the minimum amount of time that must be processed for each time reporter you run through Time Administration. This data is stored in the TL\_TA\_TRLIST table along with each time reporter's EMPLID and EMPL\_RCD.

---

**Important!** The explanation of the initial period of interest above, assumes that the Use Reported Time for POI check box on the Process Time Admin page is selected. For an explanation of what happens when the check box is cleared, see the Process Time Admin page.

---

**Note:** The initial period of interest start (START\_DT) and end (END\_DT) dates contained in the TL\_TA\_TRLIST Table are referenced in Step 2, Combining Time Reporters into Batches, and are used to help group the population you are processing into batches.

---

The following table lists the critical fields in the TL\_TA\_TRLIST table:

<b>Field</b>	<b>Use</b>
BATCH_NUM	This number represents the initial assignment of time reporters to a batch for processing.
EMPLID	Identifies the time reporter to be processed.
EMPL_RCD	Identifies a specific job or position.
START_DT	This is the start of the initial period of interest.
END_DT	This is the end of the initial period of interest.
EARLIEST_CHGDT	This is the earliest date of reported time for the time reporter.
RUN_CNTL_ID	This is the run control ID entered on the run control page for Time Administration processing.

To determine the START\_DT and END\_DT contained in this table (the initial period of interest for batch creation), the selection process does the following:

- It determines the EARLIEST\_CHGDT for the time reporter being processed.
- It identifies the time reporting period (based on the Time Period ID in the workgroup table) intersected by the EARLIEST\_CHGDT.
- It uses the begin and end dates of the time reporting period intersected by the earliest change date as the begin and end dates of the initial period of interest. The selection process then queries the reported time tables (both punch and reported) to see if time has been reported for a future date (that is, a date following the time reporting period). If so, the end date of the initial period of interest is set to the last date of reported time.

The start and end date information in this table is used in Step 2—Combining Time Reporters into Batches.

### **Example: Determining the Initial Period of Interest**

Suppose that the EARLIEST\_CHGDT for the time reporter you are processing is 2 February 2000, and you run Time Administration on 7 February 2000 (the current date). Assume that the time reporting period associated with this time reporter's workgroup is weekly, and that the week is defined to begin on Monday and end on Sunday. The timeline for this time reporter would look like this:

This graphic illustrates the example: Determining the Initial Period of Interest

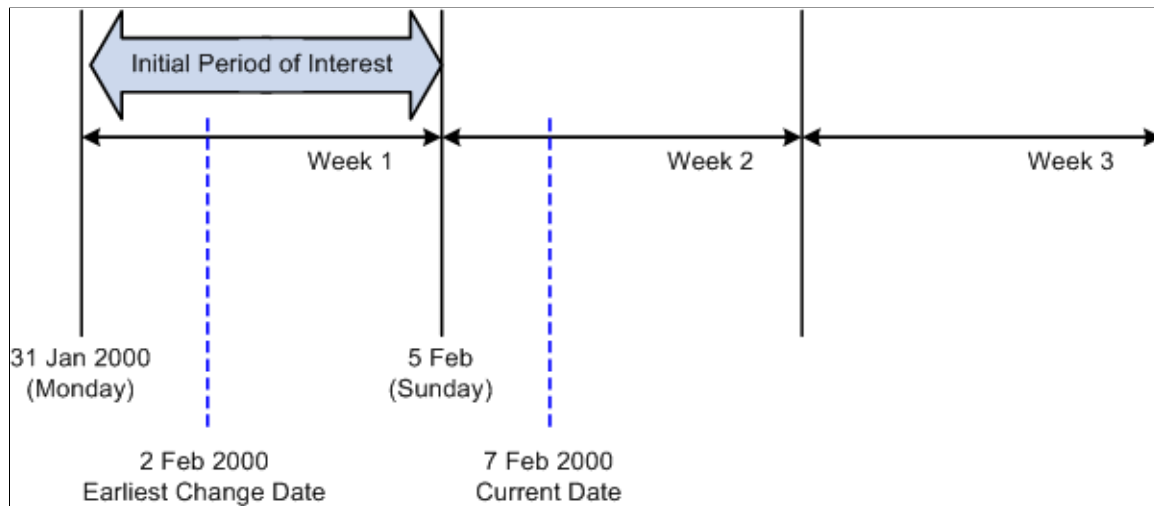

As you can see from the timeline, the EARLIEST\_CHGDT for the time reporter intersects a weekly calendar period that begins on January 31, 2000 (Monday) and ends on February 5, 2000 (Sunday). The system uses the begin and end dates of this week to establish the initial period of interest: January 31 – February 5.

## Step 2: Combining Time Reporters Into Batches

This process takes the time reporters listed in the TL\_TA\_TRLIST Table and their initial period of interest begin and end dates and organizes them into batches based on workgroup affiliation.

To create batches:

1. Define Workgroup Affiliation.

The system determines the workgroup affiliation of the selected time reporters and organizes them into batches by workgroup. This ensures that all time reporters processed as part of the same batch share a common rule program (because each workgroup is associated with one rule program).

If a time reporter switches workgroups during the initial period of interest stored in the TL\_TA\_TRLIST Table, the system detects the transfer when it reads the time reporter's TL\_EMPL\_DATA record. The transfer causes Time Administration to process the time reporter in more than one batch. The same thing occurs when there are changes to Rule Program effective dates or TL\_EMPL\_DATA effective dates during the initial period of interest—effective dates associated with employee hires, inactivation, or job transfers. For example, if the rule program associated with a workgroup changes in mid period, time reporters are processed in separate batches on either side of the change date. Similarly, because a time reporter could have more than one row in TL\_EMPL\_DATA with different effective dates, multiple rows per time reporter can be pushed into the batch creation process. In this case, start dates and end dates for each batch must be adjusted for such things as the TL\_EMPL\_DATA.EFFDT falling within the initial period of interest. For example, if the EFFDT of a time reporter is greater than the START\_DT of the initial period of interest defined in the TL\_TA\_TRLIST Table, the START\_DT of the new batch will be set equal to the EFFDT.

2. Send batches to Rule Map.

The resulting batches are then sent to the Determine Period of Interest function for time reporters described in the Building the Rule Map section. The batches contain a record for each of the time reporters to be processed, the time reporter's workgroup, workgroup effective date, rule program, and rule program effective date.

---

**Note:** The system separates time reporters into batches for efficient processing by grouping time reporters with the same Rule Program and common dates. However, it is possible that the resulting batch size may be too large to ensure rapid processing. If so, you can reduce the size of batches by completing the Max Employees in Rules Run field on the TL Installation page.

---

### Related Links

[Making Workgroup Transfers](#)

[Making Changes to a Rule Program of a Workgroup](#)

---

## Step 3: Resolving Pending Time Reporting Exceptions

Among other things, the TL\_TA000300 process validates reported time for the days where there are unresolved exceptions. This process calls validation application engine sections for only those exceptions which are still unresolved. It does not call all the validations as defined in the validation set.

This process clears exceptions if exceptions are not recreated.

This process also recreates exceptions if they are still unresolved.

The Clean Up Exception process (run by clicking the **Clean Up Exceptions** button) on the Manage Exceptions page, doesn't have to be run as Time Admin cleans up exceptions. However if a user would like to be proactive about exceptions, this process can be run.

If exceptions are recreated, Time Admin will not process data for the days of the exceptions for that time reporter.

In addition, the process excludes employees from further processing when there are exceptions, if, on the Time and Labor installation page, the **Continue with Exceptions** field is not selected.

---

## Step 4: Building the Rule Map

The initial period of interest used to create batches of time reporters in Step 2 represents only the minimum amount of data (or time) that must be processed in Time Administration. This initial period does not necessarily include all the time needed to process the rules in a time reporter's rule program. To determine both how far back into the past and forward into the future Time Administration must go to retrieve, for each batch, 1) the data needed to run each individual rule in a time reporter's Rule Program, and 2) the maximum amount of data encompassing the entire group of rules in the Rule Program, Time Administration must define a second period of interest. In the following section, we refer to the maximum period of time containing the data needed to run all the rules in a rule program as the final period of interest. In addition to defining this period, the Build Rule Map process generates an output table (TL\_RULE\_MAP) identifying the rules to process for each batch, the priority of the rules, the AE

Section containing each rule in the rule program, the effective dates of both the workgroup and the rule program, and other data.

After the rule map is complete, Time Administration sends the correct amount of time to the Intermediate Payable Time tables for processing and identify the AE section for each rule and period of interest.

## Determining the Final Period of Interest

As noted earlier, the initial period of interest constitutes only the first step in the definition of a period for rules processing.

---

**Important!** The following explanation of the final period of interest assumes that the Use Reported Time for POI check box on the Process Time Admin page is selected. For an explanation of what happens when the check box is cleared, see Process Time Admin page.

---

The final rule map may need to be extended beyond this initial period:

- If a rule you are processing requires data from *before* the time reporting period intersected by the EARLIEST\_CHGDT, the initial period of interest must be expanded back in time. For example, suppose that the time reporting period associated with the workgroup you are processing is weekly, and that the initial period of interest is the third week of the current month. If you are processing a monthly rule in connection with this workgroup, the final rule map will need to extend past the initial period of interest to capture data going back at least to the beginning of the month.
- The rules you are processing may require data from periods following the period intersected by the earliest change date. The data required may extend to the end of a rule period that both includes and goes past the initial period of interest end date.

The following example illustrates how the system determines the maximum date range for the final period of interest:

### Example: Determining the Final Period of Interest

Assume that the following is true:

- The time reporter you are processing is a positive time reporter.
- The time reporting period on the time reporter's workgroup is weekly, and the week is defined to begin on Monday and end on Sunday.
- The initial period of interest—the weekly time reporting period intersected by the earliest change date—extends from February 7 to February 13 (Monday through Sunday).
- The last period processed for the payee is the week of January 31 (Monday) through February 6 (Sunday).
- The current week (the week to be processed) begins on February 7.
- The payee has 3 rules in his rule program as represented in the following diagram: a weekly rule, a monthly rule, and a daily rule. Each of these rules is assigned a priority from one to three.
- The Earliest Change Date is February 7.
- The Process Date on the run control page is February 17.



- The latest date of reported time is 25 February (in this example, the employee has reported a future vacation from February 23 to February 25).

This diagram illustrates the example: Determining the Final Period of Interest

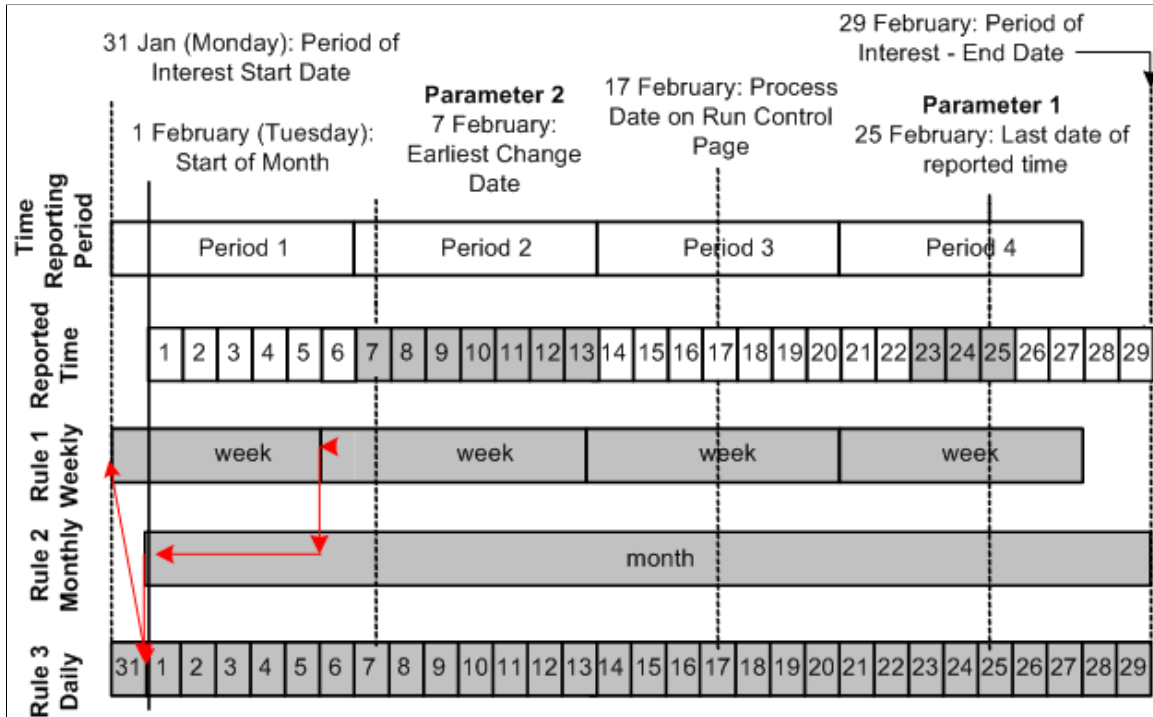

Time Administration determines the maximum date range for the period of interest through a process called pyramiding (represented in the diagram by a series of lines leading in stair-step fashion from the beginning of one rule period to the next in order of priority). The algorithm that Time Administration uses to define the begin and end dates of this period can be broken down into the following steps:

- Time Administration determines the latest date of reported time. In the preceding example, this date is February 25. This date—identified as Parameter 1 in the diagram—is used to determine the final period of interest end date.

**Note:** If no time is reported for future periods—that is, periods outside the period intersected by the earliest change date—the date of Parameter 1 is the last day of the time period intersected by the earliest change date (the end of Period 2 in our example). This date is used in the following step.

- Using the date of Parameter 1, the system selects the latest date from all of the rule periods intersected by Parameter 1. In the diagram, the rule period with the maximum end date intersected by Parameter 1 is the monthly rule (rule number 1). Because the end date of this rule period is February 29, this is the date the system uses as the final period of interest end date.
- The system then determines the earliest date that an instance of Payable Time has *not* been passed to Payroll for the set (that is, the EARLIEST\_CHGDT). This includes any adjustments that have been made to reported time since the previous update to payroll. This date, identified as Parameter 2 in the diagram, is used to determine the final period of interest start date.
- To determine the period of interest start date, the Rule Map process:

- Locates where the earliest change date (EARLIEST\_CHGDT) intersects the rule period corresponding to rule 1 in the rule program. It expands the period of interest to the start of this rule period (February 7).
- Locates where the start of rule period 1 intersects the next rule in order of priority—rule 2—and expands the period of interest back to the beginning of rule period 2 (February 1).
- It starts the process over again by locating where the start date of rule period 2 intersect the next rule in the priority list—rule 3—and expands the period of interest start date back to the beginning of rule period 3 (because rule 3 in this example is a daily rule, the period of interest stays at February 1).
- The rule mapping program then moves back *up* through each rule period to capture additional time that may be needed to process any rule that could influence Payable Time. Consider the example: The weekly rule period that begins January 31 and ends February 6 overlaps with the monthly rule period. Because the weekly rule has priority and can therefore influence time (alter a TCD, create new rows in TL\_IPT1, and so forth) that will later be processed by the monthly rule, the rule map pyramids backwards not just to the start of the monthly rule (February 1), but to the start of the first weekly rule period that could potentially affect the monthly rule: this is the weekly rule period that begins on January 31.

---

**Note:** The purpose of going back up through the rule program can be explained as follows: Suppose that the weekly rule in the example is an overtime rule that states that all time reporters should be paid at the overtime rate of 1.5 x Regular for each hour over 40. If the Rule Map process does not move back up through the rules to include the data for January 31, the system won't know if or when the condition for this rule was fully satisfied, and incorrect time data could then be passed to the monthly rule. Consider this scenario: Your time reporters all work ten hours a day for 5 days during the week beginning January 31. If the weekly overtime rule does not include the first day of the workweek— January 31—it will appear that no one worked overtime during the week. But in fact, the condition needed to initiate overtime pay was met at the end of the fourth day of work (x 10 hours per day). This means that the last day of the week must be paid at the overtime rate. This information can then be made available to the monthly rule, because there are dependencies between the rule periods.

---

## Understanding How Time Administration Uses the Final Period of Interest

After the system has defined the range of dates that make up the final period of interest, Time Administration:

- Transfers the data for this range of dates to Intermediate Payable Time.
- After Intermediate Payable Time has been processed, Time Administration passes all or part of this time to Payable Time.

In this section we discuss the difference between the final period of interest, Intermediate Payable Time, and Payable Time, and then describe how Time Administration calculates Payable Time.

## Understanding the Relationship between the Final Period of Interest, Intermediate Payable Time, and Payable Time

The range of dates transferred to Intermediate Payable Time is exactly equivalent to the final period of interest. This period includes all the data needed to process each rule in your rule program. However, the amount of data in Intermediate Payable Time can differ from the time data that Time Administration

transfers to Payable Time. This is because the function of Payable Time is to supply time data to external systems, for example, Payroll or Project Costing, while the function of the period of interest Rule Map is to supply Intermediate Payable Time with the data needed to run Time and Labor rules. The range of dates needed to process these rules may be considerably larger than the range of dates needed by Payroll or Project Costing. For example, suppose you are processing a workgroup whose period type is weekly, and that the week you are processing falls in the middle of the month. The rule program for this workgroup contains several monthly rules. Your payroll system may only be interested in data for the week you are currently processing, but your Time and Labor rules need data going back at least to the beginning of the current month (to satisfy the needs of your monthly rules).

Let's examine the following rules for how Time Administration creates Payable Time for positive time reporters, and then review what occurs in the case of an exception reporter.

## Rules for Positive Time Reporters

To create Payable Time for positive time reporters, Time Administration transfers to Payable Time all dates within the current time reporting period for which time has been reported positively.

In addition, Payable Time includes:

- Any positively reported time for dates before the current workgroup period.
- Any positively reported time for dates following the current workgroup period.
- Payable Time also includes days for which time has been created using rules processing.

## Example: Payable Time for Positive Time Reporters

Let's use a slightly modified version of the example we used earlier to illustrate the Building the Rule Map Process to show the type and extent of the data that can be passed from Intermediate Payable Time to Payable Time. Assume the following:

- The time reporter we are processing is a positive time reporter.
- The time reporting period on the time reporter's workgroup is weekly, and the week is defined to begin on Monday and end on Sunday.
- The last period processed for the payee is the week of 31 January (Monday) through 6 February (Sunday).
- The current week (the week to be processed) begins on 7 February.
- The payee has 3 rules in his rule program as represented in the following diagram: a monthly rule, a weekly rule, and a daily rule. Each of these rules is assigned a priority from one to three.
- The Process Date on the run control page is 17 February.
- The latest date of reported time is 25 February (in this example, the employee has reported a future vacation from 23 February to 25 February).
- The time reporter enters new time data for 6 February, a day that has already been processed and sent to payroll: He originally reported working 8 hours on 6 February when he actually worked 12, and has now corrected the mistake.
- The earliest change date is 6 February—the day for which the time reporter has entered new data.

This graphic illustrates the example: Payable Time for Positive Time Reporters

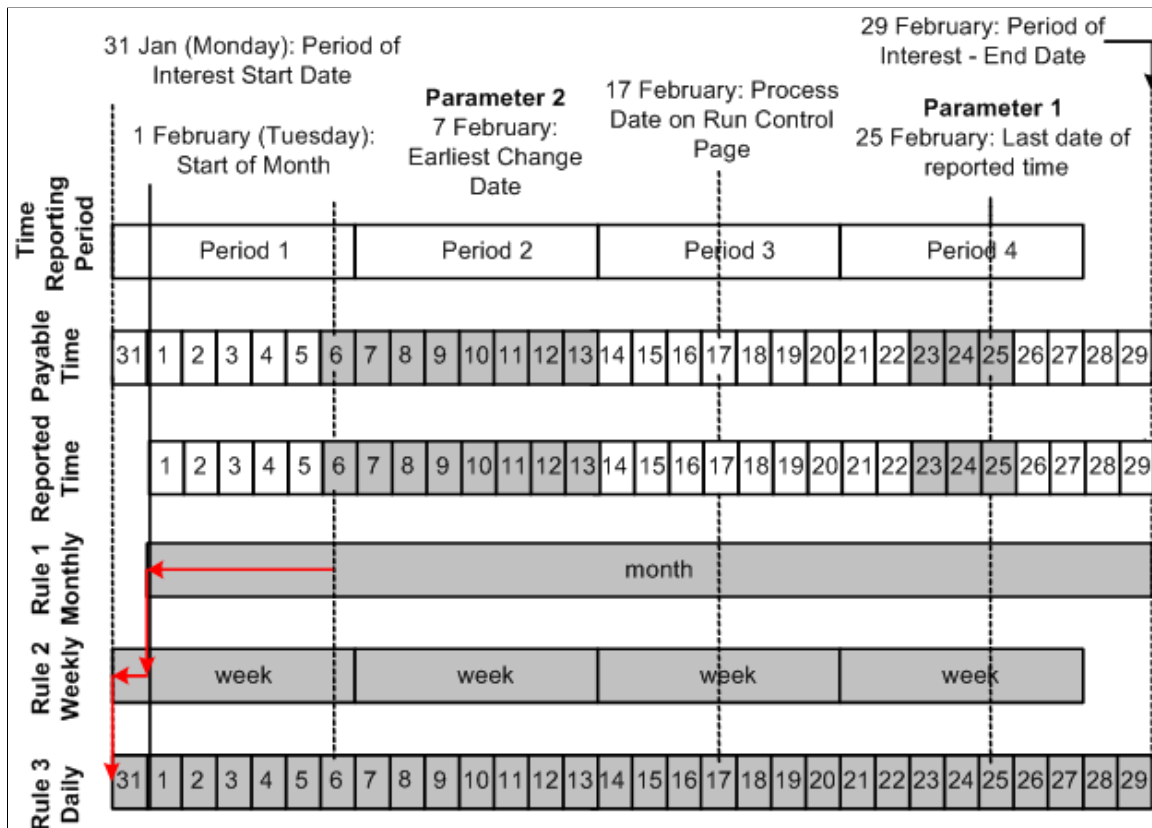

This diagram illustrates the different sources of time data that can be transferred to Payable Time.

*Source 1: Positively Reported Time within the Current Workgroup Period*

In this example, the time reporter has reported time for each of the days in the time reporting period that begins on February 7 and ends on February 13. The data for these dates is therefore passed to Payable Time.

*Source 2: Positively Reported Time for Dates Prior to the Current Workgroup Period*

As illustrated in the preceding diagram, the time reporter reports new time data for June 6—a day that falls within a previously processed period (he originally reported working 8 hours on February 6 when he actually worked 12).

*Source 3: Positively Reported Time for Dates Following the Current Workgroup Period*

In this example the time reporter reports three future vacation days: February 23, 24 and 25 . This data must be passed to Payable Time.

*Source 4: Time Created Using Rules Processing*

To illustrate this last source of data, we need to make a small modification to our example. Let's assume that the monthly rule in the diagram states that as soon as a time reporter works more than 10 hours of overtime in a given month, any overtime hours paid at the normal rate must be recalculated and paid at twice the normal rate. Let's also assume that the new data our time reporter has entered for February 6 (see Source 2) increases the total number of overtime hours worked for the month to 11 hours. Because of this, the condition for the monthly rule is satisfied, and all previously reported overtime hours must be

recalculated using the new rate (2 x normal rate). Assuming that our time reporter logged overtime hours on February 1-5 at the normal rate, these days (marked by cross-hatching in the diagram) are recalculated, offsets generated, and new data sent to Payable Time.

---

**Note:** The Process Date, Use Current Date or Use Reported Time for POI fields on the run control page, have no *direct* affect on what is sent to Payable Time in the case of positive time reporters—its primary function is to select time reporters for processing. Time Administration processes only time reporters whose earliest change date is less than or equal to ( $\leq$ ) the Process Date. However, in addition to selecting time reporters for processing, it also aids in determining the end date to process. The end date equates to the time period end date based on the field selected: Process Date, Use Current Date or the maximum date reported for Use Reported Time for POI field.

---

## Rules for Exception Reporters

To create Payable Time for exception reporters:

- Time Administration creates Payable Time from the time reporters' schedules for all dates within the current time reporting period (as long as the current period falls within the period of interest). If any day within this period has positive time reported for it, the positive time takes precedence over scheduled time—that is, Time Administration does not use the scheduled hours for that day.
- In addition to the dates within the current time reporting period, Payable Time includes:
  - Any positively reported time for dates before the current workgroup period.
  - Any positively reported time for dates following the current workgroup period.
  - Payable Time also includes days for which time has been created using rules processing.
- In the case of exception reporters, you can also use the Process Date on the run control page to send additional data to Payable Time according to the following criteria:
  - If any rule period you are processing is greater than or equal to the current workgroup period length, you can create Payable Time outside the current workgroup period by placing the Process Date outside the workgroup period but within the date range of the rule period that extends into the future. When you do this, you'll create Payable Time from the start of the current workgroup period up to the end of the time reporting period in which you set the Process Date—as long as the rule period extends at least to the end of this time reporting period. If the rule period ends before the time reporting period, then the last date for which time data will be passed to Payable Time is the end date of the rule period.
  - If all rule period lengths are less than or equal to the current workgroup period length, then Payable Time will be created from the time reporters' schedules for the current workgroup period (time reporting period) only—regardless of the Process Date.
  - Regardless of how far past the current workgroup period a rule period extends, if you use a Process Date that is within the date range of the current workgroup Time Period ID, Time Administration creates time for exception reporters for the current workgroup period only (regardless of the date ranges for the rule periods).

**Note:** Because of the widely differing results you can get, we do not recommend that you set the Process Date after the current workgroup period. This ensures that all exception reporters will have time created for them within the current period.

**Example 1: Expanding Payable Time to the End of a Future Workgroup Period**

Let's view an example in which we use the Process Date to expand Payable Time from the current workgroup period to the end of a future period.

This graphic illustrates the example using the Process Date to expand Payable Time from the current workgroup period to the end of a future period

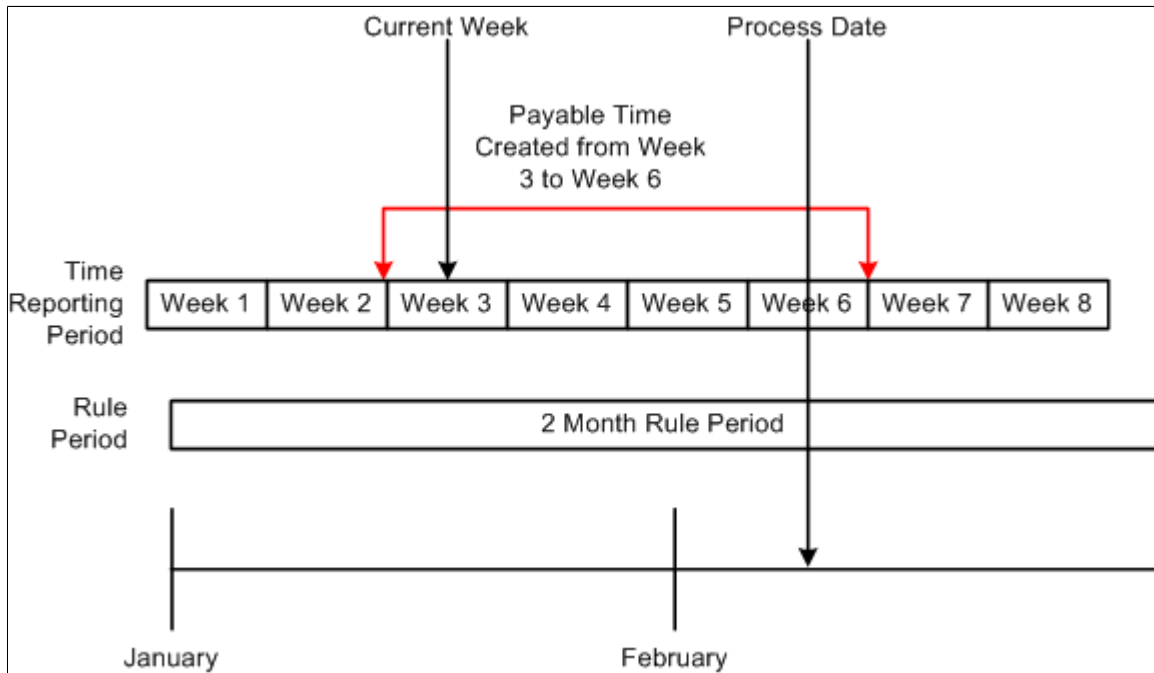

Assume the following:

- Week 3 is the current workgroup period (the week to be processed).
- There is a two-month rule associated with the workgroup.
- The Process Date is set to Week 6.

Because the two month rule period that begins in January extends past the current workgroup period (Week 3) to the end of February, when we set the Process Date to Week 6, Payable Time will be created from schedules to the end of Week 6.

**Example 2: End of Rule Period Limits Extension of Payable Time**

This is an example in which the end of rule period limits the extension of payable time.

This graphic illustrates the example in which the end of rule period limits the extension of payable time

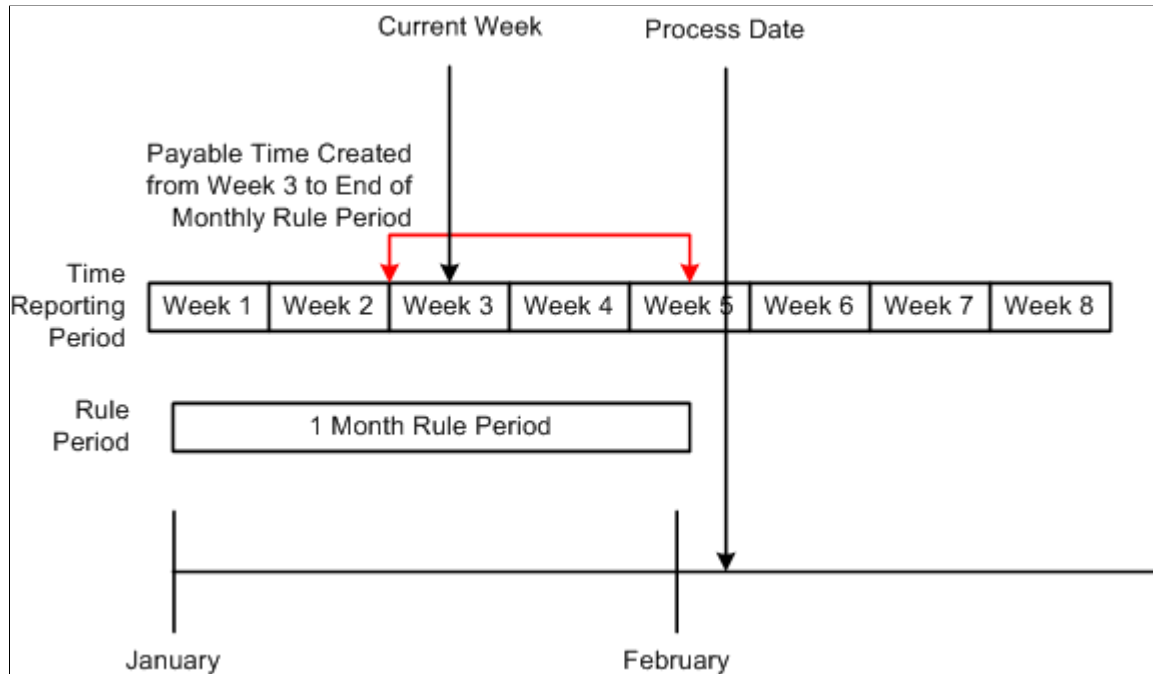

Assume the following:

- Week 3 is the current workgroup period (the week to be processed).
- There is a one-month rule associated with the workgroup.
- The Process Date is set to the end of Week 5; however, the one month rule period ends before this—in the middle of Week 5.

Because the one month rule period in this example extends past the current workgroup period (Week 3), when we set the Process Date to the end of Week 5, Payable Time will be created into the future. However, Payable Time will not be created past the last day of January, even though the Process Date is in February. This is because Payable Time extends either to the end of the time reporting period intersected by the Process Date, or to the end of the rule period—whichever comes first.

---

**Note:** In this example, if we had set the Process Date to the first day of Week 5, Payable Time would still only be created to the end of January. Again, this is because Payable Time extends either to the end of the time reporting period intersected by the Process Date, or to the end of the rule period—whichever is first.

---

## Understanding the Sources of Payable Time

We've reviewed several examples of how to use the Process Date on the run control panel to extend Payable Time past the current workgroup period. Let's examine a more comprehensive example that illustrates all the sources of time data that can be transferred to Payable Time in the case of an exception reporter:

### Example 3: Determining Payable Time for Exception Reporters

Assume that the following is true:

- The time reporter you are processing is an exception time reporter.

- The time reporting period on the time reporter's workgroup is weekly, and the week is defined to begin on Monday and end on Sunday.
- The last period processed for the payee is the week of January 31 (Monday) through February 6 (Sunday).
- The current week (the week to be processed) begins on February 7.
- The payee has 3 rules in his rule program as represented in the following diagram: a monthly rule, a weekly rule, and a daily rule. Each of these rules is assigned a priority from one to three.
- The earliest change date is February 6.
- The Process Date on the run control page is February 15.
- The latest date of reported time is February 25 (in this example, the employee has reported a future vacation from February 23 to February 25).
- The time reporter enters new time data for 6 June, a day that has already been processed and sent to payroll: He originally reported working 8 hours on 6 June when he actually worked 12, and has now corrected the mistake.
- The earliest change date is February 6 – the day for which the time reporter has entered new time data.

This graphic illustrates the example: Determining Payable Time for Exception Reporters

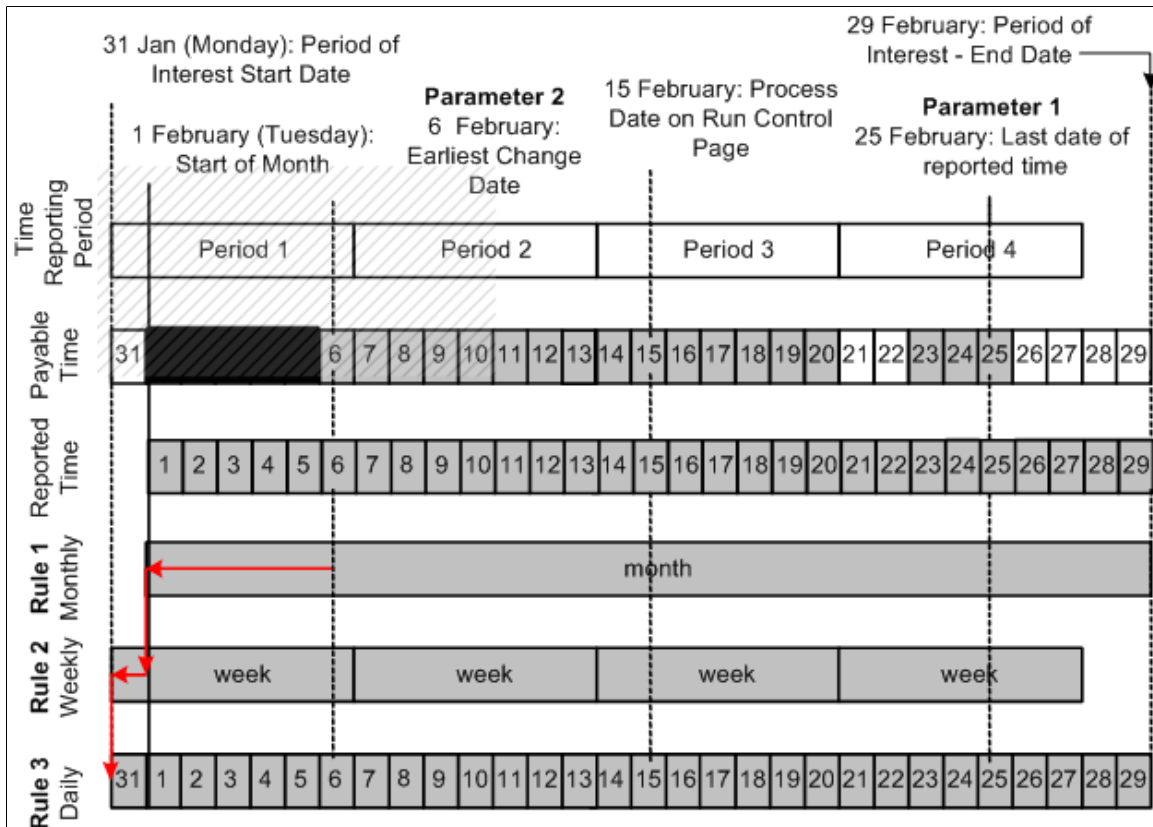

Using this diagram, we can illustrate the different sources of time data that can be transferred to Payable Time.



*Source 1: Time within the Current Workgroup Period*

In this example, the current workgroup period begins on February 7 and ends on February 13. The data for these dates is therefore passed to Payable Time.

*Source 2: Time Created by Setting the Process Date after the Current Workgroup Period*

Because the monthly rule period in this example extends past the current workgroup period, and the Process Date (February 15) has been set outside the workgroup period, Payable Time is created into the future—as far out as the end of Period 3 (the time reporting period intersected by the Process Date).

*Source 3: Positively Reported Time for Dates Prior to the Current Workgroup Period*

As illustrated in the preceding diagram, our exception reporter positively reports new time data for June 6—a day that falls within a previously processed period (he was scheduled to work 8 hours on June 6 when he actually worked 12).

*Source 4: Positively Reported Time for Dates Following the Current Workgroup Period*

In this example the time reporter reports three future vacation days: February 23, 24 and 25 . This data must be passed to Payable Time.

*Source 5: Time Created Using Rules Processing*

To illustrate this last source of data, we must make a small modification to our example. Let's assume that the monthly rule in the diagram states that as soon as a time reporter works more than 10 hours of overtime in a given month, any overtime hours paid at the normal rate must be recalculated and paid at twice the normal rate. Let's also assume that the exception reporter in our example positively reports new time for February 6 (see Source 3), and that the newly reported hours increase the total number of overtime hours worked for the month to 11 hours. Because of this, the condition for the monthly rule is satisfied, and all previously reported overtime hours must be recalculated using the new rate (2 x normal rate). Assuming that our time reporter logged overtime hours on February 1-5 at the normal rate, these days (marked by cross-hatching in the diagram) will be recalculated, offsets generated, and new data will be sent to Payable Time.

**Related Links**

[Launching the Time Administration Process](#)

---

## Step 5: Building Time Reporter Profiles

This process extracts time reporter data for each batch of time reporters from different tables in the HCM system and loads it into a single working table, TL\_PROF\_WRK, that you can refer to each time you need basic time reporter data within a rule. Thus, rather than having to refer to multiple tables, you can check a single table containing data on the time reporters in each of your batches for the period of interest defined by the Building the Rule Map process. When you create rules in SQL, you can define a join to this table to retrieve common information relating to all the time reporters you must process.

**Related Links**

[Understanding Time Administration](#)

[Understanding Rules](#)

---

## Step 6: Explaining the Time Administration Main Batch Loop Driver

TL\_TA000501 performs the following actions:

- Checks that there are time reporters to process.
- Processes each batch of time reporters
- Ensures that the PSTZOFFSET table is appropriately loaded for the POI that Time Admin is processing and allocates the Payable Time Sequence Number.

---

## Step 7: Explaining Batch Driver Calls of Time Administration

TL\_TA000501 checks if reported punch time exists and conditionally calls TL\_TA000600 when either reported time exists or scheduled time has punch schedules.

It then calls the TL\_TA000850 rules engine driver program and then calls the TL\_TA000900 process which distributes task and post rules rounding.

If Paybill is installed the Paybillstaffing process FO\_TL\_OVR\_RT is called to update the override rate. The Comp Time process is called to validate compensatory time balances for each batch. All the intermediate payable time is accumulated into the TL\_VALID\_DATAxx table.

---

## Step 8: Matching Punches

The Punch Matching process transforms raw punches into a first cut of Intermediate Payable Time. It does this by first selecting punches that fall within the date range specified by the Building the Rule Map process. The Punch Matching process calls the schedule resolution process to resolve the time reporters' schedules.

To match punches:

1. Select all appropriate punches for processing.

The system gathers punches from either the time reporter's scheduling table (WRK\_ADHOC\_TAO) if Forecast Payable Time was chosen on the Time Administration Run Control page (or the time reporter is of the exception type), or the reported Punch Time Table (TL\_RPTD\_TIME).

To select the appropriate punches for processing, the system checks the TL TA Batch file which contains the list of time reporters to select from and the start/end date for each time reporter. The system identifies the first punch to process by looking for the last out punch that occurred before the start date in the TL TA Batch file, no matter how far back in the calendar it must go. If it locates an out punch before the start date, it knows that it must use the first in punch on the start date as the initial punch for processing. Otherwise, it begins processing with the last in punch that occurred before the start date. This ensures that the system begins processing with the correct first punch, even if that punch was entered before the initial start date.

If the last punch selected using the end date is not an out punch, the system checks the future for the next out punch and stores all punches up to and including the next out punch.

## 2. Apply pre-rules rounding.

Time Administration checks the rounding options you selected on the Workgroup page to determine whether it should round punches. There are three options for rounding on this page: Round Punches Before Rules (Punch Rounding), Segment Rounding, and Day Rounding.

Each rounding option can have a different effect on how time is processed and the amount of time that is converted to Payable Time. In other words, two time reporters could each record the same in and out punches for a day or a week, but depending on the rounding options you select, the amount of time sent to Payable Time could be different for each time reporter.

The Punch Matching process is only concerned with the first option: Round Punches. The other two types of rounding are applied as part of the Round Punches subprocess described in Step 11 – Performing Post-Rules Rounding.

---

**Note:** The Round Punches process is skipped if Forecast Payable Time is chosen on the run control page, because scheduled punches are already rounded.

---

## 3. Apply daybreaker logic.

This subprocess is initiated only when the Split By Day Breaker option is selected on the Workgroup page. Depending on the day breaker logic you select, you can apply all the time worked in a shift to the day on which the shift begins; split the time using a day breaker; apply all the time to the day on which the shift ends; or assign the time to the day in which the majority of the time falls. So for example, if a time reporter works a shift that begins at 8:00 p.m. and continues until 5:00 a.m. of the next day, and you select 12 midnight as the day breaker, 4 hours would accrue to the day on which the time reporter began work, and 5 hours would go to the subsequent day.

## 4. Calculate the duration of punches.

When the system encounters a series of punches, it converts punch time into output that resembles elapsed time. It does this by matching a punch with the next corresponding punch and then calculating the difference between them (the amount in TL\_QUANTITY). The resulting in and out segments, as indicated in the following table, are then sent to Intermediate Payable Time for use in rules processing.

<b>Punches</b>	<b>Begin</b>	<b>End</b>	<b>TL_QUANTITY</b>
In	8:00	10:00	2.00
Break	10:00	10:15	.25
In	10:15	12:00	1.75
Meal	12:00	13:00	1.00

<b>Punches</b>	<b>Begin</b>	<b>End</b>	<b>TL_QUANTITY</b>
In	13:00	15:00	2.00
Break	15:00	15:15	.25
In	15:15	17:00	1.75
Out	17:00		

---

**Note:** The Calculate Duration process is skipped if Forecast Payable Time is selected on the Run Control page. This is because time reporter schedules already contain the calculated duration between punches.

---

### Related Links

[Setting Up Day Breaker Options](#)

---

## Step 9: Creating Intermediate Payable Time

Before Time Administration can execute a rule, it moves the data needed to run the rule from scheduled and reported time into a data store known as Intermediate Payable Time. The system then applies the rule to information in the data store for the appropriate period of interest (as defined by the Build Rule Map process).

This section discusses the structure of the Intermediate Payable Time data store, and the type and source of the data it contains.

### Understanding the Data Store

The Intermediate Payable Time data store is made up of the following five tables:

- TL\_IPT1
- TL\_IPT2
- TL\_IPT3
- TL\_IPT4
- TL\_IPT5

All of these tables use the same TL\_IPT\_SBR sub-record.

Initially, Time Administration loads all reported and scheduled time data for all time reporters who must be processed into TL\_IPT1. In your rules, you can move data back and forth between TL\_IPT1 and the other Intermediate Payable Time Tables, or to other working tables in the system. For example, your rule could move time data from TL\_IPT1 to TL\_IPT2, apply a specific TRC to this time, and then update the original row of data in TL\_IPT1 with the new TRC associated data.

**Note:** Only processed data in TL\_IPT1 is transferred to Payable Time at the end of the Time Administration run. Therefore, after your rules work on the data in other tables, you must return any processed data you want to send to Payable Time back to TL\_IPT1.

**Warning!** Never truncate or delete the data in TL\_IPT1; it contains time data in raw form that is needed to execute your rules. If you delete this data, your rules will be left with nothing to process.

This diagram illustrates the movement of data from scheduled and reported time to Intermediate Payable Time, and from Intermediate Payable Time to Payable Time

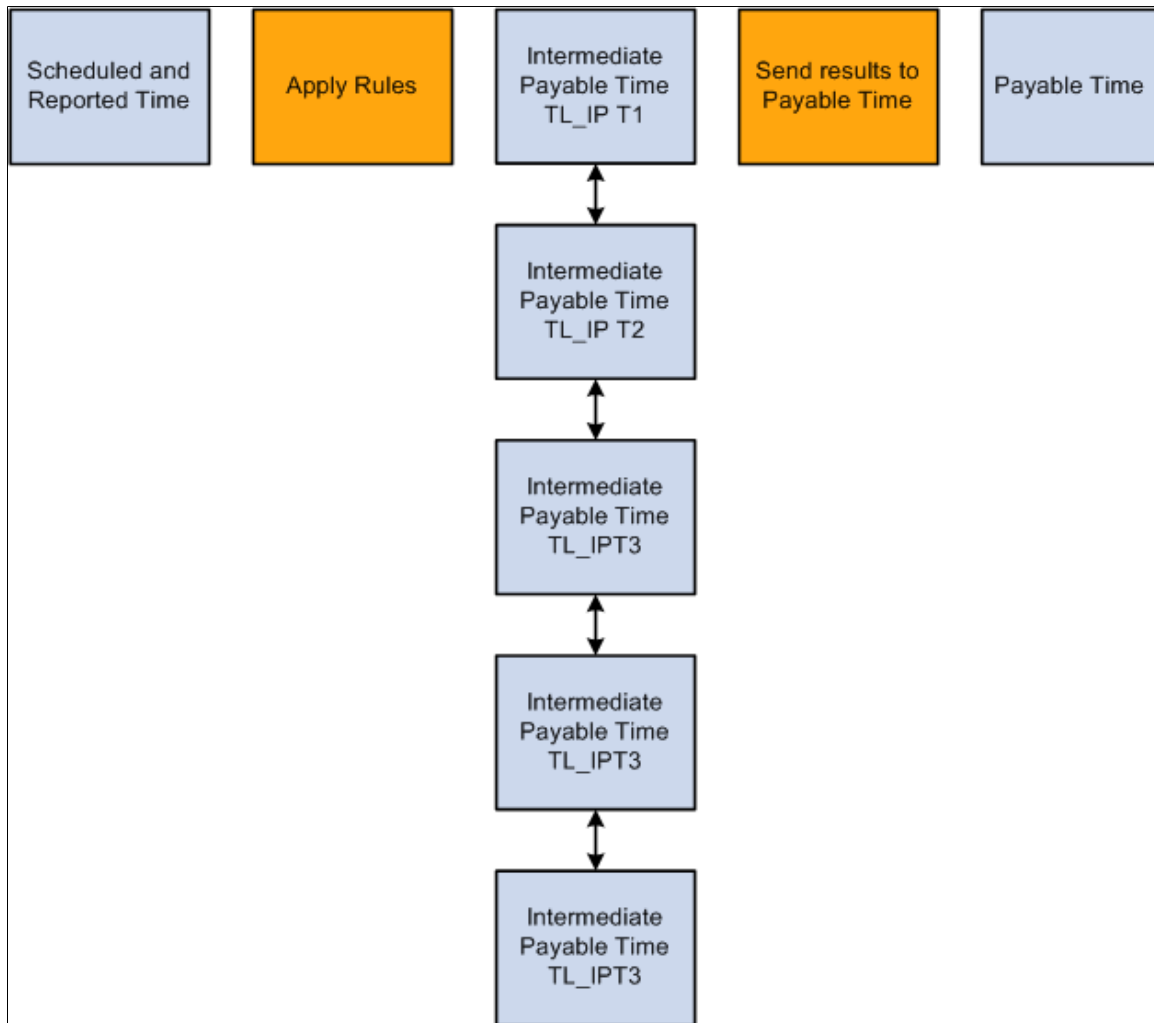

### Loading the IPT Tables

For each batch of time reporters it processes (in CREATE\_IPT), Time Administration loads data into TL\_IPT1 from the following sources, This information is used later by the Create Payable Time process.

#### Reported Time

The following applies to reported time:

- For elapsed time reporters, the system retrieves reported elapsed time from the Elapsed Time Table (TL\_RPTD\_TIME).
- For punch time reporters, the system retrieves rounded punches created by the Rounding Punches process that runs before the Create IPT process.
- For exception time reporters, the system pulls time from the schedule table (WRK\_ADHOC\_TAO) for days the time reporter was scheduled to work. (If an exception time reporter positively reports time on a particular day, the reported time takes precedence over the scheduled time.)
- If a person reports both elapsed and punch time on the same day, Time Administration retrieves both sets of time.
- If creating Forecasted Payable Time and reported time is not available, Time Administration fetches scheduled time for positive time reporters from the WRK\_ADHOC\_TAO Table.

## Absences

If your Time and Labor system is integrated with Global Payroll, Payroll for North America with Absence Management, or both, this step loads absence rows to TL\_IPT1. Approved absences are loaded to the TL\_AM\_WRK table from the GP\_ABS\_EVENT table, which contains absence events reported in Global Payroll or Absence Management. The system resolved the rows for holiday configurations, time reporting codes and schedules.

### Absence Management, Time and Labor, and Payroll for North America Only

TL\_TA0007000.GA000 resolves the absence time reporting data that needs to be brought into the TL\_ABS\_WRK table and inserts the Absence data into TL\_IPT1 by performing the following steps:

- Copying absence data from the TL\_ABS\_WRK table to TL\_ABS\_NA\_WRK for PNA employees.
- Deleting absence data in TL\_ABS\_WRK for PNA employees.
- Inserting absence data from TL\_PAYABLE\_TIME into TL\_ABS\_WRK by joining TL\_ABS\_NA\_WRK, TL\_PAYABLE\_TIME, GP\_PIN, TL\_ERNCD and TL\_PROF\_WRK.

At this point all of the absence time reporting codes in TL\_ABS\_WRK are populated.

- Calling Section 2 to update the SEQ\_NUM field in TL\_ABS\_WRK with a unique number.
- Inserting Absence data from TL\_ABS\_WRK into TL\_IPT1.
- Updates the SEQ\_NBR in TL\_ABS\_WRK table.
- Inserts partial hours into TL\_IPT1 by joining TL\_ABS\_WRK, TL\_TOTAL\_QTY and TL\_PROF\_WRK. Section 3 is only called when the workgroup time type is set to Exception Time Reporting and the Create Partial Work Hours for Partial Absence field is selected on the Workgroup – Definition page.

---

**Important!** Absence data is not populated for rules processing in the following scenarios:  
When GP\_ABS\_EVENT contains absence data but the data is not present in TL\_PAYABLE\_TIME (Absence Conversion is not run).

When absence data is present in TL\_PAYABLE\_TIME but not available in GP\_ABS\_EVENT in case of a delete or void after running the Absence Conversion process and before running Time Administration. In this scenario, data in TL\_PAYABLE\_TIME is pending an update from the Absence Conversion process.

When the Absence data in Payable time is populated by the Absence Conversion process.

Rules that specify a Result (Action) of Replace within the Template-Built Rules definition only affect the time reporting codes that are not Absence or Comp time related.

---

## Task Information

The following applies to tasks:

- If a taskgroup was positively reported, its value populates the TL\_IPT1 Table. If no taskgroup was reported, Time Administration populates TL\_IPT1 with the taskgroup assigned to the time reporter on the Employee Data Table (TL\_EMPL\_DATA) through the Create Time Reporter Data page or Maintain Time Reporter Data page.
- If a task profile ID was positively reported, its value populates the TL\_IPT1 Table. If no task profile was reported, Time Administration populates TL\_IPT1 with the task profile assigned to the time reporter on the Employee Data Table (TL\_EMPL\_DATA) through the Create Time Reporter Data page or Maintain Time Reporter Data page. If it does not find a task profile on the Employee Data Table, it populates TL\_IPT1 with the default task profile associated with the time reporter's taskgroup in the Taskgroup Table (TL\_TASKGRP\_TBL).
- Task template IDs are always retrieved from the Taskgroup Table (TL\_TASKGRP\_TBL) to populate TL\_IPT1. Task template IDs are not positively reported.
- If task data was positively reported, the values of the task entities populate TL\_IPT1.

## Rules Override Transactions

If rule overrides have been entered through the Override Rules page, the Time Administration process extracts the overridden records from TL\_IPT1 and places them into the working table, TL\_TA\_RUL\_OVR, before applying rules to the data stored on TL\_IPT1.

Time Administration applies rules to all records stored on TL\_IPT1 and proceeds to update Payable Time as it normally does. But, as a final step, Time Administration uses data stored in the TL\_TA\_RUL\_OVR Table (preserved – untouched by rules) to replace records found on the TL\_PAYABLE\_TIME Table.

## Related Links

[Understanding Task Reporting Requirements](#)

[Understanding Time Administration](#)

[Understanding Rules](#)

---

## Step 10: Tracking Attendance

The Track Attendance process tracks attendance violations committed by punch time reporters including tardies, long lunches, early outs, and long breaks. It prompts you to take one of the recommended actions

you defined on the Attendance Actions page. This process catches violations by comparing actual punch times logged by punch time reporters to their schedules. If a time reporter punches in late, leaves early, or takes a long meal or break, the Attendance process can recognize the infraction. Each infraction receives a certain user defined point value and point values exceeding the threshold you established on the Attendance Program page will trigger a user-defined action. You can view the recommended actions for each time reporter on the Recommended Actions page.

### Related Links

[Understanding Time Administration](#)

[Understanding Rules](#)

---

## Step 11: Processing Rules

When you create a rule in Time Administration you must assign the rule to an Application Engine section. When it is time to execute the rule, Process Rules uses the Rule Map created in Step 4 – Building the Rule Map, to call the AE section for the appropriate rule and period of interest. Each rule in a Rule Program is processed for every time reporter to whom the rule applies at the same time.

---

**Note:** To protect the integrity of the source data, you should always run rules that change or manipulate time against the data in the Intermediate Payable Time tables rather than against the scheduled or reported time tables.

---

### Related Links

[Adding Rules to a Rule Program](#)

---

## Step 12: Performing Rounding, Task Distribution and Estimated Gross

This process performs the following functions:

- Calculates and validates leave and comp time balances.
- Updates each time reporter's task profile.
- Applies post rules rounding to processed time data.
- Calculates estimated gross amounts.

### Check Leave and Comp Time Balances

This subprocess ensures that leave and compensatory time hours recorded in the Intermediate Payable Time Table (TL\_IPT1) do not exceed the available balance. If reported hours exceed the available balance, an exception is written to the Exceptions Table. If the comp time balance or leave time balance is sufficient, Time Administration updates Payable Time.



## Check Leave Balance

This subprocess checks to see if there is sufficient balance to cover the leave time contained on the IPT Table for each time reporter. If there is insufficient balance, the system writes an exception to the Exceptions Table.

For the setup to be valid for leave processing to occur, the following conditions must apply:

- The TRC must be active and the Comp/Leave Indicator must be for Leave Taken (Leave Tkn).
- The Leave TRC must be of the Hours TRC Type.
- The TRC must be in the Time Reporter's TRC Program.
- The TRC must be mapped to a NA Payroll Earnings Code, which is mapped to a Leave Plan type and has the Taken Flag selected on the Add to Accrual Balance section of the NA Earnings code.
- The Time Reporter must be associated to a Leave Plan of the Leave Plan Type to which the NA Earnings Code is associated.
- The Leave Plan for the time reporter should specify if it allows a negative balance, and if so, how many hours the balance for the time reporter can go negative.

---

**Note:** Leave balances are maintained by PeopleSoft Benefits. Time and Labor does not update Benefits Tables with balance information; however, it uses the Leave Plan Table (LEAVE\_PLAN\_TBL) and Leave Accrual Table (LEAVE\_ACCRUAL) of the Benefits system to validate time reported against TRCs of leave, for the availability of leave. To allow leave balances to go negative, you must select the Allow Negative Balance check box on the Leave Plan Table, which is part of the Benefits system. The Maximum Negative Hours Allowed (MAX\_NEG\_HRS) field then becomes available for data entry, and you can specify the maximum negative hours allowed under the Leave Plan. This field remains hidden if the Time and Labor application is not selected on the Installation Table.

---

This sub-process can be broken down as follows:

To calculate leave balance:

1. Check the Time and Labor Installation Table.

The system checks the Time and Labor Installation Table to see whether leave balance validation has been selected. The user can select Online Only validation, Batch Only validation, Both Online and Batch validation, or None. If Both or Batch Only has been selected, Time Administration validates leave time.

2. Check the TRCs on the IPT Table against settings on the TRC Table.

The system checks the TRC on the Intermediate Payable Time Table TL\_IPT1 against the TRC Table TL\_TRCPGELE\_TBL for valid TRCs for the workgroup, and for the Comp Leave Indicator on TL\_TRC\_TBL. This subprocess runs for those TRCs you have defined as having an affect on comp/leave of *Leave Taken* on the TRC Setup page.

3. Check the Leave Accrual Table to calculate available hours.

The system checks the Leave Accrual Table to calculate available hours using the following formula:

<b>Field or Control</b>	<b>Description</b>
<b>Available Hours =</b>	Hours carried over from previous year + Earned year-to-date - Taken year-to-date + Adjusted year-to-date + Bought year-to-date - Sold year-to-date - Unprocessed hours taken - Unprocessed hours adjusted - Unprocessed hours sold

4. Check reported leave against the available balance.

The system checks reported leave against the available balance as follows:

If available hours + negative hours allowed is less than reported comp time taken, the system writes a high severity exception to the Exceptions Table. If this is not the case, the system continues processing.

### Check Comp Time Balance

This subprocess determines whether there is a sufficient balance to cover the compensatory time hours recorded on the TL\_IPT1 Table for each time reporter. If there is an insufficient balance, the system writes an exception to the Exceptions Table. If the balance is sufficient, the system updates the Payable Time Table.

For the setup to be valid for compensatory time processing to occur, note the following:

1. The Comp TRC must be active and have a Comp/Leave Indicator of either Comp Earned (CT Earned) or Comp Taken (CT Taken).
2. The Comp TRC must be of an Hours TRC Type.
3. The Comp Time TRC must be in the time reporter's TRC Program.
4. The Comp Time TRC must be associated to the time reporter's Compensatory Time Off Plan.
5. You must have defined the appropriate limits on the time reporter's Compensatory Time Off Plan.

This sub-process can be broken down as follows:

To calculate compensatory time balance:

1. Check Time and Labor Installation Table.

The system checks the TL Installation Table (TL\_INSTALLATION) to see if Comp Balance validation has been selected. The user can select Online Only validation, Batch Only validation, Both Online and Batch validation, or None. If either Batch Only or Both is selected, Time Administration validates comp time.

2. Check TRCs on IPT Table against settings on TRC Table.

The system checks TRCs on the Intermediate Payable Time Table TL\_IPT1 against TL\_TRCPGELE\_TBL for valid TRCs in the TRC Program, and TL\_TRC\_TBL for the Comp Leave Indicator on the TRC Table. For those TRCs defined as affecting CT Earned (Comp Time Earned) or CT Taken (Comp Time Taken) on the TRC Setup page, Time Administration processes them against the Time Reporter's comp plan.

3. Calculate available hours.
4. Load Compensatory Time Off rows into Comp Leave table (TL\_COMPLEAV\_TBL). The system summarizes the time for each day for Comp Time Earned and Taken, calculates the expiration dates for the earned rows, and loads the time into the TL\_COMPLEAV\_TBL with the End Balance=0.

5. Calculate the end balance for each day.

The system calculates the end balance for each day by taking into consideration the comp time hours earned, hours taken, and hours expired for each day and then updates the end balance on the TL\_COMPLEAV\_TBL.

6. Check comp time taken against available balance.

The system then checks to see if the reported Comp Time Taken is more than the available hours:

If reported Comp Time Taken is greater than the available hours plus negative hours allowed, the system writes a high-severity exception to the Exceptions Table. If the balance is sufficient to cover comp hours earned, and Payable Time is not yet updated, the system inserts a new row of data into TL\_PAYABLE\_TIME for the applicable TRCs.

7. Calculate comp time earned.
8. Check comp time earned against available balance.

The system checks to see if the reported Comp Time earned is more than the available hours:

If reported Comp Time Earned is greater than the available hours, the system writes a high-severity exception to the Exceptions Table. If the balance is sufficient to cover comp hours earned, and Payable Time is not yet updated, the system inserts a new row of data into TL\_PAYABLE\_TIME.

---

**Important!** Comp Time exception TLX0001 must be set to 'high' severity. A 'low' or 'medium' severity exception can create payable time. However, if the time reporter is reporting a comp TRC that is not in his comp plan, this is still an exception. Although the system can create the payable time, it cannot update the comp time balance. Therefore keep the severity of this exception as "High."

---

## Related Links

[Understanding Time and Labor Implementation](#)

[Defining TRC Programs](#)

[Understanding Exceptions and Validations](#)

## Expand Task Profiles

When a task profile is reported positively or has been updated by the system during Step 9--Creating Intermediate Payable Time, the Expand Task Profiles subprocess expands the corresponding Intermediate payable time records with proper detailed task data after rules have been applied.

For example, a time reporter may have reported the Task Profile "AB," which contains 50% of Project A and 50% of Project B. If the time reported is 8 hours, this process splits these 8 hours into 4 hours each for Projects A and B.

## Apply Post Rules Rounding

Time Administration checks the Rounding Option you selected on the Workgroup page to determine whether it should apply Segment Rounding or Day Rounding. If you have selected one of these rounding types, the system applies the specific rounding rules you defined on the Workgroup page.

---

**Note:** There are two types of rounding in Time and Labor: pre-rules rounding and post rules rounding. Pre-rules rounding applies only to punch time data. Segment Rounding and Day Rounding apply after rules have been processed, but before time is transferred to Payable Time.

---

### Related Links

[Understanding Workcenters](#)

## Calculate Estimated Gross

The Calculate Estimated Gross process determines the estimated gross for each row contained in the Intermediate Payable Time Table when you set the Calc Estimated Gross field on the TL Installation page to Y (yes).

The system uses the following formula to calculate the gross:

$$TL\_QUANTITY \times (COMPRATE + FACTOR\_RATE\_ADJ) \times FACTOR\_MULT$$

The components of this formula are defined as follows:

<b>Components/Fields</b>	<b>Definition</b>
TL_QUANTITY	The quantity entered by the time reporter or taken from the time reporter's schedule.
COMPRATE	Either a rate or a compensation rate code. The derivation of the rate code is explained in Step 1 under Calculate Estimated Gross.
FACTOR_RATE_ADJ	The Rate Adjustment Factor defined for the TRC on the TRC 1 page.
FACTOR_MULT	The Multiplication Factor defined for the TRC on the TRC 1 page.

To calculate estimated gross:

1. Derive the Comp Rate.

The Time Administration process derives the Rate in the Comp Rate variable as follows:

- a. When a time reporter enters an override rate on the time reporting pages, the system uses this rate. This rate resides in the Intermediate Payable Time Table TL\_IPT1.
  - b. When a time reporter enters a comp rate code on the time reporting pages, the system attempts to derive the rate in the Comp Rate Code (CRC) from the following locations in this order:
2. The Comp Rate Code Table (PS\_COMP\_RATECD\_TBL). If the comp rate is not there, it then checks:
  3. The Compensation Table (PS\_COMPENSATION); if the comp rate is not there, it then checks:
  4. The Job Code Table (more specifically, the PS\_JOB\_CD\_COMP\_RATE field on PS\_JOB).
    - a. If no rate or comp rate code is reported, the system checks for a rate on the TRC Table.

---

**Note:** If the Comp Rate Code (CRC) is HF (hourly + flat), the reported rates are added to the amount on the CRC and then inserted into the basic formula. If the CRC is PH (percent of hourly), the percent is calculated against the reported rate before inserting into the basic formula.

---

- b. If the system finds nothing in these locations, it uses the hourly rate associated with the TRC in the Intermediate Payable Time Table TL\_IPT1.

---

**Note:** When a TRC is of type Amount, the Quantity (QTY) is placed into the Estimated Gross field in Intermediate Payable Time. Other calculations are bypassed. If the TRC is of type Amount and is mapped to a NA Payroll Earnings Code where Mult Factor = 0, then the amount passed to IPT for Est Gross will be 0.

---

- c. If the system cannot find the information in the previous locations, it takes the hourly rate from the JOB Table to use in the calculation.
5. Calculate Estimated Gross.

If Reported Hours is not zero, the Estimated Gross amount is calculated using this formula:

$$TL\_QUANTITY \times (COMPRATE + FACTOR\_RATE\_ADJ) \times FACTOR\_MULT$$

The Estimated Gross amount is written to the Estimated Gross work Table (TL\_W2\_EST\_GRS) to be used in the final step.

---

**Note:** If a reported amount is populated in the Intermediate Payable Time Table, this amount automatically becomes the Estimated Gross amount. No further calculation is needed.

---

6. Update IPT Estimated Gross.

This step populates the Estimated Gross field on the TL\_IPT1 record with the Estimated Gross amount contained on the Estimated Gross Work Table.

---

## Step 13: Post Rule Validation

This step validates the data generated as a result of rules processing of task data and TRC data. Numerous validations are run during post rules processing. All the exceptions generated by these validations are delivered with Time and Labor and have a severity level of high. They are written to the TL\_EXCEPTION table. Payable Time is not created for time reporters on the days for which there are medium and high level exceptions.

Post Rules time validation in Time Administration applies to the TRC and task data created by rules processing. For example, you might create a rule that sets all time reported without a TRC to a TRC of Reg. In another rule, you might specify that all Reg hours over eight in a day should be paid at the overtime rate of 1.5 using the TRC "OVT1.5." Suppose, however, that the overtime rate represented by "OVT1.5" is no longer in the TRC program for the workgroup you are processing; instead, it has been replaced by a different TRC called OVTPay. In a case like this, Time Validation would generate an exception noting that the TRC "OVT1.5" was no longer valid for this workgroup.

---

**Note:** Customers should configure and use a validation set rather than enabling all validations to run.

---

### Processing Exceptions

This process updates the Exceptions Table (TL\_EXCEPTION) to include any new exceptions generated during the current batch run. When this table has been updated, go to the Manage Exceptions page to approve or clear out exceptions.

This process does the following:

- Compares new exceptions created in the current run to the unresolved exceptions that exist in the TL\_EXCEPTIONS Table.
- Sets the ACTION\_DTTM field on the TL\_EXCEPTIONS Table to *CurrentDateTime* for the exceptions that exist in both tables and deletes these exceptions from the working table.
- Updates the TL\_EXCEPTIONS Table by adding any new exceptions.
- Sets the status of resolved exceptions to *resolved*. After Time Administration has updated the status of an exception to *resolved*, it refers to the SAVE\_IND flag (save indicator) on the TL\_EXCEPT\_DEFN Table for the Exception ID. If the save indicator for that exception is *Y* (Yes), Time Administration archives the exception. If the save indicator is *N* (No), Time Administration deletes it.

---

**Note:** Time Administration does not process exceptions when it creates forecasted Payable Time.

---

### Related Links

[Using Validation Criteria](#)

[Understanding Exceptions and Validations](#)

---

## Step 14: Processing Adjustments

Time and Labor supports two types of adjustments: normal and record-only.

- Changes you make to reported time through the weekly and elapsed time reporting pages are considered normal adjustments. The frozen flag associated with a payable time entry determines how these adjustments are processed. (The frozen flag is set when time is approved, closed, or sent to payroll). Before the frozen flag is set, any changes you make will replace existing payable time entries. Changes made after the frozen flag is set will create offsetting entries that are sent to your payroll system.
- Changes you make through the Record Only Adjustment page are considered record-only adjustments. You typically enter record-only adjustments when you cut a manual check for a time reporter and then want to go back and enter the time history for that check. In record-only mode, the system does not create payable time, run the adjusted time through Time Administration, or send record-only adjustments to payroll.

This section discusses the process that generates offsets for normal adjustments.

## Related Links

[Understanding Payable Time](#)

## Understanding the Adjustment Process

An offset is the negative image of a current earnings for a given Date Under Report. (Date Under Report, or DUR, is the date for which time was reported.) The system creates offsets automatically when a DUR is adjusted. For example, suppose someone reports 8 hours of regular time for a given day, as the manager, you need to adjust this to 6 hours of regular time. If this 6 hours has already been processed by payroll, the adjustment you make creates an earnings row to offset the original amount of 8 hours regular (-8 hours) and creates a new earnings row containing the positive 6 hours of regular.

Offset records are created for every earnings for the day, regardless of whether earnings are modified or not. This implies that if a time reporter reported 8 hours of Regular, and 2 hours of OT, and the manager adjusts the Overtime amount, offsets are created for the Regular (-8) and the OT (-2) hours. Positive entries are also created for all earnings in the amount of the final snapshot of that day.

## Making Multiple Adjustments

If you adjust Time for a date under report several times, the process only checks the most recent set of adjustments. For instance, in the previous example, if the user makes another adjustment to the Date Under Report, the process uses the 6 hours of Regular to generate the offset (-6 hours), not the original 8 and the offset -8 earnings rows. Only the latest adjustments are processed.

## Determining When to Create Offsets

Adjustment processing occurs after rules and post-rules processes have been executed. Time Administration uses the following criteria to determine whether to create offsets for the data in an existing Payable Time record:

- The original time data for which the system is creating an offset or adjustment must have previously been closed or approved by the user, or processed by an external system such as payroll or project costing.

You can determine whether an adjustment will create an offsetting entry by checking the payable status (PAYABLE\_STATUS). Note that Time and Labor does not create offsets when the payable status is estimated or needs approval.

<b>Payable Status</b>	<b>Create Offsets?</b>
AP–Approved	Y
DN–Denied	Y
PB–Pushed Back	Y
CL – Closed	Y
SP – Sent to Payroll	Y
RP – Rejected by Payroll	Y
TP – Taken by Payroll	Y
PD – Distributed	Y
DL – Diluted	Y
ES – Estimated	N
NA – Needs Approval	N
NP – No Pay	N
IG – Ignore	Y
RV – Reversed Check	Y

- The system must be able to match the new Intermediate Payable Time record (the record that contains the new, adjusted data) with the original Payable Time record. In other words, the EmplID, Empl\_Rec#, and Duration (DUR) associated with the new record and old record must match.

If these conditions are met, the system creates two new entries in Payable Time: one to reverse or offset (multiply by negative one) the original entry and the second to insert new data.

---

**Note:** This step creates offsets for absence rows that are from Global Payroll only. Payroll for North America process create offsets for absences and updates payable time with negative absence rows.

---



## Example

The following example illustrates how this process works.

Original Payable Time data (TL\_PAYABLE\_TIME) that was reported, processed, and paid:

#	DUR	TRC	QTY	Est_Gross	Lbr_Dist_Amt	Diluted_Gross
1	1/2/00	Reg	4	40	40	40
2	1/2/00	Vac	4	40	40	40

New Data in Intermediate Payable Time (TL\_IPT1):

#	DUR	TRC	QTY
1	1/2/00	REG	8

Offsets to Payable Time data (TL\_PAYABLE\_TIME) that were reported, processed, and paid:

#	DUR	TRC	QTY	Est_Gross	Lbr_Dist_Amt	Diluted_Gross
1	1/2/00	Reg	-4	-40	-40	-40
2	1/2/00	Vac	-4	-40	-40	-40

## Related Links

[Understanding Payable Time](#)

## Step 15: Updating Payable Time

This process takes the final results of Intermediate Payable Time processing and inserts them into the Payable Time table, at which point the data becomes available to payroll or other subscribers to Time and Labor.

## Understanding the Difference between Payable Time and Intermediate Payable Time

Payable Time supplies time data to external systems like Payroll or Project Costing, while the function of Intermediate Payable Time is to make time data available internally for rules processing. The dates needed for rules processing may be considerably larger than the range of dates needed by your Payroll

system or Project Costing. For this reason, the range of dates transferred to Payable Time may not be identical to the range of dates originally loaded in the Intermediate Payable Time Table.

### Related Links

[Step 4: Building the Rule Map](#)

## Understanding How Time Administration Formats Payable Time

The Payable Time and Intermediate Payable Time (TL\_IPT1) tables organize and format data differently. In contrast to Intermediate Payable Time, Payable Time attempts to sum data with the same attributes (TRC and Task) to create consolidated lines of data. For example, if two punch segments created for a single day have the same TRC in Intermediate Payable Time, Time Administration adds them to create a single row in Payable Time. The same is true of task data, whether tasks are reported positively or derived from task profiles. However, if there are separate TRCs or tasks for the rows of data in Intermediate Payable Time, the system preserves separate rows in Payable Time. If we look at how punch time is formatted in these tables, we can see the difference.

### Intermediate Payable Time Versus Payable Time

As illustrated in the following table, when Time and Labor transfers punch data to Intermediate Payable Time, it arranges the data into separate rows of in and out punches, calculates the duration between each in and out punch, and stores the resulting durations or time segments in TL\_QUANTITY. Because each duration has a separate row in the table, you can write rules that act differently on different time segments based on punch type, task assignment, and so forth.

In the following example, assume that detailed task information has been reported positively (time has already been assigned to Dept. A or B). We'll then look at a second example in which task assignments are derived from a task profile.

#### Example 1: Tasks Are Positively Reported

Assuming that tasks are positively reported, rows in TL\_IPT1 before rules have been executed would appear as shown in the following table, where there is a record for each segment of time. Rules may later delete or add rows:

<i>PUNCH_TYPE</i>	<i>PUNCH_BEGIN</i>	<i>PUNCH_END</i>	<i>TL_QUANTITY</i>	<i>TASK</i>
In	8:00	10:00	2.00	Dept. A
Break	10:00	10:15	.25	Dept. A
In	10:15	12:00	1.75	Dept. A
Meal	12:00	13:00	1.00	Dept. A
In	13:00	15:00	2.00	Dept. B

<i>PUNCH_TYPE</i>	<i>PUNCH_BEGIN</i>	<i>PUNCH_END</i>	<i>TL_QUANTITY</i>	<i>TASK</i>
Break	15:00	15:15	.25	Dept. B
In	15:15	17:00	1.75	Dept. B
Out	17:00			

After rules have been executed to assign TRCs to each time segment, TL\_IPT1 would look like this:

<i>PUNCH_TYPE</i>	<i>PUNCH_BEGIN</i>	<i>PUNCH_END</i>	<i>TL_QUANTITY</i>	<i>TRC</i>	<i>TASK</i>
In	8:00	10:00	2.00	Reg	Dept. A
Break	10:00	10:15	.25	Reg	Dept. A
In	10:15	12:00	1.75	Reg	Dept. A
Meal	12:00	13:00	1.00	Reg	Dept. A
In	13:00	15:00	2.00	Reg	Dept. B
Break	15:00	15:15	.25	Reg	Dept. B
In	15:15	17:00	1.75	Reg	Dept. B
Out	17:00				

After rules have been run, all similar rows (those with the same TRC and task elements) for the same employee and date are summarized and passed to Payable Time. Assuming that the meals and breaks in this example are paid, Payable Time would look like this:

<i>TL_QUANTITY</i>	<i>TRC</i>	<i>TASK</i>
5.00	Reg	Dept. A
4.00	Reg	Dept. B

**Note:** In this example Payable Time creates two separate rows in TL\_QUANTITY. This is because each is associated with a different task and cannot be summed.

### Example 2: Task Data Derived From a Task Profile

Assume that task data has been generated through the use of a task profile, rather than positively reported, and that 25% of time is to be charged to Dept. A and 75% to Dept. B. Prior to running rules, TL\_IPT1 appears as follows:

<i>PUNCH_TYPE</i>	<i>PUNCH_BEGIN</i>	<i>PUNCH_END</i>	<i>TL_QUANTITY</i>
In	08:00	10:00	2.00
Break	10:00	10:15	.25
In	10:15	12:00	1.75
Meal	12:00	13:00	1.00
In	13:00	15:00	2.00
Break	15:00	15:15	.25
In	15:15	17:00	1.75
Out	17:00		

**Note:** When using task profiles, Time Administration refers to the instructions defined for the task profile to determine the correct allocation of time to tasks.

After rules have been executed, TL\_IPT1 appears as follows:

<i>PUNCH_TYPE</i>	<i>PUNCH_BEGIN</i>	<i>PUNCH_END</i>	<i>TL_QUANTITY</i>	<i>TRC</i>	<i>TASK</i>
In	08:00	10:00	1.875 (7.5 total "In" hrs x .25)	Reg	Dept. A
Break	10:00	10:15	.125 (.5 hrs of total break time x .25)	Reg	Dept. A
Meal	12:00	13:00	.250 (1 "meal" hr x .25)	Reg	Dept. A

<i>PUNCH_TYPE</i>	<i>PUNCH_BEGIN</i>	<i>PUNCH_END</i>	<i>TL_QUANTITY</i>	<i>TRC</i>	<i>TASK</i>
In	08:00	10:00	5.625 (7.5 total "In" hrs x .75)	Reg	Dept. B
Break	10:00	10:15	.375 (.5 hrs of total break time x .75)	Reg	Dept. B
Meal	12:00	13:00	.750 (1 "meal" hr x .75)	Reg	Dept. B

Assuming that breaks and meals are paid, Payable Time appears as follows:

<i>TL_QUANTITY</i>	<i>TRC</i>	<i>TASK</i>
2.25	Reg	Dept. A
6.75	Reg	Dept. B

**Note:** Although these examples include meals and breaks in the total time for the day, they would not typically be included in the *TL\_QUANTITY* column used to determine the allocation of time to tasks. For example, if you were to use a "Default TRC" rule template to assign TRCs to reported time, you could specify which punches should get the default TRC (Punch Types = IN, ML (meal), BRK (break), OUT, and so on). Normally, you would only assign the default TRC to IN or XFER punch types, but not to ML or BRK. If ML or BRK do not get a TRC, then they do not get included in calculations in Intermediate Payable Time or Payable Time, but they could still be used to evaluate other miscellaneous rules.

**Note:** Even though Intermediate Payable Time contains a separate row for each time segment, this does not, for example, prevent you from writing a weekly overtime rule that sums all the segments in *TL\_QUANTITY* for each day of the week to determine if a time reporter has met the requirement for overtime pay. You could even write a rule that sums all the hours in *TL\_QUANTITY* for each segment in the week, deletes rows for individual segments, and writes the daily sum of hours back into *TL\_QUANTITY*. However, you probably want to maintain separate rows for each segment, because you may have other rules that process different segments of time differently depending on their punch type or task association.

## Related Links

[Creating Rules from a Template](#)

## Step 16: Updating Time Reporter Status

In this final step of the Time Administration run, the system resets the values in the TL\_TR\_STATUS record.

**Note:** Time Administration does not update TR status when it creates forecasted Payable Time.

- For each fully processed positive time reporter, the system sets the status (TA\_STATUS) to *N* and the EARLIEST\_CHGDT to the latest date of payable time in the TL\_PAYABLE\_TIME table. If, after Time Administration has been run, time data is altered, or new time data is entered for a time reporter that affects the period just processed (or a prior period), the system updates TA\_STATUS to *Y* and updates EARLIEST\_CHGDT to reflect the earliest date of reported time. The time reporter can then be reprocessed.
- For exception reporters, the system resets the status (TA\_STATUS) to *Y* rather than to *N* (TA\_STATUS is always set to *Y* for exception reporters) and automatically moves the EARLIEST\_CHGDT to the beginning of the next processing period. The time reporter is not reprocessed unless new data is entered that causes the EARLIEST\_CHGT field to be reset in the period that was just processed or in a prior period.

## Viewing and Updating Time Reporter Status

This section discusses how to view and update time reporter status.

### Pages Used to View Time Reporter Status

<i>Page Name</i>	<i>Definition Name</i>	<i>Usage</i>
<a href="#">Time Reporter Status Page</a>	TL_TR_STATUS	View the TA status and earliest change date for the time reporter or group of time reporters you specify.
<a href="#">Update TA Status and ECD Page</a>	TL_TR_STAT_UPD	Modify the TA Status and earliest change date for the time reporter or group of time reporters you specify.

## Understanding Time Reporter Status

Before or after you run the Time Administration process, you may want to use the View TR Status page to check the status of a time reporter or a group of time reporters.

For example, before running Time Administration, you can review a group of time reporters to see which members have the appropriate status settings to be processed in the run. Or during system implementation, you may want to check status information after you run Time Administration to verify that the process is updating time reporters as you expect. For exception time reporters, the Earliest Change Date should display the beginning of the next time period for the workgroup, and the TA Status

should be set to *Up for processing*. For positive time reporters, the Earliest Change Date should be updated to the latest date of payable time, and the TA Status should be set to **Not up for processing**.

**Related Links**

[Understanding Time Reporter Data](#)

**Time Reporter Status Page**

Use the Time Reporter Status page (TL\_TR\_STATUS) to view the TA status and earliest change date for the time reporter or group of time reporters you specify.

Navigation:

**Time and Labor > View Time > Time Reporter Status**

This example illustrates the fields and controls on the Time Reporter Status page. You can find definitions for the fields and controls later on this page.

Time Reporter Status									
Employee Selection									
Time Reporters									
Last Name	First Name	Employee ID	Empl Record	Earliest Change Date	TA Status	Last Updated	Last Processed	User ID	Run Control ID
Barlow	Max	KA3002	0	06/04/2001	Up For Processing	03/09/2006 6:07:35PM			
Twoup	Peter	KA3006	1	06/04/2001	Up For Processing	03/09/2006 6:07:35PM			
Ranson	Marcus	KA3003	0	06/04/2001	Up For Processing	03/09/2006 6:07:35PM			

<b>Field or Control</b>	<b>Description</b>
<b>Earliest Change Date</b>	The earliest addition or update to time-related data for a time reporter since the last Time Administration run. No entry indicates a null value. This date is a trigger for Time Administration's determination of a time reporter's period of interest.
<b>TA Status</b>	Indicates whether the time reporter will be processed the next time the person is selected for the Time Administration process. Displays the value of TA_STATUS: <i>Up for Processing</i> , the time reporter is ready for processing; <i>Not up for processing</i> , the time reporter is not ready for processing; or <i>In Process</i> , the time reporter is being processed.  <b>Note:</b> An exception time reporter never obtains a status of "Not Up for Processing". The system assigns this status to positive time reporters with no outstanding changes or exceptions after processing .

<b>Field or Control</b>	<b>Description</b>
<b>Last Updated and Last Processed</b>	<p>The fields in the <b>Last Updated</b> column display the date and time that the Time Reporter was last updated. The fields in the <b>Last Processed</b> column indicate when the Time Administration process was last run for a Time Reporter.</p> <p>The system compares these two dates and if the value in the <b>Last Updated</b> field is later than the date and time in the <b>Last Processed field</b> then the system recognizes that the update for a positive time reporter may not have been processed by the Time Administration process yet, and will not set the TA_STATUS to <i>Not up for processing</i>.</p>
<b>User ID</b>	<p>The fields in this column display the User ID that initiated the last update of the TA Status.</p>
<b>Run Control ID</b>	<p>The fields in this column display the Run Control ID for the last update of the TA Status.</p>

**Related Links**

[Understanding Time Reporter Data](#)

**Update TA Status and ECD Page**

Use the Update TA Status and ECD page (TL\_TR\_STAT\_UPD) to modify the TA status and earliest change date for the time reporter or group of time reporters you specify.

Navigation:

**Time and Labor > Process Time > Update TA Status and ECD**



Use the Update TA Status and ECD page (TL\_TR\_STAT\_UPD) to modify the TA status and earliest change date for the time reporter or group of time reporters you specify.

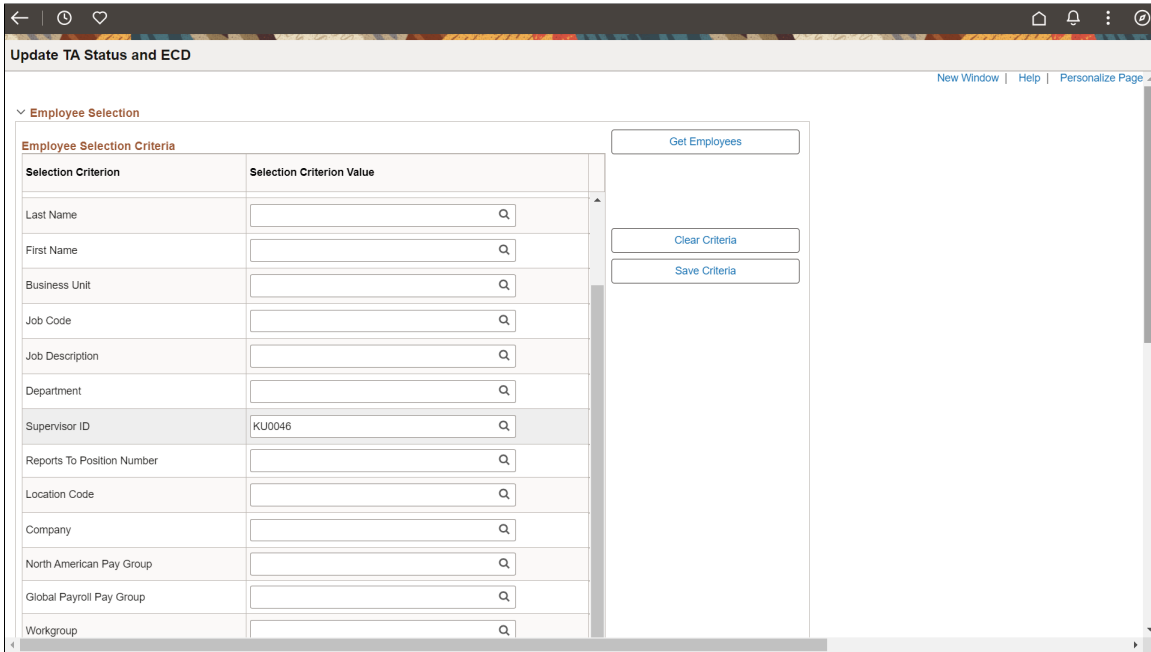

Use the Update TA Status and ECD page (TL\_TR\_STAT\_UPD) to modify the TA status and earliest change date for the time reporter or group of time reporters you specify.

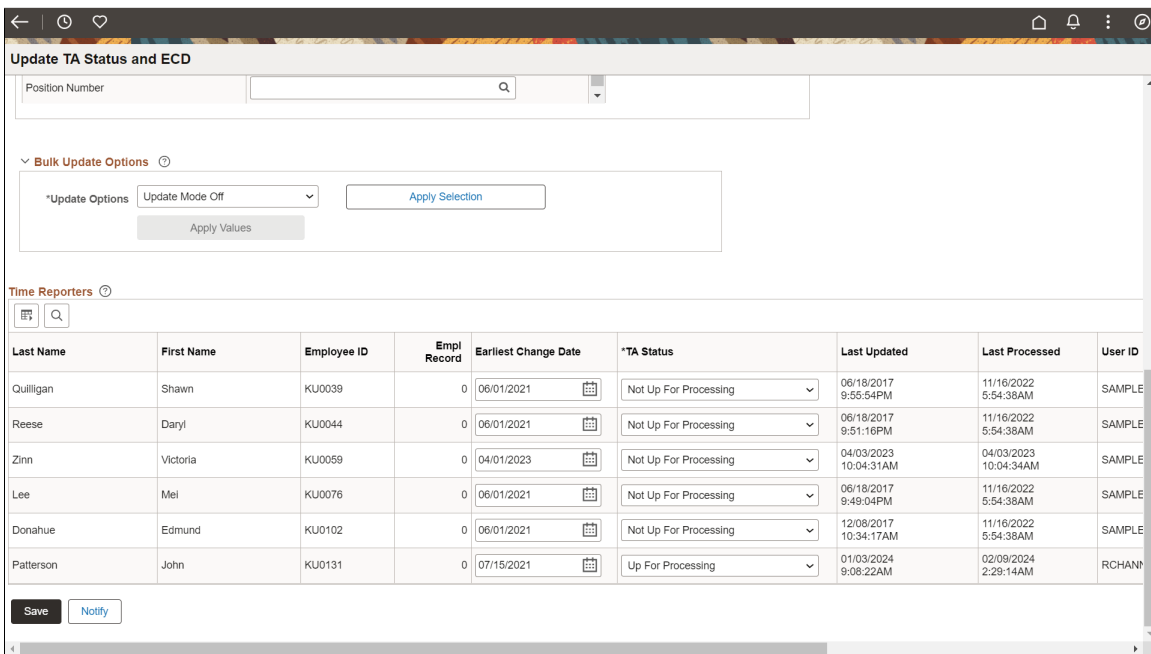

## Employee Selection

Use the Employee Selection section to search for employees based on certain filter criteria.

## Bulk Update Options

Use the Bulk Update Options to update the ECD and TA status for multiple rows in the Time Reporters grid. With the Bulk Update Options, you can easily apply the desired ECD and TA status to all the rows in the time reporters grid. This feature is particularly useful when you need to make bulk updates to the Time Administration statuses.

It's important to note that the changes made using the Bulk Update Options will only be reflected in the grid, and the actual data won't be saved until you manually save the page. This gives you the flexibility to review and modify the values for any specific rows that require individual attention.

<b>Field or Control</b>	<b>Description</b>
<b>Update Options</b>	<p>Select the required value from the drop-down list.</p> <p>Available options are:</p> <ul style="list-style-type: none"> <li>• Update ECD: Select this value to set the Earliest Change Date field.</li> <li>• Update ECD and TA Status: Select this value to set both the Earliest Change Date and Time Administration status values simultaneously.</li> <li>• Update Mode Off: Select this value to reset the values on the Time Reporters grid to the last saved values, for the selection that was opted out.</li> <li>• Update TA Status: Select this value to set the Time Administration status.</li> </ul> <p>By default, the value 'Update Mode Off' is selected in this field.</p>
<b>Apply Selection</b>	<p>When a new option is selected or changed, click this button to confirm the bulk update selection.</p> <p>Apply selection will take the chosen option and display the corresponding fields.</p>
<b>Apply Values</b>	<p>Click the Apply Values button to copy the values for TA Status, ECD, or both to the Time Reporters grid.</p> <p>A text message stating "Time Reporters will be updated with the Earliest Change Date of &lt;date&gt; and TA Status of &lt;selected TA Status value&gt;" appears when the Apply Values button is selected.</p> <hr/> <p><b>Note:</b> The Apply Values button will be enabled only after Apply Selection is selected.</p> <hr/>

Whenever the action is reverted before saving for example Reverting to "Bulk Mode Off" after selecting "Update ECD and TA Status" and applying the values on the grid, the time reporters grid will be replaced with the default values from the last commit.

## Time Reporters

Use the Time Reporter grid to view the TA status and earliest change date for the time reporter or group of time reporters you specify.

<b>Field or Control</b>	<b>Description</b>
<b>Earliest Change Date</b>	<p>The earliest addition or update to time-related data for a time reporter since the last Time Administration run. You can modify the date in this field to in order to facilitate corrective Time Administration processing for specific time reporters. The system prevents you from entering an Earliest Change Date before the time reporter was enrolled in Time and Labor.</p> <hr/> <p><b>Important!</b> You should only modify the Earliest Change Date on an exception basis. Setting this field incorrectly could result in a time reporter not receiving accrued Payable time, or a time reporter receiving Payable time that has not been accrued.</p> <hr/>
<b>TA Status</b>	<p>Indicates whether the time reporter will be processed the next time the person is selected for the Time Administration process. The valid values are: <i>Up for Processing</i>, the time reporter is ready for processing; <i>Not up for processing</i>, the time reporter is not ready for processing; or <i>In Process</i>, the time reporter is being processed. The system does not allow you to change the time reporter's status to <i>In Process</i>.</p>
<b>Last Updated and Last Processed</b>	<p>The fields in the <b>Last Updated</b> column display the date and time that the Time Reporter was last updated. The fields in the <b>Last Processed</b> column indicate when the Time Administration process was last run for a Time Reporter.</p> <p>The system compares these two dates and if the value in the <b>Last Updated</b> field is later than the date and time in the <b>Last Processed field</b> then the system recognizes that the update for a positive time reporter may not have been processed by the Time Administration process yet, and will not set the TA_STATUS to <i>Not up for processing</i>, however, you can manually set that status on this page.</p>
<b>User ID</b>	<p>Displays the User ID of the last user that updated the <b>Earliest Change Date</b> and <b>TA Status</b> fields.</p>

## Related Links

[Understanding Time Reporter Data](#)

---

## Launching the Time Administration Process

This section explains how to launch the Time Administration process.

### Page Used to Start the Time Administration Process

<i>Page Name</i>	<i>Definition Name</i>	<i>Usage</i>
<a href="#">Request Time Administration Page</a>	TL_TA_RUNCTL	Select the time reporters and/or groups of time reporters to process. If you do not want to pass data to payroll, and only want to forecast payable time, select the Forecast Payable Time option.

### Understanding When the Process is Called

To start the batch process, use the Request Time Administration page (Time Administration run control page). If you have selected the Automatic Rules Run option on the TL Installation page, the batch process is also called automatically when you:

- Invoke the Submit process after entering time on the Rapid Entry page.
- Start the GP Absence process from the GP Absence Request page, if Time and Labor is integrated with Global Payroll. The GP Absence process calls Time Administration immediately after it retrieves absence data from Global Payroll.

### Request Time Administration Page

Use the Request Time Administration page (TL\_TA\_RUNCTL) to select the time reporters and/or groups of time reporters to process.

If you do not want to pass data to payroll, and only want to forecast payable time, select the Forecast Payable Time option.

Navigation:

**Time and Labor > Process Time > Request Time Administration > Request Time Administration**

This example illustrates the fields and controls on the Request Time Administration page. You can find definitions for the fields and controls later on this page.

The screenshot shows the 'Request Time Administration' interface. At the top, it displays 'Run Control ID 1', 'Report Manager', 'Process Monitor', and a 'Run' button. Below this is the 'Run Control Parameters' section with three checkboxes: 'Forecast Payable Time' (unchecked), 'Use Reported Time for POI' (checked), and 'Use Current Date' (unchecked). A 'Process through Date' field is set to '02/15/2013'. To the right, the 'Time Administration Settings' section has two checked options: 'Continue with Exceptions' and 'Include All Jobs'. Below these is the 'Employees To Process' section, which includes a table with columns for 'Empl ID', 'Name', and '\*Include or Exclude Selection'. The table lists two employees: Rick Mawson (MUET100) and Franklin Burns (MUET111), both with 'Include' selected. Navigation controls like 'Personalize', 'Find', and 'First 1-2 of 2 Last' are also visible.

If you would like the system to generate runtime statistics for the current run, use the Time Administration Options page to select the statistics you would like it to produce.

<b>Field or Control</b>	<b>Description</b>
<b>Forecast Payable Time</b>	<p>Select if you do not want to send the results of the Time Administration Batch run to Payable Time, but want to use the results for budgeting or other business purposes. You might also use this feature to test new rules associated with a new contract. You can forecast payable time repeatedly without having to reset TA Status until results are accurate.</p> <p>If you select this check box, the <b>Process Period with this Date</b> field becomes available. For the system to forecast time for current and future periods accurately, the <b>Use Reported Time for POI</b> check box must be selected.</p> <hr/> <p><b>Note:</b> Forecasting Payable Time does everything that creating Payable Time does, except process exceptions (TL_TA001200) and update time reporter status (TL_TA001300). It also ignores the EARLIEST_CHGDT and TA_STATUS.</p>

<b>Field or Control</b>	<b>Description</b>
<b>Use Reported Time for POI</b>	<p>This check box enables you to determine dynamically if Time Administration should consider dates related to newly reported punch or elapsed time when creating the period of interest. If this check box is selected (default setting), the system will consider all reported time when creating the Period of Interest. Consequently, if the time reporter has reported time for a date that is greater than the initial Period of Interest end date, the greatest date from reported time becomes the initial POI end date. However, if this check box is cleared, the system will only use the earliest change date and current workgroup period to determine the period of interest, and will not consider time from future periods.</p> <p>For example, suppose that on 28 February you are processing time for the months of January and February and a time reporter has reported future vacation time for March. If you want the system to include the future reported time in its calculations, you would make sure that this check box is selected. Or, if you want the system to ignore the future reported time and only process the current and previous month's time, you would clear this check box.</p>
<b>Use Current Date</b>	<p>Select to create Payable Time if you want the system to use the current (system) date to select time reporters for processing. Any time reporters with an Earliest Change Date (from the TR Status Table) that is equal to or less than the current date or system date. Selecting this option deactivates the <b>Process Date</b> field.</p>
<b>Process through Date</b>	<p>Use this field if you are creating Payable Time, and you want to use a date other than the current (system) date to select time reporters for processing. For example, if you enter a new period before processing the previous calendar period, you could change the date on the run control to the last day of the previous pay period, and the run control would select the appropriate time reporters for that period. That is, only time reporters whose status (TA_STATUS) is Y and who have data to process in the previous period (whose EARLIEST_CHGDT is equal to or less than the last day of the previous period) will be selected. Time reporters who have unprocessed time in the current period only will be not selected.</p> <p>You can have time processed through the period that intersects with the process date for both exception and positive time reporters.</p> <hr/> <p><b>Note:</b> The system date is automatically set by default into the <b>Process Date</b> field, but can be modified.</p> <hr/>

<b>Field or Control</b>	<b>Description</b>
<b>Process Period with this Date</b>	<p>This field becomes available only when you select <b>Forecast Payable Time</b>. Enter the date you want to use to select a period for processing. The system determines the correct period to process as follows:</p> <p>For any time reporters you select for processing in the <b>Employees to Process</b> scroll area, the system locates the workgroup (or time reporting) period intersected by the Process Period date, and processes time for that period only (it does not select or exclude time reporters based on whether their earliest change date is less than or equal to this date. It processes any time reporter with time in this period).</p> <hr/> <p><b>Note:</b> If a time reporter in the period for which you are forecasting payable time is an exception reporter, the system uses scheduled time in its calculations—unless the exception reporter has entered time positively. In this case the positively reported time takes priority over the scheduled time. If a time reporter in the period for which you are forecasting payable time is a positive time reporter, the only time the system can process is positively reported time—unless the time reporter has a schedule.</p>
<b>Continue with Exceptions</b>	<p>Select to enable the system to continue to run the process when exceptions are encountered. The system generates payable time for the employee, except for the days with high severity exceptions. This means that for a high severity exception, the system generates the exception and does not generate payable time for the impacted reported time. For any other exceptions, the system generates the exception and continues to generate payable time for the impacted reported time.</p> <p>Clear the field to indicate that when the system encounters any exception, no payable time is generated for the impacted reported time.</p>
<b>Include All Jobs</b>	<p>If selected, the system processes all Empl_Rcd numbers for the EmplID if the TA status and ECD are ready for processing, regardless of what Empl_Rcd numbers are defined on the Time Administration run control page. If the Empl_Rcd numbers are in different workgroups, they are processed in different batches.</p> <p>If not selected, the system processes all Empl_Rcd numbers listed on the Time Administration run control page or all Empl_Rcd numbers that are in the same workgroup as the Empl_Rcd numbers listed on the Time Administration run control page. Empl_Rcd numbers in the same workgroup are processed in the same batch.</p>

### Employees To Process

Use this group box to select the time reporters that you want to process or exclude from the Time Administration run. You can enter Group IDs for entire workgroups, exclude certain individuals from

those workgroups while processing everyone else, or select individuals from one or more workgroups to avoid processing large numbers of time reporters.

<b>Field or Control</b>	<b>Description</b>
<b>EmplID</b>	Select the Employee ID for the time reporter that you want to include or exclude from the run.
<b>Empl Red Nbr</b>	Select the Employee Record Number for the time reporter's job that you want to include or exclude from the run.
<b>Group ID</b>	If you want to include an entire group of time reporters, select the group ID in this field.
<b>Include/Exclude Indicator</b>	Select <i>Include</i> to include the time reporters you identified in the fields to the left.  Select <i>Exclude</i> to exclude the time reporters you identified in the fields to the left.
<b>Run</b>	Click to run this request. PeopleSoft Process Scheduler runs the TL_TA process at user-defined intervals.

## Related Links

[Step 1: Determining Time Reporters to Process](#)

## Restarting Batch Processes in Time and Labor

Occasionally, an error may prevent a batch process, such as Time Administration, from completing successfully. When the error is caused by a change to a SQL statement or PeopleCode steps, you can usually fix the error and resume processing directly from the Process Monitor by selecting the Restart Request option and clicking OK.

Do not use the Restart option when:

- A rule that you created causes an abend.
- The error results from a change to the application engine structure, such as the addition, deletion, or modification of a step.

In these cases, create a new run control to ensure that the corrected rule components are brought into the buffer for processing.

See the product documentation for *PeopleTools PeopleSoft Process Scheduler*



## Generating and Viewing Runtime Statistics

This section discusses how to generate and view runtime statistics.

### Pages Used to Generate and View Runtime Statistics

<i>Page Name</i>	<i>Definition Name</i>	<i>Usage</i>
<u>Time Administration Options Page</u>	TL_TA_OPTIONS	Select the runtime statistics, batch data, and rule information you want the system to generate during each Time Administration Run. You also specify the number of runs for which you want to store data.
<u>Time Administration Statistics Page</u>	TL_TA_RSL_MAINT	Select the runtime statistics, batch data, and rule information you want the system to generate during each Time Administration run. You also specify the number of runs for which you want to store data.  View the macro runtime statistics for the Time Administration process.  View archived batch data.  View archived rule maps.
<u>Program Statistics Page</u>	TL_TA_RSL_SECT	View the Application Engine statistics.
<u>Batch Statistics Page</u>	TL_TA_RSL_BATCH	View the run time, start and end dates of the period of interest covered by the batch, and the number of time reporters in the batch. The Store Batch Stats or Store Section Stats option on the Time Administration Options page must be selected. Statistics are generated when you run the Time Administration process.
<u>Rule Statistics Page</u>	TL_TA_RSL_RULE	View the archived rule maps details.

### Time Administration Options Page

Use the Time Administration Options page (TL\_TA\_OPTIONS) to select the runtime statistics, batch data, and rule information you want the system to generate during each Time Administration Run. You also specify the number of runs for which you want to store data.

Navigation:

**Set Up HCM > System Administration > Utilities > Analyze Time and Labor > Time Administration Options**

This example illustrates the fields and controls on the Time Administration Options page. You can find definitions for the fields and controls later on this page.

**Time Administration Options**

Tracking Options

Store Run Level Statistics  
 Store Program Level Statistics  
 Store Batch Level Statistics  
 Store Rule Level Statistics  
 Store EE Level Statistics

Number Of Runs To Keep

 Store Online Run Statistics

<b>Field or Control</b>	<b>Description</b>
<b>Store Run Level Statistics</b>	Select to generate high level statistics for the current run as a whole, information about when the Time Administration process started and stopped, how many rows were processed, and so forth.
<b>Store Program Level Statistics</b>	Select to generate detailed information for each batch at the program level, in other words, at the level of each of the steps or Application Engine subprocesses that make up the Time Administration process. For example, selecting this option enables you to generate and view statistics on such subprocesses as Punch Matching, Generate Intermediate Payable Time, and so forth.
<b>Store Batch Level Statistics</b>	Select to generate more detailed statistics on a batch by batch basis. For instance, the time taken to process each batch, and the start and end date of the period of interest for the batch.
<b>Store Rule Level Statistics</b>	Select to store the Rule Map and see what rules you ran, the order in which they ran, and so forth.
<b>Store EE Level Statistics</b>	Select to store employee details such as the Employee ID, Employee Record, Name, Employee Effective Date, Status, batch start date and end date, rule period start and end, and the unadjusted end date for each employee processed.
<b>Number of Runs to Keep</b>	Enter the number of previous Time Administration runs for which you want to store runtime statistics, batch and rules data — up to four digits. For example, if you enter a 3 in this field, the system keeps the data for the last three runs.
<b>Store Online Run Statistics</b>	Select to store any applied rule statistics when the process runs for real-time rules from the timesheet. This stores statistics for the Online Regular Calculation processing mode.

## Time Administration Statistics Page

Use the Time Administration Statistics page (TL\_TA\_RSL\_MAINT) to view the macro runtime statistics for the Time Administration process.

Navigation:

- **Set Up HCM > System Administration > Utilities > Analyze Time and Labor > Time Administration Statistics > Time Administration Statistics**
- **Time and Labor > Process Time > Time Administration Statistics > Time Administration Statistics**

This example illustrates the fields and controls on the Time Administration Statistics page. You can find definitions for the fields and controls later on this page.

Time Administration Statistics												
Tracking Options												
<input checked="" type="checkbox"/> Store Run Level Statistics	Number Of Runs To Keep <input type="text" value="3"/>											
<input checked="" type="checkbox"/> Store Program Level Statistics												
<input checked="" type="checkbox"/> Store Batch Level Statistics												
<input checked="" type="checkbox"/> Store Rule Level Statistics												
<input checked="" type="checkbox"/> Store EE Level Statistics	<input checked="" type="checkbox"/> Store Online Run Statistics											
Run Statistics												
Process Instance	Keep	User ID	Run Control ID	Processing Mode	Run Status	Duration (milliseconds)	IPT Rows Created	Actual Rows Created	Exceptions Created	Program Statistics	Batch Statistics	Rule Statistics
100000673	<input type="checkbox"/>	PS	TS_MPC007_S0	Online Regular Calculation		00.00.07.057	11	11	0	Program Statistics	Batch Statistics	Rule Statistics
100000670	<input type="checkbox"/>	PS	TS_MPC005_S0	Online Regular Calculation		00.00.07.602	10	20	0	Program Statistics	Batch Statistics	Rule Statistics
100000665	<input type="checkbox"/>	PS	TS_MPC002_S0	Online Regular Calculation		00.00.04.475	0	0	0	Program Statistics	Batch Statistics	Rule Statistics
100000664	<input type="checkbox"/>	PS	TS_MPC001_S0	Online Regular Calculation		00.00.08.063	9	9	0	Program Statistics	Batch Statistics	Rule Statistics
100000533	<input type="checkbox"/>	PS	TS_MAM80040	Online Regular Calculation		00.00.06.175	9	10	0	Program Statistics	Batch Statistics	Rule Statistics
1111	<input checked="" type="checkbox"/>	PS	MAMB002	Batch Regular Calculation	Success	00.00.09.309	11	7	0	Program Statistics	Batch Statistics	Rule Statistics
1110	<input checked="" type="checkbox"/>	PS	MAMB002_MAM80040	Batch Regular Calculation	Success	00.00.12.240	31	29	0	Program Statistics	Batch Statistics	Rule Statistics

### Tracking Options

Use the following options to define the runtime statistics you want the Time Administration process to generate:

**Note:** If you elect to store information at the detail level, the system automatically stores information at all higher levels. For example, if you select **Store Batch Level Statistics**, you can also access run level Time Administration statistics for the current run. You cannot, however, access detailed, section level statistics.

<i>Field or Control</i>	<i>Description</i>
<b>Store Run Level Statistics</b>	Select to generate high level statistics for the current run as a whole, information about when the Time Administration process started and stopped, how many rows were processed, and so forth.

<b>Field or Control</b>	<b>Description</b>
<b>Store Program Level Statistics</b>	Select to generate detailed information for each batch at the program level, in other words, at the level of each of the steps or Application Engine subprocesses that make up the Time Administration process. For example, selecting this option enables you to generate and view statistics on such subprocesses as Punch Matching, Generate Intermediate Payable Time, and so forth.
<b>Store Batch Level Statistics</b>	Select to generate more detailed statistics on a batch by batch basis. For instance, the time taken to process each batch, and the start and end date of the period of interest for the batch.
<b>Store Rule Level Statistics</b>	Select to store the Rule Map and see what rules you ran, the order in which they ran, and so forth.
<b>Store EE Level Statistics</b>	Select to store employee details such as the Employee ID, Employee Record, Name, Employee Effective Date, Status, batch start date and end date, rule period start and end, and the unadjusted end date for each employee processed.
<b>Number of Runs to Keep</b>	Enter the number of previous Time Administration runs for which you want to store runtime statistics, batch and rules data — up to four digits. For example, if you enter a 3 in this field, the system keeps the data for the last three runs.
<b>Store Online Run Statistics</b>	Select to store any applied rule statistics when the process runs for real-time rules from the timesheet. This stores statistics for the Online Regular Calculation processing mode.

**Note:** If you elect to generate runtime statistics on your batch runs, you can view the statistics using the Batch Statistics page and Program Statistics page.

## Run Statistics

<b>Field or Control</b>	<b>Description</b>
<b>Process Instance</b>	The order assigned to the run in the processing queue. The number is generated automatically by the Process Scheduler.
<b>Keep</b>	Select to specify that the system should retain the selected row of run statistics. The <b>Number of Runs to Keep</b> field indicates the maximum number of rows you can specify.

<b>Field or Control</b>	<b>Description</b>
<b>Forecast Payable Time</b>	This check box is selected if you chose the Forecast Payable Time option on the Time Administration run control page.
<b>IPT Rows Created</b>	The number of rows created in Intermediate Payable Time.
<b>Actual Rows Created</b>	Displays the actual rows created, either payable time or forecasted time.
<b>Exceptions Created</b>	The number of exceptions generated when Time Administration was run.
<b>Program Statistics</b>	Click this link to access the Program Statistics page, where you can see the runtime for each section in the batch.
<b>Batch Statistics</b>	Click this link to access the Batch Statistics page, where you can see additional information about the batch.
<b>Rule Statistics</b>	Click this link to access the Rule Statistics page, where you can see additional information about the Archive Rule Map.

## Program Statistics Page

Use the Program Statistics page (TL\_TA\_RSL\_SECT ) to view the Application Engine statistics.

Navigation:

Click the Program Statistics link on the Time Administration Statistics page.

This example illustrates the fields and controls on the Program Statistics page. You can find definitions for the fields and controls later on this page.

The screenshot shows a window titled "Time Administration Statistics" with the following details:

- Process Instance: 100000673
- User ID: PS
- Run Control ID: TS\_MPC007\_S0

The main table is titled "Processing Time by Program" and includes a search bar and navigation controls. The table data is as follows:

Start Datetime	Program Name	Description	Batch Number	Duration (milliseconds)
02/05/2013 11:19AM	TL_TA000200	Determine TRs To Process		00.00.00.080
02/05/2013 11:19AM	TL_TA000300	Create Batches		00.00.01.466
02/05/2013 11:19AM	TL_TA000300_STVALD			00.00.01.293
02/05/2013 11:19AM	TL_TA000400	Create Rule Maps		00.00.00.111
02/05/2013 11:19AM	TL_TRPROFILE	Get TR Profiles		00.00.00.413
02/05/2013 11:19AM	TL_SCHRES_AE	Schedule resolution	1	00.00.00.737
02/05/2013 11:19AM	TL_ABS_RSLV	Load Absences	1	00.00.00.067
02/05/2013 11:19AM	TL_TA000700	Create IPT	1	00.00.00.174
02/05/2013 11:19AM	TL_TA_RULES	TA Rules	1	00.00.00.301
02/05/2013 11:19AM	TL_TA000850	Apply Rounding	1	00.00.00.112
02/05/2013 11:19AM	TL_TA000900	Validate Balances, Est. Gross		00.00.00.381
02/05/2013 11:19AM	TL_VALD_MAIN	Time Validation		00.00.01.346
02/05/2013 11:19AM	TL_TA001000	Process Offsets		00.00.00.033
02/05/2013 11:19AM	TL_TA001100	Update Payable Time		00.00.00.178
02/05/2013 11:19AM	TL_TA001200	Approvals and Notifications		00.00.01.241
02/05/2013 11:19AM	TL_TA001200_AWE			00.00.01.080
02/05/2013 11:19AM	TL_TA001300	Update ECD and TR Status		00.00.00.100

A "Return" button is located at the bottom left of the table area.

<b>Field or Control</b>	<b>Description</b>
<b>Program Name</b>	This is the section name, that is, the name of the subprocess for which you have generated statistics.
<b>Batch Number</b>	The order assigned to the run in the processing queue. The number is generated automatically by the Process Scheduler.

## Batch Statistics Page

Use the Batch Statistics page (TL\_TA\_RSL\_BATCH ) to view the run time, start and end dates of the period of interest covered by the batch, and the number of time reporters in the batch.

Navigation:

Click the Batch Statistics link on the Time Administration Statistics page.

This example illustrates the fields and controls on the Batch Statistics page. You can find definitions for the fields and controls later on this page.

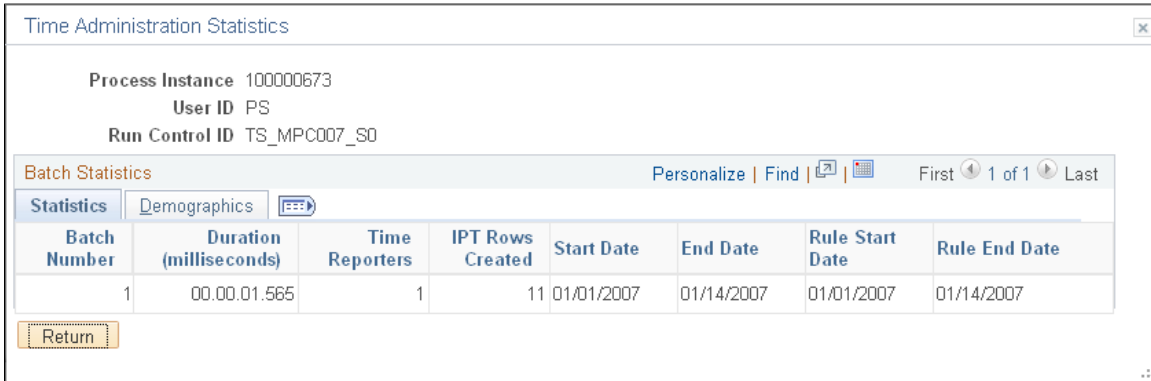

### Statistics Tab

<i>Field or Control</i>	<i>Description</i>
<b>Time Reporters</b>	This is the number of time reporters processed in the batch.

### Demographics Tab

<i>Field or Control</i>	<i>Description</i>
<b>Workgroup Effective Date</b>	The effective date of the workgroup row that was effective for this run and for this time reporter.
<b>Rule Program Date</b>	The effective date of the rule program row that was effective for this run and for this time reporter.

## Rule Statistics Page

Use the Rule Statistics page (TL\_TA\_RSL\_RULES ) to view the archived rule maps details.

Navigation:

click the Rule Statistics link on the Time Administration Statistics page

This example illustrates the fields and controls on the Rule Statistics page. You can find definitions for the fields and controls later on this page.

Time Administration Statistics

Process Instance 100000673  
 User ID PS  
 Run Control ID TS\_MPC007\_S0

Batch Statistics Find | View All First 1 of 1 Last

Batch Number 1  
 Rule Program ID MPCRULPGM01 Workgroup MPCWRKGRP1  
 Start Date 01/01/2007 End Date 01/14/2007  
 Rule Period Start 01/01/2007 Rule Period End 01/14/2007

Rule Statistics Personalize | Find | [?] [ ] First 1-8 of 8 Last

Rule Timing Demographics [ ]

Process Order	Rule ID	Start Time	Duration (milliseconds)
10	M130MAMRG	02/05/2013 11:19AM	00.00.00.007
20	M160MMLO	02/05/2013 11:19AM	00.00.00.056
30	M010MOTP	02/05/2013 11:19AM	00.00.00.103
40	M040MDBL	02/05/2013 11:19AM	00.00.00.016
50	M050SCHDEVIA	02/05/2013 11:19AM	00.00.00.023
60	M060MHOLL	02/05/2013 11:19AM	00.00.00.041
70	M140DLYOTLMT	02/05/2013 11:19AM	00.00.00.009
80	M180MBNSA	02/05/2013 11:19AM	00.00.00.004

Validation Rule Statistics Personalize | Find | [?] [ ] First 1-166 of 166 Last

Validation ID	Validation Option	Program Name	Section	Duration (milliseconds)
TLX00030	Submitted Time	TL_TR0012904	EMPL002	00.00.00.011
TLX00040	Submitted Time	TL_TR0012903	TG00101	00.00.00.008
TLX00060	Submitted Time	TL_TR0012903	TG00103	00.00.00.011
TLX00080	Submitted Time	TL_TR0012903	TG00105	00.00.00.012
TLX00090	Submitted Time	TL_TR0012903	TG00106	00.00.00.017
TLX00100	Submitted Time	TL_TR0012903	TG00108	00.00.00.014
TLX00110	Submitted Time	TL_TR0012903	TG00110	00.00.00.063
TLX00120	Submitted Time	TL_TR0012903	TG00111	00.00.00.005
TLX00130	Submitted Time	TL_TR0012903	TG00112	00.00.00.005

You can view detailed information about the rules processed during a Time Administration run through the Archived Rule Maps page and the linked Archive Rule Map Detail page.

<b>Field or Control</b>	<b>Description</b>
<b>Rule ID</b>	The rule that was executed.
<b>Start Date</b>	The Period of Interest start date.
<b>End Date</b>	The Period of Interest end date.



<i>Field or Control</i>	<i>Description</i>
<b>Rule Program ID</b>	The rule program associated with the rule.

---

## Using Batch Processing Tips

*Q.* How can I process both a prior period adjustment for an exception reporter *and* the "current" time reporting period if the current period does not fall within the period of interest for batch processing, and how can I avoid skipping periods when I run Time Administration in a situation like this?

*A.* Because Payable Time cannot be created for a date or a period that is not contained within the period of interest (and which is therefore not included in Intermediate Payable Time), the current period may need to be processed in a separate run from the prior period adjustment. The following example illustrates why this might occur, and how to avoid skipping a period when you run Time Administration.

---

**Note:** The information contained in this topic assumes that you are familiar with the explanation of how Time Administration calculates the period of interest, and the material on the relationship between the period of interest, Intermediate Payable Time, and Payable Time.

---

### Example: Creating Time for an Exception Reporter with a Prior Period Adjustment

Assume the following:

- You are processing an exception time reporter.
- The time reporter belongs to a workgroup with a monthly rule in the workgroup rule program.
- As illustrated in the following diagram, the last period processed for this time reporter is Week 6 (the current week to be processed is Week 7). After Week 6 is processed, the earliest change date is automatically reset to the first day of the next period—that is, Week 7 (after processing an exception time reporter, the earliest change date is automatically reset to the start of the period immediately following the one intersected by the current date or process date used in the current Time Administration run).

This graphic illustrates the example: Creating Time for an Exception Reporter with a Prior Period Adjustment

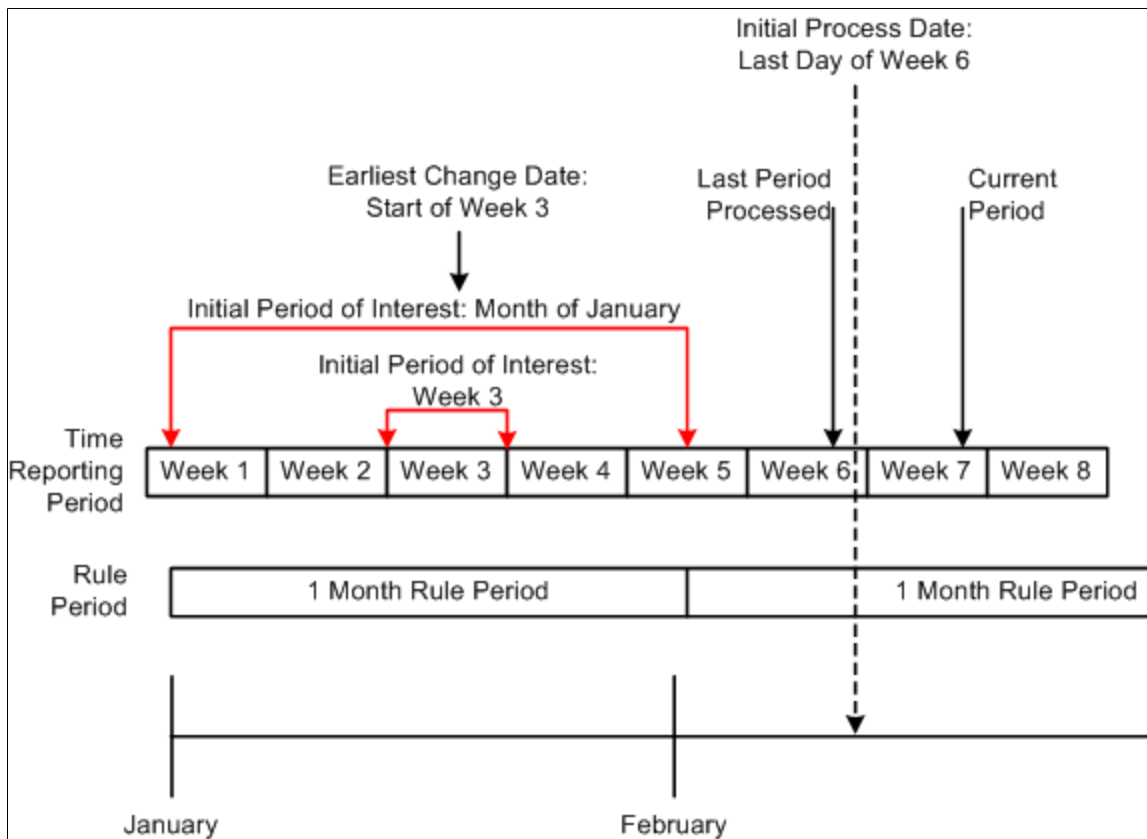

- After Week 6 is processed, the time reporter makes a change to prior period time—he neglected to report a vacation day at the beginning of Week 3, and then does so during Week 7. Because of this, the earliest change date for the time reporter moves from the beginning of Week 7 to the start of Week 3.
- After our time reporter reports new data in the prior period, the system administrator runs Time Administration for Week 7, setting the process date to the end of the week (Week 7). When the process is started, Time Administration defines the initial period of interest as the time reporting period intersected by the earliest change date (Week 3 in our example). The system then expands the period of interest to create time for the monthly rule, giving us a final period of interest that begins on January 1 and ends on January 31. Because there is no positively reported time for periods after January 31, the final period of interest does not extend into the current month or even to the current week (Week 7). This means that Payable Time for the time reporter cannot be created, during this run of Time Administration, for the current period (Week 7), as the data for this period does not fall within the period of interest (and therefore does not exist in Intermediate Payable Time). Payable Time will, however, be created for the month of January.

**Problem:**

In a situation like this, you may still want to create Payable Time for the time reporter in Week 7, which is the "current" period (the period in the present you want to process.) How can you do this, given that the period of interest does not extend into the current month? (Remember, you cannot move time into Payable Time unless it falls within the period of interest, and is included in Intermediate Payable Time.) And how can you avoid skipping a time reporting period—Week 7 in this example—given that the earliest change

date is automatically reset to the start of Week 8 (that is, the start of the period immediately following the one intersected by the current date or process date used in the last Time Administration run)?

**Solution:**

After processing an exception reporter, Time Administration automatically resets the earliest change date to the first day of the time reporting period following the one intersected by the process date used in the current run. In our example, the earliest change date for our time reporter moves to Week 7 after Week 6 is processed, back to Week 3, and finally to Week 8—but time is not picked up for Week 7. In this situation (in which there is a prior period adjustment, and the period of interest does not include the "current" period), you can ensure that all the time for a time reporter is processed (both prior and current), by initially setting the process date to the last day of the last period processed (the one prior to the current period you want to process). After running Time Administration, the earliest change date will be reset to the start of the current period, and you can then move the process date into this period and process current time. So in this example, you would first set the process date to the end of Week 6 (the last period processed), run Time Administration, and then process Week 7.

**Related Links**

[Using Time Reporter Status in the Selection Process](#)



# Time and Labor Auto Enrollment

---

## Understanding Auto Enrollment

Auto enrollment is a framework that is used to automate the Time and Labor enrollments. The auto enrollments in Time and Labor include the employees' time reporter data enrollments, work schedule assignments and employee user preference updates.

The enrollment process updates time reporter data for all new hires including concurrent employment instances, rehires, terminations, job data changes and other configured HR actions. With this framework, you can also configure any other actions to trigger auto enrollment process triggers using customization. The solution provides an optional check step for the administrators to review the data prior to the process committing the change. Delivered reports provide load and error information. The frequency of time reporter data changes can be real-time or scheduled in a batch process based on the configurable option chosen.

---

**Note:** The Earliest Change Date (ECD) will be reset to the effective date upon rehiring or when reactivating a time reporter. ECD will not be reset if there are previous pending rows to be processed.

---

Video: [Time and Labor Auto Enrollment Data Preview and Error Handling](#)

The diagram represents the architectural diagram of auto enrollment.

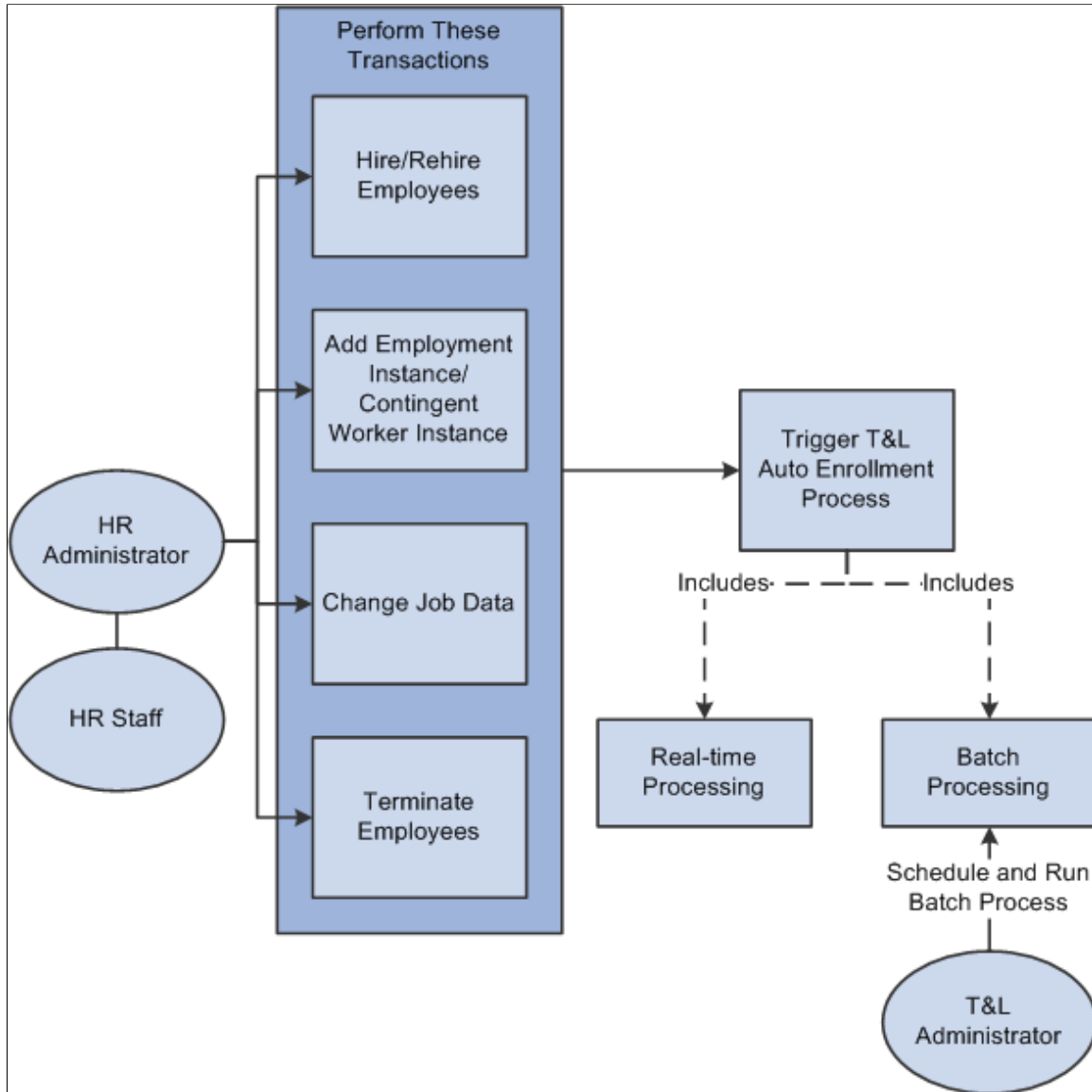

The Time and Labor Administrator defines the auto enrollment rules using the job and other attributes using which the Auto Enrollment framework define the selection criteria which determine what kind of time reporter an employee is.

The Administrators can create enrollment rules to determine how each employee will be added or updated for time reporter data and schedule assignment. The Administrator can use a PS Query to specify the SQL “WHERE” criteria which select employees who become eligible to a specific time reporter data set.

**Note:** When Real Time Processing is selected on the Time and Labor Installation table - Auto Enrollment tab, the Workforce\_Sync service operation needs to be active to trigger the system to run through the enrollment groups to determine how the enrollment fields should be populated.

This section explains the following topics:

- Setting up Auto Enrollment

- Defining Auto Enrollment Groups
- Previewing the Enrollment Data

### Prerequisite for Real Time Processing

Perform the following steps to activate the Workforce\_Sync service operation and associated settings:

1. Navigate to PeopleTools, Integration Broker, Integration Setup, Service Operations. Depending on the PeopleTools release you are on, you may need to use the NavBar.
2. Search for the Workforce\_Sync service operation.
3. On the General tab ensure the service operation is active by checking the “Active” checkbox.
4. Go to the Handlers tab, Change the status of the handler “TLJobSubscriptionsEventHandler” to “Active”, if it is not already active. If you do not see the handler at first, click on the View All link at the top of the grid.
5. Change the status of SCH\_PrimarySchedAssign to “Inactive”.
6. Go to the Routings tab, select the WORKFORCE\_SYNC\_HR\_TO\_HR routing, and click on the Activate Selected Routings button.
7. Click on the Save button to save all of your changes.

---

## Setting Up Auto Enrollment

This section discusses how to enable the auto enrollment setup. All pages related to auto enrollment are placed in Time and Labor Set Up Center.

### Pages Used to Set Up Auto Enrollment

<i>Page Name</i>	<i>Definition Name</i>	<i>Usage</i>
<u>Time and Labor - Auto Enrollment Page</u>	TL_AENRL_INSTALL	Enable the auto enrollments setting using Time and Labor installation settings.
Service Operations page	IB_SERVICE	To make the service operation active.
<u>Workgroup Overrides Page</u>	TL_AENR_WRKGRP_OPT	Enable Enrollment inactivation group box and its fields for user action.

### Time and Labor - Auto Enrollment Page

Use the Time and Labor-Auto Enrollment page (TL\_AENRL\_INSTALL) to enable the auto enrollments on the system by selecting a check box.

Navigation:

**Set Up HCM > Product Specific > Time and Labor > Auto Enrollment**

This example illustrates the fields and controls on the Time and Labor Auto Enrollment page.

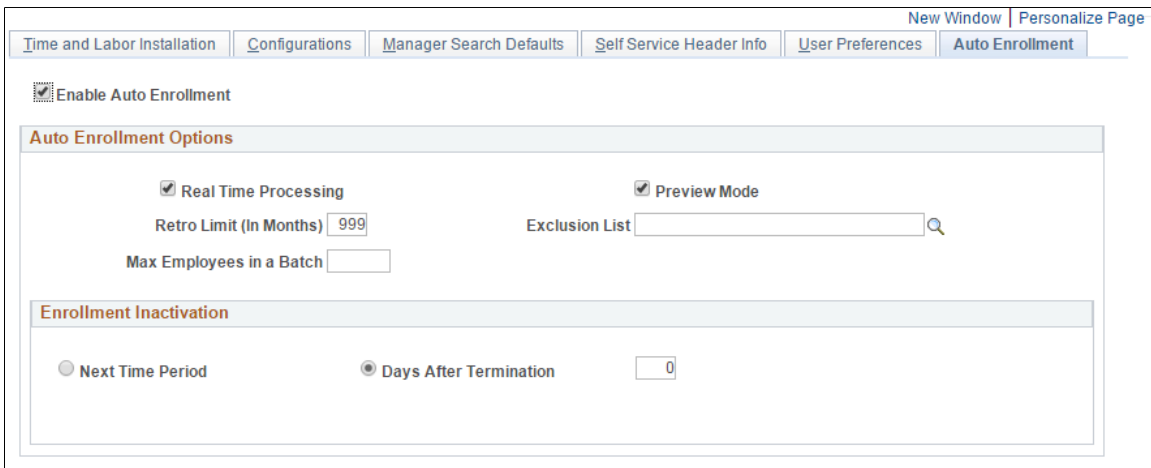

You can edit all other fields on this page by selecting the **Enable Auto Enrollment** check box.

<b>Field or Control</b>	<b>Description</b>
<b>Enable Auto Enrollment</b>	Select the check box to enable all other fields on this Auto Enrollment Installation page.
<b>Real Time Processing</b>	Select the checkbox to enable the real time processing. All Time and Labor Enrollments are done in real time when this option is chosen. The errors encountered is logged in an error table.
<b>Preview Mode</b>	Select for populating the enrollment data into a staging table for review.
<b>Retro Limit (In Months)</b>	Specify the number of months that the Auto Enrollment framework can go back when processing data changes.
<b>Exclusion List</b>	Provide a public query of process type through exclusion list. This query identifies the list of employees who should not be part of auto enrollment process.
<b>Max Employees in a Batch</b>	Controls the number of employees that get included in a batch when using the batch job for doing Auto enrollments. This field controls the number of employees that are placed in a single batch.
<b>Days After Termination</b>	Use to inactivate the employee enrollments with an effective date determined after adding the specified number of days to the Job data termination/ transfer date. If the number selected is '0', then the time and labor enrollments are inactivated with the date equal to the effective date used on the job data transaction.



<b>Field or Control</b>	<b>Description</b>
<b>Next Time Period</b>	Inactivated with an effective date equal to the next Time period begin date after considering the Job data termination or transfer date. Auto enrollment process uses the time period specified on employees' Workgroup.

## Workgroup Overrides Page

Use the Workgroup Overrides page (TL\_AENR\_WRKGRP\_OPT) to enable Enrollment inactivation group box and its fields for user action.

Navigation:

**Set Up HCM > Product Specific > Time and Labor > Auto Enrollment > WorkGroup Overrides .**

This example illustrates the fields and controls on the Workgroup Overrides page

<b>Field or Control</b>	<b>Description</b>
<b>Override Defaults</b>	Enable the Enrollment Inactivation option in the Auto enrollment process.

**Note:** Any retrospective termination events done before updating the workgroup will have to be set manually using Maintain Time Reporter Data page or by using Data correction mode processing.

## Setting Up Enrollment Group

Use PS Queries to define the job and other data criteria that need to be used for differentiating employees before assigning relevant Time Reporter Data attributes. Use the Query Manager to create new process queries to be used in the enrollment rules. Employees identified in the PS Query are assigned with Time reporter data attributes specified in the Enrollment rule

The following video provides a demonstration of how the administrators can enroll the time reporters in bulk.

Video: [Image Highlights, PeopleSoft Update Image 24: Time and Labor - Bulk Auto Enrollment](#)

## Pages Used to Set Up Auto Enrollment Group

<b>Page Name</b>	<b>Definition Name</b>	<b>Usage</b>
<a href="#">Enrollment Group Page</a>	TL_AENRL_CRT_PNL	Select and group the employees who share similar Time Reporter Data attributes using PS Queries.
<a href="#">Time and Labor Enrollments Page</a>	TL_AENRL_TR_PNL	Assign Time Reporter Data attributes to employees selected by the PS Query used earlier.
<a href="#">Time Reporting Preferences Page</a>	TL_AENRL_EE_PREF	Assign Time Reporting Preferences to the employees selected by the PS Query used earlier.
<a href="#">Schedule Assignment Group Page</a>	SCH_AENRL_CRT_PNL	Select and group the employees who share similar scheduling requirements with the help of the PS Queries.
<a href="#">Schedule Assignment Page</a>	SCH_AENRL_ASGN_PNL	Assign Schedules to the employees selected by the PS Query used earlier.
<a href="#">Process Auto Enrollments Page</a>	TL_AENRL_RUNCTL	To run Auto Enrollments in batch mode for individually specified employees, all employees or for employees defined by a process query.
<a href="#">Auto Enrollment Data Correct Page</a>	TL_AENRL_DC_RUNCTL	To run Auto Enrollments in data correction mode for changes within a specified period of time.

## Enrollment Group Page

Use the Enrollment Group (TL\_AENRL\_CRT\_PNL) page to select and group the employees who share similar time reporter data attributes using PS queries.

Administrator uses Enrollment Groups to select and filter a group of employees by using a PS Query and assigns them relevant Time reporter data attributes.

Navigation:

**Set Up HCM > Product Related > Time and Labor > Auto Enrollment > Enrollment Group**

The enrollment group pages include a process of three step train stops action for submitting the selection of enrollments.

The first action is to select the PS query used for grouping employees. Use this step to select and group the employees who share similar Time Reporter Data attributes with the help of Public PS query of Process type.

This example illustrates the fields and controls on the Enrollment Group page.

<b>Field or Control</b>	<b>Description</b>
<b>Effective Date</b>	Date on which the Enrollment group is effective from.
<b>Status</b>	Status of the Enrollment group.
<b>Query Name</b>	Use PS Queries to define job and other data criteria that need to be used for differentiating employees before assigning relevant <b>Time Reporter Data</b> attributes.
<b>Exclude from Preview</b>	Check to exclude this enrollment group from Previews.

The query selected on this page has two field values; they are **Employee ID** and **Employee Record** as output.

As auto enrollment process is primarily designed to pick and process employees’ job data, query used should contain Job data record and it can have any additional records with relevant join conditions for defining the required criteria.

---

**Note:** While creating PS query, delete any effective dated or effective sequence criteria which are added. Auto enrollment process adds the required date criteria based on the job data change row which are processed at run time.

---

Edit the query by selecting the **View Query** and do the necessary updates.

The **View Query** is to access, edit and execute the query.

In the subsequent steps of Enrollment Group definition, the user can specify the time reporter data attributes that need to be assigned to the employees selected by the query specified on the first step.

## Time and Labor Enrollments Page

Use the Time and Labor Enrollments (TL\_AENRL\_TR\_PNL) page to assign Time Reporter Data attributes to employees selected in First Step..

Navigation:

**Set Up HCM > Product Related > Time and Labor > Auto Enrollment > Enrollment Group**

This example illustrates the fields and controls on the Time and Labor Enrollments page.

The screenshot displays the 'Time and Labor Enrollments - Step 2 of 3' interface. At the top, there are navigation tabs for 'Enrollment Group', 'Time and Labor Enrollments', and 'Time Reporting Preferences'. Below the tabs, there are 'Exit', 'Previous', and 'Next' buttons. The main content area is titled 'Time and Labor Enrollments - Step 2 of 3' and includes a sub-header 'Enrollment Group Definition'. The enrollment group is identified as 'TLWRKGRP8'. Key details include:
 

- Effective Date: 01/01/2014
- Status: Active
- Description: TLWRKGRP8
- Short Description: TLWRKGRP8

 The 'Time Reporter Data' section is expanded, showing a list of fields with search icons:
 

- Time Reporter Type: Elapsed Time Reporter (dropdown)
- Elapsed Time Template: [Searchable]
- Punch Time Template: [Searchable]
- Time Period ID: [Searchable]
- \*Workgroup: KUWRKGRP8 (with 'Positive Time /Overtime Limit' note)
- \*Taskgroup: PSNONTASK (with 'Non Task Taskgroup' note)
- Task Profile ID: [Searchable]
- TCD Group ID: [Searchable]
- Restriction Profile ID: [Searchable]
- Rule Element 1 through 5: [Searchable]
- Time Zone: PST (with 'Pacific Time (US)' note)

 On the right side of the 'Time Reporter Data' section, there are two main control areas:
 

- Send Time to Payroll:** A button with a checked checkbox below it.
- Commitment Accounting:** A button with an unchecked checkbox labeled 'For Taskgroup' below it.

The enrollment rules created for time reporter data updates are executed during every Job data change.

## Time Reporting Preferences Page

Use the Time Reporting Preferences (TL\_AENRL\_EE\_PREF) page to assign the Time Reporting Preferences selected in the first step.

Navigation:

**Set Up HCM > Product Related > Time and Labor > Auto Enrollment > Enrollment Group**

Time and Labor user preferences are updated for employees only during the time of new hire or during first time enrollments. During subsequent Job data changes, only time reporter data gets updated wherever required. Employees have the ability to update their user preferences at any point of time. The user can enable their employees to make user preference updates by giving them the access to required pages.

This example illustrates the fields and controls on the Time Reporting Preferences page.

The screenshot shows the 'Time Reporting Preferences' page for enrollment group TLWRKGRP8. The page is titled 'Time Reporting Preferences - Step 3 of 3'. It includes navigation buttons for 'Exit', 'Previous', and 'Submit'. The main content area is divided into two sections: 'User Preferences' and 'Task Value Defaults'. The 'User Preferences' section contains several dropdown menus for configuring time reporting settings. The 'Task Value Defaults' section includes a search bar and a table for defining task groups.

Taskgroup	Description

Time and Labor User Preferences are updated for employees only during the time of Hire or during first time enrollments. During subsequent Job data changes, only Time Reporter Data gets updated wherever required, while Time and Labor User Preferences remain the same throughout the employment tenure of the employee. Employees have the ability to update their user preferences at any point of time. The customer can enable their employees to make user preference updates by giving them the access to required pages.

Select **Submit** to update the changes after making the necessary changes.

---

**Note:** Existing user preferences will never be overridden by the auto enrollment process.

---

## Schedule Assignment Group Page

Use Schedule Assignment Group (SCH\_AENRL\_CRT\_PNL) page to perform the step of selecting and grouping employees who share similar scheduling requirements with the help of PS Queries.

Navigation:

**Set Up HCM > Product Related > Time and Labor > Auto Enrollment > Schedule Assignment Group**

The scheduling assignment is a two step train stops process to select and group employees who share similar requirements and assign the employees to the particular schedule.

As the employee schedule assignments are dynamic in nature, it is expected that Managers update employee schedules wherever required. Schedule defaulting based on preset rules happen only at the time of new hire.

This example illustrates the fields and controls on the first step of Schedule Group page.

The screenshot displays the 'Schedule Group' page, Step 1 of 2. At the top, there are two tabs: 'Schedule Group' (active) and 'Schedule Assignment'. Below the tabs are 'Exit', 'Previous', and 'Next' buttons. The main heading is 'Schedule Group - Step 1 of 2'. A sub-heading reads: 'Use this Step to select and group employees who share similar Scheduling requirements. Employee selection can be done using PS Queries.' Below this, the 'Enrollment Group' is set to 'SCHAERULE1'. The 'Schedule Group Definition' section includes a table with the following fields: '\*Effective Date' (01/01/2010), '\*Status' (Active), '\*Description' (SCHAERULE1), and 'Short Description' (SCHAERULE1). There are also 'Find', 'View All', 'First', '1 of 1', and 'Last' navigation options. Below the table, there is a checkbox for 'Exclude from Preview' and a 'Define Criteria' section with a search icon and a 'View Query' button. The '\*Query Name' field contains 'TL\_KUDE00\_WRKGRP10'.

## Schedule Assignment Page

Use Schedule Assignment (SCH\_AENRL\_ASGN\_PNL) page to assign schedules to employees selected in the first step.

Navigation:

**Set Up HCM > Product Related > Time and Labor > Auto Enrollment > Schedule Assignment Group**

Use Schedule Assignment page for assign schedules to employees and submit it.

Schedule defaulting are based on preset rules which happen at the time of a new hire.

This example illustrates the fields and controls on the Schedule Assignment page.

The screenshot shows the 'Schedule Assignment' page for enrollment group 'SCHAERULE1'. It includes a 'Schedule Group Definition' section with fields for Effective Date (01/01/2010), Description (SCHAERULE1), and Status (Active). Below this is the 'Schedule Assignment' section with radio buttons for 'Use Default Schedule' and 'Select Predefined Schedule'. The 'Select Predefined Schedule' option is chosen, and there are input fields for 'Schedule Group' (KUUSA) and 'Schedule ID' (KUSCHDFE2).

Administrator can either choose to assign **Default Schedules** or **Predefined Schedule** .

## Process Auto Enrollments Page

Use the Process Auto Enrollments ( TL\_AERNL\_RUNCTL) page to run Auto Enrollments in batch mode for individually specified employees, all employees or for employees defined by a process query.

Bulk Auto Enrollment provides another option for administrators to enroll new employee populations into Time and Labor. This option lets administrators run the enrollment in an ad hoc manner. You can specify the employee population and a date from which the new enrollment can commence, irrespective of the effective date on the employee’s job record.

Navigation:

**Time and Labor > Enroll Time Reporters > Auto Enrollment > Process Auto Enrollments**

This example illustrates the fields and controls of Process Auto Enrollments page.

The screenshot shows the 'Process Auto Enrollments' page. It features a 'Run Control ID' field with the value 'MBT' and buttons for 'Report Manager', 'Process Monitor', and 'Run'. Below this is the 'Employees To Process' section, which includes a 'Process Bulk Enrollments' sub-section with a checkbox for 'Process Bulk Enrollments' and an 'Enrollment Start Date' field set to '06/06/2017'. At the bottom, there are radio buttons for 'Select Employees', 'All Employees' (which is selected), and 'Process Group Query'.

<b>Field or Control</b>	<b>Description</b>
<b>Process Bulk Enrollments</b>	Select to process auto-enrollment as a one-time process.
<b>Enrollment Start Date</b>	Select an enrollment date that will be used to enroll employees into Time and Labor. The Enrollment date will be the effective date of each employee enrolled into Time and Labor in the bulk mode.  The <b>Process Bulk Enrollments</b> has to be checked to make <b>Enrollment Start Date</b> enabled.
<b>Select Employees</b>	Select to specify the employees to run the auto enrollment process for both bulk and batch mode.
<b>All Employees</b>	Select to run auto enrollment for all employees.  For batch enrollments, all of the changes to job since the last time the process was run will be picked up and processed, including future dated job rows. If the new job row does not require a change to the Time and Labor enrollment, then no new enrollment record will be inserted.  For bulk enrollments, the maximum effective dated row as of the enrollment start date will be processed. If the employee is terminated as of the enrollment start date, they will not be processed.
<b>Process Group Query</b>	Select to run auto enrollment for employees defined by a process group query.

Batch Auto Enrollment does not handle data corrections to Job. Job data corrections will not trigger the usual processes.

The following is an example of a data correction and how it is handled. An Administrator runs the Batch Enrollment process on March 1, 2017 which processes Employee A's Job change effective 26 February. Later there is a correction to Employee A's job row for 26 February. This correction would not be picked up and processed the next time the Batch Enrollment process is run.

User runs the process with as **Enrollment Start Date** of 01-01-2017 for an employee with a job data as of 01-01-2000. Later there is a correction to the employee's job data as of 01-01-2000 or a new row is inserted on the date range between 01-01-2000 and 01-01-2017. This correction or insertion to the existing job data would trigger a change in enrollment group criteria. Bulk Auto Enrollment will not handle any data correction for scenario outlined above (between 01-01-2000 and 01-01-2017). Job Data corrections will not trigger all of the usual processes. Any correction will be picked up only if the data correction is run.

## Auto Enrollment Data Correct Page

Use the Auto Enrollment Data Correct (TL\_AENRL\_DC\_RUNCTL) Page to run Auto Enrollments in data correction mode for changes within a specified period of time.



Navigation:

**Time and Labor > Enroll Time Reporters > Auto Enrollment > Auto Enrollment Data Correct**

This example illustrates the fields and controls of Auto Enrollment Data Correct page.

<i>Field or Control</i>	<i>Description</i>
<b>From Date</b>	Specify the start date through which the corrections of auto enrollments are needed.
<b>To Date</b>	Specify the date until when the corrections of auto enrollments are needed.

## Batch

If not using Real Time Processing, you can use **Batch processing** to automate employee enrollments in Time and Labor. The Auto Enrollment framework assumes that the **Batch processing** is in use, if the **Real Time processing** option is not chosen on Setup table. Batch processing can be processed in 2 modes – **Incremental** mode and **Data correction** mode.

**Incremental processing** means processing only that data which has changed since the last run. During the incremental run, only those employees whose job data changed after the last process run undergoes processing.

**Data correction** mode type of processing happens when your setups change or when the enrollments rules change retrospectively. The Time and Labor enrollments can be corrected between given dates. Data correction mode processing is available even when using real time processing.



# Understanding Payable Time

---

## Understanding Payable Time

Payable time is created through the Time Administration process and is the end product of Time and Labor. It can be generated in advance from schedules or during the course of the pay period from reported time entries. It represents:

- The quantity of work performed (in hours, dollars, or units).
- The time reporting code that controls how the time reporter is paid.
- The tasks to which time was reported, if applicable.

Payable time can be used in other PeopleSoft applications. For example, if you integrate Time and Labor with Global Payroll or Payroll for North America, your payroll system can pull payable time into its pay runs, compensate time reporters, and then return the calculated costs to Time and Labor. Or you could send payable time with estimated or actual costs to Project Costing for use in project planning, budgeting, billing, and other activities.

### Related Links

[Overview of Payroll Integration](#)

[Understanding Integration](#)

## Payable Time Attributes

Four attributes determine when payable time is available to other applications and how the Time Administration process handles adjustments to payable time. These attributes are:

- *Payable status.* Payable time goes through many stages, most of which relate to the transmission of payable time records from Time and Labor to your payroll system, as well as the transmission of cost data from your payroll system to Time and Labor. Payable status records the progress of payable time through these stages.
- *Reason code.* A reason code is associated with a payable time status code to better align and track payable time from Time and Labor with what actually is paid by the payroll system.
- *Frozen flag.* The frozen flag determines how the system handles any changes that are made to payable time entries. An adjustment made to an entry before its frozen flag is set results in the replacement of the original entry by the new entry. An adjustment made after the frozen flag is set causes the system to create a new entry and an offsetting entry that reverses the original entry.
- *Frozen date.* The frozen date identifies when the frozen flag was set.

Together, the payable status, reason code, frozen flag, and frozen date determine whether an entry of payable time can be sent to your payroll system or published to other applications. The values of the four attributes reside in the payable time tables.

This diagram shows each stage of payable time

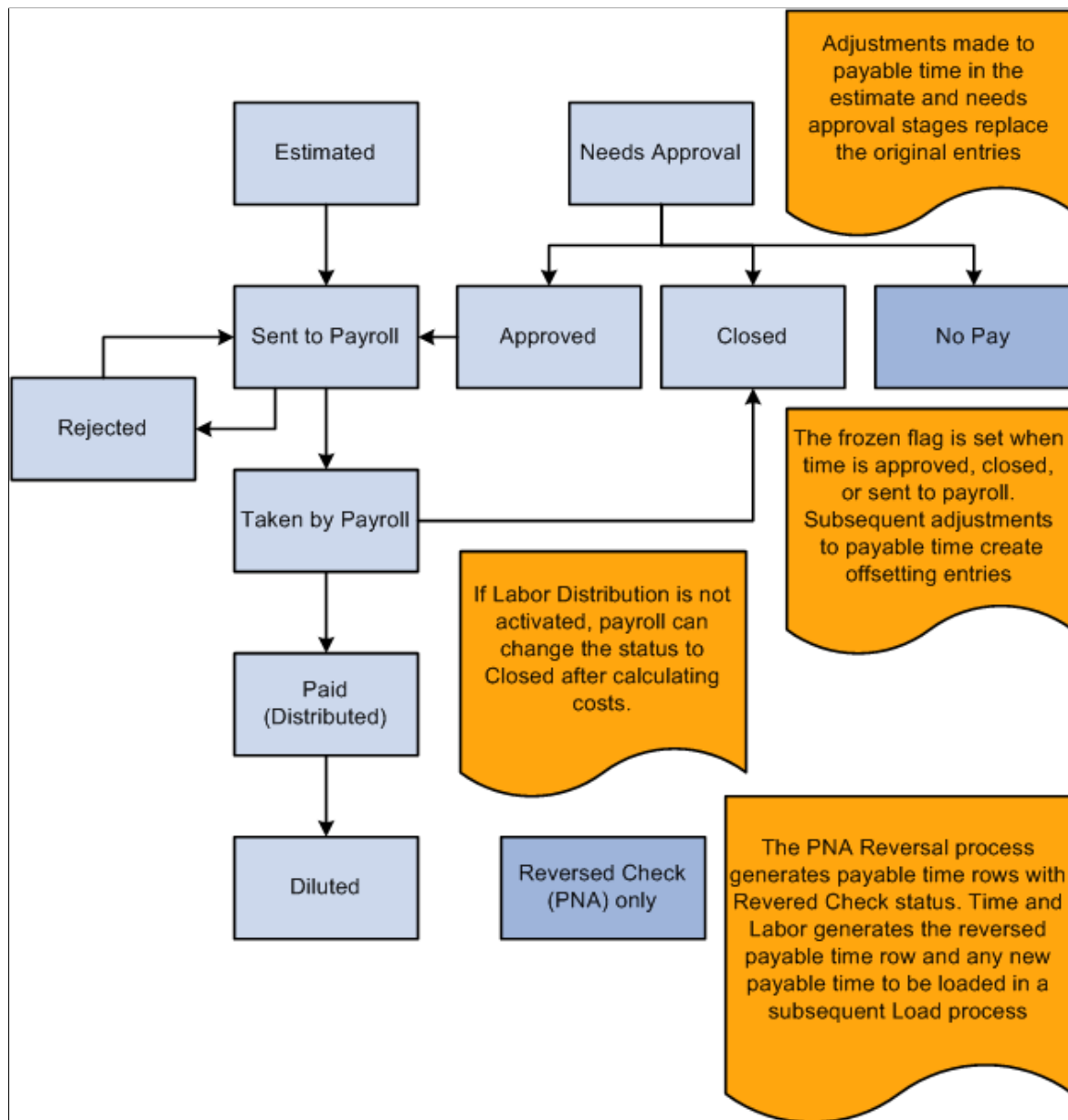

The frozen flag and frozen date are set when the payable status changes to Approved, Closed, or Sent to Payroll. Until this time, any changes made to reported time can result in new payable time entries that replace the original entries. Any changes made after the frozen flag is set cause Time Administration to create offsetting entries, leaving the original entries intact.

### Payable Time Status and Reason Codes

The following table lists and describes all of the payable time statuses and reason codes and indicates when they are published.

<b>Status Codes</b>	<b>Description</b>	<b>Reason Codes</b>	<b>When Published?</b>
Estimated (ES)	<p>This is the first stage of payable time created by the Time Administration process, unless you've activated the Needs Approval option on the Workgroup page. It includes cost estimates calculated by Time Administration if you've selected the Calculate Estimated Gross option on Time and Labor Installation Page.</p> <p>Time Administration updates the original payable time whenever you change reported time that relates to payable time with a payable status of Estimated-Ready for Payroll.</p>	No reason code is associated with this status.	Published to systems that subscribe to the Estimates message.
Needs Approval (NA)	<p>If the workgroup or TRC is set up to require approval of payable time, the Time Administration process sets this status. It is similar to Estimated except that the time must be approved before it can be sent to a payroll system. You approve time using the Approve Payable Time page.</p> <p>Time Administration updates the original payable time whenever you change reported time that relates to payable time with a payable status of Needs Approval.</p>	No reason code is associated with this status.	Published to systems that subscribe to the Estimates message.
Approved – Goes to Payroll (AP)	<p>Approved payable time can be sent to your payroll system. When payable time reaches the approved stage, the system sets the frozen indicator on.</p> <p>Time Administration creates offsetting entries whenever you change reported time that relates to payable time with a payable status of Approved-Goes to Payroll..</p>	No reason code is associated with this status.	Not applicable.

<b>Status Codes</b>	<b>Description</b>	<b>Reason Codes</b>	<b>When Published?</b>
<p>Closed (CL)</p>	<p>When payable time reaches the closed stage, the system turns on the frozen indicator. Payable status is set to this status when any of the following conditions are met:</p> <ul style="list-style-type: none"> <li>• The <b>Send Time to Payroll</b> check box is selected on the Maintain Time Reporter Data page.</li> <li>• The status of the TRC is not <i>Active</i> .</li> <li>• The workgroup or TRC does not need approval and the <b>Publish unmapped TRC as No Pay</b> check box on the TL Installation page is not selected.</li> <li>• The payable time has been taken by payroll, but it will not be labor distributed or diluted because you did not select the Labor Distribution and Dilution options on the Pay System page. (In this case, you'll see the Pay System code and Pay Request Number on the View Payable Time Details page.)</li> <li>• After the TL Load Data process is run, the system changes the payable status from NP to CL in order to close out the time rather than leaving it in NP status.</li> </ul> <p>When the workgroup or TRC is set up to require approval of payable time, then the approval process sets this status.</p> <p>Time Administration creates offsetting entries whenever you change reported time that relates to payable time with a payable status of Closed.</p>	<p>These reason codes can be associated with the Closed status:</p> <ul style="list-style-type: none"> <li>• Not Sent to Payroll (NSP) – Time and Labor sets this reason code when payable status changes to Closed.</li> <li>• Not Distributed (NDS) – When the payroll system (GP or PNA) successfully processes time, and the pay system is not configured for the Time and Labor Distribution process, payroll sets the payable status code to Closed and the reason code to Not Distributed.</li> <li>• Record Adjustment (RAJ) – Time and Labor sets the payable status to Closed and the reason code to record adjustment (RAJ) when paid time is adjusted in Time and Labor.</li> </ul>	<p>Published to systems that subscribe to the Actual message.</p>

<b>Status Codes</b>	<b>Description</b>	<b>Reason Codes</b>	<b>When Published?</b>
Sent to Payroll (SP)	<p>When payable time is selected, the payroll system sets this status code (either GP or PNA).</p> <p>Payable time has this status when it is sent to payroll and payroll either takes or rejects the entry. When payable time reaches this stage, the system turns on the frozen indicator.</p> <p>Time Administration creates offsetting entries whenever you change reported time that relates to payable time with a this status.</p>	No reason code is associated with this status.	Not applicable.
Rejected by Payroll (RP)	<p>Time that payroll has refused.</p> <p>Time Administration creates offsetting entries whenever you change reported time that relates to payable time with a payable status of Rejected by Payroll.</p> <p>The Set Ignore Status for Not Ok to Pay check box on the TL Installation page defines which payable code and reason codes Time and Labor sets during the Distribution Dilution process for PNA integration when a no pay other earning or pay earning are processed:</p> <p>If the <b>Set Ignore Status for Not Ok to Pay</b> check box is selected, then Time and Labor sets the payable time status code to Ignore (IG) and the reason code to Manual Reject</p> <p>If the Set Ignore Status for Not Ok to Pay check box is <i>not</i> selected, then Time and Labor sets the payable status code to Rejected by Payroll (RP) and the reason code to Payroll Not Processed (PNP).</p> <p>Note: The default setting for this check box is selected.</p>	<p>These reason codes can be associated with this status:</p> <ul style="list-style-type: none"> <li>• Manual Reject (MRJ) –</li> <li>• Payroll Not Processed (PNP) – The payroll system sets the payable time status to Rejected by Payroll and the reason code to Payroll Not Processed for any payable time that is not processed by the payroll system (either GP or PNA)</li> <li>• Cancelled (CAN) – If a Global Payroll user cancels an entire Calendar Group run (pay run), Global Payroll sets the payable status code to Rejected by Payroll and the reason code to Cancelled. PNA sets related rows of payable time to Rejected by Payroll and the reason code to Cancelled when a payrun is unsheeted.</li> </ul>	Not applicable.

<b>Status Codes</b>	<b>Description</b>	<b>Reason Codes</b>	<b>When Published?</b>
Taken - Used by Payroll (TP)	Time has been accepted by Payroll. Time Administration creates offsetting entries whenever you change reported time that relates to payable time with a payable status of Taken – Used by Payroll.	No reason code is associated with this status.  When payable time is taken by the payroll system (GP or PNA) the payroll system sets this status code and removes any associated reason code (sets to blank).	Not applicable.
Distributed (PD)	Time that has actual costs from payroll applied by the Labor Distribution process. Time Administration creates offsetting entries whenever you change reported time that relates to payable time with a payable status of Paid-Labor Distributed.	A reason code may be set or removed, depending on the payroll system: <ul style="list-style-type: none"> <li>• Prior Period Salary Adjustment (PPS) – When PNA selects prior period time for a salaried employee, it sets this status and reason code.</li> <li>• Global Payroll sets this status and removes any associated reason code (sets to blank) on a new row for a prior period adjustment.</li> </ul>	Published to systems that subscribe to the Actual message.
Diluted (DL)	Time that has actual costs from Payroll applied by the Labor Distribution process and Labor Dilution process. Time Administration creates offsetting entries whenever you change reported time that relates to payable time with a payable status of Paid-Labor Diluted.	Refer to the previous row for the Distributed payable time status. The same reason codes apply to the Diluted status.	Published to systems that subscribe to the Actual message.



<b>Status Codes</b>	<b>Description</b>	<b>Reason Codes</b>	<b>When Published?</b>
<p>No Pay (NP)</p>	<p>Used by the Project Costing application only. The No Pay status is a status used to reflect transaction rows that are not going to payroll but are in a closed state.</p> <p>When payable time reaches the closed stage, the system turns on the frozen indicator. Payable status is set to this status when any of the following conditions are met:</p> <ul style="list-style-type: none"> <li>• The <b>Send Time to Payroll</b> check box is cleared on the Maintain Time Reporter Data page.</li> <li>• The status of the TRC is not <i>Active</i> .</li> <li>• Time is approved and the <b>Publish unmapped TRC as No Pay</b> check box on the TL Installation page is selected.</li> <li>• Time is approved and ACTUAL_TIME_ADD publishes the information to PeopleSoft Project Costing. Project Costing generates a NPY and a TLB row for each DUR.</li> </ul>	<p>Not Sent to Payroll (NSP) – Time and Labor sets this status and reason code when the TRC is not mapped to an earnings code. This reason code differentiates payable time that is closed without being sent to payroll (suspended) and payable time that is closed because it is sent to payroll.</p>	<p>In order for a No Pay status to be populated and published to PeopleSoft Project Costing the following conditions must be met:</p> <ol style="list-style-type: none"> <li>1. The <b>Publish unmapped TRC as No Pay</b> check box is selected on the Time and Labor Installation page.</li> <li>2. The Maintain Time Reporter Data - Send to Payroll check box is selected.</li> <li>3. The related TRC is not associated with an earnings code.</li> </ol>

<b>Status Codes</b>	<b>Description</b>	<b>Reason Codes</b>	<b>When Published?</b>
Ignore (IG)	<p>When a Time and Labor user indicates on the Adjust Paid Time page that rows that have been rejected by the payroll system should not be paid, Time and Labor sets this payable status.</p> <p>The <b>Set Ignore Status for Not Ok to Pay</b> check box on the TL Installation page defines the payable time status code and reason codes that Time and Labor sets during the Distribution Dilution process when a no pay other earning or pay earning are processed: If the check box is selected, then Time and Labor sets this payable status.</p> <p>Payable time rows with this status are never pulled by Global Payroll.</p>	<p>Manual Reject (MJR) – Time and Labor associates this reason code to rows when it changes the status to Ignore.</p> <p>Not Used (NUS) – Global Payroll adds this reason code to payable time with this status.</p>	Denotes offset rows that should be ignored by Global Payroll.
Reversed Check (RV)	<p>This status code exists to handle check reversals in PNA. The PNA Reversal process generates payable time rows with this status.</p> <p>Time and Labor generates the reversed payable time row and any new payable time to be loaded in a subsequent Load process. This process occurs after PNA has successfully completed the Confirm Pay process.</p> <hr/> <p><b>Note:</b> If the process ends abnormally, you must restart the process from the Process Monitor.</p> <hr/>	The reason code that is associated with the Reversed Check status is always Reversed (CRV).	

**Related Links**

- [Integrating with Project Costing](#)
- [Step 14: Processing Adjustments](#)

**Summary of System Settings that Determine Payable Time Status**

This table summarizes the settings that are made on various pages in Time and Labor that determine the payable time status:

<b>Workgroup Approval</b>  <b>See <u>Setting Up Workgroups</u>.</b>	<b>TRC Approval</b>	<b>Leave Modified</b>  <b>See <u>Time and Labor Installation Page</u>.</b>	<b>Send time to Payroll on TR Data</b>	<b>Send to Payroll on TRC</b>  <b>See <u>Defining and Mapping Time Reporting Codes (TRCs)</u>.</b>	<b>Publish unmapped TRC as No Pay</b>  <b>See <u>Time and Labor Installation Page</u>.</b>	<b>Payable Time Status</b>
Yes	No	No	No	No	Yes/No	NA
No	Yes	No	No	No	Yes/No	NA
Yes	Yes	No	No	No	Yes/No	NA
No	No	Yes	No	No	Yes/No	NA
Yes	Yes	Yes	No	No	Yes/No	NA
No	No	No	Yes	Yes	Yes/No	ES
No	No	No	No	Yes	Yes/No	CL
No	No	No	No	No	Yes/No	CL
No	No	No	Yes	No	Yes	NP
No	No	No	Yes	No	No	CL

For *TRC Approvals*, See [Understanding Time Reporting Codes](#) and for *Send time to Payroll on TR Data*, See [Understanding Time Reporter Data](#).

---

## Publishing Estimated and Actual Payable Time

This section discusses how to:

- Publish payable time with estimated costs.
- Publish payable time with actual costs.

### Publishing Payable Time with Estimated Costs

Each entry of payable time can have both an estimated and actual cost associated with it. If you've selected the Calculate Estimated Gross option on the Time and Labor Installation page, Time and Labor

calculates the estimated cost of payable time when you run the Time Administration process. At the same time, it assigns the entry a payable status of Estimated or Needs Approval.

Estimated payable time is available to any system that wants an early estimate of costs. Time and Labor publishes, on request, all payable time that has not had actual costs applied, including payable time with a status of Estimated, Needs Approval, Approved, Sent to Payroll, Rejected by Payroll, and Taken by Payroll. It does not include payable time in a Closed, Diluted, or Distributed statuses.

Receiving systems should replace any previously collected estimates with the data from Time and Labor and not try to reconcile old and new estimates. Whatever comes from Time and Labor for a given time reporter on a given date should replace all other entries for that time reporter and date.

---

**Note:** Estimated payable time is not the same as forecasted payable time. Forecasted payable time is stored in a separate table and does not go through the stages associated with payable time.

---

### Related Links

[Overview of Payroll Integration](#)

[Understanding Integration](#)

## Publishing Payable Time with Actual Costs

If you integrate Time and Labor with your payroll system, the payroll system can calculate actual costs associated with payable time entries and send them back to Time and Labor. Closed, Distributed, and Diluted payable time entries reflect actual costs. Time and Labor automatically publishes payable time with these statuses after actual costs have been applied and after labor dilution.

If the payroll system must recalculate paychecks after the pay period is closed, it can send Time and Labor new actual costs. Time and Labor then updates the payable time, publishes a message reversing the original amounts, and publishes the new actual costs. Labor Distribution can be rerun; Time and Labor publishes the difference between the original and new costs to Project Costing.

### Currency Codes in the Payable Time Table

The Payable Time Table (TL\_PAYABLE\_TIME), includes two fields for currency codes: Currency Code and Currency Code 2.

- Currency Code reflects the currency used to calculate the estimated gross costs.
- Currency Code 2 reflects the currency the payroll application used to calculate actual costs when payable time has a Closed status. Because it does not go to a payroll system, or does not get labor-distributed, the Currency Code 2 field is the same as Currency Code.

### Related Links

[Overview of Payroll Integration](#)

[Understanding Integration](#)

---

## Understanding Payable Time Fields

This table lists the fields maintained for each entry of payable time in TL\_PAYABLE\_TIME:

<b>Field Name</b>	<b>Description</b>
Emplid	Employee identification number.
Empl_Rcd	Employee record number.
DUR	Date to which this time was reported.
Seq_Nbr	Unique serial number. The link for payroll update and distribution.
Initial_Seq_Nbr	Initial sequence number. Used for PNA check reversal integration. Has a value equal to the Seq_Nbr field value when a check is reversed.
Task_Prfl_Tmpl_ID	Task template for task elements.
TRC	Time reporting code for this time.
TL_Quantity	Hours, amount, or units reported by elapsed time reporters. This field is calculated for punch time reporters.
Shift_ID	The shift under which the original time was reported.
Billable_Ind	Billable indicator.
Override_Rate <sup>1</sup>	Override rate, entered directly by an authorized user or derived through rules.
Comp_RateCd	Alternate rate code to be used with this time. Entered directly by an authorized user or derived through rules.
Country	Country to be used with this time. Entered directly by an authorized user or derived through rules.
State	State to be used with this time. Entered directly by an authorized user or derived through rules.
Location	Location to be used with this time.
Locality	Locality to be used with this time. Entered directly by authorized individual or derived through rules.
Est_Gross	The estimated gross pay for this entry.

<b>Field Name</b>	<b>Description</b>
Currency_Cd	The monetary unit in which the Reported, Override_Rate and Est_Gross fields are stated.
Lbr_Dist_Amt	Actual gross from your payroll system, spread evenly across all relevant TRCs in the period.
Diluted_Gross	Labor distribution amount after dilution.
Currency_Cd2	The monetary unit in which the Lbr_Dist_Amt and Diluted_Gross fields are stated.
Payable_Status	Identifies the status for this time.
TL_Pybl_Reason_Cd	Payable reason code.
TL_Rule_ID	Rule ID. Indicates which rule has created the time. This field is populated only if a rule has created the time.
Pay_System	Payroll system that processed this entry.
Payroll_Req_Num	Sequential number of payroll requests.
Frozen_Sw	Indicates that this record will not be changed by Time Administration.
Frozen_Date	Date the frozen flag was set.
Record_Only_Adj	Record only adjustments.
Publish Sw	Indicates if the row was published.
Actual_Pub_Date	Date published as the final paid time.
Oprid	Operator ID that approved the time.
Apprv_Prcs_Dttm	Date time was approved.
Source_Ind	Source indicator: Offset, System Generated, or User Reported (Record Adjustments)
Rt_Source	Reported time source.

<b>Field Name</b>	<b>Description</b>
Orig_Seq_Nbr	The original sequence number, if this is an offset.
Company	Company code.
Business_Unit_PC	Project Costing business unit.
Business_Unit	HR business unit.
DeptID	Department ID.
Product	Product code.
Project_ID	Project ID.
Task	Task code.
Customer	Customer code.
Acct_CD	Account code.
Resource_Type	Resource type.
Resource_Category	Resource category.
Resource_Sub_Cat	Resource sub category.
Activity_ID	Activity ID.
User_Field_1	User field 1.
User_Field_2	User field 2.
User_Field_3	User field 3.
User_Field_4	User field 4.
User_Field_5	User field 5.
Business Unit PF	Performance Management business unit.

<b>Field Name</b>	<b>Description</b>
SetID_Dept	Department set ID.
SetID_Resource	Resource set ID.
SetID_Activity	Activity set ID.
Deptid_CF	Department ID ChartField.
Account	Account code.
Fund Code	Fund code.
Program Code	Program code.
Class Field	Class field.
Affiliate	Affiliate field.
Operating Unit	Operating unit field.
Alt Account	Alternate account code.
Budget Ref	Budget reference field.
Chartfield 1, Chartfield 2, Chartfield 3	ChartField codes.
Affiliate Intra1, Affiliate Intra2	Affiliate Intra1 and Affiliate Intra2 fields.

---

## Generating a Payable Status Report

You can generate a Payable Status report that shows the payable status for each entry of payable time for the EmplID or Group IDs that you specify during the range of dates you specify. You can include all time entries or specify the payable statuses in which you're interested.

You can also choose the language in which the report is produced.



## Page Used To Generate a Payable Status Report

<i>Page Name</i>	<i>Definition Name</i>	<i>Usage</i>
Payable Status Page	TL_RUNCTL_TL001	Lists all Payable time for a range of dates, sorted by the chosen Payable Statuses on the run control, to provide the manager with a picture of processed and unprocessed time.

## Payable Status Page

Use the Payable Status page (TL\_RUNCTL\_TL001) to lists all Payable time for a range of dates, sorted by the chosen Payable Statuses on the run control, to provide the manager with a picture of processed and unprocessed time.

Navigation:

**Time and Labor > Reports > Payable Status Report > Payable Status**

This example illustrates the fields and controls on the Payable Status page. You can find definitions for the fields and controls later on this page.

### Payable Status

Run Control ID PS Report Manager
Process Monitor
Run

**Run Control Parameters**

\*Description

\*From Date

\*Through Date

**Select Payable Status**

<input type="checkbox"/> Estimated	<input type="checkbox"/> Sent to Payroll	<input type="checkbox"/> Distributed
<input type="checkbox"/> Needs Approval	<input type="checkbox"/> Taken by Payroll	<input type="checkbox"/> Diluted
<input type="checkbox"/> Pushed Back	<input type="checkbox"/> Rejected by Payroll	<input type="checkbox"/> Closed
<input type="checkbox"/> Approved	<input type="checkbox"/> Check Reversed	<input type="checkbox"/> Ignore
<input type="checkbox"/> Denied	<input type="checkbox"/> No Pay	

**Employees To Process** Personalize | Find | View All | | First 1 of 1 Last

Empl ID	Name	Empl Record	Group ID	*Include or Exclude		
<input style="width: 40px;" type="text"/>		<input style="width: 40px;" type="text"/> 0	<input style="width: 40px;" type="text"/>	Include <input style="width: 40px;" type="text"/>	<input type="button" value="+"/>	<input type="button" value="-"/>

<b>Field or Control</b>	<b>Description</b>
<b>Approved</b>	Payable Time in this status is approved in Time and Labor and is ready for a payroll system to select it for payment. Payable Time is in a frozen state and can be selected by financial systems as estimated costs.
<b>Closed</b>	<p>Payable Time in this status may have been published in Project Costing. Payable Time is in a frozen state and can be selected by other financial systems as actual costs. Payable Time that is closed is the result of one of the following situations:</p> <ul style="list-style-type: none"> <li>• TRC reported is not being sent to a Payroll System.</li> <li>• Time Reporter is not sending time to a payroll system.</li> <li>• A record adjustment.</li> <li>• Payable Time is going to a payroll system but is not labor distributed.</li> </ul>
<b>Diluted</b>	Payable Time in this status has been paid by a payroll system and has run through the process of Labor Distribution with Dilution. Payable Time with TRCs that are selected for Labor Dilution will be reflected in this status. The Payable Time is in a frozen state and can be selected by other financials systems as actual costs.
Check Reversed	Payable time with this status results from check reversals in Payroll for North America. The Reversal process in Payroll for North America generates payable time rows and sets the payable time status code to Reversed. Time and Labor generates the reversed payable time row and any new payable time to be loaded in a subsequent Load process.
<b>Estimated</b>	Payable Time in this status is not in a frozen state and can be updated by the Time Administration process. This Payable Time can be selected by other financial systems as estimated costs.
<b>Needs Approval</b>	Payable Time in this status is not in a frozen state and can be updated by the Time Administration process. This time can be selected by other financial systems as estimated costs. This time requires approval either through online or batch process in Time and Labor.
<b>Distributed</b>	Payable Time in this status has been paid by a payroll system and has run through the process of Labor Distribution. Labor Dilution may have been run for the Pay System, but the TRCs related to this Payable Time were not selected for Labor Dilution. The Payable Time is in a frozen state and can be selected by other financial systems as actual costs.

<b>Field or Control</b>	<b>Description</b>
<b>Ignore</b>	Payable Time is in this status when Global Payroll ignores offset rows in processing.
<b>Rejected by Payroll</b>	Payable Time in this status has been rejected by a payroll system, since it does not meet the payroll's selection criteria. The Payable Time is in a frozen state and can be selected by another pay system for payment.
<b>Sent to Payroll</b>	Payable Time in this status has been selected by a payroll system. The Payable Time is in a frozen state. This time can be selected by other financial systems as estimated costs.
<b>Taken by Payroll</b>	Payable Time in this status has been paid by a payroll system and has not run through the process of Labor Distribution. The Payable Time is in a frozen state and can be selected by other financial systems as estimated costs.
<b>No Pay</b>	Payable Time is in this status when transaction rows are not going to payroll but are in a closed state. Used by the Project Costing application only.

---

**Note:** From a troubleshooting perspective, after your pay period has passed, check to see whether you have payable time that remains in a *Rejected by Payroll*, *Sent to Payroll* or *Taken by Payroll* status. This payable time review is necessary to determine what is causing the time to remain in this state.

---



# Reporting Time

---

## Understanding Time Reporting

You can report time using a time clock device, such as a time clock or phone, or through time reporting pages you access through the internet. Time and Labor can also generate time automatically through the use of schedules.

You can also view and modify all time entries—regardless of their source—using the Time and Labor time management pages.

When you run the Time Administration process, the system converts reported time to payable time that can be sent to your payroll system, Project Costing, and other applications.

This graphic shows how reported time is converted to payable time for use by other applications:

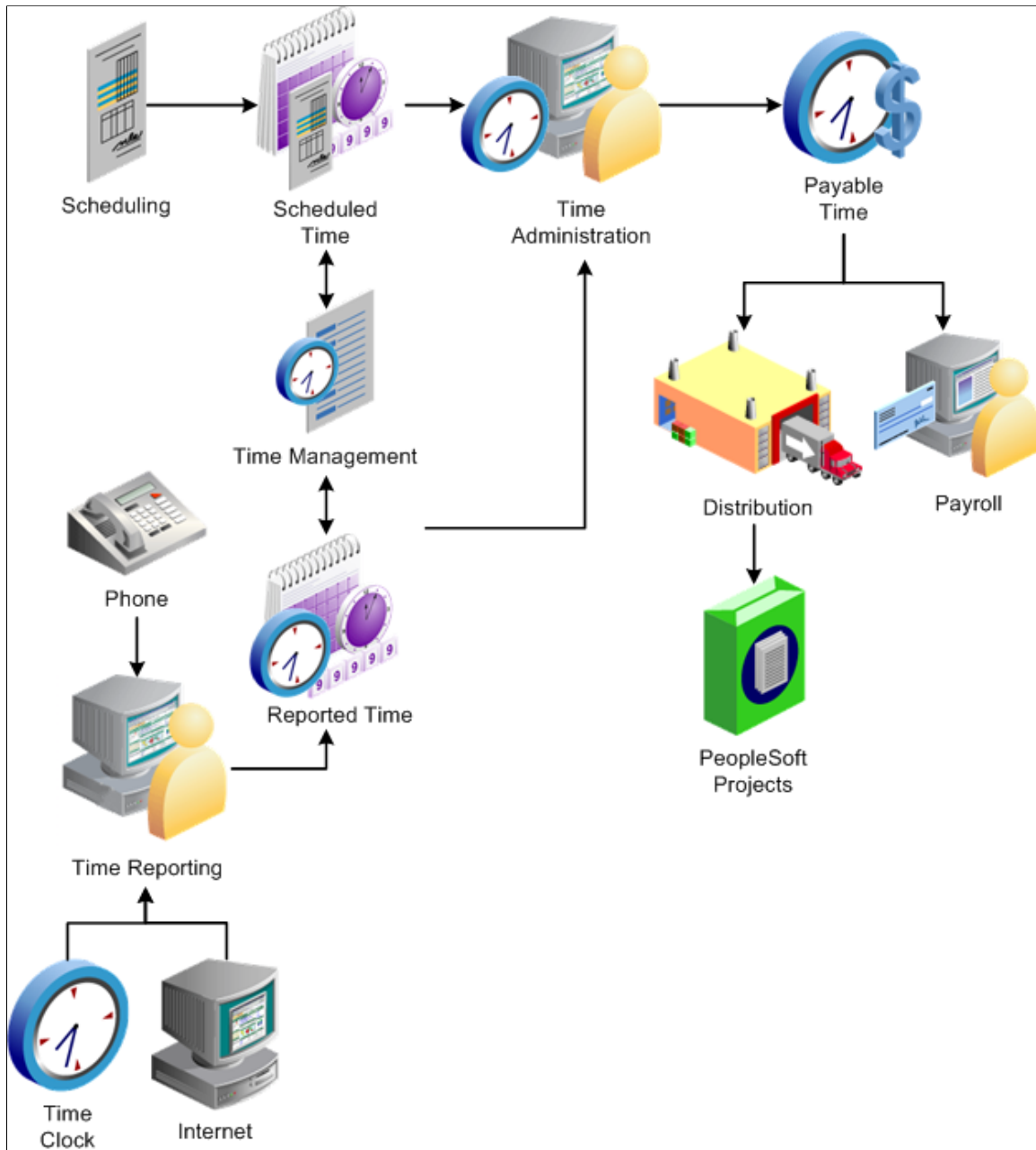

**Related Links**

[Understanding Integration](#)

---

## Creating Time Reporting Templates

Use time reporting templates to establish easy-to-use, self-service pages that time reporters can use to enter time for the current period.

This section provides an overview of time reporting templates and discusses how to specify fields to display on the time entry pages.

## Page Used to Create Time Reporting Templates

<i>Page Name</i>	<i>Definition Name</i>	<i>Usage</i>
<a href="#">Time Reporting Template Page</a>	TL_RPTD_TMPLT1	Specify time-related fields to display on the punch or elapsed time entry pages.
<a href="#">Punch Pattern Page</a>	TL_RPTD_PUNCH	Specify time reporting punch pattern defaults at a Time Reporting Template level for punch time entry pages.

## Understanding Time Reporting Templates

You design the time reporting pages. Use the Time Reporting Template page to select the fields to appear on the Timesheet, Web Clock, and Mass Time self-service pages. You also indicate which data entry fields are required and which fields are optional.

### Task Data

To select the types of task data you want time reporters to provide, use the task template rather than the time reporting template. The task template is associated with a Task Profile and/or a Task Group and then assigned to an employee.

### Time Reporting Templates

You must assign a punch time reporting template and an elapsed time reporting template to each taskgroup. These templates become the default time reporting templates for the members of the taskgroup. You can also assign time reporting templates directly to time reporters using the Create Time Reporter Data page or Maintain Time Reporter Data page. When reporting time, the system uses the default template (the one assigned to the time reporter's taskgroup) only if you did not assign a time reporting template directly to the time reporter.

---

**Note:** You must create time reporting templates before you can create taskgroups.

---

### Predefined Time Reporting Templates

If you want minimal information from time reporters, use the two predefined templates delivered with Time and Labor.

- **Punch Template - No Options (PSPCH\_NONE).** You might want to assign this template to elapsed time reporters who never need to enter punch time. Users of this template only need to select the date they want to report time for and then enter their punch times or punch types on the time entry pages.
- **Elapsed Template - No Options (PSELP\_NONE).** Users of this template select the date they want to report time for and enter a quantity. The time reporting code will default to REG if nothing is reported, and the Taskgroup and Billable Indicator fields are also defaulted in.

### Related Links

[Entering and Maintaining Time Reporter Data](#)

Understanding Task Reporting Requirements

## Time Reporting Template Page

Use the Time Reporting Template page (TL\_RPTD\_TMPLT1) to specify time-related fields to display on the punch or elapsed time entry pages.

Navigation:

**Set Up HCM > Product Related > Time and Labor > Time Reporting > Time Reporting Template > Time Reporting Template**

This example illustrates the fields and controls on the Time Reporting Template page. You can find definitions for the fields and controls later on this page.

The screenshot shows the 'Time Reporting Template' configuration page. At the top, there are tabs for 'Time Reporting Template' and 'Punch Pattern'. The main section is titled 'Time Reporting Template ID: KUTRTP2'. Below this, there are several fields for configuration:

- \*Description: PTime Rptg Template/Profile
- \*Template Type: Punch Time Reporter

The 'Time Reporting Elements' section contains two columns of dropdown menus:

- Left column: \*Time Reporting Code (TRC), \*TRC Type, \*Unit of Measure, \*Currency Code, \*Time Capture Device (TCD), \*Time Zone, \*Country, \*State, \*Locality, \*Billable Indicator, \*Badge ID, \*Time Source.
- Right column: \*Comp Rate Code, \*Override Rate, \*Override Reason, \*Rule Element 1-5, \*Task Template, \*Task Profile, \*Taskgroup, \*Time.

The 'Approval Locations' section has two dropdowns: \*Reported Time and \*Payable Time Needs Approval, both set to 'Both Detail and Summary Page'.

The 'Timesheet Controls' section has two columns of dropdown menus:

- Left column: \*Save For Later Option, \*Submit Option, \*View Selection, \*Real Time Rules, \*Apply Schedule, \*Show All Punches, \*Print Timesheet.
- Right column: \*Reported Time Summary, \*Absence Events, \*Absence Balances, \*Leave and Comp Time, \*Exceptions, \*Payable Time, \*Estimated Pay, \*Attendance.

This example illustrates the fields and controls on the Time Reporting Template page. You can find definitions for the fields and controls later on this page.

The screenshot shows the 'Display of Job Information' section. It includes a checkbox for 'Use Installation Settings' and a search bar. Below is a table with the following data:

*Field	Field Name		
Full/Part Time	FULL_PART_TIME	+	-
HR Status	HR_STATUS	+	-
Pay Group	PAYGROUP	+	-



<b>Field or Control</b>	<b>Description</b>
<b>Template Type</b>	Select <i>Elapsed Time Reporter</i> or <i>Punch Time Reporter</i> to indicate the type of time reporter the template applies to. <i>Elapsed Time Reporter</i> causes the system to display elapsed fields on the Timesheet and Mass Time pages. <i>Punch Time Reporter</i> causes the system to display default punch fields on the Timesheet and Web Clock pages.

## Selecting Time Reporting Elements

Select each type of data reported by time reporters using this template. For each element, specify whether the type of data is *Not Used*, *Required*, or *Optional*. The available elements depend on whether the template applies to elapsed time reporters or punch time reporters.

<b>Field or Control</b>	<b>Description</b>
<b>Time Reporting Code (TRC)</b>	This field is available for both Elapsed and Punch Time Reporter template types. When you select an <i>Elapsed Time Reporter</i> template type, this field defaults to checked and has the default value of <i>Optional</i> . This field is required to display on the time entry pages for an elapsed time reporter, but the time reporter is not necessarily required to enter a value in the field. Select this option if you want your time reporters to enter a TRC for the reported time on the <b>Timesheet, Web Clock, or Mass Time entry</b> pages.
<b>TRC Type</b>	This field is available for both <i>Elapsed and Punch Time Reporter</i> template types. Because this field is a display only field on the time entry pages, the default value is <i>Optional</i> . Select this option to display TRC type (hours, units, or amount) when the time reporter enters a TRC on the Timesheet page.  <b>TRC Type</b> is dependent on the <b>Time Reporting Code</b> field. If you select <b>TRC Type</b> without selecting <b>Time Reporting Code</b> , the system automatically selects <b>Time Reporting Code</b> .
<b>Unit of Measure</b>	This field is available for both <i>Elapsed and Punch Time Reporter</i> template types. Because this is a display only field on the time entry pages, the default value is <i>Optional</i> . Select this option if you want the system to display the unit of measure for the TRC on the Timesheet page when the <b>TRC Type</b> is units.

<b>Field or Control</b>	<b>Description</b>
<b>Currency Code</b>	This field is available for both the <i>Elapsed Time Reporter</i> and <i>Punch Time Reporter</i> template types. The default value is <i>Required</i> . Select this option if you want time reporters to report a currency type code for the reported time.
<b>Time Collection Device ID</b>	This field is available for both the <i>Elapsed Time Reporter</i> and <i>Punch Time Reporter</i> template types. The default value is <i>Required</i> . Select this field if you are interfacing with a third-party time collection device. The system displays the ID of the time collection device to which the time was reported.
<b>Time Zone</b>	This field is available only when you select a <i>Punch Time Reporter</i> <b>Template Type</b> . The default value is <i>Optional</i> . This option allows time reporters to report a time zone for the reported time on the Timesheet, Web Clock, and Mass Time pages.
<b>Country</b>	This field is available for both <i>Elapsed Time Reporter</i> and <i>Punch Time Reporter</i> template types. The default value is <i>Required</i> . Select this option if you want time reporters to report a country for reported time on the Timesheet, Web Clock and Mass Time pages.
<b>State</b>	<p>This field is available for both <i>Elapsed Time Reporter</i> and <i>Punch Time Reporter</i> template types. The default value is <i>Required</i>. Select this option if you want time reporters to report a state for the reported time on the Timesheet, Web Clock or Mass Time pages. Time reporters can then enter a state other than the default associated with the time reporter's tax location code. (Tax location codes are assigned to time reporters on the Job Data pages in Human Resources Management.)</p> <p>The state must be set up for the time reporter in the Maintain Tax Data pages.</p>
<b>Locality</b>	This field is available for both <i>Elapsed Time Reporter</i> and <i>Punch Time Reporter</i> template types. The default value is <i>Required</i> . This option is similar to the state option. Select this option to enable time reporters to enter a locality. The locality should be reported with the associated state. The state and locality combination must be defined for the time reporter in the Maintain Tax Data pages.

<b>Field or Control</b>	<b>Description</b>
<b>Billable Indicator</b>	<p>This field is available for both <i>Elapsed Time Reporter</i> and <i>Punch Time Reporter</i> template types. The default value is <i>Required</i>. Select this option if you want time reporters to report a billable indicator on the Timesheet, Web Clock and Mass Time pages.</p> <p>If Project Costing is integrated with Time and Labor, the reported value is passed to Project Costing.</p>
<b>Badge ID</b>	<p>This field is available for both the <i>Elapsed Time Reporter</i> and <i>Punch Time Reporter</i> template types. The default value is <i>Required</i>. Select this option if you want the time entry page to display the badge ID the time reporter used when entering time.</p>
<b>Comp Rate Code</b> (compensation rate code)	<p>This field is available for both <i>Elapsed Time Reporter</i> and <i>Punch Time Reporter</i> template types. The default value is <i>Required</i>. Select this field if you want time reporters to be able to enter a compensation rate on the Timesheet, Web Clock and Mass Time pages.</p>
<b>Override Rate</b>	<p>This field is available for both <i>Elapsed Time Reporter</i> and <i>Punch Time Reporter</i> <b>Template Types</b>. The default value is <i>Required</i>. Select this check box if you want time reporters to be able to enter an override rate on the Timesheet, Web Clock, and Mass Time pages. The override rate is passed to the payroll system for use in pay calculations. Otherwise, the override rate is set by default to the rate on the TRC or to the hourly rate on the employee's job record.</p>
<b>Override Reason</b>	<p>This field is available for both <i>Elapsed Time Reporter</i> and <i>Punch Time Reporter</i> template types. The default value is <i>Required</i>. Select this option if you want time reporters to be able to enter an override reason code on the Timesheet, Web Clock, and Mass Time pages.</p> <p>You define override reason codes on the Override Reason Code page.</p>

<b>Field or Control</b>	<b>Description</b>
<b>Rule Element 1-5</b>	<p>These fields are available for both <i>Elapsed Time Reporter</i> and <i>Punch Time Reporter</i> template types. The default value is <i>Required</i>. Select these fields to enable time reporters to override any of the rule elements assigned to them on the Create Time Reporter Data or Maintain Time Reporter Data pages.</p> <p>You define rule elements on the Rules Element pages.</p>
<b>Task Profile</b>	<p>This field is available only if the <b>Task Template</b> field is set to <i>Not Used</i>. The default value is <i>Required</i>, which causes <b>Task Profile</b> options to appear on the Timesheet, Web Clock, and Mass Time pages.</p> <p>The task profiles that appear in the drop-down list box are determined by the time reporter's taskgroup. If a taskgroup was assigned to the time reporter directly through the Create Time Reporter Data or Maintain Time Reporter Data page, only those task profiles associated with the assigned taskgroup appear.</p> <p>Task profiles specify the values of the task elements that the system should associate with the reported time. They eliminate the need for the time reporter to enter values for the individual task elements.</p>
<b>Taskgroup</b>	<p>Specify whether the Taskgroup field is available on the time entry pages.</p>
<b>Time</b>	<p>Select this option to either enable or disable the time options that allows a punch time reporter to enter the time that they are punching in or out on the Report Time page.</p> <p>The default value is <i>Disabled</i>. where time reporters cannot enter their punch time, but instead the system uses the server time as the punch time.</p> <p>Select <i>Enable</i> to allow time reporters to enter their punch time instead of being forced to use the system time.</p>

<b>Field or Control</b>	<b>Description</b>
<b>Task Template</b>	<p>This field is available only if the <b>Task Profile</b> field is set to <i>Not Used</i>. The default value is <i>Required</i>.</p> <p>Select this field if you want the Timesheet, Web Clock, or Mass Time pages to display a field for each of the task elements you selected when creating the task template that is assigned to the time reporter's taskgroup. The Timesheet page displays a tab called Overrides that contains all of the appropriate task elements.</p>
<b>Time Source</b>	<p>This option displays the source of the reported time, such as Time Administration, Absence Management, Schedule source, or Time Collection Device.</p>

**Note:** Punch Timesheet display of time reporting and task values are driven by use of Punch Time Reporting Template.

Elapsed Timesheet display of time reporting and task values are driven by use of Elapsed Time Reporting Template.

In order to derive the display of time reporting template information, the system looks for a time reporting template first on the Maintain Time Reporter Data page. If one is not there, then the system uses the time reporting template of the default taskgroup on the time reporter's Maintain Time Reporter Data page.

## Approval Locations

Use the fields in the Approval Locations region to control whether approvers perform approval tasks from a summary view or must navigate into the detail view to complete the task. You can also specify that approvers can work from either location.

## Timesheet Controls

The Save For Later Option field enables you to add a Save For Later button on the Timesheet page for both the employee and manager and enables you to specify how your organization implements time validation on the timesheet. You can choose to always validate time, never validate time, prompt the user to choose whether to validate time, or you can accept the user preferences for validation, or simply not allow users to save timesheets for later submission. The View Selection field enables you to control the views available to the employee on the timesheet: Day, Week or Time Period. Other fields in this region enable you to control the sections that the user sees on the timesheet.

<b>Field or Control</b>	<b>Description</b>
<b>Save For Later Option</b>	<p>This option enables you to add a <b>Save For Later</b> button on the Timesheet page for both the employee and manager and enables you to specify how your organization implements time validation on the timesheet. The button allows the user to save reported time to the database without submitting it. The saved data is not picked up and processed by Time Administration, but remains in a holding state in the database until it is submitted. For example, if an employee typically submits their time on a weekly basis, they can go in and enter their time each day and click on the Save for Later button. Then at the end of the week they can submit the for processing. With the save button, the user has the option of checking for errors or saving the time without checking for errors. The <b>Allow Save For Later</b> check box is selected by default.</p> <p>The values available in this field are <i>Always Validate, Never Validate, Prompt for Validation, Save for Later is Not Allowed, and Use User Preference.</i></p>
<b>Submit Option</b>	<p>This field specifies whether the system always displays a confirmation page when a timesheet is submitted successfully.</p> <p>Choose <b>Confirm</b> to display the Timesheet - Submit Confirmation page when a timesheet is successfully submitted. Choose <b>Skip Confirmation</b> to never show the Timesheet - Submit Confirmation page. Choose <b>Use User Preferences</b> to have the system use the <b>Submit Option</b> selection on the Time Reporting Preferences page.</p>
<b>Show All Punches</b>	<p>Specify whether a user can use the <b>Show All Punch Columns</b> button on the Timesheet for Punch Time reporters.</p> <p>Values are: <b>Enable</b> and <b>Disable</b>.</p>
<b>View Selection</b>	<p>This field enables you to control the views available to the employee on the timesheet: Daily, Weekly, Bi-weekly, Monthly or Time Period.</p> <hr/> <p><b>Note:</b> The timesheet display for users in Classic will return to weekly format when the options, Monthly or Bi-Weekly is selected since these options are available only for Fluid timesheet.</p> <hr/>
<b>Print Timesheet</b>	<p>Use this field to specify whether a link appears on the timesheet that enables the user to print the Timesheet to a PDF file, in order to create a physical timesheet for signatures.</p>

<b>Field or Control</b>	<b>Description</b>
<b>Reported Time Summary, Absence Events, Absence Balances, Leave and Comp Time, Exceptions, Payable Time, and Attendance</b>	<p>These fields enable you to specify the sections that users see on the Timesheet. You can specify whether the relevant section appears at all, or if it only appears in the manager view or only in the employee view of the Timesheet.</p> <p>The values are: <i>Show Section</i>, <i>Hide Section</i>, <i>Show in Employee View Only</i>, and <i>Show in Manager View Only</i>.</p>
<b>Estimated Pay</b>	<p>This field only enables you to specify whether an employee's estimated pay appears on the Timesheet.</p> <p>The Timesheet page displays <i>Estimated Gross</i> tab when you select the option of <i>Show on Timesheet</i> option from the dropdown list of <i>Estimated Pay</i> in the Time Reporting Template page.</p>

## Display of Job Information

Use the fields in this region to specify the information you want to display in the Self Service page header with the employee name and job title.

<b>Field or Control</b>	<b>Description</b>
<b>Use Installation Settings</b>	<p>Select this field to use the settings specified on the Self Service Header Info page to determine the information displayed with the employee name and job title on Time and Labor Self Service pages. Clearing this field displays the Field Selection region on this page so that you can override the installation settings for this time reporting template.</p>

The Field Selection region only appears when you clear the Use Installation Settings field. Use the fields in this region to specify the information displayed with the employee name and job title on Time and Labor Self Service pages.

## Punch Pattern Page

Use the Punch Pattern page (TL\_RPTD\_PUNCH) to specify time reporting punch pattern defaults at a Time Reporting Template level for punch time entry pages.

Navigation:

**Set Up HCM > Product Related > Time and Labor > Time Reporting > Time Reporting Template > Punch Pattern**

This example illustrates the fields and controls on the Punch Pattern page. You can find definitions for the fields and controls later on this page.

Time Reporting Template
Punch Pattern

**Time Reporting Template ID** KUTRTP2

**Description** PTime Rptg Template/Profile

Time Reporting Punch Pattern ?

*Punch Type	*Column Heading		
In <span style="float: right;">▼</span>	In	+	-
Break <span style="float: right;">▼</span>	Break	+	-
In <span style="float: right;">▼</span>	In	+	-
Meal <span style="float: right;">▼</span>	Lunch	+	-
In <span style="float: right;">▼</span>	In	+	-
Out <span style="float: right;">▼</span>	Out	+	-

**Warning!** Be careful to create a punch pattern that makes sense, without the same punch type in a row.

The selections made here determine the Punch columns displayed on the Timesheet for Punch time reporters that use this Time Reporting Template.

This page allows users to set up the typical punch type pattern for employees assigned to this Time Reporting Template. For example, you may have a group of employees assigned to a time reporting template that only has an In, Meal, In, and Out punch pattern. For another group of employees you can set up a different time reporting template that includes Break punch types. No reported tasks or time reporting information are associated to an *Out* punch.

A shift or punch pattern can hold a maximum of 10 punches, including at least one In and one Out punch.

All reported task or time reporting information is associated to the prior punch. For example:

<b>Punch Type</b>	<b>Time</b>	<b>TRC</b>	<b>Punch Duration</b>
In	8 AM	REG	
Break	10 AM	BRK	2 hours for REG from In to Break.
In	10:15 AM	OVT	15 minutes to BRK from Break to In.
Meal	12 PM	ML1	1.5 hours for OVT from In to Meal.



<b>Punch Type</b>	<b>Time</b>	<b>TRC</b>	<b>Punch Duration</b>
In	12:15 PM	OVT1	15 minutes for ML1 from Meal to In.
Transfer	1 PM	OVT2	45 minutes for OVT1 from In to Transfer.
Out	5 PM		4 hours for OVT2 from Transfer to Out.

**Note:** The Time and Labor Installation – Configurations page also contains options for defining a default punch pattern for all punch time reporters. The time reporting template punch pattern overrides the settings on the Time and Labor Installation – Configurations page for the employees assigned to that time reporting template. The system delivered default punch pattern on both the Time and Labor Installation – Configurations page and Time Reporting Template page is *In, Break, In, Meal, In, Out*.

### Related Links

[Integrating with Project Costing](#)

[Understanding Task Reporting Requirements](#)

[Configurations Page](#)

## Creating Templates for Rapid Time Reporting

This section provides an overview of rapid time reporting and discusses how to create templates for rapid time reporting.

### Page Used to Create Templates for Rapid Time Reporting

<b>Page Name</b>	<b>Definition Name</b>	<b>Usage</b>
<a href="#">Rapid Time Template Page</a>	TL_RAPID_TMPLT1	Select the fields to appear on the Rapid Time Reporting page.

## Understanding Rapid Time Reporting

Use rapid reporting templates to design time entry pages for fast reporting. Limited editing occurs during data entry, so users can operate at top speed. Full validation occurs during a separate Submit process.

The rapid time reporting feature of Time and Labor is especially useful when employees report their time using timecards and data entry personnel enter the time into the system. Data entry is fast because users can enter time for multiple employees and multiple days on the same page. Only a few edits are in place to validate data as it is entered. Complete validation occurs when the user submits the reported time entries. Any exceptions then become visible to managers on the Manage Exceptions page.

---

**Note:** Validation TLX0010, Invalid Leave Time Taken, cannot be enabled for the Submit Time process.

---

See [Understanding Time and Labor Implementation](#).

You control which fields appear on the Rapid Time Reporting page—the page used to report time. For example, you can design the page based on the format of your time cards. You use the Rapid Time Template page to select the fields to include on the Rapid Time Reporting page.

Create as many rapid time reporting templates as you need. Elapsed and punch time reporters require separate templates.

## Where to Find Valid Field Values

You may want to supply data entry clerks with a list of the values that are valid for the data entry fields you choose to include on the Rapid Time Reporting page. The valid field values are stored in these tables:

<b>Field Name</b>	<b>Table</b>
Task Detail	Various
TRC	TRC
Time Zones	TIMEZONE
Quantity	TL_QUANTITY
Task Profile ID	TASK_PROFILE_ID
Currency Codes	CURRENCY_CD
Taskgroup	TASKGROUP
Rule Elements	RULE_ELEMENT_1 (2, 3, 4, or 5)
Comp Rate Code	COMP_RATECD
State	STATE
Locality	LOCALITY
Override Reason	OVERRIDE_RSN_CD

## Rapid Time Template Page

Use the Rapid Time Template page (TL\_RAPID\_TMPLT1) to select the fields to appear on the Rapid Time Reporting page.

Navigation:

**Set Up HCM > Product Related > Time and Labor > Time Reporting > Rapid Time Template**

This example illustrates the fields and controls on the Rapid Time Template page. You can find definitions for the fields and controls later on this page.

### Rapid Time Template

Rapid Time Template KURTTE1

**Time Template Definition**

\*Description  \*Template Type

Employee ID   
  Employment Record   
  Employee Name  
 TRC   
  Quantity   
  Currency Code  
 Punch Type   
  Punch Time   
  Time Zone   
  Comments

**Task Elements**

Task Profile ID   
  Company   
  Business Unit HR   
  Location   
  Department ID  
 Jobcode   
  Position Number   
  Customer   
  Task   
  TL Product  
 User Field 1   
  User Field 2   
  User Field 3   
  User Field 4   
  User Field 5  
 Combination Code  
 Business Unit PC   
  Project   
  Resource Type  
 Business Unit PF   
  Activity   
  Resource Category   
  Resource Sub-Category

**Overrides**

Taskgroup   
  Country   
  State   
  Locality  
 Comp Rate Code   
  Override Rate   
  Override Reason   
  Billable Indicator  
 Rule Element 1   
  Rule Element 2   
  Rule Element 3   
  Rule Element 4   
  Rule Element 5

<b>Field or Control</b>	<b>Description</b>
<b>Description</b>	Enter a description of up to 30 alphanumeric characters for the template. This is a required field.
<b>Template Type</b>	Select <i>Punch Time Reporter</i> or <i>Elapsed Time Reporter</i> to indicate the type of time reporter the template applies to.
<b>Employee ID</b>	This check box is selected automatically to indicate that users must supply the time reporter's employee ID when entering time through the Rapid Time Reporting page.
<b>Employee Record</b> (employee record number)	This check box is selected automatically to indicate that a field for employee record number appears on the Rapid Time Reporting page if you enable the <b>Multiple Jobs Allowed</b> option on the Installation table in Human Resources Management.

<b>Field or Control</b>	<b>Description</b>
<b>Employee Name</b>	If you want the time reporter's name to display automatically when a user completes the <b>EmplID</b> (employee ID) field on the Rapid Time Reporting page, select this check box.
<b>TRC</b> (time reporting code)	If you select this check box, a <b>TRC</b> field appears on the Rapid Time Reporting page.
<b>Quantity</b>	This check box is available only when you select <i>Elapsed Time Reporter</i> in the <b>Template Type</b> field. It is automatically selected and indicates that a <b>Quantity</b> field is included on the Rapid Time Reporting page. The user can supply hours, units, or an amount when reporting time.
<b>Currency Code</b>	This check box is available only when you select <i>Elapsed Time Reporter</i> in the <b>Template Type</b> field. Select this option if you want a <b>Currency Code</b> field to appear on the Rapid Time Reporting page. If a user enters an amount or rate when reporting time on the Rapid Time Reporting page, the system can pass this data to your payroll system during processing.
<b>Punch Type</b>	This check box is available only when you select <i>Punch Time Reporter</i> in the <b>Template Type</b> field. It is automatically selected and indicates that a <b>Punch Type</b> field appears on the Rapid Time Reporting page. The user can select <i>Break, In, Meal, Out, or Transfer</i> from a drop-down list box.
<b>Punch Time</b>	This check box is available only when you select <i>Punch Time Reporter</i> in the <b>Template Type</b> field. It is automatically selected and indicates that a <b>Punch Time</b> field is included on the Rapid Time Reporting page.
<b>Time Zone</b>	This check box is available only when you select <i>Punch Time Reporter</i> in the <b>Template Type</b> field. It is automatically selected and indicates that a <b>Time Zone</b> field is included on the Rapid Time Reporting page.
<b>Comments</b>	This check box is available for both <i>Elapsed Time Reporter</i> and <i>Punch Time Reporter</i> template types. Select this check box if you want users to be able to enter a comment for each time entry.

## Task Elements

<i>Field or Control</i>	<i>Description</i>
<b>Task Profile ID</b>	<p>Select this check box if you want the Rapid Time Reporting page to include a <b>Task Profile ID</b> field. The system refers to the time reporter's task profile to determine how to allocate the reported time across tasks.</p> <p>If you select this check box, you cannot select individual tasks from the <b>Task Detail</b> group box on this page.</p>

---

**Note:** Select only those task elements that are included in the default task templates assigned to the time reporters. When a data entry clerk reports tasks that are not associated with the task template, the validation process initiates exceptions.

---

## Overrides

Use this group box to select additional fields to appear on the Rapid Time Reporting page. If a user completes any of these fields when reporting time, the entered values override default values defined elsewhere in Time and Labor or Human Resources Management.

<i>Field or Control</i>	<i>Description</i>
<b>Taskgroup</b>	<p>Select this check box if you want a Taskgroup field to appear on the Rapid Time Reporting page. Users can override the time reporter's default taskgroup when entering time. The system uses the task profile ID associated with the chosen taskgroup to determine how reported time should be allocated across tasks.</p> <hr/> <p><b>Note:</b> If you select any of the <b>Task Detail</b> check boxes and also select <b>Taskgroup</b>, it is possible for a user to enter task data on the Rapid Time Reporting page that does not match the default task profile ID for the time reporter's taskgroup.</p> <hr/>
<b>Country</b>	<p>Select this check box if you want the Rapid Time Reporting page to include a field for a country code. Users can select a country when reporting time. This check box is required when you select the <b>State</b> and <b>Locality</b> check boxes in the Overrides group box.</p>

<b>Field or Control</b>	<b>Description</b>
<b>State</b>	<p>Select this check box to have a <b>State</b> field appear on the Rapid Time Reporting page. Users can enter a state other than the default state associated with the time reporter. The value in the <b>State</b> field identifies the state and local tax jurisdictions in which the time reporter works.</p> <p>If you select this check box, you must also select the <b>Country</b> check box.</p>
<b>Locality</b>	<p>This check box is similar to the <b>State</b> check box. Select this check box to give users the ability to override a time reporter's default locality. The locality must be reported with the associated state and country. If Time and Labor is integrated with Payroll for North America, the state and locality combination must be defined for the time reporter on the Maintain Tax Data page.</p> <p>If you select this check box, you must also select the <b>Country</b> and <b>State</b> check boxes.</p>
<b>Comp Rate Code</b> (compensation rate code)	<p>If you select this check box, the time-entry clerk can enter a compensation rate code that overrides the code assigned to the time reporter on the job record.</p> <p>You define compensation rate codes and assign them to employees in Human Resources Management.</p>
<b>Override Rate</b>	<p>Select this check box to enable users to override the time reporter's default rate when reporting time on the Rapid Time Reporting page. The rate is passed to the payroll system for use in pay calculations.</p>
<b>Override Reason</b>	<p>Select this check box if you want data entry clerks to be able to enter an override reason code on the Rapid Time Reporting page. The code identifies why any override was entered.</p> <p>Override reason codes are defined in the Override Reason Code page in Time and Labor.</p>
<b>Billable Indicator</b>	<p>Select this check box if you want a Billable Indicator field to appear on the Rapid Time Reporting page. If Project Costing is integrated with Time and Labor, the value entered in this field is passed to Project Costing.</p>

<b>Field or Control</b>	<b>Description</b>
<b>Rule Element 1-5</b>	<p>If you want to give users the ability to override specific rule elements assigned to time reporters, select the appropriate rule element check boxes. When reporting time on the Rapid Time Reporting page, users can then enter values for the rule elements that pertain to the reported time.</p> <p>You define rule elements on the Rule Element page and assign them to time reporters on the Create Time Reporter Data or Maintain Time Reporter Data page.</p>

### Related Links

[Defining Rule Elements](#)

[Understanding Time Reporter Data](#)

[Understanding How to Create Task Values in Time and Labor](#)

[Integrating with Project Costing](#)

---

## Reporting Time Rapidly

This section provides an overview of rapid time reporting.

### Pages Used to Report Time

<b>Page Name</b>	<b>Definition Name</b>	<b>Usage</b>
<a href="#">Rapid Time Page</a>	TL_RAPID_SESSION	Enter daily time quickly for time reporters and submit time for validation.
<a href="#">TimeCard Page</a>	TL_REPORTS_RNCTL	Displays all punch time, elapsed time rows, payable time, and unresolved exceptions for an individual employee for the period selected on the run control. The report can be run by an individual employee or by a group. The report contains lines for approval signatures for both the employee and the approving supervisor.

### Understanding Rapid Time Reporting

The Rapid Time Reporting page enables you to quickly enter time for multiple time reporters. No online edits or rules are applied during data entry, so that you can enter data at top speed.

Because there's no up-front validation, try to enter data as accurately as possible. You may also want to have a list of the field values that are valid for your organization nearby when you to enter time—for example, the list of valid time reporting codes, task entity codes, and rule element values, if applicable.

### Reported Time Validation

After you enter time on the Rapid Time Reporting page, click the **Submit** button to validate your entries. During validation, the system checks all the time reporting code and task data you've entered for the session. It also verifies that the status of each time reporter is *Active*. Invalid transactions appear on the Manage Exceptions pages for the manager's review. All time transactions are converted to reported time, whether exceptions are created or not. For those reported time entries that have related exceptions, the time can be corrected in the time reporting pages.

Validation TLX0010, Invalid Leave Time Taken, cannot be enabled for the Submit Time process.

See [Using Validation Criteria](#).

If you selected the **Automatic Rules Run** option on the Time and Labor Installation page, the Submit Time process also starts the Time Administration process, which converts the reported time to payable time.

**Note:** If the rapid entry data includes task details that do not match the employee's task profile, the task details you entered are moved to the Reported Time table if they pass the validation process.

## Rapid Time Page

Use the Rapid Time page (TL\_RAPID\_SESSION) to enter daily time quickly for time reporters and submit time for validation.

Navigation:

**Time and Labor > Report Time > Rapid Time Entry > Rapid Time**

This example illustrates the fields and controls on the Rapid Time page. You can find definitions for the fields and controls later on this page.

The screenshot shows the 'Rapid Time' page with the following sections:

- Rapid Session Information:**
  - \*Description: WKLY PAY
  - \*Template Type: Elapsed Time Reporter
  - \*Template: MUTRAPID-E
  - \*Processing Mode: Replacement
  - Session Number: 751
  - Session Status: Submitted to Reported Time
  - Last Updated: 07/11/01 9:34:50AM
  - User ID: PS
- Rapid Detail Information Table:**

Delete	*Empl ID	Empl Record	*Date	TRC	Quantity	Rule Elem 5	Override Rate	Company	Business Unit	Location	HR Department	Job Code	Task	Combination Code
<input type="checkbox"/>	MZ335		07/03/2006	MEG	8.000000									
<input type="checkbox"/>	MZ335		07/04/2006	MEG	8.000000									
<input type="checkbox"/>	MZ335		07/05/2006	MEG	8.000000									
<input type="checkbox"/>	MZ335		07/06/2006	MEG	8.000000									
<input type="checkbox"/>	MZ335		07/07/2006	MEG	8.000000									
<input type="checkbox"/>	MZ335		07/07/2006	MJMILL	1000000.000									
<input type="checkbox"/>	MZ335		07/10/2006	MEG	8.000000									
<input type="checkbox"/>	MZ335		07/11/2006	MEG	8.000000									
<input type="checkbox"/>	MZ335		07/12/2006	MEG	8.000000									
<input type="checkbox"/>	MZ335		07/13/2006	MEG	8.000000									
<input type="checkbox"/>	MZ335		07/14/2006	MEG	8.000000									
- Controls:**
  - Rows to Add: 1
  - Copy Down Values from Last Row:
  - Increment Date:
  - Buttons: Add Row(s), Delete Selected Row(s), Save, Submit



<b>Field or Control</b>	<b>Description</b>
<b>Description</b>	Enter a description of up to 30 alphanumeric characters for this session.
<b>Session Number</b>	The system displays the session number as 999999999 until you save the page, at which time it automatically assigns the session number.
<b>Template Type</b>	<p>Select the template type, either <i>Elapsed Time Reporter</i> or <i>Punch Time Reporter</i>. This determines which Rapid Time Templates are available.</p> <hr/> <p><b>Warning!</b> You should not change the <b>Template Type</b> field after saving data. Doing so causes the system to delete any data entered with the original template. Instead, create a new session with the desired template type. Similarly, if you change from one template to another of the same type (elapsed to elapsed), any of the data that does not match the current rapid template is deleted when the session is submitted.</p> <hr/>
<b>Session Status</b>	<p>Indicates whether you have run the Submit process to validate the time entries for the data entry session. Values are <i>Submitted</i>, <i>Not Submit</i>, <i>Resubmit</i>, and <i>Submit TA</i> (Time Administration).</p> <p><i>Submit</i>: Indicates that you submitted the session and the entries were validated.</p> <p><i>Resubmit</i>: Indicates that you modified a session that was previously submitted.</p> <p><i>Submit TA</i>: Indicates that you submitted the session and processed Time Administration automatically, as the <b>Automatic Rules Run</b> flag is enabled on the Time and Labor Installation page.</p> <hr/> <p><b>Note:</b> If the system is unable to complete the Submit process because of an error, the session status still reads <i>Submit</i>. After fixing the problem, you can resume processing by selecting the <b>Restart</b> option on the Process Monitor.</p> <hr/>
<b>Template</b>	<p>Select the rapid time template you want. The template determines which data entry fields appear in the <b>Rapid Detail Information</b> section.</p> <hr/> <p><b>Warning!</b> If you select a different rapid time template after you enter time, the system deletes any unsaved entries.</p> <hr/>

<b>Field or Control</b>	<b>Description</b>
<b>Processing Mode</b>	<p>The options available in this field are <i>Replace</i>, <i>Add</i>, and <i>Correction</i>. The option you select determines how the system processes the entries you make on this page:</p> <ul style="list-style-type: none"> <li>• <i>Replace</i> is the default value. It tells the system to replace any time that was entered for the same dates through either the Rapid Entry page or the Mass Time Reporting page (time that has a reported time source code equal to <i>SYS</i>) with the time you are entering now. Only time originating from those two sources is replaced by the new instance of time. Time that originated from any other source, such as the Timesheet page or a Time Clock Device is not changed. For example, when reporting rapid elapsed time and the <b>Processing Mode</b> indicator is set to <i>Replace</i>, the system replaces all the elapsed time that exists for an employee on that same date that originated from either the Mass Time Reporting or Rapid Time Reporting pages. It does not affect any punch time that may exist. Likewise, when reporting rapid punch time, the system replaces all punch time meeting the same criteria and does not delete any elapsed time.</li> <li>• Select <i>Add</i> if you want the system to add a new instance of time for the day without replacing any time that was previously reported for the same day. The system adds the time generated by the Rapid Entry page to the Reported Elapsed table (PS_TL_RPTD_ELPTIME) or Punch Time table (PS_TL_RPTD_PCHTIME).</li> <li>• When a session is resubmitted in <i>Correction</i> mode, reported time is regenerated and reported time that was submitted earlier for this session is deleted. In correction mode the Submit Time process deletes all time with an <i>ST</i> instance and regenerates submitted time. When a new session is submitted in <i>Correction</i> mode, there is nothing to delete and the session data is added as it is when you select <i>Add</i> mode.</li> </ul> <hr/> <p><b>Warning!</b> If you upgraded from Time and Labor Release 8.8 or a prior release, make sure that any existing Rapid Time Reporting sessions that you resubmit using <i>Correction</i> mode were created and submitted using the current release of the application. To enable <i>Correction</i> mode for sessions created using release 8.8 or prior releases, first resubmit the session in <i>Replace</i> mode; after that, you can resubmit the session using <i>Correction</i> mode.</p>

### Rapid Detail Information

The fields that appear in this section vary depending on the rapid time template you selected. The **Delete** check box enables you to delete an entry and is explained later in this section. **EmplID** (employee ID) and **Date** are always required fields.

Few prompt tables are provided for fields within the grid, so you need access to the various codes you'll enter, including the time reporting codes, task, and override values.

**Note:** If you report task elements that are not part of the time reporter's default task template and do not report a different taskgroup, the validation process that occurs when you run Time Administration task data validation will generate exceptions.

<b>Field or Control</b>	<b>Description</b>
<b>Save</b>	<p>Click this button to save the session. The system assigns a session number that replaces 9999999999.</p> <p>After you save a session, you can exit the page, return later, and enter additional rows of data for the session.</p>
<b>Submit</b>	<p>Click this button to validate the data you've entered. When you click this button, the system saves and submits the data. You cannot make any changes to the session until the Submit process is complete.</p>
<b>User ID</b>	<p>If this is a new session, your user ID appears here. If you are updating a session, the user ID of the last person who entered data for the session appears in this field.</p>
<b>Date/Time Updated</b>	<p>If this is a new session, the time you accessed the page appears. If you are updating a session, the date and time that data was last saved for the session appears.</p> <hr/> <p><b>Note:</b> You can see who entered time for an employee on a particular date on the Elapsed Time Audit page or Punch Time Audit page after the time data has gone through the Submit Time process.</p> <hr/>

## Adding Rows of Data During Rapid Time Reporting

You can add as many rows of data to a session as you need.

To add rows to a session:

1. In the **Rows to Add** field, enter the number of rows you want to add.
2. If you want the values entered in the previous row to be copied into the new rows, select the **Copy Down Values from Last Row** check box. Clear this check box if you want the system to add blank rows.
3. If you're using an elapsed time template and want each new row to display the next date, select the **Increment Date** check box.
4. Click the **Add Row(s)** button.

## Deleting Rows of Data During Rapid Time Reporting

To delete rows from a session:

1. Select the **Delete** check box for each row of data you want to delete.
2. Click the **Delete Selected Row(s)** button.

---

**Note:** To delete rows of rapid time that have been submitted, use the Timesheet page.

---

## Viewing Time Entered on the Rapid Time Reporting Page

To view a session entered on the Rapid Time Reporting page, access the page in Update/Display mode.

After time has been submitted, you can also view time by employee ID and date using the Timesheet page.

See the product documentation for *PeopleTools PeopleSoft Process Scheduler*

## TimeCard Page

Use the TimeCard page (TL\_REPORTS\_RNCTL) to display all punch time, elapsed time rows, payable time, and unresolved exceptions for an individual employee for the period selected on the run control.

The report can be run by an individual employee or by a group. The report contains lines for approval signatures for both the employee and the approving supervisor.

Navigation:

**Time and Labor > Reports > TimeCard > TimeCard**

<i><b>Field or Control</b></i>	<i><b>Description</b></i>
<b>Include/Exclude Indicator</b>	Use to include additional time reporters or exclude specific time reporters from the indicated group.

---

**Note:** This report provides functionality to replace the Reported Time by TRC report, TL006.SQR in prior versions.

---

See the product documentation for *PeopleTools PeopleSoft Process Scheduler*

# Using Time Collection Devices

---

## Understanding TCDs

Time and Labor's time collection process enables you to control how the system collects and sends time-related information to and from third-party, time-collection devices.

You can collect both punched and elapsed time data from any TCD for processing through Time and Labor. You can send setup data to these devices for improved performance and flexibility. Setup data, such as time reporter and supervisor information, task detail, and restriction rules, are synchronized with the clock system. After time is reported using a TCD, Time and Labor can apply rules to the clock data and process it for the purposes of scheduling, reporting, and time management.

Many TCD time reporters perform the same tasks, and their cost allocation data remains static. Using the TCD interface, time reporters can swipe their badges when they start and stop working without setting up task data. The time reporter's default task profiles, defined in Time and Labor, can then be used to allocate these costs.

Time and Labor uses schedules and restriction profiles to determine when a time reporter is scheduled to punch in and out for work, meals, and breaks, and to determine when to allow or disallow punches.

You can group TCD information by TCD taskgroup to use when enrolling time reporters into Time and Labor. Doing so allows time reporters assigned to a TCD taskgroup to enter time using any TCD configured to accommodate their taskgroup. For example, a time reporter can punch clock A when performing shipping tasks, and later, punch clock B found in another section of the warehouse when performing inventory tasks if both clocks were set up for that TCD taskgroup.

Time and Labor uses the information defined on the TCD pages to control the data going to the TCDs. It does not send data the TCD cannot handle, thus reducing traffic on the network.

---

## Understanding TCD Setup and Data Integration

When setting up a TCD, you identify a generic set of input data that is sent to your TCD systems. You also determine a generic set of output data that will be produced by your various TCD systems. Your TCD vendor will need to populate all required fields.

You determine the frequency in which you pass data between the TCD and Time and Labor; you should schedule the process to run on a regular basis.

---

**Note:** You do not need to set up TCDs to use PeopleSoft Mobile Time and Expense. Mobile Time and Expense sends service operations to Time and Labor by time reporter ID; these service operations contain elapsed time that Time and Labor sends to a pay system and to Project Costing. Mobile Time and Expense does not accept setup data from Time and Labor. For information about setting up integration with Mobile Time and Expense, see *"Integrating with PeopleSoft Financials."*

---

To set up a TCD, you need to:

- Establish flat file or Extensible Markup Language (XML) data integration information.
- Make sure your service operations are active.
- Set up the vendor interface for your organization.

Determine communication setup links between your TCDs and Time and Labor.

- Create a TCD configuration in Time and Labor, as described later in this section.
- Make sure all values are mapped and configured correctly.

If your TCD accepts schedule, TRC, or task information, your interface needs to map to the PeopleSoft codes that will be displayed on the TCD.

## **Related Links**

[Understanding the TCD Interface](#)

## TCD Setup Process Flow

This diagram is provided as a guide for integrating third-party TCDs with Time and Labor

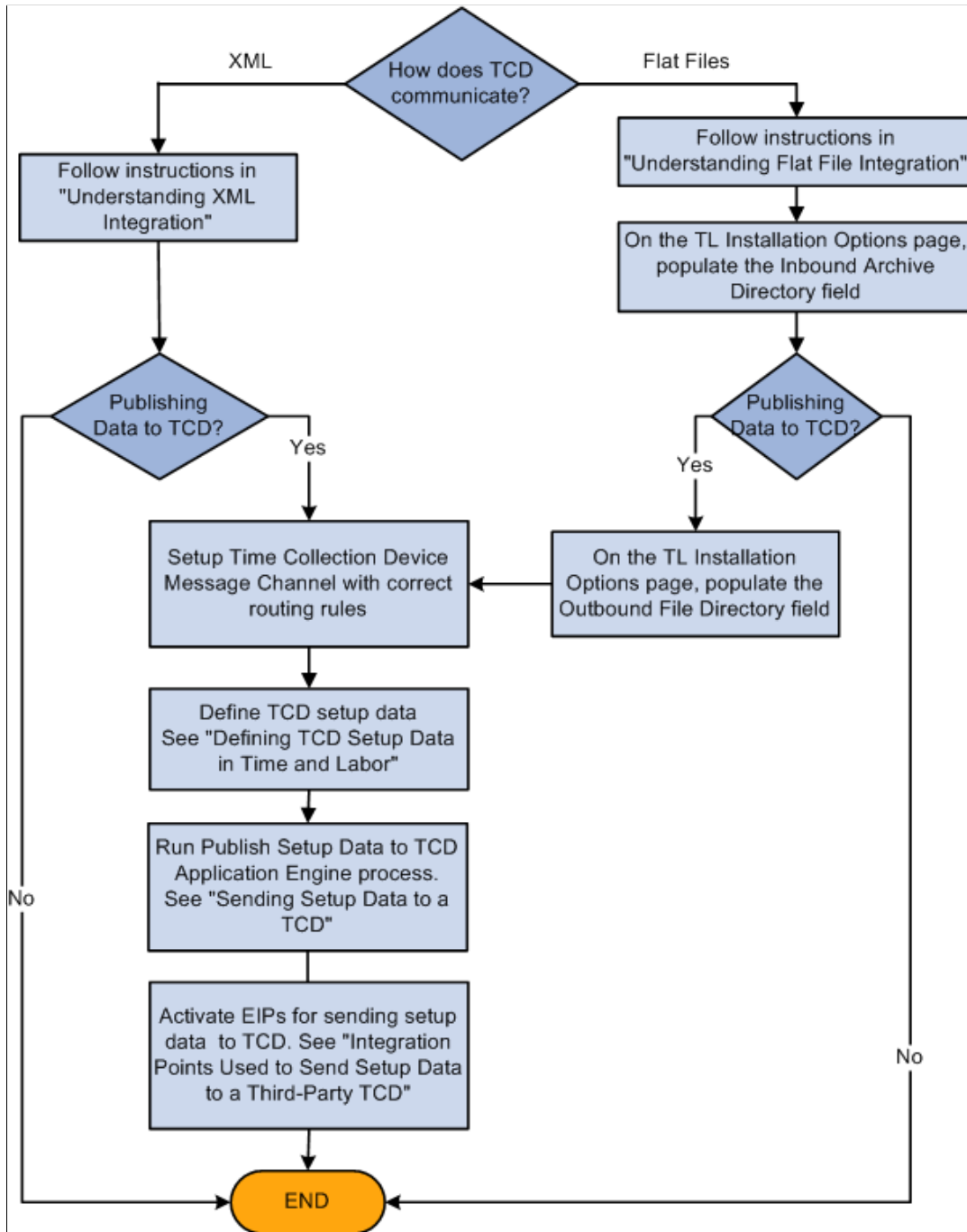

## Integration Points Used to Publish Data to Time and Labor

The following table lists the Integration Broker service operations used to publish data from a third-party TCD to Time and Labor.

<b>Integration Point</b>	<b>Service Operation</b>	<b>Queue</b>
T&L Labor Time Rep Elapsed Time	ELAPSED_TIME_ADD	ELAPSED_TIME
T&L Time Reporter Punch Time	PUNCHED_TIME_ADD	PUNCHED_TIME

## Understanding XML Integration

If you use XML, time sent from the TCD is transferred through an active service operation that is automatically sent to the reported time tables. For setup data being sent to the TCD, service operations are transferred as often as you determine them to be published.

To set up XML integration:

1. Ensure that the service operations are active.  
Activate service operations and their handlers, routings, and queues.
2. Make sure nodes have been created on the Nodes component (IB\_NODE).  
Each comm server is associated with a node.
3. Ensure that the appropriate ELAPSED\_TIME\_ADD and PUNCHED\_TIME\_ADD service operation routings are active for all required nodes on the Routings page in the Nodes component.

See the product documentation for *PeopleTools Integration Broker Service*.

## Understanding Flat File Integration

If you use flat file integration, the TCD writes a flat file of reported time to a common directory. The file is picked up by Time and Labor and converted to a message associated with a service operation. These service operations are integration points that send time data back and forth from Time and Labor to your TCD.

Flat files should be based on the table structures listed in the TCD Interface section. The date/time format for flat files is CCYY-DD-MMTHH:MM:SS.ssssss[+/-hhmm]. For example, 1999-09-14T16:47:56.793000-0700.

Each message listed corresponds to a flat file format. All flat files generated are in the CSV (comma-separated value) format. Quotation marks surround each field of data. The first row of each PeopleSoft-generated file is the PSCAMA record (PSCAMA stands for PeopleSoft Common Application Message Attributes). This record includes the message sequence and process instance fields.

The first field of each row is the name of that row's record; this allows for easy parsing of files with a parent and child record in the file format. Record names can be a maximum of 15 characters. The process instance combined with the message sequence allows split files to have data that ties them together. For example, if the TIME\_DEVICE\_EMPL\_ATT\_FULLLSYNC flat file becomes too large, it is split into multiple files with the same process instance.



If a TIME REPORTERS record with fields EMPLID and EMPL\_RCD, and a child record EMPL\_PHONE with fields EMPLID, EMPL\_RCD, and PHONE\_NBR are transmitted, here is what the sample files would look like:

```
File 1 (notice the message sequence of H for header)
"PSCAMA","ENG","","","H","18",""

File 2
"PSCAMA","ENG","","","","18",""
"TIME REPORTERS","1001","0"
"EMPL_PHONE", "1001","0","800 555-5555"
"TIME REPORTERS","1002","0"
"EMPL_PHONE", "1002","0","800 555-6666"
"TIME REPORTERS","1003","0"
"EMPL_PHONE", "1003","0","800 555-7777"

File 3 (notice the message sequence of T for trailer)
"PSCAMA","ENG","","","T","18",""
```

The first field of all rows is the record name. The process instance is the same for the header, detail, and trailing message.

Files generated by Time and Labor for the TCD are the form [message name]-[comm server ID]-[datetime of form ccyy\_mm\_dd\_hh\_mm\_ss].csv . Each part of the filename is separated by a hyphen. These files are always new; Time and Labor will never append to an existing file. Once a file has been processed by the comm server, you should move it into an archive directory.

Files generated by the comm server for the Time and Labor should be of the form [message name]-[comm server].csv. The comm server should always append to the end of the file. Once PeopleSoft has processed the data, it is removed from the file and placed in an archive file of the form [message name]-[comm server ID]-[datetime of form ccyy\_mm\_dd\_hh\_mm\_ss]. csv. This file is placed in an archive directory.

Flat file directories are part of Time and Labor setup. The TCD vendor should have a similar type of setup, so that none of the programs have hard-coded path names.

The most seamless flat file integration should be completely controlled by scheduled processes. Process schedulers exist on the PeopleSoft side and should also exist on the TCD vendor side. At a specified time, a scheduled process polls a directory to find files (punched and elapsed time) that follow the naming convention specified above. The TCD vendor's process scheduler should regularly initiate a process that polls a directory for the TCD setup data. The TCD vendor process scheduler should also regularly initiate a process that appends time on to the punched and elapsed time flat files. Schedulers should be strategically timed so that there is very little risk of contention. For example, the TCD vendor's population of the punched and elapsed time flat files could be at 2 a.m. every morning, while PeopleSoft's extraction of data from these files could be at 4 a.m. every morning. Also, any system that is reading from or writing to a file should force that file to be inaccessible to all other systems.

To set up flat file integration:

1. Ensure that the service operations are active.

- Verify that one of the nodes on the PUNCHED\_TIME and/or ELAPSED\_TIME queues is the local node.

The appropriate routings should be specified for all the nodes on the Routings page of the Nodes component (IB\_NODE).

- Set up the inbound file rule on the File Inbound page (Enterprise Components, Integration Definitions, Inbound File Rule).
- On the Time and Labor Installation page, set up the File Dest for TCD Integration section. See [Setting Up System Defaults and Loading Dates](#).
- Make sure that the selected directory will contain the elapsed or punch time files.
- Your inbound file publish rules should look similar to the following:

Inbound File for Punched Time: c:\temp\PUNCHED\_TIME\_ADD\*.csv. File Layout ID: Blank, LUW Size: Blank, Application: TL\_TCD\_FILE, Section: Archive, File Layout Name: 1 PUNCHED\_TIME\_ADD, Message Name: PUNCHED\_TIME\_ADD.

This graphic shows an example of the File Inbound page used to set up flat file integration

**File Inbound**

**File Identifier:** PUNCHED\_TIME

**\*Inbound File:** c:\temp\PUNCHED\_TIME\*.csv  **Index Flag**

**\*Status:** Active

**File Layout ID:**

**LUW Size:**

**Program Name:** TL\_TCD\_FILE **Section:** ARCHIVE

**Create Message Header**

**Create Message Trailer**

File Layout		Customize	Find	View All	First	1 of 1	Last
	*Definition Name	*Message Name					
1	PUNCHED_TIME_ADD	PUNCHED_TIME_ADD					

The comm server attached to your TCD creates and continually appends to a file of the form [message name]-[comm server]. csv. For example, comm server cs1 would create and append onto a file named PUNCHED\_TIME\_ADD-cs1.csv for its punch time message. The directory containing the comm-server-generated files should correspond to the directory in the Inbound File Rule.

To initiate the inbound file publish, select **Enterprise Components, Integration Definitions, Initiate Processes, Inbound File Publish** and create a run control.

After the punched time has been received by Time and Labor, the time is evaluated. If the time is error-free, the rows are located in Reported Time. If the time is invalid, the message is displayed on the TCD error queue.

**Note:** If the data from your TCD is in flat file format and the value is in character format for a numeric field, the default character is zero (0). If a value is sent in a numeric format for a character field, the system adds that value into the field. If the data from your TCD is in XML format, the message including invalid formats for the fields is stopped in the Service Operations Monitor.

You need to make sure the information you send is in the correct format for proper processing. This is especially important if you are using multiple jobs and reporting by multiple time reporter record numbers. If you fill in the time reporter ID but not the time reporter record number, the system uses a default time reporter record number of zero. This is a valid value, so you will need to be sure the proper time reporter record number is entered before sending the information to Time and Labor.

See the product documentation for *PeopleTools Integration Broker Service* and *PeopleTools Integration Broker Testing*

## Related Links

[Understanding Integration](#)

## Defining TCD Setup Data in Time and Labor

This section discusses how to define TCD setup data.

### Pages Used to Define TCD Setup Data in Time and Labor

<b>Page Name</b>	<b>Definition Name</b>	<b>Usage</b>
<a href="#">TCD Type Definition Page</a>	TL_TCDDEF_PNL	Select data elements to pass from Time and Labor to a TCD.
<a href="#">TCD Setup Page</a>	TL_TCD_SETUP_PNL	Establish basic information about a TCD.
<a href="#">TCD Taskgroup Page</a>	TL_TCD_TSKGRP_PNL	Specify physical and taskgroup information for a TCD.
<a href="#">TCD Supervisor Page</a>	TL_TCD_SUPERV_PNL	Establish supervisors allowed to perform TCD functions.
<a href="#">TCD Restriction Profile Page</a>	TL_RESPRF_PNL	Establish restriction profile data. Your TCD uses this information to determine when to allow or disallow punches.
<a href="#">TCD Group Page</a>	TL_TCDGRP_PNL	Establish TCD groups for time reporting purposes.

## TCD Type Definition Page

Use the TCD Type Definition page (TL\_TCDDEF\_PNL) to select data elements to pass from Time and Labor to a TCD.

Navigation:

**Set Up HCM > Product Related > Time and Labor > Time Collection Devices > TCD Type Definition > TCD Type Definition**

This example illustrates the fields and controls on the TCD Type Definition page. You can find definitions for the fields and controls later on this page.

The screenshot shows the 'TCD Type Definition' page for 'TCD Type KUFLAT1'. It includes a search bar with 'Find | View All' and navigation buttons for 'First', '1 of 1', and 'Last'. The main form contains the following fields and controls:

- \*Effective Date:** 01/01/1980
- \*Status:** Active
- \*Description:** Flt, Prfls, TRCs, Sched 7, RE1
- Short Description:** Flat1
- \*Integration Type:** Flat File Integration

The 'TCD Function Integration' section is divided into four panels:

- Main Components:**
  - Send Hours
  - Send TRCs
  - Send Schedules
  - Schedule Days: 7
- Task Elements:**
  - Send Task Profiles
  - Send Task Template
  - Send Task Values
- Time Reporting Elements:**
  - Send Country
  - Send State
  - Send Locality
  - Send Rate Code
  - Send Currency Code
  - Send Override Reason Code
- Rule Elements:**
  - Send Rule Element 1
  - Send Rule Element 2
  - Send Rule Element 3
  - Send Rule Element 4
  - Send Rule Element 5

### Task Elements

<i>Field or Control</i>	<i>Description</i>
<b>Send Task Profiles</b>	<p>Select to send valid task profiles from Time and Labor to your TCD.</p> <p>The system only extracts and sends task profile records that are defined as Send to TCD. Valid task profiles are derived from taskgroups associated to your TCD.</p>

<b>Field or Control</b>	<b>Description</b>
<b>Send Task Template</b>	<p>Select to send valid task templates to your TCD.</p> <p>Task templates contain the task elements that can be entered at your TCD, such as a value for department and account code. Valid templates are derived from taskgroups associated to your TCD.</p> <hr/> <p><b>Note:</b> If you use task template reporting but do not want to present a list of templates for time reporters to select from, the system sends a default task template for each time reporter message. This default provides the ability to automatically prompt for task elements based on the time reporter at your TCD.</p> <hr/>
<b>Send Task Values</b>	<p>Select to send task values to your TCD. This option is only available if you select <b>Send Task Templates</b>.</p> <p>Task values correspond to valid task elements associated to the task template. For example, valid values for task elements Department and Account Code may be Shipping and Receiving and 1001 and 1002.</p>
<b>Send Hours</b>	<p>Select to send hours to your TCD, which represent the total hours that will be compensated.</p> <p>These hours have been run through the Time Administration process and are considered payable time. The sent payable time hours with TRCs are for the beginning of the time reporter's current period up to the current date.</p>
<b>Send TRCs</b>	<p>Select to send time reporting codes (TRCs) to your TCD.</p> <p>The system only extracts and sends TRCs that have been established as Send to TCD on the TRC definition and are a part of the TRC program ID you select on the TCD Setup page.</p> <hr/> <p><b>Note:</b> You may need to convert character codes to numeric codes before you can use them, depending on your TCD's requirements.</p> <hr/>

<b>Field or Control</b>	<b>Description</b>
<b>Send Schedules</b>	<p>Select to send schedules to your TCD.</p> <p>Schedule information comes from the Schedule table. The system sends time reporters' daily punch schedules to your TCD. Your TCD uses this information to determine when time reporters are scheduled to punch in and out for work, meals, and breaks. Your scheduling setup, assignment, and calendar build process must be executed before Time and Labor can send the appropriate information to your TCD.</p> <p>The system does not send holiday schedules to your TCD. You'll need to determine how to assign schedules in coordination with the holiday schedule.</p> <p>You must select this check box to use restriction profiles with your TCD.</p> <hr/> <p><b>Note:</b> This data structure contains multiple instances of schedules per day. If your TCD requires only one schedule record per day, you need to reformat the input data before sending schedules to your TCD.</p> <hr/>
<b>Schedules Days</b>	<p>Enter the number of days of the schedule to send to your TCD.</p> <p>For each time reporter, the system sends today's punch schedule detail in addition to the number of days you define in this field. The limit is 99. If <b>Send Schedules</b> is clear, this field is unavailable for entry.</p>

## Rule Elements

<b>Field or Control</b>	<b>Description</b>
<b>Send Rule Element 1-5</b>	<p>Select to send values from the Rule Element tables one through five to your TCD.</p> <p>Rule elements can be positively reported. They are special compensation elements that are used in building rules and in Time Administration. For example, if a rule element value on the Rule Element table is labeled Close Store, and a time reporter reported this code, the time reporter could receive special compensation based on the rules for closing the store for the day.</p>

## Reporting Elements

<i>Field or Control</i>	<i>Description</i>
<b>Send Country, Select State, and Select Locality</b>	<p>Select to send a list of country, state, and locality names to be positively reported with time.</p> <p>The system uses the default country, state, or locality defined on the TCD if one is not positively reported.</p> <hr/> <p><b>Note:</b> At table change time, there is no way for Time and Labor to determine if the country, state, or locality was positively reported or if the default value was used. As a result, the system cannot perform any referential integrity actions on these fields if there are changes</p> <hr/>
<b>Send Rate Code</b>	Select to send a list of valid comp rate codes to be reported at the TCD. This value is only valid in conjunction with a reported TRC at the TCD.
<b>Send Currency Code</b>	Select to send a list of valid currency codes to be reported at the TCD.
<b>Send Override Reason Code</b>	Select to send codes from the Override Reason Code page.

## Integration Type

<i>Field or Control</i>	<i>Description</i>
<b>XML Integration</b>	Select if you are using XML integration.
<b>Flat File Integration</b>	Select if you are using flat file integration. If you select this option, you must also establish an outbound and inbound archive file location on the TL Installation page.

**Note:** If the country, state, or locality contained in the inbound interface are different from the TCD setup default, then the inbound interface automatically populates those fields with what is positively reported. It should also be noted that the inbound interface allows for positive reporting on these fields. Therefore, at table change time, there is no way for Time and Labor to determine if the time was positively reported, or if it was defaulted in from the TCD definition. As a result, the system will not perform any referential integrity actions on these fields if there are changes.

## Related Links

[Understanding Time Reporting Codes](#)

[Understanding Task Reporting Requirements](#)

Defining Rule Elements  
Understanding Time and Labor Implementation

## TCD Setup Page

Use the TCD Setup page (TL\_TCD\_SETUP\_PNL) to establish basic information about a TCD.

Navigation:

**Set Up HCM > Product Related > Time and Labor > Time Collection Devices > TCD Setup > TCD Setup**

This example illustrates the fields and controls on the TCD Setup page. You can find definitions for the fields and controls later on this page.

The screenshot shows the TCD Setup page for TCD ID KUTCD1. It is divided into two main sections: Time Collection Device Settings and TCD Communication Settings. The Time Collection Device Settings section includes fields for \*Effective Date (01/01/1980), \*Status (Active), \*Description (First Floor Time Clock), Short Description (TCD1), Installation Date (01/01/1980), \*TCD Type (KUXML1), and TRC Program ID (KUTP2). The TCD Communication Settings section includes \*Message Node Name (PSFT\_HR), Terminal ID, and Network ID.

<b>Field or Control</b>	<b>Description</b>
<b>Installation Date</b>	Select the date your TCD was installed. Used for your reference only.
<b>TCD Type</b>	Select the TCD type. This is required so the system knows which data elements to send to your TCD. This also reflects if your TCD type is an XML or flat file.
<b>TRC Program ID</b>	Select the TRC program ID associated with the TRCs you want to send to your TCD. This field is required if you selected to Send TRCs on the TCD Type page.  <b>Note:</b> Only TRCs in the TRC Program that are defined as Send to TCD are sent to your TCD.



<b>Field or Control</b>	<b>Description</b>
<b>Message Node Name</b>	<p>Enter the message node or comm serv ID to which you want to send TCD information. The field changes based on the TCD type you selected.</p> <p>A comm serv ID is used for flat file integration. A message node is used for XML integration; it uses PeopleSoft Integration Broker technology.</p>
<b>Terminal ID</b>	<p>Enter the ID you use for your TCD.</p> <p>The value depends upon your system configuration. This field is required if your TCD is configured according to the Configuration 2 illustration following this table.</p>
<b>Network ID</b>	<p>Enter the network ID to which you want Time and Labor to send data.</p> <p>This field is required if your organization is configured according to the Configuration 3 illustration following this table.</p>

## Determining Your Communication Settings

Use the following diagrams to determine which communication settings you need.

This diagram illustrates the communications settings needed if you uniquely identify your terminals throughout the system, requiring only a Comm Serv/Message Node.

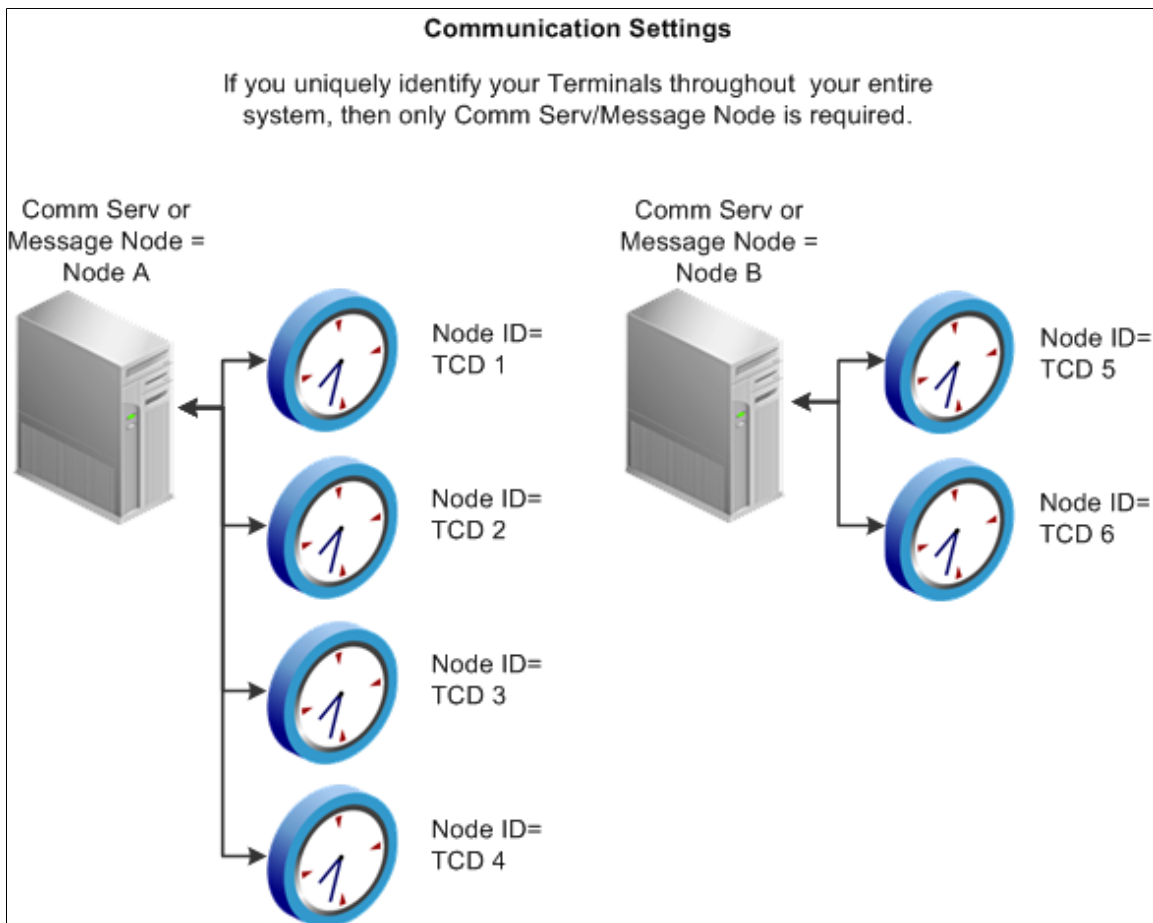

This diagram illustrates the communications settings needed if you do not uniquely identify your terminals throughout the system, requiring both Comm Serv/Message Node and Terminal ID

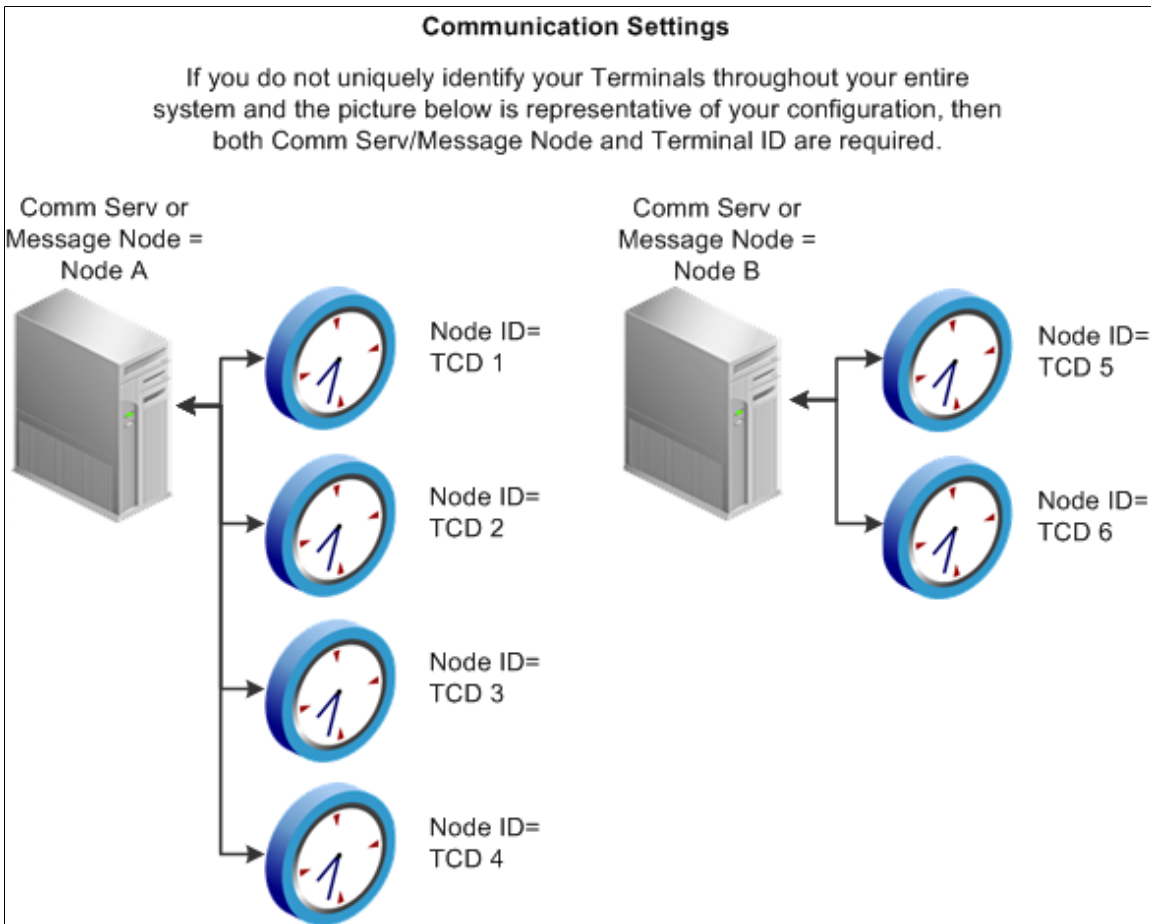

This diagram illustrates the communications settings needed if you do not uniquely identify your terminals throughout the system, requiring all communication settings

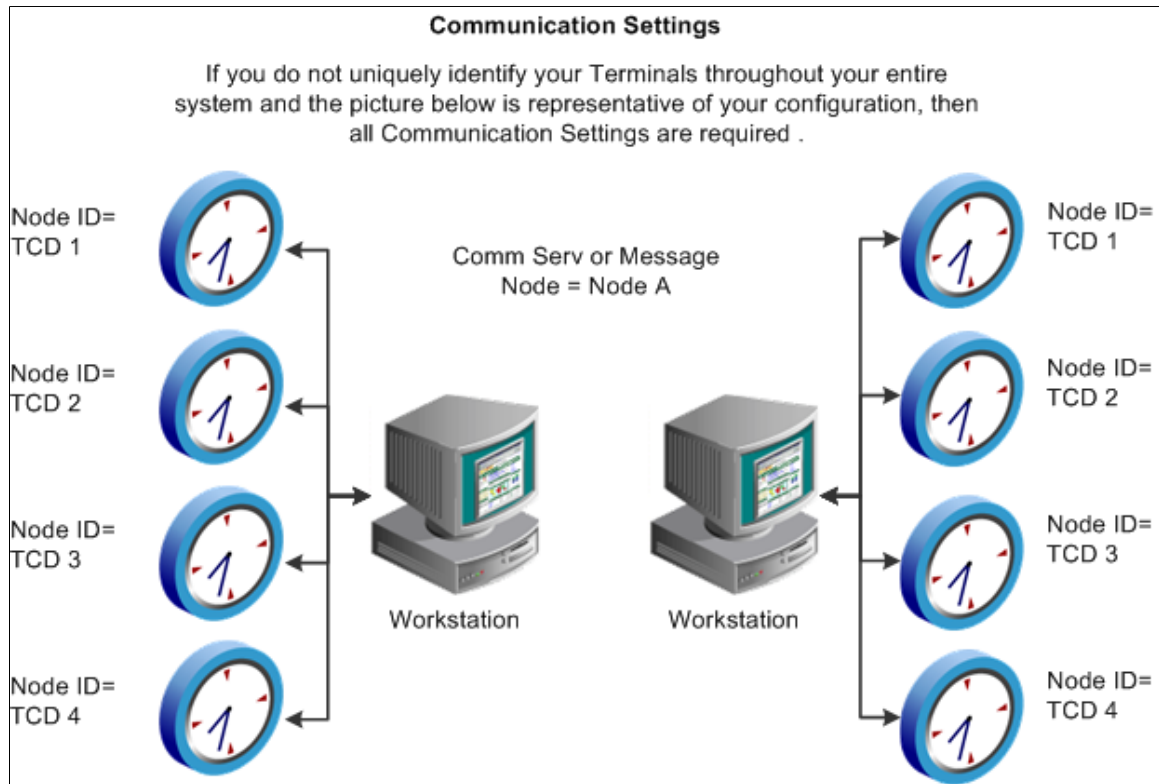

## TCD Taskgroup Page

Use the TCD Taskgroup page (TL\_TCD\_TSKGRP\_PNL) to specify physical and taskgroup information for a TCD.

Navigation:

**Set Up HCM > Product Related > Time and Labor > Time Collection Devices > TCD Setup > TCD Taskgroup**

This example illustrates the fields and controls on the TCD Taskgroup page. You can find definitions for the fields and controls later on this page.

The screenshot shows the 'TCD Taskgroup' page for TCD ID KUTCD1. It features a 'TCD Physical Settings' section with fields for Effective Date (01/01/1980), Country (USA), State (CA), Locality (67000), Time Zone (PST), and Language Code (English). Below this is a 'Taskgroups' table with two entries: KUTSKGRP1 and KUTSKGRP2, both described as 'Task Grp for Template & Prfl 1' and 'Task Grp for Template & Prfl 2' respectively.

### TCD Physical Settings

<i>Field or Control</i>	<i>Description</i>
<b>Country, State, and Locality</b>	<p>Select the country, state, and locality where this TCD is located.</p> <hr/> <p><b>Note:</b> Country, state, and locality can be positively reported using the Punch or Elapsed Time Interface. If they are not positively reported, the system populates the time records with these values. If the values are not established here, the system does not pass any values at all to Time Administration. The receiving payroll system will have to get the default country, state, and locality.</p>
<b>TimeZone</b>	<p>Select the time zone where this TCD is located.</p> <p>The system uses the time zone for punch time reporting. If a time zone is not reported or it isn't validated during the TCD Interface process, the system looks for the time zone defined here. If a time zone isn't defined here, the system looks at the base time zone on the PeopleTools Options page, under Utilities.</p>

## Time Collection Device Taskgroups

<i>Field or Control</i>	<i>Description</i>
<b>Taskgroup</b>	<p>Select one or more taskgroups to send to your TCD.</p> <p>The system edits time reporter data to verify if the time reporter is assigned to a taskgroup that is associated to a TCD in the time reporter's TCD group. If a time reporter reports time to a taskgroup (task profiles or task values) that are not related to the taskgroup assigned to the time reporter, the taskgroup will be considered borrowed.</p>

### Related Links

[Defining Taskgroups](#)

## TCD Supervisor Page

Use the TCD Supervisor page (TL\_TCD\_SUPERV\_PNL) to establish supervisors allowed to perform TCD functions.

Navigation:

**Set Up HCM > Product Related > Time and Labor > Time Collection Devices > TCD Supervisor > TCD Supervisor**

This example illustrates the fields and controls on the TCD Supervisor page. You can find definitions for the fields and controls later on this page.

**TCD Supervisor**

**Antonio Santos** Person ID KU0010

---

**TCD Supervisor**

\*TCD Supervisor ID

Supervisor PIN Number

<i>Field or Control</i>	<i>Description</i>
<b>TCD Supervisor ID</b>	<p>Enter a unique supervisor ID.</p> <p>You assign supervisors to TCDs on the TCD Group page.</p>
<b>Supervisor Pin Number</b> (supervisor personal identification number)	<p>Enter a PIN associated with the supervisor ID.</p> <p>This ID could be the password used to access the TCD to override a punch or function.</p>

## TCD Restriction Profile Page

Use the TCD Restriction Profile page (TL\_RESPRF\_PNL) to establish restriction profile data.

Your TCD uses this information to determine when to allow or disallow punches.

Navigation:

**Set Up HCM > Product Related > Time and Labor > Time Collection Devices > TCD Restriction Profile > TCD Restriction Profile**

This example illustrates the fields and controls on the TCD Restriction Profile page. You can find definitions for the fields and controls later on this page.

The screenshot shows the 'TCD Restriction Profile' page for 'Restriction Profile ID KURSTPRF1'. It includes a 'Restriction Profile Attributes' section with fields for '\*Effective Date' (01/01/1980), '\*Status' (Active), '\*Description' (Basic Restriction Profile), and 'Short Description' (RestPrfl1). Below this is a section titled 'Punch restrictions with Margins in minutes' containing several rows of checkboxes and input fields for margins: Restrict Unscheduled Meal Punches, Restrict Early In (margin 15), Restrict Late In (margin 10), Restrict Early Out (margin 15), Restrict Late Out, Restrict Early Meal, Restrict Late Meal (margin 10), Restrict Early Break, and Restrict Late Break (margin 5).

<b>Field or Control</b>	<b>Description</b>
<b>Restrict Unsched Meal Punch</b> (restrict unscheduled meal punch)	Select to restrict a time reporter from punching out for an unscheduled meal.
<b>Restrict Early In Indicator</b>	Select to restrict a time reporter from punching in early.
<b>Early In Punch Margin (Mins)</b> (early in punch margin [minutes])	Enter the number of minutes you will allow a time reporter to punch in early. Unavailable if <b>Restrict Early In Indicator</b> is cleared.
<b>Restrict Late In Punch</b>	Select to restrict a time reporter from punching in late.
<b>Late In-Punch Margin (Mins)</b> (late in punch margin [minutes])	Enter the number of minutes you will allow a time reporter to punch in late. Unavailable if <b>Restrict Late In Indicator</b> is cleared.
<b>Restrict Early Out Indicator</b>	Select to restrict a time reporter from punching out early.

<b>Field or Control</b>	<b>Description</b>
<b>Early Out-Punch Margin (Mins)</b> (early out punch margin [minutes])	Enter the number of minutes you will allow a time reporter to punch out early. Unavailable if <b>Restrict Early Out Indicator</b> is cleared.
<b>Restrict Late Out Indicator</b>	Select to restrict a time reporter from punching out late.
<b>Late Out-Punch Margin (Mins)</b> (late out punch margin [minutes])	Enter the number of minutes you will allow a time reporter to punch out late. Unavailable if <b>Restrict Late Out Indicator</b> is cleared.
<b>Restrict Early Meal Indicator</b>	Select to restrict a time reporter from punching out early for a meal.
<b>Early Meal Margin (Mins)</b> (early meal margin [minutes])	Enter the number of minutes you will allow a time reporter to punch in early for a meal. Unavailable if <b>Restrict Early Meal Indicator</b> is cleared.
<b>Restrict Late Meal Indicator</b>	Select to restrict a time reporter from punching in late after a meal.
<b>Late Meal Margin (Mins)</b> (late meal margin [minutes])	Enter the number of minutes you will allow a time reporter to punch in late after a meal. Unavailable if <b>Restrict Late Meal Indicator</b> is cleared.
<b>Restrict Early Break Indicator</b>	Select to restrict a time reporter from punching in early after a break.
<b>Early Break Margin (Mins)</b> (early break margin [minutes])	Enter the number of minutes you will allow a time reporter to punch in early after a break. Unavailable if <b>Restrict Early Break Indicator</b> is cleared.
<b>Restrict Late Break Indicator</b>	Select to restrict a time reporter from punching in late after a break.
<b>Late Break Margin (Mins)</b> (late break margin [minutes])	Enter the number of minutes you will allow a time reporter to punch in late after a break. Unavailable if <b>Restrict Late Break Indicator</b> is cleared.

**Note:** To use restriction profiles, you must set up punch schedules and select the **Send Schedules** check box on the TCD Type Definition page.

## TCD Group Page

Use the TCD Group page (TL\_TCDGRP\_PNL) to establish TCD groups for time reporting purposes.

Navigation:



**Set Up HCM > Product Related > Time and Labor > Time Collection Devices > TCD Group > TCD Group**

This example illustrates the fields and controls on the TCD Group page. You can find definitions for the fields and controls later on this page.

This page is used to group together a restriction profile ID, TCDs and TCD supervisors. TCD groups are associated to time reporters.

<i>Field or Control</i>	<i>Description</i>
<b>Restriction Profile ID</b>	Select a restriction profile ID that allows or disallows users to punch in and out.

**Time Collection Devices**

<i>Field or Control</i>	<i>Description</i>
<b>TCD ID</b> (unlabeled)	Select the IDs of the TCDs you want in this group.

**Time Collection Device Supervisors**

<i>Field or Control</i>	<i>Description</i>
<b>TCD Supervisor ID</b> (unlabeled)	Select the supervisor ID of the person who can perform supervisor functions for the TCDs in this group.

---

## **Sending Setup Data to a TCD**

This section provides an overview of data publishing to a TCD and describes how to publish Time and Labor setup data.

## Page Used to Send Setup Data to a TCD

<i>Page Name</i>	<i>Definition Name</i>	<i>Usage</i>
Send Setup to TCD Page	TL_TCD_RUN_PNL	<p>Publish setup information for your TCD to retrieve from Time and Labor.</p> <p>This page can also be used to Generate a TCD Usage report that sums up the number of elements transmitted to a TCD during time reporting. The TCD Usage report can be used to estimate the memory requirements of each TCD.</p>

## Understanding Data Publishing to a TCD

Time and Labor sends (publishes) setup data to your TCD in the form of messages associated with service operations. The publish process can be scheduled to run once or multiple times a day. All information contained in one set of published messages replaces the previously stored information at the TCD level. The date the system uses to retrieve TCD information is always the current date.

This diagram depicts how Time and Labor publishes information to your TCD

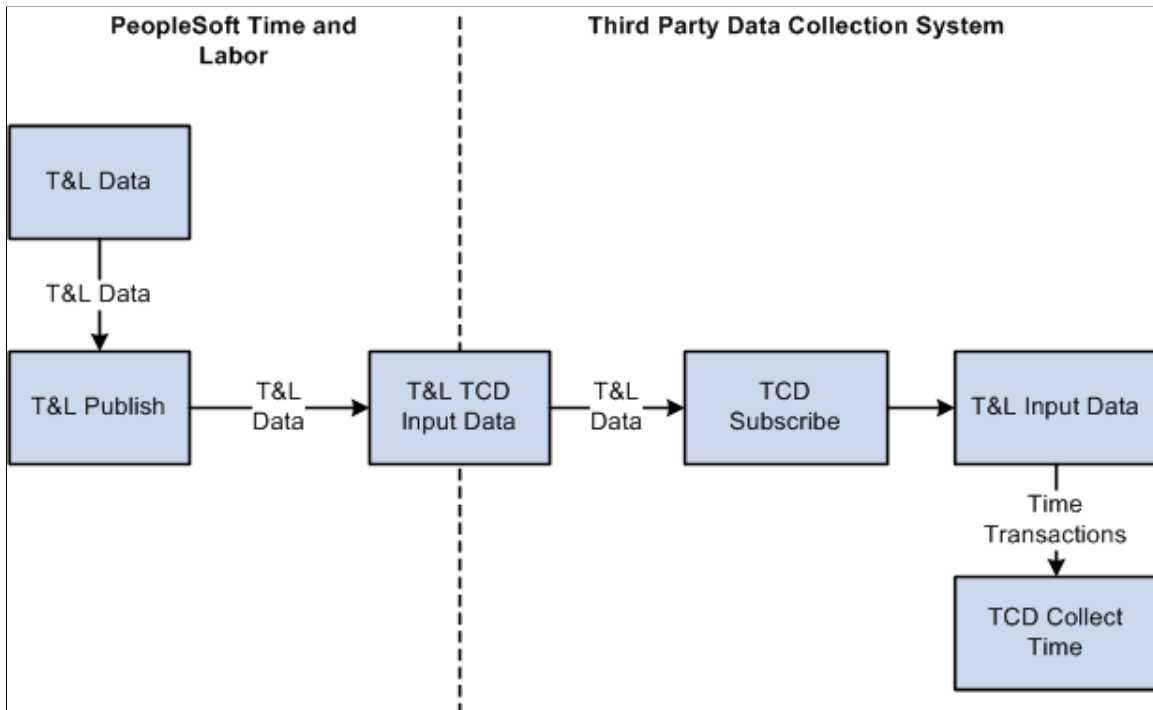

Incremental messages are sent when time reporter data changes in Time and Labor. Incremental messages are sent when you change:

- Time reporter status.
- The TCD group associated to the time reporter.

- The elements in a TCD group.

You can send the published messages to all or selected message nodes/comm servers.

Use the TCD Usage report to determine how many values of each kind of reporting element are sent to a TCD.

### Integration Points Used to Send Setup Data to a Third-Party TCD

The following table lists the integration points that the Time and Labor TCD interface uses to send setup information from Time and Labor to a third-party TCD. All TCD integration points are batch published.

<b>Functional Name</b>	<b>Service Operation</b>	<b>QUEUE</b>
T&L Payable Time Totals by TRC	TIME_DEVICE_PER_HRS_ FULLSYNC	TIME_COLLECTION_DEVICE_ SETUP
T&L REPORTING ELEMENTS	TIME_DEVICE_RPT_ELMNT_ FULLSYNC	TIME_COLLECTION_DEVICE_ SETUP
T&L SUPERVISORS	TIME_DEVICE_SUPERVISOR_ FULLSYNC	TIME_COLLECTION_DEVICE_ SETUP
T&L TASK ELEMENT CODE VALUES	TIME_DEVICE_TASK_VALS_ FULLSYNC	TIME_COLLECTION_DEVICE_ SETUP
T&L TASK PROFILES	TIME_DEVICE_PROFILES_ FULLSYNC	TIME_COLLECTION_DEVICE_ SETUP
T&L TASK TEMPLATES	TIME_DEVICE_TEMPLATES_ FULLSYNC	TIME_COLLECTION_DEVICE_ SETUP
T&L TIME REPORTER DATA	TIME_DEVICE_EMPL_ATT_ FULLSYNC	TIME_COLLECTION_DEVICE_ SETUP
T&L TIME REPORTER SCHEDULES (Outbound)	TIME_DEVICE_SCHEDULE_ FULLSYNC	TIME_COLLECTION_DEVICE_ SETUP
T&L TIME REPORTER PUNCH RESTRICTION RULE	TIME_DEVICE_RESTRICT_ FULLSYNC	TIME_COLLECTION_DEVICE_ SETUP
T&L TRC INFORMATION	TIME_DEVICE_RPTG_CODE_ FULLSYNC	TIME_COLLECTION_DEVICE_ SETUP

---

**Note:** To research the technical details of any integration point used by PeopleSoft applications, refer to the Interactive Services Repository on My Oracle Support.

---

## TCD Message Types

Time and Labor uses the information you defined on the TCD setup pages to control the data going to your TCD. The following table summarizes the types of TCD messages.

<b>Table</b>	<b>Comment</b>
Time Reporter	Contains basic information about a time reporter.
Schedule	Contains a time reporter's daily schedules.
Restriction Profile	Contains restriction information from the TCD Restriction page.
Total Hours	Contains total hours already worked in the current week. Your TCD displays this information to the time reporter or supervisor.
Time Reporting Code	Contains various TRCs for elapsed time reporting purposes (sick, vacation, holiday, and so on).
TCD Supervisor	Contains a list of supervisors who are authorized to perform supervisor functions at various TCDs.
TCD Task Profile	Contains a list of task profiles associated with each TCD. The system uses task profiles for positive task profile reporting, where the time reporter must indicate the type of work being performed.
TCD Task Template	<p>Contains a list of task templates associated with each TCD. The system uses task templates for positive task element reporting, where the time reporter must indicate the type of work being performed as well as labor information.</p> <p>Task templates also identify rule elements, which define how the time reporter is paid. These are additional task elements the time reporter can report.</p>
Reporting Element Tables	Contains a list of countries, states, localities, comp rate codes, currency codes, and override reason codes, which a time reporter can override when reporting time.

## Related Links

[TCD Setup Page](#)

[Understanding the TCD Interface](#)

## Send Setup to TCD Page

Use the Send Setup to TCD page (TL\_TCD\_RUN\_PNL) to publish setup information for your TCD to retrieve from Time and Labor.

This page can also be used to Generate a TCD Usage report that sums up the number of elements transmitted to a TCD during time reporting. The TCD Usage report can be used to estimate the memory requirements of each TCD.

Navigation:

**Set Up HCM > Product Related > Time and Labor > Time Collection Devices > Send Setup to TCD > Send Setup to TCD**

This example illustrates the fields and controls on the Send Setup to TCD page. You can find definitions for the fields and controls later on this page.

<b>Field or Control</b>	<b>Description</b>
<b>All Msg Nodes/Comm Servers</b>	Select to publish the information to all your TCDs (message nodes).
<b>Specific Msg Nodes/Comm Servers</b>	Select to send to a specific message node, or TCD.
<b>Generate TCD Usage Report</b>	Select to generate a TCD Usage report for this TCD run. Select this check box if you want the system to generate a summary TCD Usage report for this TCD run.
<b>Include Detail</b>	Select to generate a detail report for all the values being sent for this TCD run. Only available if <b>Generate TCD Usage Report</b> is selected.

<b>Field or Control</b>	<b>Description</b>
<b>Language Code</b>	Select the language the report will be printed in.
<b>Message Node Name</b>	Enter a TCD (message node) to send the data to.  Only available if <b>Specific Msg Nodes/Comm Servrs</b> is selected.

What is actually sent to the time collection device is determined by the parameters defined on the TCD Type pages associated to each TCD.

The TCD Usage report summarizes the following:

- The number of time reporters sent to the TCD.
- The number of rows of total payable time hours sent for the time reporter's current period.
- The number of punches from the time reporters punch schedules.
- The number of time collection device supervisors associated with that TCD.
- The number of restriction profiles associated with that TCD.
- The number of time reporting codes sent to the TCD.
- The number of task templates sent to the TCD.
- The number of task elements sent to the TCD.
- The number of task values sent to the TCD.
- The number of countries sent to the TCD.
- The number of states sent to the TCD.
- The number of localities sent to the TCD.
- The number of compensation rate codes sent to the TCD.
- The number of override reasons sent to the TCD.
- The number of currency codes sent to the TCD.

For the detail page of the Usage report, the following elements are detailed if they are sent to your TCD:

- Time reporter
  - Employee ID
  - Record #
  - Badge ID
  - First name

- Last name
- TCD supervisors
  - Supervisor ID
  - Badge ID
- Restriction profiles
  - Restriction profiles
  - Description
- Time reporting codes
  - Time reporting code
  - Description
- Task profiles
  - Task Profile ID
  - Description
- Task templates
  - Task template
  - Description
- Task elements
  - Task Template ID
  - Task element code
  - Description

See the product documentation for *PeopleTools PeopleSoft Process Scheduler*

---

## Receiving Time from a TCD

To receive time data from a TCD into Time and Labor, you must initiate the Subscribe process. If errors are not found, the data proceeds directly to the Reported Time tables. The system validates the information by:

- Performing standard format edits.
- Translating badge IDs to employee IDs.
- Creating reported time entries.

Time is also populated in the Reported Time tables and then run through Time Administration to create payable time when you have the Automatic Rules Run selected on the TL Installations page.

A time reporter can report time at more than one TCD; therefore, the system accepts data for a time reporter from multiple sources at the same time.

## Stopping the TCD Error Queue

If errors occur, the TCD error queue will stop time data from proceeding to the Reported Time tables if the any of following are invalid:

- EMPLID
- EMPL RCD
- BADGE ID
- TASK ELEMENT CODES
- DUR (Date Under Report)
- PUNCH DATE/TIME
- ADD/DELETE INDICATOR
- DELETE DATE

TCD Error Queue Does Not Stop the following elements if they are invalid, as these will be validated as Reported Time is created:

- Task Template ID – task profiles or Task Element Codes are populated. However, a blank value is sent for an invalid taskgroup.
- Task Element Values
- Time Zone
- Override Reason Code
- Task Profile ID
- Location
- Country
- State
- Locality



This diagram depicts how Time and Labor collects data from a TCD.

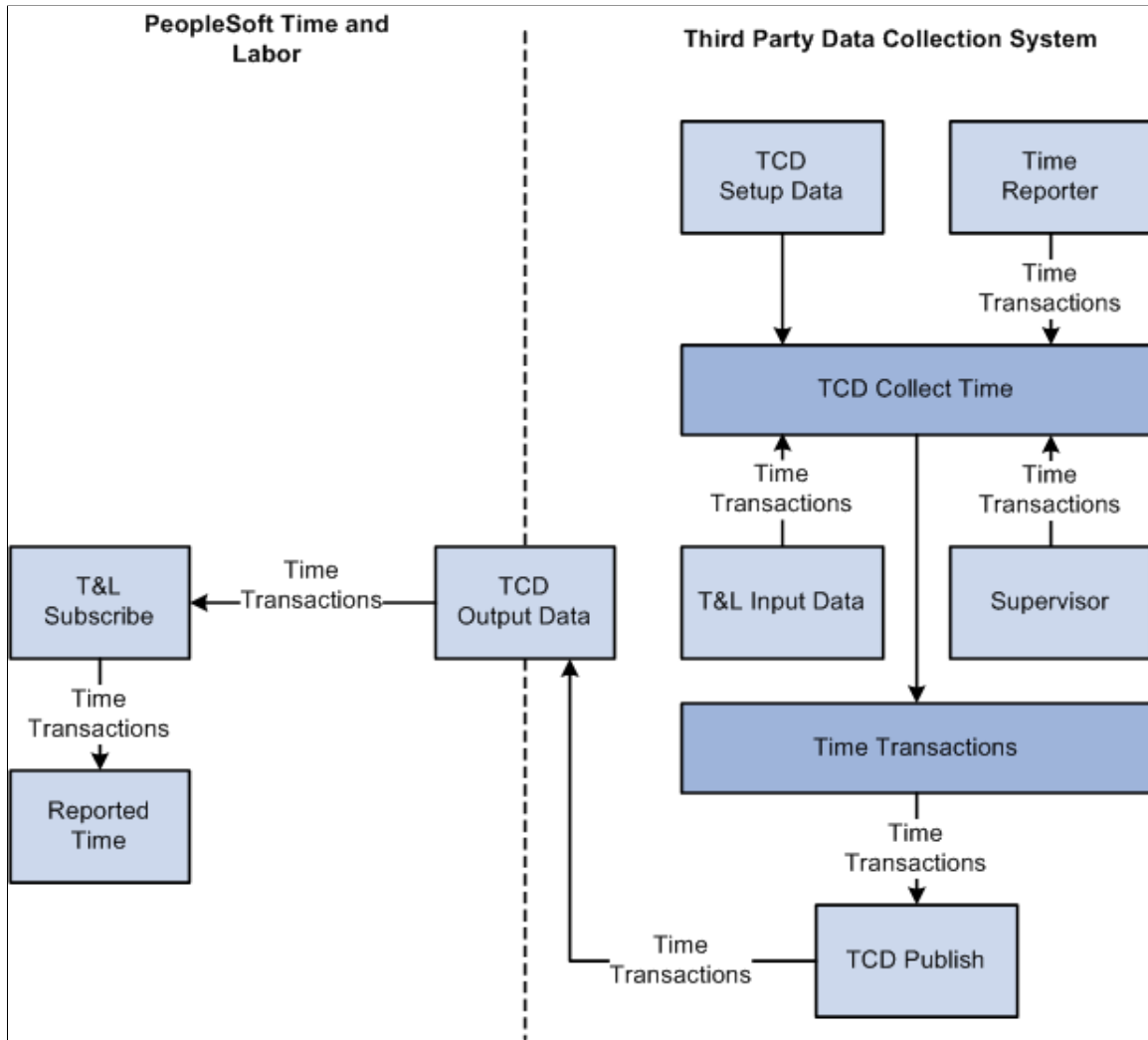

## Viewing and Resolving TCD Errors

This section discusses how to view and resolve TCD errors.

**Note:** Fixing TCD errors requires detailed knowledge of the interface data structure.

### Pages Used to View and Resolve TCD Errors

<i>Page Name</i>	<i>Definition Name</i>	<i>Usage</i>
<a href="#">Review TCD Errors Page</a>	TL_TCD_EIP_ERR	View TCD error messages.
<a href="#">TCD Elapsed Time Errors Page</a>	TL_ELAPSED_ERROR	View and fix elapsed time errors.

<b>Page Name</b>	<b>Definition Name</b>	<b>Usage</b>
<a href="#">Elapsed Time Attributes Page</a>	TL_ELAPSED_ERROR1	View or enter additional information for elapsed time sent to Time and Labor from your TCD.
<a href="#">TCD Punched Time Errors Page</a>	TL_PUNCH_ERROR	View and fix punched time errors.
<a href="#">Punched Time Error Attributes Page</a>	TL_PUNCH_ERROR1	View or enter additional information for punched time sent to Time and Labor from your TCD.

## Review TCD Errors Page

Use the Review TCD Errors page (TL\_TCD\_EIP\_ERR) to view TCD error messages.

Navigation:

**Set Up HCM > System Administration > Utilities > Analyze Time and Labor > Review TCD Errors > Review TCD Errors**

This example illustrates the fields and controls on the Review TCD Errors page. You can find definitions for the fields and controls later on this page.

Review TCD Errors				
TCD Message Type <input type="text"/>				
Time Collection Device Interface Errors			Personalize   Find   View All	
Review	Subscription Date Time	TCD Message Type	Publishing Node	Publication Id
	07/13/2000 2:11PM	Elapsed	H800R7QA	1
	07/13/2000 2:37PM	Punched	H800R7QA	2

<b>Field or Control</b>	<b>Description</b>
<b>TCD Error Detail</b> button	Click the <b>TCD Error Detail</b> button to view TCD punch or elapsed time, and to view punch or elapsed time error attributes.
<b>Subscription Date Time</b>	Displays when the punch or time was received by Time and Labor.
<b>Message Type</b>	The system displays if the message is for punched or elapsed time.
<b>Publishing Node</b>	Displays the message node/comm serv (TCD) that the information was sent from.  This is either the node you established during TCD setup or the system node used with PeopleSoft Mobile Time and Expense.

<b>Field or Control</b>	<b>Description</b>
<b>Publication ID</b>	Displays a unique ID for the error message. A message may contain more than one punch or time entry.

## TCD Elapsed Time Errors Page

Use the TCD Elapsed Time Errors page (TL\_ELAPSED\_ERROR) to view and fix elapsed time errors.

Navigation:

**Click the Review icon on the Review TCD Errors page for the Elapsed time row that you want to view.**

This example illustrates the fields and controls on the TCD Elapsed Time Errors page. You can find definitions for the fields and controls later on this page.

The screenshot shows the 'Elapsed Time Errors' window with the following sections:

- Subscription Date Time:** 07/13/2000 2:11PM
- Resubmit to Reported Time:**
- Elapsed Transaction:**
  - \*Empl ID: [text box]
  - Empl Record: [0]
  - Badge ID: [text box]
  - Date Under Report: [02/07/2000]
  - \*Add/Del Ind: [A]
  - Delete Date: [calendar icon]
  - Sequence number: [0]
  - TRC: [REG]
  - Quantity: [8.000000]
- Transaction Errors:**
  - Field Name: EMPLID
  - Message Text: Field is required. (15,8)
- Transaction Task Elements:**
  - \*Task Element Code: [text box]
  - Task Element Value: [text box]

Buttons: OK, Cancel, Apply

Navigation: TCD Elapsed Time Errors | Elapsed Time Attributes

<b>Field or Control</b>	<b>Description</b>
<b>Subscription Date Time</b>	Displays when the message was received by Time and Labor.
<b>Resubmit to Reported Time</b>	Select to submit the corrected time to Time and Labor. When you click <b>OK</b> or <b>Apply</b> , the system submits all resolved transactions within the message to the Reported Time tables.

## Elapsed Transaction

<b>Field or Control</b>	<b>Description</b>
<b>EmplID</b> (employee ID), <b>Empl Rcd Nbr</b> (employee record number), and <b>Badge ID</b>	Displays the time reporter's ID. You can change this value if this is the field in error for the reported time. Your TCD must send either a badge ID or a combination of the employee ID and employee record number.
<b>Add/Del Ind.</b> (Add/Delete Indicator)	Indicates if the system should add or delete the reported time.  If the time should be deleted, the system deletes all time for the entire day. You can change or enter this value if it is the field in error.
<b>Delete Date</b>	Displays the delete date for this message. Required if the value for <b>Add/Delete Indicator</b> is <i>Delete</i> . You can change or enter this value if it is the field in error.
<b>Sequence Number</b>	Displays a unique identifier for the time being reported.
<b>Date Under Report</b>	This element is always required.
<b>TRC</b>	You may need to convert numeric code to character code depending on your TCD requirements.
<b>Quantity</b>	Displays the quantity for the TRC for the time being reported. This field can represent hours, amount, or units.

## Transaction Errors

<b>Field or Control</b>	<b>Description</b>
<b>Field Name</b>	Displays the name of the field causing the error.
<b>Task Element Code</b>	Displayed for informational purposes in case the task element code is causing the error.

## Transaction Task Elements

<i>Field or Control</i>	<i>Description</i>
<b>Task Element Code</b> and <b>Task Element Value</b>	Displays, or you can select or enter, the task element code and value to send to the Reported Time tables for the time being reported.
<b>OK</b>	Click to save your changes and return to the TCD Error Queue page. If <b>Resubmit to Reported Time</b> is selected, the system also submits the time to the Reported Time tables.
<b>Apply</b>	Click to save your changes and remain on the current page. If <b>Resubmit to Reported Time</b> is selected, the system also submits the time to the Reported Time tables.

## Elapsed Time Attributes Page

Use the Elapsed Time Attributes page (TL\_ELAPSED\_ERROR1) to view or enter additional information for elapsed time sent to Time and Labor from your TCD.

Navigation:

From the TCD Elapsed Time Errors page, select the **Review** icon for the Elapsed Time row that you want to view, then select the Elapsed Time Attributes tab.

This example illustrates the fields and controls on the Elapsed Time Attributes page. You can find definitions for the fields and controls later on this page.

You can enter a new value for any field on this page except the **Override Date Time** field.

<b>Field or Control</b>	<b>Description</b>
<b>Currency Code</b>	The system displays, or you can enter, the currency code when the quantity for the time equals money.
<b>Comp Rate Code</b>	The system displays, or you can enter, a comp rate code for the time being reported. The code is used to calculate the time reporter's pay.
<b>Billable Indicator</b>	If populated, the system uses the <b>Billable Indicator</b> field in conjunction with costs that it sends to Project Costing.
<b>Comments</b>	The system displays, or you can enter, a comment for this punch. The comment will appear on the Weekly or Punch Time Entry pages if this field is selected on the associated Time Reporting Template for the time reporter.

## TCD Punched Time Errors Page

Use the TCD Punched Time Errors page (TL\_PUNCH\_ERROR) to view and fix punched time errors.

Navigation:

**Set Up HCM > System Administration > Utilities > Analyze Time and Labor > Review TCD Errors**

Click the **Review** icon in the Punched time row that you want to view.

This example illustrates the fields and controls on the TCD Punched Time Errors page. You can find definitions for the fields and controls later on this page.

<i>Field or Control</i>	<i>Description</i>
<b>Subscription Date Time</b>	The system displays the subscription date and time the message was received by Time and Labor.
<b>Resubmit to Reported Time</b>	Select to submit the corrected time to Time and Labor. When you click <b>OK</b> or <b>Apply</b> , the system submits all resolved transactions within the message to the Reported Time tables.
<b>Empl ID</b> (employee ID), <b>Empl Rcd Nbr</b> (employee record number), and <b>Badge ID</b>	Displays the time reporter ID for this punch. You can change these values if this is the field in error for the punch.  Your TCD must send either an employee ID and an employee record number, or badge ID.

<i>Field or Control</i>	<i>Description</i>
<b>Punch Type</b>	Displays the value for the punch type. Examples are 1 for IN type punch, 2 for OUT type punch, 3 for Meal punch, 4 for Break, and 5 for Transfer.
<b>Add/Delete Indicator</b>	Indicates if the recorded time should be added or deleted. If the time should be deleted, the system deletes all punches for the entire day. You can change or enter this value if it is the field in error.
<b>Punch Date and Time</b>	This field is always required.
<b>Delete Date</b>	Displays the delete date for this message. Required if the value for <b>Add/Delete Indicator</b> is <i>Delete</i> . You can change or enter this value if it is the field in error.

### Transaction Errors

<i>Field or Control</i>	<i>Description</i>
<b>Field Name</b>	Displays the name of the field causing the error for the time.

### Transaction Task Elements

<i>Field or Control</i>	<i>Description</i>
<b>Task Element Code</b> and <b>Task Element Value</b>	Displays, or you can select or enter, the task element code and value to send to the Reported Time tables for the time being reported.
<b>OK</b>	Click to save your changes and return to the TCD Error Queue page. If <b>Resubmit to Reported Time</b> is selected, the system also submits the time to the Reported Time tables.
<b>Apply</b>	Click to save your changes and remain on the current page. If <b>Resubmit to Reported Time</b> is selected, the system also submits the time to the Reported Time tables.

## Punched Time Error Attributes Page

Use the Punched Time Error Attributes page (TL\_PUNCH\_ERROR1) to view or enter additional information for punched time sent to Time and Labor from your TCD.

Navigation:



From the TCD Punched Time Errors page, select the Punched Time Error Attributes tab.

This example illustrates the fields and controls on the Punched Time Error Attributes page. You can find definitions for the fields and controls later on this page.

The screenshot shows a web application window titled "Punched Time Errors". At the top right, there are links for "New Window", "Help", and "Personalize Page". Below this, there are two tabs: "TCD Punched Time Errors" and "Punched Time Error Attributes", with the latter being selected. The main content area is titled "Punch Transaction" and includes a "Subscription Date Time" of "07/13/2000 2:37PM" and a checkbox for "Resubmit to Reported Time". Below this, there are several input fields: "TCD ID" (KUTCD1), "Time Zone" (PST), "Task Profile ID" (KUTSKPRF1A), "TCD Supervisor ID" (SUPER1), "Task Template" (empty), "User ID" (PS), "Country" (USA), "Override Reason Code" (empty), "State" (CA), "Action DateTime" (12/31/98 4:00:00PM), and "Locality" (PLEASANTON). A "Comments" text area is at the bottom. At the bottom of the window, there are "OK", "Cancel", and "Apply" buttons, and a breadcrumb trail "TCD Punched Time Errors | Punched Time Error Attributes".

You can enter a new value for any field on this page except the **Action Date Time** field.

<b>Field or Control</b>	<b>Description</b>
<b>Comments</b>	The system displays, or you can enter, a comment for this punch. The comment appears on the Timesheet page if this field is selected on the associated Time Reporting template for the time reporter.



# Using Approvals and Delegations with Time and Labor

---

## Understanding the Approval Process in Time and Labor

Depending on your requirements, you can configure time approvals for the following options:

- Reported time.
- Payable time.
- Both reported and payable time.
- Overtime Requests

You can also set up email notifications for particular events. For managers, these include reported time needing approval, payable time needing approval, exceptions that have been generated, or a scheduled event that has been modified. For employees, email notifications include reported time which has been approved, payable time which has been approved, reported time which has been denied, or reported time which has been modified.

---

**Note:** Oracle PeopleSoft delivers Notification Composer Framework to manage the setup and administration of all notifications in one central location.

Once you have adopted the Notification Composer feature, you must use it to create new notifications and manage your existing notifications.

Notifications delivered with HCM Image 47 or later must use Notification Composer.

For more information about Notification Composer Framework, see “Understanding Notification Composer” (Enterprise Components).

---

Many daily tasks are part of a larger process that involves several steps and people working together. The term workflow refers to this process, which could encompass, for example, the approval of a time-off request. To facilitate this type of multiuser process, PeopleSoft can automatically trigger workflow notifications to inform the next approver in the process of work waiting.

## Approval Framework and Time and Labor

The Approval Framework is the engine that provides capabilities for creating, running, and managing the approval processes. The engine uses a series of database objects combined with application component configuration settings to determine how to process approvals using workflow.

The Approval Framework is a common component that is shared across multiple PeopleSoft applications both within HCM and other application families. Due to the widespread use of this engine, you'll find documentation pertaining to it in various locations:

- *PeopleTools: Workflow Technology* describes the Approval Framework and application setup in full detail.

It is the primary source of information for approval workflow.

- This section expands on the PeopleTools section, describing the setup steps and details for the Approval Framework that are specific to the HCM application line.
- Application-specific HCM PeopleBooks expand on all of the above texts by providing approval workflow details that relate to specific business processes.

The following transactions in Time and Labor can require approval:

- When an employee reports time.
- When a manager or administrator reports time on behalf of the employee.
- Time Administration generates payable time.
- When an employee submits an overtime request.

## Approval Foundation Elements

This section discusses the several foundation elements of the Approval Framework, their definition, and how they are used for Time and Labor approvals and delegations. The following elements are discussed here:

- Process ID
- Header record
- Definition ID
- User list
- Approval events and actions

### Process IDs

A process ID is a unique approval process identifier for the approval transaction. Process IDs are registered in the Approval Framework transaction registry using the Register Transaction page. The process ID is passed to the Approval Framework when the Time and Labor application invokes the Application Framework application classes. Time and Labor provides the following process IDs:

- TLReportedTime
- TLPayableTime
- TLOvertimeRequest

### Header Record

After an approval process is defined, validated, and made active, the system can process a transaction for approval. Each PeopleSoft application typically has a top-level database record that distinguishes one transaction from the next. These top-level records are called header records. When a transaction

is submitted for approval, the Approval Framework combines the approval process definition with the header record instance and line records, if line level approval is configured, to create a unique approval process instance. Time and Labor uses the following records as header records for approvals:

- TL\_RPTD\_TIME for reported time approvals.
- TL\_PAYABLE\_TIME for payable time approvals.
- TL\_OT\_DATA for overtime request approvals

## Definition ID

Each approval process ID can have one or more definition IDs for an approval transaction. The definition ID, with the other elements on the Setup Process Definitions page, enables the Approval Framework to determine which approval process ID to initiate, and determines the stage, path, and steps the approval process uses.

Time and Labor delivers the following definition IDs:

- TLByDeptManager
- TLByPosnDeptMgr
- TLByPosnSupervisor
- TLByPosMgmt
- TLBySupervisorID
- TLGroupSingleStageALL
- TLGroupMultiStageSOME
- TLGroupMultiStageALL

---

**Note:** The TLGroupMultiStageALL Definition ID is not provided for the TLOvertimeRequest Process ID

---



---

**Note:** All delivered Time and Labor definition IDs use the TL Approval Administrator in the Admin Role, which is the role used by workflow to route the transaction to all users filling that role in case of an error during approval processing. The error conditions are no approvers or not enough approvers.

---

## User List

A user list is a collection of users (PeopleSoft Operator IDs) expressed as the result of an SQL statement, PeopleSoft role, or PeopleSoft Application Class. The system routes approval transactions to these users, based on the step level definition created on the Setup Process Definitions page. Time and Labor user lists are based on either the delivered user lists for HCM or the Time and Labor group.

The user lists based on the delivered user lists for HCM are:

- TLAdhocGroup
- TLByDeptManager

- TLByGroup1
- TLByGroup2
- TLByPosMgmt
- TLByPosnDeptMgr
- TLByPosnSupervisor
- TLBySupervisor ID

You can use Time and Labor groups for approvals, whether you are using department security or Time and Labor group security, on the Static Group page (TL\_GROUP\_S1) or the Dynamic Group page (TL\_GROUP\_D1).

## Approval Events and Actions

The first step in the approval process is to identify the first person to approve the transaction. This person is based on the Approval Process definition. If the system identifies this person, the system sends a notification indicating that there is a reported time, payable time, or overtime waiting for approval. The approver has the option to:

- Approve the time request. The system sends a notification to the next person in the approval process, if one is indicated.
- Deny the time request. The system terminates the approval process. The originator of the time request receives a notification indicating that the time request has been denied.
- Push back the time request. The originator of the time request receives a notification indicating that the time request needs their attention.

---

**Note:** TL\_UTILITY app package has two classes one under UserUtilities and the other for Web clock data. The package are called GetApproversByTLSecurity and GetApproversByDeptSecurity. All Time and Labor delivered approval definitions contain one step. The push back always goes back to the originator in Time and Labor.

---

## Approval Definition and Approval Flow

The routing path of an approval request is be based on the approval stages, paths, and steps. These elements make up the Time and Labor process definitions, which are used for Time and Labor approvals. The process definition dictates:

1. How the approval request proceeds from approver to approver.
2. How many approvers must approve a request before it is routed to the next approver.
3. If an approval request carried out in a parallel or sequential manner.

The following table describes the requirements and differences between the Time and Labor approvals definitions:

<b>Definition ID</b>	<b>Approval Routing</b>	<b>Approver User List</b>	<b>Final Approval Status</b>
TLByDeptManager	One stage, one path, and one step.	TLByDeptManager (assigned at step 1)	Approval by the specified manager required before the status of the request is Approved.
TLByPosnDeptMgr	One stage, one path, and one step.	TLByPosnDeptMgr (assigned at step 1)	Approval by the specified manager required before the status of the request is Approved.
TLByPosnSupervisor	One stage, one path, and one step.	TLByPosnSupervisor (assigned at step 1)	Approval by the specified supervisor required before the status of the request is Approved.
TLByPosMgmt	One stage, one path, and one step.	TLByPosMgmt (assigned at step 1)	Approval by PosMgmt required before the status of the request is Approved.
TLBySupervisorID	One stage, one path, and one step.	TLBySupervisorID (assigned at step 1)	Approval by the specified supervisor required before the status of the request is Approved.
TLGroupSingleStageALL	One stage, with two parallel paths that have one step in each path.	TLUserList1 (assigned at path 1/ step 1)  and  TLUserList2 (assigned at path 2/ step 1)	All approvers on path 1/ step 1 and all approvers on path 2/ step 1 must approve the request, before the status of the request is Approved.  <hr/> <b>Note:</b> The approvers on path 2/ step 1 can approve the request at the same time as the approvers on path 1/ step 1. <hr/>

<b>Definition ID</b>	<b>Approval Routing</b>	<b>Approver User List</b>	<b>Final Approval Status</b>
TLGroupMultiStageSOME	Two sequential stages, each with one path and one step.	TLUserList1 (assigned at stage 1/ path 1/ step 1)  and  TLUserList2 (assigned at stage 2/ path 1/ step 1)	Some approvers on stage 1/ path 1/ step 1 must approve the request, and then some approvers on stage 2/ path 1/ step 1 must approve the request, before the status of the request is Approved.  <hr/> <b>Note:</b> The approvers on stage 2/ path 1/ step 1 cannot approve the request before the approvers on stage 1/ path 1/ step 1 approve the request. <hr/>
TLGroupMultiStageALL	Two sequential stages, each with one path and one step`.	TLUserList1 (assigned at stage 1/ path 1/ step 1)  and  TLUserList2 (assigned at stage 2/ path 1/ step 1)	All approvers on stage 1/ path 1/ step 1 and all approvers on stage 2/ path 1/ step 1 must approve the request, before the status of the request is Approved.  <hr/> <b>Note:</b> All of the approvers on stage 1/ path 1/ step 1 must approve the request before any of the approvers on stage 2/ path 1/ step 1 can approve the request. <hr/>

See “Understanding Approvals” (Application Fundamentals).

### Configuring Approval Transactions

PeopleSoft delivers the following events and email notification templates for configuring approval transactions for time and Labor:

<b>Event</b>	<b>Template Name</b>	<b>Description</b>
On Final Approval	HC_TL_EE_REP_APPROVED  HC_TL_EE_PAY_APPROVED  HC_TL_EE_OT_APPROVED	Reported time is approved, requestor notified.  Payable time is approved, requestor notified.  Overtime request is approved, requestor notified.



<b>Event</b>	<b>Template Name</b>	<b>Description</b>
On Final Denial	HC_TL_EE_REP_DENIED HC_TL_EE_PAY_DENIED HC_TL_EE_OT_DENIED	Reported time is denied, requestor notified.  Payable time is denied, requestor notified.  Overtime request is denied, requestor notified.
Push Back	HC_TL_MGR_REP_PUSH_BACK HC_TL_MGR_PAY_PUSH_BACK HC_TL_MGR_OT_PUSH_BACK	Reported time is pushed back, approver notified.  Payable time is pushed back, approver notified.  Overtime request is pushed back, requestor notified.
Route for Approval	HC_TL_MGR_REP_AWAITING HC_TL_MGR_PAY_AWAITING HC_TL_MGR_OT_AWAITING	Reported time is awaiting approval, approver notified.  Payable time is awaiting approval, approver notified.  Overtime request is awaiting approval, approver notified.
Route for Review	HC_TL_MGR_REP_REVIEW HC_TL_MGR_PAY_REVIEW HC_TL_MGR_OT_REVIEW	Reported time is awaiting review, approver notified.  Payable time is awaiting review, approver notified.  Overtime request is awaiting review, approver notified.
On Error	HC_TL_ADMIN_ERROR	An error occurred while processing this request, admin is notified.

**Note:** It is noted that the approval process will look at the Position manager as long as Employee job data is associated with a Position number and approvals will be routed to Department manager when there is no Position number mentioned on Job data page. So if the employee does not have Reports To position number mentioned on Job data page, then the system will look at Position data to find the Report To.  
See

---

**Note:** These templates are delivered. If modifications are needed refer to the Applications Fundamentals Documentation. The events delivered must not be modified to ensure the correct functioning of the Time and Labor Self Service applications. You might be able to modify this set up if you have a thorough understanding of the Approval Framework, PeopleCode and Time and Labor Self-service.

---

## Related Links

“Configuring Approval Transactions” (Application Fundamentals)

## Prerequisites

These steps are prerequisites to setting up and using approvals and delegations in Time and Labor.

### Step 1

Define your URL for the URL Identifier TL\_APPROVALS on the URL Maintenance page (**PeopleTools > Utilities > Administration > URLs**).

See *PeopleTools 8.52: System and Server Administration PeopleBook, Using PeopleTools Utilities*

### Step 2

Set the workflow defaults on the Worklist System Defaults page (**PeopleTools > Workflow > Defaults & Messages > Set Workflow Defaults**).

---

**Note:** You must recycle and clear the cache on the application server for your changes to take effect.

---

See *PeopleTools 8.52: Workflow Technology PeopleBook, Administering PeopleSoft Workflow*

### Step 3

Specify the user profile attributes for each user in the User Profiles component (**PeopleTools > Security > User Profiles > User Profiles**). Including the following:

- Defining an email address for each approver on the User Profiles - General page.
- Select the Routing Preferences on the Workflow page.
- Establish the user profiles taking the following roles into consideration:
  - AWE Administrator  
This role provides access to the Approval Framework configuration and administration components.
  - AdhocUser\_Role  
This role provides access to the ROLE\_MANAGER for an ad hoc approver or reviewer.
  - EOAW\_ADMINISTRATOR  
This role is the default role for Enterprise Components Approval Framework.
  - TL Approval Administrator

This role provides access to the CAPTURE\_TIME\_AND\_LABOR, EOAW\_APPROVAL\_WORKFLOW, and ROLE\_MANAGER roles to set up and manage Time and Labor approvals.

- Worklist Administrator

This role receives worklist processes that have timed-out.

- HCM Delegation Admin

This role accesses all of the Delegation Administrator's delegation components.

See the product documentation for *PeopleTools: Security Administration*.

## Step 4

Define the SMTP settings for the application server and the process server.

See the product documentation for *PeopleTools: System and Server Administration*.

---

## Approving Reported Time

This section provides an overview of approving reported time.

### Pages Used to Approve Reported Time

<b>Page Name</b>	<b>Definition Name</b>	<b>Usage</b>
<u>Approve Reported Time - Timesheet Summary Page</u>	TL_MSS_TIMESHEET	View a group of employees or an individual employee's reported time needing approval.
<u>Timesheet Page</u>	TL_RPTD_ELP TL_RPTD_PCH	Approve or deny an employee's reported time. The format of the timesheet depends on whether the employee is an elapsed or punch time reporter.
<u>Comments Page</u>	TL_TR_COMMENT	Add comments to timesheet information.
<u>Payable Time Detail Page</u>	TL_MNG_PAY_DET_VW	Review details of payable time after online rules are run.

### Understanding Approval of Reported Time

You have the ability to require approval of reported time, after it has been submitted, by selecting the Approve Reported Time option on the Workgroup or TRC definition. If specified for a workgroup,

all reported time for employees in that workgroup needs approval. If specified at the TRC level, only reported time associated with the TRC needs approval.

Reported time that requires approval, regardless of the source, must be approved before it will be selected and processed by Time Administration to generate payable time. Time that has been submitted, either through interfaces or online, is available for approval.

When approved, the reported time status is *Approved*, and it is ready to be selected by the Time Administration process for payable time generation.

If reported time is denied, the reported time is given a status of *Denied* and will not be processed by Time Administration. The time remains in a *Denied* status until it is resubmitted.

---

**Important!** Approvers cannot directly approve time with a status of *Denied*. When you select a row with denied time, the only available option is to submit the time for approval once more. The status of the time changes from *Denied* to *Needs Approval* until the approval process is completed.

---

## Approvals at the Approve Reported Time Summary Level

Because approvals are based on stages, paths, steps, and routing approval transactions through the approval path, the manager only sees reported time that needs approval where the approval transaction is pending within the Approval Framework and the requestor ID within the Approval Framework equals the manager's operator ID.

## Time Approvals by Manager

The manager can do the time approval using Time and Labor Dashboard now. The Time and Labor Dashboard is a one stop shop for performing all the time related transactions by a manager.

## Approve Reported Time - Timesheet Summary Page

Use the Approve Reported Time - Timesheet Summary page (TL\_MSS\_TIMESHEET) to view a group of employees or an individual employee's reported time needing approval. For more details, refer [Viewing the Time and Labour Dashboard pagelets](#)

Navigation:

**Manager Self Service > Time Management > Approve Time and Exceptions > Reported Time > Approve Reported Time**

This example illustrates the fields and controls on the Approve Reported Time – Timesheet Summary page. You can find definitions for the fields and controls later on this page.

The screenshot displays the 'Approve Reported Time Timesheet Summary' interface. At the top, there's a title bar and an 'Employee Selection' section. Below that is a 'Change View' section with a 'View By' dropdown set to 'Week', a date field showing '06/13/2016', and checkboxes for 'Include Absence' and 'Show Schedule Information'. The main content area shows a table titled 'Employees For John Patterson, Time Needing Approval From 06/13/2016 - 06/19/2016'. The table has 17 columns: Select, Last Name, First Name, Employee ID, Empl Record, Job Title, Hours to be Approved, Reported Hours, Scheduled Hours, Exception, Absence to be Approved, Hours Approved or Submitted, Denied Hours, Hours Not Worked, Premium Time, Regular Time, Leave, and Holiday. Two rows are visible: one for David Stanfield (Billing Specialist) and one for Janice Worthington (Financial Analyst). Below the table is an 'Approval' section with buttons for 'Select All', 'Deselect All', 'Approve', and 'Deny'. At the bottom left, there are links for 'Report Time', 'Approve Absence', 'Manager Self Service', and 'Time Management'.

For more details, see [Time and Labor Dashboard](#)

### Employee Selection Criteria

Enter selection criteria in the fields in this collapsible group box. You can select a group of employees or individual employees. The fields that are displayed in this group box are defined in Manager Search Options. If the Manager Search Options are cleared, the criteria that are displayed are derived from the Manager Search Defaults page in the Time and Labor Installation component.

See [Setting Up Manager Search Options](#).

<b>Field or Control</b>	<b>Description</b>
<b>Click for Instructions</b>	Click this link to view instructional text for using this page.

<b>Field or Control</b>	<b>Description</b>
<b>View By</b>	<p>This field determines how much reported time you see in the summary list. The page refreshes each time you select an option. The options are <i>Day</i>, <i>Week</i>, <i>All Time Before</i> and <i>All Time After</i>:</p> <ul style="list-style-type: none"> <li>• Select <i>Day</i> to display any reported time with a status of <i>Needs Approval</i> or <i>Denied</i> for the day specified.</li> <li>• Select <i>Week</i> (default) to display any reported time with a status of <i>Needs Approval</i> or <i>Denied</i> for the week specified. This field uses user preferences to display the order of days in the <b>Timesheet</b> grid.</li> <li>• Select <i>All Time Before</i> to display all reported time with a status of <i>Needs Approval</i> that exists prior to the date specified in the <i>Date</i> field. The <b>Previous</b> and <b>Next</b> links do not appear, as they are not relevant for this option.</li> <li>• Select <i>All Time After</i> to display all reported time with a status of <i>Needs Approval</i> that exists in the future from the date specified in the <i>Date</i> field. The <b>Previous</b> and <b>Next</b> links do not display as they are not relevant for this option.</li> </ul> <hr/> <p><b>Note:</b> If the value in the <b>View By</b> field is <i>All Time Before</i> or <i>All Time After</i>, the system displays the first row needing approval because the manager could have denied time in the past.</p> <hr/>
Date	<p>The default is today's date when you first enter this page. If the <b>View By</b> option is <i>Week</i>, the system checks the value in the <b>Start Day of Week</b> field on the Time Reporting Preferences page and displays the week accordingly.</p> <p>If the <b>View By</b> option is <i>All Time Before</i>, the system returns a list of employees who have time needing approval prior to that date. If the <b>View By</b> option is <i>All Time After</i>, the system returns a list of employees who have time needing approval after that date.</p>
Include Absences	<p>Select this check box to include employees who have one or more reported absences needing approval within the specified time period.</p>
Refresh	<p>Click this button to refresh the page after changing date-related criteria or selecting or clearing the <b>Include Absences</b> check box.</p>

---

**Note:** The approval status monitor does not display on the Timesheet Summary page, the Approve Reported Time Summary page or the Approve Payable Time Summary page.

---

## Employee Grid

<b>Field or Control</b>	<b>Description</b>
Title Bar	This group box title displays the manager's name and the date range being viewed.
Select	<p>Select the check box next to the employee name to approve or deny reported time for the timeframe you selected.</p> <p>The <b>Select</b> check box is grayed out if the employee has only a reported absence to be approved, and no reported work time.</p> <hr/> <p><b>Note:</b> Reported absences cannot be approved on the Approve Reported Time Summary page. You must access the employee's Timesheet to approve an absence.</p> <hr/>
Name	Click the time reporter's name link to display the Timesheet grid.
Exception	Displays an icon indicating that exceptions exist.
Absence to be Approved	Displays an icon indicating that absences requiring approval exist.

---

**Note:** All columns are displayed when viewing reported time using the by *Day* or *Week View By* options. If the *All Time Before* or *All Time After* options are selected, fewer columns are displayed. All columns can be sorted, ascending or descending, by clicking the column headers, with the exception of the TRC columns.

---

## Timesheet Page

Use the Timesheet page (TL\_RPTD\_ELP ) to approve or deny an employee's reported time.

The format of the timesheet depends on whether the employee is an elapsed or punch time reporter.

Navigation:

**Click the employee name link on the Approve Reported Time page.**

This example illustrates the fields and controls on the Timesheet page – Punch example. You can find definitions for the fields and controls later on this page.

**Timesheet**  
 David Stanfield Employee ID KU0174  
 Emp Record 0  
 Actions - Select Another Timesheet  
 \*View By Week Previous Week Next Week  
 \*Date 09/19/2016  
 Scheduled Hours 40.00 Reported Hours 40.00 Print Timesheet Elapsed Timesheet  
 Earliest Change Date is too far back to run Rules in viewed period. Limit is 7 months.  
 From 09/19/2016 to 09/25/2016

Add Comments	Day	Date	Reported Status	In	1st Break	In	Lunch	In	2nd Break	In	Transfer	Out	Punch Total	Time Reporting Code	Quantity	Sched Hrs	Time Zone	Date
	Mon	9/19	Submitted	8:00:00AM			12:00:00PM	1:00:00PM	3:00:00PM	3:15:00PM		5:00:00PM	8:00	KUREG - Regular		8:00	PST	9/19
	Tue	9/20	Submitted	8:00:00AM			12:00:00PM	1:00:00PM	3:00:00PM	3:15:00PM		5:00:00PM	8:00	KUREG - Regular		8:00	PST	9/20
	Wed	9/21	Submitted	8:00:00AM			12:00:00PM	1:00:00PM	3:00:00PM	3:15:00PM		5:00:00PM	8:00	KUREG - Regular		8:00	PST	9/21
	Thu	9/22	Submitted	8:00:00AM			12:00:00PM	1:00:00PM	3:00:00PM	3:15:00PM		5:00:00PM	8:00	KUREG - Regular		8:00	PST	9/22
	Fri	9/23	Submitted	8:00:00AM			12:00:00PM	1:00:00PM	3:00:00PM	3:15:00PM		5:00:00PM	8:00	KUREG - Regular		8:00	PST	9/23
	Sat	9/24	New										0:00	PST		0:00	PST	9/24
	Sun	9/25	New										0:00	PST		0:00	PST	9/25

Save for Later Submit Clear

Summary Absence Exceptions Payable Time Attendance

**Reported Time Summary**

Category	Total	Mon 9/19	Tue 9/20	Wed 9/21	Thu 9/22	Fri 9/23	Sat 9/24	Sun 9/25
Regular Time	40.00	8.00	8.00	8.00	8.00	8.00		
Total Reported Hours	40.00	8.00	8.00	8.00	8.00	8.00		
Total Scheduled Hours	40.00	8.00	8.00	8.00	8.00	8.00		
Schedule Deviation								
Time with no Category								

Return to Select Employee  
 Request Absence  
 Approve Absence  
 Manager Self Service  
 Time Management

The Timesheet page enables the manager to work with an employee's reported time in more detail. You can adjust entries, select some or all incidences of time needing approval and click either the **Approve** or **Deny** buttons.

The placement of the Comments icon on the Timesheet page depends on the type of Timesheet that is displayed, either punch or elapsed. The comment icon is in the first column of the time grid on the punch timesheet. Click it to access the Comments page. For elapsed timesheets, the comment icon is included in the Reported Time Status grid that you can access using the link below the **Apply Rules** button. The Reported Time Status link and grid are not displayed on punch timesheets.

The manager can navigate to the previous or next employee in the list that was generated on the Approve Reported Time page by clicking the **Previous Employee** or **Next Employee** links.

Click the **Submit** button to validate reported time and set the status to Needs Approval. Time that has no errors after being validated is set to *Needs Approval*. If the user is reporting more time or modifying time for an existing row that has already been processed, and has a status of Approved, then the whole day (or row) is again set to a status of *Needs Approval*.

After clicking the **Approve** or **Deny** buttons, the manager is transferred to a confirmation page. To return to the Timesheet page click the OK or CANCEL button.

Reported Time that does not need approval is set to a status of *Submitted*.

If an Absence Event cannot be entered or approved in Timesheet, use the **Request Absence** or **Approve Absence Go To** links. You cannot return to the Timesheet after you have navigated beyond the Approve Absence Request or Request Absence pages.

## Related Links

[Understanding Payable Time](#)



## Comments Page

Use the Comments page (TL\_TR\_COMMENT) to add comments to timesheet information.

Navigation:

Click the Comments icon on the timesheet.

This example illustrates the fields and controls on the Comments page. You can find definitions for the fields and controls later on this page.

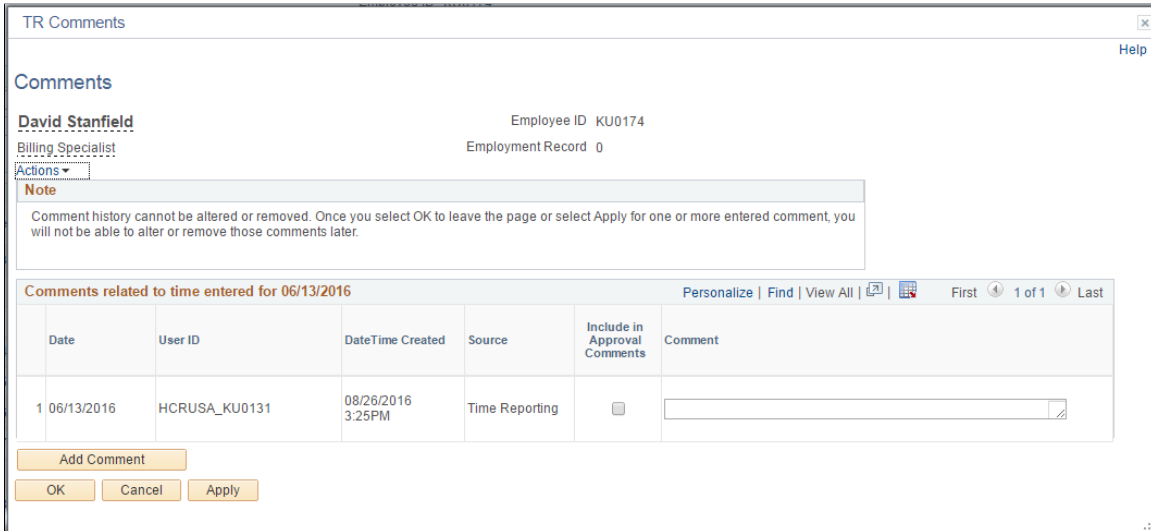

<b>Field or Control</b>	<b>Description</b>
Include in Approval Comments	Select to add the comments to the Approval Framework for the approval instance.
Comment	Enter any comments regarding the time entered.

## Payable Time Detail Page

Use the Payable Time Detail page (TL\_MNG\_PAY\_DET\_VW) to review details of payable time after online rules are run.

Navigation:

Click the Apply Rules button on the Timesheet page.

This example illustrates the fields and controls on the Payable Time Detail page. You can find definitions for the fields and controls later on this page.

**Payable Time Detail**

**Osmar Mutukumari** Employee ID K0W202  
 Administrator-Network Services Employment Record 0

Start Date 09/24/2014  
 End Date 09/30/2014

**Payable Status Filter**

**Payable Time**

Date	Status	Reason Code	Time Reporting Code	Quantity	TRC Type	Estimated Gross
09/24/2014	Needs Approval		KUREG	8.00	Hours	\$138.46
09/25/2014	Needs Approval		KUREG	8.00	Hours	\$138.46
09/26/2014	Needs Approval		KUOVT	1.00	Hours	\$25.96
09/26/2014	Needs Approval		KUREG	8.00	Hours	\$138.46

Return to Select Employee  
 Pending Exceptions

See [Timesheet Page](#).

## Reviewing and Entering Absence Events

Click the **Absence Event - select to view** link on the Timesheet page.

This example illustrates the fields and controls on the Absence Events grid. You can find definitions for the fields and controls later on this page.

Reported Time Status | Summary | **Absence** | Exceptions | Payable Time

**Absence Events**

Select	*Start Date	End Date	Absence Name	Reason	Duration	Unit Type	Details	Status	Approval Monitor	Source	Cancel	Forecast	Edit
<input type="checkbox"/>	01/02/2007	01/02/2007	Sick	Flu	8.00	Hours	Details	Needs Approval	Approval Monitor	Manager Timesheet	<input type="checkbox"/>	Forecast	Edit
<input type="checkbox"/>	01/05/2007	01/05/2007	Vacation	Vacation	8.00	Hours	Details	Needs Approval	Approval Monitor	Manager Timesheet	<input type="checkbox"/>	Forecast	Edit

Add Absence Event

**Absence Entitlement Balances**

Entitlement Name	Balance as of 09/30/2014**	From	To	Accrual Period	User Key 1	User Key 2	User Key 3	User Key 4
Vacations Balance Hrs	89.99	Hours	01/01/2014	12/31/2014	Year to Date	GBI	K0WPE ABS1	K0WPG TL1
Sick Balance Hrs	40.00	Hours	01/01/2014	12/31/2014	Year to Date	GBI	K0WPE ABS1	K0WPG TL1

The Absence Events section is collapsed by default when you access the Timesheet page.

The Absence Events grid on the Timesheet page enables the manager to review, add, change, and approve absence events.

<b>Field or Control</b>	<b>Description</b>
<b>Edit</b>	<p>Click this button to edit, submit, cancel or forecast the absence request. The edit button is disabled when you are adding a new absence.</p> <hr/> <p><b>Note:</b> You can edit only one absence event at a time so as to avoid confusion with absence validation messages.</p> <hr/>
<b>Cancel</b>	<p>This check box is enabled only when editing an absence. The event will be cancelled when you click the <b>Save</b> or <b>Submit</b> buttons. Depending on the cancellation rule defined in the Country Take component, the absence could be deleted from the database or the status could be set to cancelled.</p>
Forecast	<p>When adding or editing an absence event, click this button to forecast the absence event information for this employee.</p> <hr/> <p><b>Note:</b> The Forecast button is enabled only if defined in the Country Take component for the absence that is being reported. The <b>Forecast</b> column is not displayed if no absence events in the grid are set up to enable forecasting.</p> <hr/>
Submit	<p>Click this button to submit the entries on the Timesheet page. After submitting, you can approve the entry.</p>

The Absence Entitlement Balances grid displays Absence Entitlement balances as of the last time the absence process was completed and finalized.

If the employee is enrolled in compensatory or leave plans, those balances are displayed in a separate grid.

See “Forecasting Absence Entitlement Balance During Absence Entry” (PeopleSoft Absence Management).

See “Defining Self Service Absence Rules by Country” (PeopleSoft Absence Management).

## Entering Absence Event Details

Click the **Details** link in the Absence Events grid to access this page.

This example illustrates the fields and controls on the Absence Request Details. You can find definitions for the fields and controls later on this page.

**Request Details**

**Osmar Mutukumari**  
Administrator-Network Services

---

**Instructions**  
View Request Status and Approval Details

---

**Details** ?

Start Date	01/02/2007
End Date	01/02/2007
Absence Name	Sick
Reason	Flu
Partial Days	None
Duration	8.00 Hours
Current Balance	40.00 Hours

---

**Additional Information**

Health Care Provider	PCP
Copayment	

---

**Request History** [Personalize](#) | [First](#)

Status	Name	Date	Comments
Submitted	Betty Locherty	09/30/2014	

This page is displayed automatically when you select an absence that requires additional information, regardless of whether the partial days options have been enabled.

### Details

<b>Field or Control</b>	<b>Description</b>
<b>Start Date</b>	Select the first day of the absence event. The field option defaults to the current date. If there is a break in the absence, enter each event separately. For example, if you are out sick for two days, return to work for three days, and are out sick again, enter two absence events. If the absence includes a weekend (say, Thursday to Monday), enter one absence event.
<b>End Date</b>	Select the last day of the absence event. If you leave this field empty and the <b>Calculate End Date</b> option on the Country Take (setup) page is selected, the system automatically determines the end date based on the begin date, duration, and partial days options.  See “Defining Self Service Absence Rules by Country” (PeopleSoft Absence Management).

<b>Field or Control</b>	<b>Description</b>
<b>Original Start Date</b>	<p>Select the original start date of the absence event. Enter a date if the absence has legal or payment implications based on the original start date of the absence.</p> <p>This field is visible when <b>Display Original Begin Date</b> is selected on the Absences page of the Country Take component.</p> <hr/> <p><b>Note:</b> Careful consideration is needed when enabling this field in self-service. Incorrect data entered in this field might lead to incorrect eligibility calculations and payment for one or more events.</p> <hr/> <p>See “Defining Self Service Absence Rules by Country” (PeopleSoft Absence Management).</p>
<b>Filter by Type</b>	<p>Select the absence type. The selection you make in this field will limit or filter the selections available in the <b>Absence Name</b> field.</p>
<b>Absence Name</b>	<p>Select the absence name from the available options. The options available depend on the selection in the <b>Filter by Type</b> field, the absence Takes that are enabled in the Country Take setup, and the elements for which the employee is eligible.</p> <hr/> <p><b>Note:</b> If you change the value in the <b>Absence Name</b> field on this page, all existing information regarding the event is reset. The system prompts you to continue before it resets the data.</p> <hr/>
<b>Reason</b>	<p>Select a reason from the available options. The reasons available depend on your selections in the previous fields. Absence reasons are linked to the Absence Name (Take) through the Absence Take Type.</p> <p>See “Defining Absence Types and Reasons” (PeopleSoft Absence Management).</p>

<b>Field or Control</b>	<b>Description</b>
<b>Partial Days</b>	<p>Specify which days of the absence event are partial days.</p> <p>If the <b>Calculate End Date or Duration</b> option is enabled on the Absence (setup) page, and the <b>Unit Type</b> is <i>Hours</i>, the system does consider any partial hours or half-day entries that are entered in this group box when it calculates the end date or duration.</p> <p>For example, an employee has a work schedule of 8 hours per day, Monday through Friday. The employee reports an absence from Monday, January 8, 2007 through Wednesday, January 10, 2007. Then employee takes a half day off on Monday and full days off for the rest of the absence.</p> <p>Example 1: The Country Take set up is defined as follows:</p> <ul style="list-style-type: none"> <li>• <b>Unit Type</b> = <i>Hours</i></li> <li>• <b>Allow Partial Days</b> = Selected</li> <li>• <b>Partial Days</b> = <i>Partial Hours</i></li> </ul> <p>With these settings, to correctly enter the absence data the employee should report:</p> <ul style="list-style-type: none"> <li>• <b>Start Date</b> = <i>January 8, 2007</i></li> <li>• <b>End Date</b> = <i>January 10, 2007</i></li> <li>• <b>Partial Days</b> = <i>Start Day Only</i></li> <li>• <b>Start Day Hours</b> = <i>4</i></li> </ul> <p>Example 2: The Country Take set up is defined as follows:</p> <ul style="list-style-type: none"> <li>• <b>Unit Type</b> = <i>Hours</i></li> <li>• <b>Allow Partial Days</b> = Selected</li> <li>• <b>Partial Days</b> = <i>Half Days</i></li> </ul> <p>With these settings, to correctly enter the absence data the employee should report:</p> <ul style="list-style-type: none"> <li>• <b>Start Date</b> = <i>January 8, 2007</i></li> <li>• <b>End Date</b> = <i>January 10, 2007</i></li> <li>• <b>Partial Days</b> = <i>Start Day Only</i></li> <li>• <b>Start Day is Half Day</b> = Selected</li> </ul>

<b>Field or Control</b>	<b>Description</b>
	<p><b>Warning!</b> If the absence unit type is defined in days in the Country Take setup, we do not recommend using partial days options.</p> <hr/> <p><b>Note:</b> Data that you enter in the following fields is used in the absence calculation process only if the data is referenced by your absence formulas.</p> <hr/> <p>The available options in the <b>Partial Days</b> field when the absence is calculated in days include:</p> <ul style="list-style-type: none"> <li>• <i>All Days</i></li> <li>• <i>End Day Only</i></li> <li>• <i>None</i></li> <li>• <i>Start Day Only</i></li> <li>• <i>Start and End Days</i></li> </ul> <p>Depending on the option that you select, up to two check boxes appear that allow you to specify which days of the absence event are half days. Select the check boxes that are appropriate for the absence event.</p>
<b>Duration</b>	<p>Enter Duration by days or hours. You do not have to enter Duration if the Calculate Duration button is enabled on the Absence (setup) page. The system calculates the duration of the absence in hours or days when you click the <b>Calculate End Date or Duration</b> button.</p> <p>The behavior of this field depends on the settings on the Absence (setup) page. The value is automatically calculated if the <b>Calculate End Date</b> option is selected.</p> <ul style="list-style-type: none"> <li>• If the absence is measured in days or hours, the system automatically calculates the duration when you enter the begin date and end date.</li> <li>• If you want to calculate the end date based on a duration, the system calculates the end date after you enter the begin date and duration and click the <b>Calculate End Date</b> button.</li> </ul>

<b>Field or Control</b>	<b>Description</b>
<b>Calculate End Date or Duration</b>	<p>Click this button to have the system calculate the end date of an absence event based on the entries in the <b>Start Date</b> and <b>Duration</b> fields, or to calculate the <b>Duration</b> based on entries in the <b>Start Date</b> and <b>End Date</b> fields.</p> <hr/> <p><b>Note:</b> When the <b>Calculate End Date</b> and <b>Calculate Duration</b> options are both selected on the Date Rules page of the Country Take component, one of these two options is entered in the <b>If both entered recalculate</b> field. This ensures that when an absence event is reported with values entered in both the <b>Duration</b> and <b>End Date</b> fields, only one of the fields is recalculated when the <b>Calculate End Date or Duration</b> button is clicked.</p> <hr/>

### Additional Information

The fields that are displayed in this group box depend on how your organization sets up self service for Absence Management during the implementation process.

### Comments

The **Requestor Comments** field enables the employee to enter free form text related to the absence request that becomes part of the record and is visible throughout the approval process. Comments display on the Absence Details page.

<b>Field or Control</b>	<b>Description</b>
<b>OK</b>	Click this button to have the system perform validations regarding required fields and issue error messages if information is missing. Also, if Partial Days options are used incorrectly, error messages are displayed indicating which data needs must be corrected before the Timesheet page is displayed.
<b>Cancel</b>	Click this button to discard any modifications that you made.

See “Request Absence Page” (PeopleSoft Absence Management).

## Forecasting Absence Events

The Forecast Results tab is displayed in the Absence Events grid after the absence event Forecast process is completed.



This example illustrates the fields and controls on the Absence Forecast Results tab. You can find definitions for the fields and controls later on this page.

Select	Start Date	End Date	Absence Name	Reason	Forecast Value	Forecast DateTime	Forecast Details
<input type="checkbox"/>	01/02/2007	01/02/2007	Sick	Flu			<a href="#">Forecast Details</a>
<input type="checkbox"/>	01/05/2007	01/05/2007	Vacation	Vacation			<a href="#">Forecast Details</a>

After the Forecast process is completed, a message is displayed beneath the **Absence Event** link to indicate the absence forecast status and time stamp. The **Forecast Results** tab displays the **Forecast Value** returned for each of the absence events. Click the **Forecast Details** link to review the list of returned values for each absence event.

Depending on the Country Take configuration, some absences may require forecasting to submit for approval. Depending on the **Forecast Value** returned, some absences may not be eligible to be submitted if they do not meet the forecasting eligibility criteria defined in the Country Take component.

See “Forecasting Absence Entitlement Balance During Absence Entry” (PeopleSoft Absence Management).

## Approving Absence Events

Access the Absence grid with events awaiting approval:

Select the Absences that require approval. Absences with a status of *Needs Approval*, *Error*, and *Denied* can be approved.

You can approve multiple absence events in the **Absence Events** grid on the manager's Timesheet. If at least one of the events requires forecasting before approval, a validation error is issued that requires you to run the Forecast process. If multiple events are forecasted, a message is displayed indicating that forecasting completed successfully. Click the **Forecast Details** link that is displayed in the **Forecast Results** tab to verify the forecast results for each of the events.

## Absence Source

The Source column of the Absence Events grid displays the source of entry of the absence event. Depending on the entry source, some events can be modified on the Timesheet page. This table lists the combinations of entry source, the label displayed in the **Source** column, and indicates in which applications the event can be modified:

<b>Source of Entry</b>	<b>Label Displayed</b>	<b>Can be modified in . . .</b>
Absence Event Entry	Administrator	Absence Event Entry
Time and Labor	Time and Labor	Absence Event Entry
Third Party	Third Party	Absence Event Entry Third Party

<b>Source of Entry</b>	<b>Label Displayed</b>	<b>Can be modified in . . .</b>
Employee Absence Self Service	Employee	Absence Event Entry Employee Timesheet Manager Timesheet
Manager Absence Self Service	Manager	Employee Timesheet Absence Event Entry Manager Timesheet
Employee Timesheet	Employee	Absence Event Entry Employee Timesheet Manager Timesheet
Manager Timesheet	Manager	Absence Event Entry Employee Timesheet Manager Timesheet

**Note:** On Timesheets, you can approve absence events that are entered using Employee and Manager Absence Self-service pages or Employee and Manager Timesheets only if they are defined to allow entry in Time and Labor in the Country Take component.

**Note:** When the timesheet is the entry source for an absence, the system uses the Time and Labor approval setup. Although the country take may have approval defined, if you do not have Time and Labor approval set up the absence is auto-approved.

## Approving Payable Time

This section provides an overview of approving payable time.

### Pages Used to Approve Time

<b>Page Name</b>	<b>Definition Name</b>	<b>Usage</b>
<a href="#">Approve Payable Time - Approve Time for Time Reporters Page</a>	TL_MNG_APRV_SRCH	Approve time for one or more time reporters that are displayed using the Employee Selection Criteria and date range fields.

<b>Page Name</b>	<b>Definition Name</b>	<b>Usage</b>
<a href="#">Approve Payable Time Page</a>	TL_MNG_GRP_APPROVE	View and approve separate time entries for an individual time reporter.
<a href="#">Timesheet Page</a>	TL_RPTD_PCH TL_RPTD_ELP	Adjust reported time entries.
Time Reporting Comments Page	TL_TR_COMMENTS	View or add comments to individual time entries.
<a href="#">Request Batch Approval Process Page</a>	TL_APPRV_RUNCTL	Approve time for a group of employees during a batch process.

## Understanding Approval of Payable Time

Approval of payable time is required if one or more of these conditions apply:

- The Approval Level of Payable Time is set to Use Workgroup Setting on the Time Reporting Codes - Definition page. And the Approve Payable Time check box is selected on the employee's workgroup setup page.
- The Approval Level of Payable Time is set to *Always* on the Time Reporting Codes - Definition page.
- The Approval Level of Payable Time is set to *Use Rule* on the Time Reporting Codes - Definition page. And the user has written a rule that identifies the employee's payable time as time that must be approved.

You can view and approve payable time on the Approve Payable Time – Approve Time for Time Reporters or the Approve Payable Time pages. The Approve Payable Time – Approve Time for Time Reporter page displays all time reporters dependant on entries specified in the Employee Selection Criteria and date range fields and who have time with a Payable Status of *Needs Approval*. The Approve Payable Time page displays time entries for an individual time reporter.

---

**Note:** Basic non-AWE (non-Approval Workflow Engine) approval is an option for Payable Time approvals if you are concerned about the performance of Time Administration process. Basic non-AWE is a simpler security based model for approving payable time than the Approval Framework, or AWE, for Payable Time. This means that a manager's access and ability to approve a time reporter's Payable time is based on the same security that grants the manager access to view and modify the person's time. The appropriate rules should be selected, the payable time approval routing works fine. For more information, see: [Configurations Page](#)

---

## Approve Payable Time - Approve Time for Time Reporters Page

Use the Approve Payable Time - Approve Time for Time Reporters page (TL\_MNG\_APRV\_SRCH ) to approve time for one or more time reporters that are displayed using the Employee Selection Criteria and date range fields.

Navigation:

- **Time and Labor > Approve Time > Approve Payable Time > Approve Payable Time - Approve Time for Time Reporters**
- **Manager Self Service > Time Management > Approve Time and Exceptions > Approve Payable Time > Approve Payable Time - Approve Time for Time Reporters**

This example illustrates the fields and controls on the Approve Payable Time - Approve Time for Time Reporters page. You can find definitions for the fields and controls later on this page.

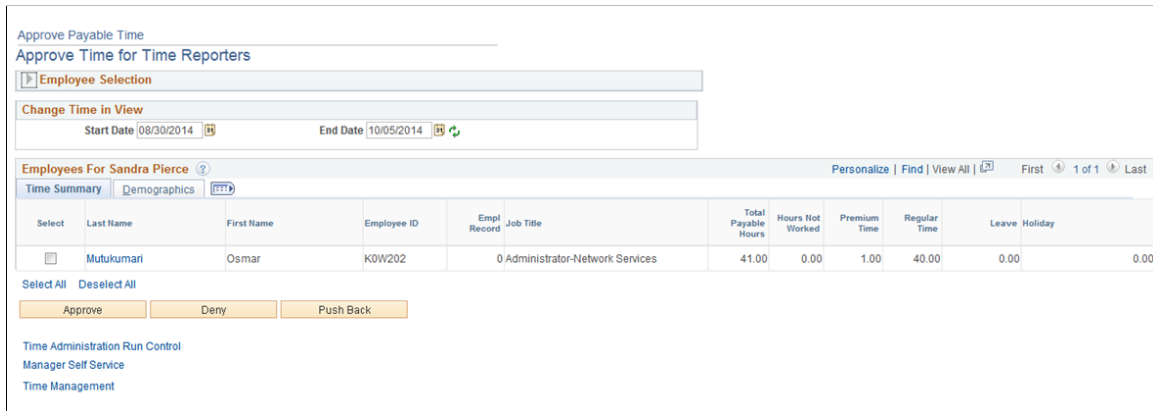

**Note:** Time must be processed through Time Administration and have a payable status of Needs Approval.

The Approve Payable Time - Approve Time for Time Reporter page offers manager the capability to refine their search including groups, employee IDs, a certain date range, or many other criteria, or simply to return all the employees for whom they have approval authority and who have payable time that needs approval. After the manager enters the search criteria and clicks the **Get Employees** button, the result list displays below the Employee Search Criteria and Date fields.

The manager can then select one or more employee rows and click the **Approve** button to approve the payable time. Alternatively, the manager can click the employee name link to view and approve each employee's payable time entries.

See [Understanding Manager Self-Service Components](#).

### Employee Grid

The columns **Select**, **Name** and **Total Payable Hours** are always displayed. The fields selected in the **Include in List** column on the Manager Search Options page are also displayed.

See [Setting Up User Preferences](#).

<i>Field or Control</i>	<i>Description</i>
<b>Select</b>	Select this check box next to the time reporter's name to approve payable time.

<b>Field or Control</b>	<b>Description</b>
<b>Name</b>	Click on the individual time reporter's link to view details of their time entry from the Approve Payable Time page.
<b>Total Payable Hours</b>	<p>Displays the total number of related hours that require approval.</p> <p>Each row of the grid displays the <b>Total Payable Hours</b> for a time reporter. In Time and Labor, you keep such things as shift differentials and shift bonuses (compensation only hours) separate from the actual hours of effort reported. The actual hours are based on the daily time records that the system has created (that is, compensation only hours are not included). Total hours, (or Total Amount or Total Units) represent all hours (amounts or units) for that day, including compensation only hours, amounts, or units.</p>
<b>Select All, Deselect All</b>	<p>Click <b>Select All</b> to select all the time reporters displayed for approval.</p> <p>Click <b>Deselect All</b> to deselect all rows.</p>
<b>Approve</b>	Click this button to approve the selected time reporters' payable time.
<b>Deny</b>	Click this button to deny the selected time reporters' payable time.
<b>Push Back</b>	Click this button to push back the selected time reporters' payable time.

## Related Links

[Understanding Payable Time](#)

## Approve Payable Time Page

Use the Approve Payable Time page (TL\_MNG\_GRP\_APPROVE ) to view and approve separate time entries for an individual time reporter.

Navigation:

**On the Approve Payable Time - Approve Time for Time Reporters, click the time reporter's Last Name link to view details of the entry.**

This example illustrates the fields and controls on the Approve Payable Time page. You can find definitions for the fields and controls later on this page.

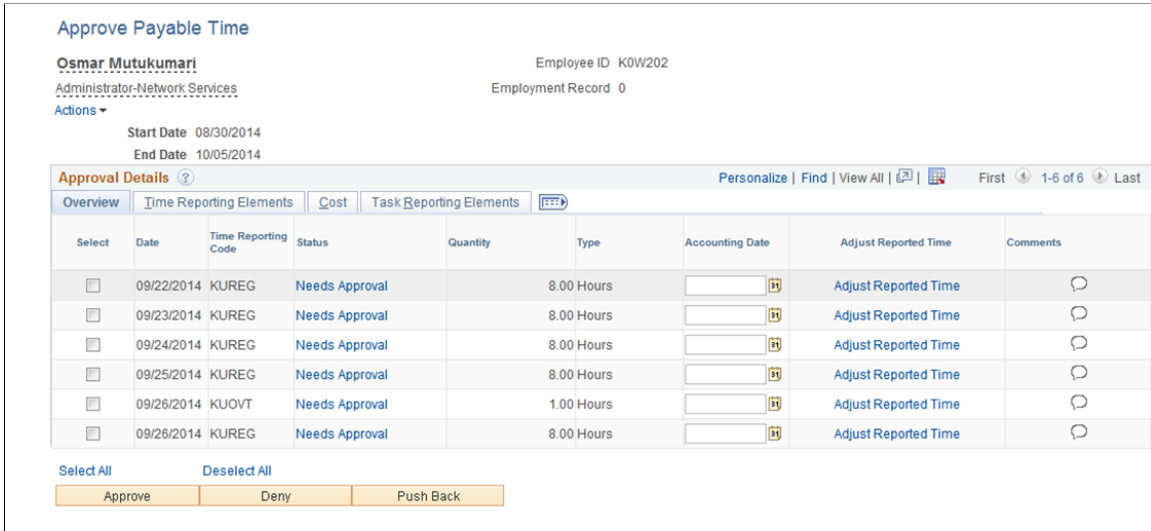

Select the check box in the **Select** column next to the rows that you want to approve. The system displays all data for the payable time in the appropriate field. If no data exists for the field, it is blank.

Select the **Time Reporting Elements**, **Cost**, or **Task Reporting Elements** tabs to view additional details about the time that needs approval.

<b>Field or Control</b>	<b>Description</b>
<b>Adjust Reported Time</b>	Click this link to display the Timesheet page that enables you to adjust the time reporter's reported time.
<b>Comments</b>	Click the icon in this column to add or view a comment related to an incidence of time. Click the <b>Save</b> button on the Comments page, and then the <b>OK</b> button to confirm the save and display the Approve Payable Time page.  <b>Note:</b> The appearance of the icon in this column changes if a comment is attached to that row.

## Timesheet Page

Use the Timesheet page (TL\_RPTD\_PCH ) to adjust reported time entries.

Navigation:

Click the Adjust Reported Time link.

This page is the same as the Timesheet page. When time is adjusted using the Timesheet page, resubmit the reported time and run the Time Administration process again. The adjusted reported time then becomes payable time that can be approved.

## Related Links

[Reporting Time](#)

## Request Batch Approval Process Page

Use the Request Batch Approval Process page (TL\_APPRV\_RUNCTL) to approve time for a group of employees during a batch process. This essentially overrides any open Approval Framework transactions.

Navigation:

**Time and Labor > Approve Time > Batch Approval Process Request > Request Batch Approval Process**

This example illustrates the fields and controls on the Request Batch Approval Process page. You can find definitions for the fields and controls later on this page.

<b>Field or Control</b>	<b>Description</b>
<b>From Date</b> and <b>End Date</b>	Enter the start and end date for the time reporters who have reported time that you want to include in the batch approval process.
<b>Accounting Date</b>	Defaults to current date. Can be changed to synchronize with a date within an accounting period used in Project Costing and PeopleSoft General Ledger.
<b>EmplID</b>	Enter or select the Employee ID that you want to include or exclude during the approve time process. If you select EmplID, <b>Group ID</b> is unavailable for entry for that row.
<b>Empl Record</b>	Displays the employee record number for the EmplID. If <b>EmplID</b> is blank, this field is blank.

<b>Field or Control</b>	<b>Description</b>
<b>Group ID</b>	Enter or select the Group ID of the employees that you want to include during the approve time process. If you select a Group ID, <b>EmplID</b> is unavailable for entry for that row.
<b>Include/Exclude Indicator</b>	You can <i>Include</i> or <i>Exclude</i> individual employees. For example, enter the Group ID for a group of employees, add a row, and enter the Employee ID of the employee whom you do not want to include in the approve time process. Then, select <i>Exclude</i> for that row. The system will not approve time for that employee, even though they belong to the group. Use the same procedure to add an employee to the group.

---

**Note:** When Approval Workflow Engine (AWE) is implemented and batch approval is run, the payable status moves to approved and the corresponding AWE status moves to terminated.

---

## Working with Delegations in Time and Labor

This section provides an overview of delegation and discusses how to review delivered Time and Labor delegation set up.

### Understanding Delegation

Time and Labor uses delegation to enable one person to authorize another to serve as his or her representative when managing time transactions. A manager can delegate their tasks of approving time, entering employee time, or entering their own time to another person due to workload or their own absence from the office.

#### Delegation Framework

The delegation framework supports the following types of delegation:

- Downward delegation of authority to a direct report or another person lower down in the reporting hierarchy.
- Upward delegation of authority to a manager or another person higher up in the reporting hierarchy.
- Lateral delegation of authority to a peer either within the same division or in a different division within the reporting hierarchy.

---

**Note:** To prevent situations of cascading or circular delegation chains, once the delegation framework passes delegated authority over a transaction to a proxy, the proxy cannot delegate authority over that transaction to another user. The delegation framework only passes authority over transactions from initial delegator to initial proxy.

---

#### Delivered Delegation Set Up for Time and Labor

The delegation framework for Time and Labor is delivered with the system. To review this framework:



1. Review delegation transactions for workflow on the Register Workflow Transaction page.
2. Review delegation permission lists and roles through PeopleTools Security components.
3. Define installation settings for delegation on the Delegation Installation Settings page.
4. Review transactions for delegation on the Configure Delegation Transaction page.

## Reviewing Delivered Time and Labor Delegation Set Up

This section discusses how to:

- Review workflow transactions.
- Review permission lists and roles for delegation.
- Define installation settings.
- Review delegation transactions.

### Reviewing Workflow Transactions

The PeopleSoft system delivers the following transactions that are pre-configured for the Time and Labor delegation framework:

- TLReportedTime
- TLPayableTime

See “Linking Workflow Transactions” (Application Fundamentals).

See “Setting Up Approval Process Definitions” (Application Fundamentals).

### Reviewing Permission Lists and Roles for Delegation

PeopleSoft Human Resources delivers as system data several permission lists that are required for use of the delegation framework.

This table describes the delivered Time and Labor roles for the delegation framework:

<b>Role Name</b>	<b>Attached Permission Lists</b>	<b>Description</b>
Delegate Manage Report Time	HCCPDL2060 HCCPDL2064	This role gives you access to the TL_MSS_EE_SRCH_PRD component.  This role gives you access to the TL_MNG_EX_PNL_GPR1 component.

<b>Role Name</b>	<b>Attached Permission Lists</b>	<b>Description</b>
Delegate Manage App Rpt Time	HCCPDL2061 HCCPDL2064	This role gives you access to the TL_MSS_EE_SRCH_PRD component.  This role gives you access to the TL_MNG_EX_PNL_GPR1 component.
Delegate Manage App Pay Time	HCCPDL2062 HCCPDL2063 HCCPDL2064	This role gives you access to the TL_SRCH_APPRV_GRP component.  This role gives you access to the TL_MNG_PAY_VIEW_DT component.  This role gives you access to the TL_MNG_EX_PNL_GPR1 component.
Delegate Manage Overtime Req	HCCPDL2065 HCCPDL2066 HCCPDL2067	This role gives you access to the TL_OT_MNGR_LIST component.  This role gives you access to the TL_OT_VW_MGR component.  This role gives you access to the TL_OT_BALANCES component.
Delegate Approve Overtime	HCCPDL2065 HCCPDL2066 HCCPDL2067	This role gives you access to the TL_OT_MNGR_LIST component.  This role gives you access to the TL_OT_VW_MGR component.  This role gives you access to the TL_OT_BALANCES component.

---

**Note:** Setting up permission lists and role security is discussed in detail in a PeopleTools PeopleBook.

---

See *PeopleTools: Security Administration*.

See “Setting Up Permission Lists and Roles for Delegation” (Enterprise Components).

## Defining Installation Settings

When using delegations in Time and Labor, you should select the **All Persons** hierarchy and the **By Dept Security Tree** hierarchy on the Delegation Installation Settings page, since Time and Labor group security is not supported by the delegation framework.

See “Defining Delegation Installation Settings” (Enterprise Components).

See “Setting Up Access to Direct Reports Data” (Application Fundamentals).

## Reviewing Delegation Transactions

This table lists the delegation transactions delivered for Time and Labor:

<b><i>Transaction Name</i></b>	<b><i>Transaction Type</i></b>	<b><i>Role</i></b>
Manage Reported Time	Initiate	Delegate Manage Report Time
Manage Approve Reported Time	Approve	Delegate Manage Appr Rpt Time
Manage Approve Payable Time	Approve	Delegate Manage Appr Pay Time
Manage Approve Overtime	Approve	Delegate Approve Overtime
Manage Overtime Request	Initiate	Delegate Manage Overtime Req

See “Configuring Delegation Transactions” (Enterprise Components).



# Managing Time

## Understanding the Time Reporting Process

Approved time is managed by resolving exceptions, modifying the time, or adjusting time that has been reported or paid.

You can use system security to determine which pages display for different types of users. For example, you may want a data entry clerk to view only reported or payable time. The User ID for the data entry clerk determines which pages are displayed. In this case, the user can only view time, without making changes. Or, you may want a user to be able to adjust time that has already been paid, but not approve the time. Again, the User ID determines which page appears; in this case, the Adjust page is accessible.

This graphic depicts the interaction between time reporting, scheduling, the time manager, and other common areas within the application with the Manage Time pages

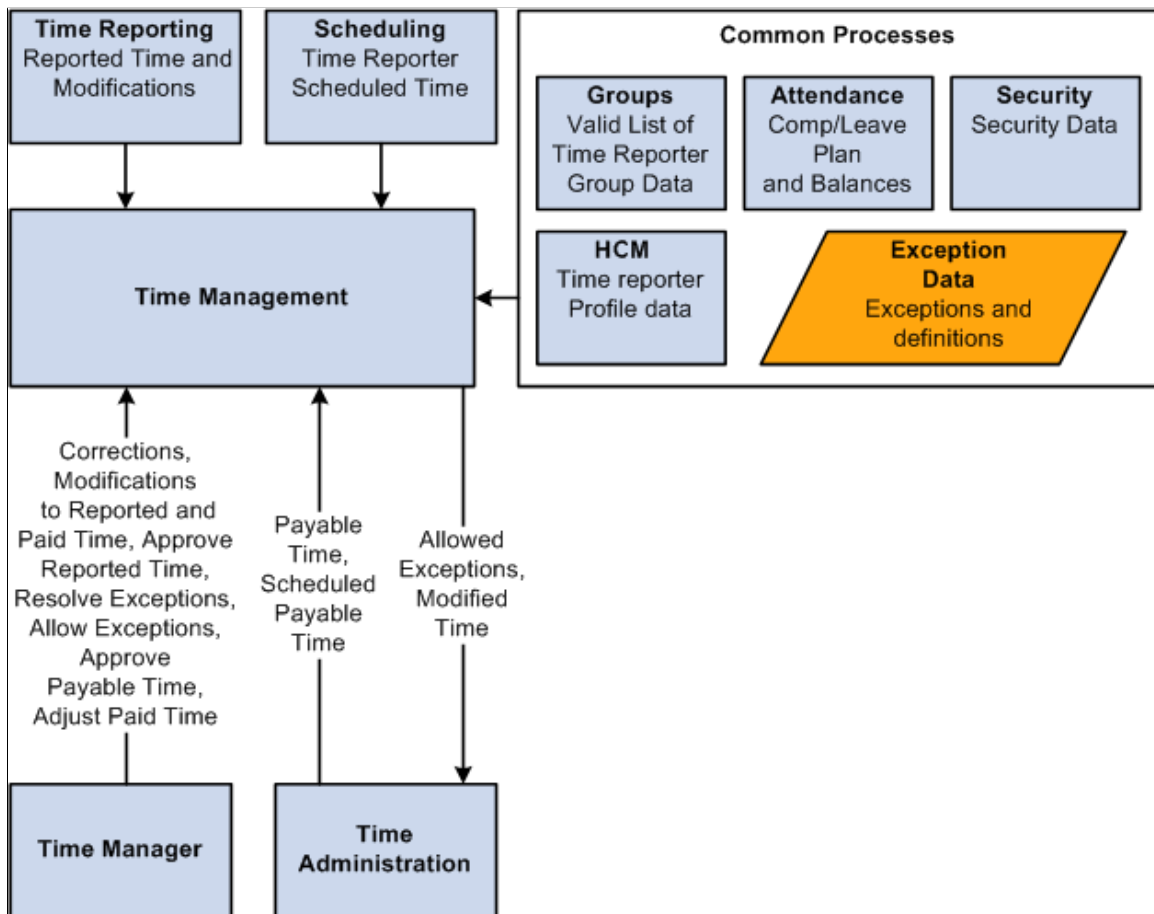

## Prerequisites for Enabling Absences on Timesheets

Absence Management integration enables employees and their managers to enter and work with absence event information that is entered in PeopleSoft Absence Management or Time and Labor, and is integrated with either PeopleSoft Payroll for North America or PeopleSoft Global Payroll. Employees that are active in Absence Management must be enrolled in Time and Labor. The absence event pages that you use to manage time in Time and Labor are included in this section.

The Absence Management grids that are displayed on the Timesheet pages in Time and Labor, including the absence event entries and absence entitlement balances and links for requesting and approving absence events, are displayed only if either Absence Management and/or Global Payroll are selected on the Products page of the HCM Installation Table component.

See “Setting Up Implementation Defaults” (Application Fundamentals).

To work with absence event information on employee timesheets, the employee's **Pay System** value must be either *Global Payroll* or *Payroll for North America* and the **Absence System** value must be *Absence Management* on the Payroll page of the Job Data component in Workforce Administration.

---

**Note:** For Global Payroll employees the **Absence System** value is hidden and defaults to Absence Management.

---

See “Payroll Page” (PeopleSoft Human Resources Administer Workforce).

Employees that are active in Absence Management must be enrolled in Time and Labor.

See [Entering and Maintaining Time Reporter Data](#).

The Country Take component is used to define Country-specific rules that apply to all Take elements for a given country. They control some of the field displays on the self service pages, and determine if online Forecasting and Balance Inquiry processes can be used for any Take elements that are set up for the country. You can define a different set of self service rules for each country.

On the Absences page of the Country Take component, ensure that you enable entry in Time and Labor for the absence Take elements that you want to enter on the Timesheet page.

See “Defining Self Service Absence Rules by Country” (PeopleSoft Absence Management).

For each Absence Take element that you want to make available to self service users, you define an additional set of rules. These rules specify whether partial-day absences are allowed, approval requirements for absence requests, how to display forecasting results, and other usage rules. It is important to set up the Country Take component and understand the significance of the values chosen or entered on this component prior to entering values through absence self service.

See “Defining Absence Take Elements” (PeopleSoft Absence Management).

## Common Elements Used in This Section

<i>Field or Control</i>	<i>Description</i>
<b>Job Title</b>	Displays the Job Title of the time reporter for which the time was reported.

<i>Field or Control</i>	<i>Description</i>
<b>ID</b>	Displays the time reporter EmplID for the reported time.

### Related Links

[Creating and Updating Dynamic Groups](#)

[Understanding Row Security Permission Lists](#)

## Managing Exceptions

This section presents an overview of managing exceptions.

### Pages Used to Manage Exceptions

<i>Page Name</i>	<i>Definition Name</i>	<i>Usage</i>
<a href="#">Exceptions Page</a>	TL_MNG_EXCEPT_PNL1	Review, allow, or clean up exceptions. Up to 100 exceptions display per page.
<a href="#">Exceptions History Page</a>	TL_AUD_EXCEPT_PNL	View exceptions that have been resolved or allowed.

## Understanding Exceptions

Exceptions are generated when time is reported and either an aspect of the time is incorrect, or the time does not comply with a user-defined rule. Exceptions may be system-generated through validation processes or generated as a result of Time Administration rules. Each exception has an associated severity level. Exceptions with a *High* severity level must be resolved or allowed, in order for the reported time associated with the exception to become payable time. Use the Manage Exception component to specify which exceptions to allow for a specific time reporter, or a group of time reporters. In addition to the standard exceptions delivered with the system, you can define your own exceptions in accordance with your organization's time management policies.

### Resolving or Allowing Exceptions

On the Manage Exceptions pages, time managers review the exceptions and determine if reported time should be adjusted or if a setup table value must be added or changed to resolve the exception. In addition to viewing exceptions on the Manage Exceptions page, time managers have the options to allow exceptions or to use the **Clean Up Exceptions** button to resolve exceptions, after the reported time for non-setup related exceptions has been adjusted.

To resolve an exception, determine if an error exists with reported time or if there is an invalid value in a setup table. If the error is due to reported time (non-setup exception), correct the time on the Timesheet or Rapid Time entry pages, and then process the time again by submitting the time and/or running Time Administration. If the error is setup-related, you may need to change the reported time or change a value

in one of the setup tables. To resolve the exception, correct the time or setup value and then run Time Administration. For example, a setup-related exception may be generated if time reporters report time using a new TRC that has not been added to their TRC program. Because the TRC is not in the program, an exception is generated stating "TRC not in the TRC Program." You must either correct the reported time or add the TRC to the TRC program. A non-setup or reported time exception could occur if time reporters report task profiles that are not valid for their taskgroup. The generated exception is "Task Profile not in Taskgroup."

If a *High* severity exception is not resolved or allowed, it remains in the Exceptions Table and the time does not become payable time. Exceptions with a severity level of *Low* or *Medium* will become payable time, but they also remain in the Exceptions Table until the exception is resolved or allowed.

The Allow Exceptions functionality enables you to allow an exception and generate payable time without having to resolve it. This is useful for organizations that use informational exceptions. For example, consider exceptions that are created in the retail industry because a time reporter is approaching an overtime limit. The time manager could be notified that the time reporter is approaching the limit but decides to allow this exception during the holiday peak season.

## Exception Statuses

PeopleSoft also provides a status indicator for the exception. Statuses help you work with the exceptions. Possible exception statuses are *Unresolved*, *Resolved*, and *Allowed*. When an exception is created, the status of the exception is *Unresolved*. If you modify time, the system checks the Exceptions Table to determine if the modification occurs within the date range of a pre-existing exception. When Time Validation and Time Administration run again, if the exception condition no longer exists, then the status changes to *Resolved*.

Exceptions are created with the *Unresolved* status. If the exception is generated for reported time, the manager or administrator changes the reported time and clicks the **Clean up Exception** button to see if exceptions are addressed. If the exception is recreated, the status is again *Unresolved*. If exceptions are not recreated, they will be deleted or retained with the status of *Resolved*, based on the archive configuration in the exception definition setup. The same is true for exceptions that are generated for payable time.

## Exception History

View Exception History Information by using the Exception History page. The following conditions determine if the exception information appears on this page:

- If you set up an Exception ID with the Archive Exception check box cleared, (Don't Archive), the exception will not appear if you *Resolve* the exception.
- If you set up an Exception ID with the Archive Exception check box cleared, (Don't Archive), the exception will appear if you *Allow* the exception
- If you set up an Exception ID with the Archive Exception check box selected, (Archive), the exception appears when you either *Resolve* or *Allow* the exception.

---

**Note:** Most exceptions delivered with the system have a Severity Level of *High* and are not allowable. You must resolve these exceptions (unless you changed them in the Exception setup table so that they are allowable) for the system to create payable time for the time reporter in these instances.

---

See [Defining Exceptions](#).



See [Exceptions History Page](#).

## Defining Exception Conditions

You can define all the conditions that require managers to review reported time before it becomes payable time. Examples include an employee missing a punch, punching in late, working more than eight hours of overtime, or being tardy ten times in the last month. Focus on the elements of reported time that are important to your organization.

## Validating Time and Creating Exceptions

Reported time entered through Time and Labor time entry pages is validated online (before Time Administration processing). Time that is reported by a Rapid Time entry, Mass Time entry, GP Absence entry, or by a TCD interface does not have online validation, and must go through a Submit Time process so that the system can create exceptions for invalid data. The Submit Time process initiates a Time Reporting Validation process, which generates exceptions for any invalid data that was a result of either time being reported or a problem with setup data. Any exceptions generated from this process are then displayed on the Manage Exceptions or Manage Group Exceptions pages.

## Low Severity Delivered Exceptions

Two exceptions are delivered that have a low severity. Both are related to the integration of Time and Labor and Absence Management. Exception TLX01700, "Full absence and reported time" occurs when a full day absence exists and there is reported time. Exception TLX01710, "Partial Absence and Punch Time" is generated if punch time with a source code SCH exists for the days of a partial absence and the workgroup is configured for Create Partial Work hours. This is a warning that the regeneration of reported time did not adjust the punch scheduled time.

## Clean Up Exceptions Button

If you have made an adjustment to reported time and want to verify the exception has been fixed before running Time Administration, click on the "Clean Up Exceptions" button on the Manage Exceptions page. The Clean Up Exceptions button also calls the Resolution Exception process and will resolve any non-setup related exceptions where the time has been corrected. You will still need to run Time Administration to create payable time, but the Clean Up Exceptions button is a tool for you to verify that the adjustment you made to the reported time will actually resolve the exception. For example, a time reporter enters an invalid value in the Task Profile field, and then you correct the value on the Timesheet page. Rather than waiting until your Time Administration process runs again, if you want to verify that the correction you made to the Task Profile is the right one and will actually fix the exception, click the Clean Up Exceptions button on the Manage Exceptions. This will clean up and resolve the exception if the adjustment you made to the Task Profile is valid. Then when your Time Administration process runs again, it will create the appropriate payable time.

---

**Note:** Exceptions may be generated based on validation rules invoked by the Submit Time process, or by user-defined rules processed through Time Administration. However exceptions are generated, they must be either resolved or allowed if Time Administration is to process the related reported time into payable time. If you resolve the exception by adjusting reported time, you need to resubmit that (adjusted) reported time so that Time Validation runs again and removes the exception. You can either run the Time Administration process again for that time reporter, or using the Manage Exceptions page, click the Clean up Exceptions button to verify the adjustment you made will actually resolve the exception, and then run Time Administration for that time reporter. During the subsequent running of Time Administration, the time will become payable time along with that which you approved, rather than resolved.

---

## Exceptions Page

Use the Manage Exceptions page (TL\_MNG\_EXCEPT\_PNL1) to review, allow, or clean up exceptions. The system displays up to 100 exceptions per page

**Note:** This page has been replaced by the Manage Exceptions page in Fluid. For more information, see [Using PeopleSoft Fluid User Interface for Time Management as a Manager](#).

Navigation:

**Manager Self Service > Time Management > Approve Time and Exceptions > Exceptions > Exceptions**

**Time and Labor > View Time > Exceptions > Exceptions**

This example illustrates the fields and controls on the Exceptions page. You can find definitions for the fields and controls later on this page.

The screenshot shows the 'Exceptions' page interface. At the top, there is a section for 'Employee Selection' and a 'Filtering Options' section. The filtering options include dropdown menus for '\*Date Filter', 'Employee Filter', '\*Exception Filter', and 'Severity', along with text input fields for 'Start Date', 'Employee ID', and 'Exception ID'. A 'Select' button is located at the bottom right of the filtering section. Below this is a table with columns: Allow, Last Name, First Name, Empl ID, Empl Record, Exception ID, Description, Date, and Severity. The table contains two rows of data. At the bottom, there is an 'Allow Exceptions' section with 'Select All', 'Deselect All', and 'Save' buttons.

Allow	Last Name	First Name	Empl ID	Empl Record	Exception ID	Description	Date	Severity
<input type="checkbox"/>	Martignoni	David	KUJ0075	0	TLX00420	Invalid TRC	12/28/2006	High
<input type="checkbox"/>	Rohein	Isabella	KUN006	0	TLX00420	Invalid TRC	12/28/2006	High

**Note:** You may view and allow exceptions with a status of *Unresolved* using this page. System delivered exceptions have a *High* severity level are not allowable. To view exceptions that have already been resolved or allowed, use the Exceptions History page.

Field or Control	Description
<b>Employee Selection Criteria</b>	Enter values and click the <b>Get Employees</b> button to control which employee exceptions the system displays to approve or resolve.
<b>Filter Options</b>	Expand this grid to further control which exceptions the system displays.

## Filter Options

<b>Field or Control</b>	<b>Description</b>
<b>Date</b>	Select a date filter for this exception: <i>between, equal to, greater than, or less than.</i>
<b>EmplID</b>	Select an EmplID filter for this exception: <i>equal to, greater than, less than, or like.</i>
<b>Severity</b>	Select a severity level filter for this exception: <i>High, Low, or Medium.</i>
<b>Exception ID</b>	Select an exception ID filter for this exception: <i>equal to, like, not equal to, not like.</i>
<b>Run Control ID</b>	Enter the value of the run control that was used when the exception was created.

## Exceptions Grid

<b>Field or Control</b>	<b>Description</b>
<b>Allow</b>	Select the check box in this column to select an individual time reporter's exception to be allowed for that date. <hr/> <b>Note:</b> If all the exceptions displayed on the page are not allowable, then the <b>Allow</b> column and <b>Allow All</b> button are hidden. <hr/>
<b>Exception ID</b>	Displays the Exception ID code that was delivered with the system or that you defined using the Define Exceptions page. Click the <b>Details</b> tab to view the Exception Information details of the exception.
<b>Description</b>	Description of the exception.
<b>Date</b>	Displays the date of the reported time that caused the exception.
<b>Name</b>	Employee's name for the related exception.

<b>Field or Control</b>	<b>Description</b>
<b>Severity</b>	<p>Displays the severity of the exception: <i>High</i>, <i>Medium</i>, and <i>Low</i>. The system does not create payable time for reported time that has an exception severity of <i>High</i>. The system does create payable time for reported time with an exception severity of <i>Low or Medium</i>.</p> <hr/> <p><b>Note:</b> The system treats <i>Low</i> and <i>Medium</i> exceptions in the same manner. The <i>Medium</i> severity is primarily an administrative designation that enables managers indicate exceptions that require greater attention.</p> <hr/>
<b>Select All</b>	<p>Click to select all the exceptions for the group to be allowed. This selects the <b>Allow</b> check boxes for all the exceptions displayed on the page. If you click this button again, the system clears the <b>Allow</b> check boxes. Once you have selected the exceptions you want to allow, click the <b>Save</b> button to allow the exceptions. The exceptions can then be processed through Time Administration to create payable time.</p> <hr/> <p><b>Note:</b> If all the exceptions displayed on the page are not allowable, then the <b>Allow</b> column and <b>Select All</b> and <b>Deselect All</b> buttons are greyed out.</p> <hr/>
<b>Deselect All</b>	<p>Click to clear all selections made.</p>
<b>Save</b>	<p>Once you have selected the exceptions you want to allow, click the Save button to allow the exceptions. The exceptions can now be processed through Time Administration to create payable time.</p>

## Viewing Manage Exception Details

Click the Details tab.

This example illustrates the fields and controls on the Exceptions page - Details tab. You can find definitions for the fields and controls later on this page.

The screenshot displays the 'Exceptions' page in a web application. At the top, there is a section for 'Employee Selection' and 'Filtering Options'. The filtering options include dropdown menus for '\*Date Filter', 'Employee Filter', '\*Exception Filter', and 'Severity', along with input fields for 'Start Date', 'Employee ID', and 'Exception ID'. A 'Select' button is located below these filters. Below the filtering section, there is a table with the following columns: 'Allow', 'Last Name', 'First Name', 'Empl ID', 'Empl Record', 'Exception ID', 'Source', 'Last Updated', and 'Exception Data'. Two rows of data are visible in the table, both showing 'Time Reporting Code KURGM is not valid for the date reported.'

**Note:** The screenshot does not display all information on the page. Scroll to right on your screen to see the entire page.

<b>Field or Control</b>	<b>Description</b>
<b>Exception ID</b>	The exception can be a system-delivered exception or one that you defined using the Define Exceptions pages.
<b>Source</b>	The source of the process that created the exception, such as Time Administration or Time Validation.
<b>Last Update Date Time</b>	Displays the date and time the exception was resolved or allowed.
<b>Exception Data</b>	Displays the message that contains the actual values that were entered that caused the exception such as "The reported TRC BNKR is invalid."
<b>Exception Description</b>	Click this link to view the long description for the exception.
<b>Comments</b>	Enter any comments about how or why the exception was allowed or resolved.

**Note:** The remaining fields that display on the Details tab are the fields that have been selected on the Manager Search Options page.

## Exceptions History Page

Use the Review Exceptions History page (TL\_AUD\_EXCEPT\_PNL) to view exceptions that have been resolved or allowed.

Navigation:

**Time and Labor > View Time > Exceptions History**

This example illustrates the fields and controls on the Exceptions History page. You can find definitions for the fields and controls later on this page.

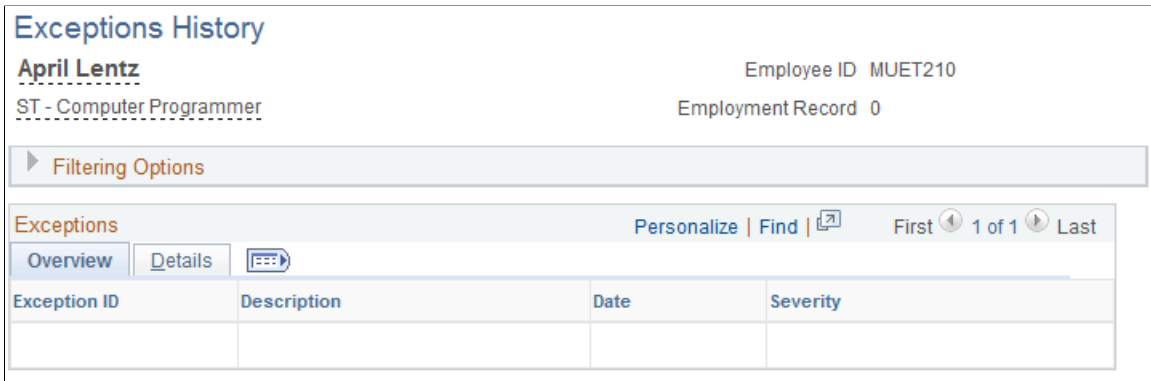

<b>Field or Control</b>	<b>Description</b>
<b>Exception ID</b>	Click the link that appears in this column to view details of the resolved or allowed exception.
<b>Description</b>	Displays the description of the exception. This description is the exception text either delivered with the system or that you established when you set up your exceptions.
<b>Status</b>	Displays whether the exception was <i>Resolved</i> or <i>Allowed</i> . To view and allow <i>Unresolved</i> exceptions, use the Manage Exceptions page.
<b>Severity</b>	Displays the severity of the exception: <i>High</i> , <i>Medium</i> or <i>Low</i> . The system will not create payable time or send the time to payroll if the exception severity is <i>High</i> until it is either allowed or resolved by the user. However, the system will create payable time for reported time with an exception severities of <i>Medium</i> or <i>Low</i> .

The Exception ID link displays the same information as the Manage Exceptions Details tab.

**Important!** To view a particular exception on the Exceptions History page, you must first specify that you want the exception to be archived during exception setup. To do this, go to the Define Exception page, display the specific exception of interest, and select the Archive Exception check box. When the exception is generated and is subsequently resolved or allowed, it appears on the Exceptions History page.

The Filter Options page functions the same as the Filter Options on the Manage Exceptions page. See Manage Exceptions , Filter Options for a description of these fields.

**Related Links**

[Understanding Exceptions and Validations](#)

## Adjusting Time

This section discusses how to make *Record Only* adjustments for individual employees or for non-employees.

### Pages Used to Adjust Time

<i>Page Name</i>	<i>Definition Name</i>	<i>Usage</i>
<u>Adjust Paid Time Page</u>	TL_MNG_PAY_DET_PNL	Make <i>Record Only</i> adjustments for individual employees or for non-employees.

### Understanding Adjustments to Payable Time

Occasionally you may need to make an adjustment to payable time that has already been paid by Payroll, or has been closed. This type of adjustment is called a Record Only Adjustment and is made using the Adjust Paid Time page. When you make an adjustment of this type, it is for record keeping purposes only. The time you add or adjust is not processed by Time and Labor nor is the time sent to payroll. For example, a time reporter may have forgotten to report vacation time taken in the last time reporting period. Payroll is notified, their system updated with the time, and a manual check is cut for the employee. To keep your payroll and Time and Labor systems in sync, you use Time and Labor to record that time for record keeping purposes. Because the time has already been paid by payroll and their system adjusted, it does not need to be sent to payroll again. This feature enables you to keep Time and Labor system in sync with your payroll system, without re-sending or processing duplicate data.

---

**Important!** This component should not be used for employees in Global Payroll Pay Groups. To make adjustments for Global Payroll employees, use the original input component, for example, Timesheets.

---

Using the Adjust Paid Time page, you can add new time, delete time, or change existing payable time that has already been processed by the payroll system and has a payable status of *Diluted* or *Distributed*. You also can adjust time that has a status of *Closed* (for example, time reported by contractors that does not get sent to payroll).

All the time reporting fields appear on the Adjust Paid Time page for editing. You can change any field except the Payable Status, and TRC Type fields. After you make adjustments using this page, the system does not process the time further. It does not run it through Time Administration or send the time to payroll. Time and Labor does publish the payable time to your Project Costing application. If compensatory time is reported, the system will not process it or adjust the time reporter's compensatory time balance the next time the Time Administration process is run for that time reporter. Use the Weekly page to make these adjustments.

When you modify existing payable time, the system creates offsets because all payable time rows viewable in Adjust Paid Time are in a frozen state. The system creates offsets to back out the originally reported time, and then add in the new time that you have entered. For example, if you originally reported 2 hours of overtime and then go in and adjust that to 4 hours, the system will generate 3 rows of data as in the following table:

<b>Date</b>	<b>Quantity</b>	<b>TRC</b>
08/01/2000	2	OT (Overtime)
08/01/2000	-2	OT (Overtime)
08/01/2000	4	OT (Overtime)

The first row is the original two hours of OT, the second row is the offset that backs out the original two hours, and the third row is the new time that you are reporting. The offsets do not display on the Adjust Paid Time page, but you can view them on the View Payable Time page.

**Related Links**

[Payable Time Status and Reason Codes](#)

[Integrating with Project Costing](#)

[Understanding Exceptions and Validations](#)

**Adjust Paid Time Page**

Use the Adjust Paid Time page (TL\_MNG\_PAY\_DET\_PNL) to make Record Only adjustments for individual employees or for non-employees.

Navigation:

**Time and Labor > Report Time > Adjust Paid Time**

This example illustrates the fields and controls on the Adjust Paid Time page. You can find definitions for the fields and controls later on this page.

**Note:** If you change or add Leave Time Taken, you must manually change the leave hours in your HR database. The system will not adjust your leave balances. Also, the system will not adjust compensatory time balances for changes or additions of reported compensatory time.

<b>Field or Control</b>	<b>Description</b>
<b>Date</b>	Enter the date you want to adjust for the time that was paid.



<b>Field or Control</b>	<b>Description</b>
<b>Payable Status</b>	<p>Displays the payable status for the reported time: <i>Closed</i>, <i>Diluted</i>, <i>Distributed</i> or <i>Rejected</i>.</p> <hr/> <p><b>Note:</b> For rows of payable time that have a status of <i>Rejected</i>, a <i>Close</i> check box is displayed. When you select this check box, you prevent the row from being loaded to payroll. After you select the <i>Close</i> check box and save the page, the payable status remains <i>Rejected</i>. (Behind the scenes, the Payroll Request Number is set to 1.)</p> <hr/>
<b>Reason Code</b>	The reason code associated with the payable status.
<b>Time Reporting Code</b>	Enter the Time Reporting Code (TRC) to use to adjust the time, or leave the field blank. The system uses TRCs to track time reporter's time to support all of your administrative and compensation needs, such as payroll processing, or to collect labor distribution information.
<b>Quantity</b>	Enter the quantity to use for the Time Reporting Code for the reported time: <i>Amounts</i> , <i>Units</i> , or <i>Hours</i> depending on the Time Reporting Code entered.
<b>TRC Type</b>	Displays the TRC Type (Amounts, Units, or Hours) based on the Time Reporting Code that you entered to adjust the time. This is a display-only element.
Accounting Date	Enter a date to synchronize with a date within an accounting period used in Project Costing and General Ledger.
<b>Taskgroup</b>	Select the taskgroup for the time you want to adjust. The system displays the appropriate task elements on the <b>Task Reporting Elements</b> tab, depending on your selection.

**Note:** Absence rows are not displayed on this page.

## Time Reporting Elements

The columns that are displayed are based on the selections made on the employee time reporting template.

<b>Field or Control</b>	<b>Description</b>
<b>Date</b>	Displays the date you entered on the Adjust Paid Time page.

<b>Field or Control</b>	<b>Description</b>
<b>Payable Status</b>	Displays a description of the payable status for the payable time to be approved. The values that will display on the Adjust Paid Time page are <i>Closed</i> , <i>Paid-Labor Diluted</i> , and <i>Paid – Labor Distributed</i> .
<b>Approval Process Datetime</b>	Displays the date and time this reported time was approved. This is a display-only element.
<b>Taskgroup</b>	Displays the taskgroup name for the taskgroup you entered on the Adjust Paid Time page, or you can select the taskgroup to use for the adjusted time here. The Task Reporting Elements defined for the taskgroup appear at the bottom of the page under Task Reporting Elements.
<b>Time Reporting Code</b>	<p>Displays the TRC that you entered on the Adjust Paid Time page. Or, if it is blank, you can enter the TRC for the payable time to adjust.</p> <hr/> <p><b>Note:</b> Rules Only type TRC's do not show up on the time reporting pages, but they will display on the Adjust Paid Time page. Rules Only TRC's are TRC's that have been specified for Rules processing use only, and not used for reporting time.</p> <hr/>
<b>Quantity</b>	Displays the quantity that you entered on the Adjust Paid Time page. Or if it is blank, you can enter the quantity for the TRC of the payable time to adjust.
<b>TRC Type</b>	Displays the TRC Type for the TRC of the payable time to adjust.
<b>Billable Indicator</b>	Select to make the time available to the Mobile Time and Expense feature in Project Costing.
<b>Currency</b>	Select a currency code for the time you want to adjust if you require your time reporters to report a currency type code for the time being reported and if the TRC Type for the time is an <i>Amount</i> .
<b>Override Rate</b>	Select an override rate for the time to adjust. The rate is sent to your payroll system to use in calculating pay. Otherwise, the rate is set by default to the rate on the Time Reporting Code or the hourly rate on the time reporter's job record.

<b>Field or Control</b>	<b>Description</b>
<b>Rate Code</b>	Select a rate code to specify the Compensation Rate for the time you want to adjust.
<b>Country</b>	Select the country for the time being adjusted, otherwise the system uses the default for the time reporter.
<b>State</b>	Select the state for the time being adjusted to report a state other than the default associated with the time reporter's Tax Location Code.
<b>Locality</b>	Select the locality for the time being adjusted to report a locality other than the default for the time reporter. The locality should be reported with the associated state. The state and locality combination must be defined for the time reporter on the Maintain Tax Data pages.

## Task Reporting Elements

The columns that are displayed are based on the selections made on the task template.

These elements appear if the task element is defined on the taskgroup associated to the time reporter.

<b>Field or Control</b>	<b>Description</b>
<b>Company, Business Unit, Location, Department, Position, Product, Customer, Task, Project/Grant, PC Business Unit, Resource Type, Resource Category, Resource Sub Category, Perf Meas Business Unit, Activity ID, Account Code, User Field 1-5, Job Code</b>	Select an item for the time being adjusted for each applicable element.
<b>User ID</b>	Displays the User ID of the person who adjusted the time.
<b>Publish Switch</b>	Displays the Publish Switch for time that was published to Project Costing.
<b>Publish Date</b>	This is the date Time and Labor published actual costs to Project Costing and other financial applications. <i>Publish</i> takes place as soon as the system sets the payable time status to <i>closed</i> . Time and Labor sets the Publish Date on the payable time record to show that this time was published in its final form.

<b>Field or Control</b>	<b>Description</b>
<b>Accounting Date</b>	Defaults to current date. Can be changed to synchronize with a date within an accounting period used in Project Costing and PeopleSoft General Ledger.
<b>Estimated Gross</b>	<p>Enter the payable time estimate for the time being reported when converted to gross pay by payroll. Payroll uses the appropriate rate for the earnings unless, in Time and Labor, the rate is a positively reported rate that's sent to payroll as an override. The currency code identifies the currency in which this amount is stated.</p> <p>This field remains an estimate. The system does not replace it with actual costs received from payroll. PeopleSoft keeps the estimate as an historic record of what Time Administration calculated.</p>
<b>Labor Distribution Amount</b>	Enter the adjusted labor distribution amount for the time being adjusted. You must manually determine the amount to enter here. The Labor Distribution process takes a lump sum amount from Payroll and divides it across the Time and Labor entries that went into the calculation of the lump sum.
<b>Diluted Labor Distribution Amt</b>	Enter the adjusted Labor Dilution amount for the time being adjusted. The process takes all the records in a day and derives a combined rate based on total cost. This combined rate is applied back to the hours in the day.

**Related Links**

[Understanding Payable Time](#)

[Creating Task Templates](#)

[Understanding Time and Labor Implementation](#)

## Auditing Time

This section provides an overview of auditing time.

### Pages Used to Audit Time

<b>Page Name</b>	<b>Definition Name</b>	<b>Usage</b>
<a href="#">Reported Time Audit Page</a>	TL_AUD_RPTTIME_PNL	View current reported punch and elapsed time.

<b>Page Name</b>	<b>Definition Name</b>	<b>Usage</b>
<u>Reported Time Audit - History Page</u>	TL_AUDIT_RPT_PNL	View changes made to the reported elapsed or punch time selected.
<u>Unprocessed Reported Time Page</u>	TL_UNPROCESS_SUMM	Identify time that has not gotten to Payable Time, either because Time Administration process has not been run, the time has not been approved, there are exceptions with the time or due to some rule processing, the amount of time in the Reported Time tables does not match the amount of time in the Payable Time tables.
<u>Unprocessed Payable Time Page</u>	TL_UNPROCESS_SUMM	Identify time that has not been paid. Employees who have time that is in the following status' will display on this page: (Status: Estimated, Approved, Needs Approval, Rejected by Payroll, Sent to Payroll for PNA.

## Understanding Auditing Time

Three Time and Labor components and a number of public queries exist to audit and track time. The components include Reported Time Audit, Unprocessed Reported Time, and Unprocessed Payable Time. This section provides an overview of these components and lists the delivered public queries for auditing time.

### Reported Time Audit

The Reported Time Audit component contains pages that display time that exists in the Reported Time tables and in the Audit tables, which include all entries and changes that have occurred to the time. Audit pages enable you to view punch and elapsed time for historical purposes and to track the changes that have occurred to the originally reported time. On the main Reported Time Audit pages, the system displays reported time that is *current*. A History link is displayed if changes were made to the originally reported time; otherwise the link is unavailable. The pages include the Time Reporting Elements and Task Reporting Elements tabs that contain additional information about the reported time. These pages eliminate the need to create reports to track changes to time.

### Unprocessed Reported Time

The Unprocessed Reported Time component identifies time that is still in Reported Time for these reasons:

- Time needs approval
- Time has not been submitted (or is in a Saved status).
- Time has been denied.
- Exceptions exist for the time entered.

- The total payable time is less than the sum of submitted or approved time.

### Unprocessed Payable Time

The Unprocessed Payable Time component identifies time with these statuses:

- Approved – Goes to Payroll
- Needs Approval
- Estimated – Ready for Payroll
- Sent to Payroll (if PNA is the pay system)
- Taken – Used by Payroll (if GP is the pay system)
- Rejected by Payroll

### Queries to Track Time

These queries enable you to identify time that was entered through Mass Time or Rapid Time but is not in Reported Time.

<b>Query Name</b>	<b>Description</b>
TL_Unproc_Rapid_Pch	Unprocessed Rapid Punch Time
TL_Unproc_Rapid_Elp	Unprocessed Rapid Elapsed Time
TL_Unproc_Mass_Pch	Unprocessed Mass Punch Time
TL_Unproc_Mass_Elp	Unprocessed Mass Elapsed Time

See the product documentation for *PeopleTools: PeopleSoft Query*.

Also see [Viewing and Resolving TCD Errors](#).

### Reported Time Audit Page

Use the Reported Time Audit page (TL\_AUD\_RPTTIME\_PNL) to view current reported punch and elapsed time.

Navigation:

**Time and Labor > View Time > Analyze Reported Time Audit > Reported Time Audit**

This example illustrates the fields and controls on the Reported Time Audit page. You can find definitions for the fields and controls later on this page.

### Reported Time Audit

**Franklin Burns**  
ST - Acctg Clerk

Employee ID MUET111  
Employment Record 0

---

\*Start Date

\*End Date

Get Rows

---

Time Information
Personalize | Find | | First 1-2 of 2 Last

Overview

Time Reporting Elements

Date	Time Reporting Code	Punch Type	Quantity	Reported Status	History	Status	Taskgroup
10/31/2002	MVT	Elapsed	3.00	Submitted	<a href="#">History</a>	Current	MUTAADMIN
10/31/2002	MEG	Elapsed	8.00	Submitted	<a href="#">History</a>	Current	MUTAADMIN

## Overview

<b>Field or Control</b>	<b>Description</b>
<b>Start Date and End Date</b>	Enter the start and end date for the time you want to view. The system populates the fields with the data for all time reported from the start to the end date.
<b>Get Rows</b>	Click after you enter the start and end dates. The system retrieves the data for all the current reported time, and all time that has been deleted that was reported on and between the start and end dates.
<b>Time Reporting Code</b>	Displays the Time Reporting Code for the reported time that has a status of either <i>Current</i> or <i>Delete</i> .
<b>Quantity</b>	Displays the quantity for the Time Reporting Code for elapsed reported time that has a status of <i>Current</i> or <i>Delete</i> , or the duration for matched punches for punch reported time.
Reported Status	Values that appear in this column include <i>Saved</i> , <i>Denied</i> , <i>Submitted</i> , <i>Needs Approval</i> , and <i>Approved</i> .
<b>History</b>	Click this link to see details about the changes that were made to the time. If the time is current and no changes were made to the time, this field is unavailable. If the link is available, then changes have occurred to the time; click the link to view them.

<b>Field or Control</b>	<b>Description</b>
<b>Status</b>	Values that appear in this column are <i>Current</i> or <i>Delete</i> . If <i>Current</i> , the system displays either the originally reported time if no changes have occurred, the latest change to the originally reported time, or time that has been added since the time was originally reported. If the status is <i>Delete</i> , the system displays the time that was deleted (through the elapsed timesheet).
<b>Taskgroup</b>	Displays the taskgroup for the reported time.

## Time Reporting Elements

Select the **Time Reporting Elements** tab to view these fields:

<b>Field or Control</b>	<b>Description</b>
<b>Punch Type</b>	Displays the type of punch for the reported time. If the reported time is elapsed time, <i>Elapsed</i> is displayed in this column.
<b>Punch Date and Time</b>	Displays the date and time the punch was reported.
<b>Currency Code, Country, State, Locality, Billable, and Rate Code</b>	Displays this field information for the reported time that was originally reported then changed.
<b>Task Profile ID</b>	Displays the Task Profile ID for the reported time. The Elapsed Audit History Sec page displays the Task Profile ID for the originally reported time.
<b>Override Reason Code</b>	Displays the code for the reason the reported time was overridden.
<b>Badge ID</b>	Displays the Badge ID number for the reported time if you require a badge number to be used when reporting time.
<b>Time Collection Device ID</b>	Displays the ID of the time collection device to which the time was reported.
<b>Rule Element 1-5</b>	Displays the rule element for the reported time. Time reporters can override rule elements that are assigned to them on the Create or Maintain Time Reporter Data pages.



<b>Field or Control</b>	<b>Description</b>
<b>Reported Time Source</b>	Displays the source of where the reported time was generated, such as Time Administration or Time Validation.

### Task Reporting Elements

This tab is displayed if the time reporter is associated with a taskgroup.

<b>Field or Control</b>	<b>Description</b>
Time Reporting Code	Displays the TRC for reported time.
Customer	Displays the customer.
Combo Code	Displays the combo code for the reported time.

### Reported Time Audit - History Page

Use the Reported Time Audit - History page (TL\_AUDIT\_RPT\_PNL) to view changes made to the reported elapsed or punch time selected.

Navigation:

Click the History link on the Reported Time Audit page.

This example illustrates the fields and controls on the Reported Time Audit – History page. You can find definitions for the fields and controls later on this page.

<b>Field or Control</b>	<b>Description</b>
<b>Audit Action</b>	Displays the Audit Action for the reported time: <i>Add</i> , when time is reported but not approved <i>Change</i> , when the reported time is approved, <i>Delete</i> , <i>Key Change Old Key</i> , and <i>Key Change New Key</i> .

<b>Field or Control</b>	<b>Description</b>
<b>Date Under Report, Time Reporting Code, Quantity, Reported Status, Taskgroup</b>	A row is inserted with this information when the time is approved.

The **Time Reporting Elements** tab displays the same information as the **Time Reporting Elements** tab on the Reported Time Audit page.

## Unprocessed Reported Time Page

Use the Unprocessed Reported Time page (TL\_UNPROCESS\_SUMM) to identify time that has not gotten to Payable Time, either because Time Administration process has not been run, the time has not been approved, there are exceptions with the time or due to some rule processing, the amount of time in the Reported Time tables does not match the amount of time in the Payable Time tables.

Navigation:

**Time and Labor > View Time > Unprocessed Reported Time > Unprocessed Reported Time**

This example illustrates the fields and controls on the Unprocessed Reported Time page. You can find definitions for the fields and controls later on this page.

The screenshot shows the 'Unprocessed Reported Time' page with the following sections:

- Employee Selection:** A dropdown menu.
- Instructions:** A section for user instructions.
- Filtering Options:**
  - Start Date: 01/01/2000
  - End Date: 01/15/2000
  - Include Exception Reporters
  - Positive / Negative Deviation:
    - Include Positive Deviations (Acceptable Deviation: 5)
    - Include Negative Deviations (Acceptable Negative Deviation: 5)
- Employees with Unprocessed Time:** A table with columns: Last Name, First Name, Employee ID, Empl Record, Job Title, Type, Saved, Needs Approval, Pushed Back, Denied, Approved and Submitted, Payable Time, Exceptions Exist, Earliest Change Date, Time Administration Status.

Last Name	First Name	Employee ID	Empl Record	Job Title	Type	Saved	Needs Approval	Pushed Back	Denied	Approved and Submitted	Payable Time	Exceptions Exist	Earliest Change Date	Time Administration Status
Fung	James	KU0035	0	Consultant-Senior	Hours					70.00	90.00		04/28/2008	Up For Processing
Rogers	Cynthia	KC0003	0	Clerk-Accounting	Hours					72.00	86.00		01/03/2000	Up For Processing
Santos	Antonio	KU0010	0	Assistant-Administrative	Hours					66.25	79.25		05/07/2012	Not Up For Processing
Stevenson	Christelle	KU0020	0	Clerk-Payroll Sr	Hours					47.75	72.50		04/28/2008	Up For Processing

<b>Field or Control</b>	<b>Description</b>
<b>Name</b>	Click the link in this column to view details for that row.
<b>Start Date and End Date</b>	The date range cannot extend beyond 31 days.
<b>Acceptable Deviation</b>	Enter an acceptable deviation amount for the calculation between reported and payable time.
<b>Include Exception Reporters</b>	Typically exception time reporters have no hours in Reported Time but many hours of Payable Time. The default is to exclude exception time reporters.

<b>Field or Control</b>	<b>Description</b>
<b>Include Positive Deviations</b>	Select to include payees with Payable Time greater than Reported Time on this page. Clear this field to only display payees with Payable Time less than Reported Time. The <b>Acceptable Deviation</b> field determines the threshold amount for reporting in either case.

Click the Name link to view details. The detail page will not display any Task Elements, Chartfields or Time Reporting Elements. The detail page displays by day and by status the employee's time for Reported Time that has not gotten to Payable Time. This includes reported time with a status of Needs Approval (NA), Saved (SV), or Denied (DN) and any time with exceptions. If there is no time in those statuses, a message is displayed indicating that the Time Administration process must be run to move approved or submitted time to Payable Time.

This example illustrates the fields and controls on the Unprocessed Reported Time Details page. You can find definitions for the fields and controls later on this page.

Unprocessed Reported Time									
Reported Time Details									
Cynthia Rogers			Employee ID KC0003		Last Processed				
Clerk:Accounting			Employment Record 0						
Previous Employee			Next Employee						
Unprocessed Reported Time from 01/01/2000 to 01/15/2000									
Date	TRC	Description	Type	Quantity	Punch Type	Punch Time	Reported Status	Datetime modified	Exception Exists
01/03/2000	KUHOL	Holiday (Statutory)	Hours	8.00			Submitted		
01/04/2000				3.00	In	7:00:00AM	Submitted		
01/04/2000				1.75	In	10:15:00AM	Submitted		
01/04/2000					Out	5:00:00PM	Submitted		
01/04/2000				2.00	In	1:00:00PM	Submitted		
01/04/2000				0.25	Break	3:00:00PM	Submitted		
01/04/2000				1.75	In	3:15:00PM	Submitted		
01/04/2000				0.25	Break	10:00:00AM	Submitted		
01/04/2000				1.00	Meal	12:00:00PM	Submitted		
01/05/2000				1.75	In	10:15:00AM	Submitted		
01/05/2000				0.25	Break	10:00:00AM	Submitted		
01/05/2000				3.00	In	7:00:00AM	Submitted		
01/05/2000				1.00	Meal	12:00:00PM	Submitted		
01/05/2000					Out	6:00:00PM	Submitted		
01/05/2000				2.75	In	3:15:00PM	Submitted		

<b>Field or Control</b>	<b>Description</b>
Reported Status	This column will display these statuses: <i>Needs Approval</i> , <i>Saved</i> , and <i>Denied</i> .
Exception Exists	An icon is displayed for rows where exceptions exist.

## Unprocessed Payable Time Page

Use the Unprocessed Payable Time page (TL\_UNPROCESS\_SUMM) to identify time that has not been paid.

Employees who have time that is in the following status will display on this page: Estimated, Approved, Needs Approval, Rejected by Payroll, Sent to Payroll for PNA.

Navigation:

**Time and Labor > View Time > Unprocessed Payable Time > Unprocessed Payable Time**

This example illustrates the fields and controls on the Unprocessed Payable Time page. You can find definitions for the fields and controls later on this page.

Unprocessed Payable Time															
Employee Selection															
Instructions															
Filtering Options															
Start Date 01/01/2000		*Payroll System Payroll for North America													
End Date 01/08/2000															
Employees with Unprocessed Time <span style="float:right">Personalize   Find   View All   First 1-8 of 8   Last</span>															
Time Summary   Demographics															
Last Name	First Name	Employee ID	Empl Record	Job Title	Type	Needs Approval	Pushed Back	Approved	Estimated	Sent to Payroll	Taken by Payroll	Rejected by Payroll	Exceptions Exist	Earliest Change Date	Time Administration Status
Dunbar	Kirby	KC0002	0	Director-Canada	Hours				40.00					01/03/2000	Up For Processing
Griffins	Marina	KC0001	0	Secretary-Senior	Hours				40.00					01/03/2000	Up For Processing
Johnson	Danny	KU0042	0	Assistant-Administrative	Hours			20.00						04/30/2012	Up For Processing
Johnson	Danny	KU0042	1	Analyst-HRMS	Hours			22.00						04/30/2012	Up For Processing
Reid	Charles	KC0004	0	Clerk-Payroll	Hours			10.00						01/03/2000	Up For Processing
Reid	Charles	KC0004	1	Analyst-Human Resources	Hours			38.00						01/03/2000	Up For Processing
Rogers	Cynthia	KC0003	0	Clerk-Accounting	Hours			47.00						01/03/2000	Up For Processing
Santos	Antonio	KU0010	0	Assistant-Administrative	Hours									05/07/2012	Not Up For Processing

<b>Field or Control</b>	<b>Description</b>
<b>Name</b>	Click the link to access the detail for that row.
<b>View Details for All Employees</b>	Click this link to display unprocessed payable time for all employees. This page that is displayed lists each instance of unprocessed payable time for each employee. Click the download icon next to the <b>Find</b> link on the group box title bar to save this information in spreadsheet format for additional analysis and reporting.

This example illustrates the fields and controls on the Unprocessed Payable Time Details page. You can find definitions for the fields and controls later on this page.

**Unprocessed Payable Time**

**Payable Time Details**

**Antonio Santos** Employee ID KU0010  
 Assistant-Administrative Employment Record 0

Start Date 01/01/2000 Payroll System Payroll for North America  
 End Date 01/08/2000 Previous Employee

▼ Payable Time Details Personalize | Find | [?] | [ ] First 1-25 of 25 Last

Date	Time Reporting Code	Type	Quantity	Payable Status	Payable Reason
01/03/2000	KUREG	Hours	-3.75	Approved	
01/03/2000	KUREG	Hours	-3.75	Approved	
01/03/2000	KUREG	Hours	2.58	Approved	
01/03/2000	KUREG	Hours	2.58	Approved	
01/03/2000	KUREG	Hours	2.58	Approved	
01/04/2000	KUREG	Hours	-4.00	Approved	
01/04/2000	KUREG	Hours	-4.00	Approved	
01/04/2000	KUREG	Hours	2.66	Approved	
01/04/2000	KUREG	Hours	2.66	Approved	
01/04/2000	KUREG	Hours	2.66	Approved	
01/05/2000	KUREG	Hours	-4.00	Approved	
01/05/2000	KUREG	Hours	-4.00	Approved	
01/05/2000	KUREG	Hours	2.66	Approved	
01/05/2000	KUREG	Hours	2.66	Approved	
01/05/2000	KUREG	Hours	2.66	Approved	

This page displays all rows in payable time that have not been processed by payroll. The data is sorted by **Date** and then by **Time Reporting Code**. Payable time with these status codes is displayed on this page:

- Estimated
- Approved
- Needs Approval
- Rejected by Payroll
- Sent to Payroll (for Payroll for North America)

<i>Field or Control</i>	<i>Description</i>
<b>Previous Employee and Next Employee</b>	Click these links to display information for the previous or next employee listed in <b>Employees with Unprocessed Payable Time</b> grid on the Unprocessed Payable Time page.

## Overriding Rules for a Day

This section discusses how to override rules for a time reporter for a day. The Override Rules page tells the system to bypass rules processing for the day for the time reporter. Time Administration sends reported time, or scheduled time for an exception reporter that didn't positively report anything, to Payable Time and will not process any rules on that time.

When Time Administration is initiated, it extracts records from the Time and Labor Intermediate Payable Time table for any days with reported time that have been overridden, into a rules override working table. It then applies rules to all records stored on the Intermediate Payable Time table and updates payable time. As a final step, Time Administration uses the data stored in the rules override working table to replace records found in the final Payable Time table.

**Note:** You must enter time exactly how you want your time reporter to get paid, including overtime hours, using one of the time reporting pages when you want to override rules for a day.

## Page Used to Override Rules for a Day

<i>Page Name</i>	<i>Definition Name</i>	<i>Usage</i>
<u>Override Rules Page</u>	TL_RULES_OVR_PAGE	Stop Time Administration from processing any rules against the time for the day.

## Override Rules Page

Use the Override Rules page (TL\_RULES\_OVR\_PAGE) to stop Time Administration from processing any rules against the time for the day.

Navigation:

**Time and Labor > Process Time > Override Rules Report**

This example illustrates the fields and controls on the Override Rules page. You can find definitions for the fields and controls later on this page.

### Override Rules

**Melissa Kennedy**

Job Title Assembler

Empl ID KA3004

Empl Record 0

Date Under Report	Personalize	First	1-9 of 9	Last
<b>*Date Under Report</b>				
06/13/2001		+		-
06/14/2001		+		-
06/15/2001		+		-
07/10/2002		+		-
07/11/2002		+		-
07/12/2002		+		-
07/07/2005		+		-
07/08/2005		+		-
07/09/2005		+		-

<b>Field or Control</b>	<b>Description</b>
<b>Date Under Report</b>	Enter the date of the day for which you want Time Administration to bypass rules processing.

## Related Links

[Understanding Exceptions and Validations](#)

[Understanding the Time Administration Process Flow](#)

---

## Setting up and Managing Alerts

This section describes the overview of alerts framework.

### Understanding Alerts Framework

Time and Labor Alerts Framework is a configurable framework that allows a Company's Business Policy to define targets and thresholds to monitor business risks, set limits and to react accordingly. Alerts assist Managers to track Overtime limits and Absence limits. It also helps to track time reporting status, time data verification, leave balances, reported time limits and any unprocessed data.

The Alerts framework in Time and Labor captures the details such as planned and unplanned leave, overtime frequencies', work patterns and leave balances

## Pages Used to Set Up and Manage Alerts

<i>Page Name</i>	<i>Definition Name</i>	<i>Usage</i>
<u>Alert Criteria Page</u>	TL_ALERT_CRT	Define the circumstances that require an alert.
<u>Alert Program Page</u>	TL_ALERT_PGM	Define a set of alert rules which decides the set of people to be notified according to the met conditions.
<u>Alert Notification Page</u>	TL_ALERT_NOTIFY	Decide whose details to be routed to whom.
<u>Value List Page</u>	TL_VAL_LIST_PNLGRP	To filter or select limited Time Reporting codes for processing alerts or reports.
<u>Process Alerts Page</u>	TL_ALERTS_PROCESS	To execute the data checking at a given time and frequency.
<u>Administer Alerts Page</u>	TL_VAL_LIST_PNLGRP	Removes unwanted alerts if it is outdated and created on the basis of <ul style="list-style-type: none"> <li>• Remove unwanted alerts; outdated, created from a poorly defined criterion or any other reason. This is generally about rectifying mistakes and getting rid of outdated entries.</li> <li>• Re-assign alerts; perhaps specifically those sent to the administrator as a default recipient when the user list failed to identify anyone else. There are no restrictions to which the administrator can re-direct an alert.</li> </ul>

## Understanding Alerts Framework

Alerts Framework is a configurable framework that allows a company to define targets and thresholds to monitor business risks, set limits and to react accordingly. This functionality of Alert framework is to ensure that the appropriate people are notified when an exception occurs and then the user to react accordingly.

Alerts assist Managers to track Overtime limits and Absence limits. It also helps to track time reporting status, time data verification, leave balances, reported time limits and any unprocessed data. Alerts are not supported for the cases of severity and attendance. The Alerts framework in Time and Labor captures the details such as planned and unplanned leave, productive and unproductive work hours, overtime frequencies', work patterns and leave balances.



## Alert Criteria Page

Use the Alert Criteria page (TL\_ALERT\_CRT) to define the circumstances that require an alert.

Navigation:

**Set Up HCM > Product Related > Time and Labor > Alerts > Alert Criteria**

This example illustrates the fields and controls on the Alert Criteria page.

- Defines whose data is subject to what checks and who gets notification if there is a violation.
- Decides the type of Alert, its source and associate it with a given period.
- Qualify and quantify the data and criteria setting for acceptable limit or boundary for the data that meets criteria.
- Using the alert criteria, you can configure the criteria of each alert. The source of the alert criteria defines the data which has to be monitored. Also, you can set the criteria based on a defined calendar period.

**Note:** Oracle PeopleSoft delivers Notification Composer Framework to manage the setup and administration of all notifications in one central location.

Once you have adopted the Notification Composer feature, you must use it to create new notifications and manage your existing notifications.

Notifications delivered with HCM Image 47 or later must use Notification Composer.

For more information about Notification Composer Framework, see “Understanding Notification Composer” (Enterprise Components).

<b>Type</b>	<b>Source</b>
Balances	Compensation Leave/ Leave Plan table
Exceptions	Exceptions
Limit	Absence Event, Payable Time, Reported Time
Pattern	Absence Event, Reported Time
Status	Absence Event, Payable Time, Reported Time
Unprocessed Data	Payable Time, Reported Time
Data Verification	Payable Time, Reported Time

## Alert Criteria-Balances Page

Navigation:

**Set Up HCM > Product Related > Time and Labor > Alerts > Alert Criteria**, Select Alert Type as Balances

This example illustrates fields and controls on the alert criteria for balance type.

**Alert Criteria**

Alert Criterion ID: KUCMPBL  
 \*Description: Comp Balances exceeds 20 Hrs

**Criterion Details** ?

\*Alert Type: Balances

\*Source: Comp or Leave Time

\*Menu Navigation: [Timesheet](#)

\*Calendar: PSWEEK

**Qualify Criterion** ?

\*Filter Type: Comp Time Plan

\*Benefit Plan list: KUCOMP [Compensatory Time Off Plans](#)

**Quantify Criterion** ?

\*Criterion Type: is greater than

Limit: 20.00

Additional Criterion (Or):

Additional Limit: 0.00

**Explanation (this Criterion will result in an Alert when):**  
 The time reporters balance from the plan(s) listed in KUCOMP is greater than 20.

<b>Field or Control</b>	<b>Description</b>
<b>Criterion Details</b>	Specify the type of Alert, its source and associate it with a period.  Qualify the criterion by further refining what data should be reviewed. Quantify the criterion by setting the acceptable limit or boundary for the data that meets the criteria; for example the maximum hours of overtime reported for a week before an alert should be triggered
<b>Portal Target</b>	Select the common page within the portal where the recipient of the alert should be directed when reviewing the data that triggers this type of alert.

## Alert Criteria-Exception Page

This example illustrates fields and controls on the alert criteria for Exception alert Type.

**Alert Criteria**

Alert Criterion ID: KUEXPAP  
 \*Description: Partial Absence and Punch time

**Criterion Details** ?

\*Alert Type: Exception  
 \*Source: Exceptions  
 \*Menu Navigation: Timesheet  
 \*Calendar: PSWEEK Weekly Period - PS Delivered

**Qualify Criterion** ?

\*Filter Type: Exceptions by ID  
 \*Exception List: KUTLPABP Partial Absence Punch Time

**Quantify Criterion** ?

\*Criterion Type: is greater than  
 \*Metric: Count (Occurrences) Limit: 8.00

**Explanation (this Criterion will result in an Alert when):**  
 The number of qualifying exceptions is greater than 8 for a given PSWEEK Calendar period.

Save Return to Search Notify Refresh Add Update/Display

<b>Field or Control</b>	<b>Description</b>
<b>Quality Criterion</b>	Specify additional parameters for the data to be considered when validating this criterion, like a set of Time Reporting Codes or a set of Status codes
<b>Quantify Criterion</b>	Define the boundary (or boundaries) outside which this criterion should trigger an alert, such as the minimum and / or maximum hours generally allowed.

## Alert Criteria-Limit Page

Use Alert Criteria-Limit page to define the circumstances that require an alert.

This example illustrates fields and controls on the alert criteria for Limit.

**Alert Criteria**

Alert Criterion ID: KUWABSEL  
 \*Description: Absence exceeds 16Hrs/Wk

**Criterion Details**

\*Alert Type: Limit  
 \*Source: Absence Event  
 \*Menu Navigation: Absence Request  
 \*Calendar: PSWEEK Weekly Period - PS Delivered

**Qualify Criterion**

Absence Take List: KUABS Multiple absence takes

**Quantify Criterion**

\*Criterion Type: is greater than Limit: 16.00  
 \*Metric: Hours

**Explanation (this Criterion will result in an Alert when):**  
 The hours of qualifying absence event submitted during a PSWEEK period is greater than 16.

Limits do not require value list to be entered. It may be sufficient to express the limit without specifying a set of TRC's or Absence codes. This particularly rings true in terms of limits such as estimated gross on payable time.

## Alert Criteria-Pattern Page

This example illustrates fields and controls on the alert criteria for Pattern.

**Alert Criteria**

Alert Criterion ID: KURTHOL  
 \*Description: Works more hrs after holiday

**Criterion Details**

\*Alert Type: Pattern  
 \*Source: Reported Time  
 \*Menu Navigation: Timesheet  
 \*Calendar: PSWEEK Weekly Period - PS Delivered

**Qualify Criterion**

\*Filter Type: Works Excessive Hours TRC List:   
Punch Type List:

**Quantify Criterion**

\*Pattern: Occurs next to a Holiday \*Count: 2.00  
 \*Metric: Count (Occurrences) \*Max Acceptable Hours: 8.00

**Explanation (this Criterion will result in an Alert when):**  
 A time reporter works more than 8 hours, and this occurs next to a holiday 2 time(s) or more in the same PSWEEK period.

In addition to offering the same absence cover, when absence is reported using designated TRC's, this alert enables flagging of excess hours or people working without breaks. The page content adheres to the Filter Type chosen. The patterns are the number of occurrences, number of days consecutive, or the number of occurrences next to a holiday.

## Alert Criteria-Status Page

This example illustrates fields and controls on the alert criteria for Status

**Alert Criteria**

Alert Criterion ID KUABSNA  
 \*Description

**Criterion Details** ?

\*Alert Type

\*Source

\*Menu Navigation [Absence Request](#)

\*Calendar  Weekly Period - PS Delivered

**Qualify Criterion** ?

\*Status List  Absence needs approval status

**Explanation (this Criterion will result in an Alert when):**  
 The time reporter has one or more absence event entries with a status included in the KUABSNA list.

Status check alerts are provided against Absence Events, Payable Time and Reported time.

## Alert Criteria-Unprocessed Time Page

This example illustrates fields and controls on the alert criteria for unprocessed time.

**Alert Criteria**

Alert Criterion ID KUUPDPT  
 \*Description

**Criterion Details** ?

\*Alert Type

\*Source

\*Menu Navigation [Payable Time Detail](#)

\*Calendar  Weekly Period - PS Delivered

**Explanation (this Criterion will result in an Alert when):**  
 There is Unprocessed Payable Time.  
 Per this criterion Unprocessed Payable Time is generically defined as time left in a status of Estimated, Needs Approval, Pushed Back, Approved, Rejected, Sent to or Taken By Payroll.

Unprocessed time is expressed in the explanation when the criterion is defined.

## Alert Criteria-Data Verification Page

This example illustrates fields and controls on the alert criteria for Data Verification.

**Alert Criteria**

Alert Criterion ID: KUDVPTQ  
 \*Description: Payable Time has Zero Hrs

---

**Criterion Details** ?

\*Alert Type: Data Verification  
 \*Source: Payable Time  
 \*Menu Navigation: Payable Time Detail  
 \*Calendar: PSWEEK  Weekly Period - PS Delivered

---

**Qualify Criterion** ?

\*Filter Type: Check TRC  
 \*Inclusion: in the list  
 \*TRC List: KUTRCVL1  Regular

---

**Explanation (this Criterion will result in an Alert when):**  
 Time reporter has one or more payable time entries in the list.

---

Payable time filter type is only Check TRC. Filter type for reported time is Quantity is not positive, Zero and Check TRC

## Alert Program Page

Use Alert Program Page (TL\_ALERT\_PGM) to define a set of alert rules which decides the set of people to be notified according to the met conditions.

Navigation:

**Set Up HCM > Product Related > Time and Labor > Alerts > Alert Programs**

This example illustrates the fields and controls on the Alert Programs page.

### Alert Programs

Alert Program ID KUGBI01

Alert Program Find First 1 of 1 Last

\*Effective Date  + -

\*Description  \*Short Description

Alert Rules <span style="float: right;">Personalize   Find      First 1-12 of 12 Last</span>				
*Alert Criterion ID	Description		*Notification ID	Description
<input type="text" value="KULVEBL"/>	Leave Balances less than 40Hrs		<input type="text" value="KULNTS"/>	Limits Notifn by Supervisor <span style="float: right;">+ -</span>
<input type="text" value="KUPTSRP"/>	Time Rejected by Payroll		<input type="text" value="KULNTS"/>	Limits Notifn by Supervisor <span style="float: right;">+ -</span>
<input type="text" value="KURTHOL"/>	Works more hrs after holiday		<input type="text" value="KULNTS"/>	Limits Notifn by Supervisor <span style="float: right;">+ -</span>
<input type="text" value="KURTLBB"/>	Reports Leave back to back		<input type="text" value="KULNTS"/>	Limits Notifn by Supervisor <span style="float: right;">+ -</span>
<input type="text" value="KURTLNH"/>	Reports Leave next to holiday		<input type="text" value="KULNTS"/>	Limits Notifn by Supervisor <span style="float: right;">+ -</span>
<input type="text" value="KURTLSF"/>	Reports Leave Frequently		<input type="text" value="KULNTS"/>	Limits Notifn by Supervisor <span style="float: right;">+ -</span>
<input type="text" value="KURTWWB"/>	Reports time without any break		<input type="text" value="KULNTS"/>	Limits Notifn by Supervisor <span style="float: right;">+ -</span>
<input type="text" value="KUUPDPT"/>	Unprocessed Payable Time		<input type="text" value="KULNTS"/>	Limits Notifn by Supervisor <span style="float: right;">+ -</span>
<input type="text" value="KUUPDRT"/>	Unprocessed Reported Time		<input type="text" value="KULNTS"/>	Limits Notifn by Supervisor <span style="float: right;">+ -</span>
<input type="text" value="KUWEHRS"/>	Works excessive hrs frequently		<input type="text" value="KULNTS"/>	Limits Notifn by Supervisor <span style="float: right;">+ -</span>
<input type="text" value="KUWPTEO"/>	OT limit exceeds 8Hrs/Wk		<input type="text" value="KULNTS"/>	Limits Notifn by Supervisor <span style="float: right;">+ -</span>
<input type="text" value="KUWRTEL"/>	Reported more than 40Hrs/Wk		<input type="text" value="KULNTS"/>	Limits Notifn by Supervisor <span style="float: right;">+ -</span>

Save
 Return to Search
 Notify
 Refresh
 Add
 Update/Display
 Include History
 Correct History

<b>Field or Control</b>	<b>Description</b>
<b>Alert Program</b>	An alert program defines a set of Alert Rules. It provides - at the rule level - the link up to identify the person(s) to alert when the conditions of the rule is met.

## Alert Notification Page

Use Alert Notification Page (TL\_ALERT\_NOTIFY) to decide whose details to be routed to whom.

Navigation:

**Set Up HCM > Product Related > Time and Labor > Alerts > Alert Notification**

This example illustrates the fields and controls on the Alert Notification page.

<b>Field or Control</b>	<b>Description</b>
<b>Alert Notification</b>	Specify a target audience for alerts, and how that audience should be notified. The routings are used when defining an alert program to control the recipients of each alert listed in that program. The Admin Role serves as a back-up assignment for when the selected user list fails to return any reviewer for a given alert.

## Value List Page

Use Value List Page (TL\_VAL\_LIST\_PNLGRP) to filter or select limited Time Reporting codes for processing alerts or reports.

Navigation:

**Set Up HCM > Product Related > Time and Labor > Alerts > Value Lists**

This example illustrates the fields and controls on the Value List page.

Value List is created for the following list type:

Absence Status, Absence Take, Attendance Violations, Benefit Plan, Company, Compensatory Time off Plan, Department, Employee Status, Employee Type, Exception, Grade, Job code, Payable Status,



Paygroup, Position Number, Punch Type, Reported status, Severity, Shift, Step, TCD Group, Task Group, Time Reporting Codes, Union Code, Work Group.

## Process Alerts Page

Use Process Alert page (TL\_ALERTS\_PROCESS) to execute the data checking at a given time and frequency.

Navigation:

**Set Up HCM > Product Related > Time and Labor > Alerts > Process Alert**

Alert processing is done by managers and Time and Labor Administrators.

This example illustrates the fields and controls on the Process Alert page.

<b>Field or Control</b>	<b>Description</b>
<b>Process Parameters</b>	Select the time frame to be covered and the alert programs to be run. The Current Period option will cover the current period (according to each time reporters Workgroup setting). The process will dynamically determine the current period based on the date when the process is run.
<b>Alerts Programs</b>	Grid label on the Process Alerts page.

There are two modes for running a selection of alerts:

- *Run control Current Period option:* This covers the current period according to each time reporters' workgroup setting. The process determines the current period based on the date when the process is run
- *Run Control From and To dates specified*
  - In this case ONLY Alert criteria time period will be considered. . The process compares the time and labor calendar in sync with this period specified in the Alert criteria (other than NONE).
  - For NONE- purely from and to dates will be considered.

- Alert process allows mapping of the same program against more than one group or subject the same group to more than one program.

## Administer Alerts Page

Use Administer Alerts Page (TL\_VAL\_LIST\_PNLGRP) to update the alerts.

Navigation:

**Main Menu > Time and Labor > Alerts > Administer Alerts**

This example illustrates the fields and controls on the Administer Alert page.

The screenshot shows the 'Administer Alerts' page with a search filter section titled 'Alert Selection'. The filters include:

- From Date:  [B]
- Through Date:  [B]
- Alert Type:
- \*Alert Status:  (dropdown menu open showing: Complete, Open, Removed by Administrator, Reviewed)
- Source:
- Recipient:  [M]

There are 'Search' and 'Clear' buttons at the bottom right of the filter section.

The administrator's involvement is different from that of the manager. It serves two main purposes:

- Complete; Completed alerts by the administrator.
- Open; All open alerts
- Removed by Administrator; outdated, created from a poorly defined criterion or any other reason. This is generally about rectifying mistakes and getting rid of outdated entries
- Reviewed; perhaps specifically those sent to the administrator as a default recipient when the user list failed to identify anyone else. There are no restrictions to which the administrator can re-direct an alert.

---

## Locking Timesheets

This section discusses how to freeze or lockdown timesheets using multiple methods.

### Methods Used for Locking Timesheets

There two ways to lockdown timesheets, one using the Timesheet Lockdown page which is based on the Time and Labor lockdown and the other is using Component Lockdown Framework.

## Page Used to Lockdown Timesheets

<i>Page Name</i>	<i>Definition Name</i>	<i>Usage</i>
<a href="#">Timesheet Lockdown Page</a>	TL_TS_LOCKDOWN	Freeze current and submitted timesheets for one or more paygroups using Time and Labor Lockdown.
<a href="#">HCM Lockdown Framework</a>	HCSC_CLK_COMP_ELIG	Allows users to lockdown timesheets and multiple time reporting components from one location.

## Timesheet Lockdown Page

Use the Timesheet Lockdown page (TL\_TS\_LOCKDOWN) to lock current timesheets and timesheets that have been submitted, based on Pay Groups.

Navigation:

**Time and Labor > Report Time > Timesheet Lockdown**

This example illustrates the fields and controls on the Timesheet Lockdown page. You can find definitions for the fields and controls later on this page.

**Timesheet Lockdown**

**Lock All**

Prior Periods
Current and Prior Periods

Unlock All Periods

**Currently Active Pay Groups** ?

🔍
1-5 of 2208
View 100

Lock Prior Periods	Lock Current and Prior Periods	Company	Pay Group	Description	Payroll System
<input type="checkbox"/>	<input type="checkbox"/>	K1A	G1A	PayGroup G1A	Payroll for North America
<input type="checkbox"/>	<input type="checkbox"/>	K1B	G1B	PayGroup G1B	Payroll for North America
<input type="checkbox"/>	<input type="checkbox"/>	K1C	G1C	PayGroup G1C	Payroll for North America
<input type="checkbox"/>	<input type="checkbox"/>	K1D	G1D	PayGroup G1D	Payroll for North America
<input type="checkbox"/>	<input type="checkbox"/>	K1E	G1E	PayGroup G1E	Payroll for North America

**Note:** Only the Time Administrator role can access the Timesheet Lockdown page. Locked timesheets display a message at the top of the timesheet indicating why the timesheet is display only. The Time Administrator role also retains the ability to access timesheets that are locked through the Manager Self Service pages to deal with exceptions.

The following video provides an overview of Current Pay Period Timesheet Lockdown:

Video: [Image Highlights, PeopleSoft HCM Update Image 32: Current Pay Period Timesheet Lockdown](#)

## Lock All

<i>Field or Control</i>	<i>Description</i>
<b>Prior Periods</b>	Select the <b>Prior Periods</b> button to lock the submitted timesheets for all of the listed paygroups. This will prevent other users from making any changes to the timesheets that have been submitted.
<b>Current and Prior Periods</b>	Select the <b>Current and Prior Periods</b> button to lock the current timesheets and submitted timesheets for all of the listed paygroups. This will prevent other users from making any changes to the current time sheets and the timesheets that have been submitted.
<b>Unlock All Periods</b>	Select the <b>Unlock All</b> button to unlock all the locked timesheets for the listed paygroups.

## Currently Active Pay Groups

<i>Field or Control</i>	<i>Description</i>
<b>Lock Prior Periods</b>	Select the checkbox to lock the submitted timesheets for a paygroup.
<b>Lock Current and Prior Periods</b>	Select the checkbox to lock the current timesheets and submitted timesheets for a paygroup.

## HCM Lockdown Framework

Use the HCM Lockdown Framework to lock timesheets and all other time reporting components using the Lockdown Framework Setup page (HCSC\_CLK\_COMP\_ELIG).

The HCM Lockdown Framework delivered by Global Payroll in HCM Image 46 is now updated to manage the lockdown of all time reporting components from one location. For more information about HCM Lockdown Framework, see the “Configuring HCM Lockdown Framework” (Application Fundamentals) topic.

---

**Note:** Once you have adopted the HCM Lockdown Framework, you can use it to freeze or lock all time reporting components and it overrides the lockdown using the [Timesheet Lockdown Page](#).

---

# Integrating with Payroll Applications

---

## Overview of Payroll Integration

Time and Labor transmits the payable time created by the Time Administration process to a payroll application, such as Payroll for North America or Global Payroll. The payroll application compensates time reporters for their payable time and—at the end of the pay run—sends labor-related costs back to Time and Labor, where they are distributed across payable time and made available to Project Costing and other applications.

Before using your payroll system to pay employees for time reported in Time and Labor, you must integrate your systems. This entails:

- Mapping time reporting codes (TRCs) to your payroll system's earnings codes.
- Selecting settings on various pages within Time and Labor, your payroll system, and PeopleSoft Human Resources.

Configuration requirements vary by payroll system and are described later in this section.

After the setup is complete, payroll personnel can include payable time, created by the Time Administration process, in pay runs. Depending on how you configure Time and Labor, payroll personnel can distribute the resulting costs back to payable time for other products to use. This section discusses the relationship between payable time created in Time and Labor, your payroll application, and other applications that can use cost data.

---

**Note:** Payable time is available to third-party applications; however, PeopleSoft does not deliver a process for publishing to third-party applications.

---

See also: [Understanding Payable Time](#)

## General Procedure for Running a Payroll with Payable Time

Procedures for including payable time in pay runs vary by payroll system; however, the general steps that apply to both Payroll for North America and Global Payroll are as follows:

1. In Time and Labor, a user runs the Time Administration process to create payable time for the workgroups with time reporters to pay.
2. In the payroll system, a user sets up the calendars and run IDs for the payroll process.

The payroll system defines who is to be paid and for what period of time. This information is used to select employees in the pay group who have been active at any time during the pay period.

3. Payable time entries are selected from Time and Labor and sent to the payroll system.

The first time this occurs, all payable time that meets the selection criteria is sent. After that, only payable time that has been added or changed is selected, including adjustments to the current period and prior periods.

4. The payroll system summarizes the payable time entries.

Summarization consists primarily of totaling reported hours, units, or amounts at the earnings code or task code level. Each payroll system has its own rules for summarizing data. Pay calculations are run and the payroll cycle is completed.

5. The payroll system sends cost data generated by the pay run back to Time and Labor.
6. The Labor Distribution and Dilution processes are invoked in Time and Labor if you have selected these features.
  - The Labor Distribution process attaches the costs calculated by your payroll system to the corresponding payable time entries in Time and Labor.
  - The Labor Dilution process averages the calculated costs and evenly distributes them across the payable time entries.

The payable status associated with each entry of payable time is updated throughout the various stages of processing. You can view payable status on the View Payable Time Detail page of the Time and Labor self-service component.

This diagram illustrates the process flow when Time and Labor is integrated with a payroll application

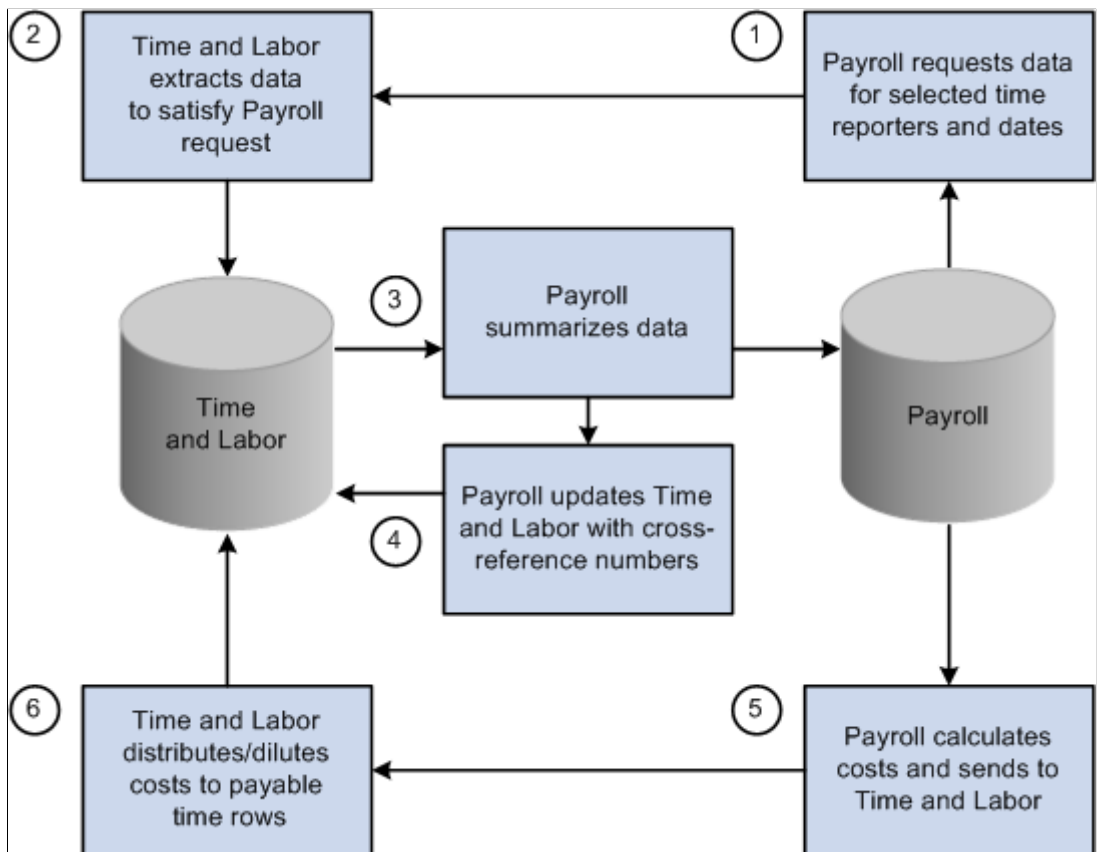

## Related Links

[Understanding Payable Time](#)

[Understanding Self-Service Components](#)

[Understanding Manager Self-Service Components](#)

## Labor Distribution and Dilution

After a pay run is complete, payroll costs associated with time that originated in Time and Labor can be extracted from the payroll system and distributed across payable time entries. The updated time detail can then be published to other applications for additional processing.

Allocating costs back to payable time is *labor distribution*. Labor distribution is an optional feature of Time and Labor that you can select on the Pay System page. Select one of two options.

- Labor distribution only.

This option enables you to allocate payroll costs back to the tasks for which payable time was originally reported, provided you defined the TRC as eligible for distribution. If you are not tracking time at the task level, costs are allocated to the TRCs to which time was reported.

- Labor distribution and dilution.

If you select this option, the Dilution process is triggered automatically at the end of the Labor Distribution process. The system reallocates labor-distributed costs for a given day, so that payroll costs are evenly distributed over payable time entries for *hourly* TRCs flagged as eligible for dilution. If a time reporter is paid at different rates or—in the case of salaried workers—is not explicitly paid for overtime, Time and Labor can calculate an average hourly (diluted) amount and apply it evenly across all hours reported for the day.

### Example: Effect of Labor Distribution With and Without Dilution

Assume the following time entries:

<i>Date</i>	<i>Hours</i>	<i>TRC</i>	<i>Project</i>
1 Feb	5	REG	A
1 Feb	4	REG	B
1 Feb	3	REG	C

Suppose the Time Administration process applies a rule that converts hours in excess of 8 per day to overtime. The results of the rule are shown as follows.

<i>Date</i>	<i>Hours</i>	<i>TRC</i>	<i>Project</i>
1 Feb	5	REG	A

<i>Date</i>	<i>Hours</i>	<i>TRC</i>	<i>Project</i>
1 Feb	3	REG	B
1 Feb	1	OT	B
1 Feb	3	OT	C

When you run the payroll process, it consolidates the entries resulting in 8 hours of regular time and 4 hours of overtime. Regular time is paid a rate of 10.00 USD per hour; overtime is paid a rate of 19.00 USD per hour. Payroll sends the costs back to Time and Labor, which distributes the costs across the payable time entries as follows:

<i>Date</i>	<i>Hours</i>	<i>Rate</i>	<i>TRC</i>	<i>Project</i>	<i>Cost</i>
1 Feb	5	10	REG	A	50
1 Feb	3	10	REG	B	30
1 Feb	1	19	OT	B	19
1 Feb	3	19	OT	C	57
TOTAL	12				156

The cost for project A is lower than the cost for project C, even though more hours were worked for project A. This is not equitable, given that the time reporter could have worked on the projects in any order.

The Labor Dilution process distributes costs more evenly. It divides the total cost of 156 by 12 (the total number of reported hours) to come up with a rate of 13. It then applies the same rate to all entries, as shown in the following table.

<i>Date</i>	<i>Hours</i>	<i>Rate</i>	<i>TRC</i>	<i>Project</i>	<i>Diluted Cost</i>
1 Feb	5	13	REG	A	65
1 Feb	3	13	REG	B	39
1 Feb	1	13	OT	B	13
1 Feb	3	13	OT	C	39



<i>Date</i>	<i>Hours</i>	<i>Rate</i>	<i>TRC</i>	<i>Project</i>	<i>Diluted Cost</i>
TOTAL	12				156

Now project A reflects a diluted cost that is proportionate to the number of hours worked.

## Labor Distribution Rules

Labor distribution rules are:

- The Labor Distribution process allocates costs back to payable time entries according to the level of detail supported by the payroll system.

The criteria that the payroll system uses to consolidate payable time entries determines the level of detail.

- When all TRCs participating in labor distribution are of the same type (amount, units, or hours), costs are allocated evenly, based on the reported values.

When one or more TRCs are defined with an amount type, the Labor Distribution process:

- Allocates the amounts that were originally reported back to TRCs with an amount type.
- Allocates the remaining costs across TRCs with a type of hours or units.

- When payable time status is set to *Closed* and the associated reason code is Not Distributed (NDS), (that is, it will not be sent to a payroll system or will not participate in labor distribution), the estimated gross amount (Est\_Gross) populates both the labor distribution amount field (Lbr\_Dist\_Amt) and the diluted labor distribution amount field (Diluted\_Gross).

In addition, the currency code (Currency\_Cd) used to calculate estimated gross populates the currency code used for the labor-distributed and labor-diluted amounts (Currency\_Cd2).

- Record-only adjustments are not sent to payroll for processing, thus they are not included in the Labor Distribution process.

You can manually update the labor distribution and labor dilution amount through the Adjust Paid Time page.

## Related Links

[Understanding Payable Time](#)

---

## Integrating Time and Labor and Payroll for North America

This section provides an overview of integrating Time and Labor and Payroll for North America, and discusses how to:

- Configure Time and Labor for use with Payroll for North America.
- Prepare Time and Labor data for Payroll for North America.

- Load Time and Labor data.
- Run the payroll process.
- Reverse or adjust a paycheck.
- Extract costs after a pay run.
- Adjust payable time.
- Refresh data.
- Correct errors generated during the load and extract processes.

## Processing Overview

This section describes the steps involved in preparing for and running a payroll when Time and Labor is integrated with Payroll for North America.

To prepare for and run the payroll:

1. Configure Time and Labor for use with Payroll for North America.
2. Run the Time Administration process in Time and Labor to create payable time for the time reporters to be paid.
3. Load payable time created by the Time Administration process into Payroll for North America.
4. Run the payroll process and confirm the pay run.
5. Extract data from payroll and send to Time and Labor.

The Extract process triggers the Labor Distribution and Labor Dilution processes if you've enabled these features in Time and Labor.

Steps 1 and 2 are the steps you perform in Time and Labor. The other interactions are initiated through Payroll for North America.

## Configuring Time and Labor for Use with Payroll for North America

Before you can use Time and Labor with Payroll for North America, you must configure both systems appropriately. You must also select options on the Installation table and set up employee job data in the Administer Workforce business process of PeopleSoft Human Resources.

This section discusses how to:

- Configure Time and Labor.
- Configure Human Resources.
- Configure the Installation table.

### Configuring Time and Labor

To configure Time and Labor for integration with Payroll for North America:

1. On the Pay System page, select the distribution features to use for Payroll for North America.

By default, Labor Distribution is selected and Labor Dilution is not.

See [Payroll System Options](#).

2. On the Time Reporting Codes - Definition page, map each time reporting code to the appropriate earnings code defined in Payroll for North America.

If you want the TRC to be eligible for labor distribution, select the Distribute Costs option. If you want an hourly TRC to be eligible for labor dilution, select the Used in Labor Dilution option.

If a TRC is set up for labor distribution or dilution, but Labor Distribution or Labor Dilution is not enabled on the Pay System page, distribution and dilution don't occur.

---

**Note:** We recommend that you use the Sync (synchronize) feature on the TRC Setup 1 page to synchronize time reporting codes with the earnings codes defined in Payroll for North America.

---

See [Defining and Mapping Time Reporting Codes \(TRCs\)](#).

3. On the Create Time Reporter Data page or the Maintain Time Reporter Data page, select the Send Time to Payroll option for each employee.

Payroll for North America does not create paysheets for non-employees.

See [Entering and Maintaining Time Reporter Data](#).

4. On the TL Installation page, select the appropriate settings in the TL/ NA Payroll Options group box.

See [Setting Up System Defaults and Loading Dates](#).

## Configuring Human Resources

To configure PeopleSoft Human Resources for integration of Time and Labor with Payroll for North America:

1. For each employee, ensure the Payroll System field on the Job Data - Payroll page is set to *Payroll for North America*.
2. Set the Employee Type field on the Job Data - Payroll page to *E* (exception hourly) or *H* (hourly).

If the Employee Type field on the Job Data - Payroll Page is set to *S* (salaried), any hours mapped to the default REG earnings code aren't loaded to paysheets. However, costs are labor-distributed across these hours if the Distribute Costs option is selected for the TRC. Select *E* or *H*. This enables the system to send updated costs for prior period adjustments to payroll and your general ledger application. If you set up employees with *S*, Time and Labor populates the labor distribution amount and the diluted gross amount with an estimated gross for these entries. These entries are available as actual costs to publish to Project Costing, but don't flow through Payroll for North America to your general ledger application.

See “Payroll Page” (PeopleSoft Human Resources Administer Workforce).

## Configuring the Installation Table

Select the Time and Labor and Payroll for North America paysheet options on the Product Specific page of the Installation Table component (INSTALLATION\_TBL).

Use this information to determine your settings:

- **Change Final Check, Change Online Check, or Change Reversal Adjustments** options.

We recommend that you do not select these options because they control whether users can make paysheet changes to data that is retrieved from Time and Labor. If you select these options, any changes made directly to the paysheets aren't transmitted back to Time and Labor.

- **Load in Preliminary Calc** (load in preliminary calculations) option.

The Pay Calculation process uses the value of the **Load in Preliminary Calc** field to determine whether to load new available time (additional time that was worked before the job change but not previously entered on paysheets):

- If you select this check box, the system loads all valid available time to the new paysheets, including new available time.
- If you clear this check box, the process does not load any new available time to paysheets.

---

**Note:** If an employee had a Job data change that caused paysheets to be rebuilt, the preliminary Pay Calculation process attempts to reload all valid time and rejects time that is no longer valid as a result of the job change. This is true regardless of the setting of the **Load in Preliminary Calc** field. As a result, some new time might be loaded for employees who had a Job data change, even when this option is not selected on the Installation table.

---

### Related Links

“Setting Up Implementation Defaults” (Application Fundamentals)

“Setting Up the Interface with Time and Labor” (PeopleSoft Payroll for North America)

## Preparing Time and Labor Data for Payroll for North America

Before a payroll user starts the payroll process, you must run the Time Administration process for the population of time reporters to be paid.

---

**Note:** Payroll for North America uses pay groups to define the population of employees to be paid. Before a pay run, verify that the Time Administration process has run for all members of the pay groups to be paid.

---

### Related Links

[Launching the Time Administration Process](#)

## Loading Time and Labor Data

These processes, run from Payroll for North America, load payable time for payroll processing:

- Time and Labor/Payroll Update COBOL SQL process (PSPLDTL1).
- Pay Calculation process.
- Final check.
- Online check.

If your payroll department prepares paysheets several days before the preliminary pay run, you may want to run the Time and Labor/Payroll Update process directly to retrieve payable time at the beginning of the process. Payable time created or changed after this point can be quickly loaded into the paysheets when you run the preliminary Pay Calculation process.

The load processing performs several steps:

- Selects payable time entries in Time and Labor.
- Passes payable time entries to payroll.
- Consolidates payable time entries.
- Updates paysheets or creates new paysheets if none exist.

Time and Labor selects the payable time; Payroll for North America does the rest.

### Selecting Payable Time

Time and Labor retrieves payable time that meets the criteria defined by the pay run ID, pay calendars, and other selection criteria specified in the Time and Labor/Payroll Update process run control parameters in Payroll for North America. For each calendar, Time and Labor selects all payable time that meets the selection criteria, excluding record-only adjustments, up to the pay end date for all time reporters associated with the calendar.

A payroll user initiates the Time and Labor/Payroll Update process from the Load Time and Labor component (PY\_LDTL\_RC), specifying the pay run ID, additional filtering criteria, and identifying which data should be loaded to separate checks. Based on the options selected in this component, the process selects appropriate payable time from Time and Labor records.

For Time and Labor to load payable time into Payroll for North America, the following criteria must also be met:

- The payable status of the payable time entry must be set to one of the following:
  - *ES* (Estimated – Ready for Payroll)
  - *AP* (Approved – Goes to Payroll)
  - *SP* (Sent to Payroll)
  - *RP* (Rejected by Payroll)
  - *TP\** (Taken-Used by Payroll)
  - *PD\** (Paid – Labor Distributed)
  - *DL\** (Paid – Labor Diluted)

- *CL\** (Closed)

\* Entries with a payable status of *TP*, *PD*, *DL*, or *CL* are selected only if you choose the Refresh Request option when initiating the load process, or if the Payroll Request Number has been reset to 0 because of a payroll unsheet. Time and Labor loads payable time for closed entries if the Pay System flag is set to *NA*. Closed entries are first set to *RP* by the refresh request and are then reselected. Refresh requests should be used only when payable time data has become corrupted or lost.

- *RV* (Reversed)

The Reversed payable time status exists to handle check reversals in Payroll for North America. The Payroll for North America Reversal process generates payable time rows with this status. Time and Labor generates the reversed payable time row and any new payable time to be loaded in a subsequent Load process. This process occurs after Payroll for North America has successfully completed the Confirm Pay process.

The process of generating an additional row to be loaded in a subsequent Load process depends on the option selected in the Reversal process from Payroll for North America.

See “Reverse Time and Labor Page” (PeopleSoft Payroll for North America).

---

**Note:** Time with a payable status of *NA* (needs approval) is never selected.

---

- The employee who reported the time has been set up for payroll processing.
- The time reporting code associated with the payable time has been mapped to an active earnings code.
- The currency used in Time and Labor matches the currency defined for the pay group in Payroll for North America when the reported quantity is an amount.

## How Payroll for North America Updates Selected Payable Time Records

Payroll for North America updates each payable time entry for the selected time reporters.

For payable time entries loaded into Payroll for North America, the system:

- Sets payable status to *SP* for payable time entries that have a payable status of *ES*, *AP*, or *RP*.

If the entry has already been labor-distributed or labor-diluted, it retains its current payable status of *PD* or *DL*. If the entry currently has a payable status of *CL*, but is not subject to labor distribution, it retains its current status.

- Sets the TL Pay System indicator to *NA Payroll for North America*.
- Sets the payroll request number to the appropriate payroll request.

The system-generated request number is important if payroll clerks need to refresh or reload data later.

For payable time entries not accepted by Payroll for North America, Time and Labor sets the payable status to *RP*.

---

**Note:** You can see the payable status for a selected time reporter's payable time entries on the View Payable Time Details page.

---

## Consolidating Payable Time and Creating Paysheets

Paysheets are the pages and tables that contain all current payroll information—earnings, deductions, hours, taxes, and other accounting data—for the specified employees and pay period. When the Time and Labor/Payroll Update process loads payable time entries into Payroll for North America, it summarizes the entries according to the application's consolidation rules. Use the Pay Group Table - Time and Labor page in Payroll for North America to instruct the system to create separate rows on the paysheets for payable time entries that have the same Account code, Business Unit, Department, Job Code, Locality, Position Number, Project Costing Business Unit, Project ID, Activity ID, or State.

---

**Note:** If Time and Labor passes an override rate to Payroll for North America, and a rate already exists on the earnings code definition, the rate on the earnings code definition takes precedence. If Time and Labor passes an amount, and the earnings code has a flat amount value defined on a flat amount earnings type, the flat amount on the earnings code takes precedence.

---

Payroll for North America keeps track of how it consolidates payable time and tracks the combined entries by passing back a payroll cross-reference (XREF) number to Time and Labor for each Time and Labor sequence number. At the same time, the system:

- Updates entries with a payable status of *SP* to *TP*, *RP*, or *CL* if labor distribution is not enabled.  
When payable status is set to *CL*, actual costs can be published to PeopleSoft Financials.
- Sets the Frozen Flag to *Yes*, and sets the **Frozen Date** field to the pay period end date of the associated pay calendar.

After consolidating entries, Payroll for North America automatically creates paysheets—the tables and pages that summarize all payment data. If current paysheets have already been created for any of the time reporters, the payroll process updates the existing paysheets, rather than creating new ones.

### Related Links

[Understanding Payable Time](#)

[Integrating Time and Labor and Payroll for North America](#)

[Refreshing Data](#)

“Understanding Pay Groups” (PeopleSoft Payroll for North America)

“Understanding the Interface with Time and Labor” (PeopleSoft Payroll for North America)

## Running the Payroll Process

After creating paysheets, a payroll user runs the Pay Calculation and the Pay Confirmation processes as usual.

Depending on the options selected on the Installation Table - Product Specific page, any payable time that has not been sent to payroll before may be automatically loaded when the preliminary Pay Calculation process begins. This includes data that has been updated, such as data for employees who have had a job change.

## Unsheeting a Pay Run

When a pay run is unsheeted, Payroll for North America changes the payable status of Time and Labor entries from *Taken – Used by Payroll (TP)* to *Rejected by Payroll (RP)* with the reason code *Cancelled*, and resets the payroll request number to 0. Entries with a payable status of *Distributed (PD)* or *Diluted (DL)* retain their payable status, but the payroll request number is set to 0. Resetting the payroll request number enables Payroll for North America to reselect the time. (Only time that has a payroll request number of 0 is selected.)

## Reversing or Adjusting a Paycheck

Payroll for North America check reversals enable you to track reversed time in Payable Time, or repay time in a new check. Check reversals can be done in the same pay cycle or different pay cycle and can be done before or after the Extract Cost process.

The way in which Time and Labor and Payroll for North America handle paycheck reversals and adjustments depends on the selections you make on the Paycheck Reversal/Adjustment page in Payroll for North America. This page contains two options in the Process Request Parameter(s) group box. These options are available on the page if payable time exists in the paycheck with any of these statuses: Taken – Used by Payroll (TP), Distributed (PD), Diluted (D), and Closed (CL). The options are:

- **Reversal** – generates a new row in Payable Time with the status of Check Reversal (RV).
- **Reversal/Adjustment** – generates a new row in Payable Time with the payable status of Check Reversal (RV) and an additional row to be loaded for future payment. The payable status of the additional row is Estimated – Ready for Payroll (ES).

---

**Note:** Payable Time with the Check Reversal status is not displayed on the Adjust Paid Time page in Time and Labor.

---

The process that creates the offset and new rows in Payable Time is triggered after the Pay Confirmation process completes successfully. This ensures that check reversal is confirmed and not unsheeted. If an Unconfirm occurs in Payroll for North America, followed by deletion of a check reversal, Time and Labor removes the reversed and new rows in Payable Time.

The rows with a payable status of Check Reversal (RV) that are created in Payable Time are published to Project Costing to keep track of reversed time. This occurs when the Extract Costs process is run, or when the Time and Labor Pay Reversal process is triggered after the Pay Confirm process.

See “Reversing Paychecks” (PeopleSoft Payroll for North America).

### Related Links

“Reverse Time and Labor Page” (PeopleSoft Payroll for North America)

## Extracting Costs After a Pay Run

After loading payable time into Payroll for North America and running and confirming the payroll calculation process, Payroll for North America initiates the Extract Time and Labor Costs Application Engine process (PY\_PULL\_COST) to extract cost data that was generated through:

- On-cycle and off-cycle pay runs.



- Final check.
- Online check.

## What the Extract Process Does

The Extract process updates the payable time entries in Time and Labor as follows:

- If the payable time is distributed, but not diluted, the Extract process changes the payable status to *Distributed (PD)*.
- If the payable time is distributed and diluted, the Extract process changes the status to *Diluted (DL)*.

---

**Note:** For time that is not being distributed, the Load Time and Labor process sets the payable time status to *Closed (CL)*.

---

- Provides the cross-reference (XREF) numbers generated during the consolidation process, the calculated costs, and percentages that represent how payroll consolidated the payable time rows.

The system uses percentages when the consolidation process is not clean.

- Triggers the Labor Distribution and Labor Dilution processes in Time and Labor, if applicable.
- Sets the publish date and publish switch.

---

**Note:** If Payable Time is pulled into paysheets, and **Ok to Pay** is cleared for those related earnings, these rows of payable time are not paid.

---

See [Time and Labor Installation Page](#).

## Example: Percentages Returned by the Extract Process

Of a time reporter's total hours, 75 percent are subject to New York state tax and 25 percent are subject to Connecticut state tax. In this case, the consolidation process creates two pay earnings rows for the individual—one for each state. The Extract process would return the percentages along with the resulting costs, so Time and Labor can distribute the costs during the Labor Distribution process.

## Distributing and Diluting Costs

Costs are always distributed across payable time for the current period, prior period adjustments, and advance payments. You can view distributed and diluted costs on the Payable Time Detail page in the Time and Labor self service transactions.

If the pay calendar is on-cycle, then on-cycle earnings can only be distributed once; off-cycle earnings can be distributed multiple times. If the Pay Calendar is off-cycle, then its off-cycle earnings can only be distributed once. The system overlays existing labor distribution amounts with new amounts. This iterative processing makes it possible to redistribute earnings after modifying or adjusting pay-related information. Subsequent runs create offsets for existing paid time entries.

If Project Costing is installed, actual payable time entries that are closed, diluted, or distributed are published automatically to Project Costing after running the extract job.

## Labor Distribution with Paycheck Reversals

For a discussion of labor distribution and paycheck reversals:

See [Publishing Estimated and Actual Cost Data to Project Costing](#).

## Adjusting Payable Time

This section discusses the adjustment of payable time.

### Normal Adjustments

Normal adjustments to payable time are changes or additions to payable time using any of the time reporting pages. If you make normal adjustments after loading payable time into Payroll for North America, run the Time Administration process again so that the changes are sent to Payroll for North America during the next load process.

If you enter an adjustment after the Frozen flag is set (that is, once the payable status is set to *AP*, *CL*, or *SP*), and the Time Administration process finds an existing entry that has the same time reporting code and task information as your adjusting entry, it creates a new row of payable time and a row that offsets the original entry. Both the new and offsetting rows are sent to Payroll for North America when you next load payable time.

### Record-Only Adjustments

Record-only adjustments entered on the Record Only Adjustment page are not sent to Payroll for North America; however, they can affect the results of the Labor Distribution process and the costs that are published to Project Costing.

- If you run the Labor Distribution process, make a record adjustment to a payable time record that's already been distributed, and then rerun Labor Distribution, no cost is distributed for the adjusted record.

An error message will display the sequence number of the payable time entry that isn't redistributed.

- If you make a record-only adjustment to an entry that was previously sent to Payroll for North America, the labor distribution amount and diluted labor distribution amount are copied to both the offset row and the new row.

You can alter the values for labor distribution and labor dilution on the new row, if needed. The amounts associated with the new row are the amounts that will be published to Project Costing.

- If you insert a new row on the Record Only Adjustment page (rather than correct an existing row), you can enter values in both the Labor Distribution Amount and Diluted Labor Distribution Amount fields.
- If you do not enter a value in the Diluted Labor Distribution Amount field, a zero amount will be published to Project Costing as the actual diluted labor distribution amount when the payable status changes to *CL*.

### Related Links

[Understanding Manager Self-Service Components](#)

[Understanding Integration](#)

## Refreshing Data

A Refresh Request option in Payroll for North America enables users to reselect all payable time passed to payroll during the original load process. This includes current data, prior period adjustments, and any new payable time entries where the payable status is set to *ES*, *CL*, *SP*, or *RP*. This feature enables a user to recapture lost data, and should be used only as a recovery measure.

---

**Warning!** Refresh requests have a significant impact on system performance and should be used only when time has been corrupted or lost and you need to reload all time associated with a particular Payroll Request Number.

---

### Related Links

“Understanding Integration with PeopleSoft HR and Expenses” (PeopleSoft Payroll for North America)

## Correcting Errors Generated During the Load and Extract Processes

This section discusses the correction of errors generated during the Load and Extract processes. The Review Time and Labor Load component enables you to identify and view load messages by employee.

See “Reviewing Results and Correcting Errors” (PeopleSoft Payroll for North America).

### Load Process Errors

Payroll personnel are advised to review the paysheets and check for error messages created during processing. During the Load Time and Labor process, payable time can trigger the processing errors listed in the following table. In all cases, the payroll system changes the payable time status to *RP*. Correct the error, run the Time Administration process again, if necessary, and advise the payroll clerk to rerun the Load Time and Labor process.

<b>Error</b>	<b>Action</b>
Invalid Mapping of TRC to NA Earnings Code	Correct the mapping on the TRC page. It's possible the earnings code was inactivated after it was mapped to the TRC.
Invalid Currency of TRC for the NA Pay Group	Correct the currency on the TRC page. Time and Labor does not perform any currency conversion.

Other reasons that payable time can be rejected are:

- A time reporter is not active in JOB.
- A time reporter has changed pay groups in the pay period that is being processed.
- The TRC in payable time is mapped to an earnings code in Payroll for North America that is not in the time reporter's earnings program.
- You run PayUnsheet and all payable time is set to a payable status of *Rejected*.
- Reported state and locality overrides are not found in the Employee Tax Data tables.

---

**Note:** Depending on the Installation table options selected, payroll users may be able to modify paysheet data that originated in Time and Labor when producing a final check, online check, or doing reversal adjustments. However, because changes made on the payroll pages will not be reflected in Time and Labor, we recommend that you make all corrections in Time and Labor.

---

### Extract Process Errors

<i>Error</i>	<i>Action</i>
Multiple currencies cannot be distributed.	Depending on the source of the error, adjust the currency for the reported time in Time and Labor or change the currency for the entry in Payroll for North America.

### Related Links

“Reviewing Results and Correcting Errors” (PeopleSoft Payroll for North America)

---

## Integrating Time and Labor with Global Payroll

The Global Payroll core application handles both payroll and absence processing.

See “Global Payroll Features” (PeopleSoft Global Payroll).

This section provides an overview of integrating Time and Labor and Global Payroll and discusses how to:

- Configure Time and Labor for Integration with Global Payroll.
- Load Time and Labor data.
- Correct errors generated by Payable Time.
- Update Payable Time after a pay run.
- Share work schedules with Global Payroll.
- Integrate absence event data.

## Processing Overview

The steps involved in preparing for and running a payroll when Time and Labor is integrated with Global Payroll are listed as follows.

To prepare for and run the payroll:

1. Prepare the time and labor data by running the Time Administration process for the time reporters to be paid.

Global Payroll uses pay groups to define the population of employees to be paid, while the Time Administration process uses work groups to generate payable time. Be sure to run the Time

Administration process for all work groups that include the time reporters in the pay groups that will be selected for payment.

2. Run the payroll process.

This automatically loads payable time from Time and Labor. Global Payroll retrieves the appropriate set of payable time from Time and Labor at the beginning of the process. The first time the payroll process runs, Global Payroll processes all employees identified in the current calendars. During subsequent runs, Global Payroll processes only those payees in error or with changes.

3. Finalize the pay run.

4. Run the Time and Labor process to distribute payroll costs to payable time rows in Time and Labor.

You can run both Labor Distribution and Labor Dilution if these features are enabled based on the settings on Time and Labor's Pay System page.

Perform step 1 in Time and Labor. All other interactions are initiated through Global Payroll.

See “Running a Payroll with Time and Labor Data” (PeopleSoft Global Payroll).

## Planning Considerations

While Global Payroll and Time and Labor are designed to integrate seamlessly, both are rules-based systems capable of executing some of the same types of rules. Before integrating the two products, think carefully about which rules you want each system to apply. In general, you should define all rules that calculate *payable time*, including rules for overtime, shift differentials, and other special situations in Time and Labor. Create rules that calculate *pay* in Global Payroll.

## Related Links

“Planning Considerations” (PeopleSoft Global Payroll)

## Configuring Time and Labor for Integration with Global Payroll

This section discusses how to:

- Configure Time and Labor.
- Configure Human Resources.

### Configuring Time and Labor

Decide on a strategy for mapping time reporting codes to earnings elements. Consider the following options:

- Define one earnings element that accumulates to gross.

This is the earnings element the payroll process uses to calculate a payee's pay slip. Do not map this element to a TRC.

- Define a second earnings element that does not contribute to gross pay.

This earnings element is used for costing purposes only and, in addition to the payee's salary, can include overhead costs or any other costs (such as an employer-paid health insurance premium). You

map this element to a TRC so that accurate cost data can be sent back to Time and Labor and made available to cost accounting, planning, or budgeting applications.

Time from Time and Labor can be reported in hours, units or amounts, based on TRC type. When mapping TRCs to earnings elements, consider how the TRC type corresponds to the calculation rule defined for the element.

To set up Time and Labor:

1. For each type of payable time to send to Global Payroll, map the TRC to the appropriate earnings, deduction, or absence Take element defined in Global Payroll.

Use the TRC 1 page to map TRCs to elements. The system selects the Send to Payroll option on the TRC Setup page when you map a TRC to an element.

2. Select the desired distribution options for Global Payroll on the Pay System page.

By default, Labor Distribution is selected and Labor Dilution is not. The Labor Distribution option enables Global Payroll to send costs generated by a pay run back to Time and Labor so that Time and Labor can distribute the costs across the original payable time entries. The dilution feature is an extension of the distribution process. It enables Time and Labor to evenly distribute payroll costs across payable time.

3. On the Create Time Reporter Data page or the Maintain Time Reporter Data page, select the Send Time to Payroll option for each time reporter.

## Configuring Human Resources

To set up PeopleSoft Human Resources:

1. For each time reporter, verify that the Payroll System field on the Payroll page is set to *Global Payroll*.
2. Repeat step 1 for non-employees if you want to send their payable time to the payroll system.

## Related Links

[Understanding Time Reporting Codes](#)

[Payroll System Options](#)

[Entering and Maintaining Time Reporter Data](#)

[Understanding Integration](#)

## Loading Time and Labor Data

Payroll personnel use the Payroll/Absence Run Control page to initiate loading payable time into Global Payroll.

When a user starts the Identify phase of the payroll process, it identifies the time reporters who have payable time during the time period defined by pay calendar.

## How Global Payroll Selects Payable Time and Updates Payable Status

Global Payroll pulls only the subset of payable time that falls within the time period specified by the calendar. It does not include record-only adjustments. The following criteria must also be met:

- For the current period, the payable status of the payable time entry can be:
  - *ES* – Estimated
  - *AP* – Approved
  - *SP* – Sent to Payroll
  - *RP* – Rejected by Payroll
- For retro periods entries, any payable status *except*:
  - *NA* – Needs Approval
  - *CL* – Closed, when the Pay System field is not set to *GP*.
- The employee has been set up for payroll processing and the TRC associated with the payable time has been mapped to an earnings or absence Take element.
- The TRC is mapped to the calendar's run type (on Global Payroll's Run Type page.)

Global Payroll also updates each payable time entry as follows:

- For payable time entries loaded into payroll:
  - Sets the payable status to *SP*, unless it already reads *PD* or *DL*.
  - Sets the Time and Labor Pay System flag to *Global Payroll*.
- For payable time entries not accepted by payroll:
  - Sets the payable status to Rejected by Payroll (*RP*) or Ignore (*IG*).

---

**Note:** A time manager can close payable time that has a status of Rejected by Payroll (RP) on the Adjust Paid Time page. This sets the payroll request number to 1 and prevents the system from loading this time to payroll. Global Payroll never pulls any payable time rows which have a payroll request number equal to 1. The payable time status, however, remains Rejected by Payroll (RP).

---

See [Adjusting Time](#).

The Time Administration process refers to the payable status to determine when to create offsets for adjustments to payable time. Offsets are created for all payable statuses except *ES* and *NA*.

When Time and Labor creates an offset as the result of an adjustment to payable time, Global Payroll ignores the original row of payable time and the offset row and processes the newly created row. The adjustment generates a retro trigger in Global Payroll, which causes the pay period to be recalculated and corrected in either the current pay period or in a forwarding period.

- Sets the Frozen flag to *Yes*.

Actual costs associated with payable time can be published to PeopleSoft Financials only after the Frozen flag is set.

- Set the frozen date and publish date to the system date.

---

**Note:** The View Payable Time Details page displays the payable status, pay system flag, and frozen flag for a selected time reporter's payable time entries.

---

See [Payable Time Attributes](#).

## Bundling Payable Time

Global Payroll bundles similar instances of payable time for efficient processing. It keeps track of how it bundles payable time and sends to Time and Labor a set of sequence and cross-reference numbers for each time entry at the end of the payroll process. This information is important to the distribution process. When a user starts the Calculate phase of the payroll process, Global Payroll automatically selects the payable time entries; bundles them, and inserts the bundled entries into Global Payroll's positive input tables.

## When a Pay Run is Canceled

If a pay run is canceled, Global Payroll deletes the payable data loaded from Time and Labor and updates the payable status for each payable time entry to *RP* unless the following are true:

- Payable status is *PD*, *DL*, or *TP*.
- The payable time has also been sent to another payroll system.

Global Payroll checks the Pay System flag to see if the entry was sent to another system.

## Retroactive Processing

During a retroactive pay run, Global Payroll always loads payable time from Time and Labor back into its generated positive input table. Payable time that was adjusted in Time and Labor has two rows of data: one row that reverses or offsets the old value and one row that contains the new value. Global Payroll only needs the new value, which it uses to determine the variance.

## Correcting Errors Generated by Payable Time

After a preliminary pay run is complete, review the Payable Status Report for payable time entries that Global Payroll rejected. Errors that are most likely to occur result from incorrect TRC mapping to Global Payroll earnings and deduction elements. Because Global Payroll rejects incorrectly mapped entries during the calculate phase of processing, you see the rejected items on the Payable Status report—not on the payroll inquiry pages. Use the TRC 1 page to correct mapping errors, run the Time Administration process again, and launch the pay run again. Other reasons that payable time may be rejected by Global Payroll include the use of the wrong or no Time and Labor processing period; an employee being inactive in the pay entity; cancellation of the pay run, or the TRC being omitted from the run type.

Correct discrepancies that are caused by Time and Labor data in the Time and Labor system, then run the payroll process again.

See [Generating a Payable Status Report](#).



## Currency Differences

Global Payroll converts the TRC currency into the currency of the country being processed and returns cost data in the Global Payroll processing currency. During the distribution process, the currency code for Global Payroll processing populates the CURRENCY\_CD2 field in the payable time record (TL\_PAYABLE\_TIME) so that you can identify the currency in which the time was paid.

## Updating Payable Time After a Pay Run

After a pay run is finalized in Global Payroll, a Global Payroll user initiates a batch process, GPTLCOST, that updates the payable time entries in Time and Labor. The actions that the batch process performs depend on whether the Labor Distribution and Labor Dilution features are enabled in Time and Labor.

### Labor Distribution and Labor Dilution Disabled

During the batch process, Global Payroll does the following:

- Changes the payable status to *CL* for each entry coded *SP* that was successfully processed and the pay system is not configured for the Time and Labor distribution process.
- Sets the Pay System flag to *GP*.
- Populates the Labor Distribution Amount field and the Diluted Labor Distribution Amount field with the estimated gross.

### Labor Distribution and Labor Dilution Enabled

For each entry with a payable status of *SP* that was retrieved but not processed, the batch process changes the payable status to *RP*, unless the record was previously sent to another payroll system.

Global Payroll doesn't process a payable time entry when a user manually enters positive input for the same earnings or deduction element. User-entered positive input always takes precedence.

For each entry with a payable status of *SP* that was successfully processed, the batch process:

- Changes the payable status to *TP*.
- Sets the Pay System flag to *GP*.
- Sets the Frozen flag to *Yes* and the frozen date to the current date.

Global Payroll also sends the cost data associated with payable time entries to Time and Labor. It also returns the original Time and Labor sequence number for each payable time entry and the corresponding cross-reference numbers that Global Payroll generated during the bundling process. The cross-reference numbers indicate which entries were bundled, making it possible to link the costs calculated for earnings and deduction back to the daily detail. At the end of the batch process, Global Payroll invokes the Labor Distribution process and the Labor Dilution process, if applicable.

## Related Links

[Time and Labor Implementation](#)

## Sharing Work Schedules with Global Payroll

Time and Labor and Global Payroll use many of the same pages and records for schedule setup and assignment. In some cases, the page names vary slightly. If you're using both applications, you need to create and assign schedules only once. However, the information displayed on the scheduling pages may vary somewhat, depending on which application you access them with.

### Related Links

[Assigning Schedules](#)

[Creating Work Schedules and Schedule Definitions](#)

## Integrating Absence Event Data

This section provides an overview of integrating absence event data with Time and Labor and the payroll system, and discusses how to:

- Integrate Absence Management, Time and Labor, and Payroll for North America.
- Integrate the absence functionality of Global Payroll with Time and Labor.

## Understanding Absence Event Integration with Time and Labor

Absence Management integration involves absence event data that is entered in Absence Management or Time and Labor, and is either integrated with either Payroll for North America or Global Payroll.

This diagram shows that absence events can be entered through either Absence Management or on the Timesheet page in Time and Labor

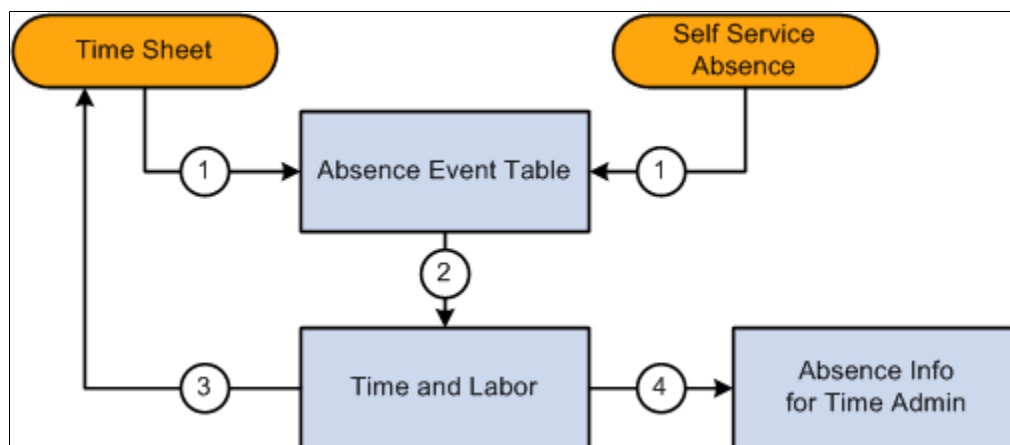

The Timesheet component in Time and Labor provides a link that enables you to enter absence event information. You can add, delete, cancel, and edit absence events for the current period of interest. Employees must be enrolled in Time and Labor to use the absence grid on the Timesheet page.

See [Timesheet Page](#).

The Allow entry in Timesheets check box must be selected on the Country-Take setup page in Absence Management to make the absence Take eligible for use on the Absence Event grid on the Timesheet page.

Absence event data that is entered in Absence Management using an ineligible Take code (for Time and Labor) may appear on the Absence Event grid in Time and Labor, but cannot be modified.

---

**Note:** During implementation of the integration of Absence Management and Time and Labor, you must complete an analysis of your current absence Take codes that are linked to TRCs. Enable those Take codes that you want to make available for absence event entries on the Timesheet page using the Country-Take setup page in Global Payroll and Absence Management.

---

See “Understanding Self Service Setup Tasks” (PeopleSoft Absence Management).

## Security Considerations

During implementation, align the setup of security for absence requests (in Absence Management) with absences entered on the Timesheet page (Time and Labor) so that the same manager is responsible for viewing or approving absences regardless of where the absence event entry is made. Setup the system so that absences that require multiple levels of approval cannot be entered using the Timesheet page.

## Integrating Absence Management, Time and Labor, and Payroll for North America

This section discusses:

- Absence event processing.
- Levels of Absence Management and Time and Labor integration.

### Absence Event Processing

When Payroll for North America, Absence Management, and Time and Labor are integrated, you run the Absence Conversion process after the Absence Entitlement process is completed to send absence event data directly from Absence Management to Payable Time in Time and Labor.

See “To Payroll for North America Page” (PeopleSoft Absence Management).

---

**Note:** This process is to generate payable time rows for absence for North American Payroll only.

---

All absence rows for employees that are enrolled in Time and Labor are sent, regardless of whether the Take codes are mapped to TRCs. Time and Labor processes the rows that are mapped to TRC and deletes these rows. For the rows where the Take code is not mapped to a TRC the process ends and a message log is generated to display all those Take codes. You need to map the remaining rows to a TRC. After you map the rows, restart the process using the Process Monitor. When the process restarts, it determines if unprocessed rows exist and it processes the mapped rows first. If other rows are still not mapped, the process stops, a message log is created, and you need to repeat the procedure to map the Take codes to a TRC. The process terminates when there are no more unprocessed rows.

---

**Note:** If data is intentionally not mapped, and you do not want these rows to be sent to Time and Labor, the Process Instance can be cancelled or deleted by selecting one of those options in the Update Process group box on the Process Monitor page.

---

At this stage, no cost is associated with the time. When all the payroll processes are completed, the associated costs and details are sent to Time and Labor. Payable Time rows will get updated with distributed and diluted costs, if needed.

## Levels of Absence Management and Time and Labor Integration

The levels of integration between Absence Management, Time and Labor, and Payroll for North America include:

- *Mapping.* Absence pay groups must be set up and configured, time reporting codes in Time and Labor for Payroll North America and Absence Management must be set up, and Absence Management Earnings to Payroll for North America Earnings must be set up.
- *Job Level.* Assign the Job record to Payroll for North America and Absence Management (PNA/AM mapped pay groups) and enroll the time reporter in Time and Labor.
- *Absence Management Process.* Run the Absence Management conversion (AE program) that invokes a Time and Labor process to update Payable Time. After the process is completed, Payable Time in Time and Labor will include absence positive input, if available.

---

**Note:** Absence Management allows you to define multiple earnings while setting up the absence take. This enables a single absence take to produce multiple rows of payable time in Time and Labor.

---

- *Time and Labor and Payroll for North America Process .* Run the Time Administration process in Time and Labor to generate payable time. Run the Load Time and Labor to Paysheets process from Payroll for North America and then the Paysheets process.

---

**Note:** The Time Administration process enables rules to process all of the absence time reporting codes associated with the generated positive input, whether the absence take has one or many earnings as part of the positive input membership list.

---

## Examples of Absence Takes with Multiple Earnings

Absence Management enables you to define multiple earnings during the set up of an absence take.

For example, the following sample page displays the Absence Take - Day Formula page **Set Up HCM > Product Related > Global Payroll & Absence Mgmt > Elements > Absence Elements > Absence Takes > Day Formula** with two earnings listed in the **Generate Positive Input Member List** region:

This example illustrates the fields and controls on the Example: Absence Take - Day Formula page with two earnings. You can find definitions for the fields and controls later on this page.

For the following examples, each of the earnings displayed on the Absence Take – Day Formula page is associated with a valid Time Reporting Code.

This table illustrates the relationship between the Absence Earnings Code, the Time Reporting Code, and the Payroll for North America Earnings Code for the example K0WAT TL-PTO absence take element:

<b>Absence Earnings Code</b>	<b>Time Reporting Code</b>	<b>PNA Earnings Code</b>
K0PHOL	K0PTO	PTO
K0WVAC PAID	KW7	VAC

Example One:

This table displays the absence hours entered by a Time Reporter:

<b>TRC</b>	<b>Mon</b>	<b>Tue</b>	<b>Wed</b>	<b>Thu</b>	<b>Fri</b>	<b>Process Generating Payable Time</b>
K0PTO	8	8	8			N/A

Running the Absence Management conversion program creates the payable time shown in the following table:

<b>TRC</b>	<b>Mon</b>	<b>Tue</b>	<b>Wed</b>	<b>Thu</b>	<b>Fri</b>	<b>Process Generating Payable Time</b>
KOPTO	8	8	8			N/A
KW7	8	8	8			Absence Conversion

This table illustrates the payable time created once the Time Administration process runs, which enables rules to process all of the absence time reporting codes associated with the generated positive input:

<b>TRC</b>	<b>Mon</b>	<b>Tue</b>	<b>Wed</b>	<b>Thu</b>	<b>Fri</b>	<b>Process Generating Payable Time</b>
KOPTO	8	8	8			N/A
KW7	8	8	8			Absence Conversion
KUOVT			8			Time Administration Rules  (Create Overtime Rule Threshold > 40 of KUREG + KOPTO + KW7)

Example Two:

The following table displays the absence hours entered by a Time Reporter:

<b>TRC</b>	<b>Mon</b>	<b>Tue</b>	<b>Wed</b>	<b>Thu</b>	<b>Fri</b>	<b>Process Generating Payable Time</b>
KOPTO	8	8	8	8	8	N/A

Running the Absence Management conversion program creates the payable time shown in the following table:

<i>TRC</i>	<i>Mon</i>	<i>Tue</i>	<i>Wed</i>	<i>Thu</i>	<i>Fri</i>	<i>Process Generating Payable Time</i>
KOPTO	8	8	8	8	8	N/A
KW7	8	8	8	8	8	Absence Conversion

This table illustrates the payable time created once the Time Administration process runs, which enables rules to process all of the absence time reporting codes associated with the generated positive input:

<i>TRC</i>	<i>Mon</i>	<i>Tue</i>	<i>Wed</i>	<i>Thu</i>	<i>Fri</i>	<i>Process Generating Payable Time</i>
KOPTO	8	8	8	8	8	N/A
KW7	8	8	8	8	8	Absence Conversion
KUOVT				8	8	Time Administration Rules  (Create Overtime Rule Threshold >24 of KUREG + KW7)  <hr/> <b>Note:</b> KOPTO is not part of the value list. <hr/>

**Related Links**

“Understanding How Absence Management Integrates with the Payroll System” (PeopleSoft Absence Management)

**Integrating the Absence Functionality of Global Payroll with Time and Labor**

Prerequisites for enabling absence event data on Timesheets are listed in the Managing Time section in this PeopleBook:

See [Prerequisites for Enabling Absences on Timesheets](#).

## Displaying Absence Event Data from Global Payroll on Timesheets

In Global Payroll, elements identify each type of earnings, deduction, and absence a time reporter can have. An element represents the set of rules that are applied during the payroll process and are somewhat similar to time reporting codes.

To integrate Time and Labor with Global Payroll absence event data, map TRCs to absence Take elements. If you're using task reporting, you may also need to map certain task codes to variable or system elements defined in Global Payroll.

When a time reporter is absent, the absence may be recorded through an Absence Entry page in Global Payroll. Time and Labor extracts and resolves absence events whenever you access the time reporting pages. First, Global Payroll checks to see if the employee is enrolled in Time and Labor, then it sends the absence event details, Take configuration, the employee's holiday schedule for the period of interest, a list of holidays, and the employee's schedule to Time and Labor. Time and Labor then generates the rows of data and displays the information on the Absence Event grid on the Timesheet page.

The setup of Time and Labor on the TL Installation page and the setup of the workgroup with which a time reporter is associated determine the way that absence information is displayed in Time and Labor.

---

**Note:** If you use the validation set delivered with Time and Labor, absences entered before a time reporter's hire date create an exception during the TR Status validation phase of the Time Administration process.

---



---

**Note:** Absence event data from Global Payroll is not stored in Reported Time in Time and Labor.

---

See [Time and Labor Installation Page](#).

### Example: Absence Data from Global Payroll

For each absence, Absence Management sends the code for the absence Take element, the beginning and end dates of the absence, and partial hours for absences that are less than a full day (when applicable). It also triggers the Schedule Resolution process, which looks at any full-day absences (that is, days for which no partial hours or half-days were reported), and determines the number of hours the time reporter was absent, based on his default schedule in Absence Management.

Assume a time reporter is scheduled to work 8 hours a day, Monday through Friday. An absence event is entered on Global Payroll absence pages for Monday, August 14 through Friday, August 18. A partial absence of 4 hours is reported for Monday and Friday. No hours are entered for the other absent days.

<i><b>Monday</b></i>	<i><b>Tuesday</b></i>	<i><b>Wednesday</b></i>	<i><b>Thursday</b></i>	<i><b>Friday</b></i>
4	Hours not reported	Hours not reported	Hours not reported	4

Absence Management sends 4 hours for Monday and 4 hours for Friday. It also invokes the Schedule Resolution process, which looks at the time reporter's schedule in Global Payroll to determine that he was absent 8 hours on Tuesday, Wednesday, and Thursday.



---

**Note:** Although Time and Labor can use absences reported in Global Payroll as criteria for rules, it never alters the reported absence data in Global Payroll.

---

See “Understanding How to Compensate Employees in Global Payroll for Time Reported Through Time and Labor” (PeopleSoft Global Payroll).



# Integrating with Absence Management

## Overview of Absence Integration

Absence Management and Time and Labor integration involves the ability for Absence administrators to process absence multiple times and send the absence data immediately to Time & Labor. This also allows the administrator to run multiple calendar groups at the same time. Here, the user role of Absence Administrator and Time Administrator is combined.

This diagram illustrates the Absence integration with Time and Labor for generating payable time.

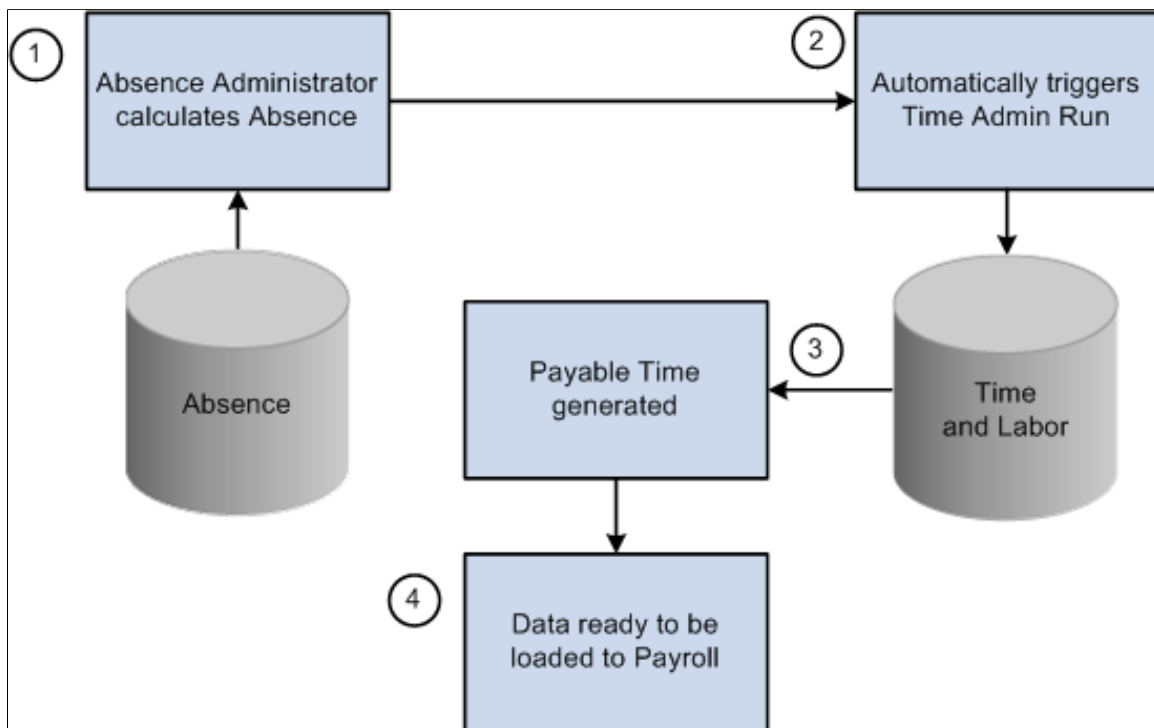

For the users with the Absence Integration feature enabled, the Time Administration process is automatically triggered to generate payable time for one or more calendar group immediately after calculating the absence. At the end of absence calculation process with in the same PS JOB (TL\_GENPT), Time administration process would be triggered for the same set of employees that are part of the calendar group by considering the Time and Labor security. For more information, see the [Generate Absence Payable Time Page](#).

Absence payable time would only be generated for the calculated absence. This ensures that only processed absence is used for rules processing.

With real time rules enabled, when timesheet user submits the timesheet, online time administration process will consider calculated absence . Calendar groups will be processed in streams for the absence calculation process from the "Generate Absence Payable time" page, if streams are enabled.

You can view the payable time results in the Timesheet component of Time and Labor. For more details, see the [Timesheet Page](#)

---

**Note:** To enable this integration feature, you need to select the Generate Absence Payable Time checkbox in the [Configurations Page](#). If not, the Generate Absence Payable Time page doesn't display any absence management calendars or its related buttons/links.

---

## Understanding the TL\_GENPT PS Job

The TL\_GENPT PS Job comprises the following processes:

- **GP\_PAYBEFORE:** This Application Engine process is intended to perform any desired pre-absence processing. It includes sections to add country-specific processing logic.
- **GPPDPRUN (Global Payroll & Absence Mgmt):** This COBOL SQL process performs the main Absence Management calculations.
- **GP\_PAYAFTER:** This Application Engine process is intended to perform any desired post-absence processing. At the end of GP\_PAYAFTER (which runs as part of GP\_PAYE), a process request is triggered for TL\_ABS\_GENPT dynamically.
- **TL\_ABS\_GENPT (Generate Absence Payable Time):** This Application Engine process collects input from the GP results and then calls the Time Administration batch process (TL\_TIMEADMIN) to generate absence payable time for employees that are part of the selected calendar group.

For more information, see “Understanding Processing Instructions” (PeopleSoft Global Payroll)

When the TL\_ABS\_GENPT calls the Time Administration process for a calendar group, it generates absence payable time for Payroll for North America only. It does not generate absence payable time for any Global Payroll payees that are part of the calendar group.

After generating payable time, administrators can still cancel or suspend calendar groups using the “Calculate Absence and Payroll Page” (PeopleSoft Global Payroll). In this case, if the generated absence payable time has not yet been loaded into Payroll for North America, the Time Administration process runs and simply deletes the generated payable time. The TL\_ABS\_GENPT will be triggered that will in turn trigger the Time\_admin process during the cancel run itself. For generated absence payable time associated with canceled or suspended calendars that has already been loaded into Payroll for North America, the Time Administration process deletes the payable time and creates offsets for it.

---

**Note:** If Time Administration process was already run and absence was processed, ECD would be reset to the earliest absence begin date. This would help the subsequent time administration process to pick this absence and generate absence payable time.

---

If the absence is modified or cancelled for an employee, the ECD will be reset back to the date of modification. This will enable Time Administration process to consider that particular employee for reprocessing of Time Administration and generate correct payable time.

For more information on the Time Administration batch process, see Understanding the Time Administration Process Flow.

---

**Note:** Absence conversion process is applicable only for Non-TL employees if this feature is enabled. When this feature is enabled, Absence conversion process will not process TL employees. And for Non-TL employees, it will proceed with loading the PSHUP table.

---

## Enhanced Integration of Absence Management with Time and Labor

By integrating Absence Management and Time and Labor, Absence administrators can now process absence multiple times and send the absence data immediately to Time and Labor. This will help to generate absence and Time and Labor payable time at the same time.

### Page Used to Integrate Absence Management with Time and Labor

<i>Page Name</i>	<i>Definition Name</i>	<i>Usage</i>
<b>Generate Absence Payable Time Page</b>	TL_ABS_RUN_CNTL_FL	Use to process absence calculation and generate payable time for one or more calendar groups.

### Generate Absence Payable Time Page

Use the Generate Absence Payable Time page (TL\_ABS\_RUN\_CNTL\_FL) to process absence calculation and generate payable time for one or more calendar groups. Here, Time Administration process is automatically triggered to generate payable time. This ensures that only processed absence is used for rules processing.

To enable this feature, you must select the **Generate Absence Payable Time** check box on the [Configurations Page](#).

Navigation:

Click the Absence Administration tile on the Workforce Administrator fluid home page, click the Absence Management from the navigation collection, then click the Generate Absence Payable Time on the Absence Administration page.

This example illustrates the Generate Absence Payable Time Page

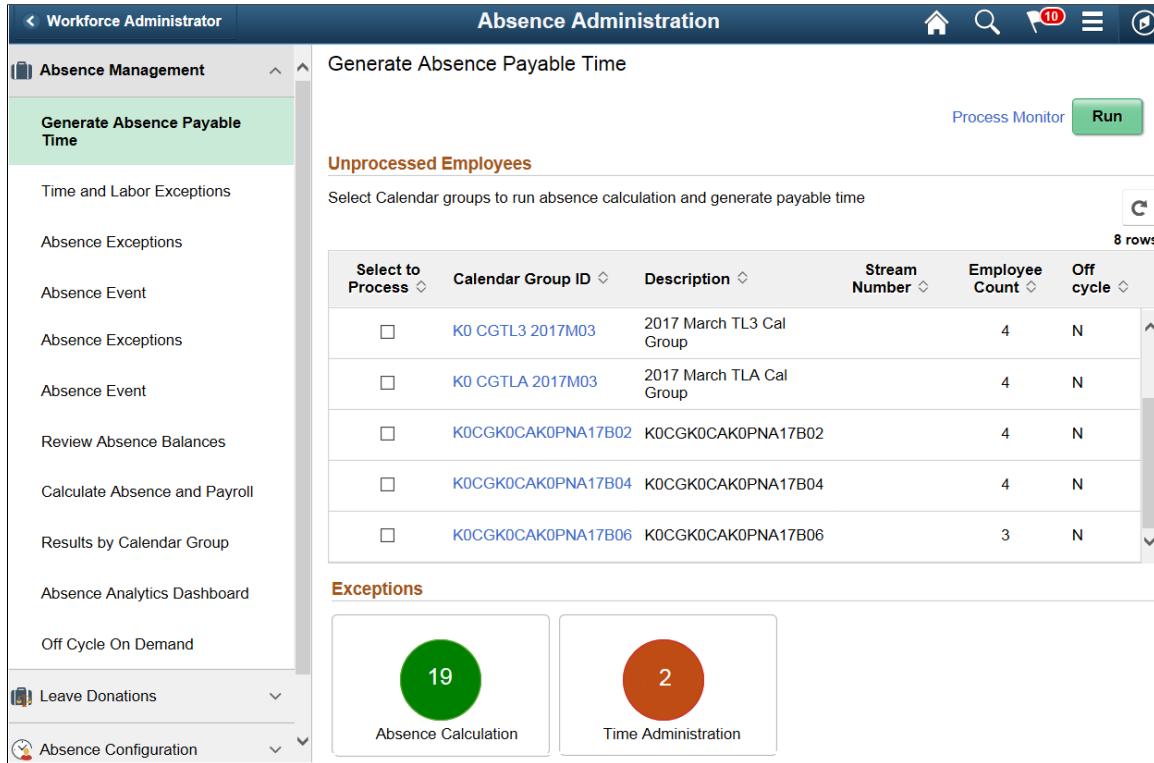

The grid on this page displays all the calendar groups that has some unprocessed absences for employees. It also displays all unfinalized calendar groups that has employees for whom approved absence has not been processed.

The Refresh button displays the current count and you can use the refresh button to refresh the grid after a particular run. On refresh, the count of the exceptions and warnings displayed on the Absence Calculation and Time Administration tiles also gets updated.

When multiple Calendar Groups are selected to be processed using the Run button, a message will be displayed indicating that this process request was submitted. Also, PS JOB (TL\_GENPT) would be triggered simultaneously (one for each calendar group) with absence calculation process being executed as part of it.

**Note:** If the Generate Absence Payable Time check box on the Configurations Page is deselected, this page doesn't display any calendars in the grid. All buttons and links in this page will also be unavailable.

<b>Field or Control</b>	<b>Description</b>
<b>Select to Process</b>	Select the calendar group that you want to process using the check box.
<b>Calendar Group ID</b>	Click to view Calendar IDs, respective paygroups, calendar begin and end dates for the selected calendar group.

This example illustrates the Calendar Group Details page

Calendar Group Details <span style="float: right;">×</span>			
Calendar Group ID K0EACYM 2009PI03			
Description March 2009 - EA PI			
1 rows			
Calendar ID ◇	Pay Group ◇	Period Begin Date ◇	Period End Date ◇
K0EAPI_09MAR_ABS	K0WPG PIA	03/01/2009	03/31/2009

Field or Control	Description
<b>Description</b>	Displays a brief description of the calendar group.
<b>Stream Number</b>	If process streams are enabled, this column displays the stream number.
<b>Employee Count</b>	<p>Displays the number of unprocessed employees (employees for whom approved absence has not been processed) associated with the calendar group. If process streams are enabled, this column displays the number of employees associated with the stream indicated in the Stream Number column.</p> <p>Note: The count also includes the approved absences that were changed retro-actively. The calendar details and the employee count associated to it is coming from a materialized view TL_CALPYESEL_VW. For more information on materialized view, see <i>Administering PeopleSoft Database on Oracle</i> and <i>Using Materialized Views</i> in <i>PeopleTools: Data Management</i>.</p>
<b>Off Cycle</b>	Indicates whether the calendar group is off cycle.
<b>Process Monitor</b>	Click to access the Process Monitor, where you can view the progress of the Generate Absence Payable Time process.

<b>Field or Control</b>	<b>Description</b>
<b>Run</b>	<p>Click to run the Generate Absence Payable Time (TL_GENPT) PSJob, which processes absence calculation and generates payable time for the payees associated with the selected calendar groups.</p> <ul style="list-style-type: none"> <li>• If you click the Run button without selecting a calendar group, you will get an error message stating 'Please select at least one calendar group to be processed'.</li> <li>• If you select multiple calendar groups with different pay end dates that include the same pay group, you will get an error message stating 'The selected Calendar Groups have common Paygroup. Calendar groups with same Paygroup needs to be processed one after the other'.</li> </ul> <hr/> <p><b>Note:</b> If process streams are enabled, the system process absence calculation and generates payable time for payees in streams.</p> <hr/>

For more information on process streams, see “Creating Process Streams” (PeopleSoft Absence Management).

<b>Field or Control</b>	<b>Description</b>
<b>Absence Calculation</b>	<p>Displays the sum of errors and warnings for absence calculations. Click <b>Absence Calculation</b> to open the Absence Exceptions page. For more information on Absence Exceptions, see “Absence Exceptions Page” (PeopleSoft Absence Management).</p>
<b>Time Administration</b>	<p>Displays exceptions count for Time and Labor. Click <b>Time Administration</b> to open the Manage Exceptions page. For more information on Time and Labor exceptions, see <a href="#">Manage Exceptions Page</a>.</p>



# Integrating with PeopleSoft Financials and Enterprise Performance Management

## Understanding Integration

This illustration shows how you might integrate Time and Labor with other PeopleSoft applications to provide an enterprise-wide solution for time collection, project costing, and compensation.

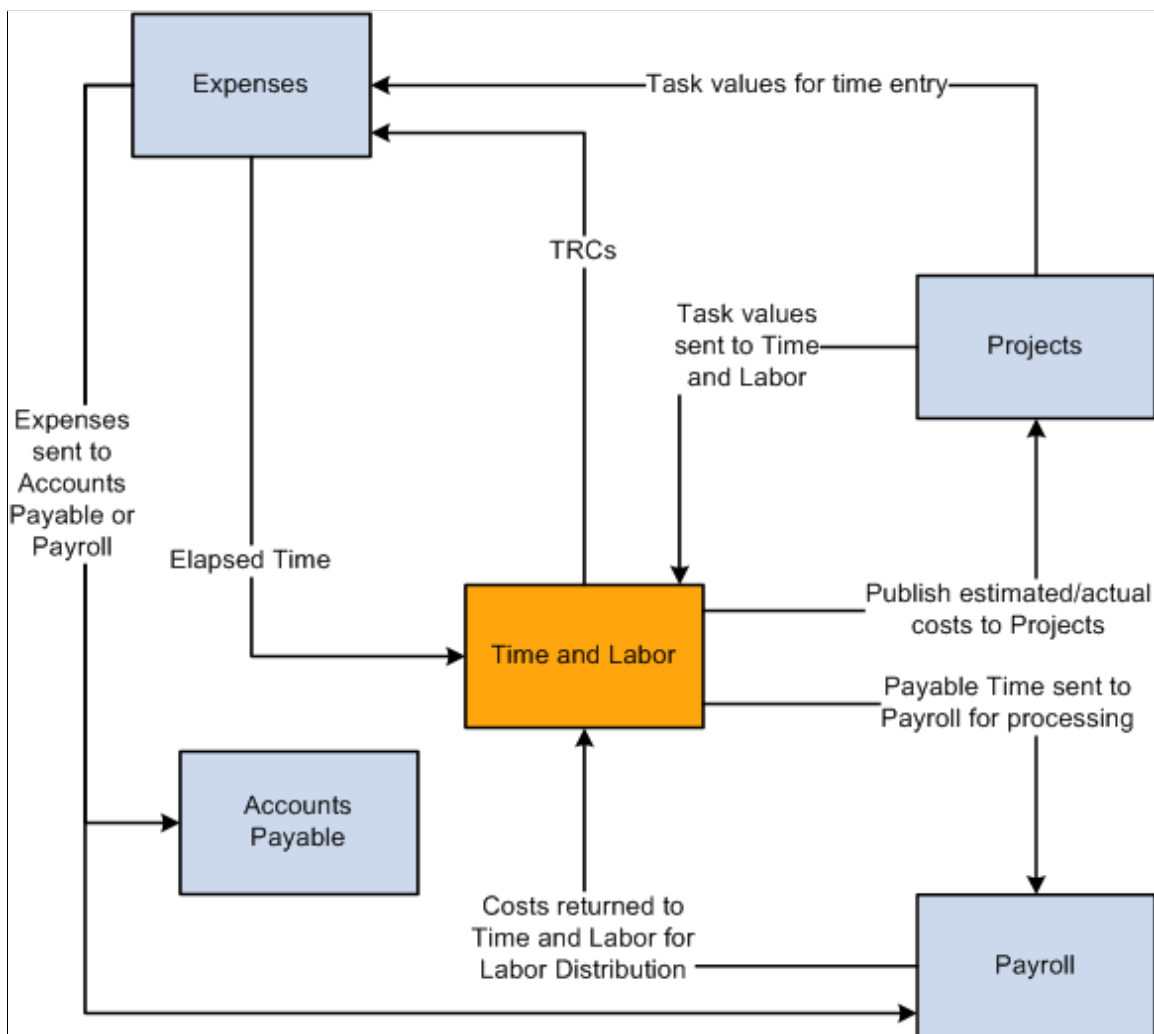

## Understanding Integration Points

Integration between Time and Labor and PeopleSoft Financials and Performance Management (EPM) is accomplished through PeopleSoft Integration Broker.

The follow tables list the integration points used to integrate with PeopleSoft Financials applications.

**Note:** To research the technical details of any integration point used by PeopleSoft applications, refer to the Interactive Services Repository found on My Oracle Support.

### Integration Points Used in Project Costing Integration

This table lists the integration point data for integrating Time and Labor with Project Costing:

<i>Service Operation</i>	<i>Integration Point Name</i>	<i>Queue</i>	<i>Publisher</i>
BUS_UNIT_PC_SYNC BUS_UNIT_PC_FULLSYNC	BUSINESS UNIT TABLE PC	PROJECTS_SETUP	Project Costing
PROJECT_SYNC PROJECT_FULLSYNC	PROJECT TABLE	PROJECTS_SETUP	Project Costing
PROJECT_ACTIVITY_SYNC PROJECT_ACTIVITY_FULLSYNC	PROJECT ACTIVITIES	PROJECTS_SETUP	Project Costing
PROJ_ACTIVITY_STATUS_SYNC PROJ_ACTIVITY_STATUS_FULLSYNC	PROJECT ACTIVITY STATUS	PROJECTS_SETUP	Project Costing
RESOURCE_TYPE_SYNC RESOURCE_TYPE_FULLSYNC	PROJECT RESOURCE TYPE	PROJECTS_SETUP	Project Costing
RES_TYPE_CAT_LINK_SYNC RES_TYPE_CAT_LINK_FULLSYNC	PROJECT TYPE-TO-CATEGORY LINK	PROJECTS_SETUP	Project Costing
RES_CAT_SUB_CAT_LINK_SYNC RES_CAT_SUB_CAT_LINK_FULLSYNC	PROJECT CATEGORY-TO-SUBCATEGORY LINK	PROJECTS_SETUP	Project Costing

<b>Service Operation</b>	<b>Integration Point Name</b>	<b>Queue</b>	<b>Publisher</b>
RESOURCE_CAT_SYNC RESOURCE_CAT_ FULLSYNC	PROJECT RESOURCE CATEGORY	PROJECTS_SETUP	Project Costing
RESOURCE_SUB_CAT_ SYNC RESOURCE_SUB_CAT_ FULLSYNC	PROJECT RESOURCE SUBCATEGORY	PROJECTS_SETUP	Project Costing
PROJECT_TEAM_SYNC PROJECT_TEAM_ FULLSYNC	PROJECT TEAM	PROJECTS_SETUP	Project Costing
PROJECT_STATUS_DEFN_ SYNC PROJECT_STATUS_DEFN_ FULLSYNC	PROJECT STATUS DEFINITION	PROJECTS_SETUP	Project Costing
PROJECT_STATUS_SYNC PROJECT_STATUS_ FULLSYNC	PROJECT STATUS	PROJECTS_SETUP	Project Costing
UOM_SYNC UOM_FULLSYNC	UNIT OF MEASURE	ENTERPRISE_SETUP	Financials to HCM
BUS_UNIT_FS_SYNC BUS_UNIT_FS_FULLSYNC	BUSINESS UNIT TABLE FS	ENTERPRISE_SETUP	Financials to HCM
TIME_REPORTING_CODE_ SYNC TIME_REPORTING_CODE_ FULLSYNC	TIME REPORTING CODES	TIME_AND_LABOR_ SETUP	T&L
ACTUAL_TIME_ADD ACTUAL_TIME_BATCH_ ADD	T&L ACTUAL TIME	ACTUAL_TIME	T&L

<i>Service Operation</i>	<i>Integration Point Name</i>	<i>Queue</i>	<i>Publisher</i>
ESTIMATED_TIME_BATCH_ADD	T&L ESTIMATED TIME	ESTIMATED_TIME	T&L
TBLSET_CONTROL_INITIALIZE  SETID_INITIALIZE	TABLE SET CONTROL	TBLSET_CONTROL	Financials to HCM
ESTIMATE_FORECAST_TIME_REQUEST  Publish Batch Program:  PC_TL_TO_PC  Subscribe Batch Program:  TL_PUB_TM_AE	ESTIMATE & FORECAST TIME REQUEST	ESTIMATED_TIME	Project Costing

**Note:** For the ESTIMATED\_TIME\_BATCH\_ADD, ACTUAL\_TIME\_ADD and ACTUAL\_TIME\_BATCH\_ADD messages, the value that is published as the Department value will vary depending on the data existing in the payable time table. If values exist in the payable time table for DeptID and DeptID\_CF, then the value associated with DeptID\_CF will be published as the Department to Project Costing. If DeptID\_CF does not have a value, then the DeptID value will be published to Project Costing.

**Note:** In order for TBLSET\_CONTROL\_INITIALIZE to publish to another database, you need to set up message chunking for it by record group. To do so, first identify the record groups which exist in both databases. Next, create a chunking rule (for Record Group), then add to the rule definition subscribing nodes as well as the record groups that were identified previously. Enter the chunking rule you created to the full table publish rules definition for the TBLSET\_CONTROL\_INITIALIZE service operation. If you are publishing to only one node, this setup is sufficient; if you are publishing to multiple nodes, you need to add routing PeopleCode to channel. For more information on message chunking, see PeopleSoft HCM 9.1 PeopleBook: Integration Interfaces, Using the Publish Utility, Setting up Message Chunking

## Integration Points Used in PeopleSoft Expenses Integration

This table lists the integration point data for integrating Time and Labor with PeopleSoft Expenses:

<i>Service Operation</i>	<i>Integration Point Name</i>	<i>Queue</i>	<i>Publisher</i>
ELAPSED_TIME_ADD	T&L LABOR TIME REP ELPSED TIME	ELAPSED_TIME	Expenses

<b>Service Operation</b>	<b>Integration Point Name</b>	<b>Queue</b>	<b>Publisher</b>
TIME_REPORTING_CODE_ FULLSYNC  TIME_REPORTING_CODE_ _SYNC	T&L TRC INFORMATION	TIME_AND_LABOR_ SETUP	Time and Labor

## Integration Points Used in PeopleSoft EPM Integration

This table lists the integration point data for integrating Time and Labor with PeopleSoft EPM applications:

<b>Service Operation</b>	<b>Integration Point Name</b>	<b>Queue</b>	<b>Publisher</b>
BUS_UNIT_PF_SYNC  BUS_UNIT_PF_FULLSYNC	BUSINESS UNIT EPM	PERF_MEASUREMENT_ SETUP	Activity Based Management
FINANCIAL_ACTIVITY_ SYNC  FINANCIAL_ACTIVITY_ FULLSYNC	ACTIVITY TABLE	PERF_MEASUREMENT_ SETUP	EPM
TBLSET_CONTROL_ INITIALIZE  SETID_INITIALIZE	TABLE SET CONTROL	TBLSET_CONTROL	GL to HR

**Note:** In order for TBLSET\_CONTROL\_INITIALIZE to publish to another database, you need to set up message chunking for it by record group. To do so, first identify the record groups which exist in both databases. Next, create a chunking rule (for Record Group), then add to the rule definition subscribing nodes as well as the record groups that were identified previously. Enter the chunking rule you created to the full table publish rules definition for the TBLSET\_CONTROL\_INITIALIZE service operation. If you are publishing to only one node, this setup is sufficient; if you are publishing to multiple nodes, you need to add routing peoplecode to channel. For more information on message chunking, see PeopleSoft HCM 9.1 PeopleBook: Integration Interfaces, Using the Publish Utility, Setting up Message Chunking

See *PeopleSoft FSCM: Expenses* for more details.

### Related Links

[Understanding TCDs](#)

[Understanding Task Reporting Requirements](#)

---

## Integrating with Project Costing

This section provides an overview of Project Costing integration and discusses how to set up Time and Labor with Project Costing.

### Understanding Project Costing Integration

Project Costing acts as a central repository for all project data. It enables your organization to capture project costs, keep projects within budget, issue bills for projects, and assess project profitability. When you use the Time and Labor task reporting functionality and integrate Time and Labor with Project Costing, you can:

- Track time for the projects, activities, business units, resource types, resource categories, and resource subcategories defined in Project Costing. You accomplish this by including project-related task entities in your task templates and task profiles.
- Publish, or send, estimated project-related costs to Project Costing. This feature can be helpful when your organization bills projects off-cycle from the payroll process.
- Publish actual project-related costs to Project Costing when a payroll cycle is complete. To use this feature, you must run your payroll through a payroll system that integrates with Time and Labor, such as Payroll for North America or Global Payroll.

You can also use the following optional features to:

- Restrict time entry so that time reporters can only report time to projects on which they are team members.
- Create a rule that causes the Time Administration process to generate an exception when it processes time reported to closed projects.
- Track time and cost data by ChartField for both accounting and commitment accounting.

This diagram illustrates the process flow in Project Costing

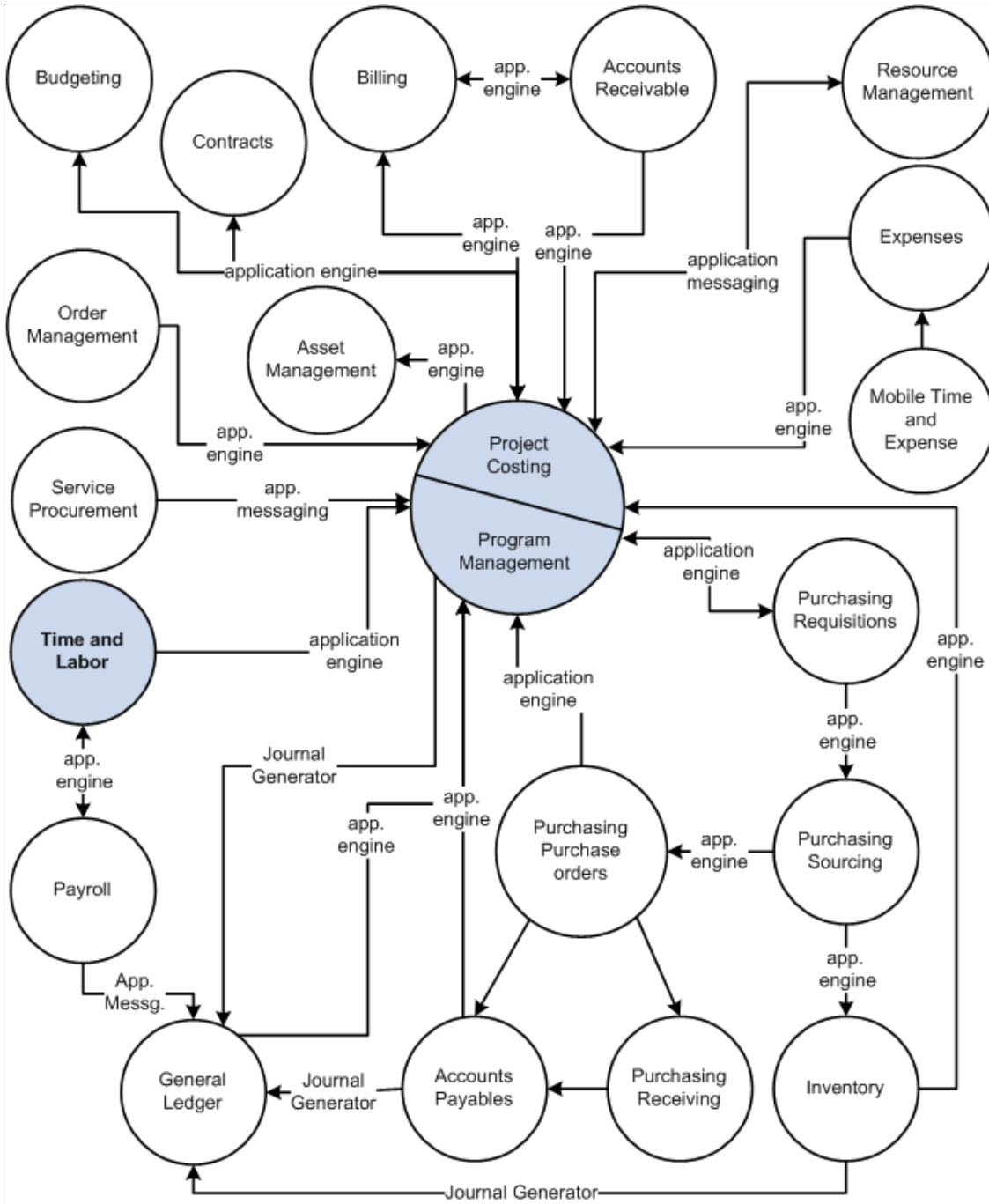

### Data Published to Project Costing

When Time and Labor publishes data to Project Costing, it sends the fields in the payable time record and the following data:

- All related ChartFields if a combination code is reported.
- The TRC type (hours, units, or amount) and unit of measure related to the TRC.

- The General Ledger business unit that is associated with the reported or default Human Resources business unit.

PeopleSoft Financials can use the business unit for currency conversion.

- The job code of the time reporter.

Project Costing can use the job code within the rate templates used for billing.

- The Send Time to Payroll value (TL\_TIME\_TO\_PAY).

Send Time to Payroll is populated with *N* if the payable time is for contractors; *Y* if the time is sent to a payroll system.

- The Accounting date of the Time and Labor cost transactions that are synchronized with the accounting period in Project Costing, as well as with the accounting period for other costs that are posted in General Ledger.

See *PeopleSoft FSCM Project Costing* for more details.

## Related Links

[Using Time and Labor with Commitment Accounting](#)

[Understanding Payable Time](#)

## Setting Up Time and Labor for Integration with Project Costing

To integrate Time and Labor with Project Costing:

- Activate the appropriate service operations used in Project Costing integration.
- Select the appropriate installation options in Time and Labor.
- Retrieve units of measure from Project Costing and configure the TRC to publish to Project Costing.
- Ensure that you have set up as a time reporter in Time and Labor each person who reports time to projects.
- Set up task templates and task profiles that include project-related task entities.
- Populate the task entity prompt tables with values defined in Project Costing.

Instructions for completing each setup step follow. Initiate some of these steps in Project Costing. They require coordination with those who administer your Project Costing application. We recommend that you discuss the setup process with the Project Costing administrators before beginning.

## Activating Integration Points Used in Project Costing Integration

The service operations that must be activated are listed earlier in this section. Detailed instructions for activating service operations are found in PeopleTools PeopleBooks.

See *PeopleTools PeopleSoft Integration Broker*.



## Selecting Installation Options in Time and Labor

On the Time and Labor Installation page, select the **Interface with PS/ Projects** option. When you select this option, the system automatically selects the **Calculate Estimated Gross** option to indicate that the system will calculate the estimated costs associated with payable time when you run the Time Administration process.

You can select **Publish unmapped TRC as No Pay** to send information to Project Costing.

You can also select the Chartfields validation option that you require.

## Retrieving Units of Measure from Project Costing and Publishing to Project Costing

When you define time reporting codes (TRCs) in Time and Labor, you select the unit of measure appropriate to each TRC. When Time and Labor is integrated with Project Costing, the valid units of measure come directly from Project Costing. You can view but not change these values through Time and Labor.

Before you begin to define time reporting codes, ensure that the units of measure defined in Project Costing have been published to Time and Labor. This process is initiated in Project Costing using a full publish.

Subsequent changes made to the units of measure are published to Time and Labor automatically (through an incremental publish) as they occur.

In addition, on the TRC 2 page, select the Publish to Project Costing check box. When you select this check box, the system sends project-related payable time information to Project Costing.

## Enrolling Time Reporters in Time and Labor

In Time and Labor, enroll as a time reporter each person who reports time to Project Costing.

## Setting Up Task Templates and Task Profiles for Project Tracking

Integration with Project Costing affects the options that are available to you when creating task templates and task profiles for time reporters. This, in turn, affects the types of task data time reporters provide when entering time.

You can select up to six additional, project-specific, task elements on the task reporting templates when you use Project Costing:

<i>Field or Control</i>	<i>Description</i>
<b>PC Business Unit</b> (project costing business unit)	The business unit entered by the time reporter determines the values available for the Project ID, Activity, Resource Type, Resource Category, and Resource Subcategory fields.
<b>Project ID</b>	If you select a project ID on the task template, and you're not using commitment accounting, the projects to which a person can report time are determined by the PC business unit.

<b>Field or Control</b>	<b>Description</b>
<b>Activity</b>	If you select an activity on the task template, time reporters are able to enter time for those activities, defined in PeopleSoft Project Activity tables that are associated with the business unit and project ID.
<b>Resource Type, Resource Category, and Resource Subcategory</b>	<p>In Project Costing, you can define dependencies between resource types, categories, and subcategories (through the dynamic edit options specified on the Project Costing Definition page in the Project Costing application). These relationships control data entry and help reduce errors.</p> <p>The valid values that time reporters can enter for the resource type, category, and subcategory also depend on the reported PC business unit.</p>

## Populating the Task Entity Prompt Tables

Values for the six project-related task entities are defined in Project Costing and made available to Time and Labor through PeopleSoft Integration Broker messages. For example, when you instruct the system to prompt users for a resource type when they report time, users can select the resource type from a prompt table that lists the resource types defined in Project Costing.

In Time and Labor, you can view, but not modify the project-related task values on the following pages: PC Business Unit page, PC Project Descr page, View Project Activity page, View Project Resource Type page, View Project Resource Category page, and View Project Resource Sub Catg page.

Project Costing initiates the transmission of project values to Time and Labor using Integration Broker with XML transmission.

As users add or change project-related data in Project Costing, the PeopleSoft Human Resources Management (HCM) tables are updated to reflect the changes.

---

**Note:** When a "full table" publish is initiated in Project Costing, all task values are deleted from the HCM tables before the current set of values is loaded. Consult with your Project Costing administrator regarding the timing of full-table publishes. We recommend that they be performed when users are not entering time through Time and Labor. (SetID messages published from the PeopleSoft Financials database to the HCM database add to, rather than delete, existing data in HCM.)

---

## Generating Exceptions When Time Is Reported to Closed Projects

When you close a project in Project Costing, the Project Status field (PROJECT\_STATUS) in the PS\_PROJECT\_STATUS Table in Time and Labor is automatically populated with a C (closed). You can create a rule that generates an exception when the Time Administration process encounters reported time with a project status of C.

## Restricting Time Entry to Project Teams

In Project Costing, you can select an Enforce Project Team option for all projects associated with a particular business unit. When this option is activated, Time and Labor only permits time reporters to enter time for projects on which they are team members.

*PeopleSoft FSCM Project Costing*

### Related Links

[Calculate Estimated Gross](#)

[Understanding Time Reporter Data](#)

[Understanding Task Reporting with PeopleSoft Financials](#)

[Understanding Time Administration](#)

[Understanding Rules](#)

## Publishing Estimated and Actual Cost Data to Project Costing

This section presents an overview of publishing estimated and actual cost data to Project Costing.

### Pages Used to Send Estimated and Actual Costs Data to Project Costing

<b>Page Name</b>	<b>Definition Name</b>	<b>Usage</b>
<a href="#">Publish Estimated Payable Time Page</a>	TL_RUN_PUB_TIME	<p>Initiate the transmission of estimated costs if the version of Project Costing you are using retrieves data through flat files. Also transmit estimated cost data to other applications.</p> <p>If your version of Project Costing uses XML to transmit data, estimated payable time is published automatically in response to a request message from Project Costing. You can use this page to publish estimated payable time if you do not want to wait for the request message.</p>
<a href="#">Publish Actual Payable Time Page</a>	TL_RUN_PUB_ACTUALS	<p>Publish time with a payable status of <i>Closed</i> before you run the extract process in Payroll for North America. To retrieve the published data, the receiving application must subscribe to the Actuals message. (Payable time that has been labor-distributed or labor-diluted is not published.)</p>

## Understanding Estimated and Actual Cost Data

You can send both estimated and actual time and cost data to Project Costing.

- Estimated costs are those calculated by the Time Administration process before payable time is sent to payroll.

When estimated costs are sent to Project Costing, Project Costing replaces any previously received estimated payable time with the entries received from Time and Labor.

- Actual costs are those your payroll system calculates for payable time and returns to Time and Labor after the completion of a pay run.

Project Costing considers all payable time it receives to be additions to previously received time. Time and Labor sends offsets in the rare cases when there is updated actual time.

## When Estimated Costs are Published to Project Costing

Estimated payable time is published to Project Costing in the following cases:

- When Time and Labor receives a request from Project Costing.

The request arrives in the form of a message from the PeopleSoft Financials database. In response, Time and Labor automatically publishes estimated time for payable time when the following conditions are met:

- A record has a value in the Business Unit PC, Project ID and Activity ID fields and that have a payable status of *Estimate*, *Needs Approval*, *Approved*, *Sent*, *Rejected*, and *Taken*.
- The related TRC has the **Publish to Projects** option selected.

---

**Note:** The publish switch field (Publish\_Sw) on the Payable Time table is updated with a status of *Ignored* for records that do not have an occurrence of either of the above.

---

- When you run the Publish Estimated Payable Time process.

The system handles this in exactly the same manner as Time and Labor receiving a request from Project Costing.

## When Actual Costs are Published to Project Costing

Actual payable time is published to Project Costing:

- When you run the Publish Actual Payable Time process.

In this case, Time and Labor publishes only closed payable time records that will not be run through the Labor Distribution process.

- When you use the Approve Payable Time page, the Approve Payable Time - Group page, or the Batch Approval page to:
  - Close payable time for time reporters whose time is not sent to payroll. (The **Send Time to Payroll** option is not selected on the Maintain Time Reporter Data page.)
  - Close payable time for a TRC that is not sent to payroll. (The **Send to Payroll** option is not activated on the TRC 2 page.)
- When you make a record adjustment to a payable time entry.

Time and Labor publishes both the new entry and an entry that offsets the original entry. (Record adjustments are not sent to payroll, only prior-period adjustments are sent.)

- When you adjust a record adjustment.
- When a record has a value of *No Pay* for the payable status field and the following conditions are met:
  - Publish No Pay rows is enabled on the Time and Labor Installation page.
  - Maintain Time Reporter Data - Send Time to Payroll option is selected.
  - The TRC is not associated with an earnings code.

Other actions that cause actual payable time to be published vary by payroll system:

### Payroll for North America Integration

When Time and Labor is integrated with Payroll for North America, actual time and cost data is published in the following cases:

- When Payroll for North America sets the status of successfully processed payable time entries to *Closed*. This happens because you have elected not to use labor distribution. Publishing occurs at the end of the load process.
- At the completion of the Extract process started in Payroll for North America. Publishing occurs after costs have been labor distributed (and diluted if the labor dilution feature is active).
- After rerunning the Extract process. If you unconfirm a pay run after running the Extract process, modify payable time, and then rerun the payroll, you can start the Extract process again. This process publishes all payable time that has a payable status of *Closed*, *Distributed*, or *Diluted*.

### Check Reversals (Payroll for North America)

The process to generate reversed rows and additional rows for future payment is an application engine process (TL\_PAY\_REVRS) and is triggered after the PayConfirm process completes successfully. This process also determines if any original or reversed rows must be sent to Project Costing.

These four scenarios describe how reversed checks are handled and how the associated costs are published to Project Costing:

- Straight Reversal – before the Extract Cost process is completed.

After the TL Load Data process is run, the payable time status is set to Taken by Payroll. If the check reversal occurs before the Extract Cost process is run, reversed rows with a Reversed status are created, and the original rows still have the status of Taken by Payroll.

When confirming the check reversal before the Extract Cost process is run, the reversal rows are not sent to Project Costing because the original rows with actual costs have not been sent yet. When running the Extract Cost process after confirming the reversal process, both the original rows with actual costs and reversed rows are published to Project Costing.

Because of the estimated costs were sent to Project Costing earlier, and these costs may already have been billed, Time and Labor sends both the original row (with actual costs) and the reversed row (offset) for the reconciliation process on the Project Costing side.

- Straight Reversal – after the Extract Cost process is completed.

When the Extract Cost process is run, the original rows with actual costs are sent to Project Costing. If the check reversal process occurs after the Extract Cost process is completed, the original rows with actual costs have already been sent to Project Costing; consequently, the reversed rows are sent to Project Costing immediately.

- Reversal with future payment – before the Extract Cost process is completed.

After the TL Load Data process is run, the payable time status is set to Taken by Payroll. If the check reversal occurs before the Extract Cost process is run, the reversed rows with a Reversed status are created, and the original rows with status Taken by Payroll are changed to the Reversed status (see PeopleBook — Time and Labor Integrating with Payroll Applications for why the status changed). These original rows are sent to Project Costing with the reversed rows.

- Reversal with future payment – after the Extract Cost process is completed.

When the Extract Cost process is run, the original rows with actual costs are sent to Project Costing. If the check reversal process occurs after the Extract Cost process is completed, and the original rows with actual costs have already been sent to Project Costing, the reversed rows are sent to Project Costing immediately. Additional rows for future payment with the Estimated status are not sent to Project Costing.

See [Reversing or Adjusting a Paycheck](#).

### **Unconfirming and Unsheeting a Payrun that Contains a Check Reversal (Payroll for North America)**

These two scenarios describe how reversed checks are handled and how the associated costs are published to Project Costing when you unconfirm and unsheet a payrun:

- Straight reversal with no additional row.

Time and Labor removes all payable time rows with the Reversed status that have an initial sequence number equal to the sequence number of the original check entered by the user. Time and Labor publishes the original row with PUBLISH\_SW equal to "Y" to Project Costing. This assumes that the reversal row has already been published to Project Costing and alerts Project Costing that the reversal has been undone.

- Check reversal with an additional row generated.

Time and Labor removes all payable time rows with statuses *Reversed*, *Estimated*, *Needs Approval*, *Rejected*, and *Ignored* that have an initial sequence number equal to the sequence number of the original check entered by the user. Time and Labor publishes the original row with PUBLISH\_SW equals to "Y" to Project Costing only if the reversal row and/or the new row have already been published.

### **Global Payroll Integration**

When Time and Labor is integrated with Global Payroll, actual time and cost data is published in the following cases:

- When Global Payroll sets the status of successfully processed payable time entries to *Closed*. This happens because you have elected not to use labor distribution. Publishing occurs at the end of the update process that is initiated through the Time and Labor Run Control in Global Payroll.

- At the completion of the Labor Distribution or Labor Dilution process that is initiated automatically at the end of the update process that you start through the Time and Labor Run Control page in Global Payroll. This process also publishes all payable time that has a payable status of *Closed*, *Paid–Labor Distributed*, or *Paid–Labor Diluted*.

---

**Note:** On the payable time table, the payable status field value of *Ignore* is used by the Global Payroll system. The status of *Ignore* is set by Global Payroll when offset rows are created in Time and Labor. The publish switch field is set to *Ignore* for rows of payable time that have payable status set to *Ignore* and either the PC Business Unit, Project ID or Activity ID are blank or both the LBR\_DIST\_AMT and DILUTED\_GROSS fields are blank.

---

## Publish Estimated Payable Time Page

Use the Publish Estimated Payable Time page (TL\_RUN\_PUB\_TIME) to initiate the transmission of estimated costs if the version of Project Costing you are using retrieves data through flat files.

Also transmit estimated cost data to other applications. If your version of Project Costing uses XML to transmit data, estimated payable time is published automatically in response to a request message from Project Costing. You can use this page to publish estimated payable time if you do not want to wait for the request message.

Navigation:

**Time and Labor > Process Time > Publish Estimated Payable Time > Publish Estimated Payable Time**

<i>Field or Control</i>	<i>Description</i>
<b>Accounting Date</b>	The accounting date is assigned to every row of payable time published to Project Costing. It defaults to the current date, but you can change it.
<b>Run</b>	Click to run the Publish Payable Time Application Engine process (TL_PUB_TM_AE).

## Publish Actual Payable Time Page

Use the Publish Actual Payable Time page (TL\_RUN\_PUB\_ACTUALS) to publish time with a payable status of *Closed* before you run the extract process in Payroll for North America.

To retrieve the published data, the receiving application must subscribe to the Actuals message. (Payable time that has been labor-distributed or labor-diluted is not published.)

Navigation:

**Time and Labor > Process Time > Publish Actual Payable Time > Publish Actual Payable Time**

In Payroll for North America, you must confirm the pay run before publishing cost data.

<b>Field or Control</b>	<b>Description</b>
<b>Accounting Date</b>	The accounting date is assigned to every row of payable time published to Project Costing. It defaults to the current date, but you can change it.
<b>Run</b>	Click to run the Publish Time that PY Closed Application Engine process (TL_PY_PUB_TM).

### **Related Links**

[Calculate Estimated Gross](#)

[Overview of Payroll Integration](#)

---

## **Using Time and Labor with Commitment Accounting**

This section provides an overview of the Commitment Accounting interface and discusses how to:

- Set up Time and Labor for use with commitment accounting.
- Distribute costs after a pay run.

## **Understanding the Commitment Accounting Interface**

This section discusses:

- Commitment accounting.
- The commitment accounting interface.

### **Commitment Accounting**

Commitment accounting, part of the Commitment Control feature in PeopleSoft Financials, helps your organization track financial obligations accurately and ensure that planned and actual expenses do not exceed budget.

A combination code (also referred to as a *funding source*) is a key that defines a valid combination of Standard Configuration ChartFields setup in FMS or HCM. These are the codes that you attach to components of your budget, such as earnings and deductions, to indicate the funding source the system should attribute to each expense. For example, if you account for salaries by department and project, you might attach a ChartField value of Department and Project to the Salaries combination code.

If you're using PeopleSoft Financials with Time and Labor you can integrate commitment accounting functionality with task reporting. This enables Time and Labor to automatically retrieve certain ChartField values when time reporters enter their time.



## The Commitment Accounting Interface

To use the commitment accounting functionality with Time and Labor, you must create task templates, task profiles, and task groups that are enabled for the commitment accounting functionality. You then assign each time reporter who works in a department that is set up for commitment accounting functionality to a taskgroup defined for commitment accounting.

When time reporters enter their time, they must provide a combination code, and any other task elements you selected when defining the task template. Time and Labor uses the combination code to retrieve the appropriate ChartField values for the following fields:

- Account
- Alt Acct (alternate account)
- Operating Unit
- Fund Code
- GL Department
- Program Code
- Class Field
- Budget Reference
- Product
- Project ID
- Affiliate
- Fund Affiliate
- Operating Unit Affiliate
- ChartField1
- ChartField2
- ChartField3

---

**Note:** ChartField values in FMS can be exported into the HCM Database through Integration Broker.

---

When you run the Time Administration process, Time and Labor performs the following validations on time reporters who belong to a commitment accounting taskgroup:

- Verifies that, if a taskgroup was positively reported, the taskgroup is defined for commitment accounting. If the taskgroup is not defined for commitment accounting, the system generates an exception.
- Determines if the time reporter changed departments or if the Use Actuals Distribution flag for the department changed. If either situation occurred, the Time Administration process generates an exception for the time reporter's default taskgroup. You can use the Maintain Time Reporter Data page to change the default taskgroup.

If you send payable time to Payroll for North America for processing, you can distribute costs associated with combination codes and ChartFields back to Project Costing after a pay run.

See *PeopleSoft FSCM Project Costing* for more details.

## Related Links

“Manage Commitment Accounting Overview” (PeopleSoft Human Resources Manage Commitment Accounting)

“Understanding PeopleSoft ChartFields” (Application Fundamentals)

## Setting Up Time and Labor for Use with Commitment Accounting

To integrate Time and Labor with the commitment accounting functionality, you must:

- Ensure that the appropriate distribution options are selected for departments subject to commitment accounting if you're using Payroll for North America.
- Set up task templates, task profiles, and taskgroups for commitment accounting.
- Enroll time reporters into taskgroups defined for commitment accounting.
- Ensure that your PeopleSoft Human Resources System administrator has run the Load Combination Code process (BUD003) to load the Combination Code table with ChartField combinations already imported from the PeopleSoft Financials database into the GL\_ACCT\_CD\_TBL using the HR\_ACCT\_CD\_LOAD service operation.

See “Entering and Maintaining Valid ChartField Combinations” (Application Fundamentals).

The first three items are described in this section.

### Selecting Distribution Options for Commitment Accounting Departments

The Department table, accessed through PeopleSoft Human Resources, controls whether a department participates in commitment accounting and whether Time and Labor data is used when the commitment accounting Actuals Distribution process runs for the department. The Actuals Distribution process—not to be confused with the Labor Distribution process—automatically distributes actual earnings, deductions, and employer taxes calculated by Payroll for North America across combination codes (funding sources) and uses the Pay Message Table to notify users when a department's budget has been exceeded. After you run the Actuals Distribution process you can run a separate process (in Payroll for North America) that creates the general ledger transactions for your PeopleSoft General Ledger system.

To configure the commitment accounting feature so that the Actuals Distribution process takes into account the task information reported through Time and Labor, access the Comm Acctg and EG page for each department that's set up to use the Actuals Distribution process. Select the Use TL Distribution check box and the Use Actuals Distribution check box, if it is not already selected.

When you then run the Actuals Distribution process, it uses the labor-distributed (not labor-diluted) costs as the source of funding. That is, the process creates an entry for each combination code to which time was reported in Time and Labor and distributes the costs in the same ratio that was used for labor distribution.

---

**Note:** If any of the company/pay group combinations to be run in the Actuals Distribution process are not correctly set up, you can rerun the process after you have corrected the error.

---

Use the task reporting pages in Time and Labor to create:

- Task templates that are enabled for commitment accounting.

To activate commitment accounting, select the Commitment Accounting check box on the Task Template page when you create the task template.

- Task profiles that are enabled for commitment accounting.

To enable a task profile for commitment accounting, link it to a task template that's defined for commitment accounting by selecting the template in the Task Template ID field on the Task Profile page.

- Taskgroups that are enabled for commitment accounting.

Select the Commitment Accounting check box on the Taskgroup page when creating the template.

## **Enrolling Time Reporters in Taskgroups Defined for Commitment Accounting**

Use the Create Time Reporter Data page to assign a commitment accounting taskgroup to each time reporter who works in a department that's subject to commitment accounting.

### **Related Links**

[Time and Labor Implementation](#)

“Maintaining Departments” (Application Fundamentals)

[Understanding Task Reporting Requirements](#)

[Entering and Maintaining Time Reporter Data](#)

## **Distributing Costs after a Pay Run**

After you confirm a pay run in Payroll for North America, run the Actuals Distribution process with Time and Labor. This process, which you start within Payroll for North America, extracts time and labor data then runs the Actuals Distribution process.

For employer deductions and employer taxes, the system first looks for a combination code specified on the employee's job record. If none is found, it uses the combination code on the Department Budget page. If there is no Department Budget page information entered for a department, the Actuals Distribution process cannot distribute the actual costs.

### **Related Links**

“Understanding the Data Flow Between PeopleSoft HCM and PeopleSoft Financials” (PeopleSoft Human Resources Manage Commitment Accounting)

---

## Integrating with Performance Management

Performance Management (EPM) enables you to collect and use data generated by other enterprise applications, such as Time and Labor, to analyze your business processes, profitability, and key performance measures.

When you select Interface with PS/EPM on the Time and Labor Installation page, you can include Business Unit PF and FS Activity as task entities on your task templates and task profiles. Time and Labor retrieves the values for these task entities from the PeopleSoft Financials database.

When time is reported using any of the values in the Business Unit PF table or the FS Activity table, the resulting payable time entries become available for extract by Performance Management after they reach the frozen state. You can then use the data within your financial analyses.

### Related Links

[Setting Up System Defaults and Loading Dates](#)

# Using Self-Service Components

---

## Understanding Self-Service Components

The self-service components enable employees to review, add, update, and delete (where appropriate) their time and labor information. Self-service components include:

- Time and Labor Launch Pad for employees (TL\_LAUNCH\_PAD\_PNLG).

Enables employees to view information about reported and scheduled time for a month at a time. It also enables employees to navigate to self-service transaction pages.

- Time Sheet (TL\_MSS\_EE\_SRCH\_PRD).

Enables employees to view and report time and task details for a day, week, or time period for punch and elapsed time.

---

**Note:** Pages of this feature have been replaced by equivalent pages in Fluid. For more information, see [Using PeopleSoft Fluid User Interface for Time Reporting as an Employee](#).

---

- Mass Time for employees (TL\_MASS\_TIME\_ESS).

Enables employees to report time in several ways. They can report time according to their schedule for a specified date or date range. They can also specify a lump sum amount to be distributed according to their schedule, or specify multiple time transactions to be applied to each day in the time period.

- Overtime Requests (TL\_OT\_HISTORY\_LIST).

Enables employees to view recent overtime requests or submit a new overtime request.

- Web Clock (TL\_WEBCLK\_ESS).

Enables employees to enter a single punch and provide time and task details.

- Monthly Schedule (SCH\_EE\_SCHEDULE).

Enables employees to display monthly schedules.

- Compensatory Time (TL\_COMPTIME\_PNL).

Enables employees to view compensatory time balance and compensatory time expiration information.

- Exceptions (TL\_MNG\_EX\_PNL\_GRP3).

Enables employees to display exceptions associated with reported time.

- Payable Time Summary (TL\_TM\_MPAY\_SUMM\_PG).

Enables employees to view payable time that the system calculated from a schedule or reported time.

- Payable Time Detail (TL\_MNG\_PAY\_VIEW\_DT).

Enables employees to view details about their payable time.

- Forecasted Time Summary (TL\_TM\_SPAY\_SUMM\_PG).

Enables employees to view a forecasted summary of the payable time for a future or current period. This payable time is calculated based on the employee's schedule or time reported for a specified date.

- Forecasted Time Detail (TL\_MNG\_SPAY\_VIEW\_D).

Enables employees to view details about forecasted payable time.

- User Preferences (TL\_USER\_PREF).

Enables employees to view or update their time reporting and scheduling preferences.

## Roles

The self-service components can be used by both the employee and the manager; therefore, we deliver definitions for these roles and define a menu for each role.

---

**Note:** In this section, we use the term *employee* to refer to all people who work for and report time in the organization. This can include regular employees as well as contractors and other temporary workers.

---

---

## Navigating in Time and Labor Home Pages

There are several ways to access self-service transactions:

- The Self Service page.
- The Time Reporting page.
- Standard menu path navigation.

### Self Service Page

The Self Service page present a simple user interface design and directs navigation for the end user.

The links that appear on the page depend on which collaborative applications were purchased and whether the products are selected in the Installation Table.

This example illustrates the fields and controls on the Self Service page. You can find definitions for the fields and controls later on this page.

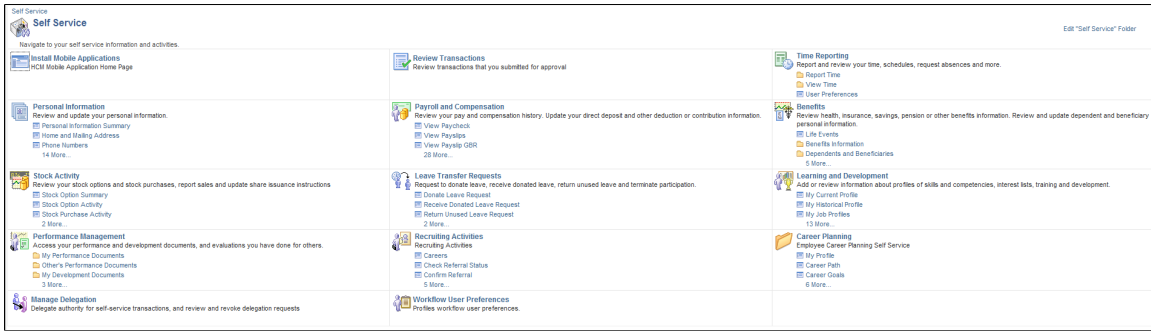

## Time Reporting Page

This page includes links to all Time and Labor self-service transactions that pertain to the user. The user can also click a link to return to the Self Service page.

This example illustrates the fields and controls on the Time Reporting page. You can find definitions for the fields and controls later on this page.

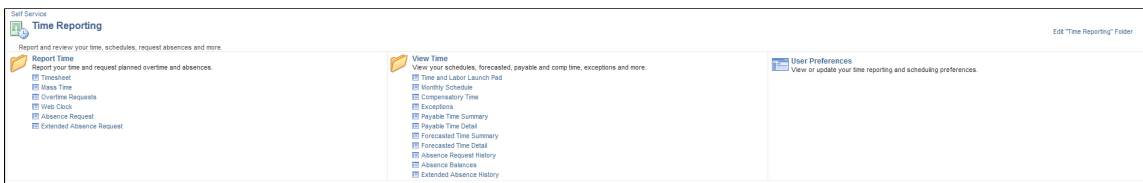

## Standard Menu Navigation

The standard menu-driven navigation is the traditional PeopleSoft access method.

This example illustrates the fields and controls on the Standard self service navigation path. You can find definitions for the fields and controls later on this page.

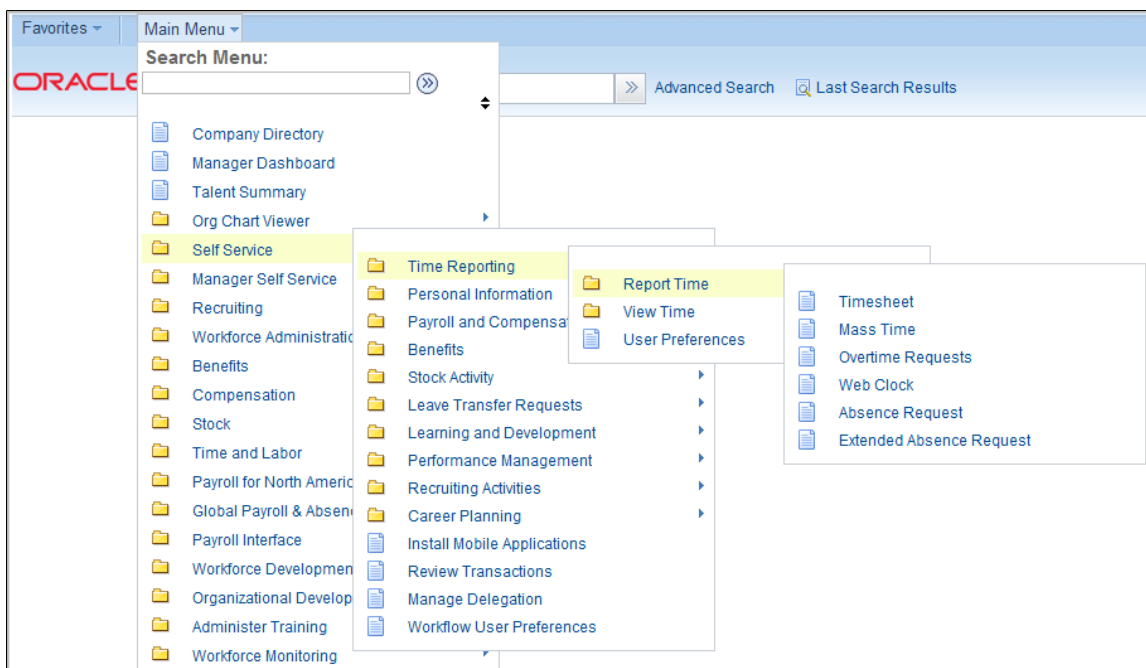

## Using Time and Labor Launch Pad Pages for Employees

This section discusses how to use the Time and Labor Launch Pad pages for employees.

### Pages Used to Specify Time and Labor Launch Pad Information for Employees

<b>Page Name</b>	<b>Definition Name</b>	<b>Usage</b>
<u>Time and Labor Launch Pad Page</u>	TL_LAUNCH_PAD	<p>View which days in the specified month have payable time, forecasted payable time, reported elapsed time, reported punch time, exceptions, and recommended actions associated with each exception.</p> <p>You can change the calendar view to display time sheet information, forecasted payable time, the actual number of payable hours (detail and summary), or scheduled hours that were reported for each day.</p> <p>Use the Time and Labor Launch pages to navigate to other Time and Labor pages enabling the user to manage all aspects of their time.</p>



<b>Page Name</b>	<b>Definition Name</b>	<b>Usage</b>
<u>Details Page</u>	TL_LAUNCH_PAD_DLY	View detailed calendar information for each day. The Details page provides more information on the Reported Elapsed or Punch time, Exceptions, and Payable or Forecasted Payable time that exist for that day.
<u>Monthly Schedule Page</u>	SCH_EE_MONTHLY	View the monthly schedule for each job, if an employee has multiple jobs. Navigate to any month, or year and navigate to a prior or future month.
<u>Monthly Schedule - Daily Detail Page</u>	SCH_EE_DAILY	View schedule details for a day.

## Time and Labor Launch Pad Page

Use the Time and Labor Launch Pad page (TL\_LAUNCH\_PAD) to view which days in the specified month have payable time, forecasted payable time, reported elapsed time, reported punch time, exceptions, and recommended actions associated with each exception.

You can change the calendar view to display time sheet information, forecasted payable time, the actual number of payable hours (detail and summary), or scheduled hours that were reported for each day. Use the Time and Labor Launch pages to navigate to other Time and Labor pages enabling the user to manage all aspects of their time.

Navigation:

**Self Service > Time Reporting > View Time > Time and Labor Launch Pad > Time and Labor Launch Pad**

This example illustrates the fields and controls on the Time and Labor Launch Pad page. You can find definitions for the fields and controls later on this page.

**Time and Labor Launch Pad**

Betty Locherty  
Director-Finance

Employee ID KU0007  
Empl Record 0

July 2013 \*Month 07 - July 2013 Reported Hours View

Selection In View Reported Hours Previous Month Next Month

Sunday	Monday	Tuesday	Wednesday	Thursday	Friday	Saturday
	1	2	3	4 Independent	5	6
7	8	9	10	11	12	13
14	15	16	17	18	19	20
21	22	23	24	25	26	27
28	29	30	31			

Forecast Payable Time

When you first enter the Launch Pad page, it displays the current month and year by default. Going forward, it opens in the same state in which you last left it.

Field or Control	Description
<b>View</b>	Click this button after you enter the month, year, and the type of hours to display on the calendar. Options for the type of hours are <i>Forecasted Payable Hours</i> , <i>Exceptions</i> , <i>Payable Hours</i> , <i>Reported Hours</i> , or <i>Scheduled Hours</i> .  For example, if you select <i>Scheduled Hours</i> and 8.00 is displayed in the days on the calendar, then you are scheduled to work eight hours on those days.
<b>Previous Month and Next Month</b>	Use these buttons to display the preceding or next month.

At any given time, any day in the calendar may display the following valid values: *X*, *P*, *E*, *\$*, *F*, or *R*. These values indicate that there is information about reported time for that day. For example, suppose *E* appears for one day on the calendar. This means that the employee has elapsed time reported for that day. If *\$* appears, it means that payable time exists for that day. See the bottom of the Launch Pad page for a description of each of the values. If any of the days are highlighted or linked, that indicates that the day has elapsed time, punch time, payable time, and exceptions with recommended actions for each exception. Click the day to view the time reporting details that exist for that day.

<b>Field or Control</b>	<b>Description</b>
<b>Forecast Payable Time</b>	<p>Click this button to start the Forecasted Payable Time process, which calculates forecasted payable time for the employee.</p> <p>The system looks at the employee's schedule and any time they have reported for this month. It then indicates which days have payable time forecasted for them by displaying an <i>F</i> on the day. To view the number of forecasted hours for that day, change the view at the top of the page to <i>Forecasted Payable Hours</i> and click the <b>View</b> button. To view the details of the forecasted time, click the link for the day that you want to view.</p>

Finally, if you want to navigate to a different part of the system to perform other transactions or to get more information, use the **Links** field at the bottom of the page. Select the application item that you want to navigate to from the drop-down list, click the **Go** button, and navigate to the feature that you selected. Depending on how the application suites are set up, different options are available for the **Links** field. These can include Monthly Schedule, Timesheet, View Forecasted Payable Time, View Payable Time (Detail) and View Payable Time (Summary).

## Details Page

Use the Details page (TL\_LAUNCH\_PAD\_DLY) to view detailed calendar information for each day. This page provides more information on the Reported Elapsed or Punch time, Exceptions, and Payable or Forecasted Payable time that exist for that day.

Navigation:

### Click the **Date** link on the **Time and Labor Launch Pad** page

This example illustrates the fields and controls on the Details page. You can find definitions for the fields and controls later on this page.

<b>Time Details For 01/05/2007</b>			
Sandra Pierce		Employee ID K0W201	
Analyst-HRMS		Empl Record 0	
<a href="#">Previous Day</a>		<a href="#">Next Day</a>	
Reported Elapsed Time			
Quantity	Type	Time Reporting Code	
8.00	Hours	Paid Vacations Employee	
Forecast Payable Time			
Forecasted Payable Time			
Quantity	Type	Time Reporting Code	Estimated Gross Currency Code

The Details page displays information that exists for that day. It shows elapsed hours, punch hours, exceptions with associated recommended actions, payable time, and forecasted payable time, if they exist. The values *X*, *P*, *E*, *\$*, *F*, or *R* that are on the Time and Labor Launch Pad page indicate what information appears on this page. The system reports time on different lines if there are different tasks, reporting codes, or shifts.

If you have not already calculated the forecasted payable time for the specified day, click the **Forecast Payable Time** button. The system looks at the employee's scheduled or reported time to generate forecasted payable time. If there is no scheduled or reported time, no forecasted payable time is generated. However, if the system generates forecasted payable time, it appears in the **Forecasted Payable Time** group box.

## Monthly Schedule Page

Use the Monthly Schedule page (SCH\_EE\_MONTHLY) to view the monthly schedule for each job, if an employee has multiple jobs. Navigate to any month, or year and navigate to a prior or future month.

Navigation:

**Self Service > Time Reporting > View Time > Monthly Schedule > Monthly Schedule**

This example illustrates the fields and controls on the Monthly Schedule page (1 of 2).

### Monthly Schedule

Danilo Travantti Employee ID K0W002  
 Job Title Sales Manager

---



Previous Month
05 - May
2009
Next Month

Sunday	Monday	Tuesday	Wednesday	Thursday	Friday	Saturday
					K08HRS <b>1</b> 8:00AM- 5:00PM	OFF <b>2</b>
OFF <b>3</b>	K08HRS <b>4</b> 8:00AM- 5:00PM	K08HRS <b>5</b> 8:00AM- 5:00PM	K08HRS <b>6</b> 8:00AM- 5:00PM	K08HRS <b>7</b> 8:00AM- 5:00PM	K08HRS <b>8</b> 8:00AM- 5:00PM	OFF <b>9</b>
OFF <b>10</b>	K08HRS <b>11</b> 8:00AM- 5:00PM	K08HRS <b>12</b> 8:00AM- 5:00PM	K08HRS <b>13</b> 8:00AM- 5:00PM	K08HRS <b>14</b> 8:00AM- 5:00PM	K08HRS <b>15</b> 8:00AM- 5:00PM	OFF <b>16</b>

This example illustrates the fields and controls on the Monthly Schedule page (2 of 2).

OFF <a href="#">17</a>	K08HRS <a href="#">18</a> 8:00AM- 5:00PM	K08HRS <a href="#">19</a> 8:00AM- 5:00PM	K08HRS <a href="#">20</a> 8:00AM- 5:00PM	K08HRS <a href="#">21</a> 8:00AM- 5:00PM	K08HRS <a href="#">22</a> 8:00AM- 5:00PM	OFF <a href="#">23</a>
OFF <a href="#">24</a>	K08HRS <a href="#">25</a> 8:00AM- 5:00PM 	K08HRS <a href="#">26</a> 8:00AM- 5:00PM	K08HRS <a href="#">27</a> 8:00AM- 5:00PM	K08HRS <a href="#">28</a> 8:00AM- 5:00PM	K08HRS <a href="#">29</a> 8:00AM- 5:00PM	OFF <a href="#">30</a>
OFF <a href="#">31</a>						

**Legend**

 Approved Training     Planned Absence     Holiday    OFF Scheduled OFF Day

## Monthly Schedule - Daily Detail Page

Use the Monthly Schedule - Daily Detail page (SCH\_EE\_DAILY) to view schedule details for a day.

Navigation:

**Click a Date link on the Monthly Schedule page.**

This example illustrates the fields and controls on the Monthly Schedule - Daily Detail page. You can find definitions for the fields and controls later on this page.

Monthly Schedule									
Schedule Detail for 05/05/2009									
Danilo Travanti Sales Manager					Employee ID K0W002 Empl Record 0				
Primary Schedule									
Schedule Detail 									
Shift ID	Taskgroup	Off Shift	In	Meal	In	Out	Time Zone	Sched Hrs	More
K08HRS		<input type="checkbox"/>	8:00:00AM	12:00:00PM	1:00:00PM	5:00:00PM		8.00	More
Alternate Schedule									
No schedule data for today									
Training Details									
No training data for today									
Absence Details									
No absence data for today									
Holiday Details									
No holiday data for today									

On the Monthly Schedule page, if a punch or flex schedule is displayed for the day, the daily cell of the monthly schedule displays the **Shift ID**, the number of **Scheduled Hours**, and the start and end time of the shift. If an elapsed schedule for the day is displayed, the system displays the **Shift ID** and **Scheduled Hours** in the daily cell of the month. If there is more than one shift for the day, the daily cell displays *More shifts...* and all the shift information is displayed on the Daily Detail page.

Users can link to their Schedule Preferences page from the Monthly Schedule page to update or view their preferences. Users can use the **Notify** button from the Monthly Schedule or Daily Detail pages, to alert their manager of changes they would like made for their schedule. Employees can also navigate to other self service and time reporting pages from the Monthly Schedule page.

The user can click on the calendar date to drill into the daily detail of the schedule. On the Daily Detail page the user can view details of the primary or alternate schedule. Training details from Training Administration or Learning Management are displayed with the start and end time of the training. Absence details from PeopleSoft Absence Management or leave reported for Base Benefits is displayed with the number of hours for the absence. Holiday details are displayed with the name of the holiday and the number of hours for the holiday.

---

## Setting Up User Preferences

This section provides an overview of using user preferences and discusses how to set up user preferences.

### Pages Used to Set Up User Preferences

<i>Page Name</i>	<i>Definition Name</i>	<i>Usage</i>
<a href="#">Time Reporting Preferences Page</a>	TL_TR_EE_PREF	Enables employees to view and update their time reporting preferences.
<a href="#">Schedule Preferences Page</a>	SCH_EE_PREF	Enables employees to view and update their schedule related preferences.
<a href="#">Send Notification Page</a>	PT_WF_NOTIFY	Enables employees to email managers, supervisors, or other employees when they change their user preferences.

### Understanding the User Preferences Page

The User Preferences page is used by employees to set up their schedule and time reporting preferences, such as preferred shifts and times, and time related defaults to display on the Timesheet page.

When setting up or changing an employee's schedule, a manager can view an employee's schedule preferences in the Manage Schedules feature, and take that information into account for future schedule creation and changes.

When a manager is viewing or reporting time for an employee using the Timesheet page, certain time reporting preferences that the employee sets up will appear on the Timesheet page, such as Start Day of Week and Task Values.

Employees can also email managers, supervisors, or other employees when they change their user preferences.

## Time Reporting Preferences Page

Use the Time Reporting Preferences page (TL\_TR\_EE\_PREF) to enable employees to view and update their time reporting preferences.

Navigation:

**Self Service > Time Reporting > User Preferences > Time Reporting Preferences**

This example illustrates the fields and controls on the Time Reporting Preferences page. You can find definitions for the fields and controls later on this page.

The screenshot shows the 'Time Reporting Preferences' page for user Betty Locherty (ID KU0007). The page has two tabs: 'Time Reporting Preferences' (selected) and 'Schedule Preferences'. The settings are as follows:

- \*TRC Presentation: Show CODE - Description
- Time Prepopulation Method: [Dropdown]
- \*Default Timesheet Display: Weekly
- \*Start Day of Week: 1 - Monday
- \*Save For Later Option: Prompt For Validation
- \*Submit Option: Confirm

Below the settings is a 'Task Value Defaults' section with a help icon and a toolbar containing 'Personalize', 'Find', 'View All', and navigation buttons. Below that is a 'Taskgroup' table with columns for '\*Taskgroup' and 'Description'. The table is currently empty.

Employees use this page to set up and maintain their specific time reporting preferences and configuration options. The preferences that employees specify on this page will be reflected on various time reporting pages such as the Timesheet, Mass Time, Web Clock, and the Adjust Paid Time pages.

<b>Field or Control</b>	<b>Description</b>
<b>TRC Presentation</b>	<p>Select <i>Show CODE - Description</i> (the default setting), <i>Show Description - CODE</i>, or <i>Show Description Only</i> . This configuration option determines in what order the Time Reporting Code is displayed and sorted when viewing the Time Reporting Code field on the Timesheet, Mass Time, Web Clock, or Adjust Paid time pages.</p> <hr/> <p><b>Note:</b> When you select <i>Show Description Only</i> the system warns you if there is another TRC program with the same description. The system does not prevent you from saving this TRC Presentation option.</p>

<b>Field or Control</b>	<b>Description</b>
<b>Time Pre-population Method</b>	<p>Select a value to automatically populate the employee Timesheet page with default information to use when reporting time.</p> <p>Valid values are <i>Task Values</i>, <i>Prior period</i>, and <i>Schedule Information</i>.</p> <hr/> <p><b>Note:</b> Under task value defaults, select the Taskgroup from which the Task Values can be defaulted on the Timesheet. On the second tab Task reporting elements, enter the task values you want to pre-populate on the timesheet and leave the rest empty save the page to populate the required field in Timesheet. This has no effect if the commitment accounting is used or not.</p> <hr/> <p>When opening the page, the Timesheet will automatically populate an employee's default Taskgroup that is specified on the Maintain Time Reporter Data page. If an employee is a task template reporter, then when opening the Timesheet the system will look at the Employee User Preferences page to see if any default task values have been specified.</p> <p>If an employee is a task profile reporter, the Timesheet will just use what is defined as the default task profile either from Maintain Time Reporter Data or from the taskgroup displayed on the Timesheet, and not look at the User Preferences.</p> <p>Select <i>Prior Period</i> to provide default values from the prior period. This pre-population method works for employee access, not for manager access of an employee timesheet.</p> <p>Select <i>Schedule Information</i> to provide default values from the employee's current schedule. This pre-population method works for employee access, not for manager access of an employee timesheet.</p> <p><i>Blank</i> (which is the default) to specify no default value.</p>
<b>Default Timesheet Display</b>	<p>Choose <i>Daily</i>, <i>Weekly</i>, or <i>Time Reporting Period</i>. <i>Weekly</i> is the default. This option determines if time displays on the Timesheet in a day, week, or time period format.</p>
<b>Start Day of Week</b>	<p>Select the default day for the week to start when using the Timesheet page. This field is applicable only when you select <i>Weekly</i> in the <b>Default Timesheet Display</b> field.</p>
<b>Save for Later Option</b>	<p>Specify whether timesheets are validated when a user selects the Save for Later button on a timesheet. Values are: <b>Always Validate</b>, <b>Never Validate</b>, <b>Prompt for Validation</b>.</p>



<b>Field or Control</b>	<b>Description</b>
<b>Submit Option</b>	<p>This field specifies whether the system always displays a confirmation page when a timesheet is submitted successfully</p> <p>Choose <b>Confirm</b> to display the Timesheet - Submit Confirmation page when a timesheet is successfully submitted. Choose <b>Skip Confirmation</b> to never show the Timesheet - Submit Confirmation page.</p> <p>The <b>Submit Option</b> selection on the Time Reporting Template page overrides any selection made here.</p> <p>See: <a href="#">Creating Time Reporting Templates</a></p>

---

**Note:** If Time and Labor is not installed, the Time Reporting Preferences page is hidden.

---

## Understanding Task Value Defaults

Use this section with the time pre-population method of task values. You can enter one or more rows for the same taskgroup, or enter a set of default task values for different taskgroups.

When you enter a taskgroup, the display of fields is dependent on the time reporting templates associated with that taskgroup. If the elapsed and punch reporting templates have **Task Profile** selected, then no task values appear. If one or both of the time reporting templates designate **Task Template**, then the default task values can be used. If task values can be used, they depend on the task template ID associated with each taskgroup entered. The task template drives the display of the Task Reporting Elements and ChartFields folder tabs in this section. Task values entered on the Time Reporting Preferences page is only be utilized for timesheet display if the Time Prepopulation method is Task Values.

## Schedule Preferences Page

Use the Schedule Preferences page (SCH\_EE\_PREF) to enables employees to view and update their schedule related preferences.

Navigation:

**Self Service > Time Reporting > User Preferences > Schedule Preferences**

This example illustrates the fields and controls on the Schedule Preferences page. You can find definitions for the fields and controls later on this page.

All fields on this page are optional, with the exception of the **Telephone/Email** option and the **Willing to work** fields. The **Willing to work** fields have a default value of *No*.

### Contact Preference

The employee's preferred phone number and email address appear. To change them, access the **Update your contact information** link, which takes the user to the Personal Information page. Phone, email, and other contact information can be viewed and modified. The link to employee's contact information is only available for editing if eProfile is installed on the General Installation page.

### Schedule Preferences

For each day of the week, enter the shift or start and end times you prefer to work.

<i>Field or Control</i>	<i>Description</i>
Willing to work a compressed work week	Define whether or not you would be willing to work a compressed work week.

<b>Field or Control</b>	<b>Description</b>
Shift	<p>Enter the shift you prefer to work. This field is populated based on the particular <b>EmplID</b>. If the current user has a schedule assigned, the only shifts available in the drop-down list box are those shifts that correspond to the user's schedule ID and the SetID determined by the user's schedule group. If the user has no schedule assigned, the <b>Shift ID</b> field is hidden.</p> <hr/> <p><b>Note:</b> There is no validation between start and end times and shifts. No logic exists to verify that the times entered fall within the shift, if one is entered.</p> <hr/>
Start Time, End Time	Enter the start and end times you prefer to work.
Willing to work overtime	Enter whether you would be willing to work overtime.
Willing to work double shifts	Enter whether you would be willing to work a double shift.

## Send Notification Page

Use the Send Notification page (PT\_WF\_NOTIFY) to enables employees to email managers, supervisors, or other employees when they change their user preferences.

Navigation:

- **Self Service > Time Reporting > User Preferences > Notify button**
- **Self Service > Time Reporting > User Preferences > Schedule Preferences tab > Notify button**

This example illustrates the fields and controls on the Send Notification page. You can find definitions for the fields and controls later on this page.

**Workflow Notification**

---

**Send Notification**

Type names or email addresses in the To, CC, or BCC fields, using a semi-colon as a separator.  
 Click LOOKUP RECIPIENT to search for a name. Click DELIVERY OPTIONS to view or change the method of the send.

<div style="border: 1px solid #ccc; padding: 5px; margin-bottom: 5px;"> <p><b>Notification Details</b></p> <p>To: <input type="text"/></p> <p>CC: <input type="text"/></p> <p>BCC: <input type="text"/></p> <p>Priority: <input type="text"/></p> <p>Subject: <input type="text" value="Employee Preferences - Comments"/></p> <p>Template: <input type="text" value="Please review the comments below, sent by Betty Locherty (Employee ID# KU0007). You can view this employee's schedule preferences at http://slc04sap.us.oracle.com:8000/psp/h92jalrmx/EMPLO..."/></p> <p>Message: <input type="text"/></p> </div>	<p><a href="#">Lookup Recipient</a></p> <p><a href="#">Delivery Options</a></p> <p><input type="checkbox"/> RichText</p>
---	--

Click OK to send this notification and exit this page. Click Cancel to exit this page without sending a notification.  
 Click Apply to send this notification and remain on this page.

Select the **Notify** button to access the Send Notification Page. Use this page and the links provided to email managers, supervisors, or other employees when you change your user preferences.

## Setting Up Preferences Using Fluid

This section provides an overview of using My Preferences (TL\_TR\_PREF\_FLU) and discusses how to set the Time Reporting and Preferences.

### Pages Used to Set Up Preferences Using Fluid

<i>Page Name</i>	<i>Definition Name</i>	<i>Usage</i>
<u>Time Reporting Preferences Page</u>	TL_TR_PREF_FLU TL_TR_PREF_DTL_FL	Enables employees to view and update their time reporting preferences.
<u>Schedule Preferences Page</u>	SCH_EE_USERPREF_FL	Enables employees to view and update their schedule related preferences.

## Understanding the My Preferences Page

The Time and Labor My Preferences page is used by employees to set up their schedule and time reporting preferences, such as preferred start day of the week, and time related defaults to display on the Time reporting pages.

When a Time Reporter is viewing or reporting time using the Timesheet page, certain time reporting preferences setup appear on the Timesheet page, such as Start Day of Week and Task Values.

---

**Note:** The Time Reporters can specify whether they want to be contacted through email or phone, when there is a change in schedule.

---

By default, the **My Preferences** page opens the **Time Reporting Preferences** tab.

## Time Reporting Preferences Page

Use the Time Reporting Preferences page (TL\_TR\_PREF\_FLU and TL\_TR\_PREF\_DTL\_FL) to enable employees to view and update their time reporting preferences.

Navigation:

Select the Actions button from the page banner. From the Actions menu, select **My Preferences > Time and Labor**

This example illustrates the fields and controls on the My Preferences - Time Reporting Preferences page. You can find definitions for the fields and controls later on this page.

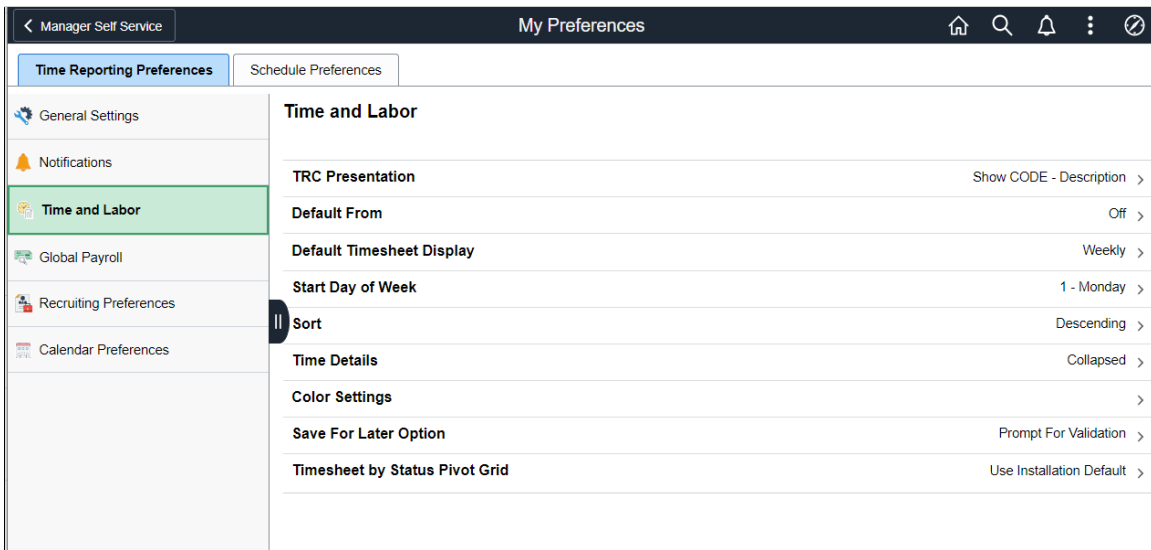

Employees use this page to set up and maintain their specific time reporting preferences and configuration options. The preferences that employees specify on this page will be reflected on various time reporting pages such as the Timesheet, Mass Time, Web Clock, and the Adjust Paid Time pages.

<b>Field or Control</b>	<b>Description</b>
<b>TRC Presentation</b>	Select to view or update the section for TRC Presentation.

<b>Field or Control</b>	<b>Description</b>
<b>Default From</b>	Select to view or update the section for Default From.
<b>Default Timesheet Display</b>	Select to view or update the section for Default Timesheet Display.
<b>Start Day of Week</b>	Select to view or update the section for Start Day of Week.
<b>Sort</b>	Select to view or update the section for Sort.
<b>Time Details</b>	Select to view or update the section for Time Details.
<b>Color Settings</b>	Select to view or update the section for Color Settings.
<b>Save for Later Option</b>	Select to view or update the section for Save for Later Option.
<b>Timesheet By Status Pivot Grid</b>	Select to view or update the section for Timesheet By Status Pivot Grid.

## TRC Presentation

This configuration option determines in what order the Time Reporting Code is displayed and sorted when viewing the Time Reporting Code field on the Enter Time, Report Time, Weekly Time and Time Summary pages.

This example illustrates the fields and controls on the TRC Presentation section of the Time Reporting Preferences page. You can find definitions for the fields and controls later on this page.

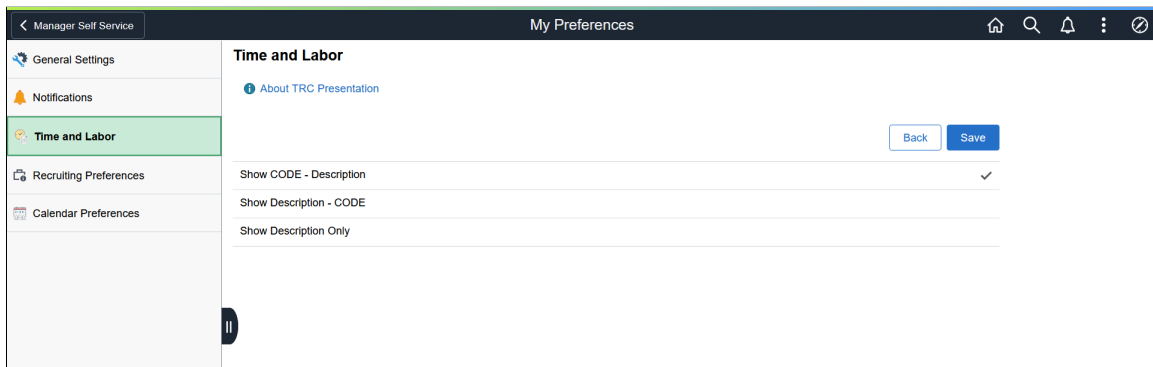

<b>Field or Control</b>	<b>Description</b>
<b>Show CODE - Description</b>	This configuration option shows the code first and then its description.

<b>Field or Control</b>	<b>Description</b>
<b>Show Description - CODE</b>	This configuration option shows the description first followed by the code.
<b>Show Description Only</b>	This shows only the description.  <b>Note:</b> The system warns time reporters if there is another TRC program with the same description. The system does not prevent from saving this TRC Presentation option.
<b>Back</b>	Go back to the Time Reporting Preferences page.
<b>Save</b>	Save the selected preferences  <b>Note:</b> The <b>Save</b> button will only be enabled if any change is made to the page.

## Default From

Based on the preferences that are selected here in **Default From**, the Enter Time, Report Time and Weekly Time pages will default the values.

**Note:** If an employee is a task profile reporter, the Timesheet will just use what is defined as the default task profile either from Maintain Time Reporter Data or from the taskgroup displayed on the Timesheet, and not look at the User Preferences.

This example illustrates the fields and controls on the Default From section of the Time Reporting Preferences page. You can find definitions for the fields and controls later on this page.

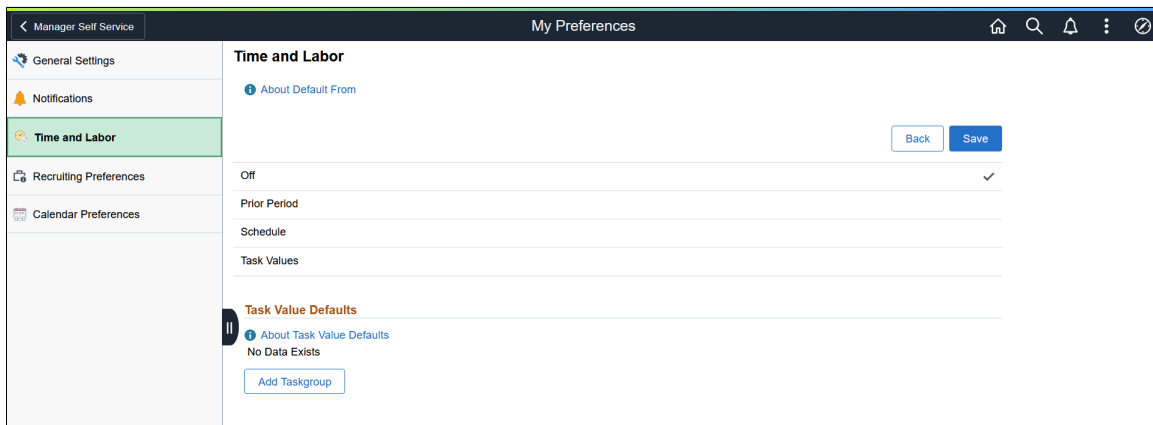

<b>Field or Control</b>	<b>Description</b>
<b>Off</b>	Default option to specify no default value.

<b>Field or Control</b>	<b>Description</b>
<b>Prior Period</b>	Defaults information from the last period. This pre-population method works for employee access, not for manager access of an employee timesheet.
<b>Schedule</b>	Defaults information from the time reporter's current schedule.
<b>Task Values</b>	<p>Task element values are automatically populated from the taskgroup and tasks listed in the Task Value Defaults section of Time Reporting Preferences.</p> <hr/> <p><b>Note:</b> If default task values are setup and values are not selected as an option, then the user receives a warning each time while leaving the page.</p> <hr/>
<b>Add Taskgroup</b>	Select to open a modal window to add a taskgroup on the Taskgroup page (TL_USRPREF_TSK_SCF).
<b>Back</b>	Go back to the Time Reporting Preferences page.
<b>Save</b>	<p>Save the selected preferences</p> <hr/> <p><b>Note:</b> The <b>Save</b> button will only be enabled if any change is made to the page.</p> <hr/>

This example illustrates the fields and controls on the Taskgroup page. You can find definitions for the fields and controls later on this page.

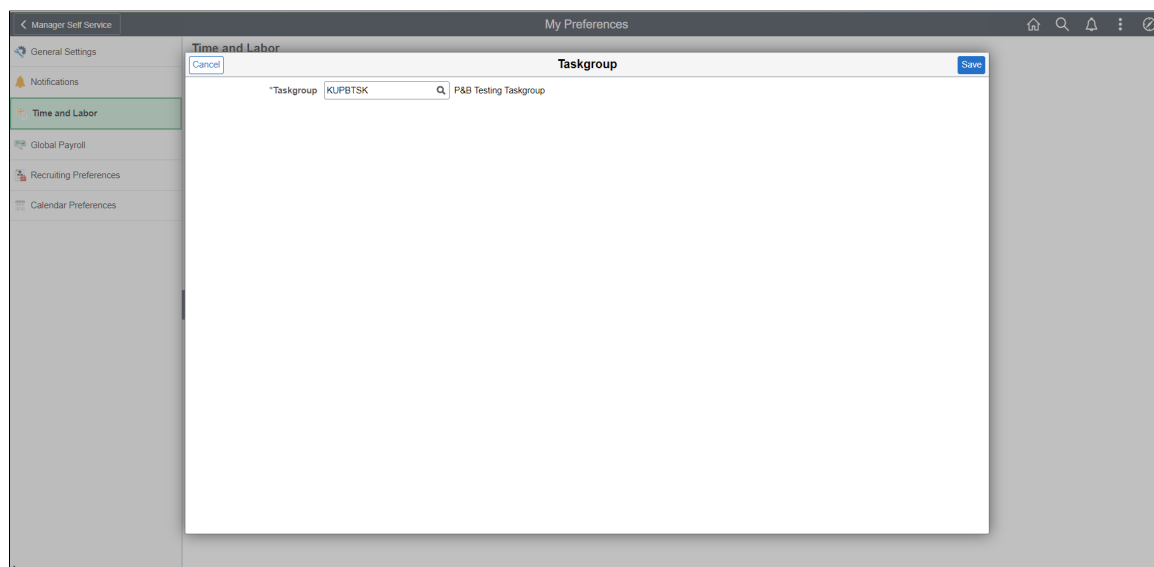



## Default Timesheet Display

The Default Timesheet Display page determines if time displays on the Enter Time page in a weekly, bi-weekly, monthly or time period format.

This example illustrates the fields and controls on the Default Timesheet Display section of the Time Reporting Preferences page. You can find definitions for the fields and controls later on this page.

<b>Field or Control</b>	<b>Description</b>
<b>Bi-Weekly</b>	Select to display the time on the Enter Time page in bi-weekly format.
<b>Monthly</b>	Select to display the time on the Enter Time page in monthly format.
<b>Weekly</b>	Select to display the time on the Enter Time page in weekly format.
<b>Time Reporting Period</b>	Select to display the time on the Enter Time page in a time period format defined on the Workgroup.
<b>Back</b>	Go back to the Time Reporting Preferences page.
<b>Save</b>	Save the selected preferences  <b>Note:</b> The <b>Save</b> button will only be enabled if any change is made to the page.

## Start Day of Week

Use Start Day of Week to specify the first day of the week on the Enter Time page.

Select the default day for the week to start when using the Timesheet page. This field is applicable only when the time reporters select *Weekly* in the **Default Timesheet Display** field.

Save the selection after choosing the start day of the week using the **Save** button.

---

**Note:** The **Save** button will only be enabled if any change is made to the page.

---

This example illustrates the fields and controls on the Start Day of Week section of the Time Reporting Preferences page. You can find definitions for the fields and controls later on this page.

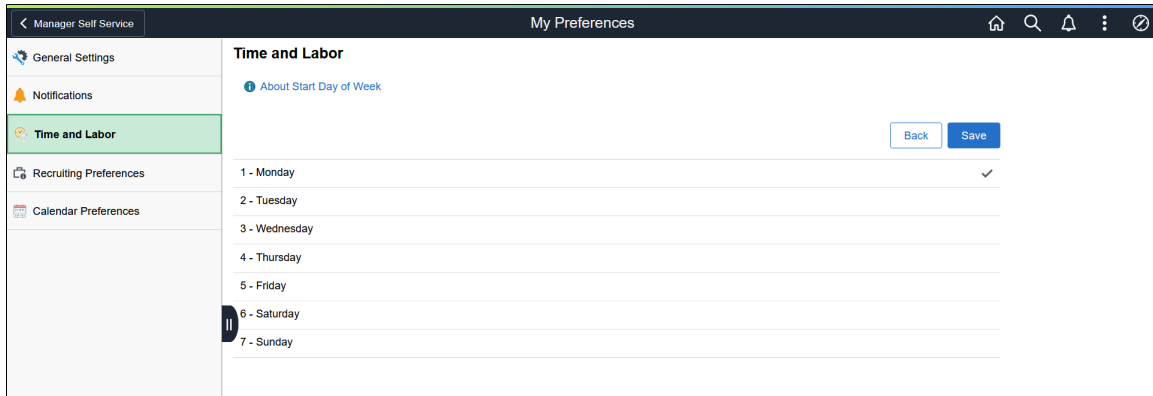

## Sort

Use sort to select the display of reported time in ascending or descending order.

This example illustrates the fields and controls on the Sort section of the Time Reporting Preferences page.

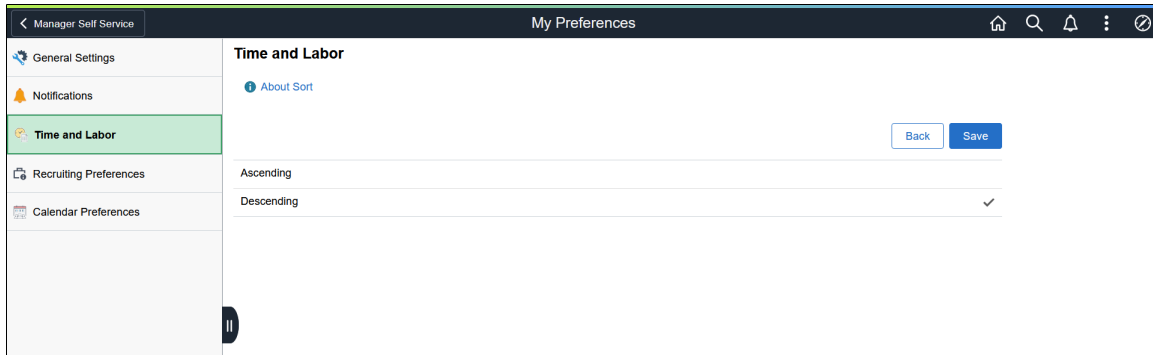

Save the selection to update the sorting preference.

---

**Note:** The **Save** button will only be enabled if any change is made to the page.

---

## Time Details

Use to expand or collapse the Time Details fields for Report Time and Weekly Time entry pages.

This example illustrates the fields and controls on the Time Details section of the Time Reporting Preferences page.

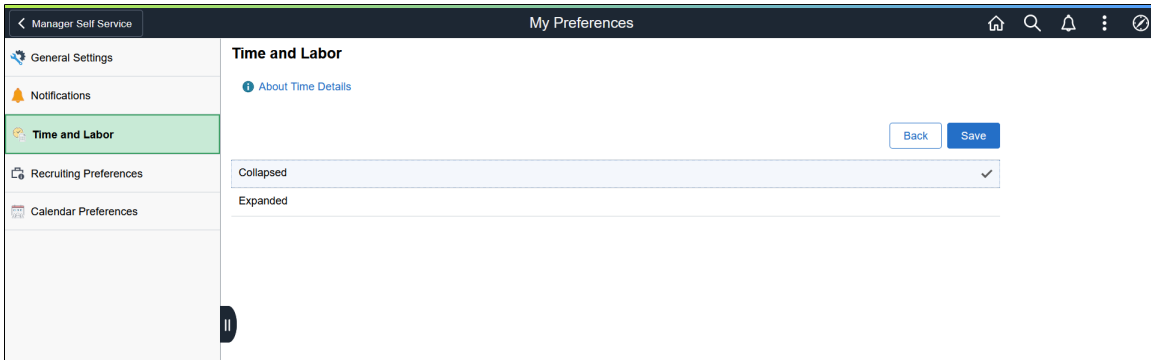

**Note:** This is applicable to Daily Time and Weekly Time Entry pages and not to the Enter Time page.

Save the selection to update the time details preference.

**Note:** The **Save** button will only be enabled if any change is made to the page.

### Color Settings

Choose a color or pattern for reported time, scheduled time and deviations to their schedule to be displayed in the status bar of the Color Settings page (TL\_USER\_COLOR\_SCF).

This example illustrates the fields and controls on the Color Settings page displayed from the Time Reporting Preferences page.

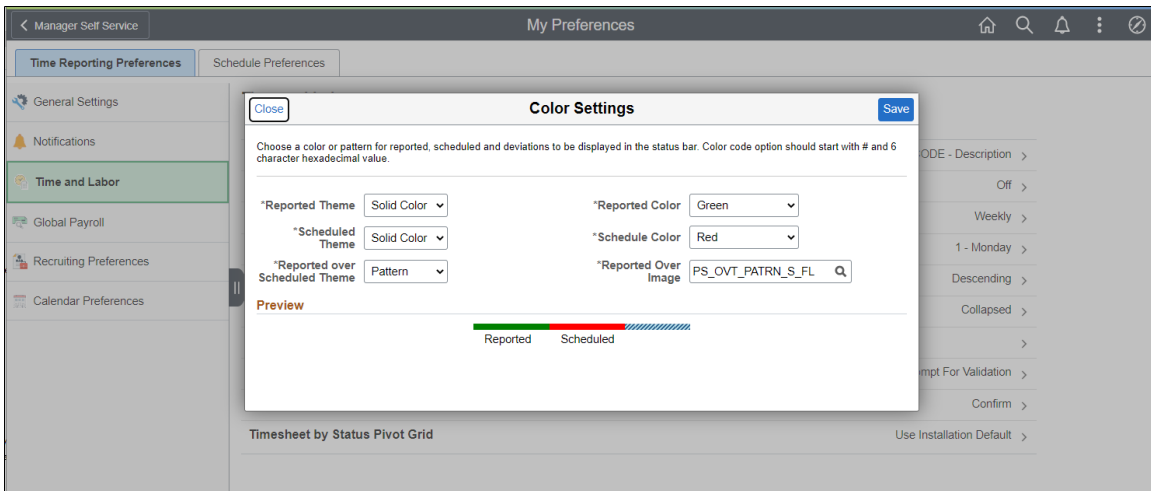

### Save For Later Option

Specify whether timesheets are validated when a user selects the Save for Later button on a timesheet.

This example illustrates the fields and controls on the Save For Later section of the Time Reporting Preferences page. You can find definitions for the fields and controls later on this page.

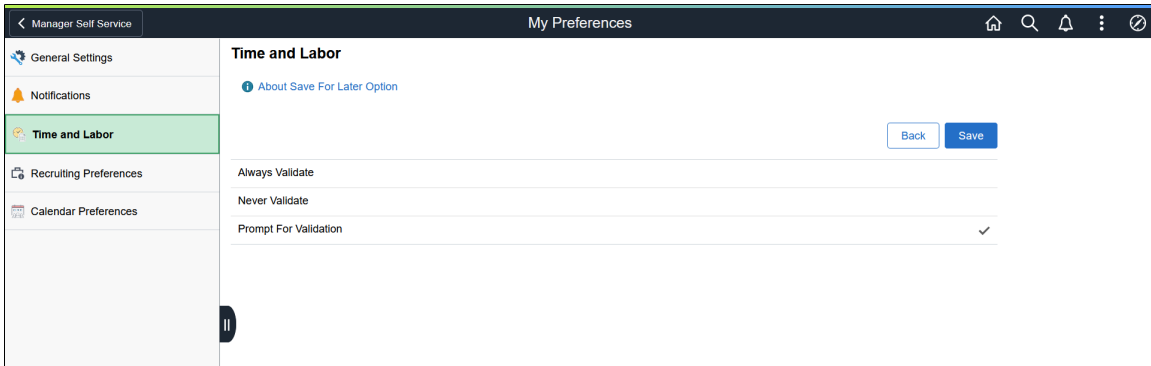

<b>Field or Control</b>	<b>Description</b>
<b>Always Validate</b>	Select to always validate when saving.
<b>Never Validate</b>	Save the time without validation.
<b>Prompt for Validation</b>	Ask whether the entered time should be validated.
<b>Back</b>	Go back to the Time Reporting Preferences page.
<b>Save</b>	Save the selected preferences <hr/> <b>Note:</b> The <b>Save</b> button will only be enabled if any change is made to the page. <hr/>

### Timesheet By Status Pivot Grid

Use this section to enable real-time processing for the Timesheet by Status pivot grid.

This example illustrates the fields and controls on the Timesheet By Status Pivot Grid section of the Time Reporting Preferences page. You can find definitions for the fields and controls later on this page.

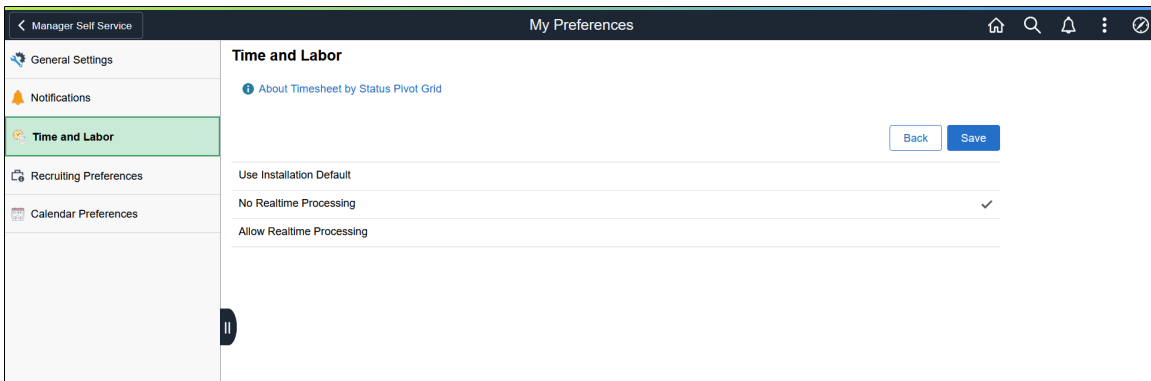

<b>Field or Control</b>	<b>Description</b>
<b>Use Installation Default</b>	Select to load the data according to the time and labor installation set by the administrator.
<b>No Realtime Processing</b>	Select to load the data according to the last staging run on the pivot grids.
<b>Allow Realtime Processing</b>	Select to have the system load the most recent reported time on the pivot grids.
<b>Back</b>	Go back to the Time Reporting Preferences page.
<b>Save</b>	Save the selected preferences <hr/> <b>Note:</b> The <b>Save</b> button will only be enabled if any change is made to the page. <hr/>

## Schedule Preferences Page

Use the Schedule Preferences page (SCH\_EE\_USERPREF\_FL) to enable employees to view and update their schedule related preferences.

Navigation:

Select the Actions button from the page banner. From the Actions menu, select **My Preferences > Time and Labor**. Select the **Schedule Preferences** tab.

This example illustrates the fields and controls on the Schedule Preferences page. You can find definitions for the fields and controls later on this page.

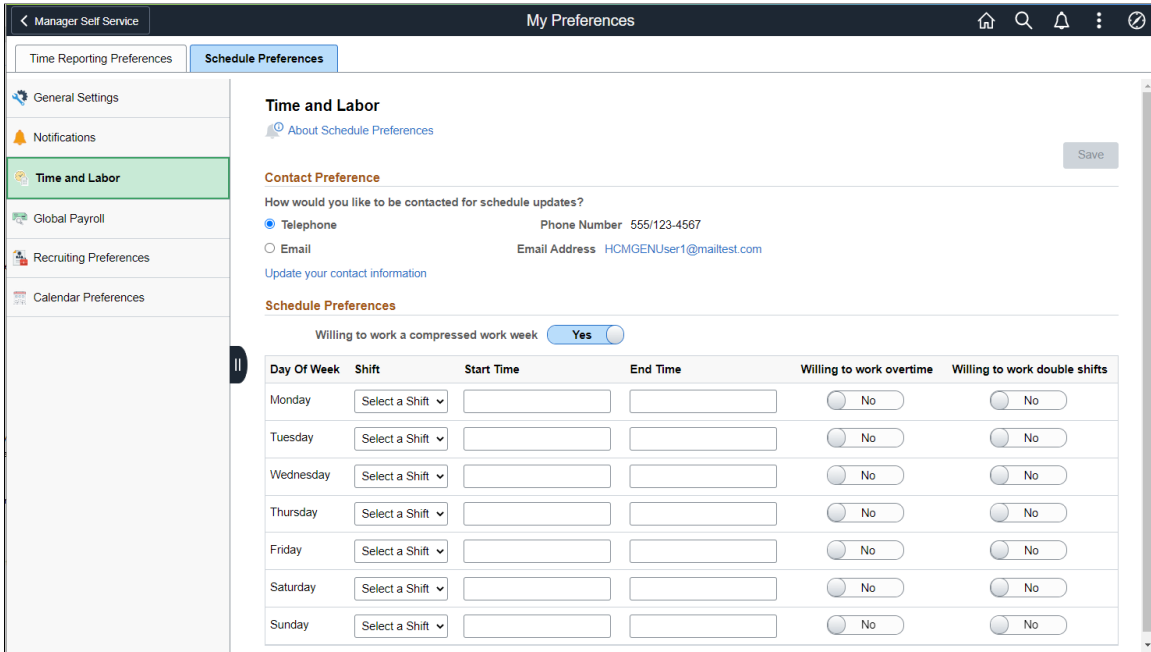

All fields on this page are optional, with the exception of the **Telephone/Email** option and the **Willing to work** fields. The **Willing to work** fields have a default value of *No*.

### Contact Preference

The employee's preferred phone number and email address appear. To change them, access the **Update your contact information** link, which takes the user to the **Contact Details** page. Phone, email, and other contact information can be viewed and modified. The link to employee's contact information is only available for editing if eProfile is installed on the General Installation page.

### Schedule Preferences

For each day of the week, enter the shift or start and end times the time reporters prefer to work.

<i>Field or Control</i>	<i>Description</i>
<b>Willing to work a compressed work week</b>	Allows the time reporter to specify whether they are willing to work on a compressed work week.

<b>Field or Control</b>	<b>Description</b>
<b>Shift</b>	<p>Enter the shift preference. This field is populated based on the particular <b>EmpIID</b>. If the current user has a schedule assigned, the only shifts available in the drop-down list box are those shifts that correspond to the user's schedule ID and the SetID determined by the user's schedule group. If the user has no schedule assigned, the <b>Shift ID</b> field is hidden.</p> <hr/> <p><b>Note:</b> There is no validation between start and end times and shifts. No logic exists to verify that the times entered fall within the shift, if one is entered.</p> <hr/>
<b>Start Time, End Time</b>	Enter the start and end times the time reporter prefers to work.
<b>Willing to work overtime</b>	Enter whether you would be willing to work overtime.
<b>Willing to work double shifts</b>	Enter whether you would be willing to work a double shift.

**Note:** The **Save** button will only be enabled if any change is made to the page.

## Reporting Time

This section lists common elements and discusses how to report time.

**Note:** This feature has been replaced by the Report Time functionality in Fluid. For more information, see [Using PeopleSoft Fluid User Interface for Time Reporting as an Employee](#).

## Pages Used in Reporting Time

<b>Page Name</b>	<b>Definition Name</b>	<b>Usage</b>
<u>Timesheet Page</u>	TL_MSS_TIMESHEET TL_RPTD_PCH TL_RPTD_ELP	Report time and task details for a day, week, or time period for either punch or elapsed time reporters.
Select Job Title Page	CO_MULTI_JOB_SRCH	Enables employees with multiple jobs to select the job for which they want to view or report time. The page lists both punch time and elapsed time jobs, and includes terminated jobs.

<b>Page Name</b>	<b>Definition Name</b>	<b>Usage</b>
<u>Web Clock - Enter Punch Page</u>	TL_WEBCLK_ENTR_PCH	Enables employees to enter a single In, Break, Meal, Out, or Transfer punch. Employees can provide time and task detail when entering punches. Includes links to pages for viewing overtime requests and the holiday schedule.
Save Confirmation Page	TL_WEBCLK_CONFIRM	Confirms the date, punch type, time zone, and punch type reported through the Web Clock - Enter Punch page.
<u>Mass Time - Select Time Reporting Method Page</u>	TL_MASS_TIME_SELF TL_MASS_SELF_SAVE	Specify the range of dates and the method for reporting time.
<u>Mass Time - Report Time Page</u>	TL_MASS_TIME_SELF TL_MASS_SELF_SAVE	<ul style="list-style-type: none"> <li>Indicate additional attributes about the time that you are reporting.</li> <li>Report additional Time Reporting Elements and Task Elements.</li> </ul>
<u>Compensatory Time Page</u>	TL_COMPTIME_PNL	View compensatory time balance and expiration information.

## Common Elements Used in this Section

<b>Field or Control</b>	<b>Description</b>
<b>Time Reporting Elements and Task Reporting Elements</b>	The self-service pages that <i>employees</i> use to report time include fields for selecting time reporting and task reporting elements. The employee's time reporting template determines which fields appear on the self-service pages. Should data be reported in error for invalid time or task elements (through TCD, Mass Time, or Rapid Time Reporting pages, for example), those time reporting or task fields will appear so that employees can make corrections, even if those fields are not chosen on the employee's time reporting template.
<b>Timesheet Page</b>	Both punch time and elapsed time are reported using the Timesheet navigation component. When selected, the system determines whether the employee has multiple jobs. If multiple jobs exist, the Select Job Title page appears, with links for each job. If the time reporter has only one job, the Select Job Title page does not appear, and the time reporter is taken directly to the appropriate Timesheet page. The Timesheet page displays either the punch time page (TL_RPTD_PCH) or elapsed time page (TL_RPTD_ELP) based on the Time Reporter Type value selected on the Create or Maintain Time Reporter Data pages.



## Timesheet Page

Use the Timesheet page (TL\_MSS\_TIMESHEET) (TL\_RPTD\_PCH) (TL\_RPTD\_ELP) to report time and task details for a day, week, or time period for either punch or elapsed time reporters.

Navigation:

**Self Service > Time Reporting > Report Time > Timesheet > Timesheet**

This example illustrates the fields and controls on the Timesheet page. You can find definitions for the fields and controls later on this page.

The screenshot shows the Timesheet page for Samuel John, Senior Manager: Finance. Employee ID is KU0431, Empl Record is 0, and Earliest Change Date is 01/02/2012. The page includes a 'Select Another Timesheet' section with a 'View By' dropdown set to 'Week', a 'Date' field set to 02/11/2013, and buttons for 'Previous Week', 'Next Week', 'Print Timesheet', and 'Punch Timesheet'. Below this is a table for reporting time from Monday 02/11/2013 to Sunday 02/17/2013, with columns for days and a 'Total' column. The table shows 0.00 hours reported. There are 'Submit' and 'Apply Rules' buttons. At the bottom, there are tabs for 'Reported Time Status', 'Summary', 'Leave / Compensatory Time', 'Exceptions', and 'Payable Time'. The 'Reported Time Status' tab is active, showing a table with columns for Date, Total, TRC, Description, Sched Hrs, and Comments. The table shows 0.000000 total hours and 0.00 scheduled hours.

The Days, Total, TRC and Type fields are based on the related time reporting template. The remaining fields are based on the task reporting template.

<b>Field or Control</b>	<b>Description</b>
<b>&lt;Job Title&gt;</b>	Placing your mouse over the Employee’s Job Title displays a pop-up window containing job information specified on the Self Service Header Info page.  See: <a href="#">Self Service Header Info Page</a>
<b>View By</b>	The defaults for the View By field are set on the User Preferences page. This field may be display only, depending upon the settings for the time reporting template. Values are <i>Day, Week, or Time Period</i> .  See: <a href="#">Creating Time Reporting Templates</a>
<b>Date, Refresh</b>	If you change the <b>Date</b> field, click the <b>Refresh</b> button to update the page.

<b>Field or Control</b>	<b>Description</b>
<b>Previous Day, Previous Week, Previous Time Period, Next Day, Next Week, Next Time Period</b>	Use the requisite link to view the previous or next time reporting period.  If you use one of these links, additional text appears to let the user know that reported time is being entered for a prior or future period.
<b>Print Timesheet</b>	Select this link to print the Timesheet to a PDF file, in order to create a physical timesheet for signatures.
<b>Punch Timesheet or Elapsed Timesheet</b>	Select to switch the timesheet to either an elapsed time or a punch timesheet. This option may not be available, based on the configuration specified on the Time and Labor Installation page.  See: <a href="#">Setting Up System Defaults and Loading Dates</a>
<b>Show All Punch Columns</b>	Select this option to show all of the Punch Time columns on this spreadsheet. This option is only available on Punch Timesheets.  The Time Reporting Template page determines which Punch Columns are shown on the Punch Timesheet and whether the <b>Show All Punch Columns</b> button is available.  See: <a href="#">Creating Time Reporting Templates</a>
<b>Reported Hours</b>	This field is updated when the <b>Save for Later</b> or <b>Submit</b> buttons are clicked.
<b>Scheduled Hours</b>	The value is displayed when you access the Timesheet page.
<b>Total</b>	This field is updated when the <b>Save for Later</b> or <b>Submit</b> buttons are clicked. This field displays the total hours per row.
<b>Time Reporting Code</b>	If applicable enter a <b>Time Reporting Code</b> .
<b>Type</b>	This field is updated when the <b>Save for Later</b> or <b>Submit</b> buttons are clicked. It shows the TRC's related <b>Type</b> — <i>Amount, Hours, or Units</i> .
<b>Taskgroup</b>	If applicable, enter a related taskgroup.
<b>Billable</b>	Select this field if the hours entered are billable.
<b>Task Profile ID</b>	If applicable, enter a related task profile ID.

<b>Field or Control</b>	<b>Description</b>
<b>Apply Rules</b>	<p>Click this button to save your data and launch the Apply Online Rules process, which immediately applies the online rules for the time reporter to the time entered on this page. If absence event data is entered in the Absence Event grid, the Apply Online Rules process generates absence payable time with the status Estimated (E) or Needs Approval (NA)..</p> <p>If any exceptions are generated, the Manage Exceptions page is displayed automatically after the process completes.</p> <p>If no exceptions occur and payable time is created, the View Payable Time Detail page appears with the rows of estimated time that were created from the online rules. The Apply Online Rules process does not generate payable time estimates when the reported time has the status Needs Approval (NA).</p> <hr/> <p><b>Note:</b> This button is displayed only if the Run Online Rules feature is activated on the Time and Labor Installation page. See: <a href="#">Setting Up System Defaults and Loading Dates</a></p>
<b>Reported Time Status</b>	<p>The fields displayed are <b>Date, Status, Total, Time Reporting Code</b> and <b>Comments</b>. Click the icon in the <b>Comments</b> column to add a comment for a row.</p> <hr/> <p><b>Note:</b> This grid applies only to elapsed Timesheets (not punch).</p>
<b>Absence</b>	<p>Click this tab to display the Absence Events grid and Absence Balance grid and add absence information. Depending on the setup of Absence Management, you may be enabled to report, save, submit, and approve or deny (managers only) absence events within the range of the Timesheet dates.</p> <p>Balance information can include sick or vacation balances, and your absence entitlement balance if the time reporter is active in the Absence Management system.</p> <hr/> <p><b>Note:</b> This tab is displayed only if the Time and Labor system is integrated with Global Payroll or Absence Management.</p> <hr/> <p>See “Understanding the Absence Request Transactions” (PeopleSoft Absence Management).</p>
<b>Summary</b>	<p>Click this tab to show the Total Reported Hours values to obtain a summary of reported hours.</p>
<b>Leave / Compensatory Time</b>	<p>Select this tab to view leave and compensatory time balances as of the date specified for the timesheet. This balance may be positive or negative, depending on how the plan is set up and what has been reported. Select the View Detail icon to access the Compensatory Time page</p>

<b>Field or Control</b>	<b>Description</b>
<b>Attendance</b>	Select this tab to view a list of attendance violations for this employee.
<b>Save for Later</b>	Use this button to partially enter a timesheet and to complete at a later date. Enter information on the page each day and submit at the end of the reporting period. When using this button a message window may appear, asking whether the user would like to validate the time entered.
<b>Submit</b>	Use this button to submit the Timesheet.
<b>Clear</b>	Click this button to remove entries from the grid that have not been saved or submitted. This button only appears on Punch timesheets.
<b>Request Absence</b>	Click this link to access the Request Absence page. That page has a link to return to the Timesheet page.  See “Understanding the Absence Request Transactions” (PeopleSoft Absence Management).

---

**Note:** TRCs that are set up with the **Absence Flag** check box selected on the Time Reporting Codes - Definition page are not displayed on the online time reporting pages (Timesheet, WebClock, and Mass Time). Consequently, you cannot report time using an Absence TRC on these pages. TRCs that have the **Rules Only TRC** check box selected on the Time Reporting Codes - Definition page are not displayed on any of the time reporting or scheduling pages, except the Adjust Paid Time page.

---

## Timesheet Display: Self-Service Versus Manager Self-Service

The Timesheet page displays different information when accessed from the Self-Service component compared to the Manager Self-Service component. The User Preferences page also plays an important role in the Timesheet display.

### Task Value Prepopulation

The following is true when viewing either the Self-Service Timesheet (as an employee) or the manager Timesheet (a manager viewing an employee's timesheet):

- To determine what task information to display on the timesheet, the system needs to determine if the employee is a task template or task profile reporter and if task value defaults are present in User Preferences. The determination of the employee's type of task reporting is first based on whether the page displayed is the Punch or Elapsed Timesheet. This page display is determined by the employee's time reporter type of Punch or Elapsed on the Maintain Time Reporter Data page.
- Then, depending on the elapsed or punch timesheet display, the system checks for that same type of time reporting template on the Maintain Time Reporter Data page. If no time reporting template exists on Maintain Time Reporter Data, it will check for the default time reporting template on the **Task Default Values** group box of the Time Reporting Preferences page, or for one on the employee's

default taskgroup on Maintain Time Reporter Data. The time reporting template determines if the task profile or the task elements should appear on either the punch or elapsed timesheet.

- If the derived time reporting template is setup to use a task template, then any task information that is populated in the **Task Default Values** group box of the Time Reporting Preferences page will be used, when the time prepopulation method of task values is specified. If no default task values are specified on Time Reporting Preferences, then the timesheet displays the employee's default taskgroup and related task element fields. If there are multiple rows defined for **Task Default Values**, they will be displayed as multiple rows on either the Punch or Elapsed Timesheet
- If an employee is a Task Profile reporter, the Timesheet will just use what is defined as the default Task Profile, either from Maintain Time Reporter Data or from the taskgroup displayed on the Timesheet, and not look at the User Preferences.

## Examples of Timesheet display with User Preferences

The system is configured as follows:

<b>Time Reporter Data</b>			
	<i>Time Reporter Type</i>	<i>Time Reporting Template</i>	<i>Default Taskgroup</i>
<i>ELAPSED</i>	Enabled	Task Element Reporting	Task Element Reporting
<i>PUNCH</i>	Blank	Blank	Task Element Reporting

### *The User Preferences*

Prepopulation Method = Task Values

Task Value Default

Selected Taskgroup has associated Time Reporting Template IDs to reflect:

- Elapsed – Task Element Reporting
- Punch – Task Profile Reporting

Task values are entered for all associated task elements.

### *Elapsed Timesheet*

The system prepopulates the timesheet with the taskgroup and task values that are reflected on the User Preferences page. Prepopulated task values can be used because the time reporter's elapsed time reporting template on the Maintain Time Reporter Data page uses task element reporting,

### *Punch Timesheet*

The timesheet displays the taskgroup and associated task elements from the default taskgroup on the Time Reporter Data page. Prepopulated task values from User Preferences cannot be used, as the time reporter does not have a punch time reporting template on the Maintain Time Reporter Data and the punch time reporting template associated with the taskgroup on User Preferences uses task profile.

## Schedule Information Prepopulation

If your schedule has tasks associated with it, in order for the scheduled tasks to prepopulate on the timesheet, the employee needs to be set up as the same type of task reporter that the system defines on the schedule.

The display of task profile or task elements on the timesheet is first derived from the Maintain Time Reporter Data page to see if a Time Reporting Template is listed. This is true for both Punch and Elapsed Timesheets.

- If none exists on Maintain Time Reporter Data, then the timesheet display will derive the time reporting template of the scheduled taskgroup, to determine whether to use task profile or task template.
- If the schedule is composed of shifts, then the system uses the taskgroup associated with the shift. If the schedule is not using shifts, then the system uses a taskgroup associated to the schedule.

## Employee User Preferences and Manager Timesheet Display

When viewing an employee's time on the Timesheet page, a manager sees the following default settings:

- **TRC Code/TRC Description:** Display the preference from the manager's own user preferences, not the employees.
- **Time Prepopulation Method:** Display the default task values as mentioned previously. The Manager Self-Service Timesheet will not prepopulate with the employee's scheduled time, or prior period time.
- Default Timesheet Display

**(View by):** Display the preference from the manager's own user preferences, not the employees. However, if the manager changes the Date and View by setting while on the Timesheet page, and then clicks on Next Employee or Previous Employee, those settings will remain - they do not return to today's date and the default View By setting. For example, if the manager changes the date to January 1, 2004 and View By *Time Period*, when clicking on the Next Employee button, the time period displayed is for January 1, 2004 for the next employee.

- **Start Day of Week:** Display the preference from the manager's own user preferences, not the employees.

The Timesheet will display existing time in the database in the following way:

- Time Reporting Elements:

Employees only see those fields that are specified on the Time Reporting Template.

For managers, if the field, **Show all Time Reporting Fields**, is selected on the **Time Reporting Options** group box of the Time and Labor Installation page, then the manager will see all time reporting elements displayed. If this is not selected, then the manager will see only those fields that are specified on the Time Reporting Template, and those fields that have values.

- Task Elements:

Employees see those fields that are specified on the Task Template, and those fields that have values.

Managers see those fields that are specified on the Task Template for the employee, and those fields that have values.

## Web Clock - Enter Punch Page

Use the Web Clock - Enter Punch page (TL\_WEBCLK\_ENTR\_PCH) to enable employees to enter a single In, Break, Meal, Out, or Transfer punch.

Employees can provide time and task detail when entering punches. Includes links to pages for viewing overtime requests and the holiday schedule.

Navigation:

**Self-Service > Time Reporting > Report Time > Web Clock > Web Clock**

This example illustrates the fields and controls on the Web Clock - Enter Punch page. You can find definitions for the fields and controls later on this page.

### Web Clock

**Betty Locherty**  
Director-Finance

Employee ID KU0007  
Employment Record 0

Your Last Recorded Punch

**Enter Punch** ?

\*Punch Type

Time Zone  Pacific Time (US)

**Enter Punch**

**Time Reporting Elements**

Day Tuesday

Taskgroup  Task Grp for Template & Prfl 1

Task Profile ID

Country

State

Locality

Comments

**Enter Punch**

<b>Field or Control</b>	<b>Description</b>
<b>Punch Type</b>	Select a punch type: <i>In, Out, Meal, Break, or Transfer.</i>
<b>Enter Punch</b>	Click after you've selected the punch type and entered element and task information. The system uses the current date and time for the punch and applies the same validations that are used for the Timesheet page.

<b>Field or Control</b>	<b>Description</b>
<b>Time Zone</b>	By default, the system uses the employee's time zone as defined on the Create Time Reporter Data page in Time and Labor; you can override the time zone during data entry.

## Task Reporting Elements

These fields only apply to *In* and *Transfer* punches.

## Using Mass Time

Use the Mass Time Reporting feature to save time and keystrokes when reporting time. It enables you to easily report different attributes of time for a period rather than having to enter them manually for each day in the specified period.

The Mass Time Reporting feature enables you to report time in several different ways by using a template type format. You enter the period of time for which you want to report time and select the method that Time and Labor uses to generate reported time.

## Understanding Mass Time

The options in the **How do you want to report time?** section of the Mass Time Reporting page function differently depending on whether the **Regenerate Reported Time** check box is selected on the TL Installation page and whether the **Create Partial Work Hours for Partial Absence** check box and **Exclude Holiday for Generating Time** check box are selected on Workgroup page.

- If the **Regenerate Reported Time** check box is selected, then the total number of hours of reported time generated for any day will not exceed the number of hours scheduled for that day. The total number of hours is the sum of absence time taken, compensatory time taken, leave time taken, and non-compensatory leave time taken, less compensatory time earned.
- If the **Create Partial Work Hours for Partial Absence** check box is selected, then on any day on which a partial absence is reported, the system will generate reported time in the manner described in the previous paragraph. If this check box is cleared, no time is generated by Mass Time on any day on which a partial absence is reported.
- On the Mass Time - Select Time Reporting Method page, when you select the **Exclude Holiday for Generating Time** field, and **Report time for selected TRC using scheduled hours** is also selected, Mass Time will not generate any reported time on days defined as holidays, even if scheduled hours exist on those days.

See [Setting Up System Defaults and Loading Dates](#), [Setting Up Workgroups](#).

## Mass Time - Select Time Reporting Method Page

Use the Mass Time - Select Time Reporting Method page (TL\_MASS\_TIME\_SELF) (TL\_MASS\_SELF\_SAVE) to specify the range of dates and the method for reporting time.

Navigation:



**Self Service > Time Reporting > Report Time > Mass Time**

Click Next on the Mass Time - Select Time Reporters page.

This example illustrates the fields and controls on the Mass Time - Select Time Reporting Method page. You can find definitions for the fields and controls later on this page.

**Mass Time**

---

**Select Time Reporting Method**

Betty Locherty Empl ID KU0007

Job Title Director-Finance Empl Record 0

---

**For when do you want to report time?** ?

**Just One Date**      Date  (example: 03/18/2014)

**Range of Dates**      From       To

---

**How do you want to report time?** ?

**Report time for selected TRC using scheduled hours**  
 This will use the schedule to report time for the specified range of days.  
 The time reporter must be assigned to a schedule in order to report time using this option.

**Report time for selected TRC for the specified number of hours**  
 For example, if 40 is entered, then 40 hours would be distributed according to the schedule.  
 The time reporter must be assigned to a schedule in order to report time using this option.

**Specify one or more transactions to be applied to each day in the time period**  
 For example, assign 8 hours of Regular and 2 hours of Overtime to each day in the indicated time period.

**Include Off Days in Schedule**

[Next](#)

<i><b>Field or Control</b></i>	<i><b>Description</b></i>
<b>Just One Date</b>	To report time for just one day, enter a date in this field.
<b>Range of Dates</b>	To report time for a range of dates, enter beginning and end dates in these fields.

You can report time in one of three ways using the Mass Time Reporting feature:

1. Report time for selected TRC using scheduled hours.

Use this option to report time according to your schedule. If you (or your employees, if you are a manager) are assigned to a schedule, you can report time according to that schedule for a specified day or for a range of dates. Once you specify the date or date range, the system generates reported time by looking at your schedule for the dates that you specified. For example, to report taking vacation for two weeks, specify a date range for those two weeks and indicate a time reporting code to

be applied. The system looks at how your schedule is built for that particular date range and generates reported time for the same number of hours for those dates. You must be assigned to a schedule for reported time to be generated using this option.

2. Report time for selected TRC for the specified number of hours.

Use this option if you want to specify a lump sum amount, for example, 40 hours, and have it distributed according to your or your employee's schedule over the date or date range specified. For example, suppose that you specify a date range of two weeks, indicate a time reporting code of *REG*, and enter 80 hours to be distributed. The system looks at your schedule and distributes 80 hours of *REG* over the two weeks according to how your schedule is set up.

---

**Note:** You must be assigned to a schedule to use this feature. Also, the system doesn't distribute the total number of hours evenly over the time period. If your schedule dictates that you normally work only 70 hours in a two-week period and you enter 80 hours to be distributed, then the extra 10 hours is lumped into the last day of the date range specified. The reason for this is that you are requesting that a lump sum of time be distributed according to your schedule. If the number of hours you report is short or over that which is indicated in the schedule, those hours are applied to the last day.

---

3. Specify one or more transactions to be applied to each day in the time period.

Use this option to report time and specify multiple transactions for the system to apply to the specified date or date range. For example, suppose there is one week for which you need to report six hours of regular time and two hours of paid time off for each day, instead of reporting your usual eight hours of regular time. Rather than having to enter these two transactions for each day, you can enter it only once by specifying six hours of *REG* and two hours of *PTO*. The system applies the six hours of *REG* and two hours of *PTO* to each of the days that you specified in your date range, excluding your regular days off. You need to be assigned to a schedule to report time using this option.

If you select this Mass Time reporting option, then the **Include Off Days in Schedule** check box appears below this selection. This check box affect how reported time is generate in these ways:

- If you have an assigned schedule and this check box is cleared, then reported time is created only for workdays and not scheduled days off.
- If you have an assigned schedule and you select this check box , then reported time is created time for all days in the schedule.
- If you do not have an assigned schedule, reported time is created for all days in the date range you enter regardless of the setting of the **Include Off Day** check box, `based on the data you enter on the **Reporting Details** grid on the Mass Time – Report Time page.

Click the **Next** button to continue on to the Mass Time - Report Time page.

## Mass Time - Report Time Page

Use the Mass Time - Report Time page (TL\_MASS\_TIME\_SELF) (TL\_MASS\_SELF\_SAVE) to specify the range of dates and the method for reporting time.

Navigation:

**Self Service > Time Reporting > Report Time > Mass Time**

Click **Next** on the Mass Time - Select Time Reporting Method page.

This example illustrates the fields and controls on the Mass Time - Report Time page. You can find definitions for the fields and controls later on this page.

**Mass Time**  
**Report Time**

Betty Locherty Empl ID KU0007  
 Job Title Director-Finance Empl Record 0

Reporting Begin Date 06/01/2009  
 Reporting End Date 06/30/2009

Report time for selected TRC using scheduled hours

Time Reporting Code KUREG - Regular

Indicate whether to use a Task Profile

Use Profile Use Employee Profile

Replace Existing Time

<i><b>Field or Control</b></i>	<i><b>Description</b></i>
<b>Time Reporting Code</b>	<p>Enter a time reporting code (TRC) in this field to specify which method to use for processing the time worked. Every active TRC that is valid for the employee appears here, unless it is specified as a "Rules Only" TRC. If it is a rules only TRC, then it will only be used in processing rules and will not show up on the time reporting pages. Select a TRC that is attached to the TRC program assigned to the employee for whom you are reporting time.</p> <p>If you're reporting a lump sum of time to be distributed according to your schedule, enter the total number of hours that you want distributed in the <b>Specify how much you want to report</b> box.</p> <hr/> <p><b>Note:</b> On the previous page, if the <b>Use the scheduled hours for the day(s) specified</b> or the <b>Use the total number of hours entered and distribute them according to the schedule</b> option was selected, and a TRC is being used, if the selected employee has a punch schedule, then a TRC will be inserted with the punch scheduled time. If the user decides to report a TRC with punch time, then the new rule Template 135 should be reviewed, in order to determine if all punch time rows with a TRC should be paid or paid with a different TRC.</p> <hr/> <p>If a TRC is not specified in this field, and a TRC exists on the employee's schedule, the system uses Scheduled TRC. If there are any other Time Reporting elements on the schedule, these will be used to populate reported time as well.</p>

<b>Field or Control</b>	<b>Description</b>
<b>Use Profile</b>	<p>Select one of the values to define how you want task information applied to reported time. The values for the <b>Use Profile</b> field are:</p> <p>Use Employee Profile. Select this value to use this profile as the default task profile on the Maintain Time Reporter Data page for reported time.</p> <p>Use Scheduled Tasks. Select this value to display any task and time reporting information on the employee's schedule to populate reported time.</p> <p>Use Taskgroup Default Profile. Select this value to use the default task profile on the employee's taskgroup listed on the Maintain Time Reporter Data page.</p>
<b>Submit</b>	<p>Click to submit the time that you reported for processing. The validation process runs, and the system generates exceptions if errors exist. The Submit process updates the employee's status codes and creates reported time. If you selected the Automatic Rules Run option on the Time and Labor Installation page, the Time Administration process runs and creates payable time.</p>

When the **Specify one or more transactions to be applied to each day in the time period** option is selected on the Mass Time - Select Time Reporting Method page.

<b>Field or Control</b>	<b>Description</b>
<b>Taskgroup</b>	<p>(Optional) If this field is left blank, when time is submitted it appears by default from the employee's assigned Taskgroup, which is indicated on their Time and Labor Employee Data record, or the Taskgroup assigned to the group for which you are reporting.</p> <p>If a Taskgroup other than the default is reported, this is considered Taskgroup borrowing. When the time is submitted, it uses the task reporting elements associated with the borrowed Taskgroup. The selection of a Taskgroup determines which fields appear on the Task Reporting Elements tab.</p>
Time Reporting Elements, Task Reporting Elements (tab)	<p>If applicable, enter information on the Time Reporting Elements or Task Reporting Elements tabs. Time reporting elements are based on your Time Reporting Template information and the Task Reporting Elements are based on the Taskgroup that is being reported.</p>

<b>Field or Control</b>	<b>Description</b>
<b>TRC</b>	Specify all the transactions that the system is to report for each of the days in the specified date range. Select a TRC in the <b>Specify which Time Reporting Code (TRC) you want to use</b> field on the Mass Time Reporting page to indicate which method the system should use for processing the time worked. Every active TRC that is set up in the system appears here. Select a TRC that is attached to the TRC program assigned to the employee for whom you are reporting time. If you select a TRC that is not valid for an employee, the system generates an exception when the time is submitted.
<b>Quantity</b>	Enter the number of hours. <hr/> <b>Note:</b> This field appears if the second option (use the total number of hours entered) or the third option (specify multiple time transactions) on the Select Time Reporting Method page is selected. A value is required in the <b>Quantity</b> field in order to complete the transaction. <hr/>
<b>Country, Currency Code, State, Locality, Comp Rate Code, Billable Indicator, Override Rate</b>	Enter values in these fields if applicable.
<b>Replace Existing Time</b>	This check box is selected by default and cannot be edited if you select the first option for Mass Time reporting. When this check box is selected, only existing time generated through Rapid Time or Mass Time (time that has a reported time source (RT_SOURCE) equal to <i>SCH</i> ) is deleted. Time generated through the Timesheet page is not deleted (time with a reported time source equal to <i>SYS</i> ). Time entered through Mass Time is added to any time that was entered through the Timesheet pages.  If you do not select this check box, the system adds the time in this entry to previous data. For example, suppose that you reported eight hours of TRC <i>REG</i> for an employee on March 1, 2000. Then you enter two hours of TRC <i>REG</i> for the same employee on the same date. If you selected this check box, the system records two hours of TRC <i>REG</i> for that day. If you did not select this check box, the system will add two hours of TRC <i>REG</i> to the existing eight hours for a total of ten hours for this date.

## Compensatory Time Page

Use the Compensatory Time page (TL\_COMPTIME\_PNL) to view compensatory time balance and expiration information.

Navigation:

**Self Service > Time Reporting > View Time > Employee Compensatory Time > Compensatory Time**

This example illustrates the fields and controls on the Compensatory Time page. You can find definitions for the fields and controls later on this page.

## Compensatory Time

**Christelle Stevenson**  
Manager-Accounting

Employee ID KU0020  
 Employment Record 0

[Previous](#)

**Comp Time Balance Summary** ?

<b>Compensatory Time Off Plan</b> KUCTOP2 <b>Date</b> 03/18/2014 <b>Balance at Start of Day</b> 0.00	<b>Expiration Period</b> Years <b>Period Count</b> 1
--	---

\*Show Time Expiring in Next 30 Days

**Expiring Time Earned** ?

Expiration Date	Quantity	Ending Balance
	0.00	0.00

[Return to Select Job](#)

[Self Service](#)

[Time Reporting](#)

The Compensatory Time page includes the compensatory time balance as of the date specified. This balance may be positive or negative, depending on how the plan is set up and what has been reported.

<b>Field or Control</b>	<b>Description</b>
<b>Show Time Expiring in</b>	Select how far in the future you want to view compensatory time expiration information. Once you make a selection, the system displays all compensatory time with an expiration date that meets the criteria.  For example, if you select <i>Next 30 days</i> , the system displays all the compensatory time expiring within the next 30 days. If the compensatory time has no expiration date, it doesn't appear here.
<b>Expiration Date</b>	Displays the date that the employee's reported compensatory time is set to expire. The time expires at midnight of the date specified in this field.
<b>Quantity</b>	Displays the number of compensatory hours that were originally reported and are set to expire on the date specified in the <b>Expiration Date</b> field.

<b>Field or Control</b>	<b>Description</b>
<b>Ending Balance</b>	Displays the compensatory time balance at the end of the date specified in the <b>Expiration Date</b> field once the hours have expired.

## Viewing Time

This section discusses how to view the summary of payable time, details of payable time, and forecasted time.

### Pages Used to View Time

<b>Page Name</b>	<b>Definition Name</b>	<b>Usage</b>
<u>Exceptions Page</u>	TL_EE_EXCEPTIONS	View exceptions using this display-only page.
<u>Payable Time Summary Page</u>	TL_TM_MPAY_SUMM	View the week-by-week summary of payable time by TRC using this display-only page.
<u>Payable Time Details Page</u>	TL_MNG_PAY_DET_VW	View the details of the payable time. If an employee has reported time and the Time Administration process runs, it is possible that the system still doesn't create payable time. If the system creates exceptions, then the priority of the exception is the determinant. Low priority exceptions enable the system to create payable time; however, higher priority exceptions do not.
<u>Forecasted Time Summary Page</u>	TL_TM_MPAY_SUMM	View forecasted payable time in summary. The View Forecasted Payable Time Summary page shows the forecast time by employee and by TRC.
Forecasted Time Details Page	TL_MNG_PAY_DET_VW	View forecasted payable time details. This page displays the time in detail for 30 days starting from the day the user selects.

## Exceptions Page

Use the Exceptions page (TL\_EE\_EXCEPTIONS) to view exceptions using this display-only page.

Navigation:

**Self Service > Time Reporting > View Time > Exceptions > Exceptions**

This example illustrates the fields and controls on the Exceptions page.

### Exceptions

**Christelle Stevenson**  
Manager-Accounting

Employee ID KU0020  
Employment Record 0

**Filtering Options**

\*Date Filter

\*Exception Filter

Severity

Start Date

Exception ID

**Select**

Continue with Exceptions

**Exceptions** Personalize | Find |

First ◀ 1-3 of 3 ▶ Last

Overview

Details

☰

Exception ID	Description	Date	Severity	Exception Source
TLX10082	Exceed daily overtime limit	09/05/2014	Low	Time Administration
TLX10082	Exceed daily overtime limit	09/10/2014	Low	Time Administration
TLX10082	Exceed daily overtime limit	09/12/2014	Low	Time Administration

<b>Field or Control</b>	<b>Description</b>
<b>Filtering Options</b>	Expand this grid to further control which exceptions the system displays.
<b>Date Filter</b> and <i>Start Date</i>	Select a date filter for this exception: <i>between, equal to, greater than, or less than</i> , then enter a date.
<b>Exception Filter</b> and <b>Exception ID</b>	Select an exception ID filter for this exception: <i>equal to, greater than, less than, like, not equal to, or not like</i> , and then enter the exception ID.
<b>Severity</b>	Select a severity level filter for this exception: <i>High, Low, or Medium</i> .
<b>Exception ID</b>	Displays the Exception ID code that was delivered with the system or that you defined using the Define Exceptions page. Click the <b>Details</b> tab to view the Exception Information details of the exception.
<b>Description</b>	Displays the description of the exception.
<b>Date</b>	Displays the date of the reported time that caused the exception.



<b>Field or Control</b>	<b>Description</b>
<b>Severity</b>	Displays the severity of the exception: <i>High</i> , <i>Medium</i> , and <i>Low</i> .

## Payable Time Summary Page

Use the View Payable Time Summary page (TL\_TM\_MPAY\_SUMM) to view the week-by-week summary of payable time by TRC using this display-only page.

Navigation:

**Self Service > Time Reporting > View Time > Payable Time Summary > Payable Time Summary**

This example illustrates the fields and controls on the Payable Time Summary page. You can find definitions for the fields and controls later on this page.

The View Payable Time Summary page displays one week's payable time. The time is allocated by date, by TRC, and then by task. For example, if your task profile specifies that your time should be allocated 50 percent to one task and 50 percent to another, then you would see two rows for the same date and TRC. However, on the Payable Time Details page, you can view the details of how it is allocated.

<b>Field or Control</b>	<b>Description</b>
<b>Start Date</b>	Seven days are displayed by default.
<b>Pending Exceptions</b>	This button appears if exceptions were generated. Click to access the Manage Exceptions page.  <b>Note:</b> If you have multiple jobs and on a given date there is an exception for EMPL_RCD=0, then Payable Time is not created for any of the multiple jobs in that workgroup for that date.
<b>Previous Week and Next Week</b>	Click to view a different week's summary of payable time.
<b>Detail Page</b>	Click this link to access the Payable Time Details page.

**Note:** Time that has generated exceptions with a "High" severity level will not appear on this page because it is not considered payable time. Time that has generated exception with a "Low" or "Medium" severity level will appear on this page and is considered payable time.

## Payable Time Details Page

Use the Payable Time Details page (TL\_MNG\_PAY\_DET\_VW) to view the details of the payable time.

If an employee has reported time and the Time Administration process runs, it is possible that the system still doesn't create payable time. If the system creates exceptions, then the priority of the exception is the determinant. Low priority exceptions enable the system to create payable time; however, higher priority exceptions do not.

Navigation:

- For manager access: **Manager Self Service > Time Management > View Time > Payable Time Detail > Payable Time Detail**
- For employee access: **Self Service > Time Reporting > View Time > Payable Time Detail > Payable Time Detail**
- Click the Detail Page button on the View Payable Time Summary page.

This example illustrates the fields and controls on the Payable Time Detail page. You can find definitions for the fields and controls later on this page.

**Payable Time Detail**

**Betty Locherty** Employee ID KU0007  
Director-Finance Employment Record 0

Start Date 03/12/2014  
End Date 03/18/2014

There is no time returned for the selected date range. (03/12/2014 - 03/18/2014)

Payable Status Filter

Payable Time

Overview | Time Reporting Elements | Task Reporting Elements | Cost and Approval

Date	Status	Reason Code	Time Reporting Code	Quantity TRC Type	Estimated Gross
	Approval Monitor				

This page displays the payable time details for each day, including the TRC for the time. The TRC either is entered by the employee when reporting time, or it is generated by the system when the Time Administration process is run. The system also displays the number of units, amounts, or hours for the TRC. This value must be within the minimum and maximum quantity set for the TRC. The TRC type determines if this value is amounts, units, or hours. The system displays the date of the reported time and the current status of the payable time. The payable status records the progress of payable time through its different stages.

<b>Field or Control</b>	<b>Description</b>
Start Date and End Date	<p>Seven days of information is displayed by default. Various values for Start Date and End Date can be entered, but End Date cannot exceed Start Date by more than 31 days.</p> <hr/> <p><b>Note:</b> If you navigate to the Payable Time Detail page from the Payable Time Summary page, the system automatically populates the <b>Start Date</b> and <b>End Date</b> fields with the information you provided on the Payable Time Summary page.</p>
Payable Status Filter	Expand this grid to limit the display of payable time by payable time status.
<b>Pending Exceptions</b>	This button appears if exceptions were generated. Click to access the Manage Exceptions page.
Time Reporting Elements, Task Reporting Elements (tab)	These tabs display information related to Time Reporting Elements or Task Reporting Elements, if applicable. Time reporting elements are based on your Time Reporting Template information and the Task Reporting Elements are based on the Taskgroup that is reported.
<b>Previous Job</b> and <b>Next Job</b>	<p>If you have multiple jobs, click to view a different job's summary of payable time.</p> <hr/> <p><b>Note:</b> If you have multiple jobs and on a given date there is an exception for EMPL_RCD=0, then Payable Time is not created for any of the multiple jobs in that workgroup for that date.</p>

## Related Links

[Understanding Payable Time](#)

## Forecasted Time Summary Page

Use the Forecasted Time Summary page (TL\_TM\_MPAY\_SUMM) to view forecasted payable time in summary.

The View Forecasted Payable Time Summary page shows the forecast time by employee and by TRC.

Navigation:

- For manager access: **Manager Self Service > Time Management > View Time > Forecasted Time Summary**
- For employee access: **Self Service > Time Reporting > View Time > Forecasted Time Summary**

This example illustrates the fields and controls on the Forecasted Time Summary page. You can find definitions for the fields and controls later on this page.

The Forecast Payable Time feature enables you to estimate what your payable time is for the current period or for a future time period. It looks at reported time and scheduled time, and calculates what the payable time would be for a specified time period using that information. By using the Forecast Payable Time feature, you can look at how many hours you have reported to date in the period, and what the remaining scheduled hours are. The Forecast Payable page shows you your estimated payable time.

There are four ways to forecast payable time:

- Forecast time for a month or for a specific day using the Time and Labor Launch Pad.
- Forecast time for the time period associated with the Process Date by clicking the **Forecast Payable Time** button on the Time Administration Run Control page.

---

**Note:** Forecasted Payable Time is not actual Payable Time. To generate Payable Time, you must use the processes for creating Payable Time.

---

The View Forecasted Payable Time Summary page displays one week of payable time. The system allocates time based on the TRC, and displays the total quantity of hours for each TRC to which time was reported within the specified date range.

<b>Field or Control</b>	<b>Description</b>
Start Date	Seven days are displayed by default.
<b>Detail Page</b>	Click this button to access the Forecasted Time Details page.

---

**Note:** The Forecasted Time Detail page is similar to the Payable Time Detail page.

---

## Requesting Overtime

This section provides an overview of self-service overtime request transactions.

## Pages Used to Enter, View, and Process Overtime Requests

<i>Page Name</i>	<i>Definition Name</i>	<i>Usage</i>
Select Job Title Page	CO_MULTI_JOB_SRCH	Select the job to which the overtime request applies. This page is only available when an employee has multiple jobs.
<u>Request Overtime - Overtime Requests Page</u>	TL_OT_EVENTS	Employees can view recent overtime requests and access the Overtime Request Details page, where they can enter new overtime requests.
<u>Request Overtime - Request Overtime List Page</u>	TL_OT_RQST_DTL	Employees can view the details associated with an overtime request.
<u>Request Overtime - Overtime Request Details (Add) Page</u>	TL_OT_RQST	Employees can enter new overtime requests.
Submit Confirmation Page	TL_OT_SUB_CONF	Confirms that an overtime request was submitted.

## Understanding Overtime Transactions

With Time and Labor, employees can enter overtime requests for a future date and receive approval or denial notices. Managers can view overtime requests, check the amount of overtime that employees have worked to date, approve or deny overtime requests, and enter comments explaining their decisions.

Employees can use Time and Labor to:

- View the status of overtime requests that they've entered.
- View the details of an overtime request.
- Enter overtime requests for a future date.

## Request Overtime - Overtime Requests Page

Use the Request Overtime - Overtime Requests page (TL\_OT\_EVENTS) to employees can view recent overtime requests and access the Overtime Request Details page, where they can enter new overtime requests.

Navigation:

**Self Service > Time Reporting > Report Time > Overtime Requests > Overtime Requests**

This example illustrates the fields and controls on the Request Overtime - Overtime Requests page. You can find definitions for the fields and controls later on this page.

**Overtime Requests**

**Betty Locherty** Employee ID KU0007  
Director-Finance Employment Record 0

**View Options** ?

Month **03 - March** Year **2014** **View Requests**

View All Requests

**Overtime Requests** ? Personalize | View All | First 1 of 1 Last

Details	Date On Request	Overtime Hours	Date Submitted	Request Status
Details	03/18/2014	4.00	03/18/2014	Submitted

## Overtime Requests

This page lists all of the employee's overtime requests and the status of each request: *Submitted*, *Needs Approval*, *Approved*, *Denied*, or *Push Back*.

- To view requests for a different month, select the month and year and click **View Requests**.
- To view the approval details for a request or see comments that were submitted with a request, click the **Details** link in the **Details** column. The Overtime Request Details page is displayed.
- To add a request, click the **Add Request** button.

## Request Overtime - Request Overtime List Page

Use the Request Overtime - Request Overtime List page (TL\_OT\_RQST\_DTL) to employees can view the details associated with an overtime request.

Navigation:

Select a **Details** link on the [Request Overtime - Overtime Requests Page](#).

This example illustrates the fields and controls on the Request Overtime - Request Overtime List page. You can find definitions for the fields and controls later on this page.

**Request Overtime List**

**Betty Locherty** Employee ID KU0007  
Director-Finance Employment Record 0

**Overtime Request Details** ?

Date On Request 03/18/2014 Date Submitted 03/18/2014  
Overtime Hours 4.00  
Request Status Submitted

**Approval Details**

User ID	Name	Request Status	Date	Comment
PS	Betty Locherty	Submitted	03/18/2014	Overtime Request.

The **Approval Details** group box shows who entered the request and who must approve it.

<b>Field or Control</b>	<b>Description</b>
<b>Name</b>	Displays the name of the employee who entered the request and names of those who must approve the request.
<b>Request Status and Transaction Date</b>	The status of an action completed by the person named to the left and the date that the action occurred. Valid actions are <i>Submitted, Needs Approval, Approved, Denied, and Push Back</i> .
<b>Comment</b>	Displays the comment entered by the employee and manager on the Overtime Request Details page.

The system displays the Approval Monitor if the system is configured to approve overtime requests.

## Request Overtime - Overtime Request Details (Add) Page

Use the Request Overtime - Overtime Request Details (add) page (TL\_OT\_RQST) to employees can enter new overtime requests.

Navigation:

Click Add Request on the [Request Overtime - Overtime Requests Page](#).

This example illustrates the fields and controls on the Request Overtime - Overtime Request Details page. You can find definitions for the fields and controls later on this page.

<b>Field or Control</b>	<b>Description</b>
<b>Date on Request</b>	Enter today's date or a later date. One request can be submitted on any given day. To correct a request after submitting it, the manager must deny that request so that you can enter a new one.
<b>Overtime Hours</b>	Enter up to 99 hours. Enter positive numbers only.

<b><i>Field or Control</i></b>	<b><i>Description</i></b>
<b>Comment</b>	Enter the reason for the request. Comments display on the manager's Overtime Request Details and approval pages.
<b>Submit</b>	Click to submit the request for approval. A confirmation page shows who submitted the request, and your comments.



# Using Manager Self-Service Workforce Availability

## Understanding the Workforce Availability

The PeopleSoft HCM Time and Labor Manager Self Service Workforce Availability fluid pages are used by managers to track the status of their team members. The manager can track his employee's availability status, and related actions in desktop, smartphone and tablet.

Video: [Workforce Availability for Time and Labor](#)

This image illustrates the architectural overview if workforce Availability.

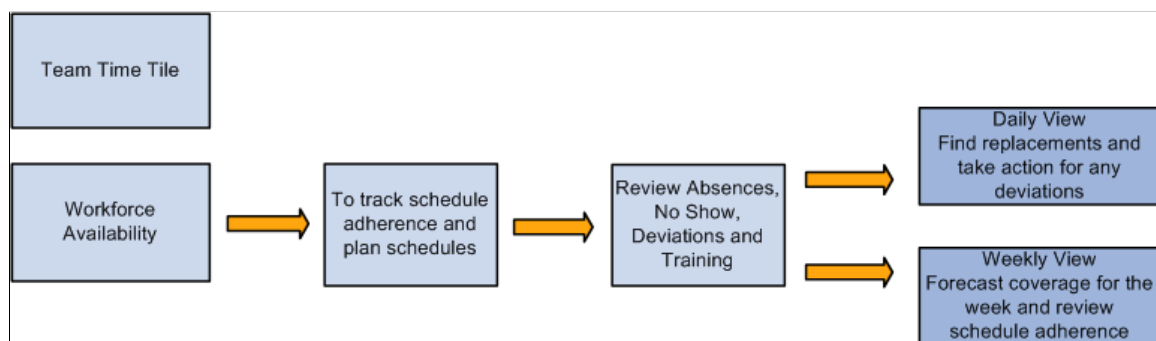





The Manager can track the availability of team members at any given time of the day and can monitor the schedule adherence and then plan the schedule coverage. This facility is available for the weekly status too. The Workforce Availability Daily view left panel displays the details for the following categories:

- Scheduled
- No Show
- Schedule Deviation
- Not Scheduled
- Elapsed
- Away from Work
  - Unapproved Absence
  - Approved Absence
  - Training

- Comp Time Off

## Common Elements Used In the Workforce Availability

<b>Element</b>	<b>Definition</b>
<b>View By</b>	<p>Drop down list where you select Daily Time or Weekly Time.</p> <p><i>Daily Time</i> : See a comprehensive view of team's availability for the day.</p> <p><i>Weekly Time</i>:: View the availability and the schedule coverage of team members for the week and as the week progresses.</p> <p>Manager can choose any date through the date picker and also be able to navigate back and forth using the Previous and Next day buttons on the <b>date header</b></p>
 <b>Filter</b>	Navigates to the filter modal where you can specify the employee population.
 Refresh	Refresh the window with the updated data.
 Sort	Click this icon to change the sort order of team members. You can sort by any field shown.
	Click to see the detailed view related to the particular employee.
	Select to go to the related actions menu.
<b>Scheduled</b>	Shows the scheduled time in hours.
<b>Reported</b>	Shows the reported time in hours.

# Using the PeopleSoft Fluid User Interface in Time and Labor

---

## Using PeopleSoft Fluid User Interface for Time Reporting as an Employee

Employees can perform time reporting and related operations using applications which are developed with the help of PeopleSoft Fluid User Interface tools. These applications are scalable across smart phones, tablet and personal computers. Employee can report and review time by the day and week, report leave and compensatory time, view reported time by the day and week, view payable time, view base benefits leave and compensatory time balances and enter user preferences for defaulting and viewing time data.

When the user taps the **Time** tile on the Employee Self Service Homepage, the application start screen for Time and Labor appears. The application start page contains a list of tasks the user can select to perform. The tasks listed are based on the applications that are installed and are on the security access of the logged in user.

The following video provides a demonstration new fluid timesheet with new rapid time entry pages.

Video: [Image Highlights, PeopleSoft Update Image 27: Time and Labor Fluid Time Entry for Phone](#)

The following video provides an overview of Fluid Time Entry pages.

Video: [Fluid Time Entry Pages VFO](#)

For general information about fluid pages in PeopleSoft, see “Understanding PeopleSoft Fluid User Interface Homepages” (Application Fundamentals)

## Pages Used to Perform the Tasks as an Employee

<b>Page Name</b>	<b>Definition Name</b>	<b>Usage</b>
<a href="#">Time Tile</a>	HC_TL_START_NAV_FLU_ESS2_GBL(this is the cref for the tile)	Add the Time tile to the home screen to access the actionable tiles for Time.
<a href="#">Time Collection — Actionable Tiles</a>	HC_TL_EMP_DSHBD_FL_LINK	Collection of actionable tiles for Time.
<a href="#">Enter Time Tile</a>	HC_TL_ENTER_TIME_FLU_GBL	Select to access Enter time page.

<b>Page Name</b>	<b>Definition Name</b>	<b>Usage</b>
<u>Enter Time Page for Elapsed Time Reporter</u>	TL_ELP_TIME_FLU	Enter time and view the default time period for the workgroup or the default time period based on the user preferences. Here you will be logged in as Elapsed Time Reporter.
<u>Enter Time Page for Punch Time Reporter</u>	TL_PCH_TIME_FLU	Enter time and view the default time period for the workgroup or the default time period based on the user preferences. Here you will be logged in as Punch Time Reporter.
<u>Legend Page</u>	TL_ICON_LEGEND_SCF	Open to view the legends with description.
<u>Request Absence Modal</u>	HGA_SS_REQ_FLU	Request absence request from the Enter Time page.
<u>Time Reporting Comments Page</u>	TL_TR_COMMENT_FLU	Modal where the employee can enter time reporting comments.
<u>Delete Confirmation Page</u>	TL_DEL_CONFIRM_FLU	Confirm deletion before the final delete or go back to the previous page.
<u>Time Summary Tile</u>	HC_TL_TIME_SUM_FLU_GBL	Select to access the Time Summary page.
<u>Time Summary Page</u>	TL_TIME_SUM_FLU	View time summary for weekly, monthly and bi-weekly  The Time Summary displays the default time period for the workgroup or the default time period from the user's preferences. This view can be changed by the time reporter.  <hr/> <b>Note:</b> For , the Time Summary page will re-direct you to Weekly Time page automatically. <hr/>
<u>View Exceptions Tile</u>	HC_TL_EMPL_EXCEP_FL_GBL	Select to access View Exception page.
<u>View Exceptions Page</u>	TL_EMPL_EXCEP_FL	Displays all exceptions for your team in one place.
<u>Setup Quick-Fill Tile</u>	HC_TL_QUICK_FILL_FLU_GBL	Select to access Setup Quick-Fill page.

<b>Page Name</b>	<b>Definition Name</b>	<b>Usage</b>
<u>Setup Quick-Fill Page</u>	TL_QUICK_FILL_FLU	Create a new Quick-Fill and view the existing saved quick fills. You can update, active and de-activate the existing Quick-Fills
<u>Report Time Tile</u>	HC_TL_RPT_TIME_FLU_GBL	Select to open Report Time page.
<u>Report Time Page for Elapsed Time Reporter</u>	TL_RPTD_ELP_FLU	Report Time Page takes the users to the new Fluid Time Sheet. Users can report the time for their configured time period using this page.
<u>Report Time Page for Punch Time Reporter</u>	TL_WEB_CLOCK_FLU	Report Time Page takes the users to the new Fluid Time Sheet.
<u>Report Time Details Page</u>	TL_RPTD_ELP_FLU	Open to view and update the time reporting details.  The page also lets the punch time reporters to record time for a day at a particular time.
<u>Weekly Time Tile</u>	HC_TL_PRE_POP_ELP_FL_GBL	Select to access Weekly Time Entry page.
<u>Weekly Time Page</u>	TL_PRE_POP_ELP_FLU	View the weekly time reported by a punch time reporter or an elapsed time reporter and submit time for a day.  The elapsed time reporter can choose between pre-populate options <b>Apply Schedule</b> , <b>Copy from Previous</b> or <b>Manual Entry</b> based on their allowed configuration.
<u>(Smartphone) Weekly Time Review Page</u>	TL_WEEKLY_COPY_FL	Review the weekly time before submitting the time for a time reporter.  This page lets you to add or edit time for any specific day before submitting their weekly time. This is an intermediate page after Weekly Time page and allows you to review and update the reported time before submitting it.
<u>Weekly Time Summary Tile</u>	HC_TL_WEEKLY_TIME_FLU_GBL	Select to open
<u>Weekly Time Summary Page</u>	TL_WEEK_TIME_FLU	View the reported time for a week for an employee and then navigate to report time page for a day.

<b>Page Name</b>	<b>Definition Name</b>	<b>Usage</b>
<u>Report Leave Tile</u>	HC_TL_RPT_TIME_FLU_GBL_2	As a punch reporter, report vacation, sick and other leave types as well as the compensatory time as a value in units of hours.
<u>Payable Time Tile</u>	HC_TL_PAYBTIME_FLU_GBL	Select to open Payable Time page.
<u>Payable Time Page</u>	TL_PAYBTIME_FLU	View the payable time reported in the payable time page.
<u>Leave / Comp Time Tile</u>	HC_TL_COMPLEAVBAL_FLU_GBL	Select to open Leave Balances page.
<u>Leave / Comp Time Page</u>	TL_COMPLEAVBAL_FLU	View the details about the Leave Type or Compensatory Plan.

## Time Tile

Use the Time tile (HC\_TL\_EMP\_DSHBD\_FL\_LINK) to navigate to the time collection.

Navigation:

The Time tile is delivered as part of the Employee Self Service home page, but the location can change if you change the delivered home pages or if administrators personalize their home pages.

As an employee, you can add the tile, through personalization, to a system-delivered home page or a home page that you create.

This example illustrates the Time tile.

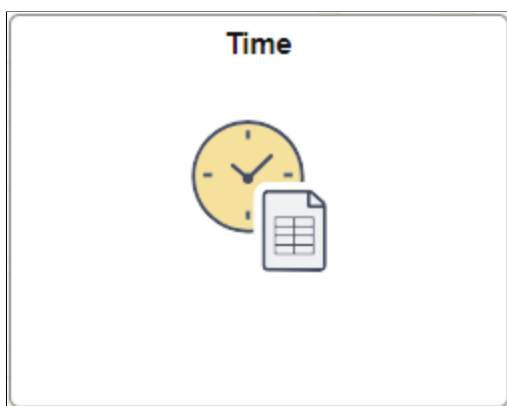

Select the Time tile to access these employee self-service actionable tiles without using traditional menu navigations:

- Enter Time
- Time Summary

- View Exceptions
- Setup Quick-Fill
- Report Time
- Weekly Time
- Weekly Time Summary
- Payable Time
- Manage Absence
- Cancel Absences
- View Requests
- Absence Balances

The following video provides an overview of Actionable Tiles for Time and Labor and Absence transactions.

Video: [Image Highlights, PeopleSoft HCM Update Image 29: Refine Employee Navigation for Time and Labor and Absence](#)

## Time Collection — Actionable Tiles

Use the Time Collection — Actionable Tiles (HC\_TL\_EMP\_DSHBD\_FL\_LINK) to navigate to the corresponding pages.

Navigation:

Select Time tile available on the Employee Self Service Home page to access the actionable tiles.

As an employee, you can add the tile, through personalization, to a system-delivered homepage or a homepage that you create.

The following video provides an overview of Time and Labor Actionable Tiles.

Video: [Image Highlights, PeopleSoft HCM Update Image 30: Actionable Tiles for Employee Time and Labor Transactions](#)

Video: [Image Highlights, PeopleSoft HCM Update Image 29: Redefine Employee Navigation for Time and Labor and Absence Transactions](#)

This example illustrates the Time Collection — Actionable tiles when logged in as an elapsed time reporter.

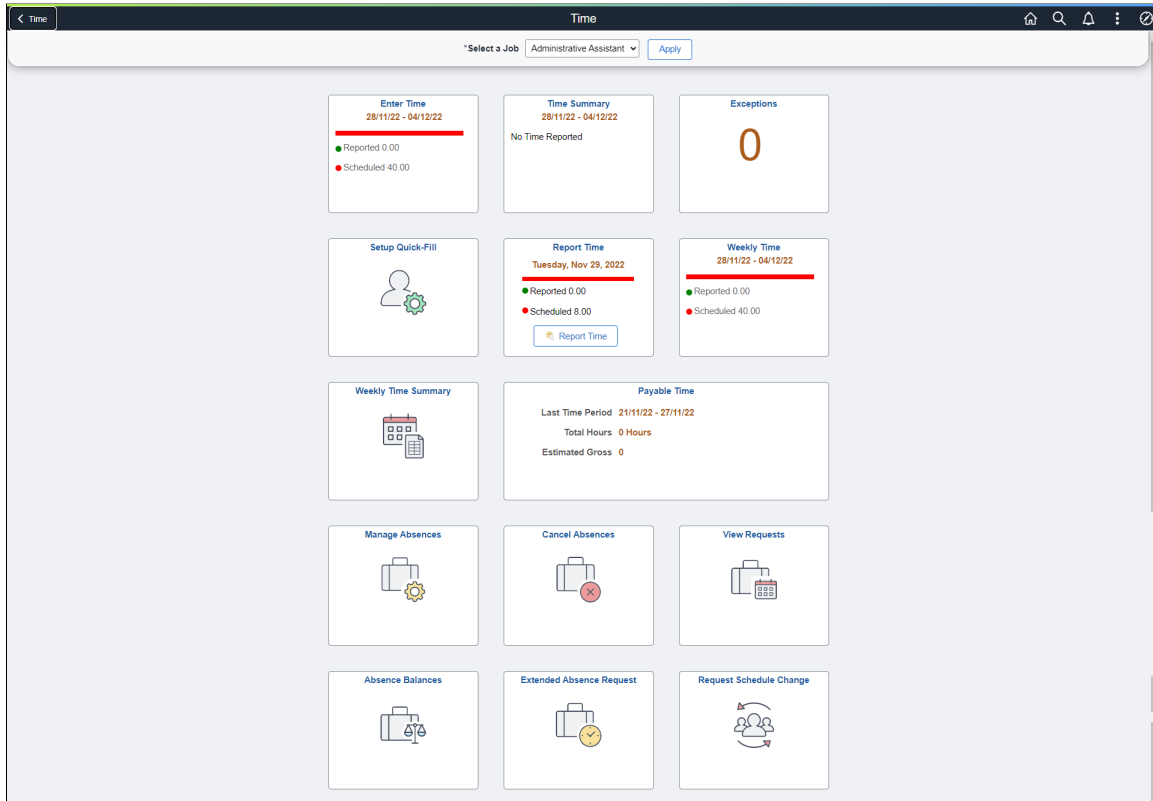



This example illustrates the (Smartphone) Time Collection - Actionable Tiles while using a smartphone.

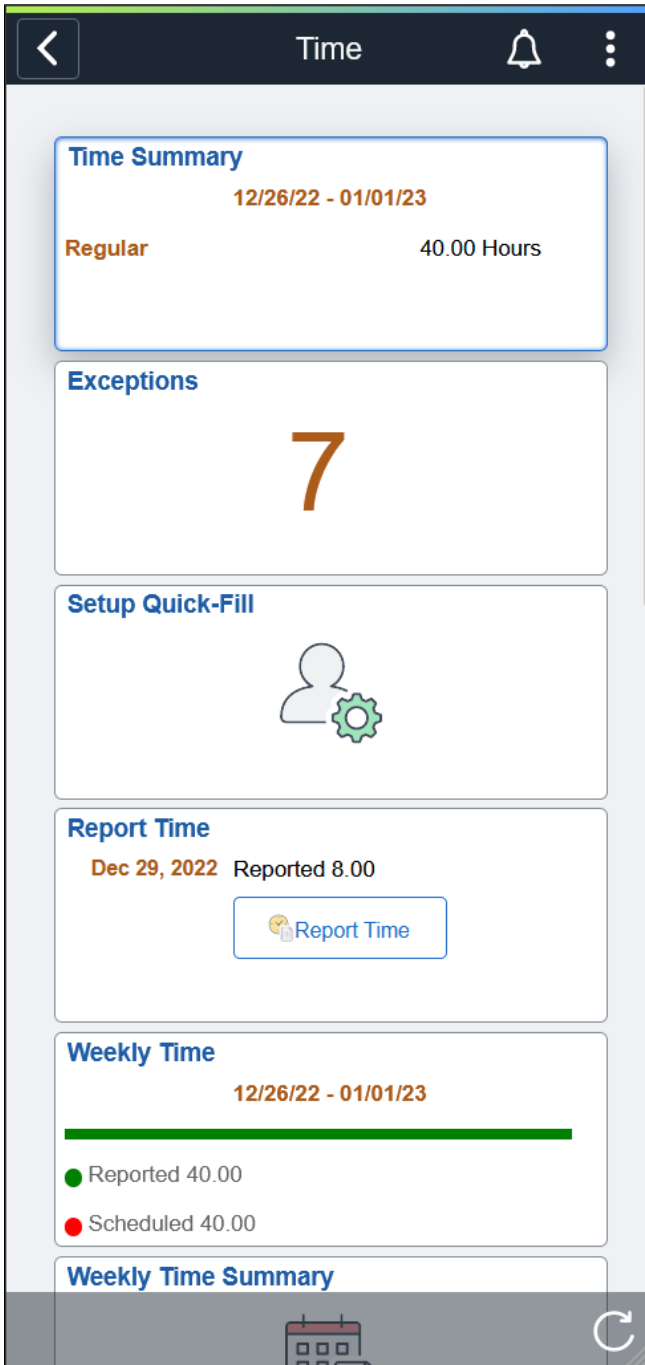

The difference of Actionable tiles collection page for Punch time reporter is that, this type of time reporter can report time using Report Time Page without going to the respective page.

This example illustrates the fields and controls of Time Collection — Actionable Tiles for Punch Time Reporter

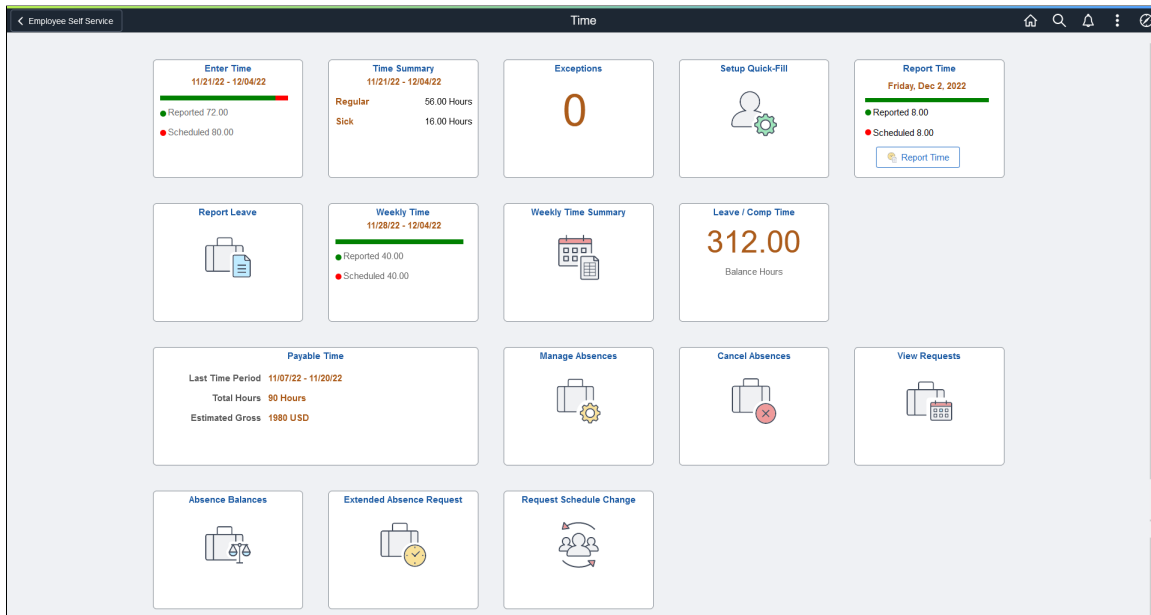

See [Report Time Tile](#) for more details.

The Job Selector banner at the top of the Actionable Time Tile page is used to select the job, in case of an employee who has more than one job to select.

The employee can select the job from **Select a job** drop down and view the corresponding details on the dashboard tiles.

This example illustrates the fields and controls of Job selector banner.

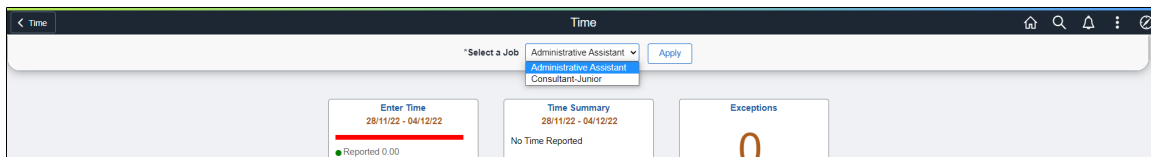

A user with multiple job profile can select a job using job-selector drop-down and **Apply** to view the details of that job profile.

The employee header displays the employee photo and up to three lines of information for a selected job. This information can be configured using the employee header configuration. For more information, see “(Fluid) Managing Employee Headers” (Application Fundamentals).

Example of an employee header in fluid self-service pages.

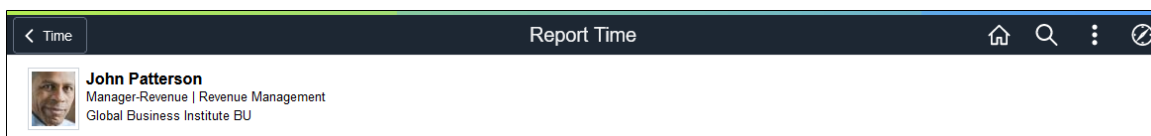

The configurable employee header appears for all fluid self-service and manager self-service Time and Labor pages. For employees with multiple active jobs, the **Select Another Job** link will be enabled that leads to a Change Job Selection window.

This example illustrates the fields and controls on the Change Job Selection Modal.

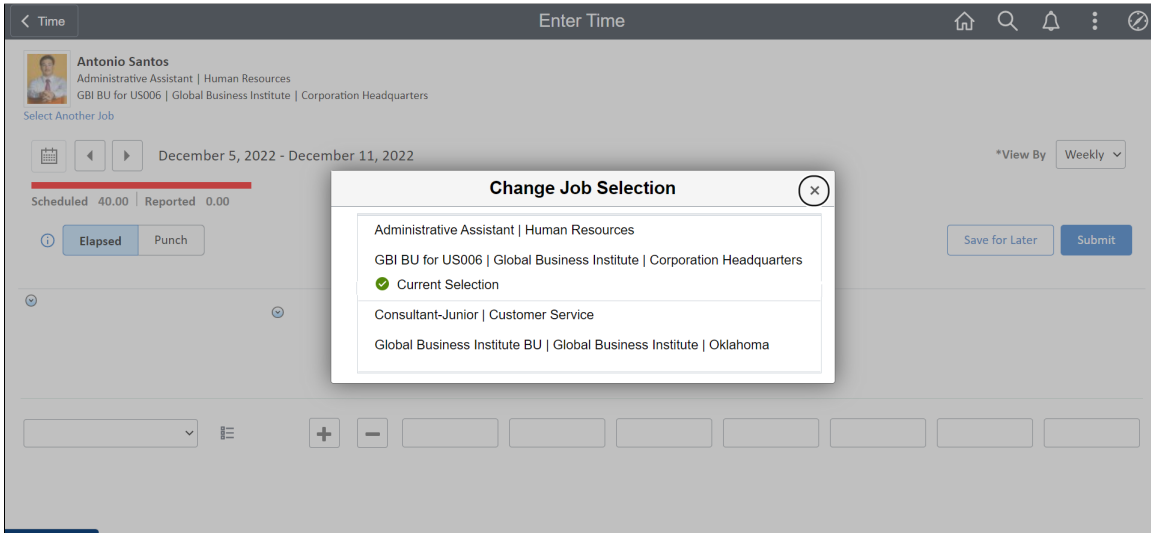

This example illustrates the fields and controls on the Change Job Selection Modal in Accessible Mode.

Change Job Selection			
My Jobs <span style="float: right;">2 rows</span>			
Line 1	Line 2	Status	Select
Administrative Assistant   Human Resources	GBI BU for US006   Global Business Institute   Corporation Headquarters	Selected	Select
Consultant-Junior   Customer Service	Global Business Institute BU   Global Business Institute   Oklahoma	Not Selected	Select

## Enter Time Tile

The Enter Time Tile (HC\_TL\_ENTER\_TIME\_FLU\_GBL) is one of the tiles on the Time Tile collection page. The tile displays up-front information such as time period, which contains begin date and end date. If configured, the status bar on the next line displays reported and scheduled time in the selected color configuration for the specified time period.

Select the Enter Time tile to navigate to the **Enter Time** page.

Navigation:

Select the Time Tile available on the Employee Self Service Home Page to access the Enter Time tile.

This example illustrates the Enter Time tile.

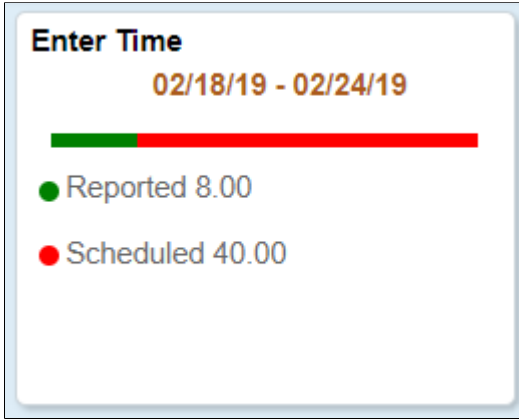

The Punch time reporter will not see the Enter Time tile, they can only see the Report Time tile on the Smartphone.

## Enter Time Page for Elapsed Time Reporter

Use the Enter Time (TL\_ELP\_TIME\_FLU) page to enter time and view the default time period for the workgroup or the default time period based on the user preferences.

Navigation:

Select the Time tile available under the Employee Self Service Homepage Tile Collections page. You can select the Enter Time tile to open the Enter Time page.

This example illustrates the fields and controls of the Enter Time page for an elapsed time reporter.

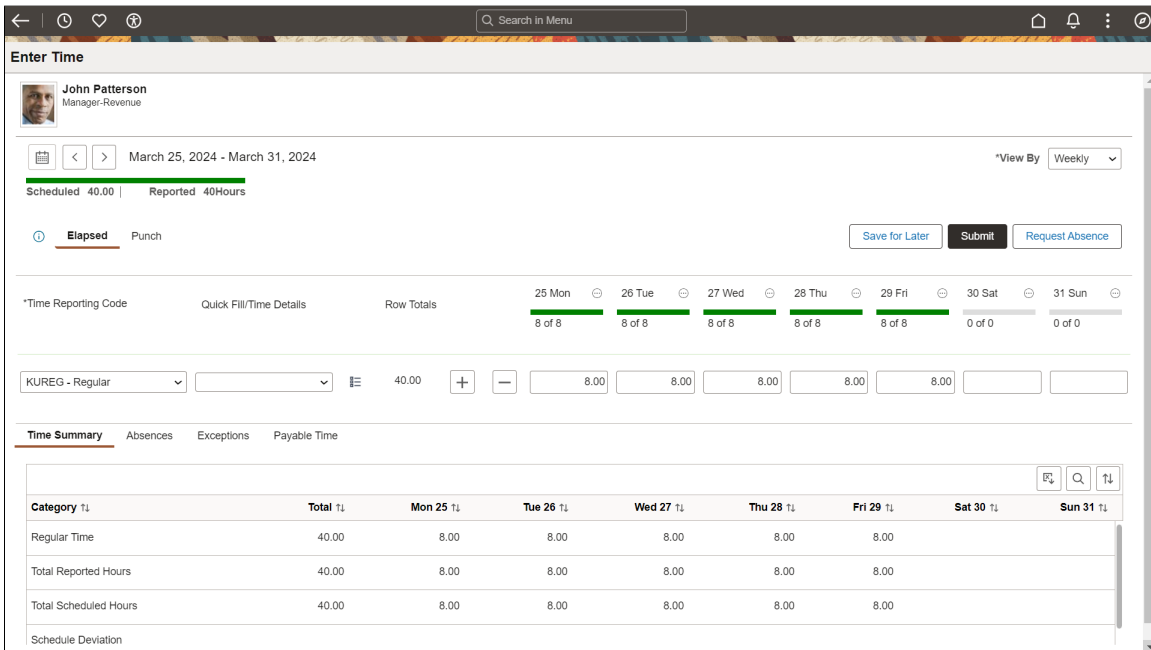

The period slider and Week time on the header indicates the time updates in units for an elapsed time reporter.

**Note:** The reported time hours are updated on entry in both Employee and Manager Self Service. If **Refresh Reported Time Totals on Time Entry** is not selected on the Time and Labor Installation page, the reported hours and status bar will not be updated until the time is either saved or submitted. The following video provides an overview of Update of Reported Totals on the Fluid Time Page after Save or Submit.

Video: [Image Highlights, PeopleSoft HCM Update Image 32: Update of Reported Totals on Fluid Time Page after Save or Submit](#)

Administrators can configure for employees to view the time detail values inline in the timesheet by selecting the option of **Expand Time Details on Timesheet** under [Time and Labor Installation Page](#).

This example illustrates the Time Detail values inline in the Timesheet of a Punched time reporter (1 of 2).

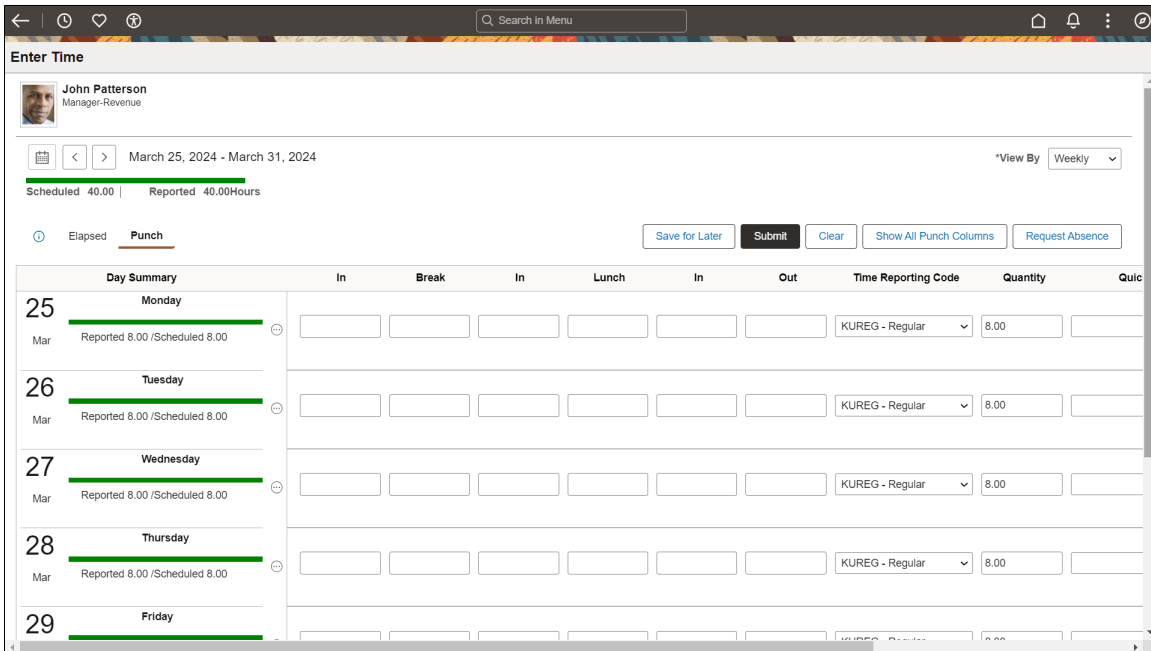

This example illustrates the Time Detail values inline in the Timesheet of a Punched time reporter (2 of 2).

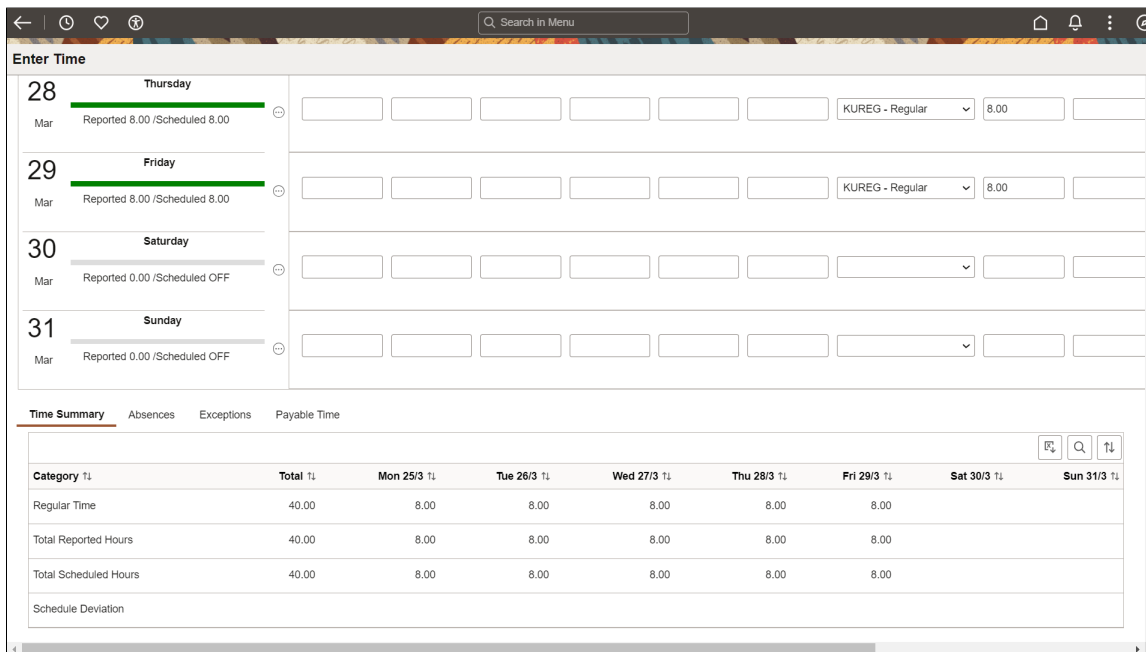

The Enter Time pages for elapsed time reporters show the **Time Details** icon when the **Expand Time Details on Timesheet** option is not selected under the *Fluid Timesheet* section in the Time and Labor Installation page.

For more details, see [Setting Up System Defaults and Loading Dates](#).

A ChartField is a data field that stores accounting information that affects budget and this field is used for internal and external reporting.

The ChartField is associated to search for valid **Combination Codes** or **Speed types** using table lookups.



The ChartField integration using Fluid is now available in Time and Labor for Managers and Employees. The user with the role TL Employee Time Fluid and Permission List ChartField Fluid (HCCPCF1000) can use this facility.

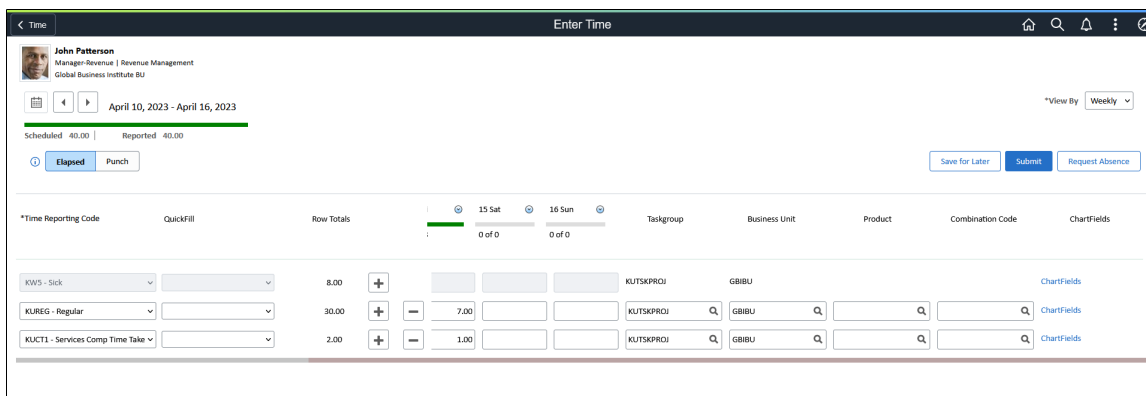

This example illustrates the fields and controls on the Enter Time Page with the ChartFields link. You can find definitions for the fields and controls later on this page.





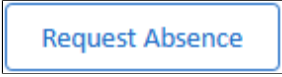

**Note:** When time details are expanded in the timesheet, the **Enter Time** page displays the combination code prompt and chart fields link for an elapsed time reporter.



For more information on common ChartField Pages, refer “Understanding ChartField Validation” (Application Fundamentals).

<b>Field or Control</b>	<b>Description</b>
<b>Employee Header</b>	Job information of the user is displayed based on the Employee Header configuration. The <b>Select Another Job</b> link will be enabled for employees with multiple active jobs to switch between them as required.
<b>Period Header</b>	<p>The period header lets user select the time period for which they will be reporting or viewing time.</p> <p>The default period for the user will be available for selection and is displayed below the dates. Users can control the time period defaults for time entry using the configuration under user preferences.</p> <p>Period Summary totals are displayed under the dates. If there is no schedule configured then the scheduled total will not display.</p> <p>All action buttons on the period header will perform the action for the period selected. If the user is viewing time for time period greater than a weeks time, then the time will be submitted for the entire period.</p> <p>The green or red banner represents the reported time against scheduled time.</p>
	Navigate to previous time period.
	Navigate to future time period.
<b>*View By</b>	<p>Enables the users to view the time reported by monthly, weekly, bi-weekly or by the period defined either on the time reporter's profile or on the Workgroup definition. By default, the view by period option displays the monthly data.</p> <p>Selecting the view by period option enables a scroll bar below the reported time to view the entire data for the date span. The columns with time entries are only moved upon scrolling and the other columns remain frozen.</p>

<b>Field or Control</b>	<b>Description</b>
<p><b>Weekly Banner, Scheduled and Reported</b></p>	<p>These are applicable only for elapsed reporters using desktop.</p> <p>Weekly summary will be displayed in the weekly banner. The summary will show the scheduled total and reported total for the week in view.</p> <p>If the selected time period for the user is greater than weekly, the weekly pagination (green banner) will be displayed.</p> <p>Users can enter time for one week at a time and navigate between weeks using the previous and next button on the weekly banner.</p> <hr/> <p><b>Note:</b> If there is no schedule configured then the scheduled total will not be displayed.</p>
	<p>Users can click on the Calendar icon to select a date from the calendar to view the weekly data starting from the selected date.</p>
	<p>Select to open <u>Request Absence Modal</u> (HGA_SS_REQ_FLU).</p> <p>If <b>Use Absence Approval Definition for Request Absence</b> is selected on the <u>Time and Labor Installation Page</u>, while requesting an absence, the absence will be routed for approval as per the approval definition ID set for that absence in Absence Management.</p>
	<p>Select to keep the entry as draft.</p> <hr/> <p><b>Note:</b> The time details that can be entered will depend on the configuration of the time reporting template used by the time reporter.</p>
	<p>Submit the timesheet entries.</p>
<p><b>Time Reporting Code/ Time Details</b></p>	<p>Select the Time Reporting Code (TRC).</p> <hr/> <p><b>Note:</b> Once the user selects the TRC and performs another action like navigating to the next or previous weeks or selecting apply rules, save for later button, then the row is locked for the TRC selected. The TRC selector will be grayed out and the time details will change to read-only. This is done to preserve data integrity when the user leaves the page.</p> <hr/> <p>The selected TRC will be available for the entire period spanning weeks in-case of bi-weekly or other periods and users can report the quantity against the same TRC and time details.</p>



<b>Field or Control</b>	<b>Description</b>
	<p>The Time details for different entries.</p> <p>See Time Details page for more details.</p> <p>This icon will be hidden and the time detail values are expanded in the timesheet pages if the option of <b>Expand Time Details on Timesheet</b> is selected in Time and Installation page.</p> <p>For more details, see <a href="#">Time and Labor Installation Page</a>.</p>
<p><b>Row Totals</b></p>	<p>The row total is displayed against each row for the selected period.</p>
	<p>Add a new row.</p>
	<p>Delete the entry which is not required. See the <a href="#">Delete Confirmation Page</a> for more details.</p>
<p><b>Days</b></p>	<p>Days of the week with scheduled and reported time is displayed. You can click on the Status bar and navigate to the requested page, while preserving the context of the date from which the action was performed.</p> <hr/> <p><b>Note:</b> Icons will appear in the boxes if the user has an exception, saved time, absence, or saved absences. The icons appear different for each case and users can hover on it to identify them. When approvals are configured the corresponding approval status icon will be displayed.</p> <hr/> <p>The visibility of the status bar can be controlled on the Time and Labor Installation. Administrators can set the options like hide/show and the default colors and patterns that will be available for their user population. Individual users can override the color preferences using the user fluid preferences. This status bar will not be automatically displayed if there is no schedule configured for the user.</p> <p>The green or red banner represents the reported time against scheduled time.</p> <hr/> <p><b>Note:</b> Current date is highlighted in blue.</p> <hr/>
	<p>Enables users to access related actions like Time Summary, Payable Time and Add/View Comments. Enter comments for the entries. See the <a href="#">Time Reporting Comments Page</a> for more details.</p>

<b>Field or Control</b>	<b>Description</b>
	Comments have been already entered for the time entry.
	Select this link to view the <a href="#">Legend Page</a> and review the patterns.  <hr/> <b>Note:</b> Any message or warning for the time reporter will appear in the screen below the View Legend link. On a Mobile device, the View Legend link re-directs you to the Weekly Time page.
<b>Elapsed/Punch button</b>	Select to switch the timesheet to either an elapsed time or a punch timesheet. This option may not be available, based on the configuration specified on the Time and Labor Installation page.

For details on the tabs available on the Enter Time page, see [Select Employee Page](#).

The following video provides an overview of the Attestation feature:

Video: [Image Highlights, PeopleSoft HCM Update Image 30: Fluid TL MSS Report Time Attestation](#)

This example illustrates the fields and controls of Elapsed Time Reporting enabled with Attestation.

**Acknowledge Reported Time**
×

I hereby certify that the time reported is a true and accurate representation of the time and assignments worked in the period.

I Agree

Accept and Continue

## Enter Time Details Page

Use Enter Time Details page to view and select ChartField links to for selecting advanced search of Combination Code.

Select the **Time Details** icon for viewing **Time Details** Page.

This example illustrates the fields and controls on the Enter Time Details page. You can find definitions for the fields and controls later on this page.

Select the **ChartFields** link to open the “ChartField Details Page” (Application Fundamentals).

---

**Note:** When **Time Details** icon is enabled, the **Time Details Page** display the combination code prompt and ChartFields link.

---

## Enter Time Page for Punch Time Reporter

Use Enter Time (TL\_PCH\_TIME\_FLU) page to enter time and view the default time period for the workgroup or the default time period based on the user preferences for a punch time reporter.

Navigation:

Select Time Tile available under Employee Self Service Home page to access the Tile Collections. You can select Enter Time tile to open Enter Time page.

You need to login as a punch time reporter.

Video: [PeopleSoft HCM Update Image 27: Time and labor Fluid Time Entry for Tablet and Desktop](#)

This example illustrates the fields and controls on the Employee Self Service - Enter Time (TL\_PCH\_TIME\_FLU) page for punch time reporters (1 of 2).

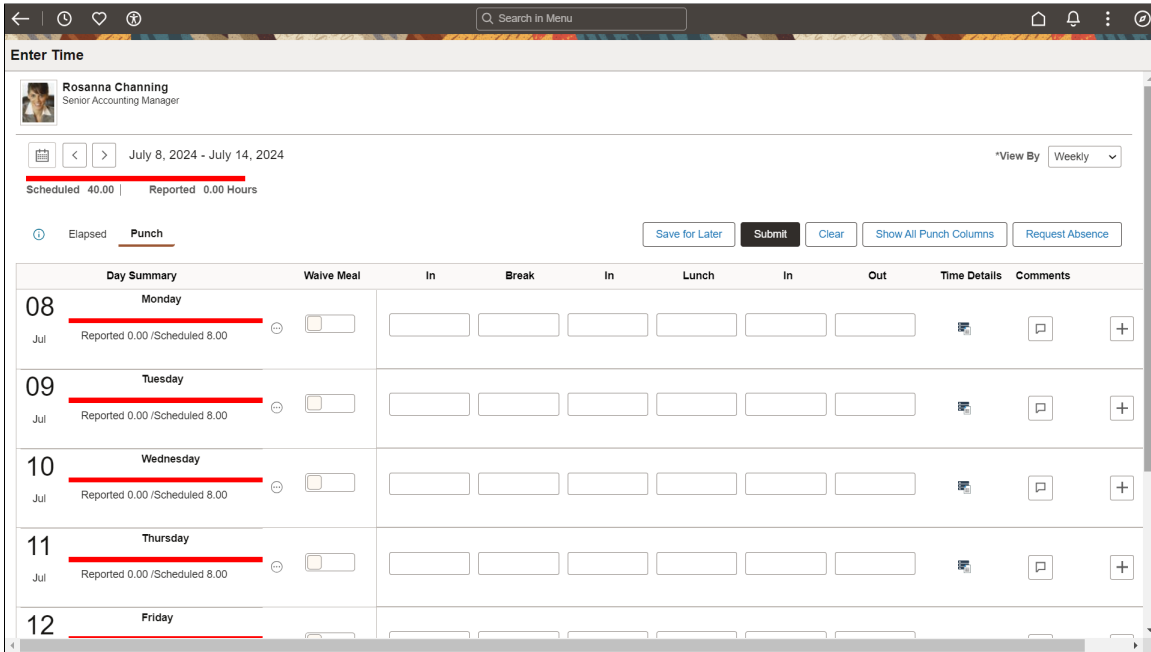

This example illustrates the fields and controls on the Employee Self Service - Enter Time (TL\_PCH\_TIME\_FLU) page for punch time reporters (2 of 2)

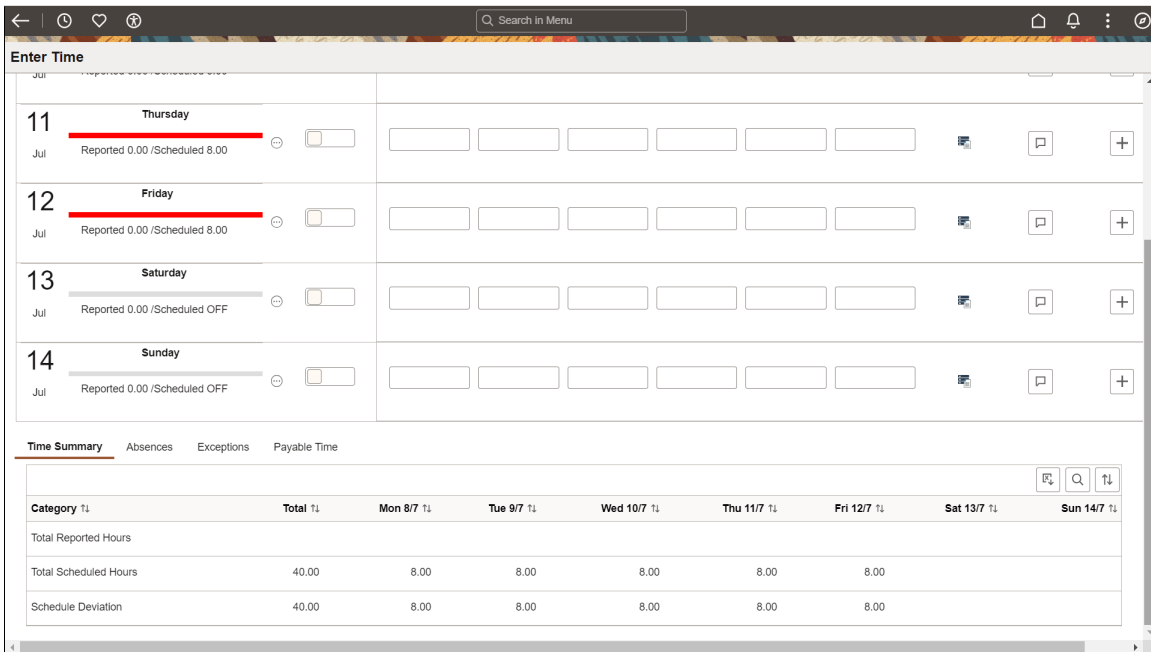



Select **Show All Punch Columns** to view all the punch breaks.



**Note:** For details on the tabs available on the Enter Time page, see [Select Employee Page](#).





Administrators can configure for employees to view the time detail values inline in the timesheet by selecting the option of [Expand Time Details on Timesheet](#) under the [Time and Labor Installation Page](#).

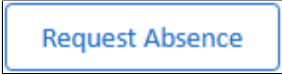

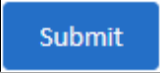

The Enter Time pages for Punch time reporters show **Time Details** icon when **Expand Time Details on Timesheet** option is not selected under *Fluid Timesheet* section in Time and Labor Installation page.

**Note:** When the expand time details is enabled, the **Enter Time** page display the ChartFields link and combination code prompt.

<b>Field or Control</b>	<b>Description</b>
<b>Employee Header</b>	Job information of the user is displayed based on the Employee Header configuration. The <b>Select Another Job</b> link will be enabled for employees with multiple active jobs to switch between them as required.
<b>Period Header</b>	<p>The period selector lets user select the time period for which they will be reporting or viewing time.</p> <p>The default period for the user will be available for selection and is displayed below the dates. Users can control the time period defaults for time entry using the configuration under user preferences.</p> <p>Period Summary totals are displayed under the dates. If there is no schedule configured then the scheduled total will not display.</p> <p>All action buttons on the period header will perform the action for the period selected. If the user is viewing time for time period greater than a week's time, then the time will be submitted for the entire period.</p> <p>The green or red banner represents the reported time against scheduled time.</p>
	Navigate to previous time period.
	Navigate to future time period.
<b>*View By</b>	<p>Enables the users to view the time reported by monthly, weekly, bi-weekly or by the period defined either on the time reporter's profile or on the Workgroup definition. By default, the view by period option displays the monthly data.</p> <p>Selecting the view by period option enables a scroll bar below the reported time to view the entire data for the date span. The columns with time entries are only moved upon scrolling and the other columns remain frozen.</p>

<b>Field or Control</b>	<b>Description</b>
<b>Weekly Banner, Scheduled and Reported</b>	<p>These are applicable only for elapsed reporters using desktop.</p> <p>Weekly summary will be displayed in the weekly banner. The summary will show the scheduled total and reported total for the week in view.</p> <p>If the selected time period for the user is greater than weekly, the weekly pagination (green banner) will be displayed.</p> <p>Users can enter time for one week at a time and navigate between weeks using the previous and next button on the weekly banner.</p> <hr/> <p><b>Note:</b> If there is no schedule configured then the scheduled total will not be displayed.</p>
<b>Waive Meal</b>	<p>To enable the meal break waiver option, select this option to allow employees and employers to agree manually to waive a meal break.</p> <p>For details on waive meal functionality, see <a href="#">Setting up Meal Break Waivers for Non-Exempt Workers</a>.</p> <p>This field is displayed only if:</p> <ul style="list-style-type: none"> <li>the employee (Employee for the selected job) is under the regulatory region of the state that is enabled under the Meal Option Waiver tab of the TL Installation page.</li> <li>The workgroup override is set to off for the workgroup this employee belongs to.</li> </ul> <hr/> <p><b>Note:</b> For Cross-over shifts, the meal waiver should be selected on the day of the first In punch.</p> <hr/> <p>When you select this option and click Submit, the Acknowledge Meal Waiver modal will appear. To proceed, click the I Agree checkbox and then the Accept and Continue button.</p> <p>The Acknowledgment Meal Waiver modal will only appear if acknowledgment is enabled in the set-up.</p>
	<p>Users can click on the Calendar icon to select a date from the calendar to view the weekly data starting from the selected date.</p>
	<p>Select to open <a href="#">Request Absence Modal</a> (HGA_SS_REQ_FLU).</p>
	<p>Select to display all punch patterns and breaks used in the punch reporting. For more information, refer to the <a href="#">Punch Pattern Page</a> in <a href="#">Creating Time Reporting Templates</a>.</p>

<b>Field or Control</b>	<b>Description</b>
	Select to clear all the punch entries.
	Select to keep the entry as draft.  <hr/> <b>Note:</b> The time details that can be entered will depend on the configuration of the time reporting template used by the time reporter.
	Submit the timesheet entries.
<b>Time Reporting Code/ Time Details</b>	Select the Time Reporting Code (TRC).  <hr/> <b>Note:</b> Once the user selects the TRC and performs another action like navigating to the next or previous weeks or selecting apply rules, save for later button, then the row is locked for the TRC selected. The TRC selector will be grayed out and the time details will change to read-only. This is done to preserve data integrity when the user leaves the page.  <hr/> The selected TRC will be available for the entire period spanning weeks in-case of bi-weekly or other periods and users can report the quantity against the same TRC and time details.
<b>Quick Fill/ Time Details</b>	Select saved Quick-Fill/ Time Details.
	Time details for different entries.  This icon will be hidden and the time detail values are expanded in the timesheet pages if the option of <b>Expand Time Details on Timesheet</b> is selected in <a href="#">Time and Labor Installation Page</a> .

<b>Field or Control</b>	<b>Description</b>
<p><b>Days</b></p>	<p>Days of the week with scheduled and reported time is displayed. You can click on the Status bar and navigate to the requested page, while preserving the context of the date from which the action was performed.</p> <hr/> <p><b>Note:</b> Icons will appear in the boxes if the user has an exception or saved time. When approvals are configured the approval status for the time reported can be viewed here.</p> <hr/> <p>The visibility of the status bar can be controlled on the Time and Labor Installation. Administrators can set the options like hide/show and the default colors and patters that will be available for their user population. Individual users can override the color preferences using the user fluid preferences. This status bar will not be automatically displayed if there is no schedule configured for the user.</p> <p>The green or red banner represents the reported time against scheduled time.</p> <hr/> <p><b>Note:</b> Current date is highlighted in blue.</p>
	<p>Add a new row.</p>
	<p>Delete the entry which is not required. See the <a href="#">Delete Confirmation Page</a> for more details.</p>
	<p>Enter comments for the entries. See the <a href="#">Time Reporting Comments Page</a> for more details.</p>
	<p>Comments have been already entered for the time entry.</p>
	<p>Select this link to view the <a href="#">Legend Page</a> and review the patterns.</p> <hr/> <p><b>Note:</b> Any message or warning for the time reporter will appear in the screen below the View Legend link. On a Smartphone, the <b>View Legend</b> link re-directs you to the Weekly Time page.</p>



<b>Field or Control</b>	<b>Description</b>
	Enables users to access related actions like Time Summary, View Payable Time and Attendance Violations. Enter comments for the entries.

## Legend Page

Employee can use Legends (TL\_ICON\_LEGEND\_SCF) window to view the legends used and a short description of legends.

Navigation:

Select the View Legend hyperlink to open Legends window.

This example illustrates the legend patterns.

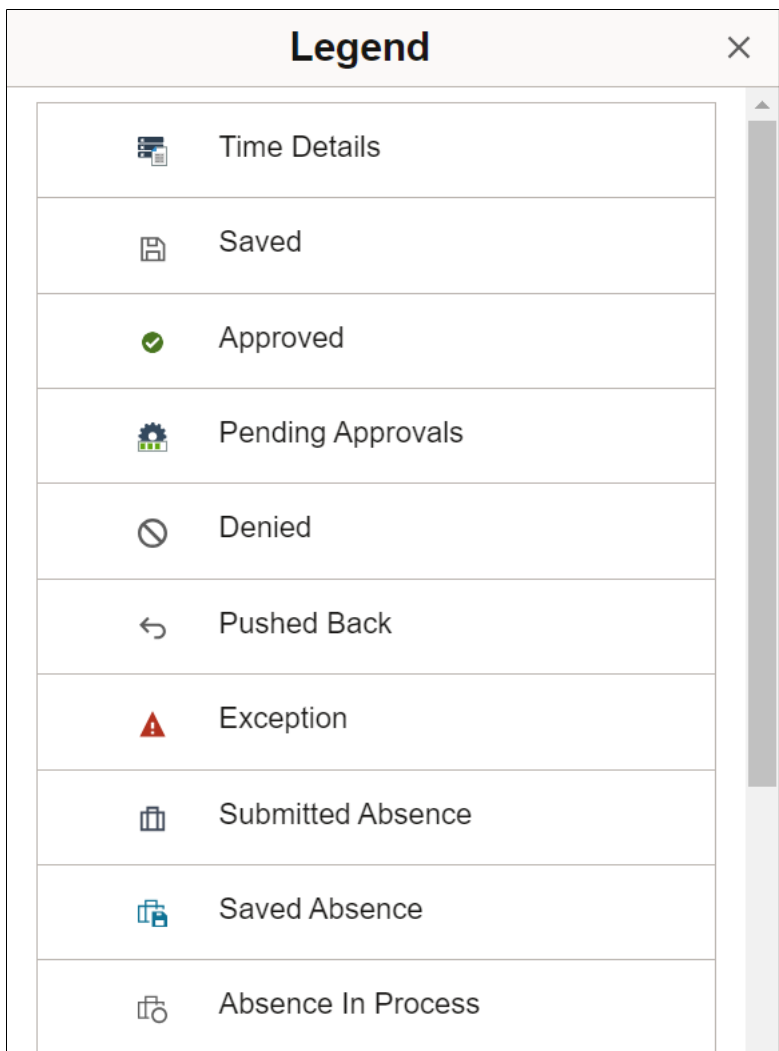

This example illustrates the legend patterns (2\_2) window

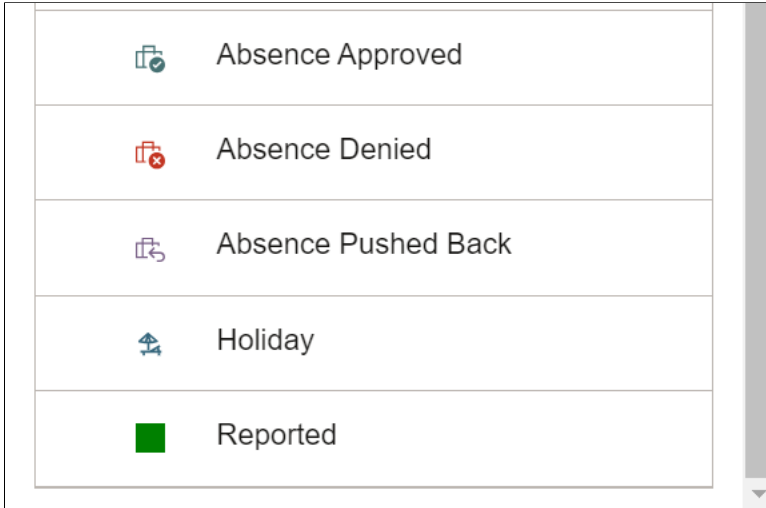

**Note:** The Reported, Reported Under Schedule, and Reported Over Schedule legend colors are dynamic. Your Organization configures the color combination as per the need in User Preferences.

## Request Absence Modal

Employee can use Request Absence (TL\_TR\_COMMENT\_FLU) modal to report the absence from enter time page.

Navigation:

Select the **Request Absence** button from Enter Time page to open Request Absence modal.

This example illustrates the fields and controls of Time Reporting modal.

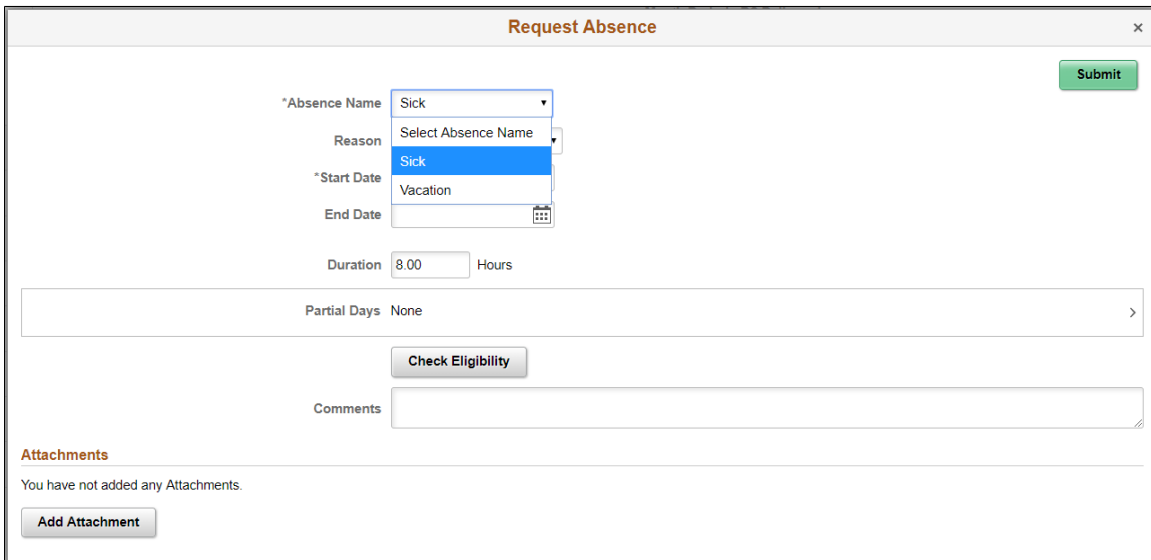

## Time Reporting Comments Page

Employee can use Time Reporting Comments (TL\_TR\_COMMENT\_FLU) page to enter comments for the time reported.

Navigation:

Select the comments icon to open Time Reporting comments page.

This example illustrates the fields and controls of Time Reporting Comments page for employees.

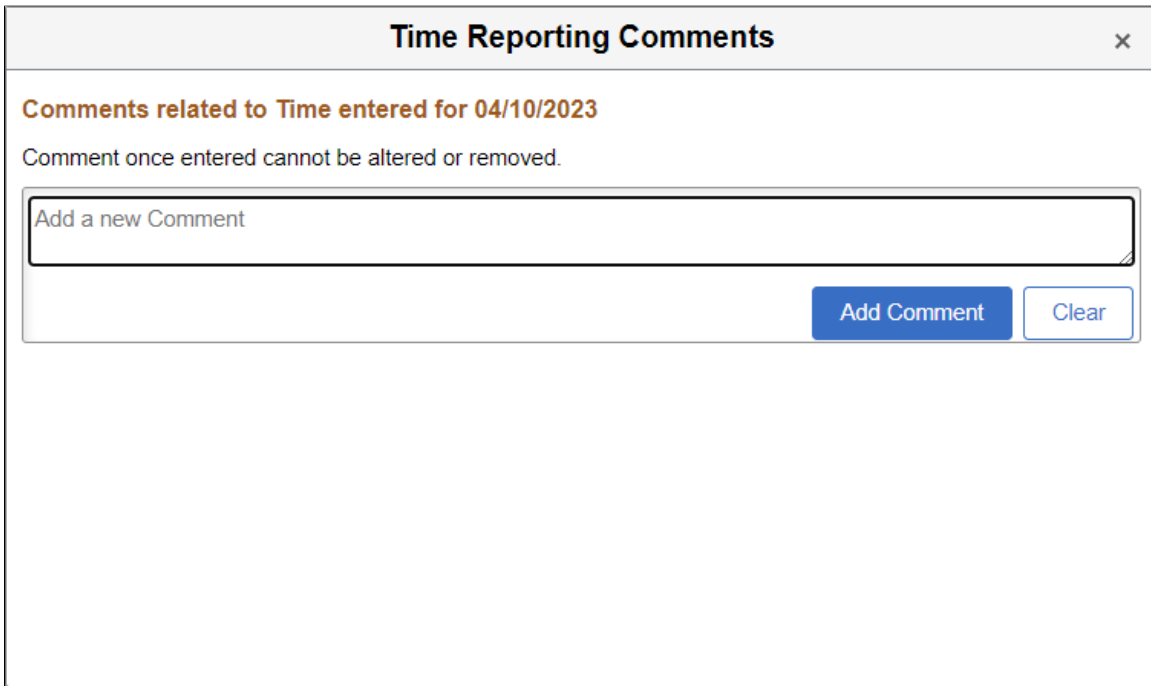

## Delete Confirmation Page

Employee can use Delete Confirmation (TL\_DEL\_CONFIRM\_FLU) window to confirm deletion before the final delete.

Navigation:

Select the negative icon to get the Delete Confirmation window.

This example illustrates the fields and controls of delete confirmation modal.

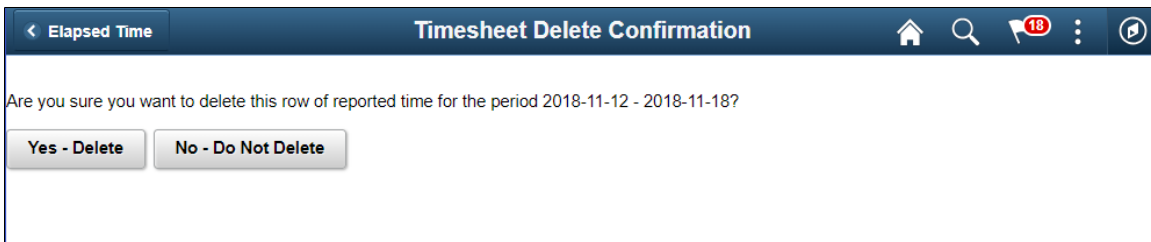

## Report Time Tile

Select Report (Time Tile (HC\_TL\_ENTER\_TIME\_FLU\_GBL) to navigate to **Report Time** page.

Navigation:

Select Time Tile available under Employee Self Service Home page to access the Tile Collections. You can select Report Time tile to open Report Time page.

This example illustrates the Report Time tile.

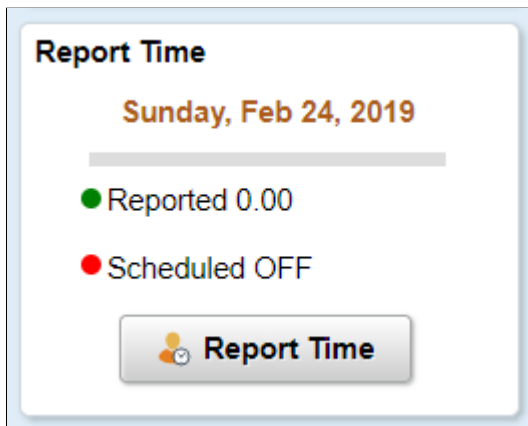

The Punch time reporter can only see the Report Time tile on the .

This example illustrates the Report Time tile.

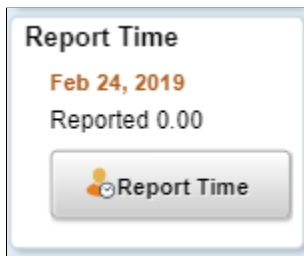

Both Enter Time and Report Time tiles are available on the desktop for the punch time reporter. But while using Smartphone, the punch time reporter can see the Report Time tile only. If you want to see the Webclock / Report Time page, then ensure the Time field on the Time Reporting Template is enabled. This enables the Report Time button for time reporter on the Report Time tile to report time for the selected punch type.

This example illustrates the Report Time tile for punch time reporters.

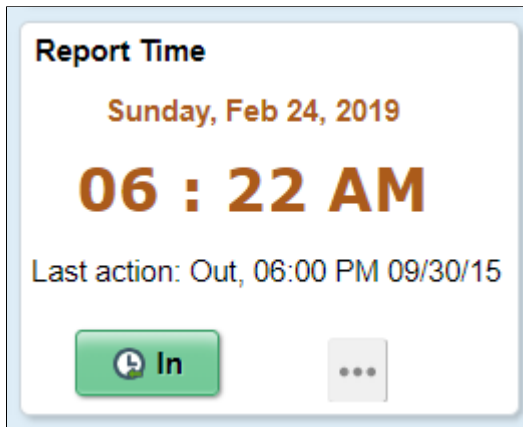

The Report Time tile is not available while using a phone for punch time reporters.

The tile displays the current date based on users time zone irrespective of any crossover punches pending action. The second line displays the live time with a dynamic refresh in HH:MM AM/PM format for user preferences of 12 hour time display and in HH:MM for user preferences of 24 hour time display. The next line shows last action as shown on the Daily Time page. A button on next logical punch and actions button are available on the tile.

This example illustrates the actions options available for a punch time reporter while using Report Time tile.

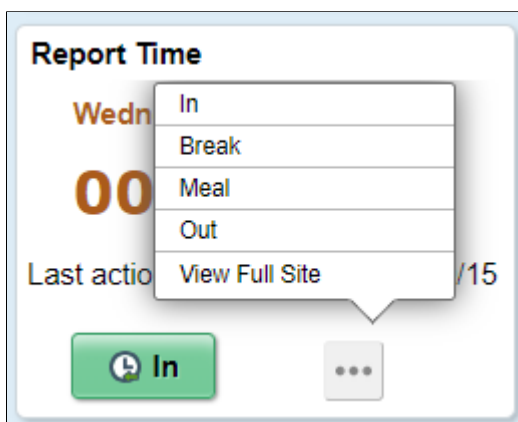

The tile will display the next logical button according to the last action performed. Select actions icon to select any other options than logical punch. The Actions button is enabled with **View Full Site**. Employee can navigate to Report Time page for daily time reporting.

## Report Time Page for Elapsed Time Reporter

Use the Report Time page (TL\_RPTD\_ELP\_FLU) to navigate to the different reporting time options when logged in as an elapsed time reporter.

Navigation:

Select the **Time** tile on the Employee Self Service page or a homepage where the tile is added.

Select **Report Time** tile from the Tile Collections .

This example illustrates the fields and controls on the Employee Self Service - Report Time page for Elapsed time reporter.

**Report Time**

Thursday, Oct 24, 2019

**Reported Status**

Reported 0.00 Scheduled 8.00

**Submit**

\*Time Reporting Code: Regular

Quick Fill: Data Testing

Quantity: 8.00 Hours

**Time Details**

\*Taskgroup: KUPROJECT Project Activity Task Group

\*Project ID: KUTSK Special Task Force

\*Activity ID: KUTEST Testing

Submitted 0 Hours

Comments (0)

Last reported time was on Friday, Oct 18, 2019.

This example illustrates the fields and controls on the Report Time Page with ChartFields.

**Report Time**

John Patterson  
Manager: Revenue | Revenue Management  
Global Business Institute BU

Wednesday, Apr 12, 2023

**Reported Status**

Reported 8.00 Scheduled 8.00

**Submit**

\*Time Reporting Code

Quantity

**Time Details**

\*Taskgroup: KUTSKPROJ Taskgroup for Proj Integration

Business Unit: GBIBU Global Business Institute BU

Product: [ChartFields](#)

Combination Code

Submitted 0 Hours

Comments (0)

Select **ChartFields** hyperlink to navigate to “ChartField Details Page” (Application Fundamentals) for selecting the required combination code.

This example illustrates the fields and controls on the Employee Self Service - Report Time page for elapsed time reporter using a smartphone.

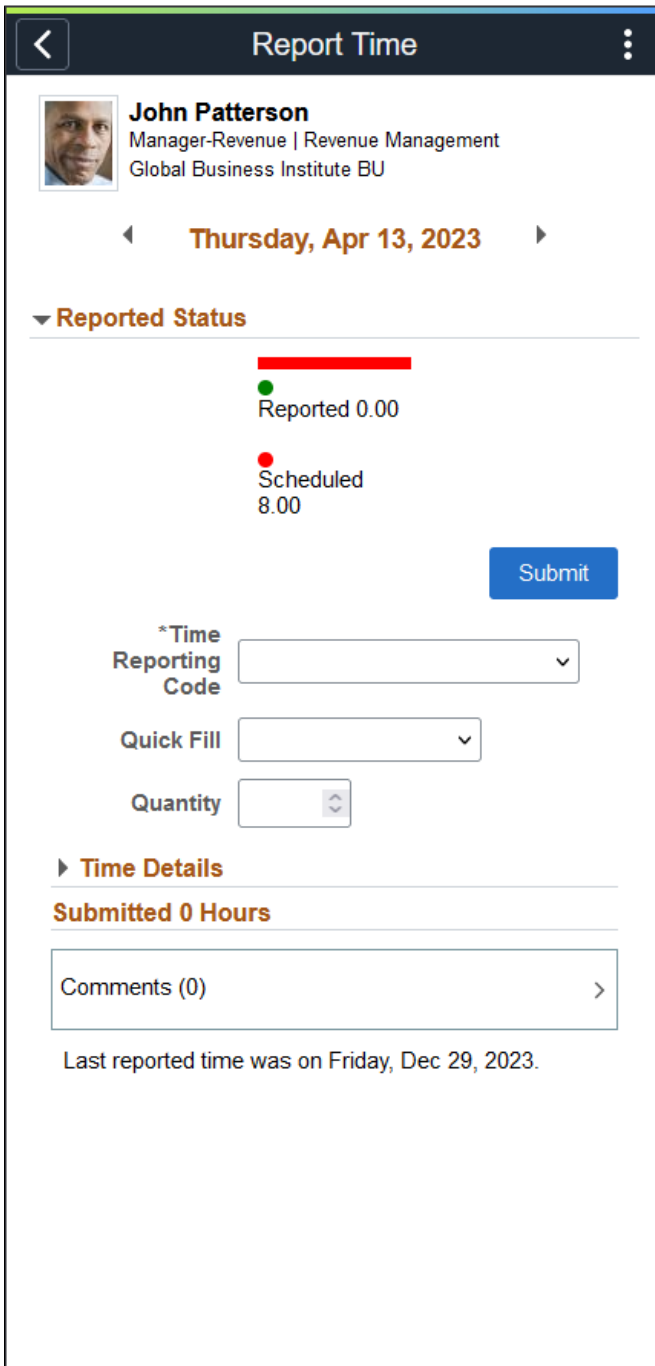

**Report Time**

**John Patterson**  
Manager-Revenue | Revenue Management  
Global Business Institute BU

**Thursday, Apr 13, 2023**

**Reported Status**

Reported 0.00

Scheduled 8.00

**Submit**

\*Time Reporting Code

Quick Fill

Quantity

**Time Details**

**Submitted 0 Hours**

Comments (0) >

Last reported time was on Friday, Dec 29, 2023.

This example illustrates the fields and controls on the Employee Self Service - Report Time Page with ChartFields. You can find definitions for the fields and controls later on this page.

**Note:** Quick fill and the status bar display on the basis of the user configurations.

<b>Field or Control</b>	<b>Description</b>
<b>Punch Type</b>	Enter the Punch type as <i>In, Out, Meal, Break, or Transfer</i> . as per the requirement.



<b>Field or Control</b>	<b>Description</b>
<b>Time Reporting Code</b>	Element of compensation or a bucket of several elements in which the system collects labor data, hours, amounts, or units worked. Select <b>Regular</b> or <b>Holiday</b> .
<b>Time Details</b>	Collapsible group box that contains any fields configured to be shown on the phone other than Punch Type, or TRC.
<b>Comments</b>	Select the chevron to open the <a href="#">Time Reporting Comments Page</a> to enter the comments. Once saved, you can view the comments entered for a time.
<b>Submit</b>	Select to submit the reported time.

## Setting up Meal Break Waivers for Non-Exempt Workers

PeopleSoft offers the flexibility for time reporters to waive breaks, calculating regular pay when breaks are not taken or waived. This enables non-exempt workers to enter instances where they have waived their meal or rest breaks, ensuring that the organization maintains accurate records and can demonstrate compliance with applicable state laws. Additionally, the system should be capable of calculating the appropriate regular pay for employees who do not take or waive their breaks, ensuring that they are compensated correctly.

Use the Meal Break Waiver Setup page (TL\_ML\_BRK\_WVR\_FL) to add the participating states.

Navigation:

Select the **Time and Labor** tile on the Workforce Administrator page.

Select the **Meal Waiver Settings** tile.

This example illustrates the fields and controls on the Meal Break Waiver Setup page.

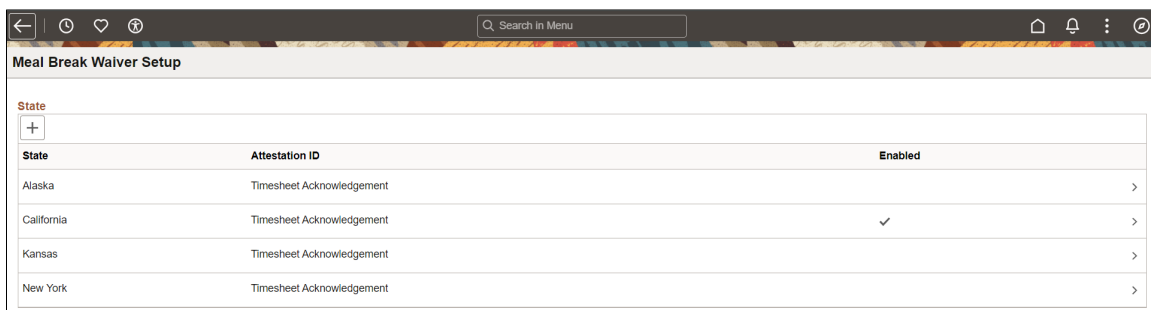

<b>Field or Control</b>	<b>Description</b>
<b>State</b>	Displays the participating state.

<b>Field or Control</b>	<b>Description</b>
<b>Attestation ID</b>	Displays the acknowledgement ID. For details on acknowledgement framework, see “Understanding the Acknowledgement Framework” (Enterprise Components).
<b>Enabled</b>	Displays whether the meal waiver option is enabled for the corresponding state.

To add more participating states, click the + button. This displays the State modal window.

This example illustrates the State modal window.

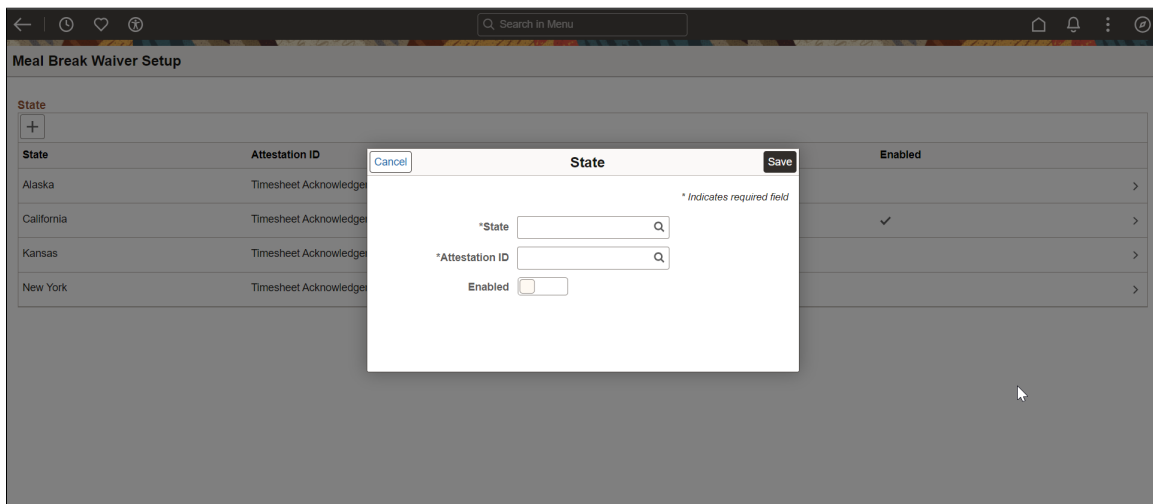

Configure the State modal as per requirement and click Save.

## Report Time Page for Punch Time Reporter

Use the Report Time page (TL\_WEB\_CLOCK\_FLU) to navigate to the different reporting time options for Punch time reporter.

Navigation:

Select the **Time** tile on the Employee Self Service page or a homepage where the tile is added.

Select **Report Time** tile from Time Tile collections.

This example illustrates the fields and controls Report Time Page when the employee is logged in as a Punch Time reporter.

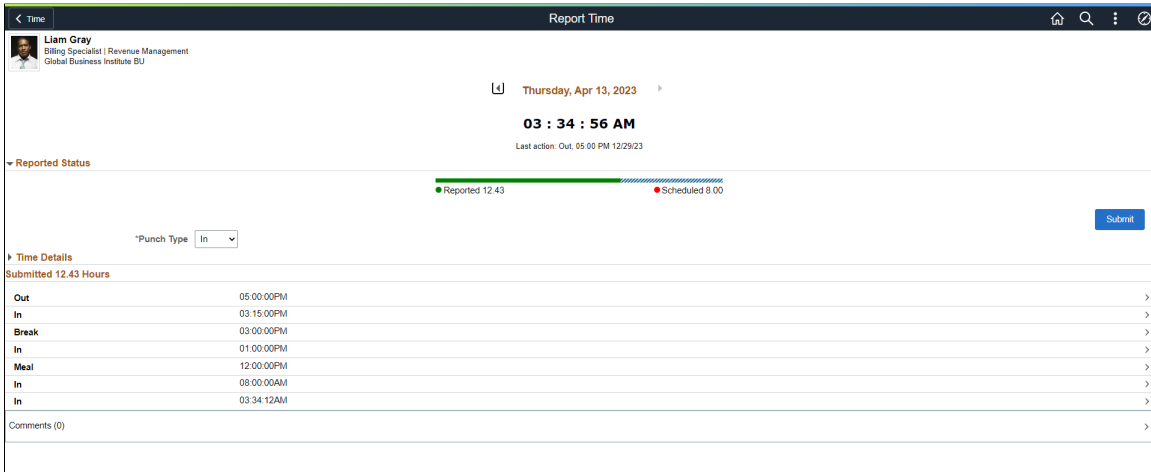

This example illustrates the fields and controls on the Report Time Page for Punch Time Reporter with ChartField. You can find definitions for the fields and controls later on this page.

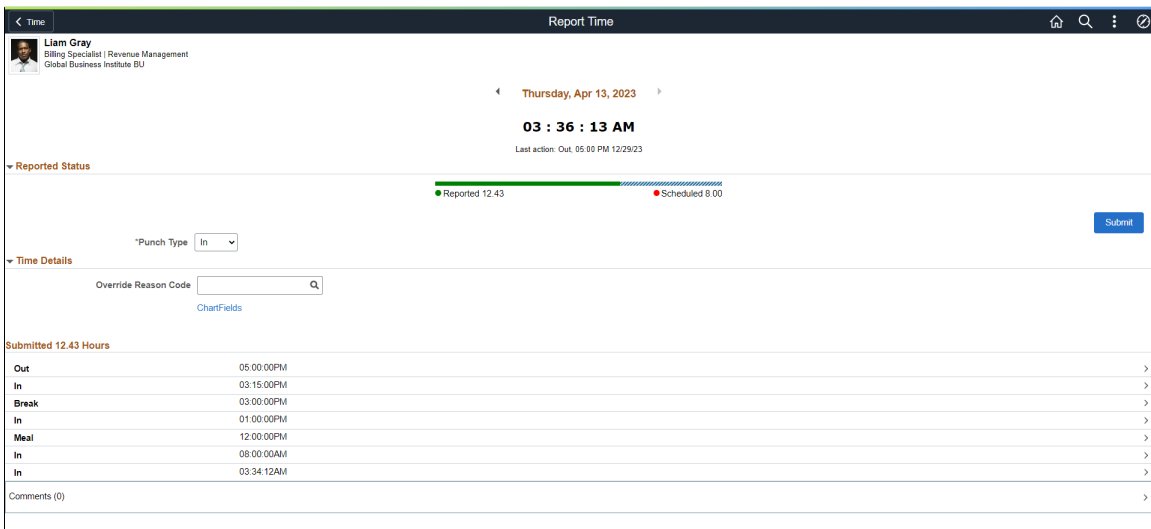

Select the ChartFields link to open the ChartField Detail page. You can select the ChartField Details or do an advanced search of Combination code and Speed Types in ChartField Detail modal.

This example illustrates the fields and controls on the Report Time\_ChartField Detail for Punch Time.

Cancel
**ChartField Detail**
Done

Combination Code   [Advanced Search](#)

**ChartField Detail**

Account <input type="text"/> <input type="button" value="Q"/>	Department <input type="text"/> <input type="button" value="Q"/>
Project/Grant <input type="text"/> <input type="button" value="Q"/>	Product <input type="text"/> <input type="button" value="Q"/>
Fund Code <input type="text"/> <input type="button" value="Q"/>	Program Code <input type="text"/> <input type="button" value="Q"/>
Class Field <input type="text"/> <input type="button" value="Q"/>	Affiliate <input type="text"/> <input type="button" value="Q"/>
Operating Unit <input type="text"/> <input type="button" value="Q"/>	Alternate Account <input type="text"/> <input type="button" value="Q"/>
Budget Reference <input type="text"/> <input type="button" value="Q"/>	Chartfield 1 <input type="text"/> <input type="button" value="Q"/>
Chartfield 2 <input type="text"/> <input type="button" value="Q"/>	Chartfield 3 <input type="text"/> <input type="button" value="Q"/>

<b>Field or Control</b>	<b>Description</b>
<b>Punch Type</b>	Enter the Punch type as <i>In, Out, Meal, Break, or Transfer</i> . as per the requirement.
<b>Time Reporting Code</b>	Element of compensation or a bucket of several elements in which the system collects labor data, hours, amounts, or units worked. Select <b>Regular</b> or <b>Holiday</b> .
<b>Time Details</b>	Collapsible group box that contains any fields configured to be shown on the phone other than Punch Type, or TRC.
<b>Submit</b>	Select to submit the reported time.

This example illustrates the fields and controls of Report Time Page when the employee is logged in as a Punch Time reporter using smartphone.

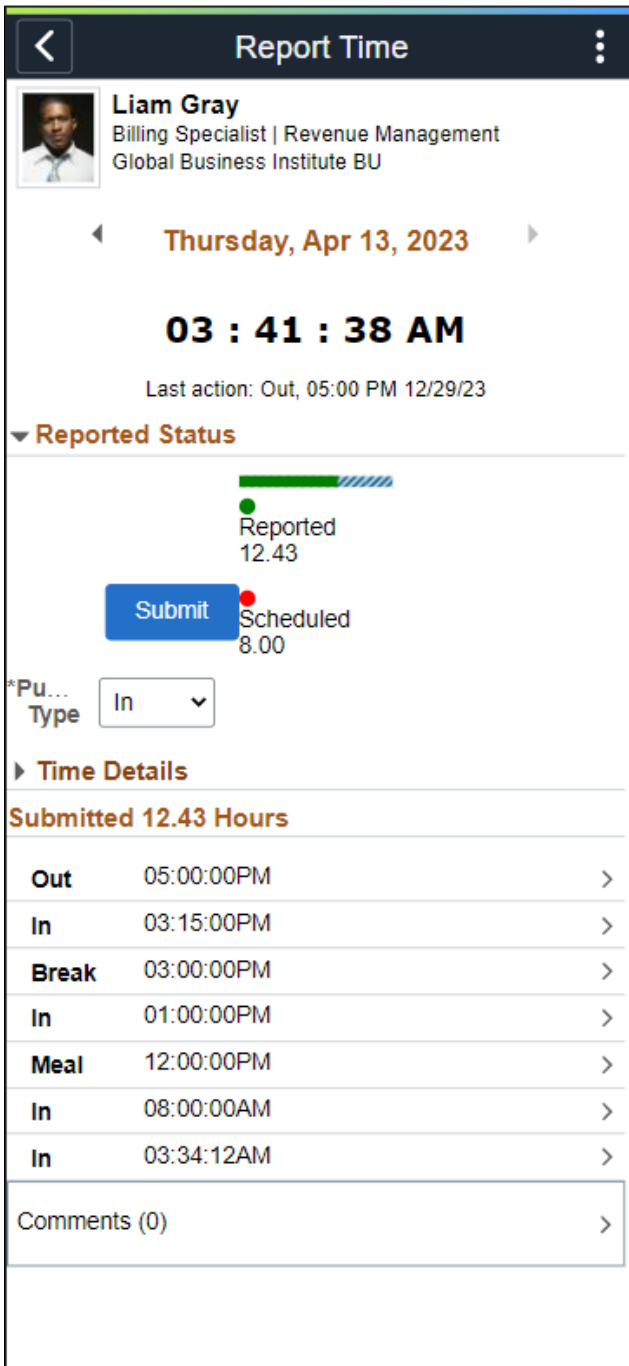



The Time page displays options according to the employees permissions.

You can use the employee punch template to identify the punch pattern and insert the punch patterns as next items. The button bar displays two up-front actions listed and the others under **Actions** overflow.

When an employee is enrolled as a punch time reporter, the reported time is captured as a point in time rather than duration. In and out pairs are used to calculate the duration of time worked.

If the **Time** options are disabled on the Punch template, a read-only running digital clock with seconds tracked displays at the top of the page. It uses the format HH:MM:SS. suffix the clock with AM or PM. accordingly. Below the clock displays the last action taken by you.

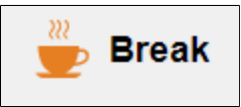
When **Time** option is enabled, the time clock displays the days details.

<b>Field or Control</b>	<b>Description</b>
	Select to display the next logical punch for the time reporter.
	Select to enter the break details.  for example, once Meal is selected, the next punch in the list <b>In</b> comes in the place of <b>Meal</b> . The logical punch <b>Meal</b> will not be displayed unless it re-occurs in the punch pattern later.
	Display the overflow actions like regular related action. Select the vertical dots see the action overflow.  On selecting <b>Actions</b> , you can select any other action like <b>In</b> , <b>Meal</b> or <b>Out</b> .

**Note:** Primary action or the first action in the list is highlighted in green. Other actions depicts in the grey background. Once the action is recorded, the next logical punch from the sequence replaces the action taken. The reporting page display is determined by the employees time reporter type of Punch or Elapsed Timesheet. When the employee taps to expand the group boxes in punch type, the fields that display are determined by the settings in the Time Reporting template and the Task Template.

These options are valid only for an employee who has been logged in as an Elapsed Time reporter.

When an employee is enrolled as an elapsed time reporter, the reported time is captured as a duration when the TRC Type is in Hours. The employee will enter a value in the Quantity field and the value entered will represent the number of hours worked.

To display the next logical punch shift, the system checks the employee's punch pattern. System would check if shift exists for the employee then the **Punch Schedule** is used. If the schedule is unavailable, the system uses the following sequence to derive the next logical punch.

1. Time reporting template from time reporter data.
2. Time reporting template from Taskgroup.
3. Punch pattern from Time and Labor Installation.

<b>Field or Control</b>	<b>Description</b>
<b>Time Reporting Code</b>	The reported time is captured as a duration when the time reporting code type is in hours.

<b>Field or Control</b>	<b>Description</b>
<b>Quick Fill</b>	Select the pre-entered or saved time schedule
<b>Quantity</b>	Enter a value which represents the number of hours worked.
<b>Time Details</b>	Collapsible group box that contains any fields configured to show fields based on time reporting template and taskgroup.
<b>Summary and Detail tabs</b>	For the submitted hours grid, the summary view shows TRC with Quantity, where as the details view shows all available fields.

---

**Note:** The employee can select the TRC which represents the unit of measure other than hours.

---

This example illustrates the fields and controls on the Report Time Page for Punch Time Reporter with comments. You can find definitions for the fields and controls later on this page.

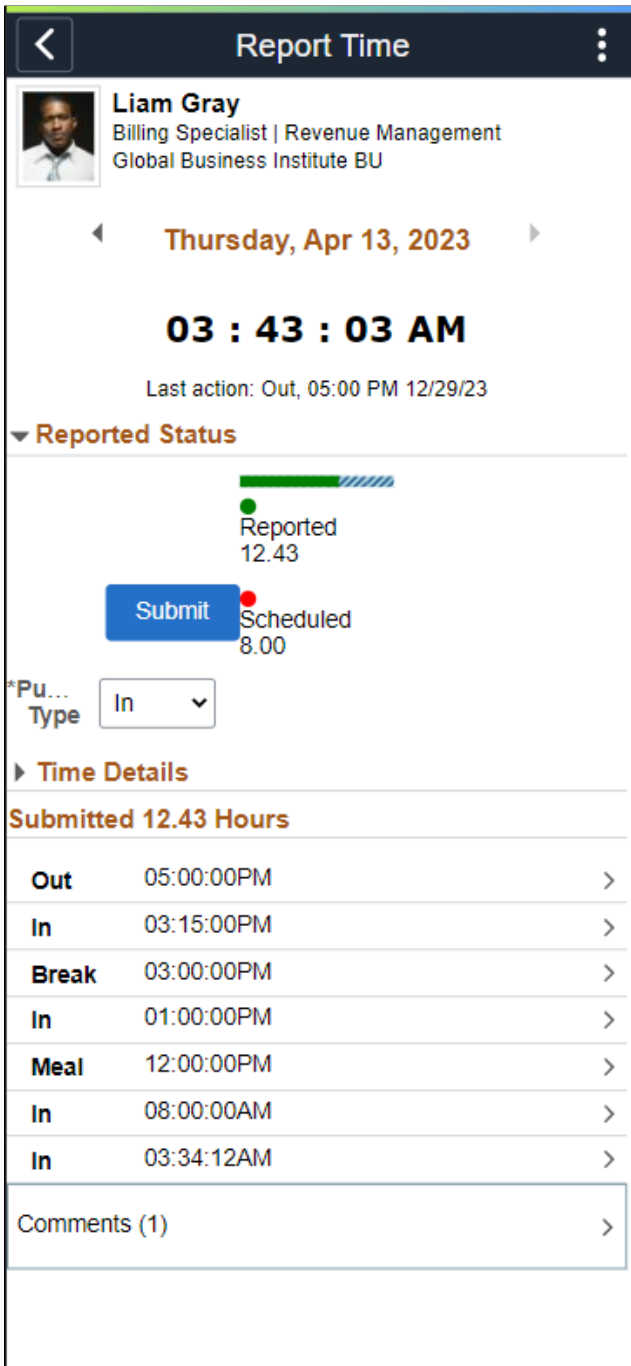

<b>Field or Control</b>	<b>Description</b>
<b>Comments</b>	Select the chevron to open the <a href="#">Time Reporting Comments Page</a> to enter and save the comments for future reference.



## Copying Time

For employees whose time reporting is not varying from week to week, the administrator can set up the **My Preferences** to copy time which is previously reported, schedules of the employee or predefined Task Values.

There are three options in user preferences for copying time, they are **Prior Period**, **Schedule**, and **Task Values**.

<i>Field or Control</i>	<i>Description</i>
<b>Prior Period</b>	Employee can copy the time reported seven days prior to the current day and this time is added to the current day.
<b>Schedule</b>	Employee can copy the time schedule for a particular day from the employee schedule and is added to the current time.
<b>Task Values</b>	Employee can copy the task value set up in PIA User preferences at the user level and is added to the current time.

**Note:** The **Copy button** appears on the **Report Time** page, when the options of **Prior Period**, **Schedule**, or **Task Values** are enabled in user preferences. Copy Time is available only in case of time reporting for today's date.

If the administrator allows user override, the user can specify their own preference on their user preference.

## Reporting Time Page for Multiple Jobs

An employee can have more than one active job at a time. This is represented in the Job component as multiple employee record numbers. Each job in the job record for a single employee should be designed so that the Job Title for each employee record number is unique. Company Directory, Absence Management and Time and Labor components use the Job Title on the Job record to select each job when an employee has multiple jobs.

The multiple job drop-down list box is visible only when an employee has more than one active job. All active jobs will be displayed in the drop-down list box.

To avoid inadvertent time reporting against an incorrect job, the employee need to select a job before submitting the time.

This example illustrates the fields and controls on the Time reporting for an employee having multiple jobs.

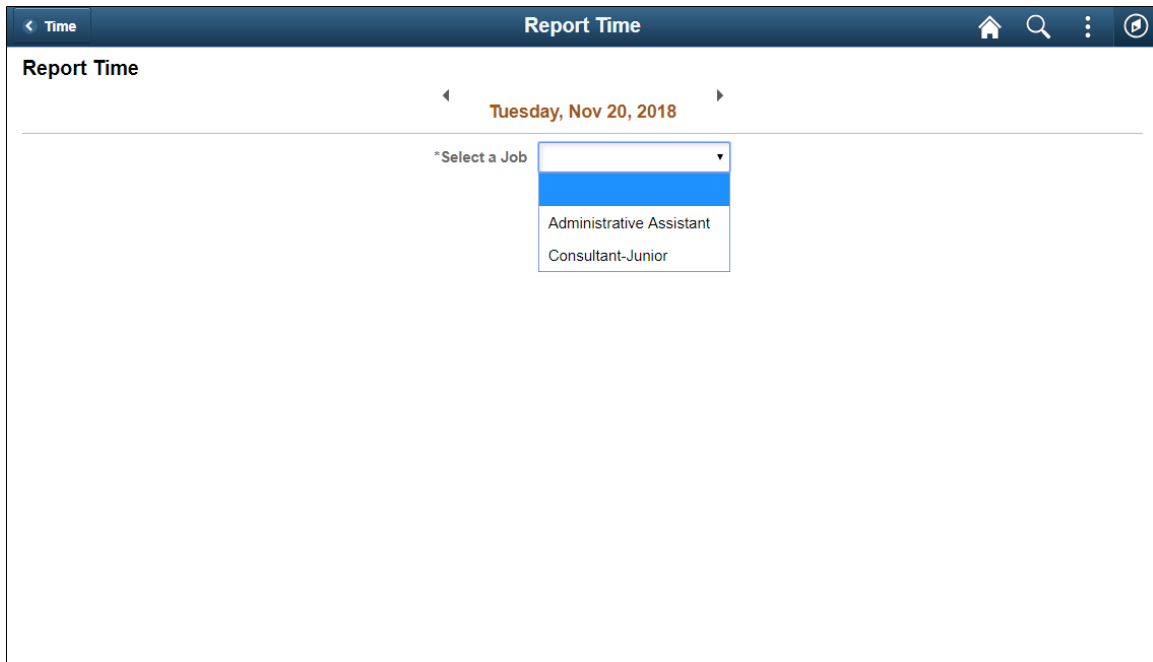

The employee can select a different job by tapping on the Job drop-down list box again and selecting another job. After selecting a different job from the drop-down list box, the screen is updated with information for the newly selected job. As the employee navigates between jobs and dates, the **Report Time** screen may display elapsed time fields or punch time fields depending upon the configuration of the job.

Multiple jobs applies for the following transactions:

- Report Time
- Report Leave
- Timesheet
- Weekly Time Summary
- Payable Time
- Leave and Comp Balances

## Time Summary Tile

Select Time Summary Tile (HC\_TL\_TIME\_SUM\_FLU\_GBL) to navigate to **Time Summary** page.

Navigation:

Select Time tile available under Employee Self Service Home page to access the Tile Collections. You can select Time Summary tile to open Time Summary page.

This example illustrates the Time Summary tile.

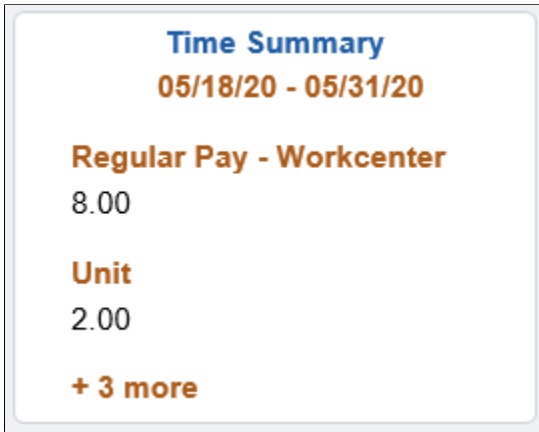

Different Fluid Time sheet pages and Time Summary tile displays the reported time total in different time units.

The following video gives an overview of Reported Time totals for units and amounts:

Video: [Image Highlights, PeopleSoft HCM Update Image 35: Reported Time Totals for Units and Amounts.](#)

The time entry for more than one entries display as link at the bottom of the tile as an extended link.



For Phone, the Enter Time Page is not available. You can use Report Time tile and Report Time Page for reporting time.

## Time Summary Page

This Time Summary (TL\_TIME\_SUM\_FLU) page is used to view the time summary for a particular period, weekly, bi-weekly and monthly time entries by an employee.

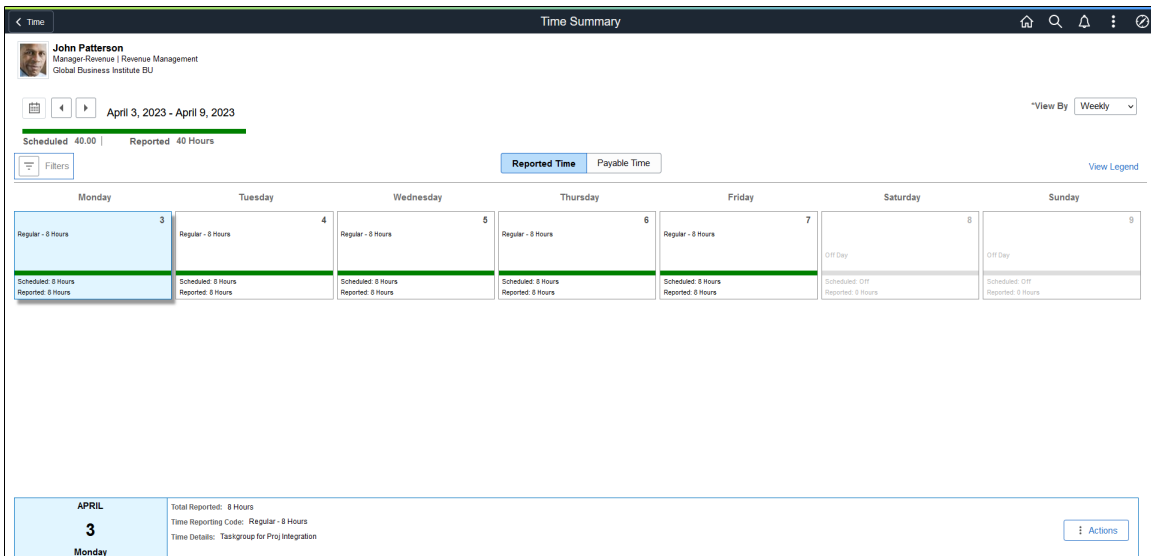
This example illustrates the fields and controls of Time Summary: Weekly page for an Elapsed Time Reporter.



<b>Field or Control</b>	<b>Description</b>
<b>Job Title</b>	Job title of the user is displayed based on the HR Fluid Header configuration. The <b>Select Another Job</b> link will be enabled for employees with multiple active jobs that leads to a Change Job Selection window.
<b>Period Header</b>	<p>The period selector lets user select the time period for which they will be reporting or viewing time.</p> <p>The default period for the user will be available for selection and is displayed below the dates. Users can control the time period defaults for time entry using the configuration under user preferences.</p> <p>Period Summary totals are displayed under the dates. If there is no schedule configured then the scheduled total will not display.</p> <p>The green or red banner represents the reported time against scheduled time.</p>
	Users can click on the Calendar icon to select a date from the calendar to view the weekly data starting from the selected date.
<b>View By</b>	Select from the options Biweekly, Monthly, Weekly or for a particular Period.
<b>Days</b>	<p>Each box will display up-to 3 TRC's with accumulated time. Icons will appear for the day to display exception, saved time and approval statuses. Each box will also display the status bar if a schedule is configured and will display the schedule and reported total for that day.</p> <hr/> <p><b>Note:</b> Current date is highlighted in blue.</p> <hr/>
	Select to go to more actions, you can edit time using this option.

This example illustrates the fields and controls on the Time Summary Reported Time Tab. You can find definitions for the fields and controls later on this page.

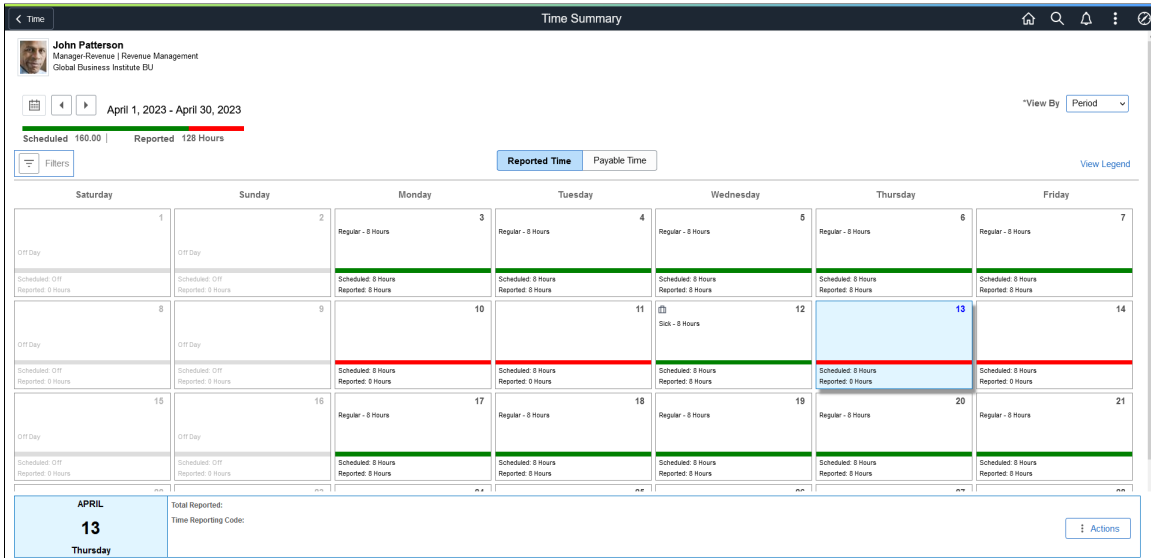

The Time Summary page reported time tab displays the reported time in different units other than hours for an employee in header, day box and footer.

**Note:** The Reported Time tab hides the TRC types **Units** and **Dollars** for a day when the particular TRC types are not present for the day. The page header hides the **Units** and **Dollars** if all the time reported for the chosen period is only of **Hours**.

This example illustrates the fields and controls of the Time Summary: Bi-Weekly page for an Elapsed Time Reporter.

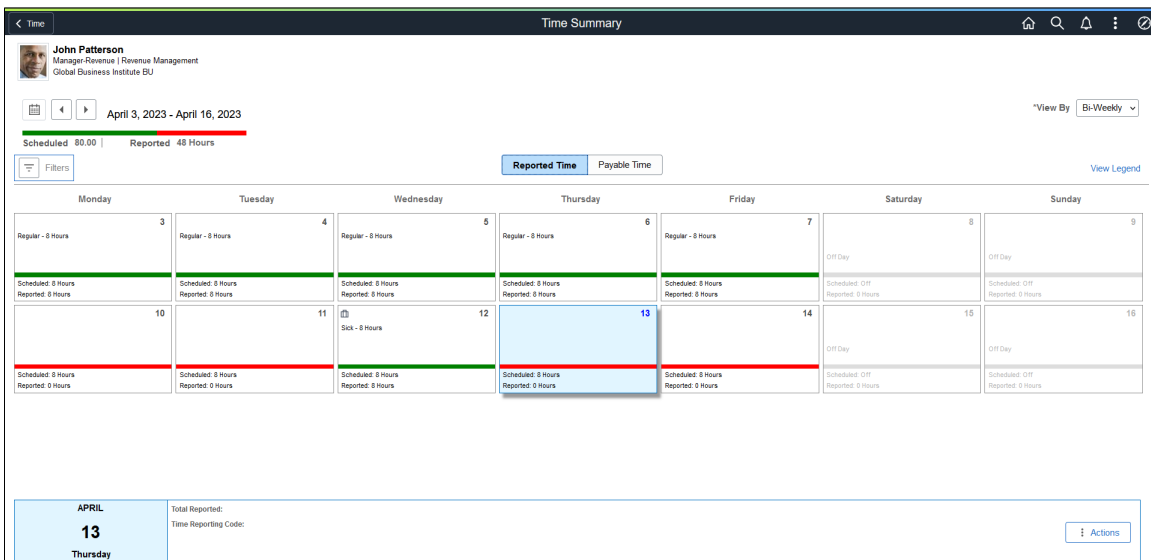

This example illustrates the fields and controls of Time Summary: Monthly page for an Elapsed Time Reporter.

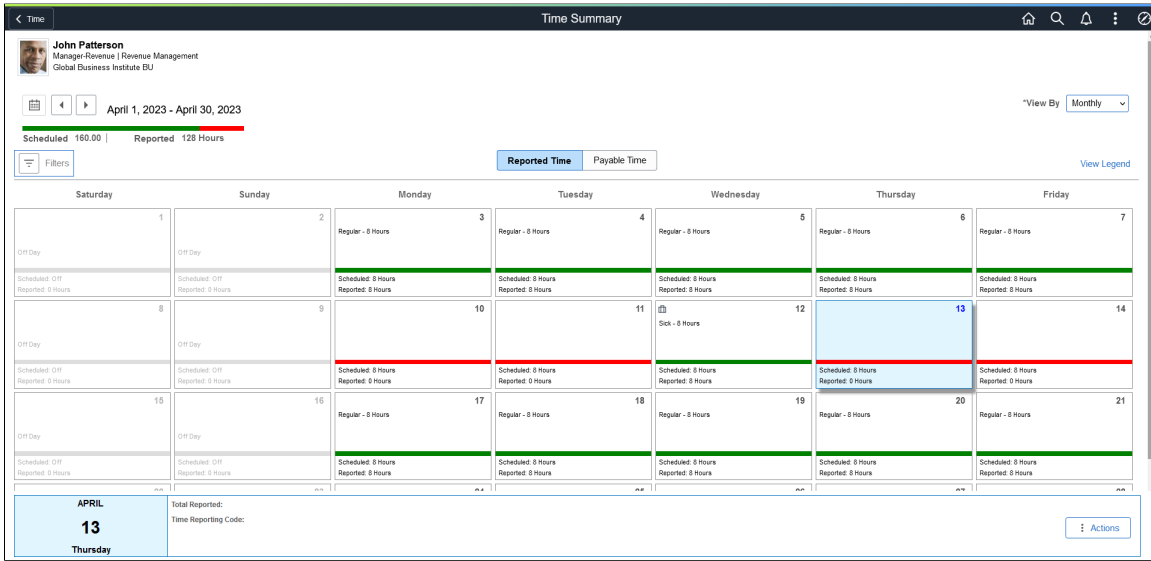

The Combo code and chartfields are available for selection using the filters. The time summary detail footer will display the respective combo code or chartfield values wherever available.

This example illustrates the fields and controls on the Reported Time Details in Time Summary Page. You can find definitions for the fields and controls later on this page.

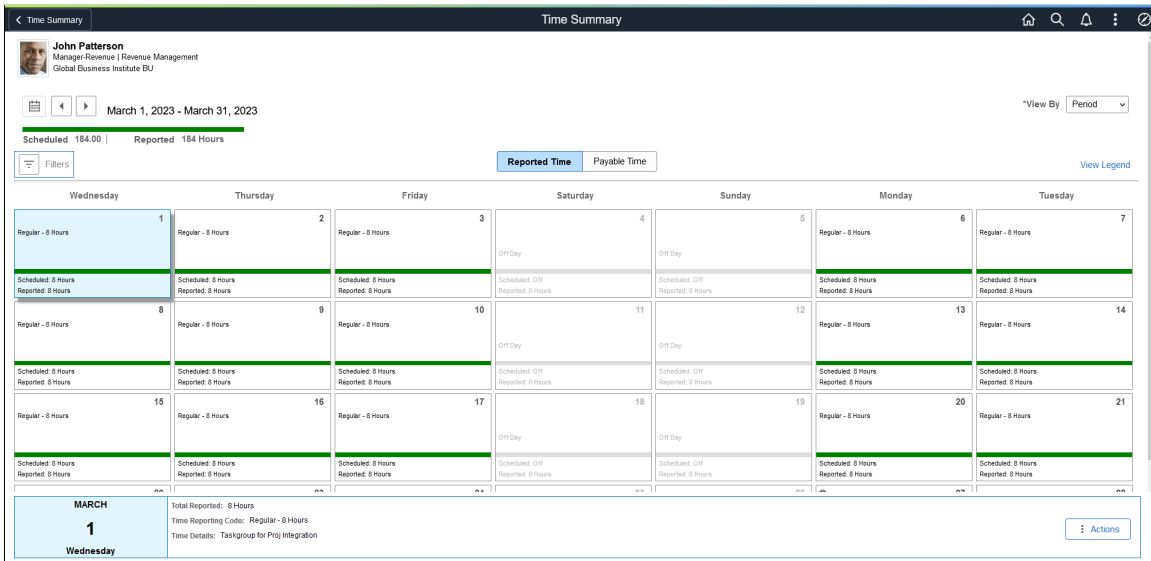

**Note:** All the time detail values for the selected day/(s) will be concatenated and displayed. This includes all the time and task values reported.

List the Combination Code as an option in the modal only if any time is reported for a combination code for the period in the context. In other case, it hides the combination code prompt.

Combo code and chartfields are available for selection using the filters. The time summary detail footer will display the respective combo code or chartfield values wherever available.

Select the filters icon to open the filter modal.

This example illustrates the fields and controls on the Time Summary\_Filter Modal. You can find definitions for the fields and controls later on this page.

The screenshot shows a modal window titled "Filter". It has a "Cancel" button on the top left and a "Done" button on the top right. The main area contains six filter fields: "TRC Type" (a dropdown menu), "Time Reporting Code" (a search field with a magnifying glass icon), "Reported Status" (a dropdown menu), "Taskgroup" (a search field with a magnifying glass icon), "Business Unit" (a search field with a magnifying glass icon), and "Combination Code" (a search field with a magnifying glass icon). At the bottom center, there is a "Clear Filters" button.

This example illustrates the fields and controls on the Time Summary Page with selected filter applied. You can find definitions for the fields and controls later on this page.

The screenshot shows the "Time Summary" page for John Patterson, Manager Revenue | Revenue Management, Global Business Institute BU. The date range is March 1, 2023 - March 31, 2023. The page shows a calendar grid with columns for days of the week and rows for dates. The grid displays "Regular - 8 Hours" for most days, with "Off Day" for weekends. A "Filters Applied" icon is highlighted in blue. The footer shows the "Selected Filter" as "KUTSKPROJ" and provides summary statistics: "Total Reported: 176 Hours", "Time Reporting Code: Regular - 176 Hours", and "Time Details: Taskgroup for Proj Integration".

**Note:** The selected filter will be shown as in the footer.

User can also use the Filters option to narrow down the results.

When filters are applied, the icon turns blue and filter results are highlighted as blue boxes in the Footer area. Clicking on any day will automatically clear the filters. A **Clear filters** link display at the top of

the screen to clear the filter. The time details for the selected day when individual day is selected is also displayed in the Footer area.

<b>Field or Control</b>	<b>Description</b>
<b>Edit Time</b>	Users can use the Edit Time button for the selected date to view or edit time for that day.  <b>Note:</b> Edit Time button is not displayed, when the filter is applied.

**Note:** The default View By is decided by the user preferences in time reporting.

This example illustrates the fields and controls of Time Summary: Weekly Page for Elapsed Time Reporter.

The screenshot displays the 'Time Summary' interface for user 'Liam Gray'. The main area shows a weekly grid for the period 'April 10, 2023 - April 16, 2023'. The grid columns are Monday (10), Tuesday (11), Wednesday (12), Thursday (13), Friday (14), Saturday (15), and Sunday (16). The Thursday cell is highlighted, showing '4,433.33 Hours' and 'Regular - 8 Hours'. Below the grid, a summary for 'APRIL 13 Thursday' is shown, indicating 'Total Reported: 12,433.33 Hours' and 'Time Reporting Code: 4,433.33 Hours, Regular - 8 Hours'. The interface also includes a 'View By' dropdown set to 'Period', a 'Filters' button, and an 'Actions' button in the footer.



This following example illustrates the Time Summary Navigation to Weekly Time page for a device.

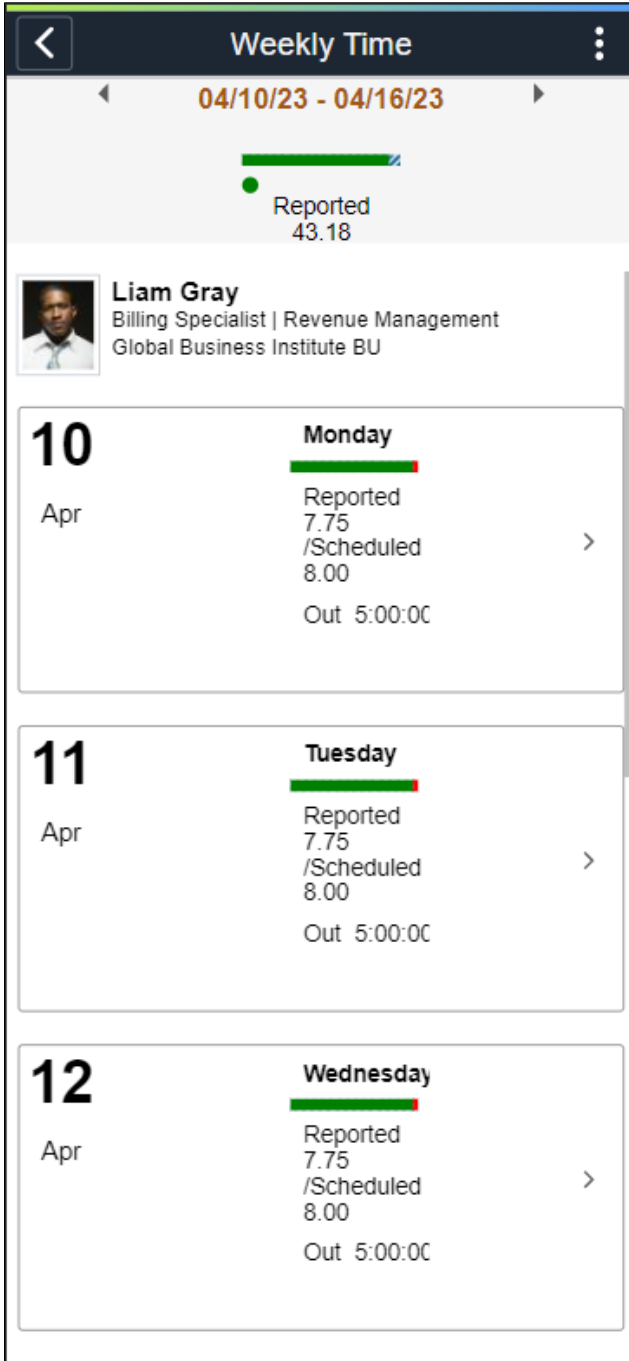

The Time Summary - Payable Time tab displays the payable time in different units.

You can also view total estimated gross amount in required currency.

The Time Summary page payable time tab displays the summary of payable time by TRC. The Payable Time Details tab displays the for each day, including the TRC for the time.

This example illustrates the Time Summary Payable Time Tab.

**Time Summary**

**John Patterson**  
Manager-Revenue

March 1, 2024 - March 31, 2024 View By: Period

Totals in USD | Estimated Gross: \$5,653.84

Filters Reported Time: Payable Time View Legend

Friday	Saturday	Sunday	Monday	Tuesday	Wednesday	Thursday
1 Regular - 8 Hours Estimated Gross: 269.23 USD Quantity: 8 Hours	2 Off Day Quantity: 0 Hours	3 Off Day Quantity: 0 Hours	4 Regular - 8 Hours Estimated Gross: 269.23 USD Quantity: 8 Hours	5 Regular - 8 Hours Estimated Gross: 269.23 USD Quantity: 8 Hours	6 Regular - 8 Hours Estimated Gross: 269.23 USD Quantity: 8 Hours	7 Regular - 8 Hours Estimated Gross: 269.23 USD Quantity: 8 Hours
8 Regular - 8 Hours Estimated Gross: 269.23 USD Quantity: 8 Hours	9 Off Day Quantity: 0 Hours	10 Off Day Quantity: 0 Hours	11 Regular - 8 Hours Estimated Gross: 269.23 USD Quantity: 8 Hours	12 Regular - 8 Hours Estimated Gross: 269.23 USD Quantity: 8 Hours	13 Regular - 8 Hours Estimated Gross: 269.23 USD Quantity: 8 Hours	14 Regular - 8 Hours Estimated Gross: 269.23 USD Quantity: 8 Hours
15 Regular - 8 Hours	16 Off Day	17 Off Day	18 Regular - 8 Hours	19 Regular - 8 Hours	20 Regular - 8 Hours	21 Regular - 8 Hours

**MARCH 12 Tuesday**  
 Quantity: 8 Hours  
 Time Reporting Code: Regular - 8 Hours  
 Payable Status: Estimated  
 Estimated Gross: 269.23 USD

You can also filter employee's payable time based on the payable time attributes.

Select the filters icon in the Time Summary - Payable Time page to open the filter modal.

This example illustrates the fields and controls on the Time Summary\_Filter Modal.

Cancel
**Filter**
Done

**TRC Type**

**Time Reporting Code**

**Payable Status**

**Taskgroup**

**Currency Code**

**Project ID**

**Activity ID**

Clear Filters

You can also filter payable time the same way you filter reported time.

## View Exceptions Tile

Select View Exceptions Tile (HC\_TL\_EMPL\_EXCEP\_FL\_GBL) to navigate to **View Exception** page.

Navigation:

Select Time Tile to access the View Exceptions tile.

This example illustrates the View Exceptions tile.



The Exceptions tile display the exception count as a number.

For Phone, the Enter Time Page is not available. You can use Report Time tile and Report Time Page for reporting time.



## View Exceptions Page

The View Exceptions (TL\_EMPL\_EXCEP\_FL) page is used to view the exceptions of time entries for an employee.

This example illustrates the fields and controls of View Exceptions page.

 A screenshot of a web browser window showing the "View Exceptions" page. The browser's address bar shows "View Exceptions". The page header includes a user profile for "John Patterson" (Manager, Revenue | Revenue Management, Global Business Institute BU). Below the header is a table of exceptions. Each row contains an error type, an "Explanation" link, a severity level, a date, and a right-pointing arrow icon.
 

Error Type	Explanation	Severity	Date	Action
Leave Time Error 2	<a href="#">Explanation</a>	High	07/15/2021	>
Leave Time Error 2	<a href="#">Explanation</a>	High	07/16/2021	>
Leave Time Error 2	<a href="#">Explanation</a>	High	08/31/2021	>
Leave Time Error 2	<a href="#">Explanation</a>	High	09/01/2021	>
Leave Time Error 2	<a href="#">Explanation</a>	High	10/28/2021	>
Leave Time Error 2	<a href="#">Explanation</a>	High	11/30/2021	>
Leave Time Error 2	<a href="#">Explanation</a>	High	12/01/2021	>

<b>Field or Control</b>	<b>Description</b>
	Sort the entries.
	Select to view the Enter Time page and highlight the day in context.

Select the Exception icon to view the options: Time Summary, View Exceptions and Payable Time Summary. This facility is available only for desktop users.

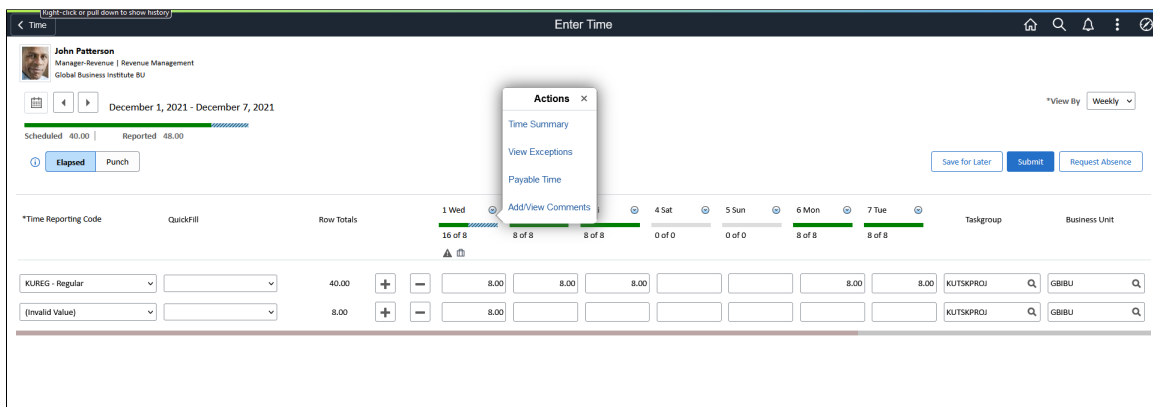

Navigation:

The related action will only be available for a reported exception.

This example illustrates the View Exceptions details for time reported for the day.

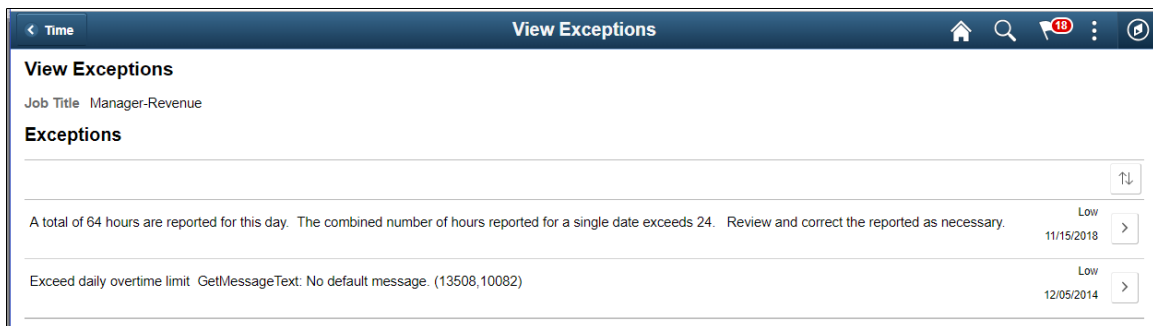

## Setup Quick-Fill Tile

Select Setup Quick-Fill Tile (HC\_TL\_QUICK\_FILL\_FLU\_GBL) to navigate to **Setup Quick-Fill** page.

Navigation:

Select Time tile available under Employee Self Service Home page to access the Tile Collections. You can select Setup Quick-Fill tile to open Setup Quick-Fill page.

This example illustrates the Setup Quick-Fill tile.

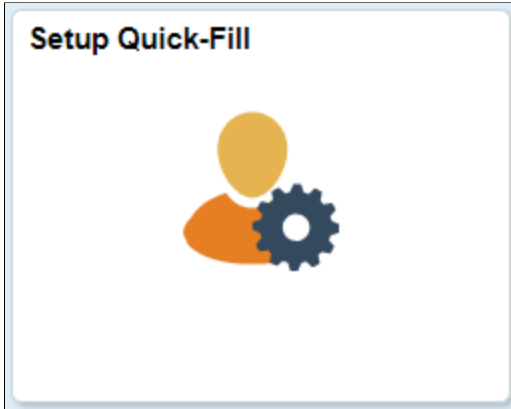

For Phone, the Enter Time page is not available. You can use Report Time tile and Report Time page for reporting time.

## Setup Quick-Fill Page

Use Setup Quick-Fill (TL\_QUICK\_FILL\_FLU) page to create a quick fill and view the existing saved quick fills. Using this page, you can select and update the quick fill and change the status to active or inactive as required.

Using Quick-Fill, you can populate the Time Details fields that are configured on a timesheet. This allows users to save combinations of values in the Time Details.

This example illustrates the fields and controls for Setup Quick-Fill page.



<b>Field or Control</b>	<b>Description</b>
	Select to add a new Quick-Fill. In the modal which opens, you can enter the time detail components that are part of that quick fill.
<b>Name</b>	Select quick fill name to view the quick fill parameters.

<b>Field or Control</b>	<b>Description</b>
<b>Details</b>	View the time details encapsulated in the quick fill. <hr/> <b>Note:</b> You cannot edit the name of the Quick-Fill. <hr/>
<b>Status</b>	Select to make the quick fill active or inactive.

**Note:** Quick-Fills are ordered by creation date descending by default. However the user can use the sort option to choose the columns to sort. You cannot delete the Quick-Fill once added.

This example illustrates the fields and controls on the Setup Quick-Fill page with ChartFields Selected.

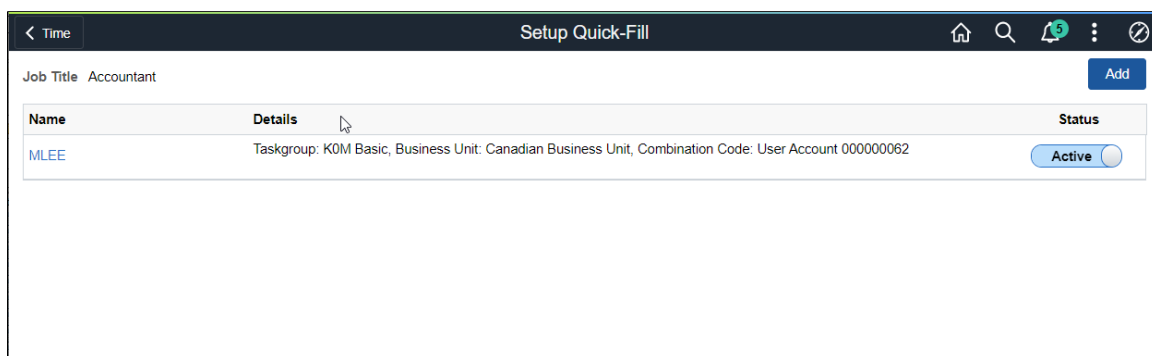

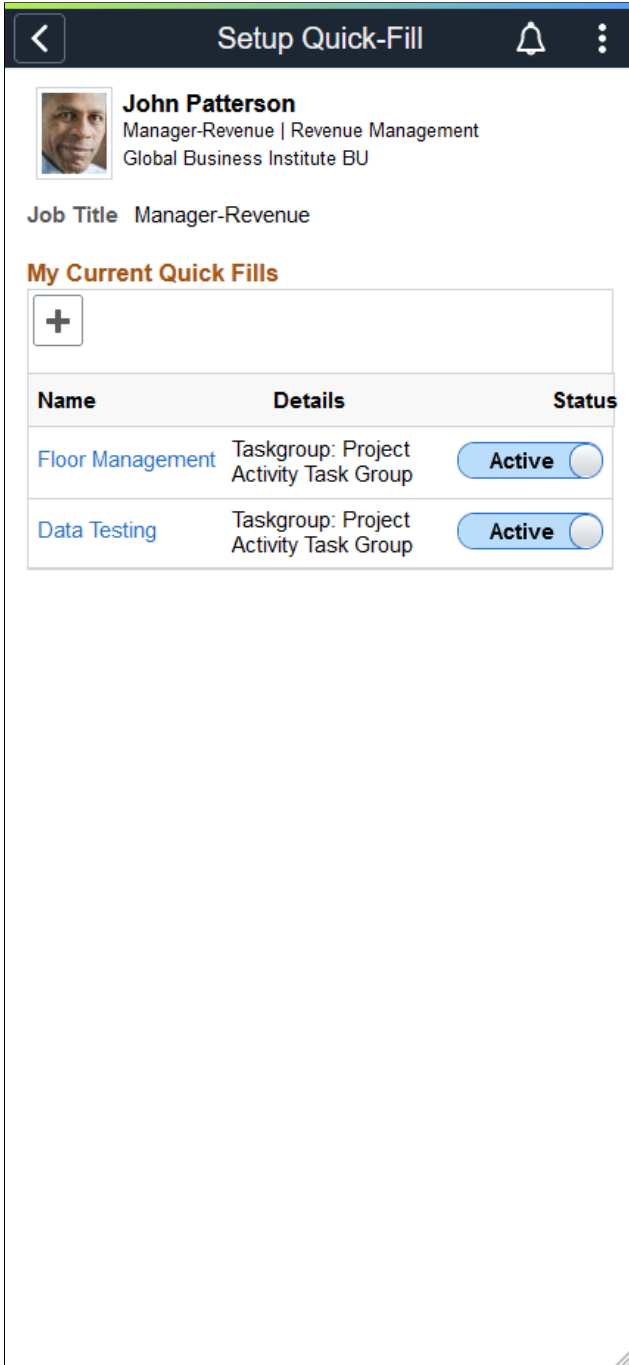

This example illustrates the fields and controls for Setup Quick-Fill page using a device.



**Note:** Inactive Quick-Fill cannot be seen in the Enter Time page unless some time is reported for the particular Quick-Fill.

<i>Field or Control</i>	<i>Description</i>
	View the summary of saved quick-fills which contains Name and status.

<b>Field or Control</b>	<b>Description</b>
	Displays the Quick-Fill name and details.
	Select to add a new quick-fill.

This example illustrates the files and controls for Quick-Fill modal window.

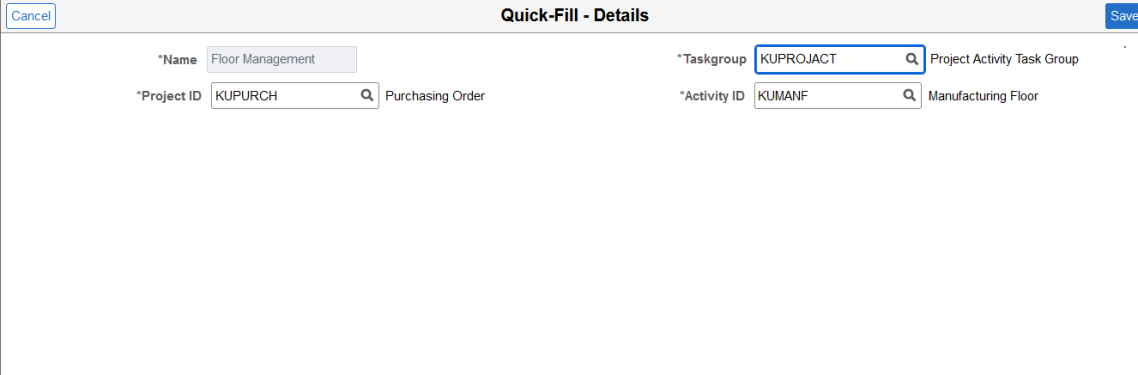

Use Template Type, Taskgroup, Project ID, Activity ID, Location, Business Unit, Customer, Product, Locality, Currency Code, Combo Codes, Comp Rate Code, User Fields, Rule Element, Time zone, Country, State, Locality, Billable Indicator, Task Template for filling the quick fill details.

Use **Save** to save the quick fill and **Cancel** to go back to the Setup Quick-Fill page.



This example illustrates the fields and controls on the Setup Quick-Fill Details page.

The screenshot shows the 'Setup Quick-Fill' page with a modal window titled 'Quick-Fill - Details'. The modal contains the following fields:

- Name: MLEE
- Taskgroup: KOMBASIC
- Company: [Searchable]
- Business Unit: CFABU (Canadian Business Unit)
- HR Department: [Searchable]
- Job Code: [Searchable]
- Position Number: [Searchable]
- Product: [Searchable]
- User Field 1-5: [Searchable]
- Combination Code: 000000062 (User Account 000000062)

## Report Time Details Page

Select already reported time to view and update the time details of the time reported.



This example illustrates the fields and controls of Report Time Details page.

The screenshot shows the 'Report Time Details' page with the following fields:

- Date: 05/14/2018
- \*Time Reporting Code: Regular
- Quantity: 8.00 Hours
- Quick Fill: [Dropdown]
- Time Details**
  - \*Taskgroup: KOMPROJ (KOM Projects)
  - Country: USA (United States)
  - State: CA (California)
  - Locality: 67000 (SAN FRANCISCO ER TAX)
  - Business Unit PC: EGV03 (PSU Medical Center)
  - Project ID: GL-0003
  - Activity ID: ACTIV1
  - Resource Type: COST (Direct cost)
  - Resource Category: ARCH
  - Resource Sub-Category: MNTOR

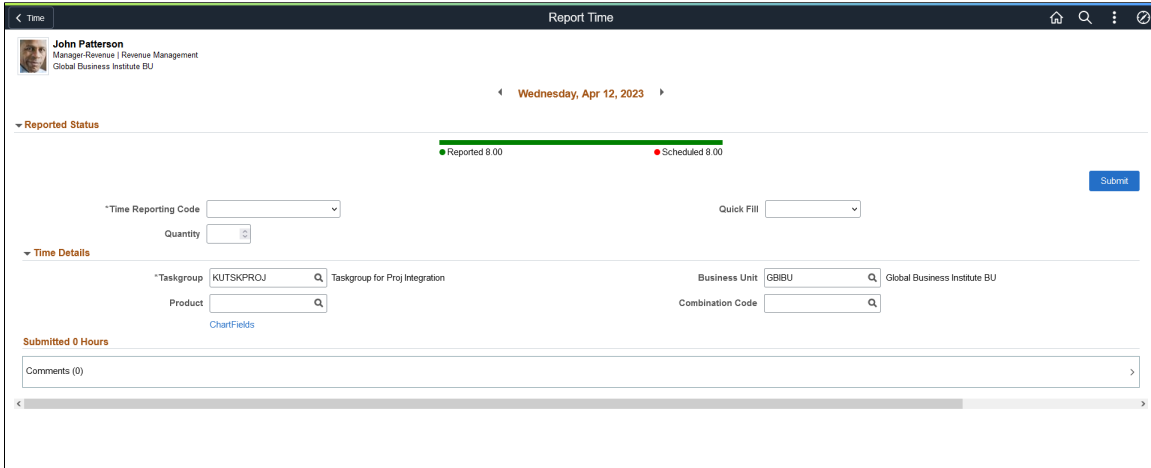
This example illustrates the fields and controls on the Report Time Details with ChartFields.



<b>Field or Control</b>	<b>Description</b>
	Cancel to go back to Report Time Page.
	Select to submit the updates for Reported Time details.

The following video gives an overview of ChartFields in Time and Labor:

Video: [Image Highlights, PeopleSoft HCM Update Image 35: Fluid ChartFields.](#)

## Weekly Time Tile

Select Weekly Time (HC\_TL\_PRE\_POP\_ELP\_FL\_GBL) tile to navigate to **Weekly Time Entry** page.

Navigation:

Select Time tile available under Employee Self Service Home page to access the Tile Collections. You can select Weekly Time tile to open Weekly Time page.

This example illustrates the Weekly Time tile.

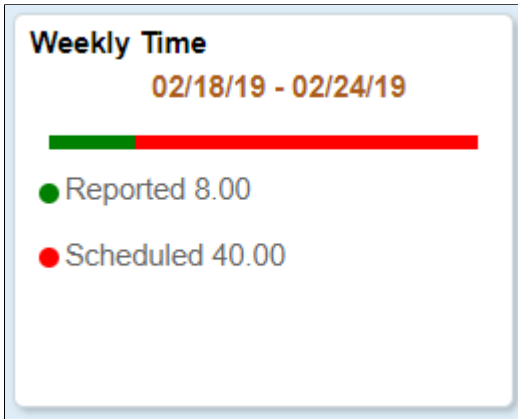

For Phone, the Enter Time Page is not available. You can use Report Time tile and Report Time Page for reporting time.

The Weekly Time tile displays the begin date and end date considering the user preferences. The status bar in the next line based on the users color preference configuration. The status bar displays the schedule to the reported ratio for the period displayed.

## Weekly Time Page

Select the Weekly Time tile on Actionable tile collections page.

This example illustrates the fields and controls of Weekly Time page for Employee Self Service.

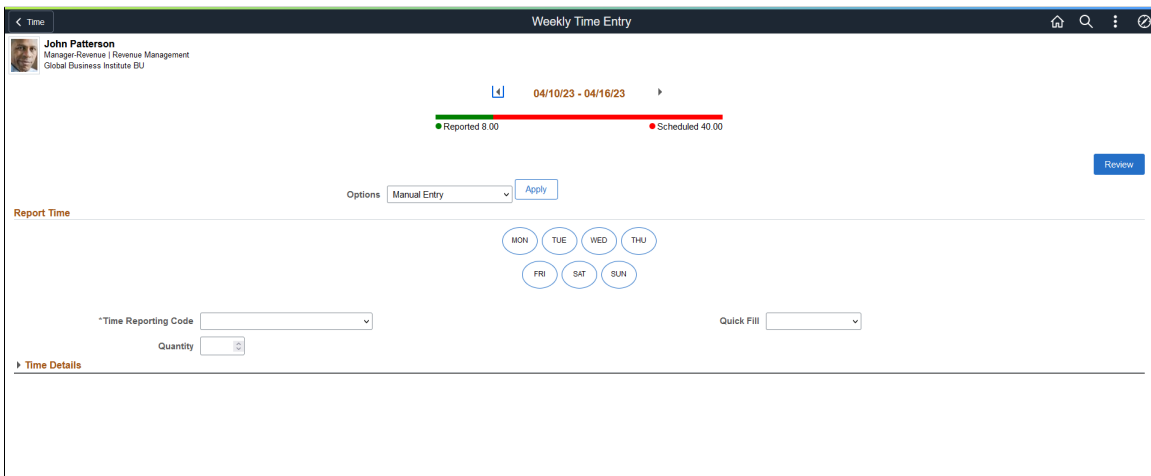

This table represents the honor of the user preferences and shows the desired option pre-populated in the weekly time entry page drop-down list.

<b>Time Pre-population Method</b>	<b>Options for Elapsed Users</b>	<b>Options for Punch Users</b>
Off/Task Values	<p><b>Default Selection:</b> Manual Entry</p> <p>Other Available Options:</p> <ul style="list-style-type: none"> <li>Apply Schedule</li> <li>Copy form previous week</li> </ul>	<p>Apply Schedule</p> <p>Copy form previous week</p>
Prior Period	<p><b>Default Selection:</b> Copy form previous week</p> <p>Other Available Options: Manual Entry</p>	Copy form previous week
Schedule	<p><b>Default Selection:</b> Apply Schedule</p> <p>Other Available Options: Manual Entry</p>	Apply Schedule

**Note:** The time pre-population options including start day of the week will be honored for custom time periods of the type *weekly*.  
 The first day of the week under **Select Days** comes from the [User Preferences Page](#).

This example illustrates the fields and controls on the Weekly Time Entry Page with ChartFields. You can find definitions for the fields and controls later on this page.

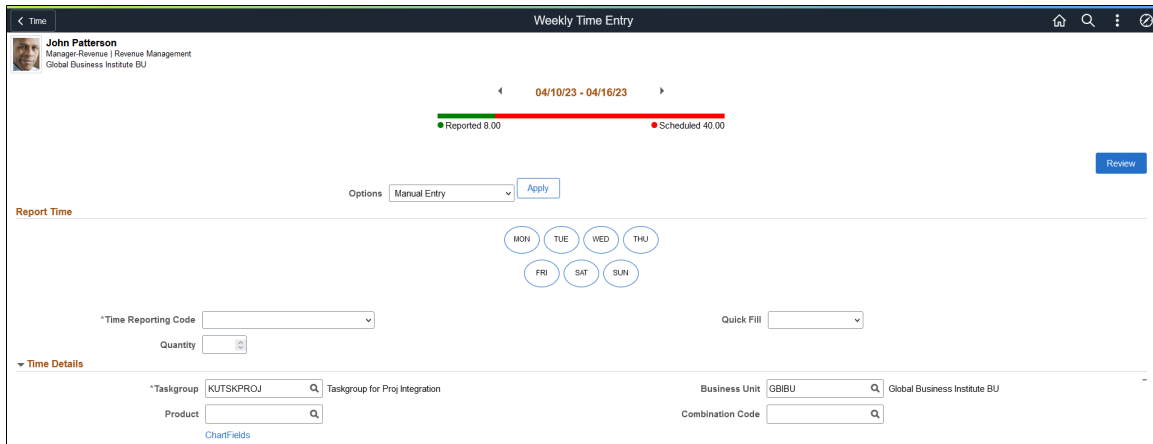

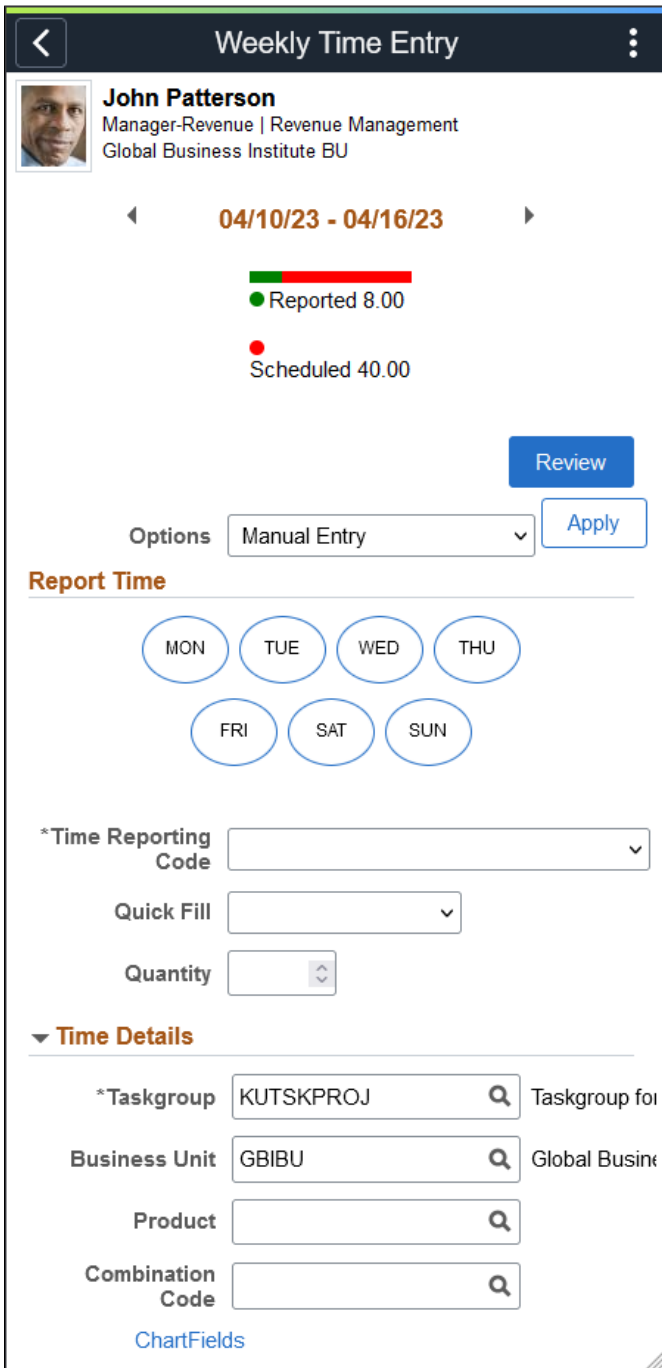

This example illustrates the fields and controls of Weekly Time page for Employee Self Service using a smartphone.



The user can do three types of time entries using the options:

- Apply Schedule
- Copy From Previous Week
- Manual Entry

<b>Field or Control</b>	<b>Description</b>
 and 	Icons that control the date ranges. Use the icons to navigate to a different week.
	Go to the reported time for a day by tapping the icon corresponding to that day.
<b>Select Days</b>	Select more than one day icons to report time for more than one days.

---

**Note:** Whenever there is time reported already for the given week, the page shows only manual entry.

---

## (Smartphone) Weekly Time Review Page

Employee can use Weekly Time Review Page (TL\_WEEKLY\_COPY\_FL) to review and submit the reported weekly time.

An employer can review the weekly time reported for a week for a job by navigating to weekly time Review page. The employee can also tap on the reported time row to navigate to the Report Time page and update existing time for that day.

This example illustrates the fields and controls of the Review Weekly Time Page using smartphone.

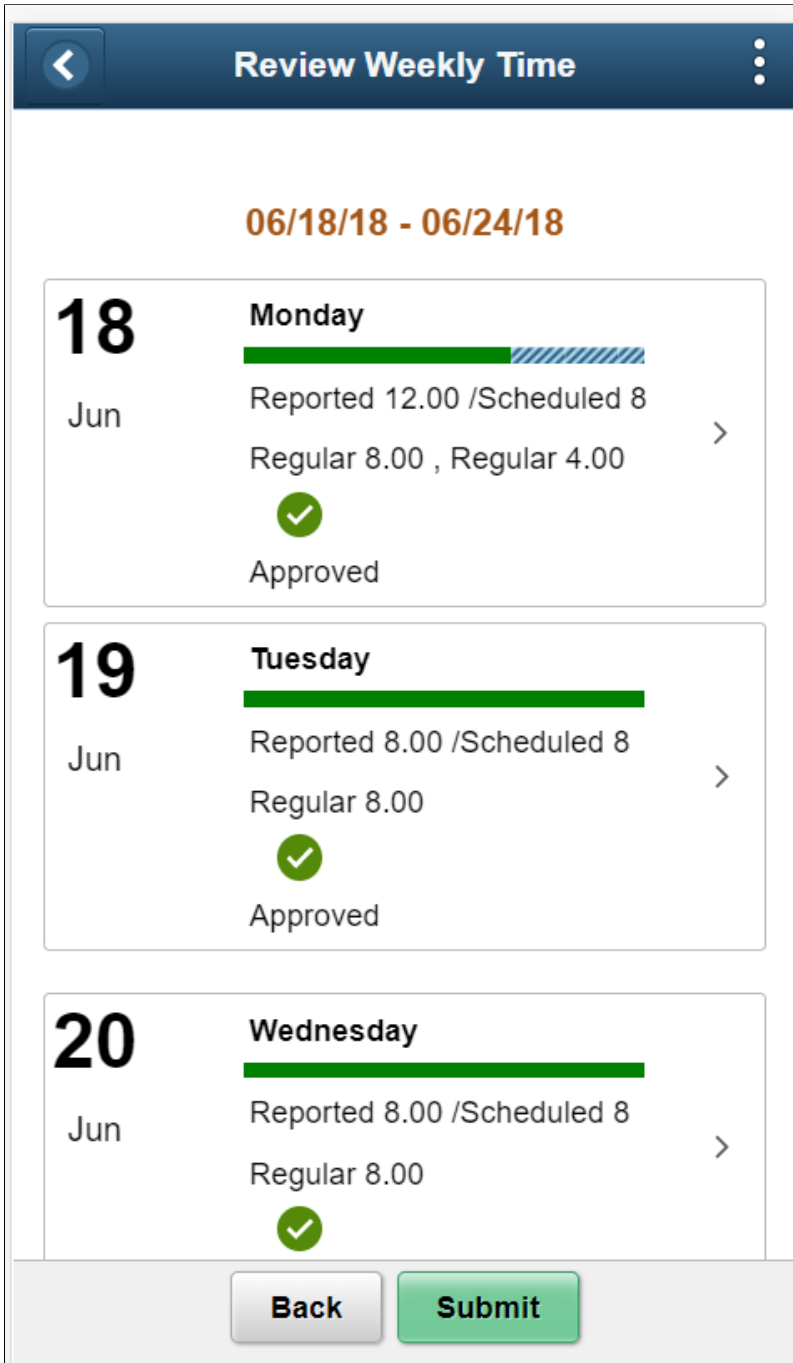

<i>Field or Control</i>	<i>Description</i>
	Enter to submit time after reviewing the time entries for a week.

## Weekly Time Summary Tile

Select Weekly Time Summary Tile (HC\_TL\_WEEKLY\_TIME\_FLU\_GBL) to navigate to **Weekly Time Summary** page.

Navigation:

Select Weekly Time Summary Tile to access the Weekly Time Summary page.

This example illustrates the Weekly Time Summary tile.

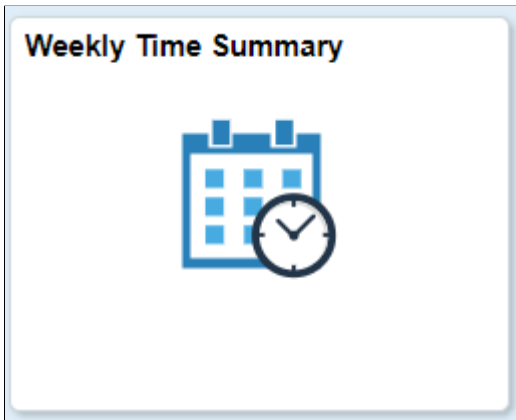

For Phone, the Enter Time Page is not available. You can use Report Time tile and Report Time Page for reporting time.

## Weekly Time Summary Page

Employee can use Weekly Time (TL\_WEEK\_TIME\_FLU) page to view the time reported for the entire week, and then navigate to the report time page for a particular day by selecting that days time.

This example illustrates the fields and controls of Weekly Time Summary page for employees.

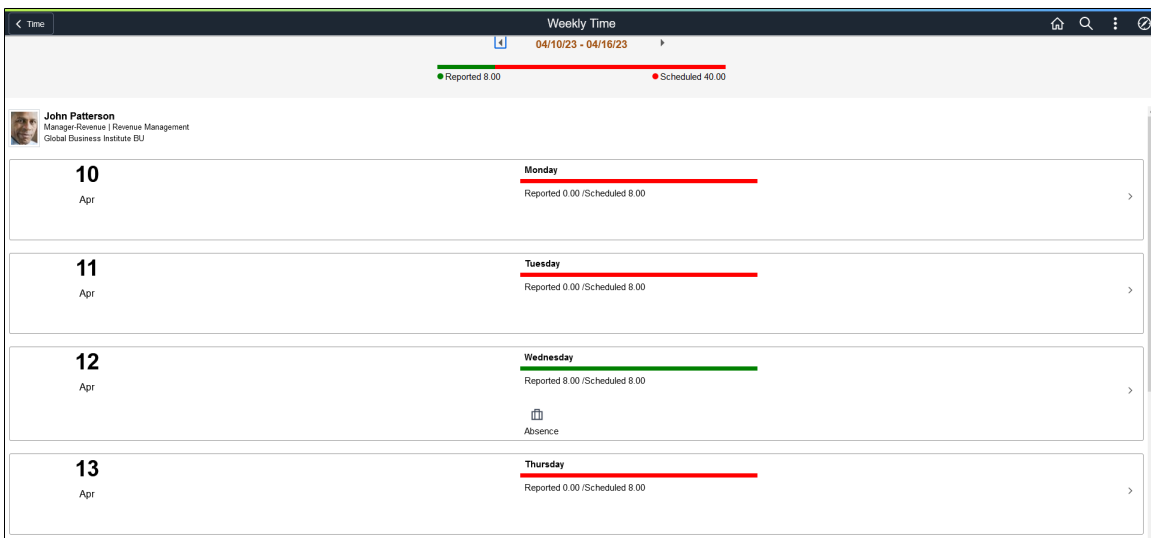



## Report Leave Tile

Select the Report Leave (HC\_TL\_RPT\_TIME\_FLU\_GBL\_2) tile to navigate to the **Report Leave** page.

Navigation:

Select the Report Leave tile to access the Report Leave page.

This example illustrates the Report Leave tile.

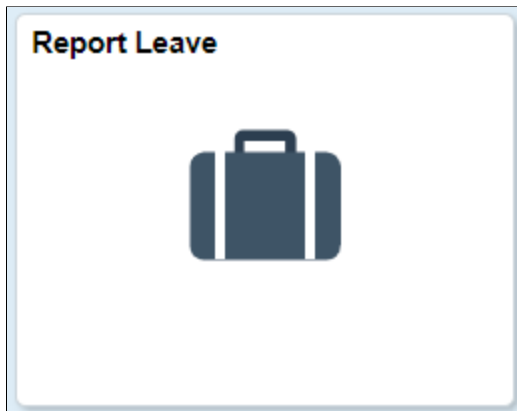

On selecting the Report Leave tile, opens the [Report Time Page for Elapsed Time Reporter](#), using which you can request a leave.

## Payable Time Tile

Select Payable Time (HC\_TL\_TIME\_SUM\_FLU\_GBL) tile to navigate to **Payable Time** page.

Navigation:

Select Payable Time Tile to access the Payable Time page.

This example illustrates the Payable Time tile.

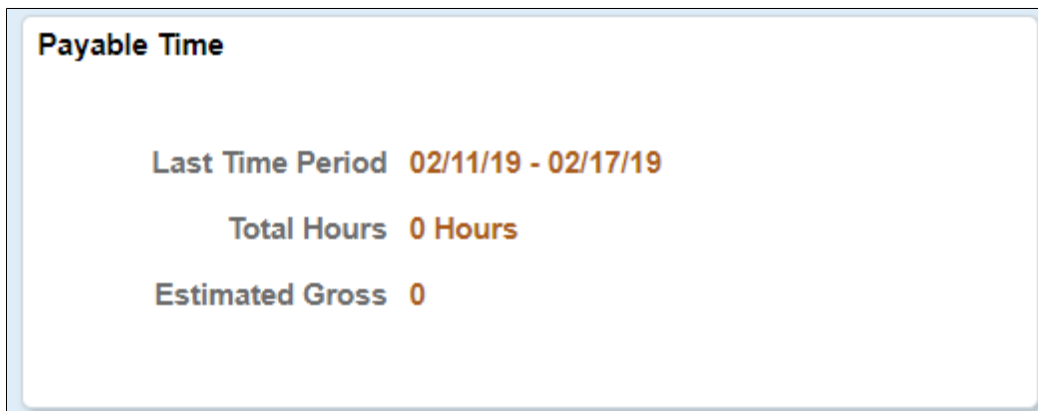

The Payable Time tile details Include Pay Period, Total Hours and Estimated Gross. The Pay Period refers to the last pay period that was paid for the employee. The Estimated Gross is controlled on the basis of configuration.

For Phone, the Enter Time Page is not available. You can use Report Time tile and Report Time Page for reporting time.

## Payable Time Page

Employee can use Payable Time page (TL\_PAYBTIME\_FLU) to report his vacation, sick and other leave types as well as compensatory time as punch reporter.

This example illustrates the fields and controls of Payable Time page for employees.

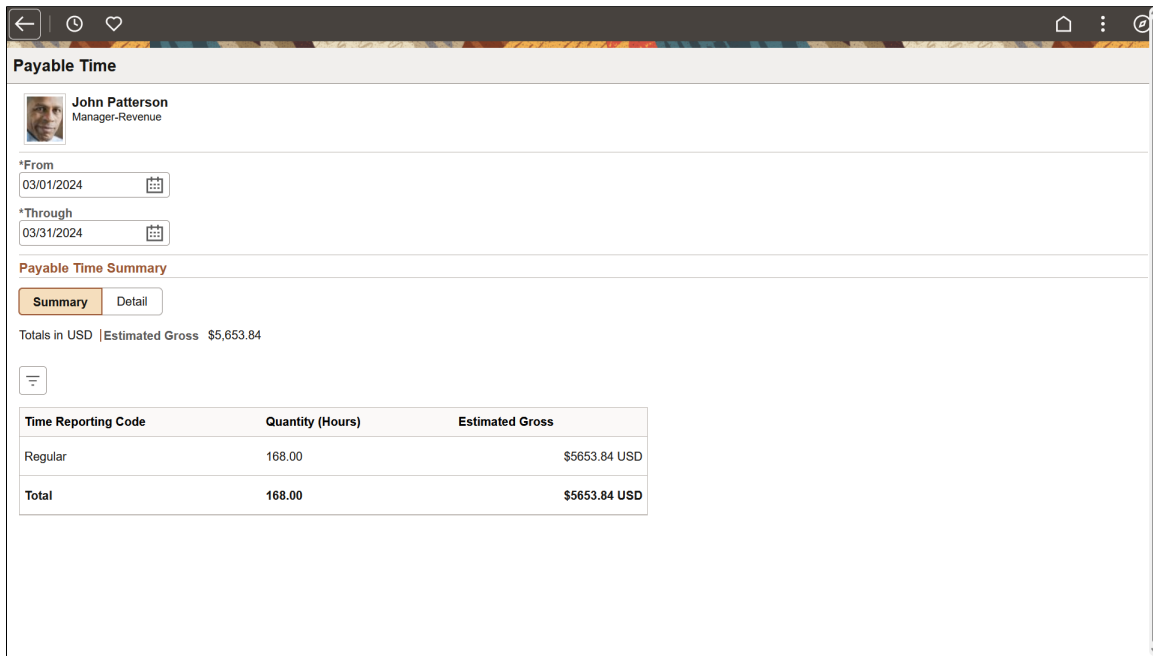

<i>Field or Control</i>	<i>Description</i>
<b>Payable Time Summary</b>	Summarizes the payable time with TRC Types of Units, Hours and Amount.

**Note:** The Payable Time Page is for the case when the relevant Workgroup setting for Payable Time Range field is set to **Date Range**. The page layout will change according to **Pay Period** or **Time Period** settings.

## Leave / Comp Time Tile

Select Leave / Comp Time Tile (HC\_TL\_TIME\_SUM\_FLU\_GBL) to navigate to **Leave Balances** page.

Navigation:

Select Leave Balances Tile to access the Leave Balances page.

The following provides an overview of the Leave / Comp Time Tile:

Video: [Image Highlights, PeopleSoft HCM Update Image 31: Leave and Compensation Balance.](#)

This example illustrates the Leave / Comp Time tile.

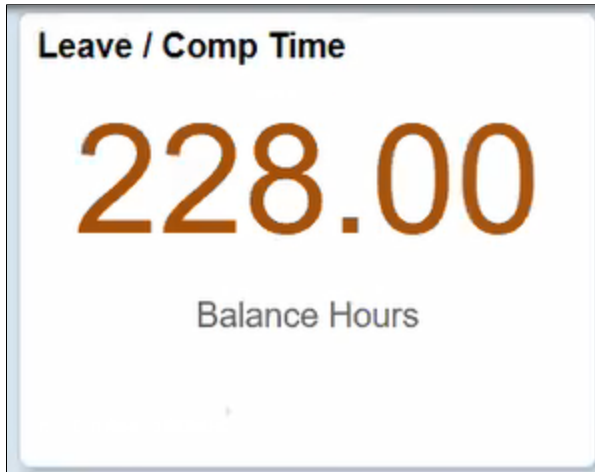

## Leave / Comp Time Page

Select the Leave / Comp Time tile to view the Leave / Comp Time details page.

This example illustrates the fields and controls on the Leave / Comp Time details page.

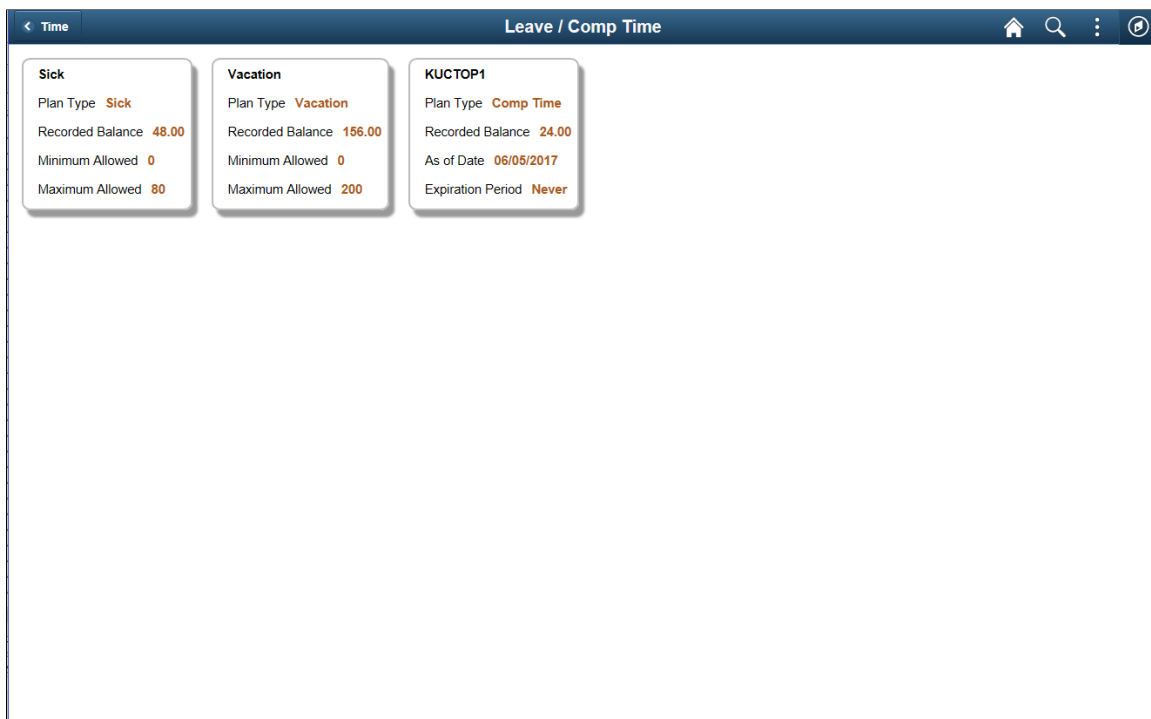

Leave and Comp Time balances are arranged in the card format with details upfront.

## Leave Balances History page

This example illustrates the fields and controls on the Leave Balances History page.

<i>Field or Control</i>	<i>Description</i>
<b>Return to Leave Balances</b>	Select to return back to Leave Balances page.

## Using PeopleSoft Fluid User Interface for Time Management as a Manager

The Managers can use the PeopleSoft Fluid User Interface to view team time, manage exceptions and to review employee time reporting locations.

Select the **Team Time** tile on the Manager Self Service home page to access a list of PeopleSoft Time and Labor, and PeopleSoft Absence Management manager self-service tasks that you can perform. The tasks listed are based on the applications that are installed and on the security access of the logged in user.

Video: [Time and Labor Manager Self Services Pages Online Help Video](#)







## Related Links



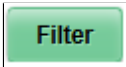
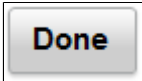

“Understanding PeopleSoft Fluid User Interface Homepages” (Application Fundamentals)

“Using the Manager Self-Service Homepage” (Application Fundamentals)

## Common Elements in Team Time Manager Self Service

These page controls appear on all the time options in manager self service right panels.

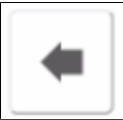
<i>Field or Control</i>	<i>Description</i>
Select Employee Page	Refer <a href="#">Select Employee Page</a> for more details.
	Select to open the filter modal using which you can define the filter criteria for the select employee panel.
	Select to sort the search results by name and title.
	Select to expand and collapse the navigation collection on the left panel.
	Click to access the list of employees after defining the filter criteria in Manager Search Options.  <b>Note:</b> The get employees button is available for Report Time, Weekly Time, Payable Time and Leave Balances component. This contains the pre populated values from manager search options if any. The fields that will be displayed here can also be configured under manager search options
	Click to open the filters modal to enter the filter criteria.  <b>Note:</b> You can edit the criteria and further filter or remove the manager search options criteria.
	Select to return to Select Employees page after defining the filter criteria in the filters modal.
	Select to close the filters modal.

<b>Field or Control</b>	<b>Description</b>
	Select to reset the values which are already entered in the filters modal.
	Select to display the previous employee from the list of employees in the select employee page.
	Select to display the next employee from the list of employees in the select employee page.  <b>Note:</b> The previous and next button is disabled, if there are no previous or next employee in the select employee page list.
<b>Return to Select Employee link</b>	Select to go back to the list of employees received as the result of filter search.
	Click to go back to the previous employees details.
	Click to go the next employees details.

## Pages Used to Manage Time as a Manager Using the PeopleSoft Fluid User Interface

<b>Page Name</b>	<b>Definition Name</b>	<b>Usage</b>
<u>Team Time Tile</u>	HC_TL_START_NAV_FLU_MSS2_GBL (this is the cref for the tile)  TL_START_NAV_FLU (page for dynamic data)	Add the Team Time tile to the homepage access the Team Time navigation collection page.

<b>Page Name</b>	<b>Definition Name</b>	<b>Usage</b>
<u>Team Time Navigation Collection</u>	HC_TL_START_NAV_FLU_MSS2_GBL (this is the cref for the tile)	<p>Opens the Team Time application start page. From this page, the Manager can navigate to the different time options using Fluid User Interface. The left panel items when selected allows the manager to perform actions like review reported time, weekly time, payable time, and leave balances of the employees.</p> <hr/> <p><b>Note:</b> You can retain the employees' context when switching between different Time and Labor transactions within the navigation collection in Manager Self Service (MSS).</p>
<u>Team Time Direct Reports Tile</u>	HC_TL_START_NAV_FLU_MSS3_GBL	Use the Team Time Direct Reports tile to access the list of employees that the logged-in user will either directly or indirectly manage.
<u>Team Time Directs Collection</u>	HC_TL_START_NAV_FLU_MSS3_GBL (this is the cref for the tile)	<p>Opens the Team Time Directs application start page. From this page, the Manager can navigate to the different time options using Fluid User Interface. The left panel items, when selected, allows the manager to perform actions like review reported time, weekly time, payable time, and leave balances of the employees.</p> <hr/> <p><b>Note:</b> You can retain the employees' context when switching between different Time and Labor and Absence Management transactions within the navigation collection in Manager Self Service (MSS).</p>
<u>Select Employee Page</u>  <u>Report Time Select Employee Filters page</u>	TL_MSS_EMP_SEL_FLU  TL_EMPPRS_FILT_SCF  Enter Time Details for Punch Time Reporters: TL_PCH_TIME_FLU  Enter Time Details for Elapsed Time Reporters: TL_ELP_TIME_FLU	<p>Page to view the list of employees. This page is also used to view the employees according to the criteria defined in filter.</p> <hr/> <p>The default landing page is Enter Time page which is inside the Timesheet folder. On expanding the Timesheet Folder, you can view the Enter Time and Time Summary results.</p>

<b>Page Name</b>	<b>Definition Name</b>	<b>Usage</b>
Report Time page	Report time details for Punch time reporters: TL_WEB_CLOCK_FLU  Report Time details for Elapsed time reporters: TL_RPTD_ELP_FLU	Select to get the search result for Report Time according the defined filter criteria. Select any employee from the list to open the report time page for that employee.  Managers can navigate through the <b>Previous</b> and <b>Next</b> to go to employees in the search list.
<u>Weekly Time Entry page</u>	Weekly Time Entry details for Punch time reporter: TL_PRE_POP_PCH_FLU  Weekly Time Entry details for Elapsed time reporter: TL_PRE_POP_ELP_FLU	Select to get the search result for Weekly Time Entry according to the defined filter criteria.  Modify reported time or delete reported time for the employees according to the row level security or Time and Labor security.
<u>Weekly Time Summary page</u>	TL_WEEK_TIME_FLU	Select to get the search result for Weekly Time Summary according to the defined filter criteria. Select any employee from the search result to view the time reported for a week. The manager can also modify and report time per week.
<u>Payable Time (Select Employees) page</u>	TL_MSS_EMP_SEL_FLU	View and select the employees to review their payable time..
<u>Payable Time page</u>	TL_PAYBTIME_FLU	Review employees payable time details with duration and Time reporting code, payable hours, and estimated gross for the selected period.
<u>Leave / Comp Time page</u>	TL_COMPLEAVBAL_FLU	Select the employee using the filter and view the employees with the selected filter criteria. This page provides the summary of leave balances for those employees enrolled in Base Benefits leave plans.
<u>Attendance Violations page</u>	TL_ATTENDANCE_FL	This page provides the summary of violations for a selected period of start and end date. This page can also be accessed from punch time sheet via related actions. The related actions open as a new modal.



<b>Page Name</b>	<b>Definition Name</b>	<b>Usage</b>
<u>Manage Exceptions Page</u>	TL_MNG_EXCEP_NUI	View and resolve the exceptions using Fluid User Interface.  Displays all exceptions of the team at one place.
<u>Reporting Locations Page</u>	TL_MSS_EMP_MAP_FLU	To view the employee location when the employee has enabled the use of location services.
<u>Workforce Availability Page</u>	TL_EMP_PRES_FLU	To view detailed information about team members, including time entries, scheduled and reported time for each type of time reporters.
<u>Time and Labor Fluid WorkCenter Page</u>	TL_WC_RSLT_FL	Access frequently used work items for Time and Labor.

## Team Time Tile

Use the Team Time tile (HC\_TL\_START\_NAV\_FLU\_MSS2\_GBL) to access the Team Time navigation collection.

Navigation:

**Manager Self Service > Team Time**

This example illustrates the Team Time tile for desktop.



The Team Time tile also shows the total number of exceptions of time reporting.

A manager can add the tile through personalizing a system-delivered homepage or by creating a customized homepage.

## Team Time Navigation Collection

This Team Time start page is a navigation collection that enables the managers to access the frequently used Time and Labor management components from one location. The left panel of this page lists the components collected under 14 categories. This panel can be expanded or collapsed to view or hide the navigation collection.

- Timesheet Folder
- Report Time
- Weekly Time Entry
- Weekly Time Summary
- Payable Time
- Leave / Comp Time
- Manage Absence
- Cancel Absences
- View Requests
- Absence Balances
- Manage Exceptions
- Reporting Locations
- Workforce Availability
- Time and Labor WorkCenter

On selecting the left navigation collection, you can open the corresponding search pages on the right panel. Expanding Timesheet Folder opens Enter Time and Time Summary search pages on the right panel.

This example illustrates the Team Time page in a smartphone

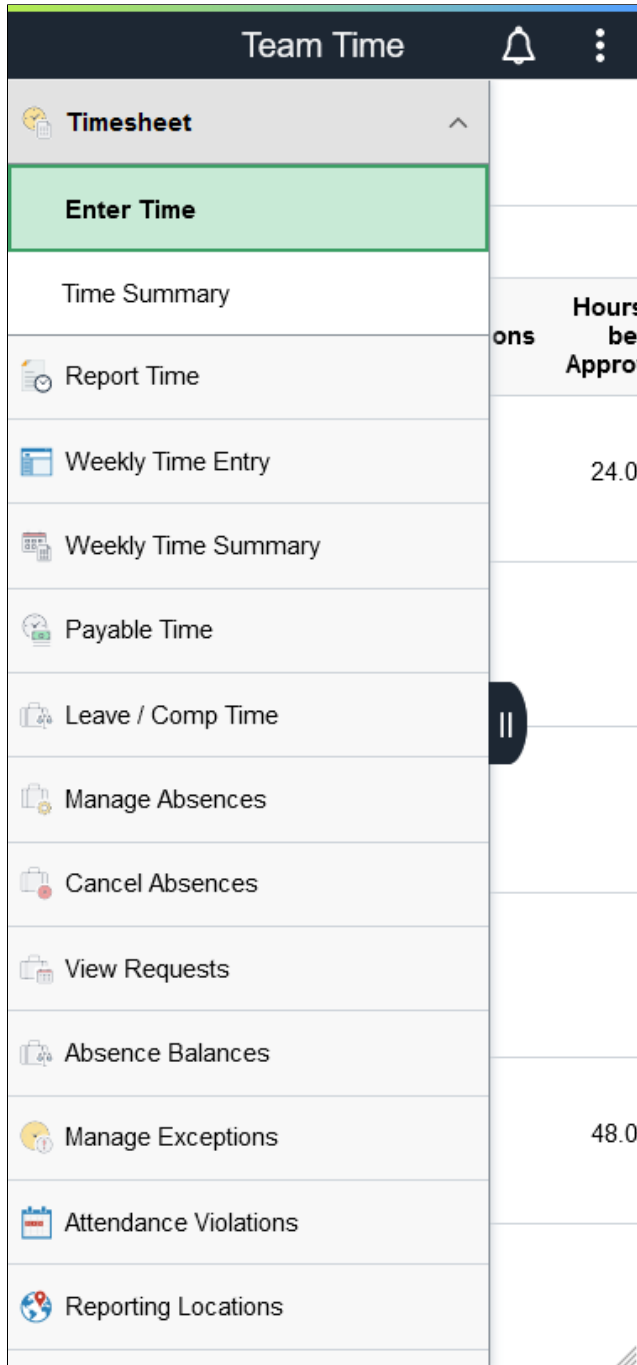

On selecting the listed items, the manager can navigate to different time options.

### Team Time Direct Reports Tile

Use the Team Time Direct Reports tile (HC\_TL\_START\_NAV\_FLU\_MSS3\_GBL) to access the Team Time Directs navigation collection page for the direct or indirect reports of the logged-in manager.

Navigation:

**Manager Self Service > Team Time Direct Reports**

This example illustrates the Team Time Direct Reports tile for desktop.



The Team Time Direct Reports tile displays the total number of exceptions in time reporting.

## Team Time Directs Collection

Team Time Directs is a navigation collection that enables the managers to access the frequently used Time and Labor and Absence management (if using the Peoplesoft Absence Management) components from one location. The left panel of this page lists the components collected under 10 categories. This panel can be expanded or collapsed to view or hide the navigation collection.

- Timesheet Folder
  - Enter Time
  - Time Summary
- Report Time
- Weekly Time Entry
- Weekly Time Summary
- Payable Time
- Leave / Comp Time
- Manage Absence
- Cancel Absences
- View Requests
- Absence Balances

On selecting the left navigation collection, you can open the corresponding search pages on the right panel.

**Note:** You can retain the employees' context when switching between all the Time and Labor and Absence Management transactions within the navigation collection. This avoids the selection of employee at each component level.

This example illustrates the Team Time Direct page in a smartphone.

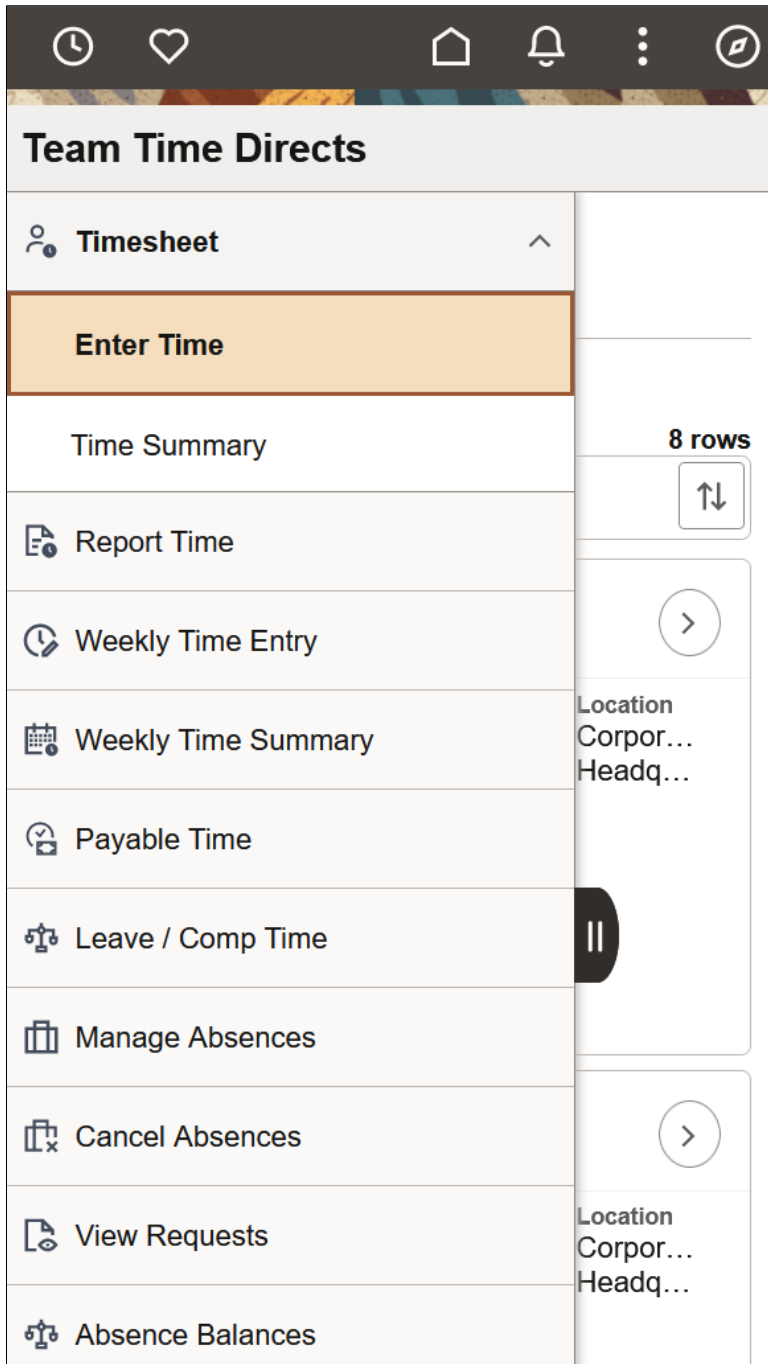

On selecting the listed items, the manager can navigate to a specific time reporter.

## Select Employee Page

Use the Select Employee (TL\_MSS\_EMP\_SEL\_FLU) page to view the employees according to the criteria defined in filter.

Video: [Image Highlights, PeopleSoft HCM Update Image 28: Manager Self Service Fluid Timesheet](#)

Navigation:

Select the **Team Time** tile on the Manager Self Service page or a homepage where the tile is added.

By default, the team time landing right panel is the select employee page. The right panel displays the filter options or the employee list.

The right panel displays the details for the components selected in the left panel.

**Note:** On setting up auto populate, the get employees and filter button don't appear. The results are displayed directly. The get employees button displays employees based on the Manager Search Options page criteria. Filter button will open the filter options with manager search options filter values defaulted. We can edit this and further filter or remove this by updating the manager search options criteria. You can retain the employees' context when switching between different Time and Labor transactions within the navigation collection in Manager Self Service (MSS). Only employee context is maintained and not date context. This means that if you make changes in any of the time transaction pages, for example Enter Time page, the changes will be retained if you navigate to another transaction like time summary.

The Select Employee on the right panel shows the number of Exceptions and Hours to be Approved information for each employee, if available.

The total number of approval hours and exceptions are updated based on the date selected in the As of Date field. The total hours and exceptions counts are as of the chosen date.

This example illustrates the fields and controls on the Enter Time\_Select Employee page

Employee ID	Name	Job Title	Status	Department	Location	Hours to be Approved
KU0020 - 0	Christelle Stevenson	Manager-Accounting Full/Part Full-Time	Active Type Employee	Accounts Receivable	Corporation Headquarters	0
KU0044 - 0	Daryl Reese	Financial Analyst Full/Part Full-Time	Active Type Employee	Corporate Accounting	Corporation Headquarters	0
KU0121 - 0	David Ho	Senior Financial Analyst Full/Part	Active Type	Financial Services	Corporation Headquarters	0

**Note:** The list of employees and the fields that are displayed in the search results page are controlled by your direct reports configuration, for more information, see the “Direct Reports Configuration Page” (Application Fundamentals).

This example illustrates the fields and controls on the Enter Time page from the Team Time Directs collection.

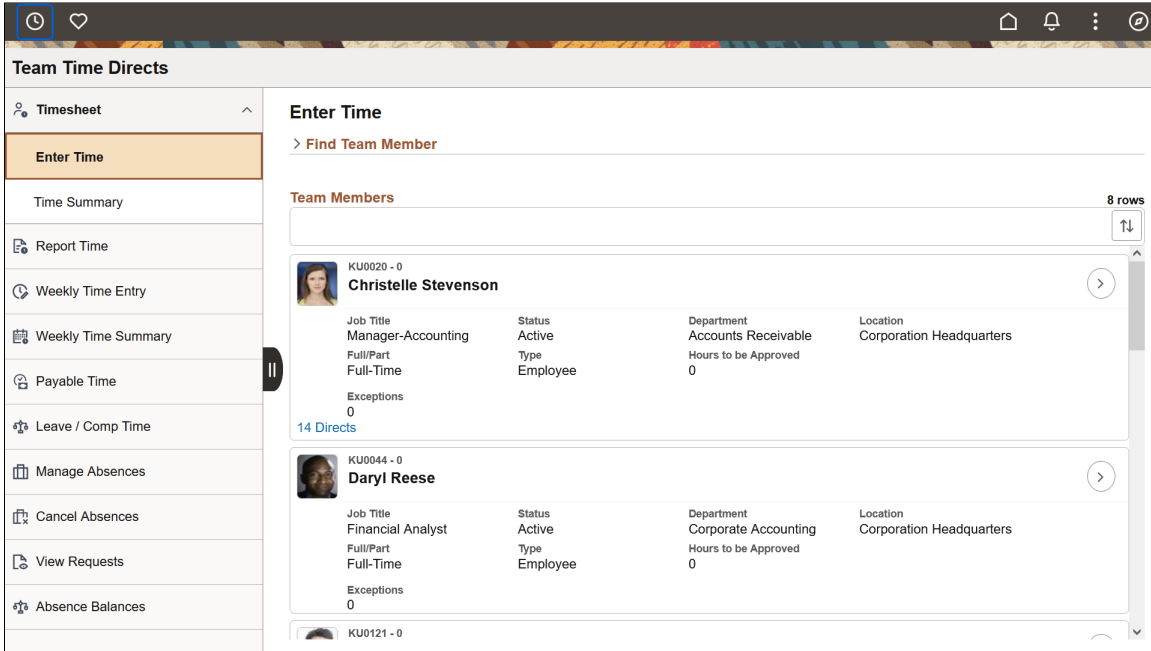

This example illustrates the fields and controls on the Find Team Member section of the Enter Time page in the Team Time Directs collection.

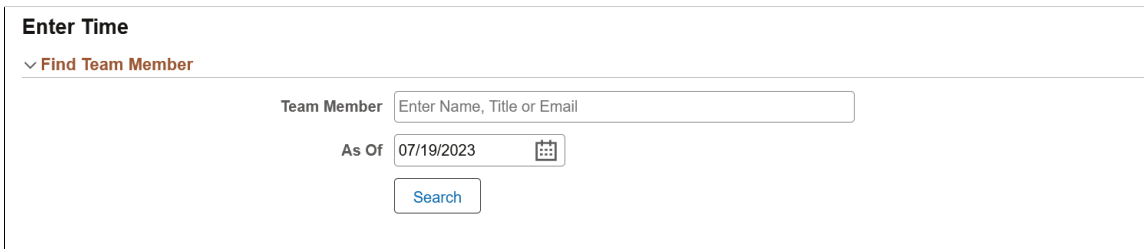

The manager can select one of the employee on the right panel to view the details.

This example illustrates the fields and controls of the Enter Time page of an Elapsed Time Reporter.

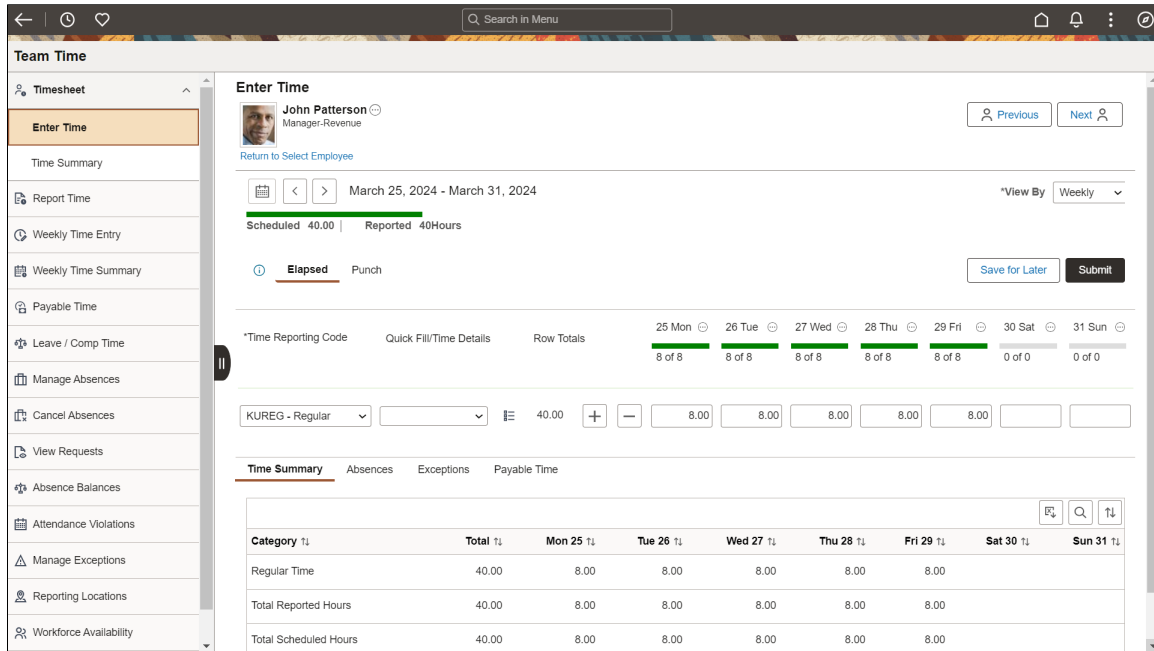

**Note:** The Time Summary, Absences, Exceptions, and Payable Time tabs are displayed based on Embedded Related Content feature. For details on Related Content feature, refer Understanding the PeopleSoft Related Content Framework in PeopleSoft PeopleTools Online Help.

The employee header displays the employee photo and up to three lines of information for a selected job. This information can be configured using the employee header configuration. For more information, see “(Fluid) Managing Employee Headers” (Application Fundamentals).

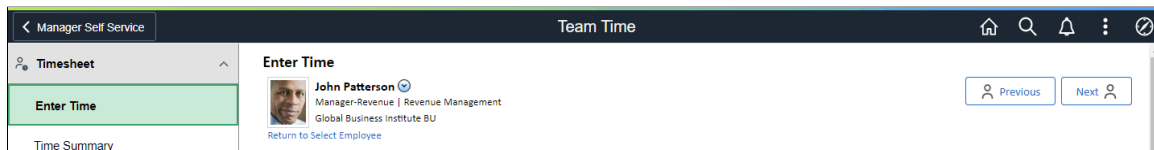

Example of an employee header in fluid self-service pages.













The configurable employee header appears for all fluid self-service and manager self-service Time and Labor pages. For employees with multiple active jobs, the **Select Another Job** link will be enabled that leads to a Change Job Selection window.



<b>Field or Control</b>	<b>Description</b>
<b>Employee Header</b>	Job information of the user is displayed based on the Employee Header configuration. The <b>Select Another Job</b> link will be enabled for employees with multiple active jobs to switch between them as required.



<b>Field or Control</b>	<b>Description</b>
<b>Period Header</b>	<p>The period header lets user select the time period for which they will be reporting or viewing time.</p> <p>The default period for the user will be available for selection and is displayed below the dates. Users can control the time period defaults for time entry using the configuration under user preferences.</p> <p>Period Summary totals are displayed under the dates. If there is no schedule configured then the scheduled total will not display.</p> <p>All action buttons on the period header will perform the action for the period selected. If the user is viewing time for time period greater than a weeks time, then the time will be submitted for the entire period.</p> <p>The green or red banner represents the reported time against scheduled time.</p>
	<p>Navigate to previous time period.</p>
	<p>Navigate to future time period.</p>
<b>*View By</b>	<p>Enables the users to view the time reported by monthly, weekly, bi-weekly or by the period defined either on the time reporter's profile or on the Workgroup definition. By default, the view by period option displays the monthly data.</p> <p>Selecting the view by period option enables a scroll bar below the reported time to view the entire data for the date span. The columns with time entries are only moved upon scrolling and the other columns remain frozen.</p>
<b>Weekly Banner, Scheduled and Reported</b>	<p>These are applicable only for elapsed reporters using desktop.</p> <p>Weekly summary will be displayed in the weekly banner. The summary will show the scheduled total and reported total for the week in view.</p> <p>If the selected time period for the user is greater than weekly, the weekly pagination (green banner) will be displayed.</p> <p>Users can enter time for one week at a time and navigate between weeks using the previous and next button on the weekly banner.</p> <hr/> <p><b>Note:</b> If there is no schedule configured then the scheduled total will not be displayed.</p> <hr/>

<b>Field or Control</b>	<b>Description</b>
	<p>Users can click on the Calendar icon to select a date from the calendar to view the weekly data starting from the selected date.</p>
	<p>Select to view the previous employee listed in enter time search page.</p>
	<p>Select to view the next employee listed in the enter time search page.</p>
	<p>Select to keep the entry as draft.</p> <hr/> <p><b>Note:</b> The time details that can be entered will depend on the configuration of the time reporting template used by the time reporter.</p>
	<p>Submit the timesheet entries.</p>
<p><b>Time Reporting Code/ Time Details</b></p>	<p>Select the Time Reporting Code (TRC).</p> <hr/> <p><b>Note:</b> Once the user selects the TRC and performs another action like navigating to the next or previous weeks or selecting apply rules, save for later button, then the row is locked for the TRC selected. The TRC selector will be grayed out and the time details will change to read-only. This is done to preserve data integrity when the user leaves the page.</p> <hr/> <p>The selected TRC will be available for the entire period spanning weeks in-case of bi-weekly or other periods and users can report the quantity against the same TRC and time details.</p>
	<p>The Time details for different entries.</p> <p>This icon will be hidden and the time detail values are expanded in the timesheet pages if the option of <b>Expand Time Details on Timesheet</b> is selected in Time and Installation page.</p> <p>For more details, see <a href="#">Time and Labor Installation Page</a>.</p>
<p><b>Row Totals</b></p>	<p>The row total is displayed against each row for the selected period.</p>

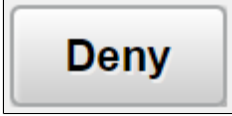
<b>Field or Control</b>	<b>Description</b>
	<p>Add a new row.</p>
	<p>Delete the entry which is not required.</p>
<p><b>Days</b></p>	<p>Days of the week with scheduled and reported time is displayed. You can click on the Status bar and navigate to the requested page, while preserving the context of the date from which the action was performed.</p> <hr/> <p><b>Note:</b> Icons will appear in the boxes if the user has an exception or saved time. When approvals are configured the approval status for the time reported can be viewed here.</p> <hr/> <p>The visibility of the status bar can be controlled on the Time and Labor Installation. Administrators can set the options like hide/show and the default colors and patters that will be available for their user population. Individual users can override the color preferences using the user fluid preferences. This status bar will not be automatically displayed if there is no schedule configured for the user.</p> <p>The green or red banner represents the reported time against scheduled time.</p> <hr/> <p><b>Note:</b> Current date is highlighted in blue.</p>
	<p>Enables users to access related actions like Time Summary, Payable Time and Add/View Comments. Enter comments for the entries.</p>
	<p>Comments have been already entered for the time entry.</p>
	<p>Select this link to view the Legend Page and review the patterns.</p> <hr/> <p><b>Note:</b> Any message or warning for the time reporter will appear in the screen below the View Legend link. On a Mobile device, the View Legend link re-directs you to the Weekly Time page.</p>
<p><b>Elapsed/Punch button</b></p>	<p>Select to switch the timesheet to either an elapsed time or a punch timesheet. This option may not be available, based on the configuration specified on the Time and Labor Installation page.</p>

<b>Field or Control</b>	<b>Description</b>
<b>Unapproved Time</b>	Displays the unapproved hours which requires approval from the respective manager.
	Check the time to approve and select approve button for time approval.
	Check the time and select deny button for rejecting time.
	Check the time and select push back button for sending the time back for checking.
<b>Time Summary tab</b>	Click this tab to show the Total Reported Hours values to obtain a summary of reported hours.
<b>Absences tab</b>	<p>This tab displays the absence balance details.</p> <p>Click this tab to display the Absence Events grid and Absence Balance grid and add absence information. Depending on the setup of Absence Management, you may be enabled to report, save, submit, and approve or deny (managers only) absence events within the range of the Timesheet dates.</p> <hr/> <p><b>Note:</b> This tab is displayed only if the Time and Labor system is integrated with Global Payroll or Absence Management.</p> <hr/> <p>Balance information can include sick or vacation balances, and your absence entitlement balance if the time reporter is active in the Absence Management system.</p>
<b>Exceptions tab</b>	Click this tab to review all the exceptions for the employee in the context. Employees are unable to allow exceptions; this ability is restricted to managers.
<b>Payable Time tab</b>	Click this tab to review details of payable time.
<b>Leave/Compensatory Time tab</b>	Click this tab to view leave and compensatory time balances as of the date specified for the timesheet. This balance may be positive or negative, depending on how the plan is set up and what has been reported.

<b>Field or Control</b>	<b>Description</b>
<b>Approvals tab</b>	<p>This tab displays the date —wise list of time report with description and scheduled work hours.</p> <hr/> <p><b>Note:</b> Approvals tab is displayed only when there is unapproved reported time.</p> <hr/> <p><b>Note:</b> For all the tabs except for Exceptions and Absences, the time period context selected on the page will be applied.</p>

This example illustrates time detail values inline in the timesheet of a Punch Time Reporter (1 of 2).

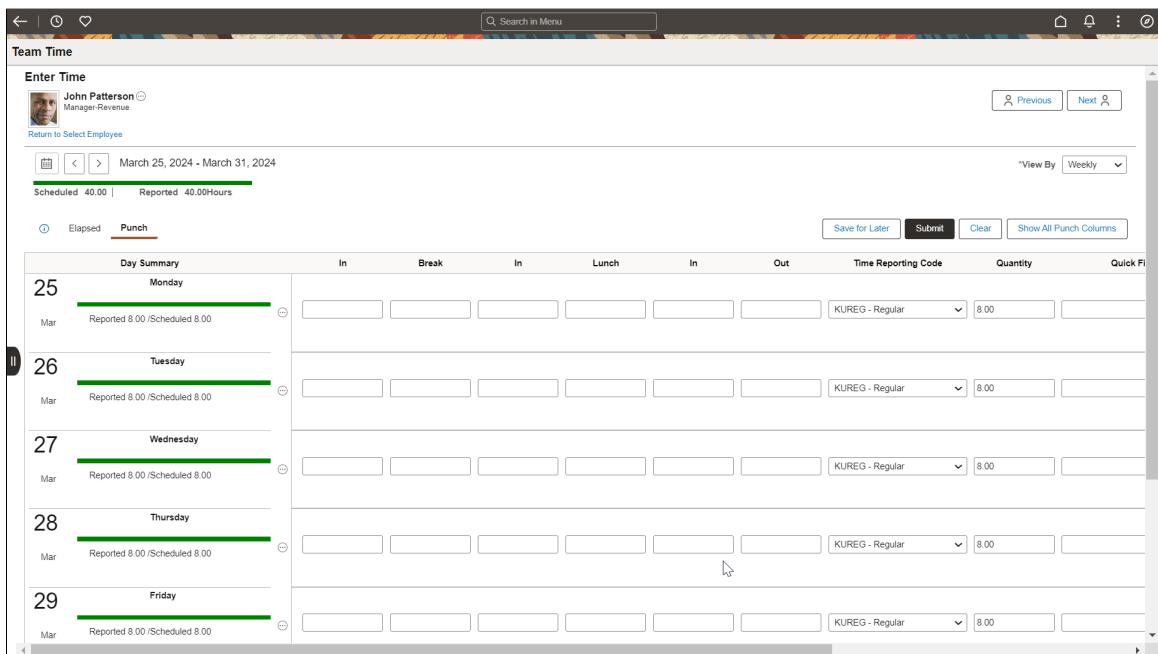

This example illustrates time detail values inline in the timesheet of a Punch Time Reporter (2 of 2).

The screenshot shows a 'Team Time' interface for a Punch Time Reporter. It displays a list of dates from March 28 to 31. For each date, there is a 'Reported' and 'Scheduled' time value, and a dropdown menu for the time type (e.g., 'KUREG - Regular'). The 'Time Summary' table at the bottom provides a breakdown of hours by category and day.

Category <sup>T1</sup>	Total <sup>T1</sup>	Mon 26/3 <sup>T1</sup>	Tue 26/3 <sup>T1</sup>	Wed 27/3 <sup>T1</sup>	Thu 28/3 <sup>T1</sup>	Fri 29/3 <sup>T1</sup>	Sat 30/3 <sup>T1</sup>	Sun 31/3 <sup>T1</sup>
Regular Time	40.00	8.00	8.00	8.00	8.00	8.00		8.00
Total Reported Hours	40.00	8.00	8.00	8.00	8.00	8.00		
Total Scheduled Hours	40.00	8.00	8.00	8.00	8.00	8.00		
Schedule Deviation								

Administrators can configure for managers to view the time detail values inline in the timesheet by selecting the option of **Expand Time Details on Timesheet** under the Time and Labor Installation Page.

The Enter Time pages for Punch time reporters show the **Time Details** icon when the **Expand Time Details on Timesheet** option is not selected under the *Fluid Timesheet* section on the Time and Labor Installation page.

An employee can delegate another person to report time on his/her behalf by authorizing another person as a delegate.

This example illustrates Enter Time selection page enabled with proxy.

**Note:** Once a delegation request is accepted by a proxy and the delegation transaction is active, the grid will be shown in the Report Time pages. If the Manager Search option has **prompt for results** or **Auto Populate**, it will be honored on this grid. Manager can choose between **Process my own Employees** or to act on behalf of the delegator. When the manager selects **Process my own Employees**, it shows a list of employees belonging to them (according to the row level security). When the manager selects the Delegator's name, it shows a list of employees that belong to the delegator (according to the row level security).

The screenshot shows the 'Enter Time' page in the Manager Self Service interface. The user is logged in as Rosanna Channing, acting as a proxy for Christelle Stevenson. The dropdown menu is set to 'Process my own Employees'. The table below lists employees with their respective hours to be approved and any exceptions.

Name/Title	Exceptions	Hours to be Approved
Edmund Donahue Manager-Accounting		
Mei Lee Accountant		2277.00
John Patterson Manager-Revenue	1	4.00
Shawn Quilligan Financial Analyst		1976.00
Daryl Reese Financial Analyst		2052.00
Vicki Zinn Accountant		2008.00

This example illustrates the Time Summary Search page.

The screenshot shows the 'Time Summary' page in the Manager Self Service interface. The search filter is set to 'As of Date' 04/01/2024. The table below lists employees with their respective hours to be approved and any exceptions.

Name/Title	Exceptions	Hours to be Approved
Dan Atwood Financial Analyst		
Cindy Bryson Billing Specialist	7	47.00
Ronnie Carmichael Billing Specialist		
Phillip Couch Financial Analyst		196.50
Colin Davidson Financial Analyst		24.00

Select an employee to view the Time Summary for that employee.

This example illustrates the fields and controls of the Time Summary Monthly view for a selected employee.

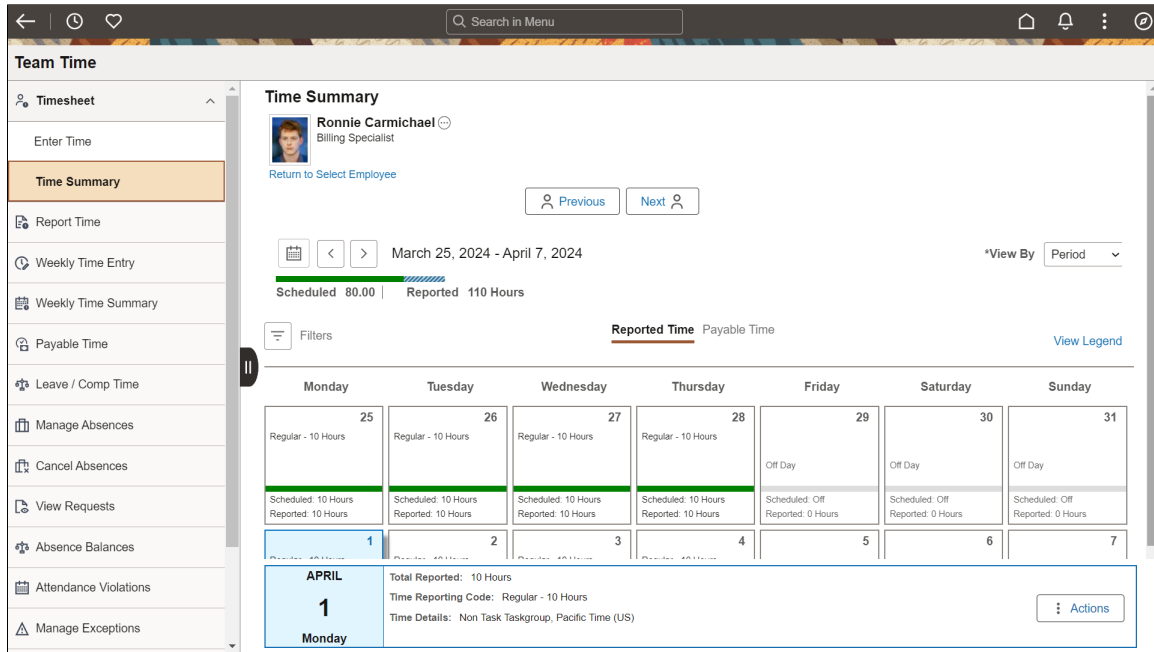

On selecting the Payable Time Summary you can get an overview of the payable time overview.

This example illustrates the fields and controls of the Time Summary Monthly view in the Payable Time tab for a selected employee.

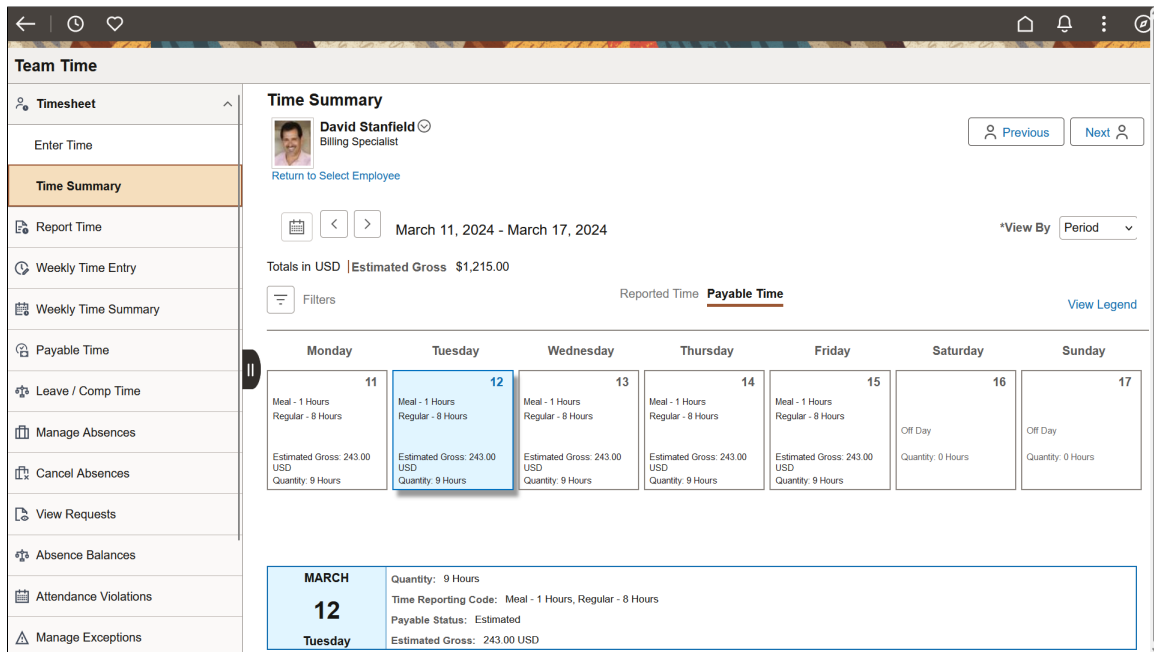

The Time Summary page reported time tab displays the reported time in different units other than hours for an employee in header, day box and footer.



Use **Get Employees** button in order to pull up the list of employees.

### Fluid Payable Time Total by Units

The Manager Payable Time and View Payable Time pages displays the quantity of time in units. You can also view total estimated gross in required currency.

The Time Summary page payable time tab displays the summary of payable time by TRC. The Payable Time Details tab displays the for each day, including the TRC for the time.

This example illustrates the fields and controls of Payable Time page summary tab.

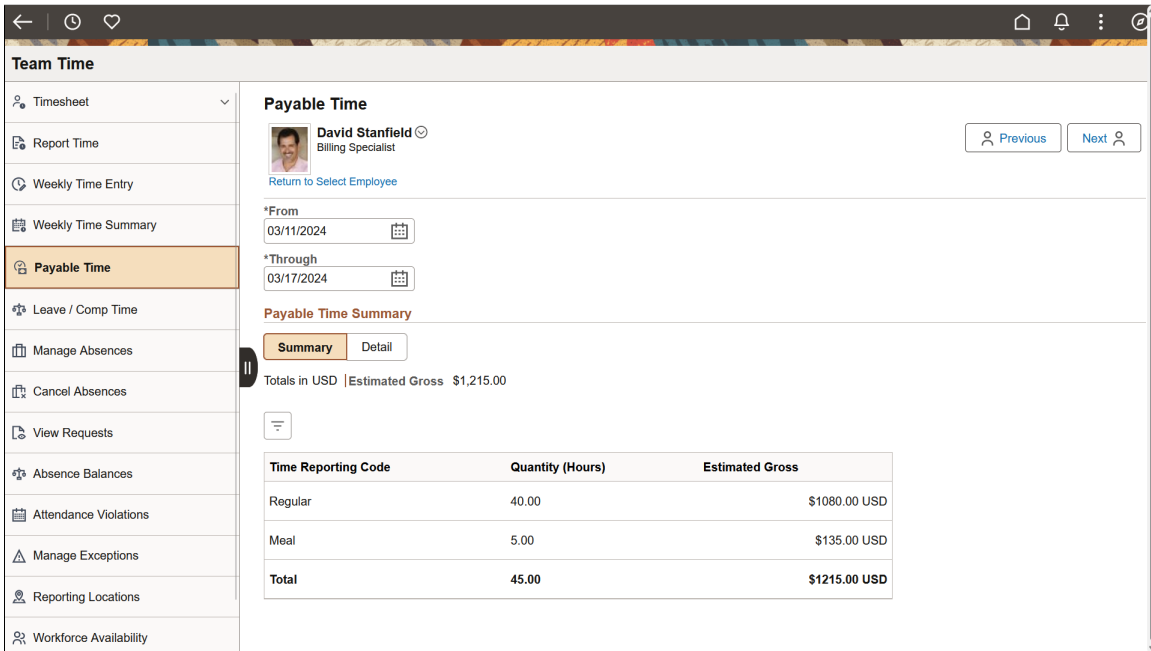

This example illustrates the fields and controls of Payable Time page details tab.

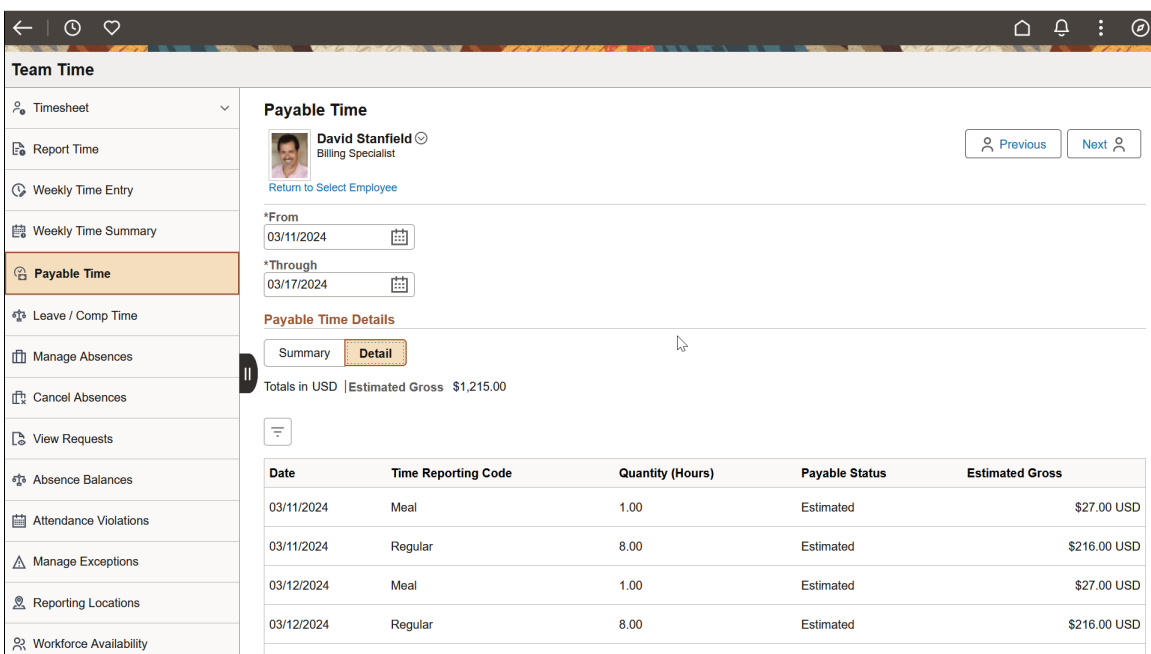

Click the Filter icon to open the Filter modal, where you can specify the parameters.

This example illustrates the fields and controls of the filters modal.

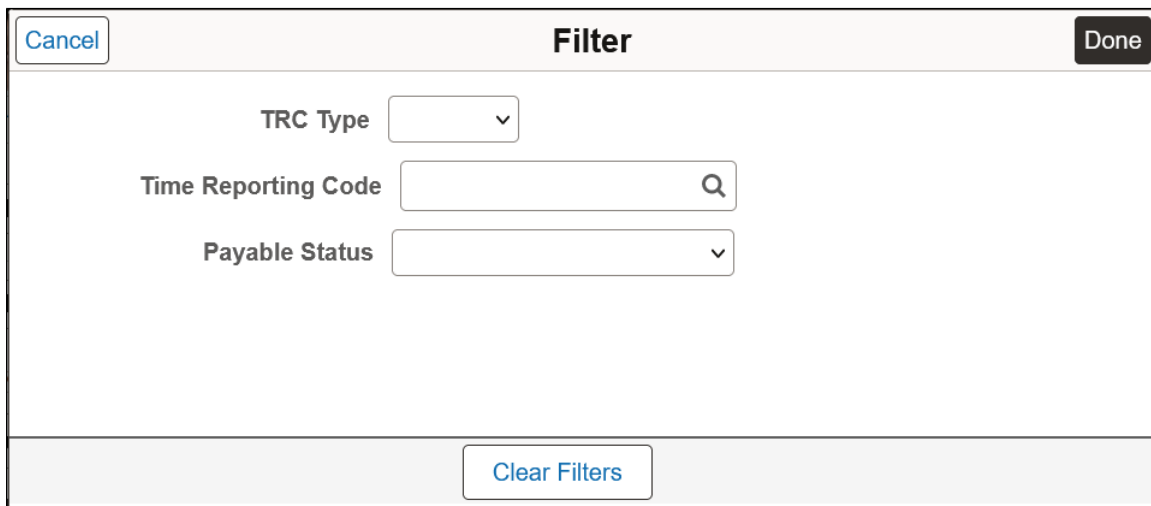

The screenshot shows a modal window titled "Filter". At the top left is a "Cancel" button and at the top right is a "Done" button. The main area contains three filter fields: "TRC Type" with a dropdown arrow, "Time Reporting Code" with a search icon, and "Payable Status" with a dropdown arrow. At the bottom center is a "Clear Filters" button.

You can filter manger's payable time based on the following attributes:

- TRC Type
- Time Reporting Code
- Payable Status

## Report Time Select Employee Filters page

Select the filter icon to open the filters modal where you can enter the parameters used set the filter criteria.

This example illustrates the fields and controls of the filters modal where you can specify the parameters for resulting the select employees.

The Report Time page allows the manager to enter reported time, modify reported time or delete reported time for the employees according to their data access.

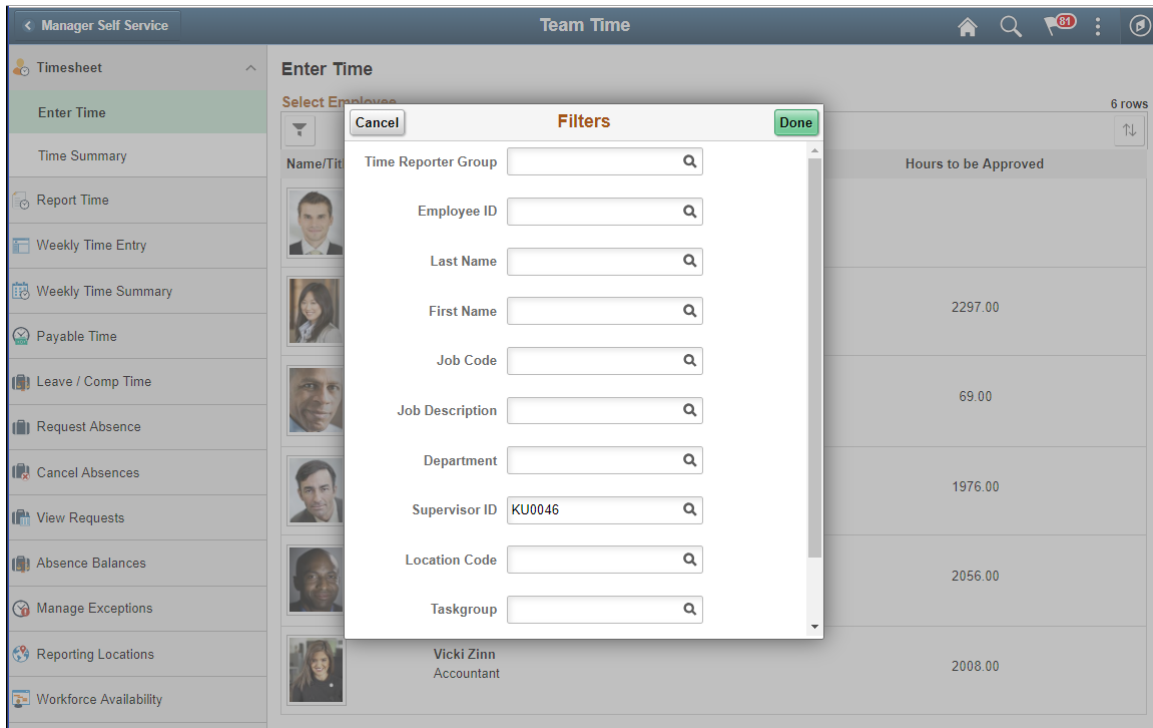

The filters modal provide a quick employee search for you with one or more of the following options:

- Time Reporting Group
- Employee ID
- Employee Record
- Last Name
- First Name
- Business Unit
- Job Code
- Job Description
- Department
- Supervisor ID
- Report To Position Number
- Location Code
- Company

- North American Pay Group
- Workgroup
- Taskgroup
- Position Number

**Note:** This options can be configured using manager search options page.

This example illustrates the fields and controls of Report Time page (TL\_RPTD\_ELP\_FLU) for Elapsed Time reporters.

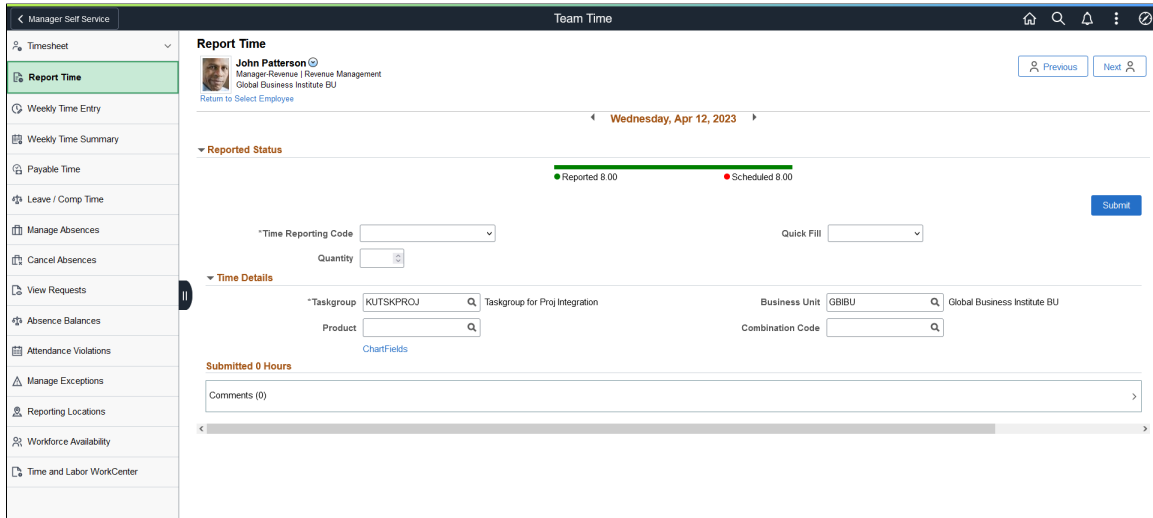

This example illustrates the Report Time page enabled with delegation.

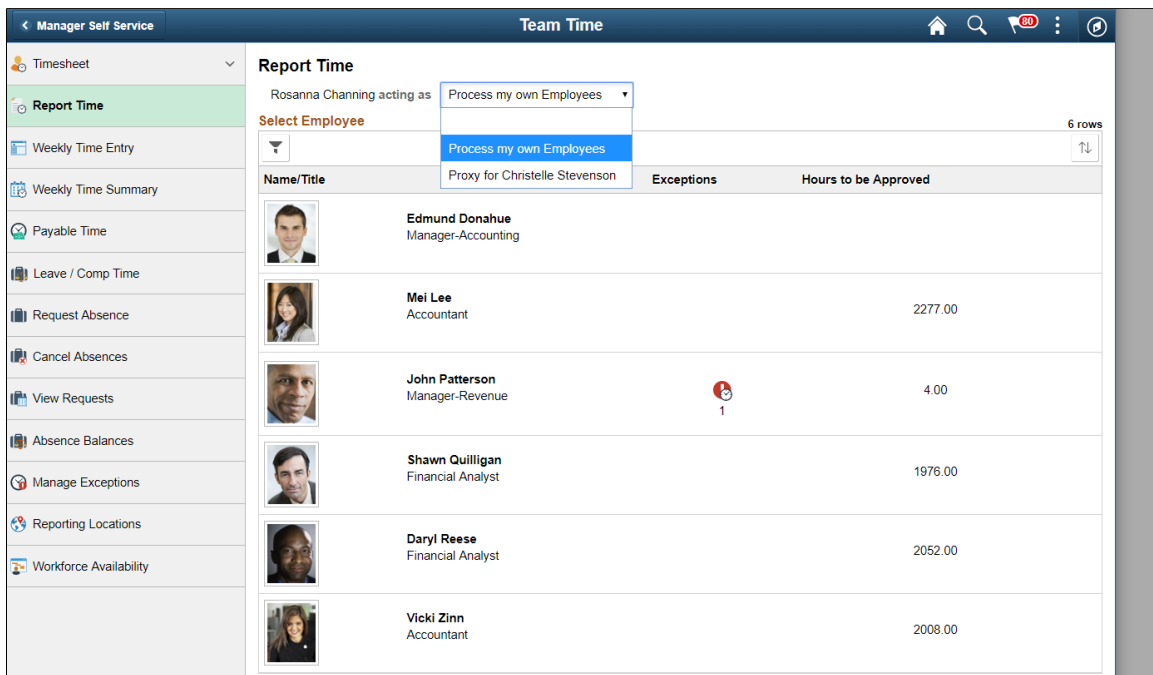

## Weekly Time Entry page

Use Weekly Time Entry (TL\_PRE\_POP\_ELP\_FLU) page to view the time reported for a week. The manager can also modify and report time per week.

This example illustrates the fields and controls of Weekly Time Entry for Manager Self Service.

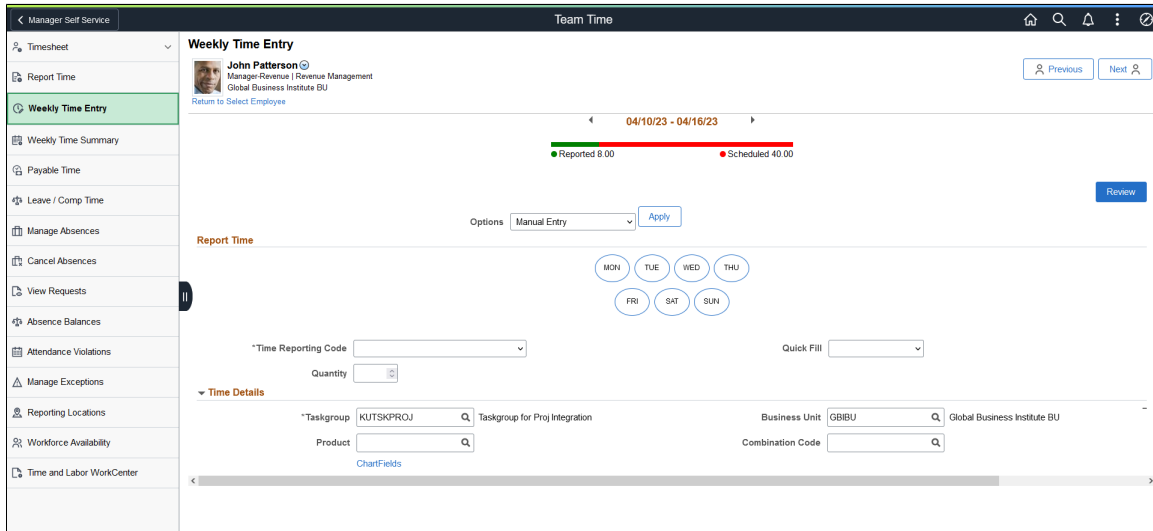

This example illustrates the Weekly Time Entry page enabled with delegation.

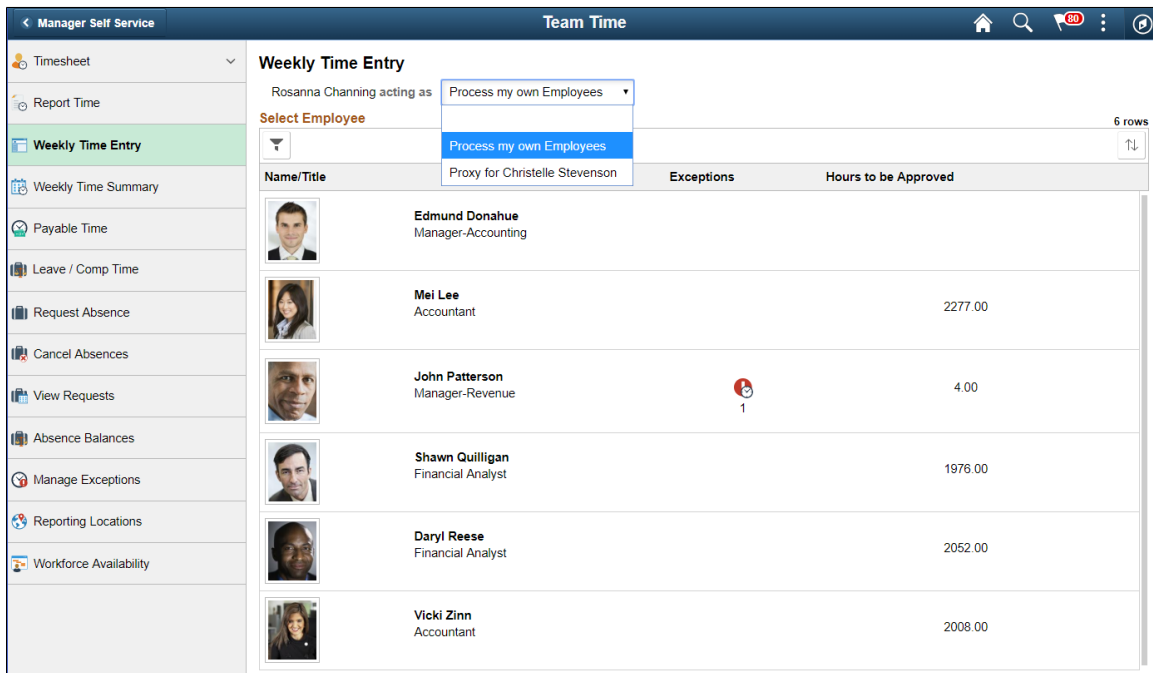

### Auto Approval For Time Submitted by Manager

The time entered by the manager on behalf of their employees are auto-approved for the following conditions:

- The reported time is entered or edited by the Manager

- Only Time that is entered and edited by the manager
- Any Time (Line or day level) only if acted on by the Manager
- The immediate approver in the approval chain is the same person as the acting Manager or their delegates (Applies to multiple managers in the same approval level).

**Note:** This is for **Any** case. For **ALL** case, the auto-approval will only trigger for the time reporter or manager in this case. If there are other steps in the approval chain, then the time will be auto-approved and only skip the acting Manager or delegates step. The time still be in **Needs Approval** status until it is approved by all in the approval chain. Time Sent Back or Denied will still retain its status until acted upon by the Manager.

Refer the configurations mentioned in [Configurations Page](#) for auto approval for time submitted by a manager.

The following video gives an overview of

Video: [Image Highlights, PeopleSoft HCM Update Image 30: Auto Approval for Time Submitted by a Manager](#)

This example illustrates an Enter Time Page with Manager Auto Approval enabled for Elapsed Time Reporter.

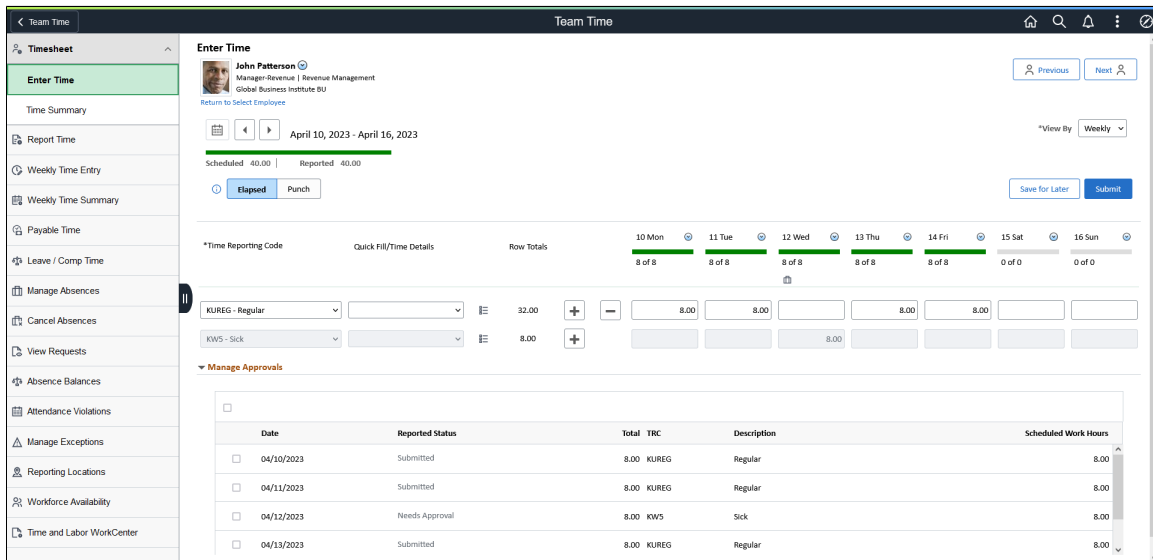

The example has two instances of time reported by manager, and the third by employee. When the time is reported by the immediate manager, it gets auto approved.

This example illustrates an Enter Time Page with Manager Auto Approval enabled for Punch Time Reporter.

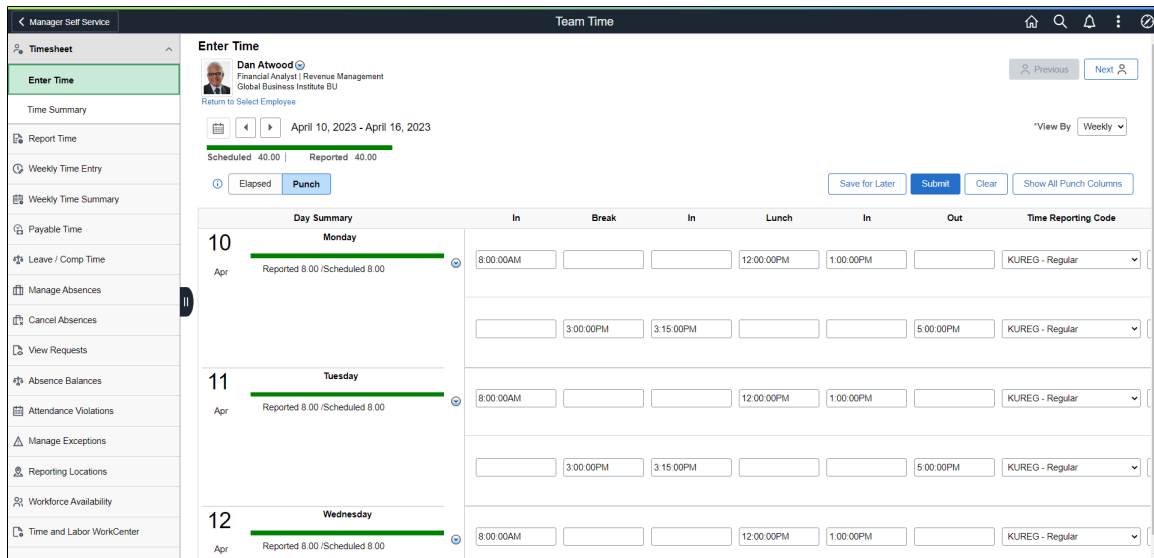

In case of punch time reporting, any punches reported by employee comes for an approval to the manager, whereas if the manager either edits or reports a new punch for a particular day, all the punches would get auto approved.

**Note:** In addition to Enter Time page, the auto approval is applicable for Report Time page, Weekly Time Entry page. The auto approval feature is available for batch programs like mass time and rapid time approvals.

This example illustrates the Time detail values inline in the Timesheet of an Elapsed Time reporter.

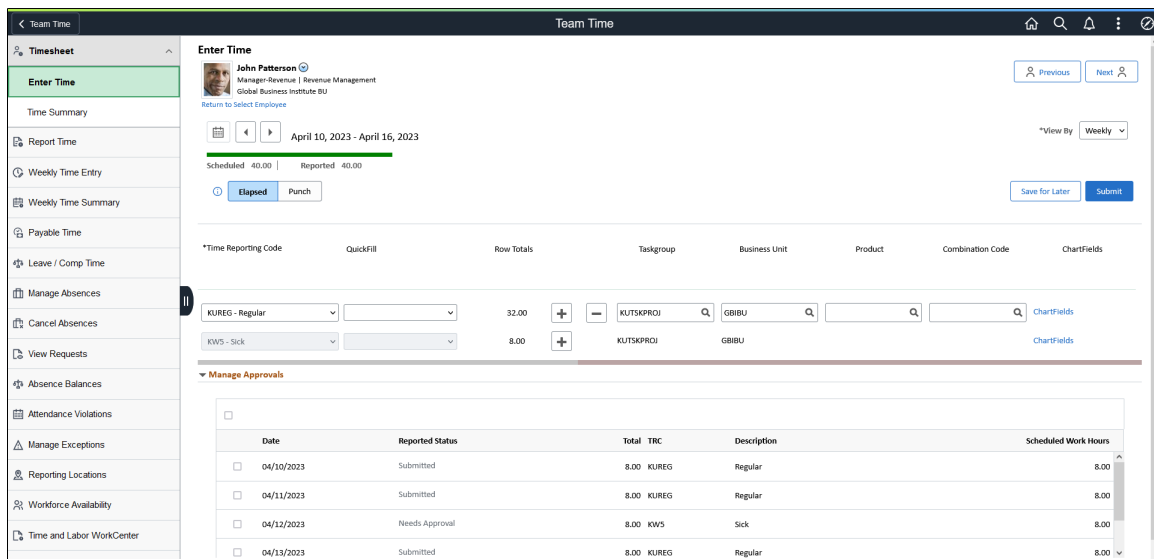

Administrators can configure managers to view the time detail values inline in the timesheet by selecting the option of **Expand Time Details on Timesheet** under Time and Labor Installation Page.

The Enter Time pages for elapsed time reporters show **Time Details** icon when **Expand Time Details on Timesheet** option is not selected under *Fluid Timesheet* section in the Time and Labor Installation page.

## Weekly Time Summary page

Select the details chevron to get the details of weekly team time reported for a particular employee.

This example illustrates the fields and controls of Weekly Team Time for Manager Self Service.

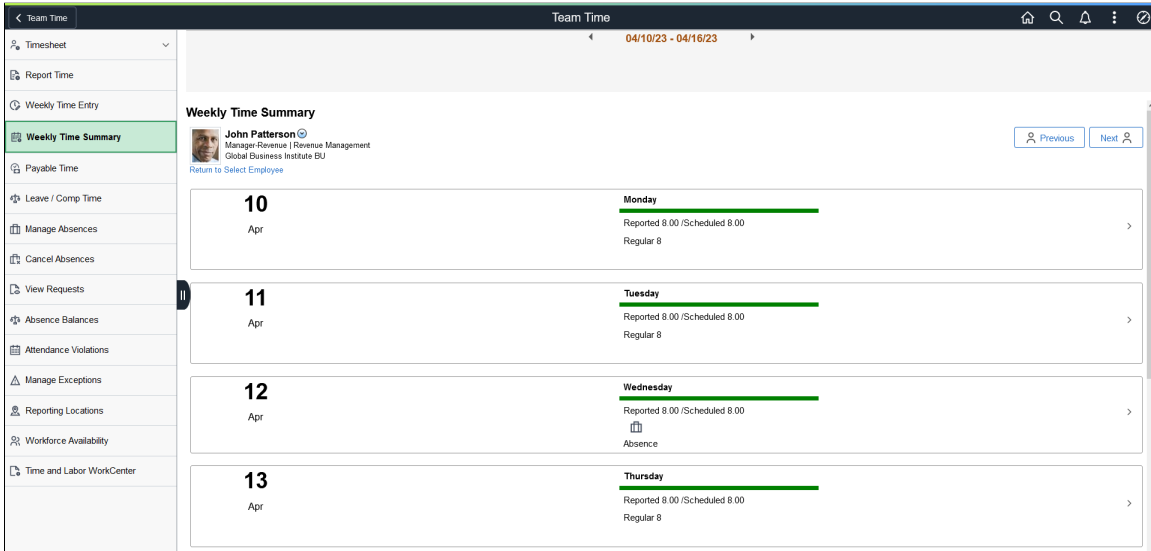

Field or Control	Description
<a href="#">Return to Select Employee</a>	Select the hyperlink to go back to the Weekly Team Time page where it list the employees according to the search criteria.
	Select to view the related actions menu.

This example illustrates the fields and controls of the weekly time page related actions.

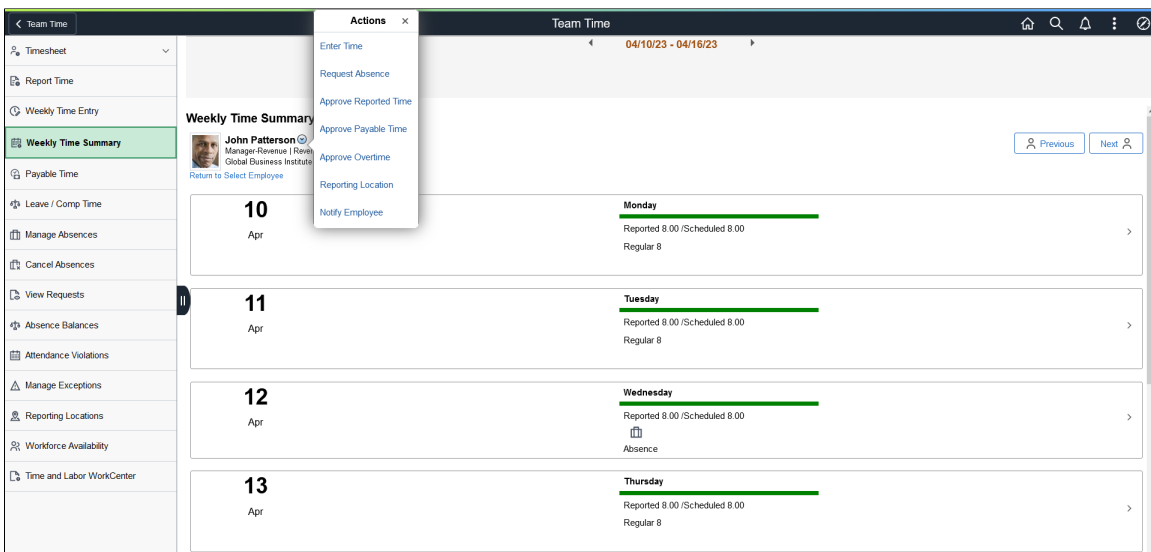



<b>Field or Control</b>	<b>Description</b>
<b>View Timesheet</b>	Select to launch the classic Timesheet page.
<b>Request Absence</b>	Select to request absence for the selected employee.
<b>Approve Reported Time</b>	Select to launch classic Approve Reported Time page to approve reported time for the selected employee..
<b>Approve Payable Time</b>	Select to launch classic Approve Payable Time summary page to approve payable time for the selected employee.
<b>Approve Overtime</b>	Select to launch classic Approve Overtime page to approve overtime for the selected employee.
<b>Reporting Locations</b>	Select to launch Reporting Locations page and view the physical location from where the employee has entered their time. The physical location is captured and stored as a latitude and longitude.
<b>Notify Employee</b>	<p>Select to launch HR Notification page to send notifications.</p> <hr/> <p><b>Note:</b> Oracle PeopleSoft delivers Notification Composer Framework to manage the setup and administration of all notifications in one central location. Once you have adopted the Notification Composer feature, you must use it to create new notifications and manage your existing notifications. Notifications delivered with HCM Image 47 or later must use Notification Composer. For more information about Notification Composer Framework, see “Understanding Notification Composer” (Enterprise Components).</p> <hr/>

**Note:** The Request Absence related action is available if the employee is part of the absence system. This related action is used to launch classic Request Absence page to view the absences requested for the selected employee. The related actions open for a date selected in the date picker.

Further on selecting chevron, the weekly time page details will navigate back to Report Time page with Return to Weekly Time page link.

## Payable Time (Select Employees) page

Use the Payable Time (Select employees) page to select an employee Use Payable Time page (TL\_PAYBTIME\_FLU) to select the employee and review their payable time.

This example illustrates the fields and controls of the Payable Time page for a signed in manager.

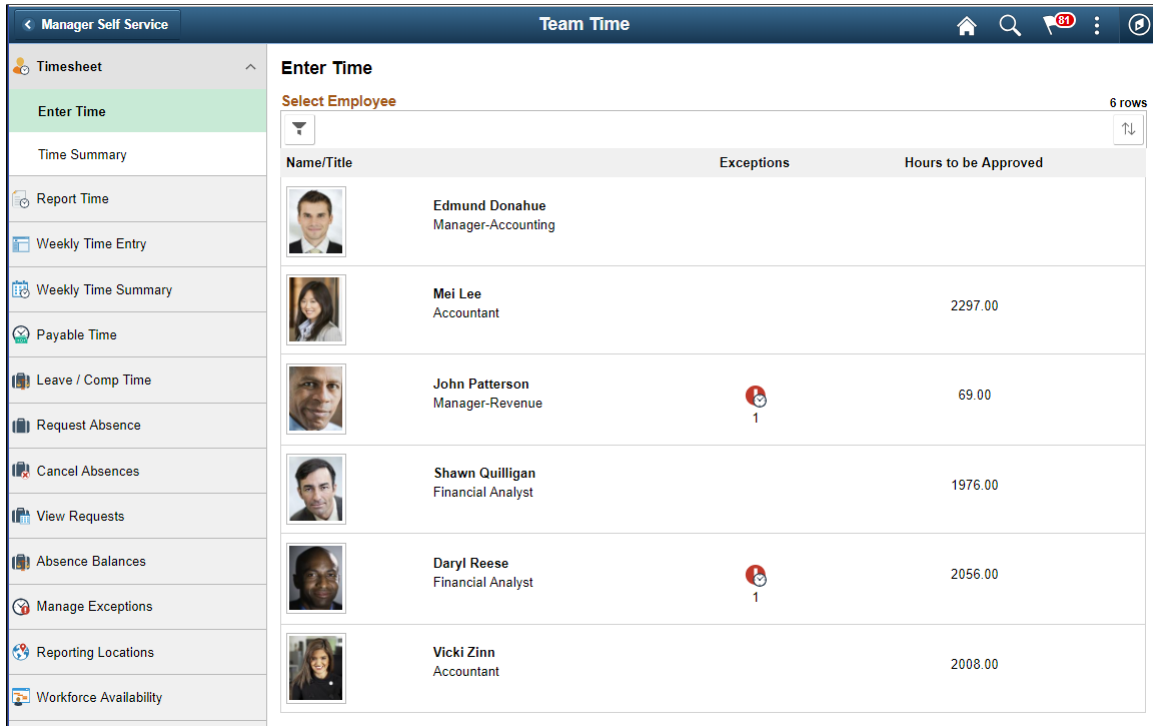

The manager can use filters to search the employees for a certain filter criteria.

## Payable Time page

Use Payable Time (TL\_PAYBTIME\_FLU) page to review employees payable time details with duration and Time reporting code, payable hours, and estimated gross for the selected period.

This example illustrates the fields and controls of the payable Time page.

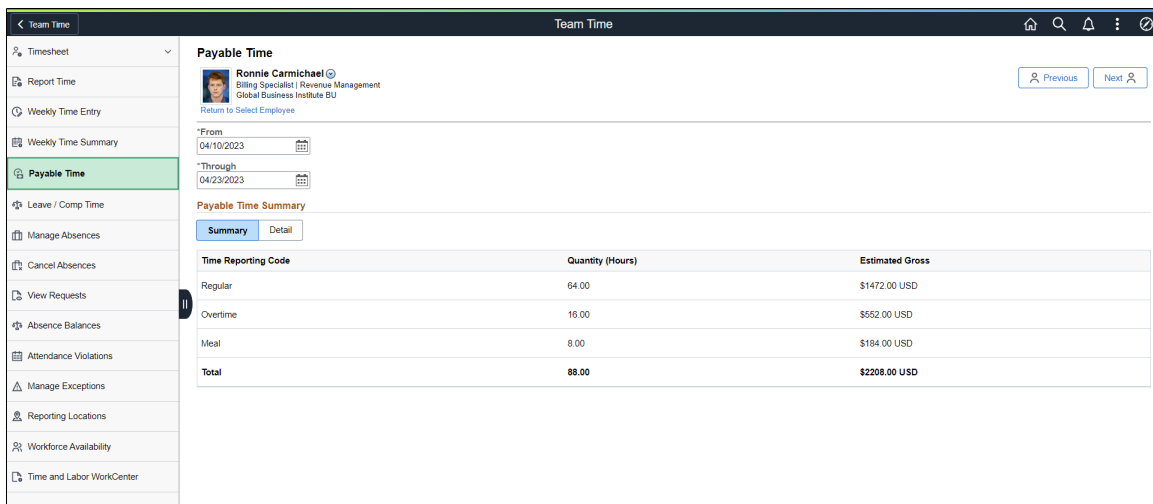

<b>Field or Control</b>	<b>Description</b>
<b>Payable Time Summary</b>	The manager can review the estimated gross and payable hours for a selected period of time.

Select on the Detail tab to view the Payable Time Detail page.

This example illustrates the fields and controls for Payable Time Detail page.

**Payable Time**

Ronnie Carmichael  
Billing Specialist | Revenue Management  
Global Business Institute BU

From: 04/10/2023  
Through: 04/23/2023

**Payable Time Details**

Summary | **Detail**

Date	Time Reporting Code	Quantity (Hours)	Payable Status	Estimated Gross
04/10/2023	Meal	1.00	Closed	\$23.00 USD
04/10/2023	Overtime	2.00	Closed	\$69.00 USD
04/10/2023	Regular	8.00	Closed	\$184.00 USD
04/11/2023	Meal	1.00	Closed	\$23.00 USD
04/11/2023	Overtime	2.00	Closed	\$69.00 USD
04/11/2023	Regular	8.00	Closed	\$184.00 USD
04/12/2023	Meal	1.00	Closed	\$23.00 USD
04/12/2023	Overtime	2.00	Closed	\$69.00 USD
04/12/2023	Regular	8.00	Closed	\$184.00 USD







The detail tab displays the Payable Status of the employee.

## Leave / Comp Time page

Use the Leave / Comp Time (Select Employee) page to select the employee using the filter and view the employees with the selected filter criteria.

This example illustrates the fields and controls on the Leave / Comp Time (Select Employees) page. You can find definitions for the fields and controls later on this page.

The screenshot displays the 'Leave / Comp Time' page in the PeopleSoft Manager Self Service interface. The page is titled 'Team Time' and features a 'Select Employee' dropdown menu at the top right, indicating 6 rows of data. Below the dropdown is a table with the following columns: Name/Title, Exceptions, and Hours to be Approved. The table lists six employees with their respective photos and titles.

Name/Title	Exceptions	Hours to be Approved
 Edmund Donahue Manager-Accounting		
 Mei Lee Accountant		
 John Patterson Manager-Revenue		
 Shawn Quilligan Financial Analyst		
 Daryl Reese Financial Analyst		
 Vicki Zinn Accountant		

This example illustrates the fields and controls on the (Smartphone) Leave /Comp Time page.

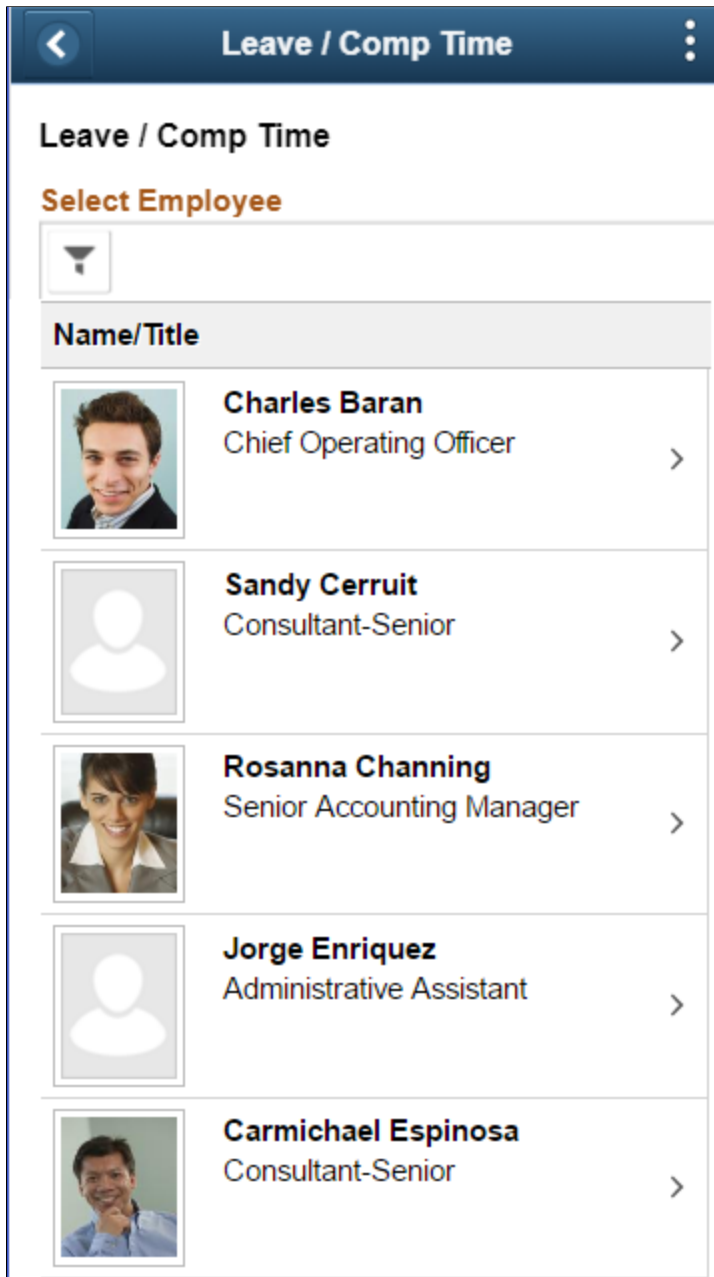

Click on the chevron to view the Leave / Comp Summary page.

The Leave / Comp Time Summary (TL\_COMPLEAVBAL\_FLU) page is used to view the summary of leave balances of employees in card format.

This example illustrates the fields and controls of Leave / Comp Time Summary using desktop.

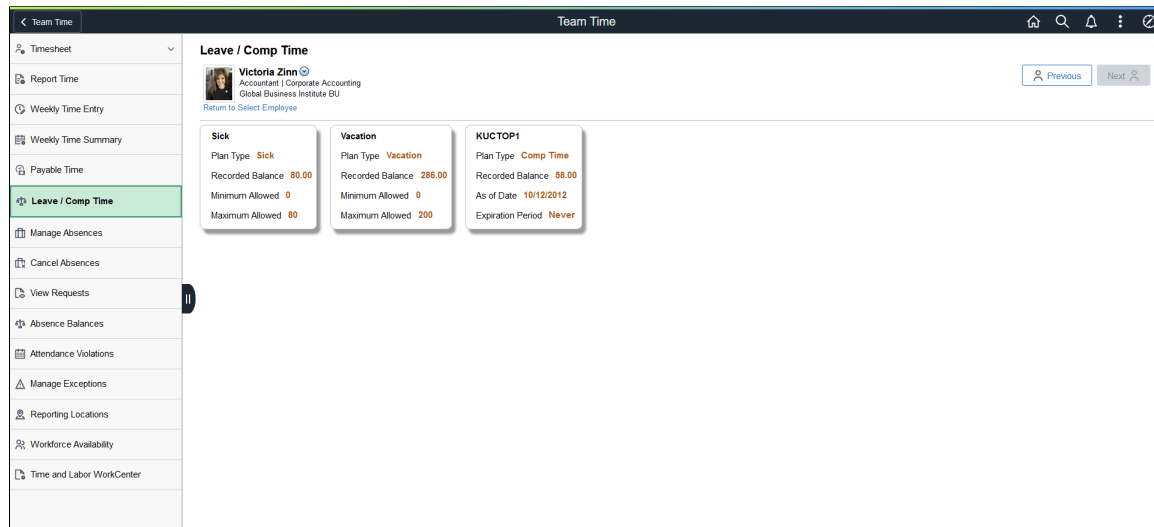

The sick, vacation and compensatory time off are shown in cards. Each of your leave types and compensatory time off plans are displayed as cards..

The compensatory time off displays **As of Date** and **Expiration Period**.

---

**Note:** The Expiration Period will be for the last approval run balance. This is determined on the basis of comp plan and the latest accrual.

---

This example illustrates the Leave / Comp Time summary page using smartphone.

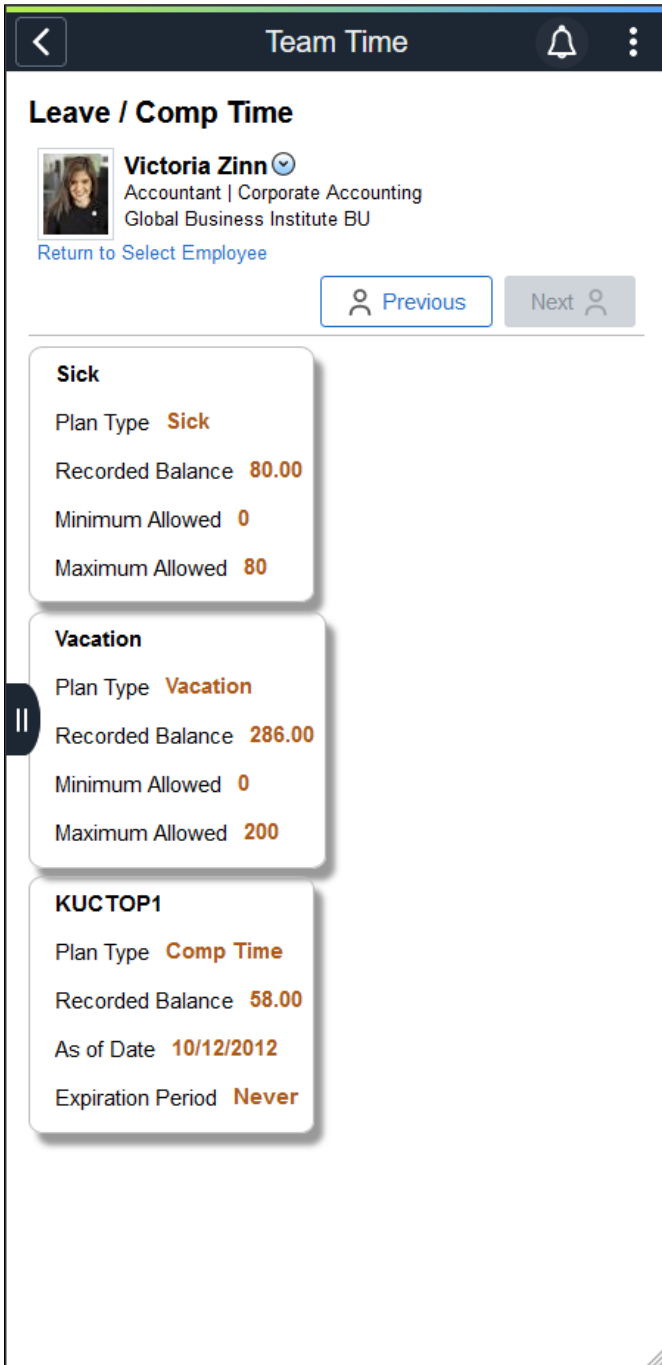

Click on the leave type card to view the Leave / Comp (TL\_COMPLEAVHST\_FLU) page.

The Sick and Vacation details show the minimum allowed and Maximum Allowed leave upfront on the card. The Comp Time leave card displays As of Date and Expiration Period.

This example illustrates the fields and controls of the Leave / Comp Time Details page.

**Victoria Zinn**  
 Accountant | Corporate Accounting  
[Return to Leave Balances](#)  
 Global Business Institute BU

**Leave Balance**

Sick Balance	Minimum Balance	Maximum Balance
80.00	0	80

**Leave Balance Details**

Accrual Date	Earned	Taken	Balance
12/31/2022	0.00	0.00	80.00
11/30/2022	0.00	0.00	80.00
10/31/2022	0.00	0.00	80.00
09/30/2022	0.00	0.00	80.00
08/31/2022	0.00	0.00	80.00
07/31/2022	0.00	0.00	80.00
06/30/2022	0.00	0.00	80.00
05/31/2022	8.00	0.00	80.00
04/30/2022	8.00	0.00	72.00
03/31/2022	8.00	0.00	64.00



The following example illustrates the fields and controls of Leave Balances details for employees using smartphone.



<b>Field or Control</b>	<b>Description</b>
<b>Earned</b>	Number of leaves earned for an year.
<b>Taken</b>	Number of leaves taken so far.
<b>Balance</b>	Number of leaves remaining for the year.

## Attendance Violations page

Use the Attendance Violations page to view the summary of violations for a selected period of time.

Navigation:

- Select the **Team Time** tile on the Manager Self Service page or a homepage where the tile is added.
- Select *Attendance Violation* on the left hand pane from the Team Time navigation collection page.

This example illustrates the fields and controls on the Attendance Violations page.

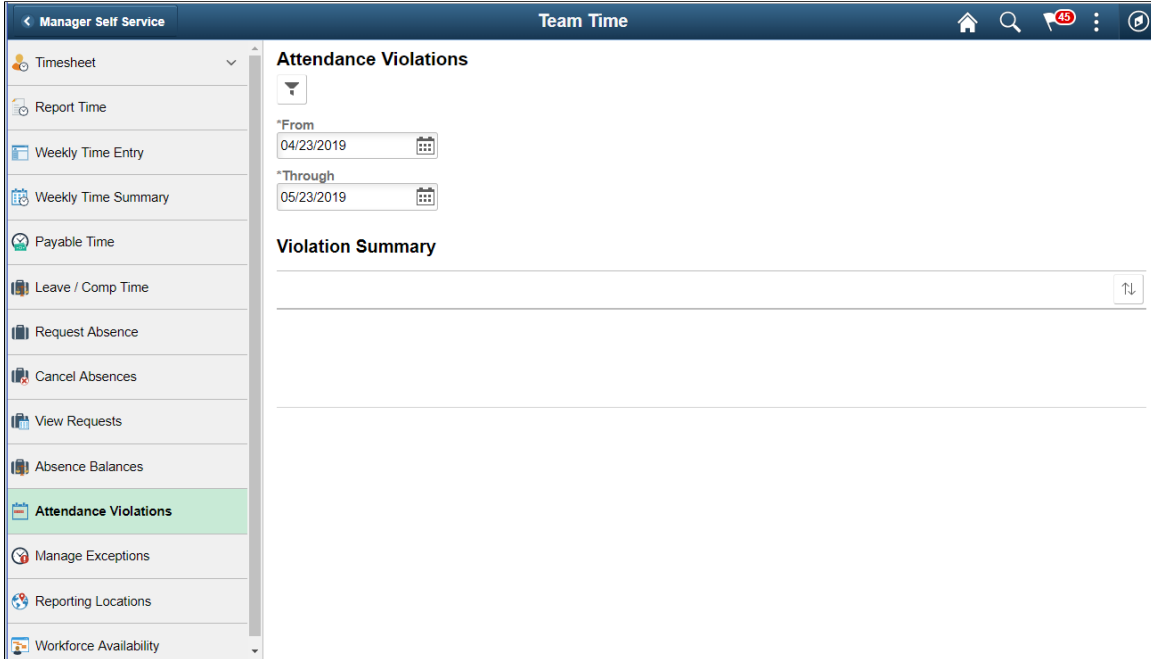

<b>Field or Control</b>	<b>Description</b>
<b>Start Time</b> <b>End Time</b>	Select and enter start and end time for which the attendance violation summary for the selected employee need to be displayed.

This example illustrates the Attendance Violations summary for a particular period.

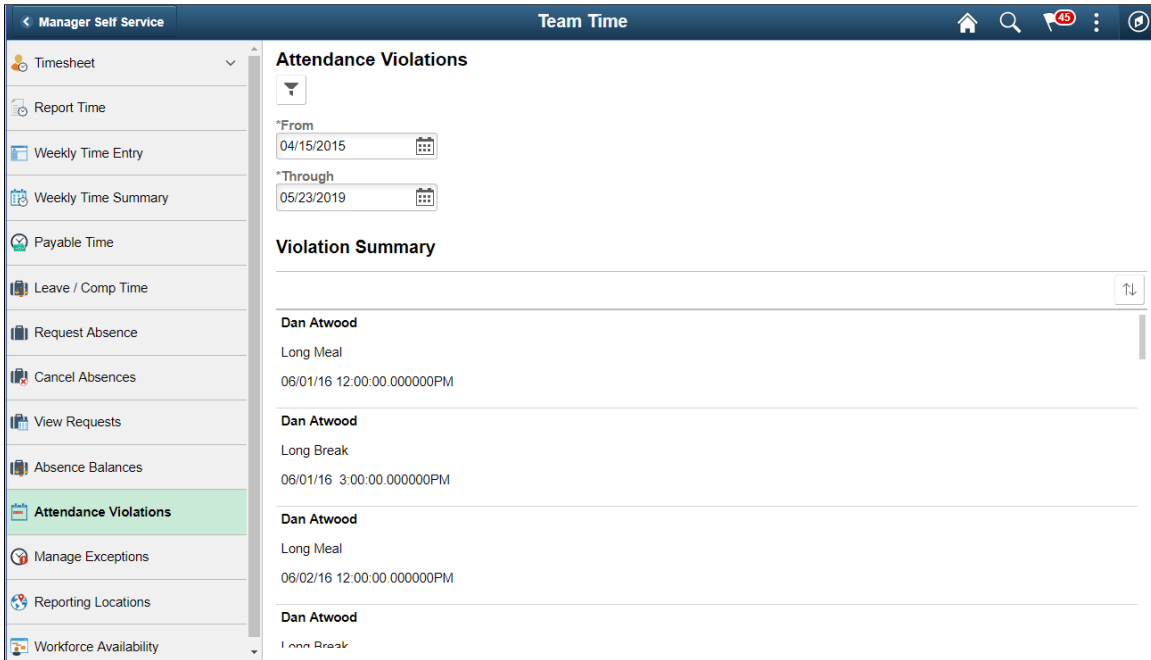

**Note:** The manager can view his employees attendance violation summary from the related actions of **Enter Time** page.

### Attendance Violation from Enter Time Related Actions

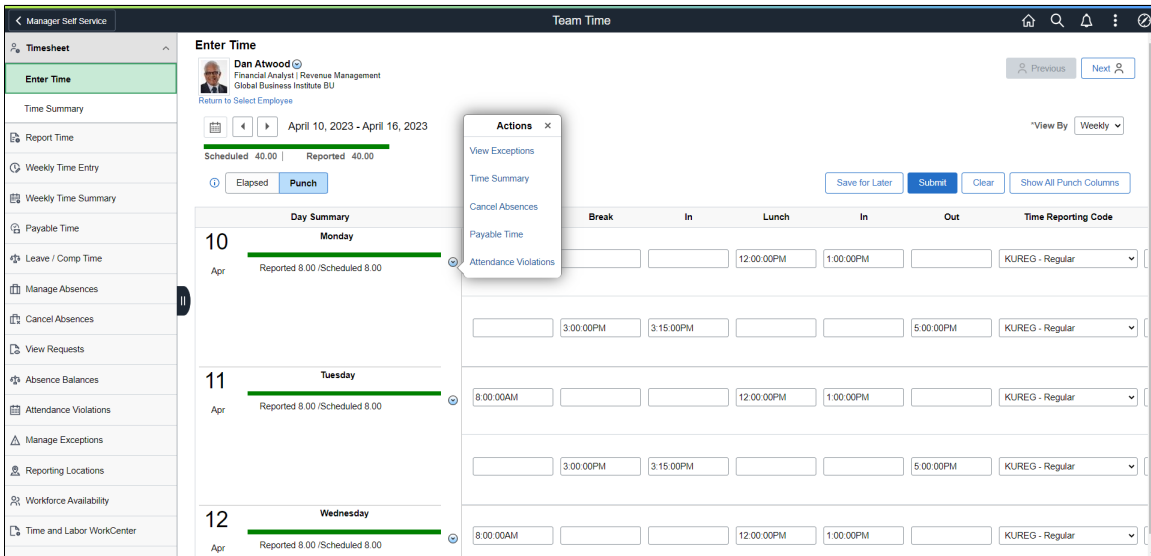

On selecting attendance violation from the related action, it opens a window with attendance violation summary.

This illustrates an example of Attendance Violations — violation summary page.

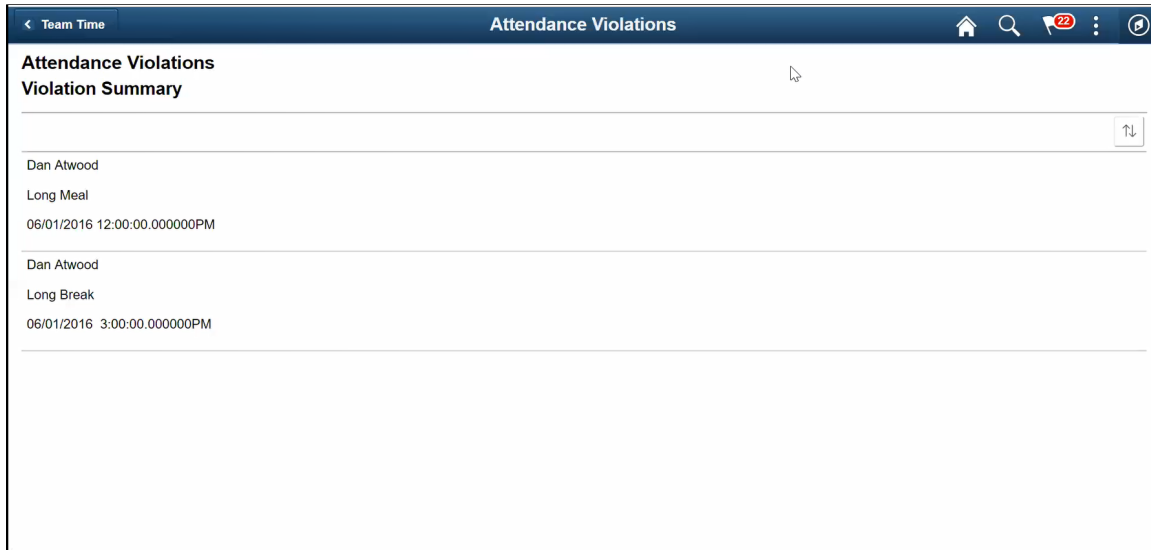

This example illustrates the fields and controls of Enter Time page with Attendance violations icon.

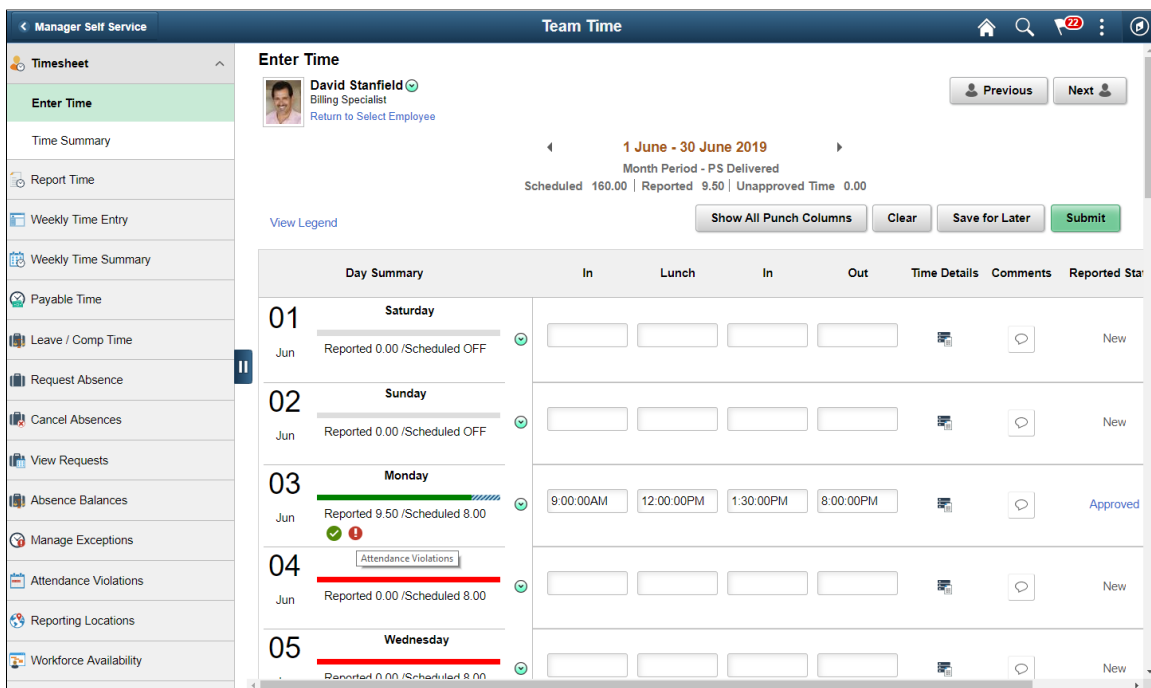

The day summary shows a red icon for attendance violations.

## Manage Exceptions Page

Use the Manage Exceptions page to view and resolve exceptions using Fluid User Interface.

Navigation:

- Select the **Team Time** tile on the Manager Self Service page or a homepage where the tile is added.

- Select *Manage Exceptions* from on the left hand pane from the Team Time navigation collection page.

This example illustrates the fields and controls on the Manage Exceptions\_Update / Add Time page.

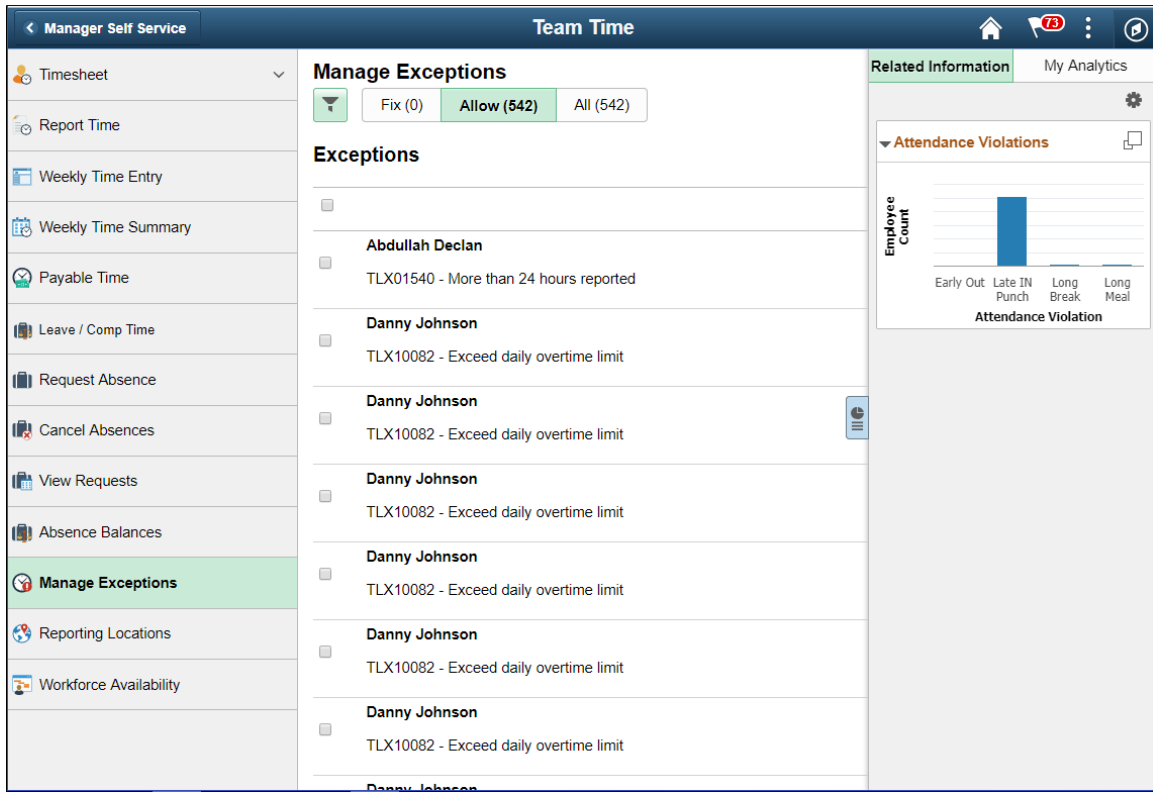

Select the chevron to open the Manage Exceptions details page. The details page contain the Return to Manage Exceptions link to go back to the Manage Exceptions page.

This example illustrates the fields and controls on the Manage Exceptions\_Update / Add Time page.

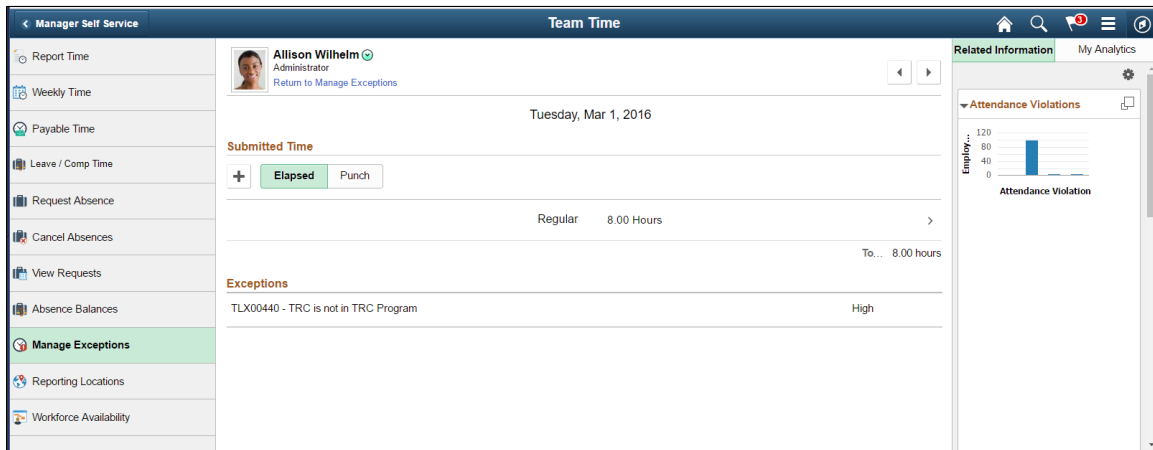

<b>Field or Control</b>	<b>Description</b>
	Click on the icon to add a new time. Also select the time row to delete or modify the reported time.

**Note:** The manager can dismiss the exception by clicking on the check box Allow. When the resolution of an exception requires a modification of the employee timesheet, the manager can transfer it to the employee timesheet to make corrections. The manager can add a new time row by clicking on the plus icon and enter the missed punch to resolve the exceptions.

## Reporting Locations Page

Managers can use the Reporting Locations page to view the employee location when the employee has accepted the use of location services and your organization has licensed and enabled Oracle Maps Service for PeopleSoft on the Installation Table — “Setting Up Implementation Defaults” (Application Fundamentals)

Navigation:

- Select the **Team Time** tile on the Manager Self Service page or a homepage where the tile is added.
- Select *Reporting Locations* from the list in the Team Time page.

When Oracle Maps Service for PeopleSoft is enabled, the Team Time page from the Fluid Manager Self Service pages displays the Reporting Locations transaction category. When Oracle Maps Service is disabled, the Reporting Locations option is not available for selection on the Team Time page.

This example illustrates the fields and controls on the Reporting Locations page.

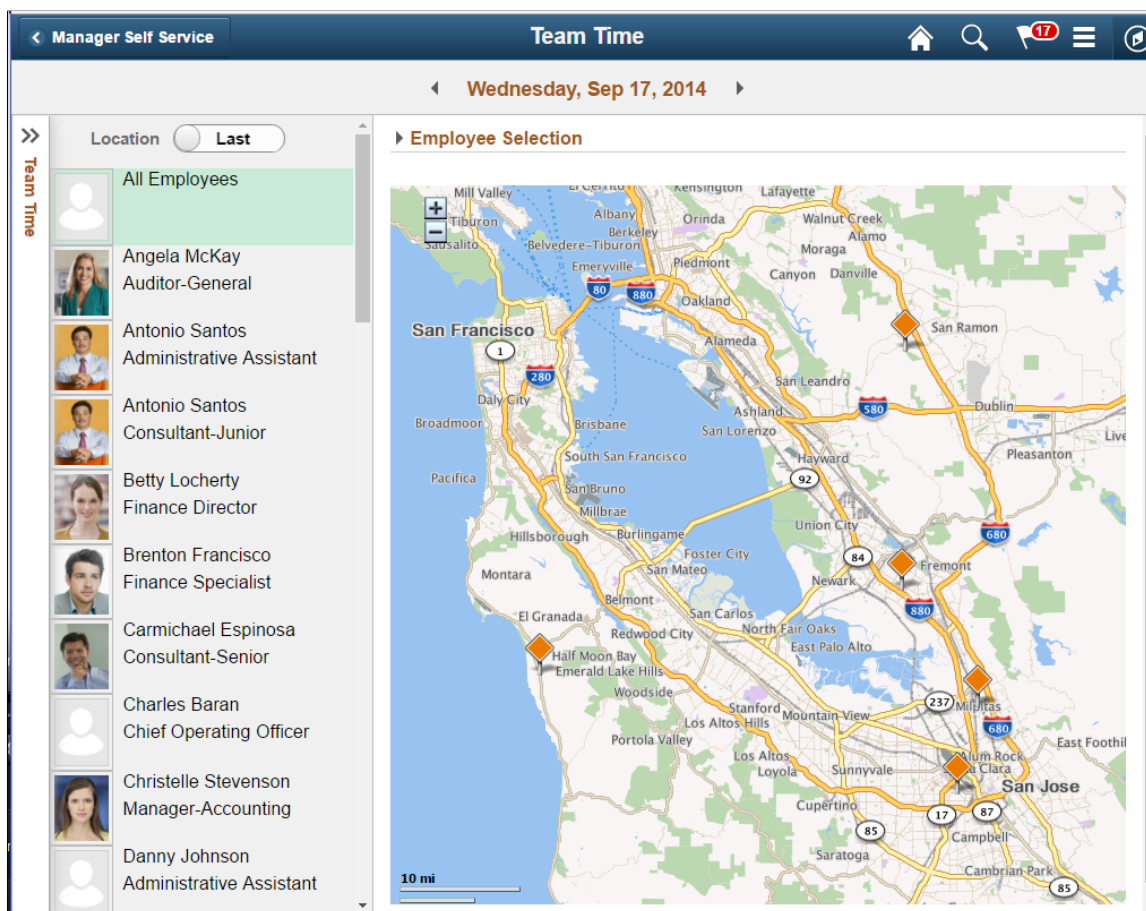

The Time and Labor related Manager Self Service tasks are Manage Exceptions and viewing Reporting Locations.

**Note:** When Oracle Maps Service for PeopleSoft is enabled, the Team Time page from the Fluid Manager Self Service pages displays the Reporting Locations transaction category. Select this option to access the [Reporting Locations Page](#) and view where your employees reported their time. When Oracle Maps Service is disabled, the Reporting Locations option is not available for selection on the Team Time page.

## Workforce Availability Page

Managers can use the Workforce Availability page (TL\_EMP\_PRES\_FLU) to access the Workforce Availability landing page and the related categories with detailed information of the team members. Workforce Availability provides ability for the managers to see a comprehensive view of his team's availability for the day - who is in office, who is in training, who has not clocked in.

Navigation:

- Select the **Team Time** tile on the Manager Self Service page or a homepage where the tile is added.
- Select *Workforce Availability* from the list in the Team Time page.

The manager can track his employee's availability status, and related actions in desktop, smartphone and tablet for a day or week and plan for a better coverage. The Manager can track the availability of team members at any given time of the day and can monitor the schedule adherence and then plan the schedule coverage. This facility is available for the weekly status too.

This example illustrates the fields and controls on the Workforce Availability page.

The screenshot shows the 'Workforce Availability' page. On the left, a sidebar contains a 'Team Time' menu and a 'Step Label Workforce Availability' section with filters: 'View By' (Daily Time), 'Scheduled' (23), 'No Show' (1), 'Schedule Deviation' (0), 'Not Scheduled' (1), 'Elapsed' (0), and 'Away from Work'. The main area is titled 'Workforce Availability' and shows a 'Scheduled' filter with 23 rows. Below this is a table with columns for Employee/Shift, Reported, and Scheduled. The table lists three employees: Helen Johnson (8:00 AM-5:00 PM), Kirby Torres (12:00 AM-7:00 AM and 11:00 PM-11:59 PM), and Brenton Francisco (7:00 AM-6:00 PM). Each employee row includes a Gantt-style availability chart and a 'No Show' indicator for Kirby Torres.

Employee/Shift	Reported	Scheduled
Helen Johnson 888/999-0000 8:00 AM-5:00 PM	0.00	0.00
Kirby Torres 555/666-7777 12:00 AM-7:00 AM, 11:00 PM-11:59 PM No Show	0.00	1.30
Brenton Francisco 925.555.0098 7:00 AM-6:00 PM	0.00	0.00

The right hand panel for scheduled category displays different combination of data for employees who are in any of the following combinations:

- Absence and Training for the day
- Absence, training and on deviation
- Actual reported time as per schedule
- Absence (Benefits leave)
- Comp Leave, Training and Reported Time.
- Schedule Deviation

**Note:** The user can view the drill down details for each specific or combination of different categories.

<b>Field or Control</b>	<b>Description</b>
	Select to view the hidden navigation collection for manager self service which includes all the time related actions.
<b>Scheduled</b>	Shows all the scheduled employees for that day . This category displays multiple categories at one place.
<b>No Show</b>	Displays the list of punch time reporters who are scheduled to work on that day but there is neither reported time nor absence or training.
<b>Schedule Deviation</b>	Lists the employees who deviated from their schedule. Deviation is arrived using TL Installation configuration which we will discuss in the next slide. Only Punch time reporters are considered for this category.
<b>Not Scheduled</b>	Shows the Elapsed and Punch time reporters with scheduled OFF / Holiday for that particular day.
<b>Elapsed</b>	Shows the list of elapsed time reporters who have reported time.



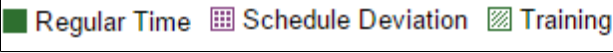



<b>Field or Control</b>	<b>Description</b>
<b>Away from Work</b>	<p>Once you expand <b>Away from Work</b> category, it will show the following sub categories:</p> <ul style="list-style-type: none"> <li>• <b>Approved absence</b> : Manager can see the employees who have approved leave for that day. Benefits administration leaves and GP Absences are considered.</li> <li>• <b>Unapproved Absence</b> : Lists the employees whose absence/leave approvals are yet to processed that means Data with needs approval status.</li> <li>• <b>Training</b> : Shows the details of employees who have enrolled into HR / ELM Training.</li> <li>• <b>Comp time off</b> : Displays the employees who are on Comp time off for that day.</li> </ul>
<b>Employee/Shift</b>	Displays the name, phone number and shift of the employee.
	Shows the patterns in which the categories of employees are represented in the below grid or in legends.
My Analytics	Shows the overview of the analytics for workforce for the current view.
Add icon	Add a new scenario for analytics by defining the needed scenarios
Workforce Availability link	Select to view My Analytics for the current scenario, or enhance the filter on the left pane to add Prompts for criteria as needed.

**Note:** In scheduled category, the drill down details displays data for all categories for that particular day. The Manager and the Employees are in the same Time Zone. Current Time would be converted to Manager Time Zone and displayed both as text and the current time indicator.

The green bar represents the regular time. The gaps in between two bars indicate a meal break. Along with the Punch time reporters, the supervisor can also view the elapsed time reporters. There is a warning icon to highlight the employees in the no show category.

## Common Elements Used In the Workforce Availability

<b>Element</b>	<b>Definition</b>
<b>View By</b>	<p>Drop down list where you select Daily Time or Weekly Time.</p> <p><i>Daily Time</i> : See a comprehensive view of team's availability for the day.</p> <p><i>Weekly Time</i>:: View the availability and the schedule coverage of team members for the week and as the week progresses.</p> <p>Manager can choose any date through the date picker and also be able to navigate back and forth using the Previous and Next day buttons on the <b>date header</b></p>
 <b>Filter</b>	Navigates to the filter modal where you can specify the employee population.
 Refresh	Refresh the window with the updated data.
 Sort	Click this icon to change the sort order of team members. You can sort by any field shown.
	Click to see the detailed view related to the particular employee.
	Select to go to the related actions menu.
<b>Scheduled</b>	Shows the scheduled time in hours.
<b>Reported</b>	Shows the reported time in hours.

This example illustrates the fields and controls on the Workforce Availability page for the smartphone.

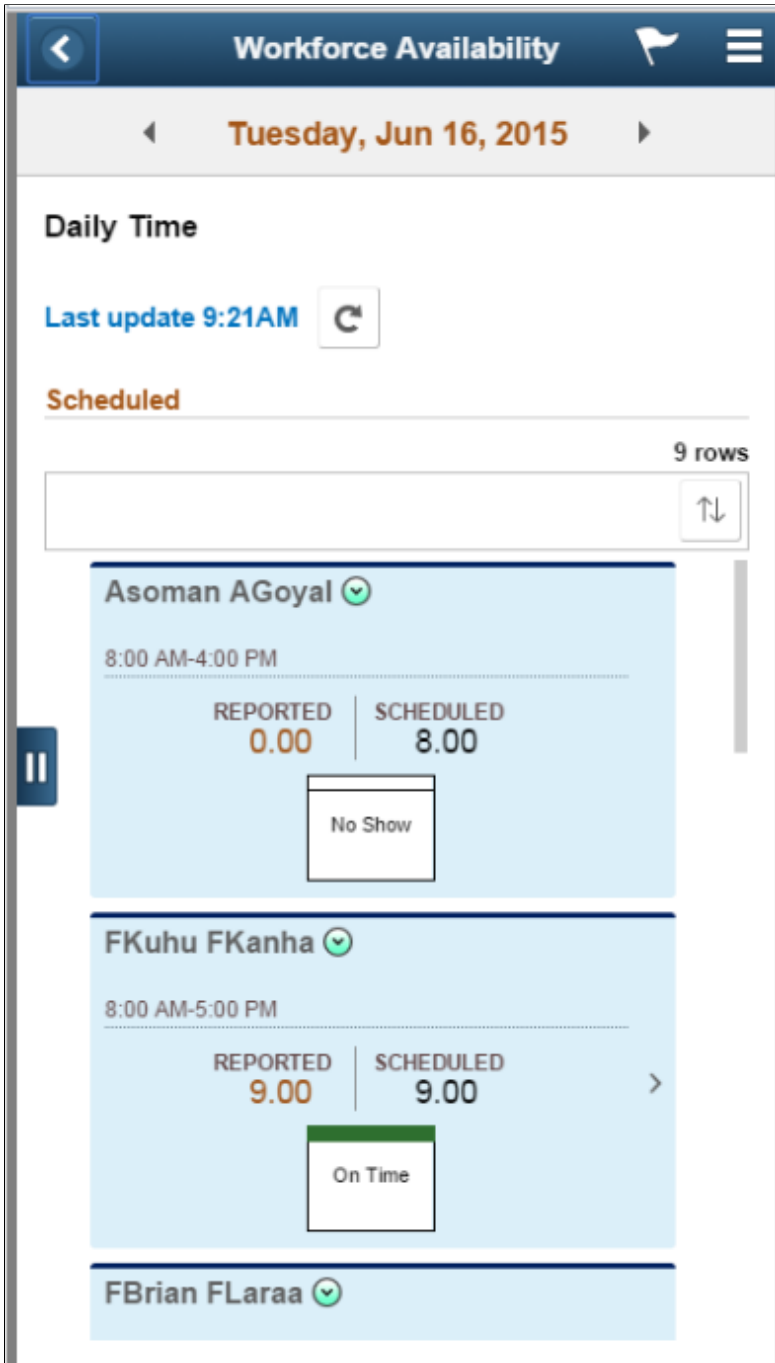

The category specific details represented in the form of boxes in the smartphone. Each category has generic text that appears in a box with a pattern corresponding to the particular category.

<b>Field or Control</b>	<b>Description</b>
	Shows the detailed information on the schedule details.

## Scheduled Daily Page

Use the Workforce Availability Scheduled daily page (TL\_EMP\_PRES\_FLU) to view the snapshot of all categories. Manager can view the punch and Elapsed employees who are scheduled to work for the specified week. Only Employees assigned with schedules would be considered.

Navigation:

Select the **Team Time** tile on the **Manager Self Service** fluid home page, and then select **Workforce Availability** on the **Team Time** page.

Click on the related actions to get the Actions panel.

This example illustrates the fields and controls on the Related Actions panel.

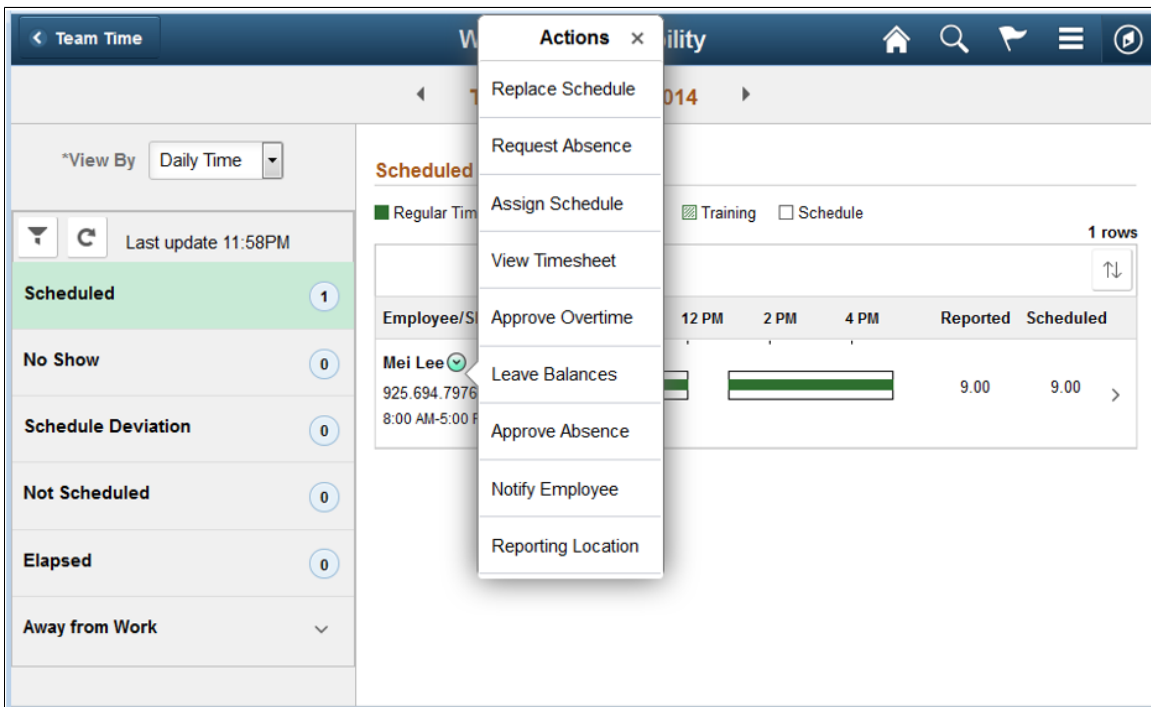

<b>Field or Control</b>	<b>Description</b>
<b>Replace Schedule</b>	Select to launch the Replace Schedule page to access the schedule for replacements and to do the necessary actions for replacements and send notifications.
<b>Request Absence</b>	Select to launch the Assign Work Schedule page to access the time reporter data to schedule and assign it to a particular employee.
<b>View Timesheet</b>	Select to launch the Timesheet page to access the reported time entries, approve pending reported time, payable time and absences.

<b>Field or Control</b>	<b>Description</b>
<b>Approve Overtime</b>	Select to launch Approve overtime requests page to access the employee selection criteria.
<b>Leave Balances</b>	Select to launch Leave and Compensatory Time to access the related selection criteria.
<b>Approve Absence</b>	Select to launch Approve Absence summary page to do the related action and to approve absences.
<b>Notify Employee</b>	Select to launch HR Notification page to send notifications.
<b>Reporting Locations</b>	Select to launch Reporting Locations page and view the physical location from where the employee has entered their time. The physical location is captured and stored as a latitude and longitude.

Tap on the **Reporting Locations** options to launch the [Reporting Locations Page](#)

**Note:** The Reporting Locations option is available only for Daily view.

For setting up the reporting locations, refer [Configurations Page](#) in the Time and Labor Installation Page.

## No Show Daily Pages

Use the No Show category daily page to view the details of the employees who are scheduled to work but haven't reported time, in absence or in training. This category displays employees who are scheduled to work also.

Navigation:

On the **Workforce Availability** page, Select **No Show** on the left panel.

This example illustrates the fields and controls on the No Show daily page.

**Workforce Availability**

Tuesday, Jun 16, 2015

\*View By: Daily Time

Last update 5:21AM

**No Show**

Regular Time Schedule Deviation Training Schedule

3 rows

Employee/Shift	8 AM	10 AM	12 PM	2 PM	4 PM	Reported	Scheduled
Asoman AGoyal 8:00 AM-4:00 PM						0.00	8.00
HRajnish HRoshan 8:00 AM-5:00 PM						0.00	9.00
HNargis HJena 8:00 AM-5:00 PM						0.00	9.00

This example illustrates the fields and controls on the No Show daily page of the smartphone.

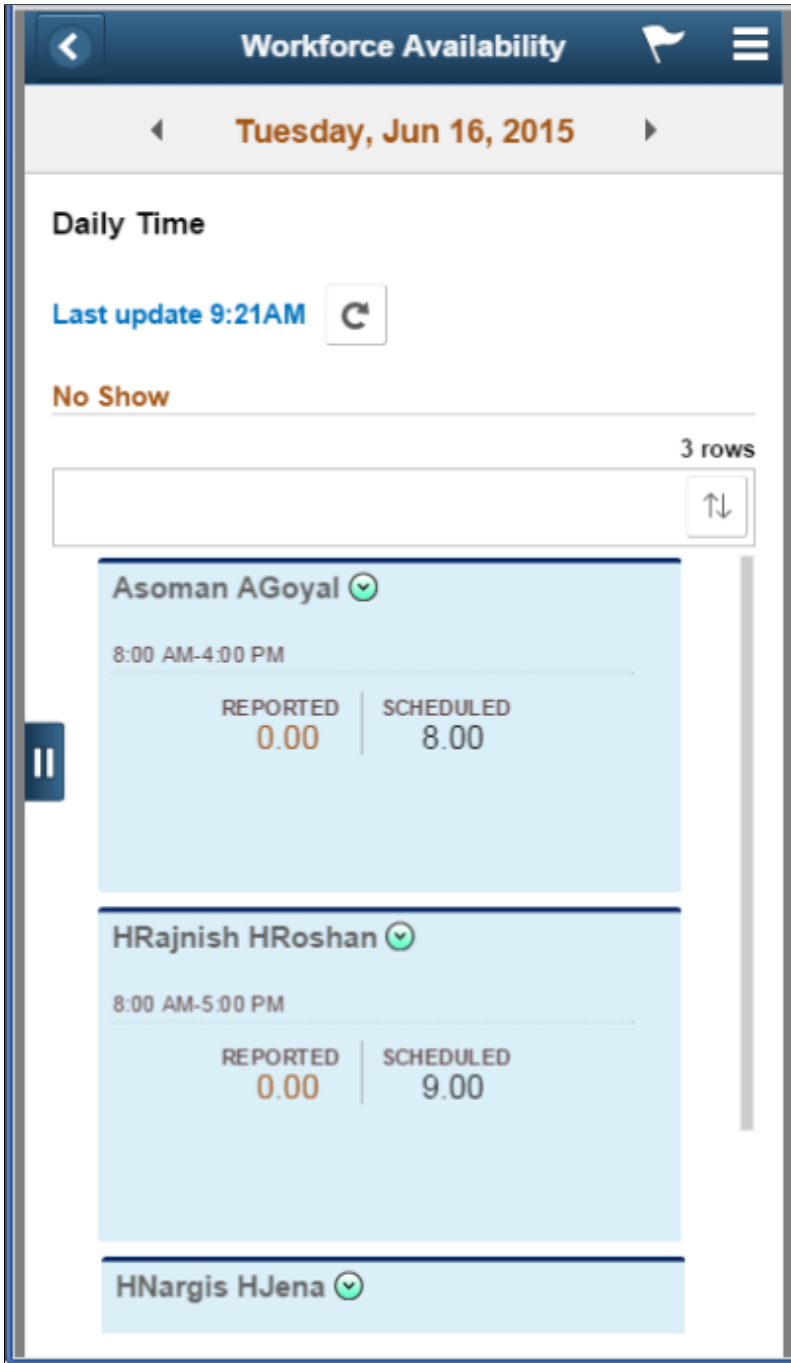

No Show status displays when the schedule for the employee has begun and the employee has not reported to work. For punch time reporters, there is no drill-down and visual representation.

**Note:** If an employee has reported absence which is in denied/pushed back status, it should show up in no show category. Elapsed reporters are not part of **No show** and **Schedule deviation** categories.

## Schedule Deviation Daily Pages

Use Schedule Deviation category to view the count and the details of the employees who have deviated from the schedule.

Navigation:

On the **Workforce Availability** page, select **Schedule Deviation** on the left panel.

This example illustrates the fields and controls on the Schedule Deviation daily page of the tablet.

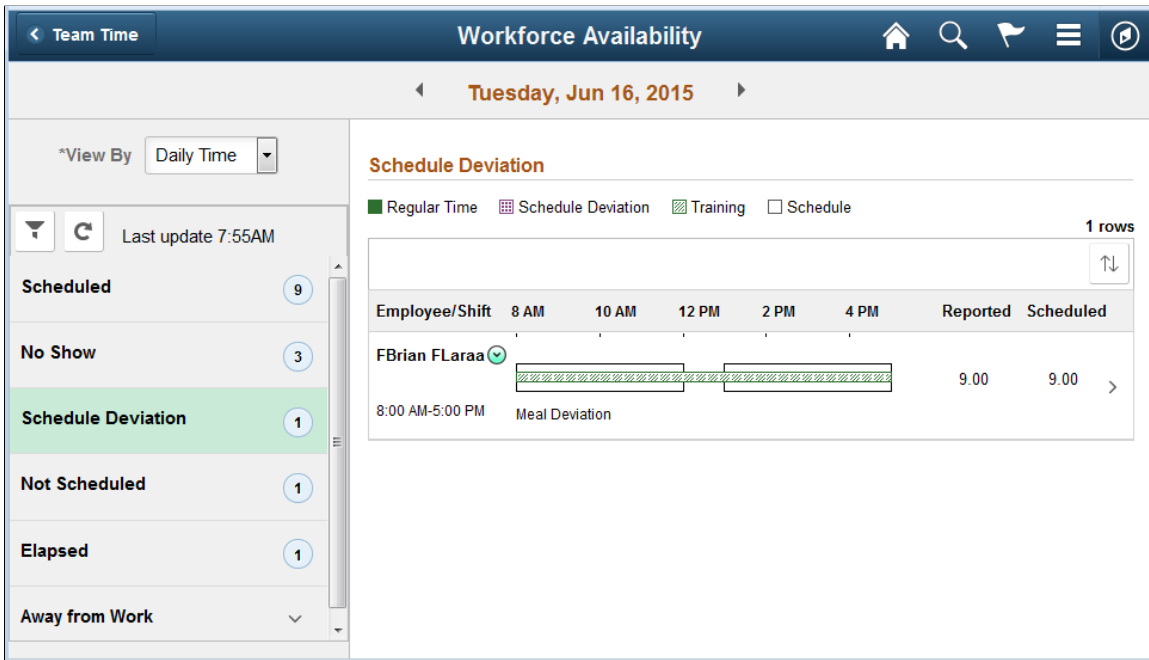

The Drill down for **Schedule Deviation** does not list the time off details means other than deviation data no other category data will be displayed in the drill down.



The modal shows the Drill down Details.

**Schedule Deviation** ✕

**FBrian FLaraa**  
ST - Filing Clerk

**▼ Schedule Details**

Punch Type	Scheduled Time	Reported Time
In	8:00 AM	8:00 AM
Meal	12:00 PM	
In	1:00 PM	
Out	5:00 PM	5:00 PM

This example illustrates the fields and controls on the (Smartphone) Schedule Deviation daily page of the smartphone.

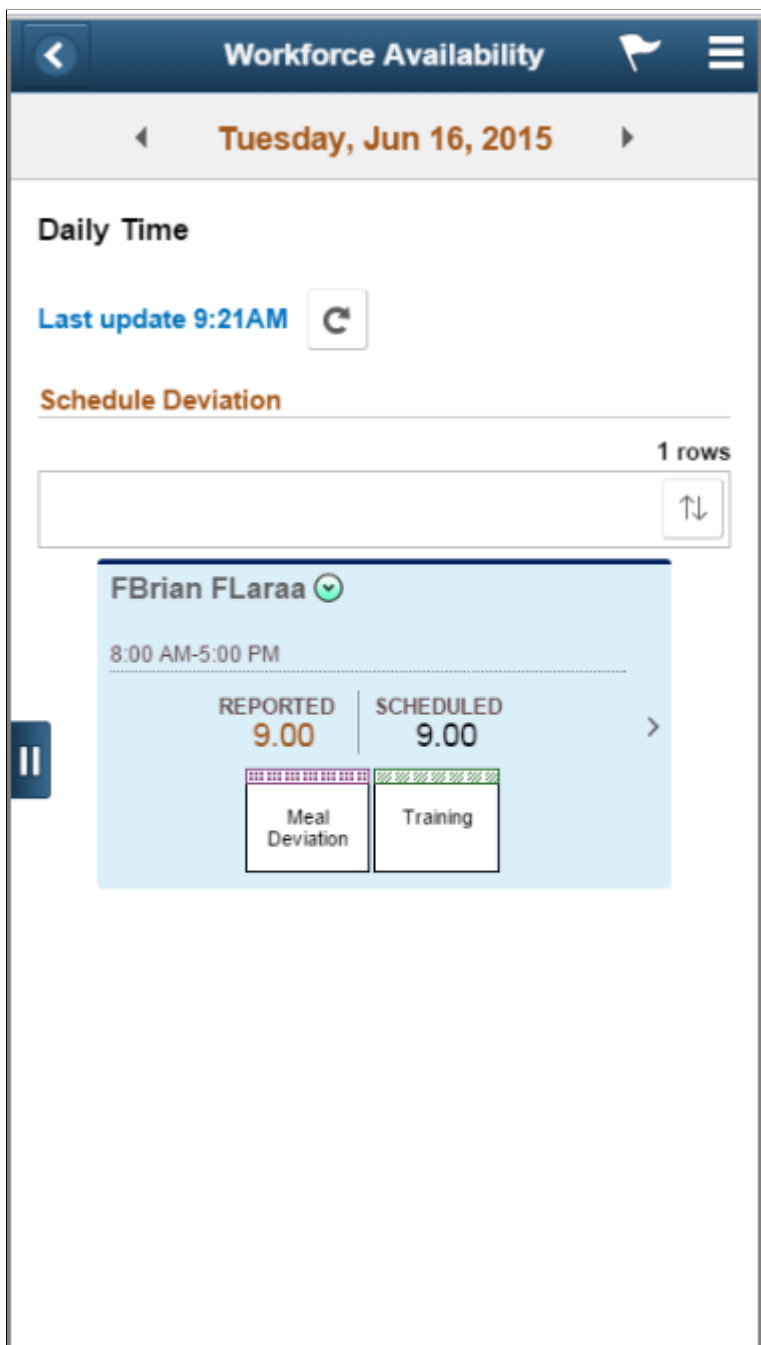

The grid in the smartphone displays the deviation for specific reasons. If there is more than one deviation, the grid displays the latest deviation reason. The grid represents additional status like time off or training as per the employee status. This category is not applicable for an elapsed reporter in smartphone. The manager can view the data in graphical representation from each day with specific reason for different type of deviation. The valid deviation reasons are Early In, Early Out, Late In and Late Out and Meal Deviation.

**Note:** This category displays even when the count is Zero. The detail page displays a message 'No data available.'

## Not Scheduled Daily Page

Use Not Schedule daily page to view the count and details of employees who report to a manager or within the hierarchy but do not have a schedule time, or on off or on holiday.

Navigation:

On the **Workforce Availability** page, Select **Not Scheduled** on the left panel.

This example illustrates the fields and controls on the Not Scheduled daily page.

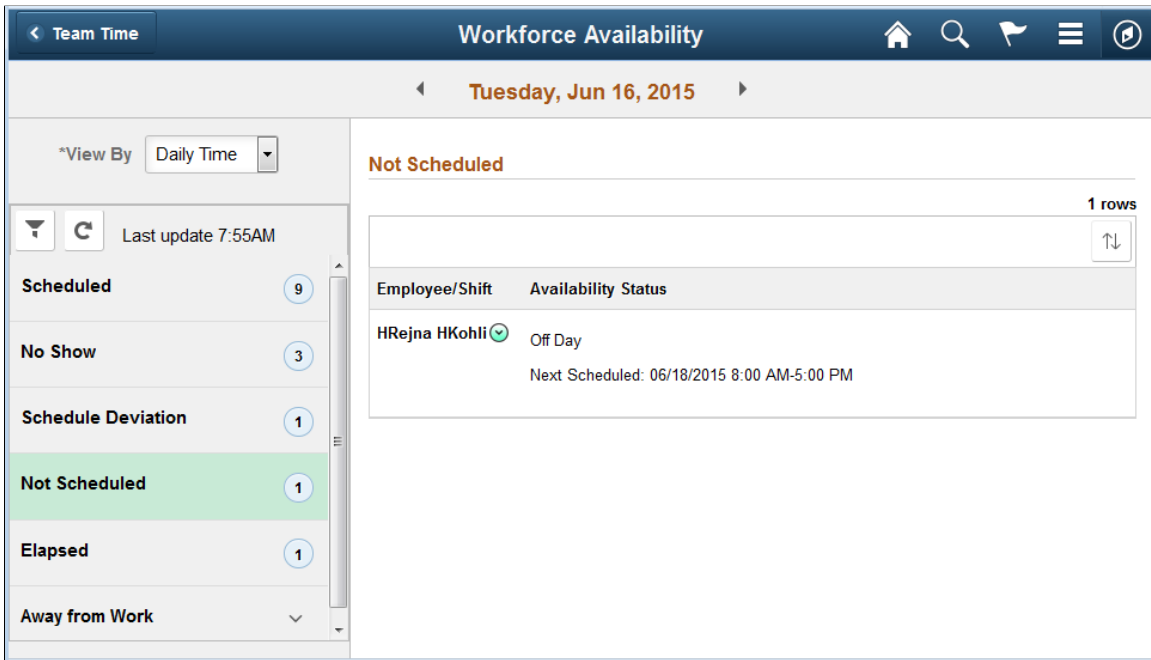

This example illustrates the fields and controls on the Not Scheduled daily page on smartphone.

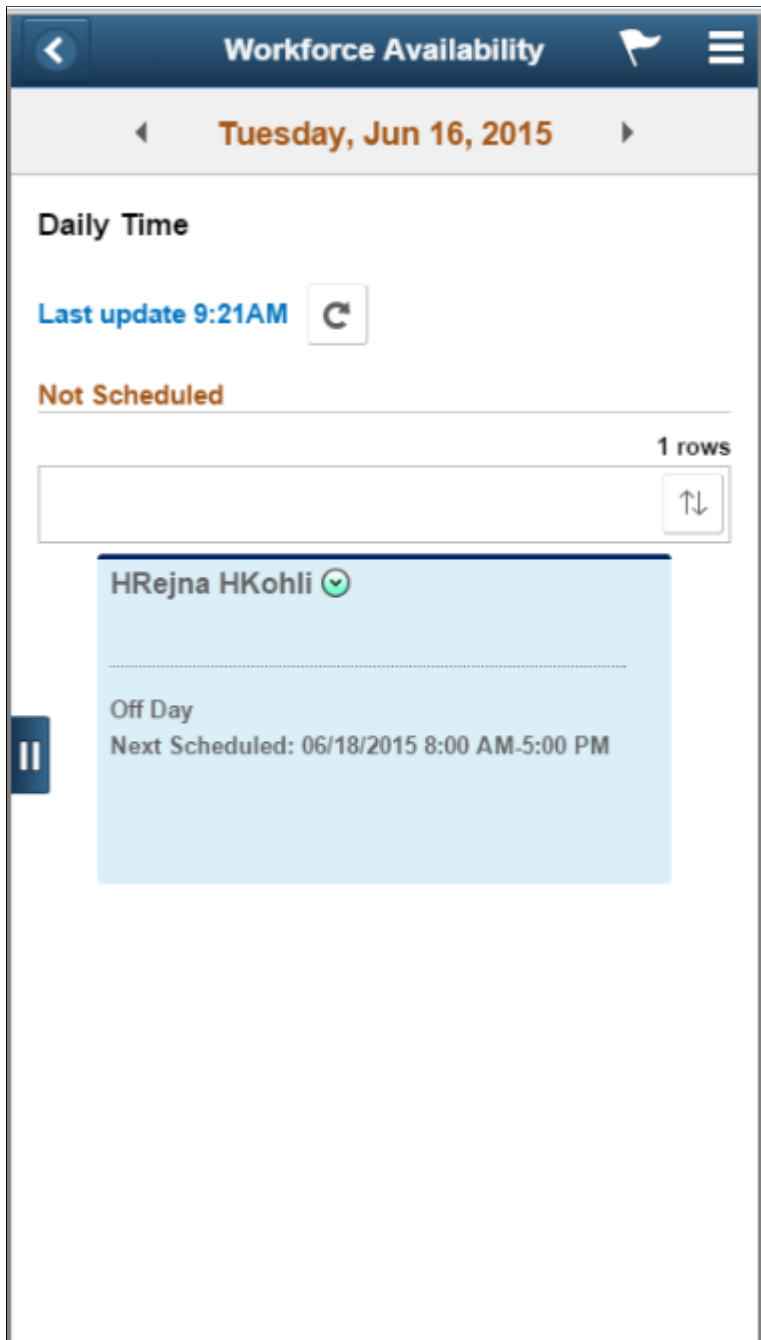

## Elapsed Daily Page

Use the Elapsed daily page to view the count and details of the elapsed employees who have reported time.

Navigation:

On the **Workforce Availability** page, Select **Elapsed** on the left panel.

This example illustrates the fields and controls on the Elapsed daily page.

The screenshot shows the 'Workforce Availability' page for 'Tuesday, Jun 16, 2015'. The left sidebar contains a list of categories: Scheduled (9), No Show (3), Schedule Deviation (1), Not Scheduled (1), Elapsed (1), and Away from Work. The 'Elapsed' category is highlighted in green. The main content area shows a table with the following data:

Employee	Reported	Scheduled
HRajlata HSri	8.00	8.00

**Note:** There is no representation using widgets for the Elapsed and Not Scheduled categories.

This example illustrates the fields and controls on the (Smartphone) Elapsed daily page.

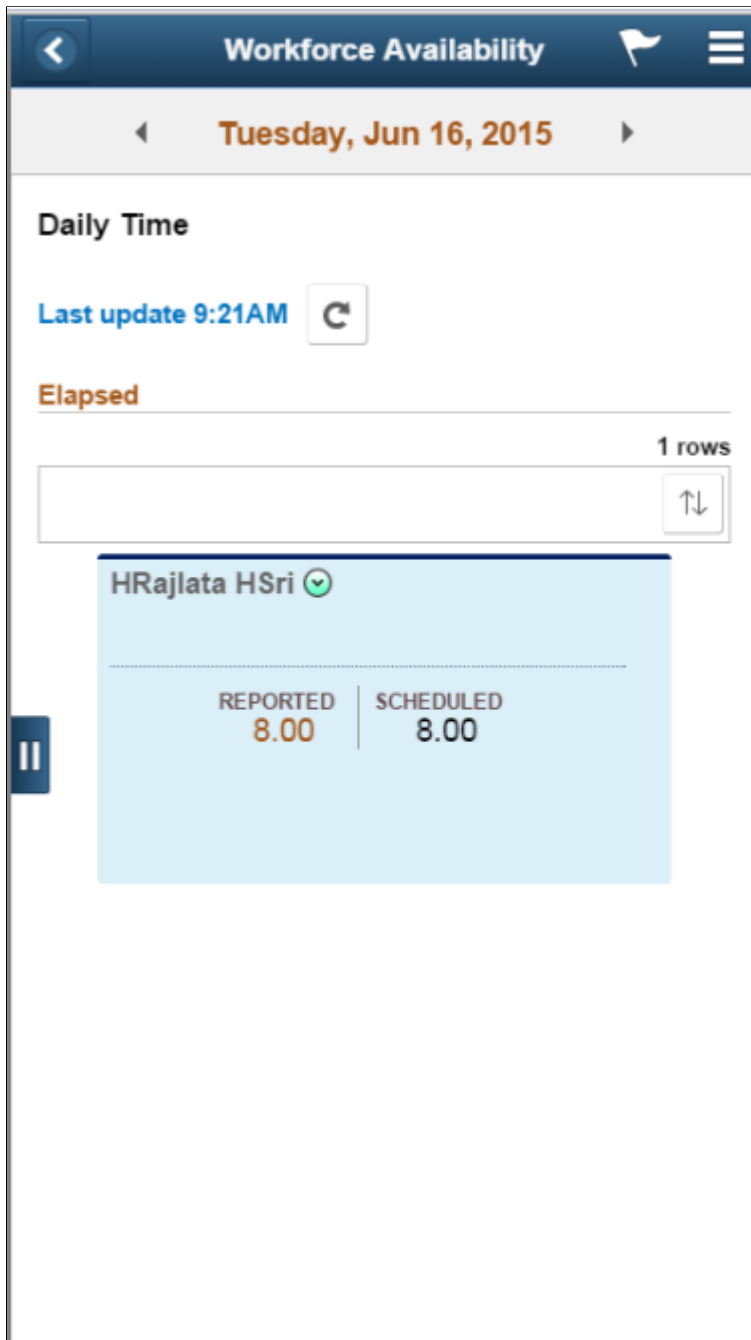

## Away From Work Daily Category

The expanded view of **Away From Work** shows the sub categories.

## Unapproved Absence Daily Page

Use Unapproved Absence daily page to view the count and details of the employees who have any unapproved absences or leave plans.

Navigation:

On the **Workforce Availability** page, Select the **Unapproved Absence** on the left panel.

This example illustrates the fields and controls on the Unapproved Absence daily page.

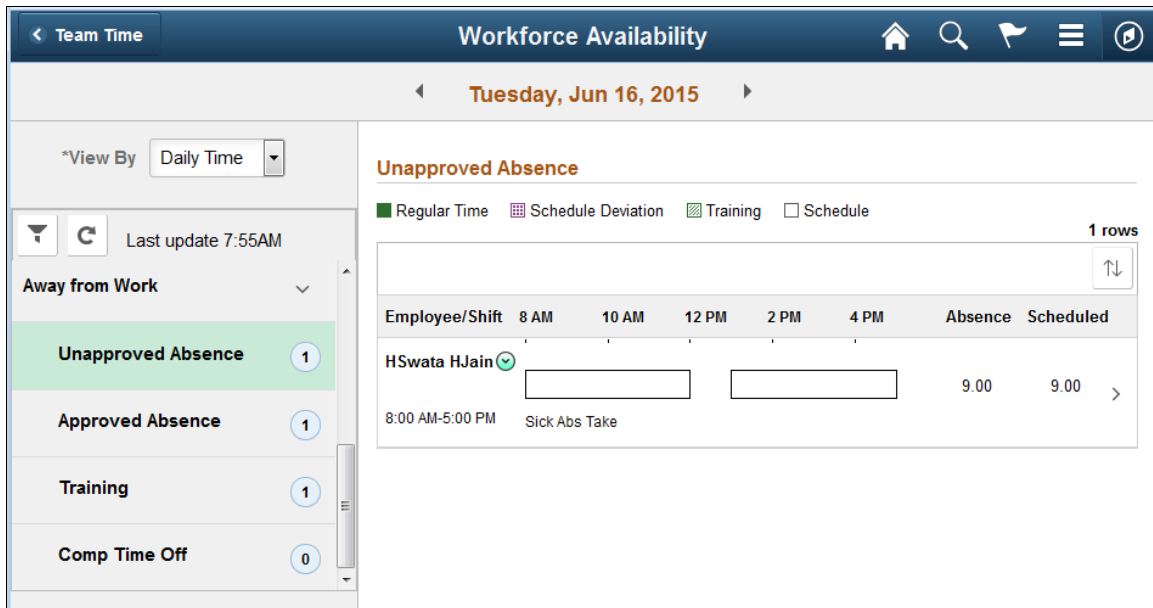

There are no patterns to represent the Unapproved Absence, Approved Absence and the Comp Time off. For these categories, there is an only schedule representation.

Click on the user to go to the drill-down modal window. The drill down shows the absence details.

This example illustrates the fields and controls on the Unapproved Absence drill down.

### Unapproved Absence ×

**HSwata HJain**  
ST - Filing Clerk

▼ **Absence Details**

Absence Name	Duration	Balance	As of Date
Sick Abs Take	9.00	0.00	



This example illustrates the fields and controls on the Unapproved Absence daily page for the smartphone.

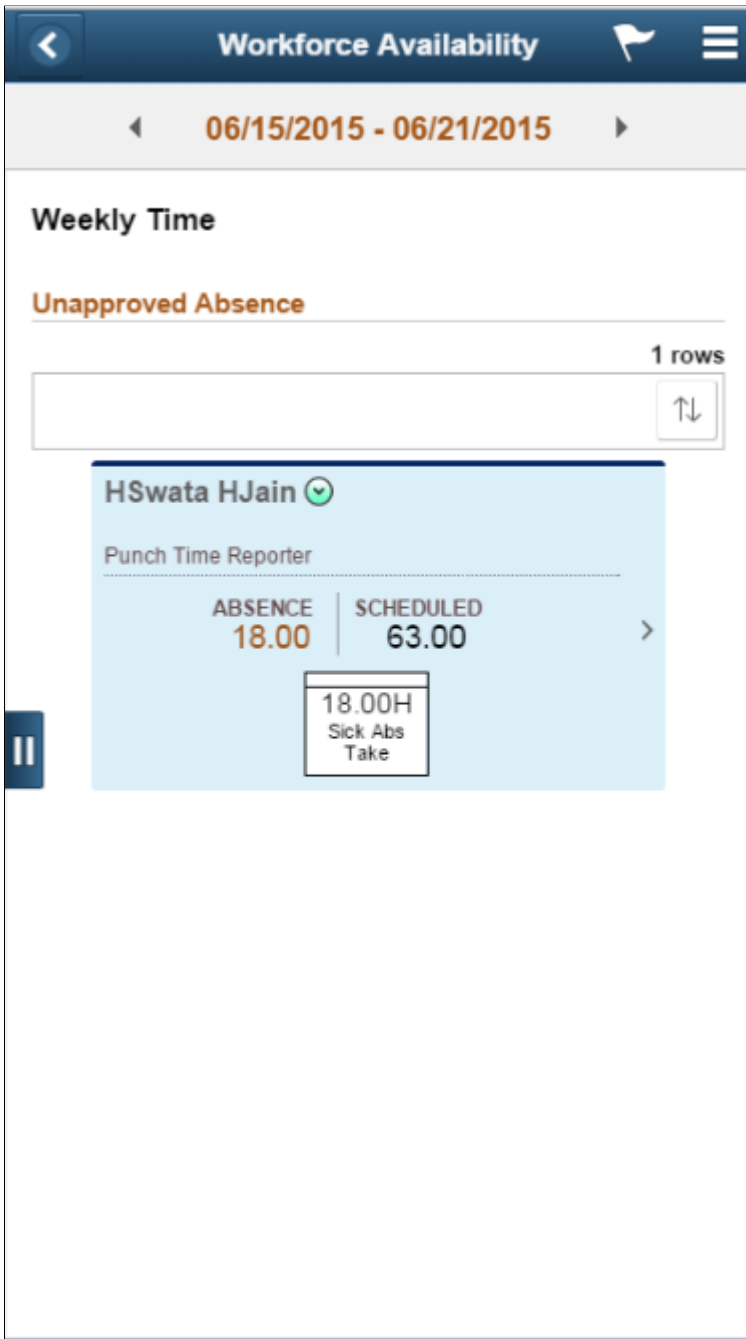

Click on **Drop down** icon to go to the related actions menu, which list the related action for unapproved absence category.

## Approved Absence Daily Page

Use Approved Absence daily page to view the count and details of the employees who have any approved absences or leave plans.

Navigation:

On the **Workforce Availability** page, select the **Approved Absence** on the left panel.

This example illustrates the fields and controls on the Approved Absence daily page.

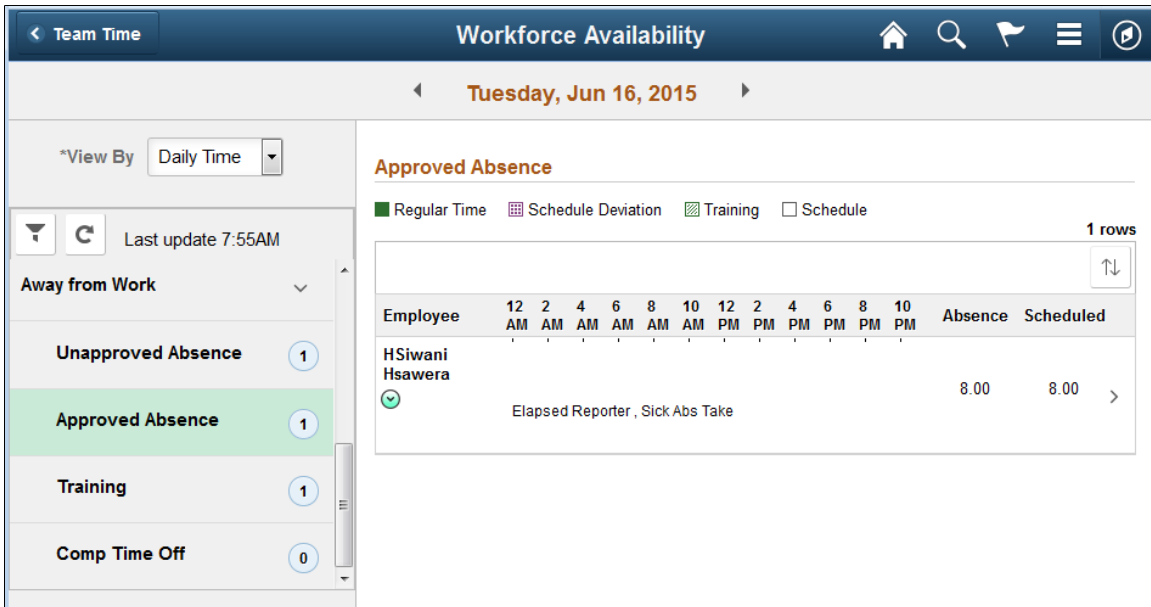

Click on the user to go to the drill-down modal window. The drill down shows the absence details.

This example illustrates the fields and controls on the Approved Absence drill down.

**Approved Absence** ×

**HSiwani Hsawera**  
ST - Filing Clerk

▼ **Absence Details**

Absence Name	Duration	Balance	As of Date
Sick Abs Take	8.00	0.00	

This example illustrates the fields and controls on the Approved Absence daily page for the smartphone.

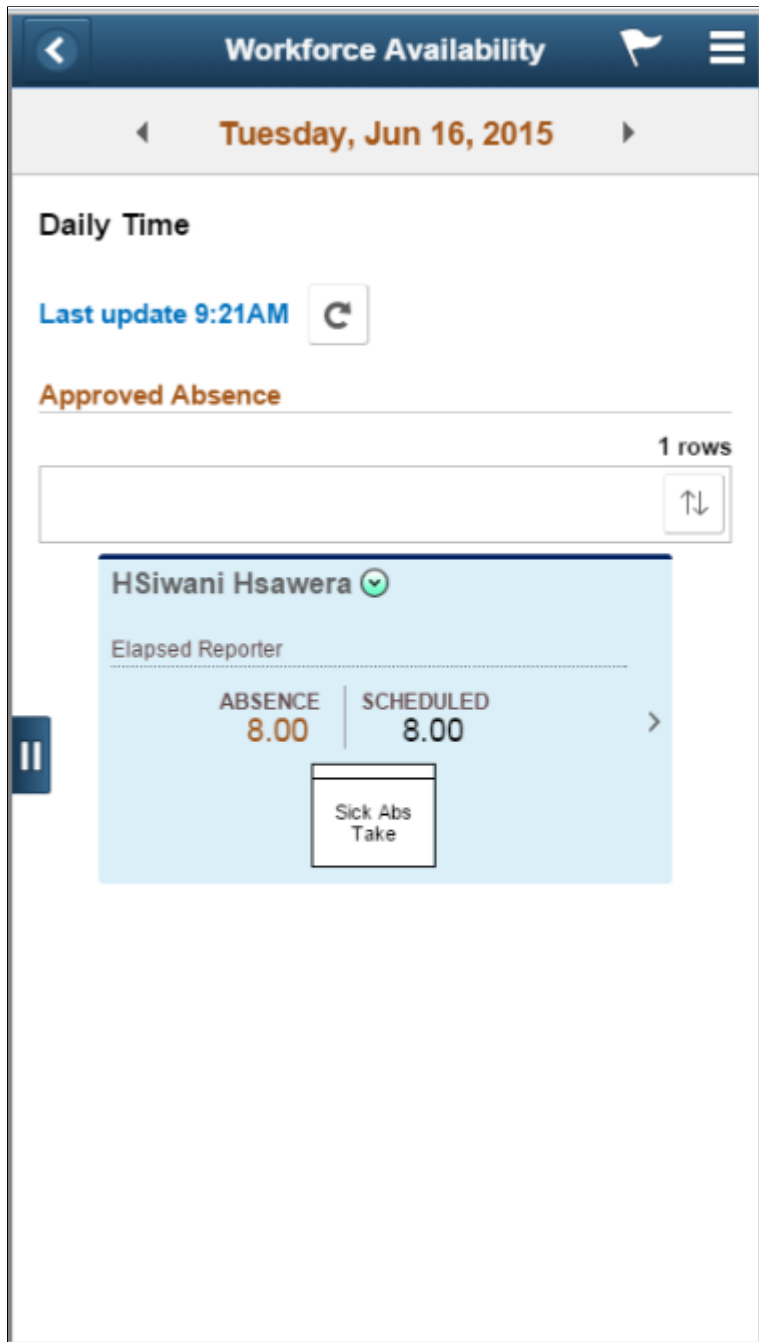

Tap on **Drop down** icon to go to the related actions menu, which list the related action for approved absence category.

## Training Daily Page

Use Training daily page to view the count and details of employees who have enrolled for HR/ELM Training in the left panel.

Navigation:

On the **Workforce Availability** page, select the **Training** on the left panel.

This example illustrates the fields and controls on the Training daily page.

The screenshot shows the 'Workforce Availability' page for 'Tuesday, Jun 16, 2015'. The left sidebar contains a navigation menu with the following items:

- Away from Work
- Unapproved Absence (1)
- Approved Absence (1)
- Training (1)**
- Comp Time Off (0)

The main content area is titled 'Training' and includes a legend: Regular Time (green square), Schedule Deviation (purple square), Training (hatched square), and Schedule (white square). Below the legend is a table with the following data:

Employee/Shift	8 AM	10 AM	12 PM	2 PM	4 PM	Training	Scheduled
FBrian FLaraa		[Training Block]		[Training Block]		9.00	9.00

The training blocks are represented by hatched rectangles. The 'Training' column shows a value of 9.00, and the 'Scheduled' column shows a value of 9.00. The employee's shift is listed as '8:00 AM-5:00 PM'.

This example illustrates the fields and controls on the Training daily page for the smartphone.

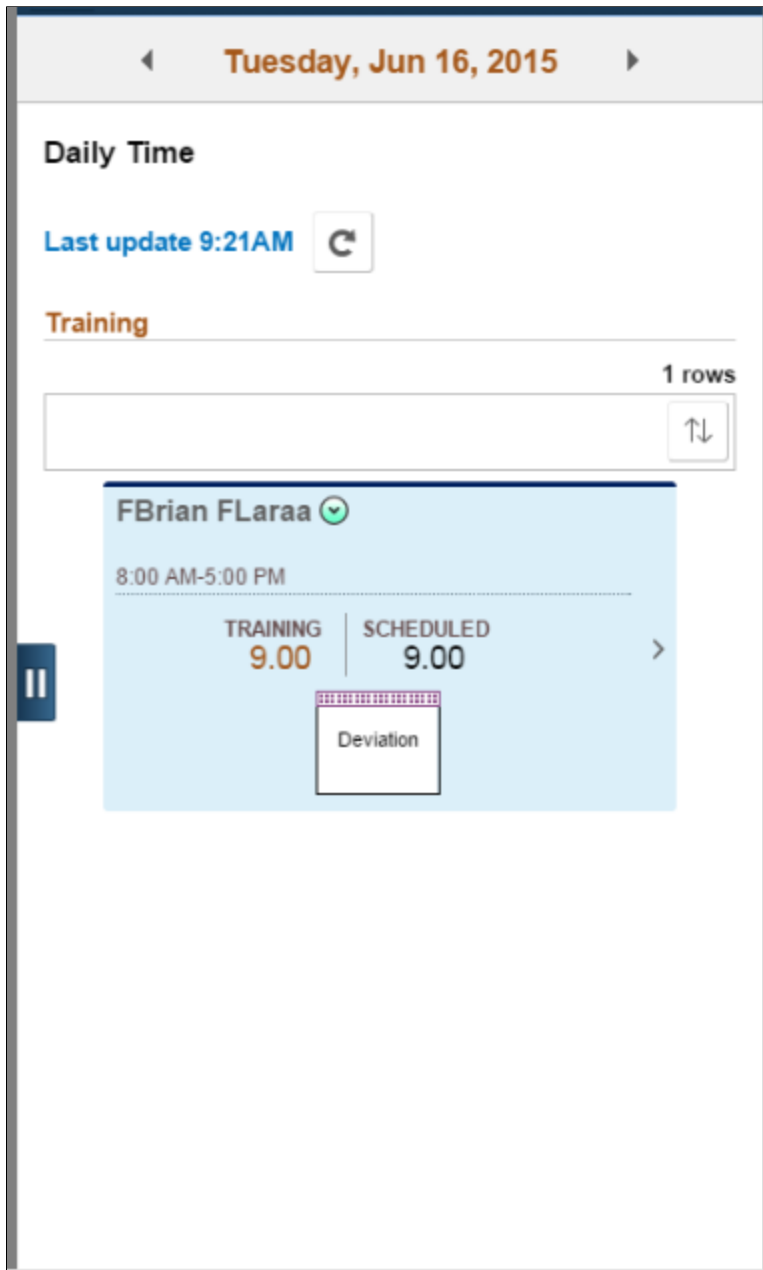

Tap on **Drop down** icon to go to the related actions menu, which list the related action for approved absence category.

## Comp Time Off Page

Use Comp Time Off daily page to can view the count and details of employees who are out on compensatory time off.

Navigation:

On the **Workforce Availability** page, select the **Comp Time Off** on the left panel.

This example illustrates the fields and controls on the Comp Time Off daily page.

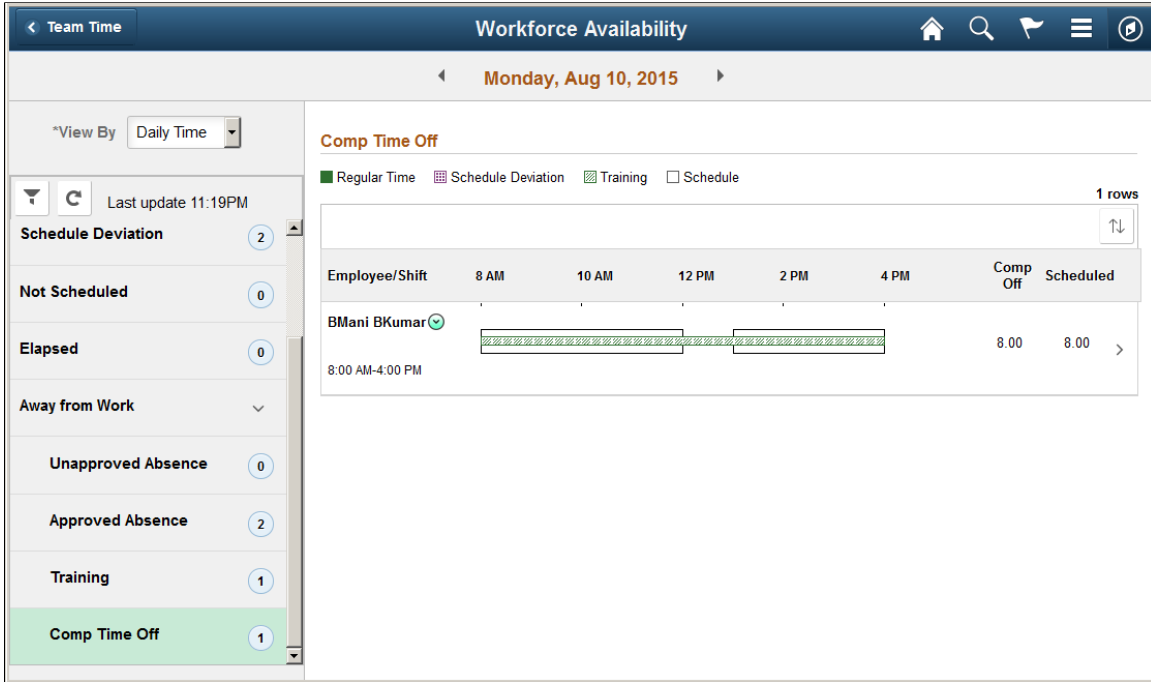

The widgets display for other categories, if they exist under Comp Time off category. It represents in a widget form if there is more than one status exist for a day.

Click on the user to go to the drill-down modal window.

The modal represents the drill down details of Comp time.

### Comp Time Off ×

**Kai MacKenzie**  
Billing Specialist  
313 9654600

▼ **Comp Time Off Details**

Plan Description	Duration	Balance	As of Date
No Limit Pos/Never Expire	8.00	17.00	11/17/2015



This example illustrates the fields and controls on the Comp Time Off daily page for the smartphone.

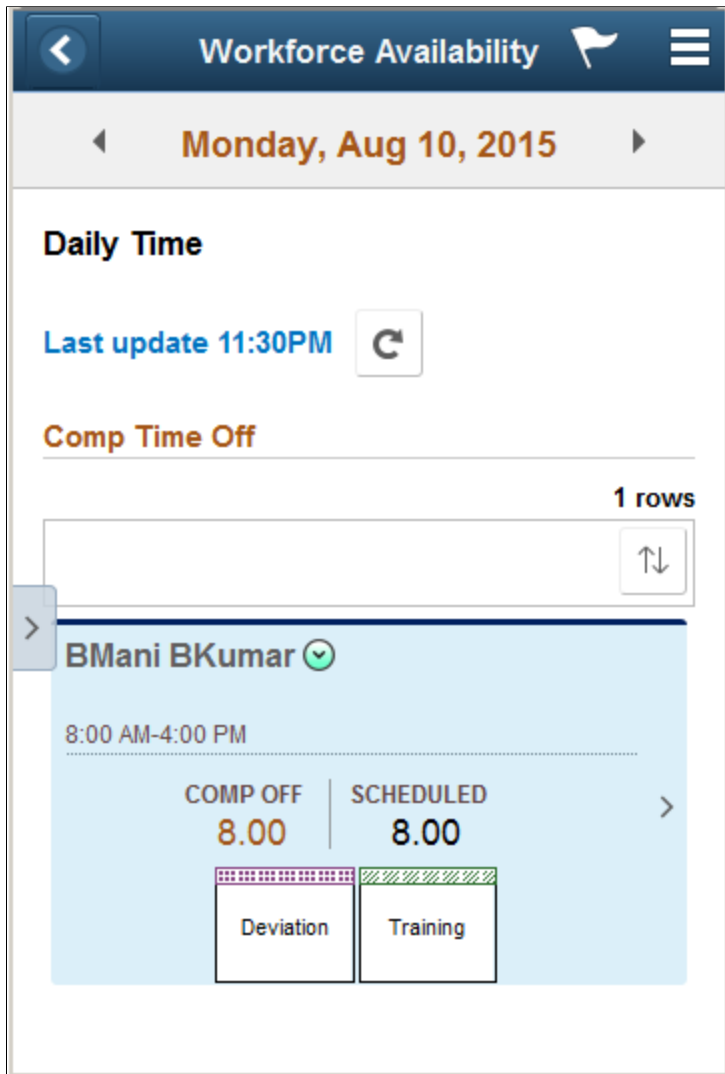

Tap on **Drop down** icon to go to the related actions menu, which list the related action for approved absence category.

The Elapsed scheduled text is displayed on the details area for Elapsed Time reporters, whereas the schedule is displayed below the widget for Punch Time reporters.

## Weekly Time Views

Weekly Time enables the Manager to view the availability of team members for the week, so that managers can forecast coverage or see the actual coverage versus the scheduled coverage.

## Workforce Availability - Scheduled Weekly Page

Use Workforce Availability – Scheduled Weekly page (TL\_EP\_WEEKLY\_FLU) to view the categories and the employee scheduled to work for the respective week.

Manager can view the punch and elapsed employees who are scheduled to work for the specified week. The employees who are assigned with schedules are considered here.

Navigation:

On the **Workforce Availability** page, select *Weekly Time* in the **View By** field.

This example illustrates the fields and controls on the Schedule Weekly page.

The screenshot shows the 'Workforce Availability' page for the week of 06/15/2015 to 06/21/2015. The 'View By' is set to 'Weekly Time'. A 'Schedule Variance' indicator shows 77.09%. Summary statistics are: Scheduled 502.00, Reported 115.00, Variance 387.00. The main table lists employees with their schedules for each day of the week, categorized by Regular Time, Schedule Deviation, Training, Schedule, and Time Off. The table also shows Reported and Scheduled hours for each employee.

Employee/Shift	Monday	Tuesday	Wednesday	Thursday	Friday	Saturday	Sunday	Reported	Scheduled
Asoman AGoyal								0.00	40.00
FKuhu FKanha								9.00	63.00
FBrian FLaraa	Training	Deviation, Training	Training	Training	Training	Training	Training	72.00	63.00
HSwata HJain		Time Off	Time Off					18.00	63.00
HNargis HJena								0.00	45.00
HRejna HKohli								0.00	45.00

Field or Control	Description
	<p>Review the total scheduled, reported hours and variation percentage for the whole group.</p> <ul style="list-style-type: none"> <li><b>Scheduled:</b> Total scheduled hours for the entire population.</li> <li><b>Reported:</b> Total reported hours for the entire population (including all categories like absences and training).</li> <li><b>Variance:</b> The difference scheduled and reported population.</li> </ul> <p>Schedule variance is calculated as <math>\text{variance} / \text{scheduled} * 100</math>.</p>
<b>Scheduled</b>	Displays the count of all the employees data captured in other categories except Not Scheduled category for the respective week.

<b>Field or Control</b>	<b>Description</b>
<b>Schedule Deviation</b>	Displays the count of employees who have violated on the entries above the tolerance time as set in the Installation configuration.
<b>Away From Work</b>	Expand to display the categories Unapproved, Approved and Training are listed under Away From Work.
<b>Employee / Shift</b>	Displays the name and phone number and shift of the employee.
<b>Reported</b>	Shows the reported time in hours.
<b>Scheduled</b>	Shows the scheduled time in hours.

Click on **Drop down** icon to go to the related actions menu, which list the related action for approved absence category.

This example illustrates the fields and controls on the Related actions common to all Weekly categories.

The screenshot shows the 'Availability' page for 06/21/2015. The page includes a navigation bar with 'Back', 'Home', 'Search', and 'Menu' icons. Below the navigation bar, there is a 'View By' dropdown set to 'Weekly Time' and a 'Last update' timestamp of 8:51AM. The main content area displays a table of employee availability for the date 06/21/2015. The table has columns for 'Employee/Shift', 'Wednesday', 'Thursday', 'Friday', 'Saturday', 'Sunday', 'Reported', and 'Scheduled'. An 'Actions' menu is open over the table, listing the following actions: Replace Schedule, Assign Schedule, View Timesheet, Approve Overtime, Leave Balances, Approve Absence, and Notify Employee. The table data is as follows:

Employee/Shift	Wednesday	Thursday	Friday	Saturday	Sunday	Reported	Scheduled
Asoman AGoyal Punch Time Reporter						0.00	40.00
FKuhu FKanha Punch Time Reporter						9.00	63.00
FBrian FLaraa Punch Time Reporter	Training	Deviation, Training	Training	Training	Training	Training	72.00
HSwata HJain Punch Time Reporter		Time Off	Time Off			18.00	63.00
HNargis HJena Punch Time Reporter						0.00	45.00
HRejna HKohli Punch Time Reporter						0.00	45.00

<b>Field or Control</b>	<b>Description</b>
<b>Replace Schedule</b>	Select to launch the Schedule Replacements page to access the schedule for replacements and do the necessary actions for replacements and send notifications.
<b>Request Absence</b>	Select to launch Absence Requests page to do the related action related to absence requests.
<b>Assign Schedule</b>	Select to launch the Assign Work Schedule page to access the time reporter data to a schedule.
<b>View Timesheet</b>	Select to launch the Timesheet page to access the reported time entries.
<b>Approve Overtime</b>	Select to launch Approve overtime requests page to access the employee selection criteria.
<b>Leave Balances</b>	Select to launch Leave and Compensatory Time to access the related selection criteria.
<b>Approve Absence</b>	Select to launch Approve Absence summary page to do the related action related to approve absences.
<b>Notify Employee</b>	Select to launch HR Notification page to send notifications.
<b>Reporting Location</b>	Select to launch Reporting Locations page and view the physical location from where the employee has entered their time. The physical location is captured and stored as a latitude and longitude.

Click on the user to go to the drill-down modal window.

This example illustrates shows the Scheduled weekly detailed view.

Scheduled
×

**Dan Atwood**  
Financial Analyst

▼ **Schedule Details**

---

**Tuesday, Jul 26**

Punch Type	Scheduled Time	Reported Time
In	8:00 AM	8:15 AM
Meal	12:00 PM	12:00 PM
In	1:00 PM	1:00 PM
Out	5:00 PM	5:00 PM

**Wednesday, Jul 27**

Punch Type	Scheduled Time	Reported Time
In	8:00 AM	8:00 AM
Meal	12:00 PM	12:00 PM
In	1:00 PM	1:00 PM
Out	5:00 PM	5:00 PM

▼ **Approved Absence**

Date	Absence Name	Duration
Monday, Jul 25	Sick	8.00

**Balance Information**

Absence Name	As of Date	Balance
Sick	06/25/2016	32.00

This example illustrates the Scheduled weekly time view in smartphone.

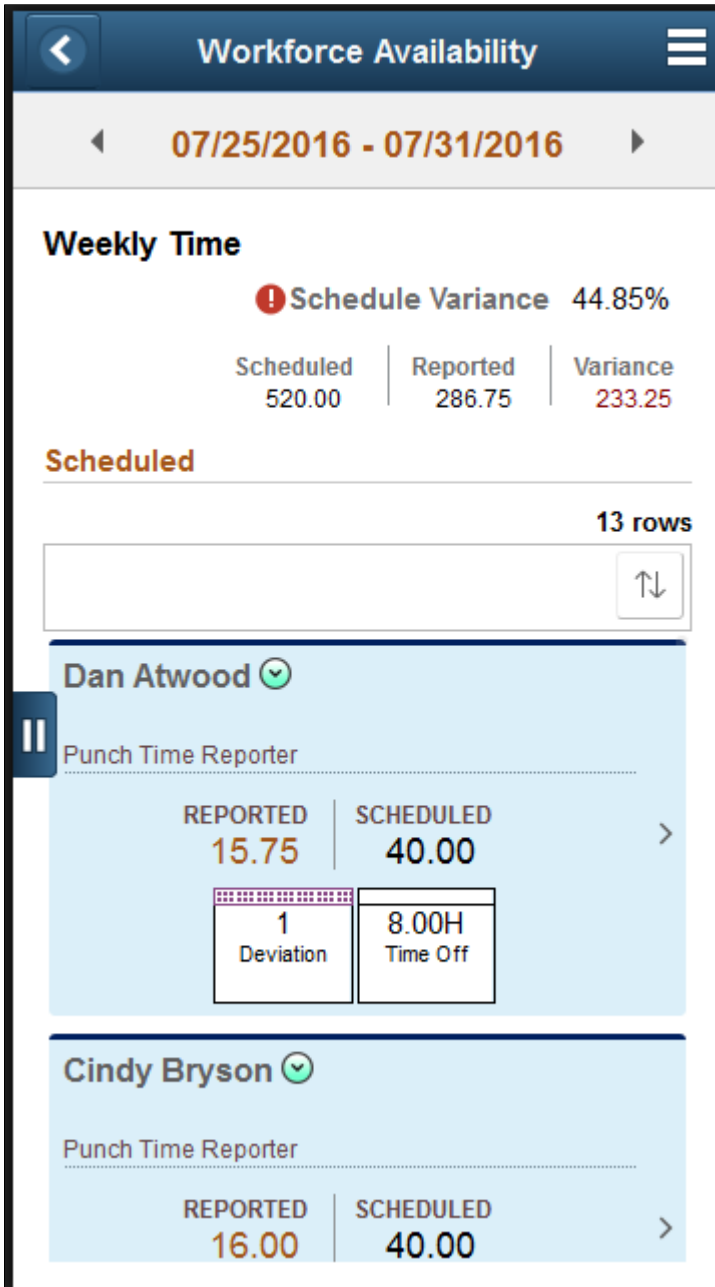

### Schedule Deviation Weekly Page

Use Schedule Deviation weekly page to view the count and the details of the employees who have deviated from the schedule for a week.

Navigation:

On the **Workforce Availability** page, select the **Schedule Deviation** on the left panel.

This example illustrates the fields and controls on the Schedule Deviation Weekly Page.

**Workforce Availability**

07/25/2016 - 07/31/2016

\*View By Weekly Time

Last update 10:06PM

**Schedule Deviation**

Regular Time
  Schedule Deviation
  Training
  Schedule
  Time Off

4 rows

Employee	Monday	Tuesday	Wednesday	Thursday	Friday	Saturday	Sunday	Reported	Scheduled
<b>Dan Atwood</b> Punch Time Reporter Late In	Time Off	Schedule Deviation	Regular Time	Schedule	Schedule			23.75	40.00
<b>Michael Miranda</b> Punch Time Reporter Early Out	Schedule Deviation	Regular Time	Regular Time	Schedule	Schedule			22.00	40.00
<b>John Russak</b> 609/555-2222 Punch Time Reporter Late In	Schedule Deviation	Regular Time	Regular Time	Schedule	Schedule			22.00	40.00
<b>Janice Worthington</b> 609/555-4567 Punch Time Reporter Early Out	Schedule Deviation	Regular Time	Regular Time	Schedule	Schedule			23.00	40.00

This example illustrates shows the Schedule Deviation weekly detailed view

Schedule Deviation			×
<b>Dan Atwood</b> Financial Analyst			
▼ <b>Schedule Details</b>			
<b>Tuesday, Jul 26</b>			
Punch Type	Scheduled Time	Reported Time	
In	8:00 AM	8:15 AM	
Meal	12:00 PM	12:00 PM	
In	1:00 PM	1:00 PM	
Out	5:00 PM	5:00 PM	



This example illustrates the fields and controls on the (Smartphone) Schedule Deviation Weekly Page.

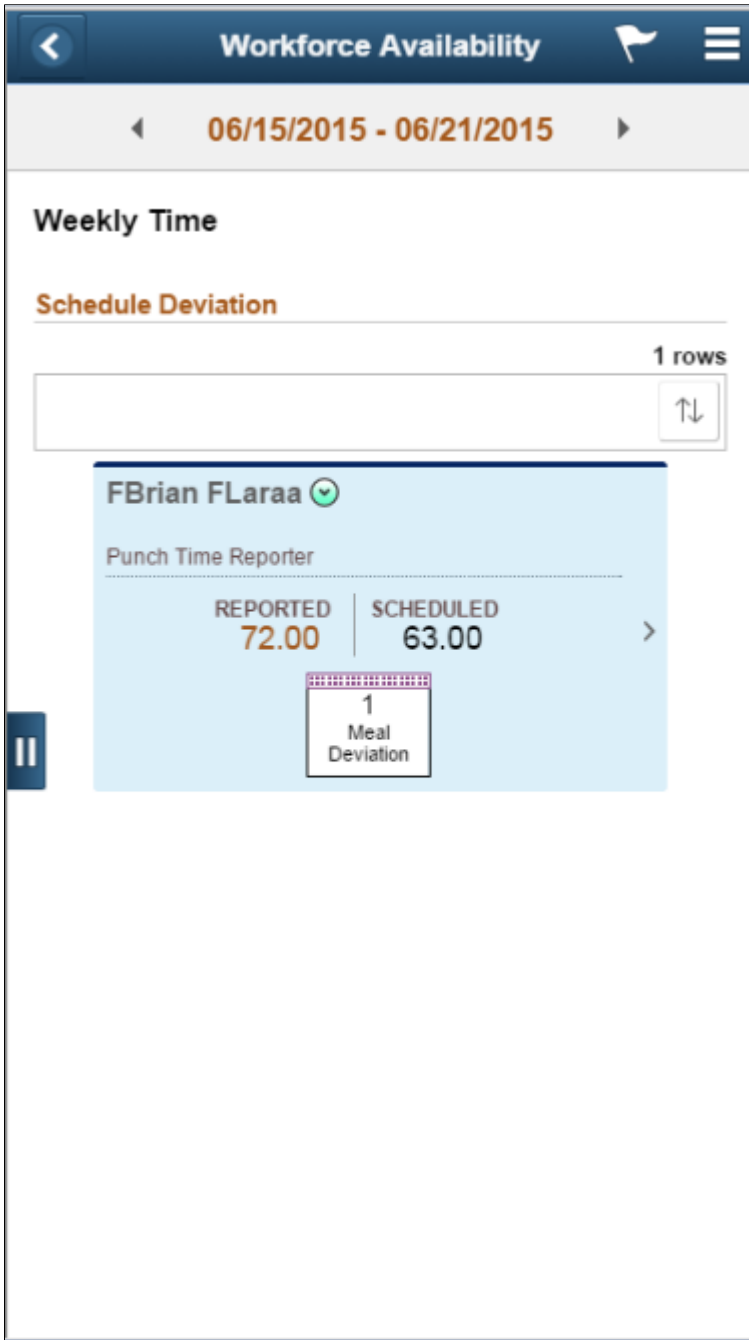

Tap on the employee to go to the drill down view.

### Away From Work Daily Category

The expanded view of **Away From Work** shows the sub categories.

## Unapproved Absence Weekly Page

Use Unapproved Absence weekly page to view the count and details of the employees who have any unapproved absences or leave plans.

Navigation:

On the **Workforce Availability** page, select *Weekly Time* in the **View By** field, then select the **Unapproved Absence** on the left panel.

This example illustrates the fields and controls on the Unapproved Absence weekly page.

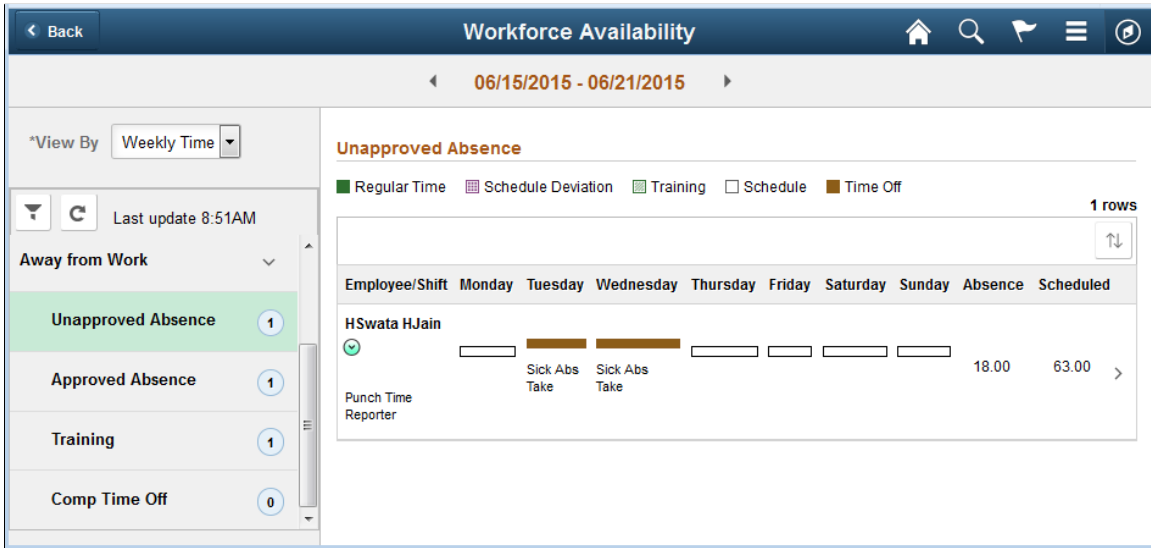

Click on the user to go to the drill-down modal window. The drill down shows the absence details.

This example illustrates the fields and controls on the Unapproved Absence weekly drill down

Unapproved Absence <span style="float: right;">×</span>		
<b>HSwata HJain</b> ST - Filing Clerk		
▼ <b>Absence Details</b>		
Date	Absence Name	Duration
Tuesday, Jun 16	Sick Abs Take	9.00
Wednesday, Jun 17	Sick Abs Take	9.00
<b>Balance Information</b>		
Absence Name	As of Date	Balance
Sick Abs Take		0.00

This example illustrates the fields and controls on the Unapproved Absence daily page for the smartphone.

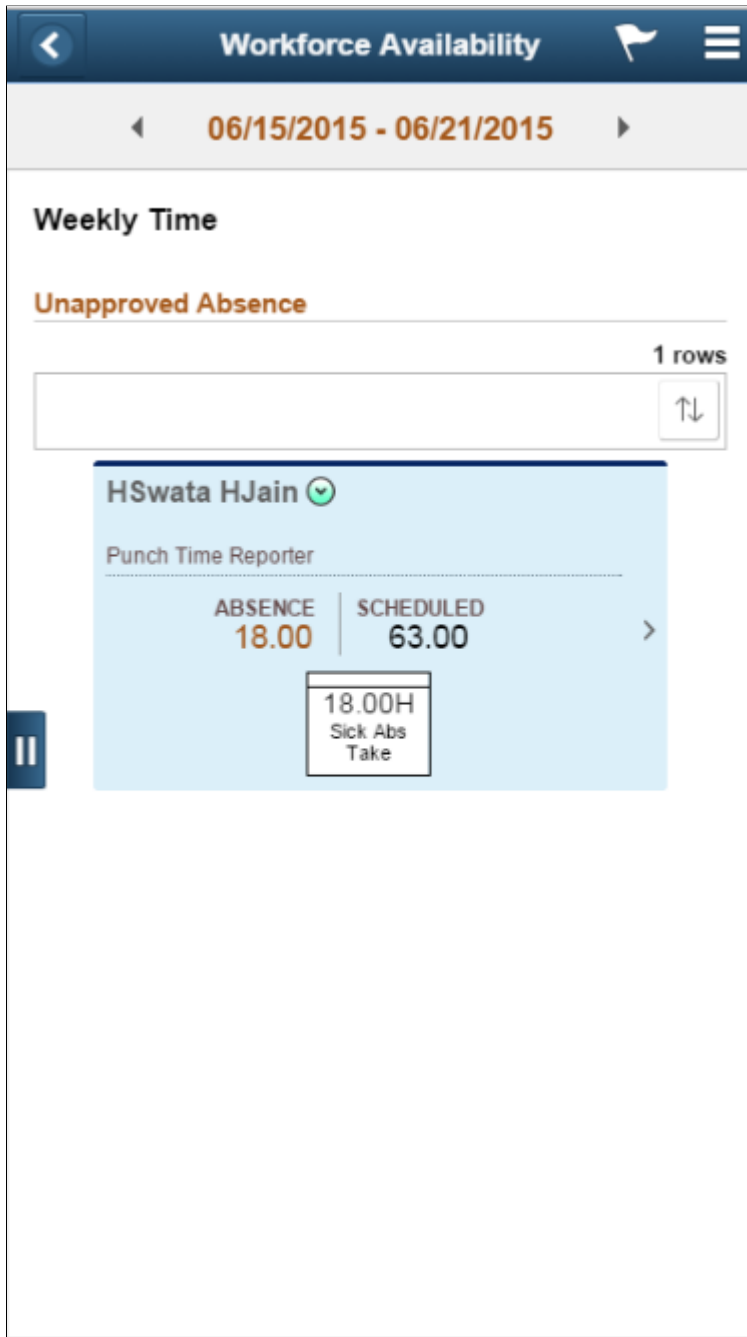

## Approved Absence Weekly Page

Use Approved Absence weekly page to view the count and details of the employees who have any approved absences or leave plans.

Navigation:

On the **Workforce Availability** page, select *Weekly Time* in the **View By** field and then select *Approved Absence* on the left panel.

This example illustrates the fields and controls on the Approved Absence weekly page.

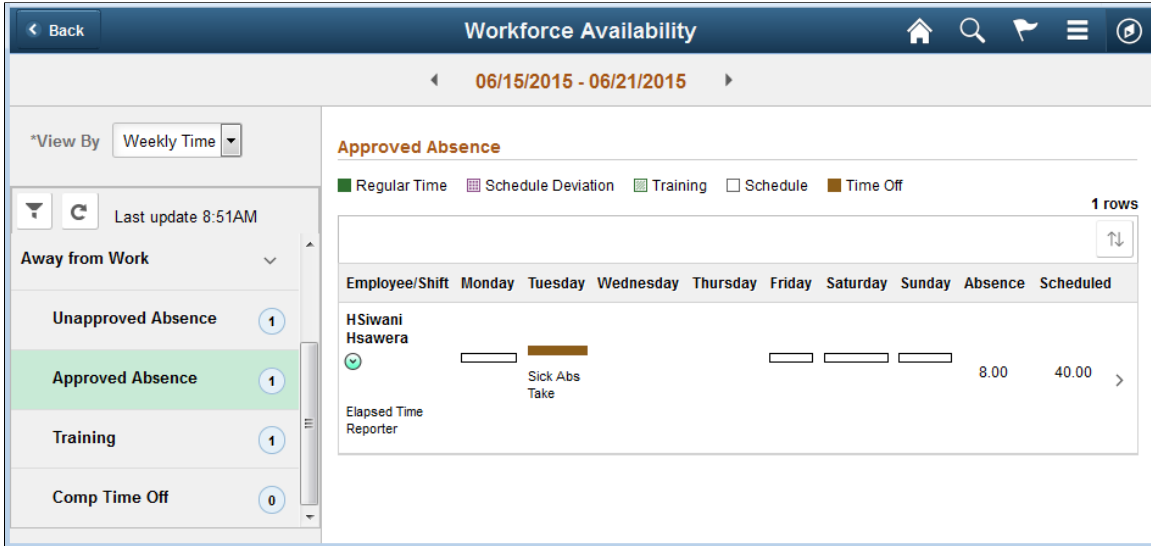

Click on the user to go to the drill-down modal window. The drill down displays the absence hours in the form of Duration/ Balance.

This example illustrates the fields and controls on the Approved Absence weekly Page drill down

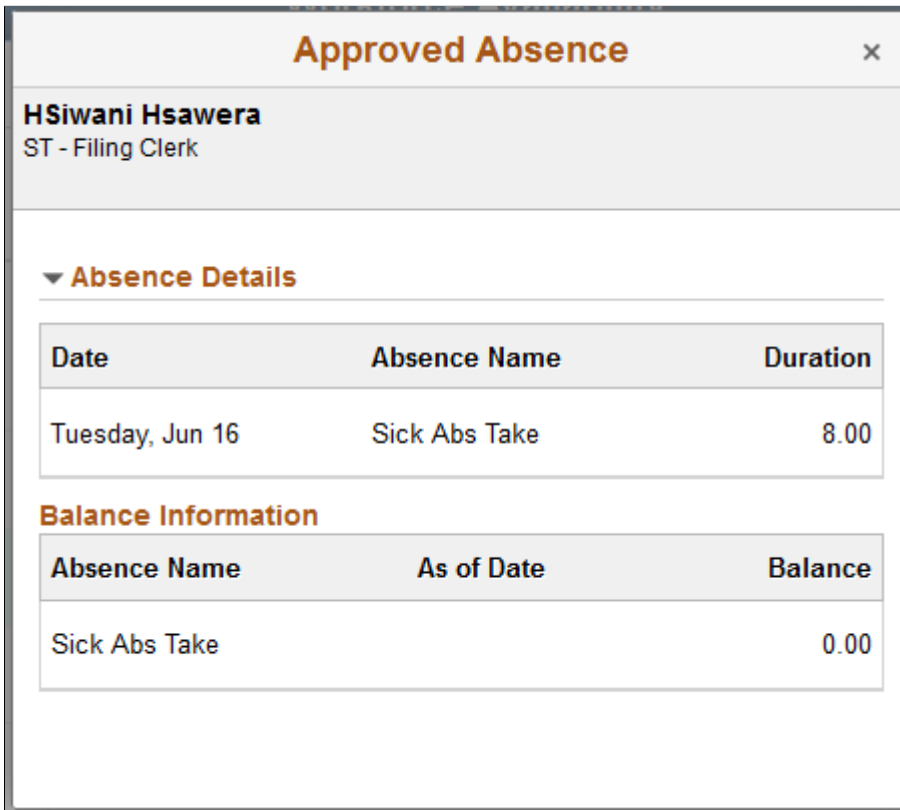

This example illustrates the fields and controls on the Approved Absence daily page for the smartphone.

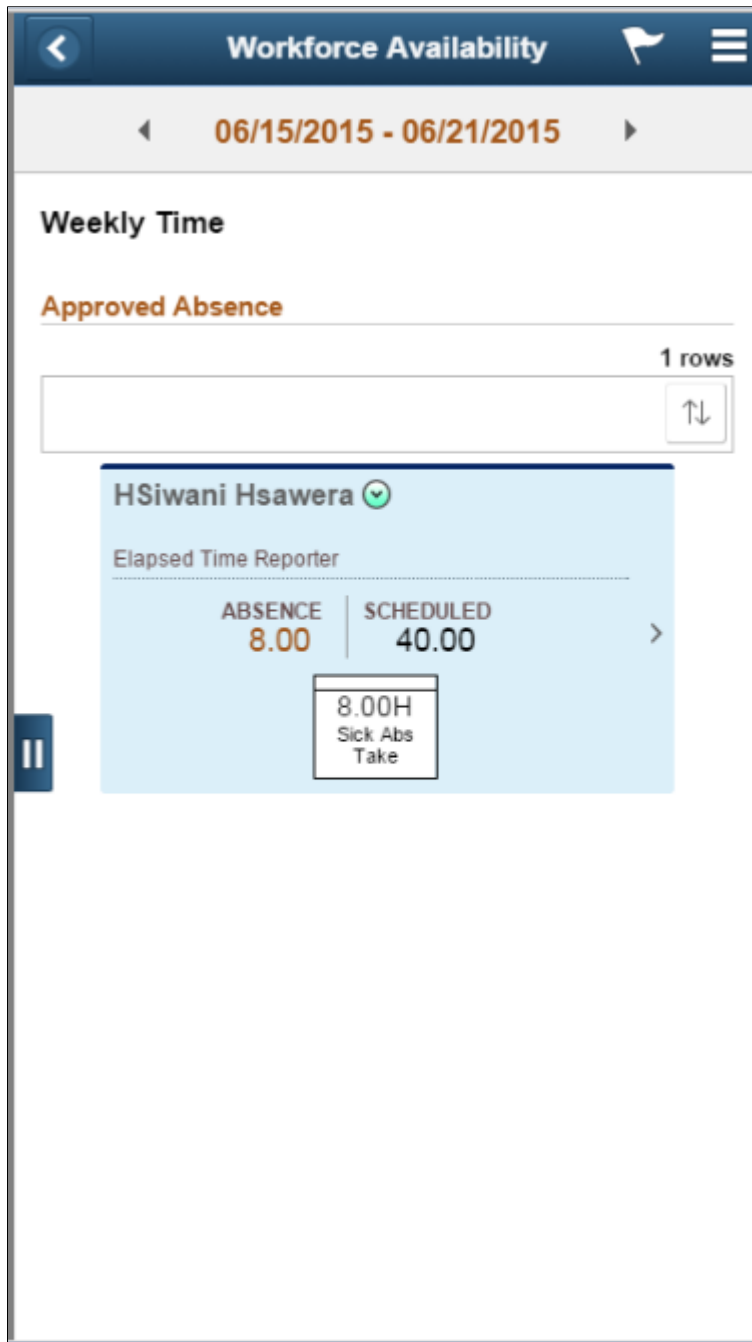

Tap on **Drop down** icon to go to the related actions menu, which list the related action for approved absence category.

## Training Weekly Page

Use Training weekly page to track or review employees who are in training and its course details. The details display the total hours of training for a week.

Navigation:

On the **Workforce Availability** page, select *Weekly Time* in the **View By** field and then select *Training* on the left panel.

This example illustrates the fields and controls on the Training weekly page.

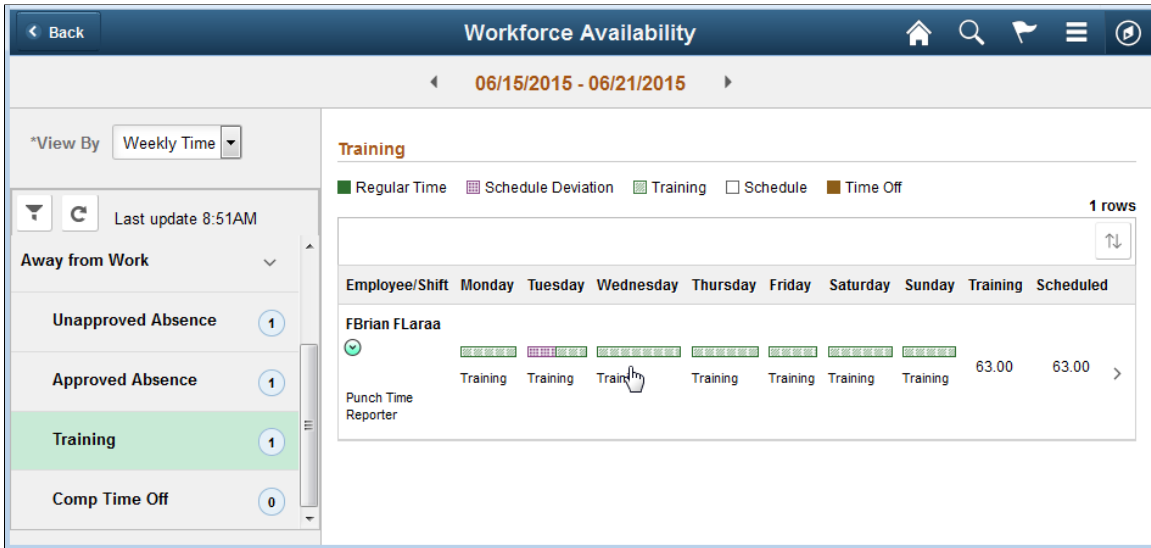

A specific pattern represents the training category.

Click on the user to go to the drill-down modal window. Drill down shows all the details for training for a week like the name of the training course, date and duration.

This example illustrates the fields and controls on the Training weekly drill down page.

### Training ×

**FBrian FLaraa**  
ST - Filing Clerk

▼ **Training Details**

---

Date Monday, Jun 15  
Course Mentoring Course  
Training Period 8:00 AM-5:00 PM

---

Date Tuesday, Jun 16  
Course Mentoring Course  
Training Period 8:00 AM-5:00 PM

---

Date Wednesday, Jun 17  
Course Mentoring Course  
Training Period 8:00 AM-5:00 PM

---

Date Thursday, Jun 18  
Course Mentoring Course  
Training Period 8:00 AM-5:00 PM



This example illustrates the fields and controls on the Training daily page for the smartphone.

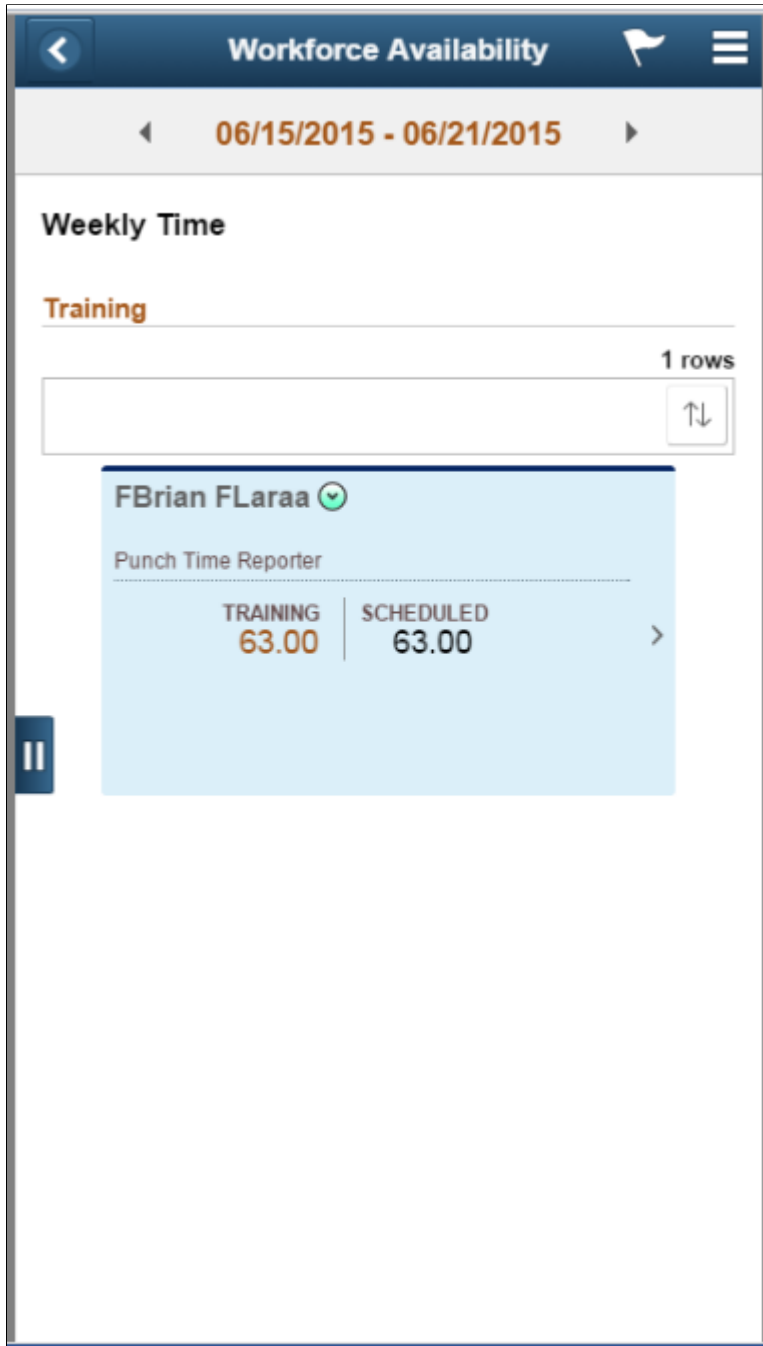

Tap on **Drop down** icon to go to the related actions menu, which list the related action for approved absence category.

### Comp Time Off Weekly Page

Use Comp Time Off daily page to can view the count and details of employees who are out on compensatory time off.

Navigation:

On the **Workforce Availability** page, select *Weekly Time* in the **View By** field and then select *Comp Time Off* on the left panel.

This example illustrates the fields and controls on the Comp Time Off weekly page.

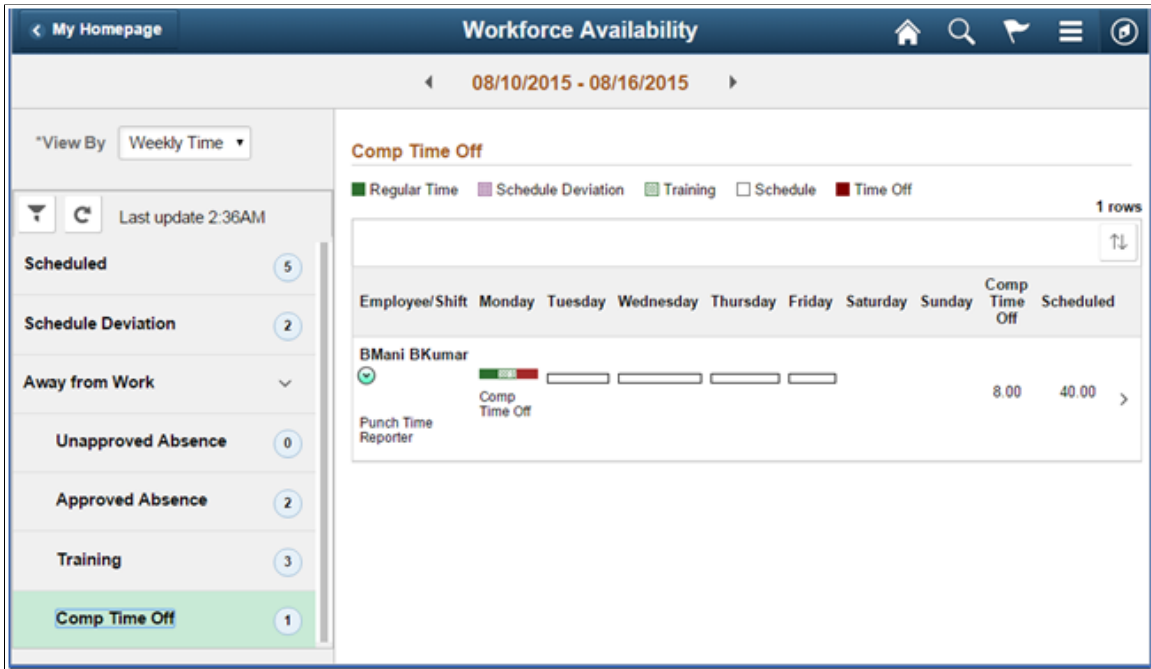

Tap on the user to go to the drill-down modal window.

This example illustrates the fields and controls on the Comp Time Off weekly drill down.

**Comp Time Off** ×

---

**Kai MacKenzie**  
Billing Specialist  
313 9654600

---

**▼ Comp Time Off Details**

---

Date	Plan Description	Duration
Tuesday, Nov 17	No Limit Pos/Never Expire	8.00

---

**Balance Information**

---

Plan Description	As of Date	Balance
No Limit Pos/Never Expire	11/17/2015	17.00

This example illustrates the fields and controls on the Comp Time Off daily page for the smartphone.

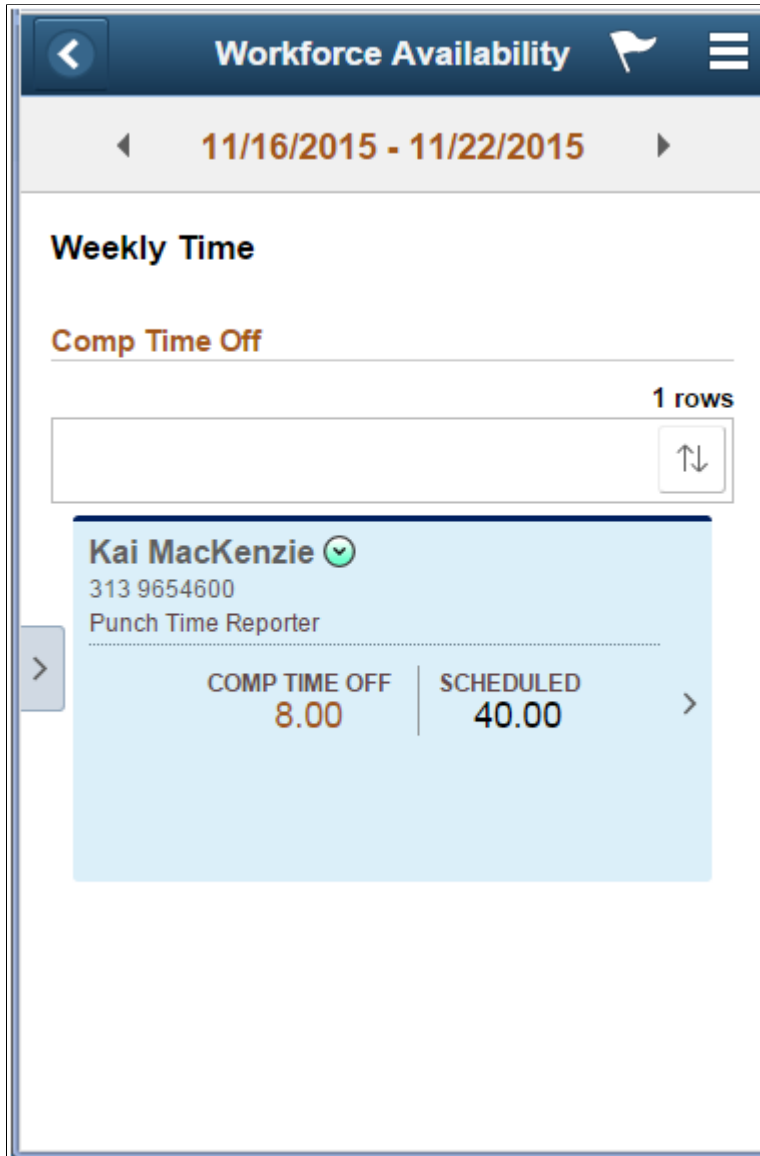

Tap on **Drop down** icon to go to the related actions menu, which list the related action for approved absence category.

The Elapsed scheduled text is displayed on the details area for Elapsed Time reporters, whereas the schedule is displayed below the widget for Punch Time reporters.

## Time and Labor Fluid WorkCenter Page

The Fluid Time and Labor WorkCenter is divided into four main sections – My Work, Links, Queries, and Reports/Processes. You can expand each sections by clicking those sections.

The following Videos give an overview of Time and Labor WorkCenter:

Video: [Image Highlights, PeopleSoft HCM Update Image 35: Time and Labor WorkCenter](#)

Video: [Benefits and Time and Labor Fluid WorkCenters](#)

This example illustrates the fields and controls on the Time and Labor WorkCenter Page. You can find definitions for the fields and controls later on this page.

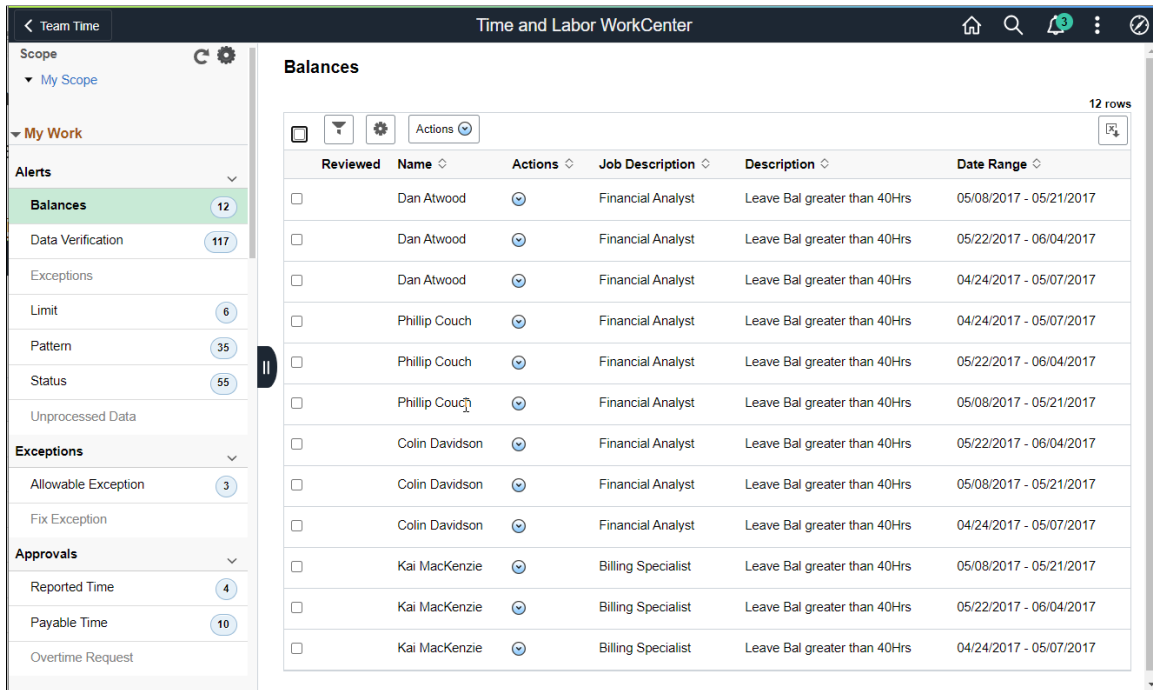

This example illustrates the fields and controls on the Time and Labor Fluid WorkCenter (2\_2) Page.

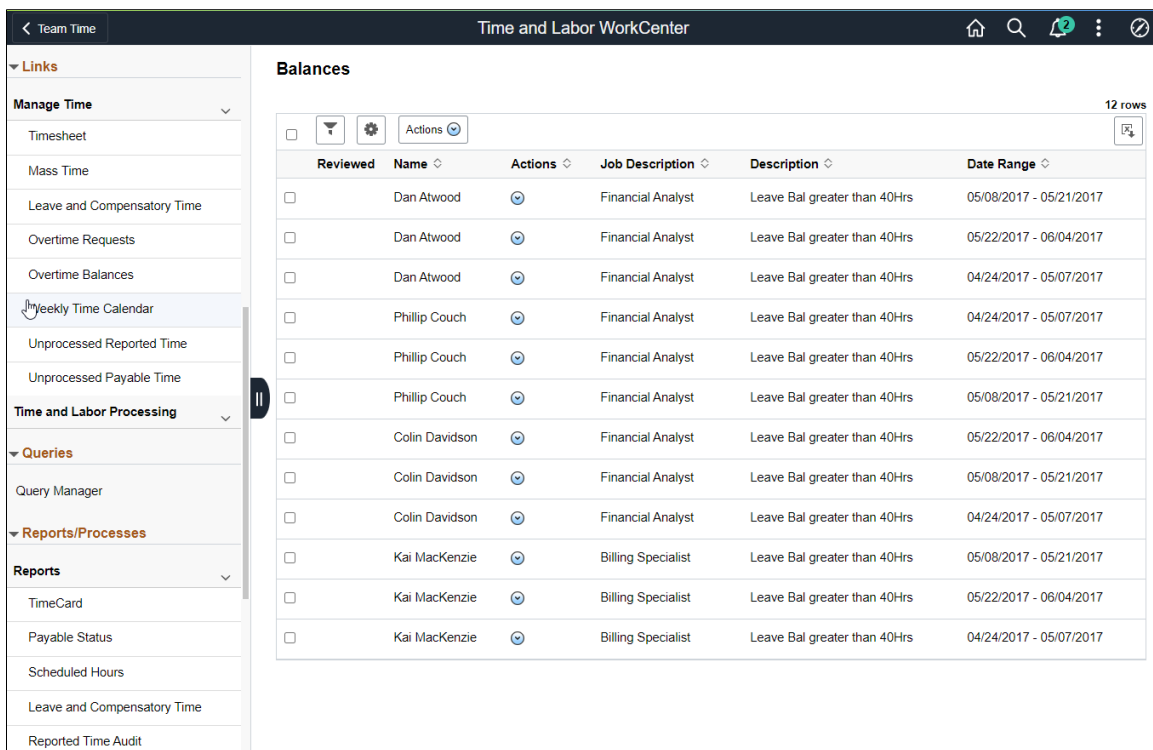



Users can personalize display options and add links to their own WorkCenter for maximum efficiency. For more information, see “Setting Up and Personalizing PeopleSoft Fluid WorkCenters” (Application Fundamentals).

The WorkCenter page is divided into two areas: the navigation panel on the left and the transaction panel on the right.

## Left Panel

The navigational panel on the left contains group boxes with links to specific transactions, menu components and other content. These group boxes are:

- **My Work.** This group box contains six collapsible sections, *Alerts*, *Exceptions*, *Approvals*, *Time Reporter Status*, *Attendance*, and *Unprocessed Time*. For more information, see [Understanding the My Work Group Box](#).
- **Links.** For more information, see [Understanding the Links Group Box](#).
- **Queries.** For more information, see “Configure Pagelets – Queries Page” (Enterprise Components).
- **Reports/Processes.** For more information, see “Configure Pagelets – Reports/Processes Page” (Enterprise Components).

<b>Field or Control</b>	<b>Description</b>
<b>Scope</b>	<p>Scope determines the data to be displayed in the WorkCenter.</p> <hr/> <p><b>Note:</b> If you have configured any additional scope, it will also be listed under the My Scope option. For more information on how to configure a new scope, see “Configure Scope Page” (Application Fundamentals).</p> <hr/>
	<p>Click to refresh the content area to display either the first page that appears when you first access the WorkCenter, or the starting page if it is specified in your personalization.</p>
	<p>Click to access these personalization options:</p> <ul style="list-style-type: none"> <li>• <i>Personalize:</i> Select this option to personalize the WorkCenter layout.  For more information, see “Personalize Page (Fluid)” (Application Fundamentals).</li> <li>• <u>Maintain Scope Detail Page:</u> Select this option to modify the current scope.</li> <li>• <i>Configure Scope:</i> Select this option to create a new scope.  For more information, see “Configure Scope Page” (Application Fundamentals).</li> </ul>

This example illustrates the fields and controls on the Personalize Scope Page. You can find definitions for the fields and controls later on this page.

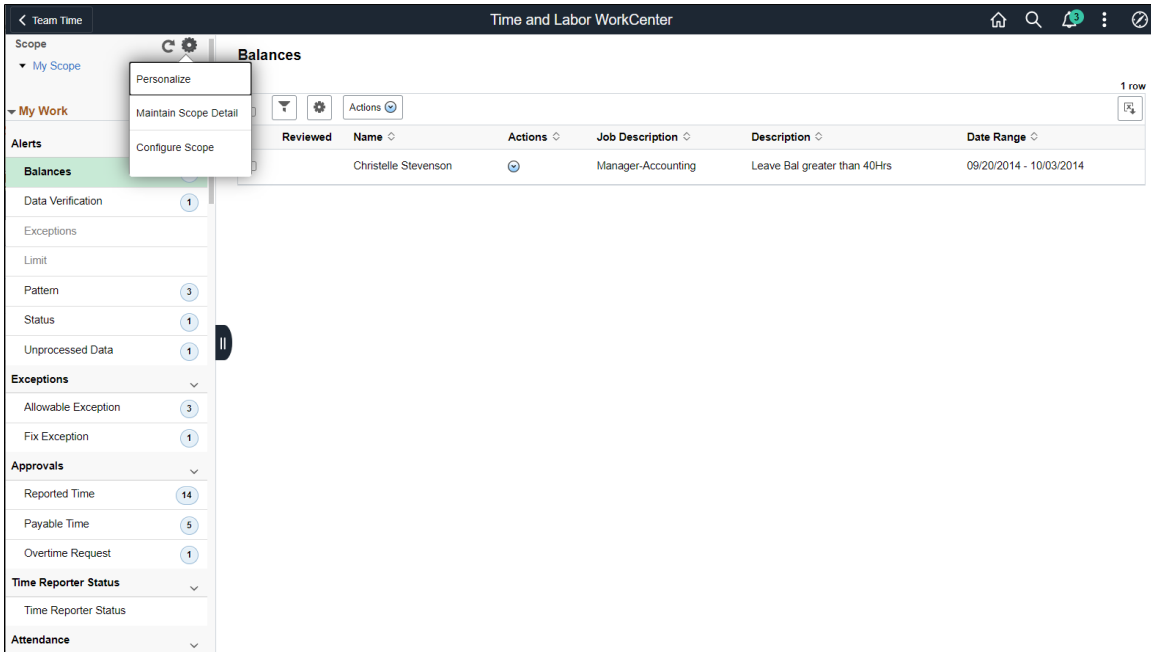

This example illustrates the sample personalized output for one of the My work items.

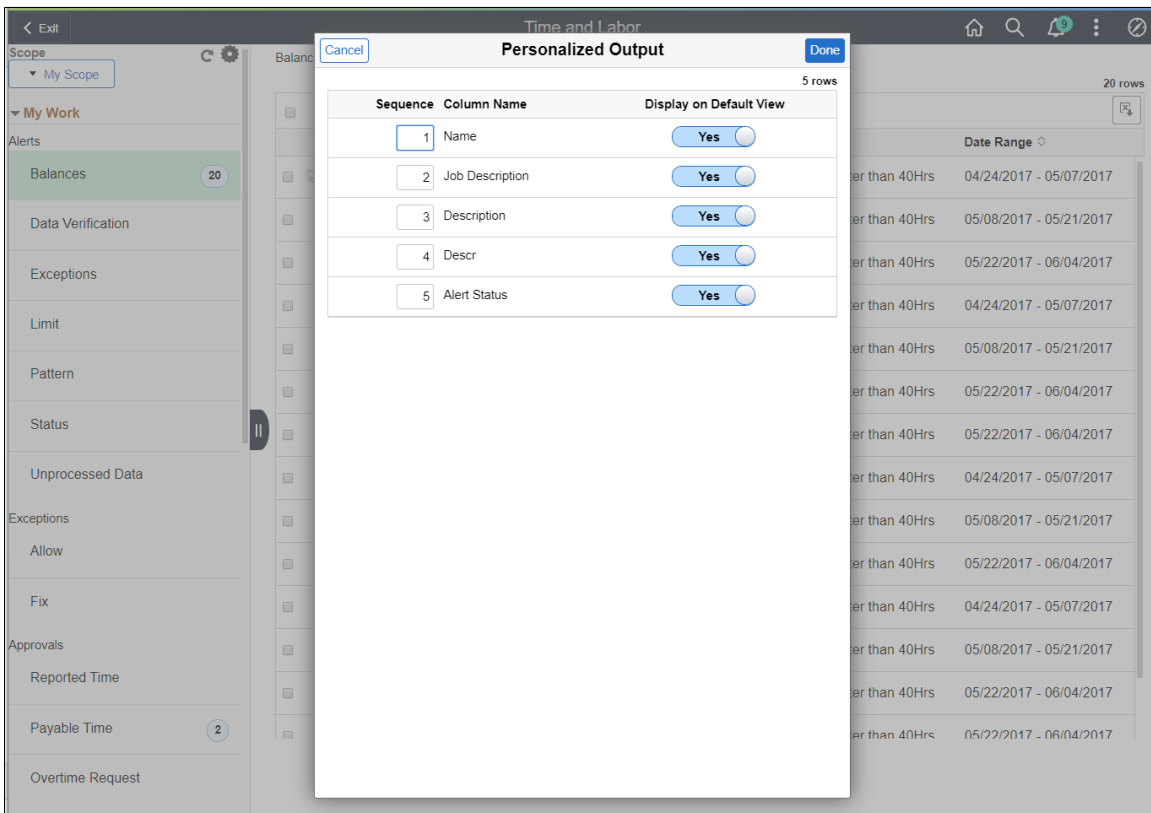

The modal for **Personalized output** provides an option to select the options to display on output.

## Right Panel

The transaction panel on the right is where the selected transaction result or component (work item) is displayed.

By default, the first My Work item appears when you first access the Time and Labor WorkCenter. You can change this default setting of the WorkCenter on the “Personalize Page (Fluid)” (Application Fundamentals).

You can also filter and personalize the output based on your requirements. Use the Refine Filter Criteria page to select one or more criteria to narrow the search result. The Filter icon appears green when filters have been applied to your search. Use the Personalized Output page to modify the position of columns and to select the columns to be displayed as default for each work item. For more information, see “Setting Up and Personalizing PeopleSoft Fluid WorkCenters” (Application Fundamentals).

## Maintain Scope Detail Page

Use the Maintain Scope Detail (EOWC\_EDITVIEWWLK\_FL) page to define the scope for **My Work** items.

This example illustrates the fields and controls on the Maintain Scope Detail Page. You can find definitions for the fields and controls later on this page.

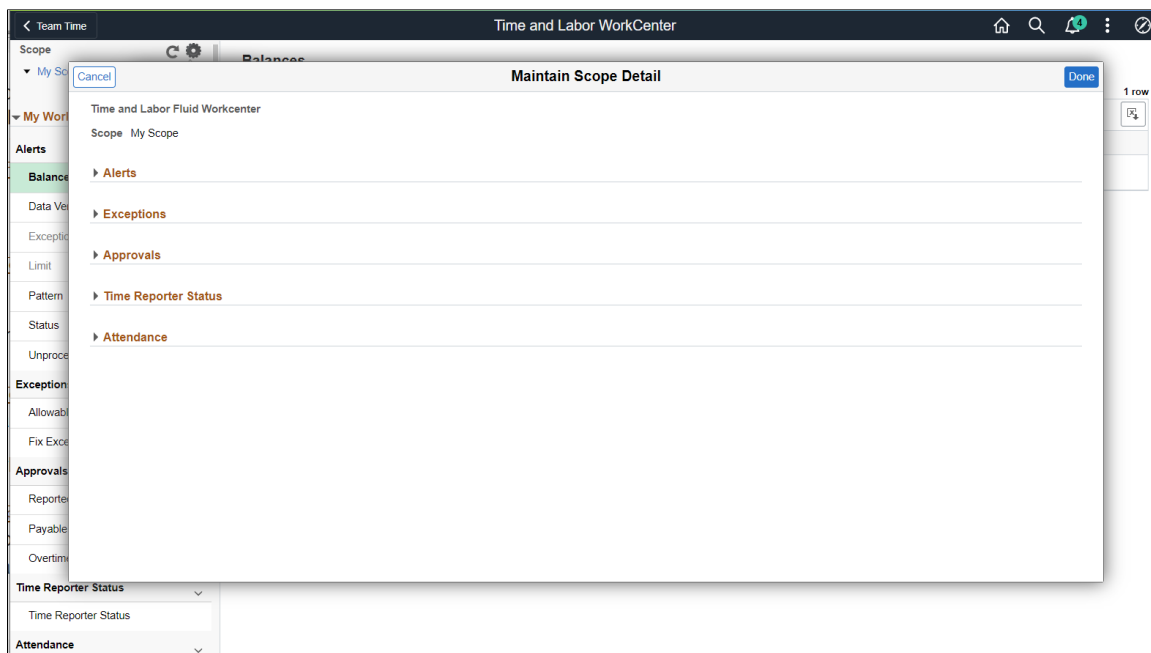

You can define the scope of alerts with Link Label, Description and Edit Filters. The **Edit Filters** enables you to define the scope values like date ranges.

## Understanding the My Work Group Box

The My Work group box provides Time and Labor work item links for alerts and exceptions in these group sections:

- Alerts



- [Exceptions](#)
- [Approvals](#)

---

**Note:** Work item links are grayed out if no data is available for display.

---

## Alerts

There are seven types of alerts available, they are Balances, Data Verification, Exceptions, Limit, Pattern, Status and Unprocessed Data.

## Exceptions

- [Allowable Exception Page](#)
- [Fix Exception Page](#)

## Approvals

There are [Reported Time Approvals Page](#), Payable Time page and Overtime Request time page in Time and Labor Fluid WorkCenter.

## Alert Type\_Balances Page

Use the Balances page (HWC\_RSLT\_FL) to view the list of employees with balances for a selected date range.

Navigation:

Click the **Balances** link in the My Work group box of the Time and Labor WorkCenter.

This example illustrates the fields and controls on the Alert type\_Balances Page. You can find definitions for the fields and controls later on this page.

Balances						19 rows
Reviewed	Name	Actions	Job Description	Description	Date Range	
<input type="checkbox"/>	<input checked="" type="checkbox"/> Alexis Calder	<input type="radio"/>	Detective	Leave Bal greater than 40Hrs	05/08/2017 - 05/21/2017	
<input type="checkbox"/>	<input checked="" type="checkbox"/> Alexis Calder	<input type="radio"/>	Detective	Leave Bal greater than 40Hrs	05/22/2017 - 06/04/2017	
<input type="checkbox"/>	<input checked="" type="checkbox"/> Gladys Gormley	<input type="radio"/>	Finance Director	Leave Bal greater than 40Hrs	04/24/2017 - 05/07/2017	
<input type="checkbox"/>	<input checked="" type="checkbox"/> Gladys Gormley	<input type="radio"/>	Finance Director	Leave Bal greater than 40Hrs	05/08/2017 - 05/21/2017	
<input type="checkbox"/>	<input checked="" type="checkbox"/> Gladys Gormley	<input type="radio"/>	Finance Director	Leave Bal greater than 40Hrs	05/22/2017 - 06/04/2017	
<input type="checkbox"/>	<input checked="" type="checkbox"/> Alic Jordan	<input type="radio"/>	Accountant	Leave Bal greater than 40Hrs	05/22/2017 - 06/04/2017	
<input type="checkbox"/>	<input checked="" type="checkbox"/> Alessandro Manzoni	<input type="radio"/>	Mayor	Leave Bal greater than 40Hrs	04/24/2017 - 05/07/2017	
<input type="checkbox"/>	<input checked="" type="checkbox"/> Alessandro Manzoni	<input type="radio"/>	Mayor	Leave Bal greater than 40Hrs	05/08/2017 - 05/21/2017	
<input type="checkbox"/>	<input checked="" type="checkbox"/> Alessandro Manzoni	<input type="radio"/>	Mayor	Leave Bal greater than 40Hrs	05/22/2017 - 06/04/2017	
<input type="checkbox"/>	<input checked="" type="checkbox"/> Paul Menezes	<input type="radio"/>	Law Enforcement Officer	Leave Bal greater than 40Hrs	04/24/2017 - 05/07/2017	

The WorkCenter uses manager search options as filters. Any default search criteria on manager search option gets extended to the WorkCenter.

This example illustrates the fields and controls on the Manager Search Options for Alert items. You can find definitions for the fields and controls later on this page.

The screenshot shows the 'Balances' alert page in the Time and Labor WorkCenter. A 'Filters' dialog box is open, allowing for a search of manager information. The dialog box includes the following fields:

- Time Reporter Group
- Employee ID
- Last Name
- First Name
- Job Code
- Job Description
- Department
- Supervisor ID (KU0046)
- Location Code
- Taskgroup

The background shows a table with one row of data for 'Christelle S...' with a date range of '09/20/2014 - 10/03/2014'.

The **Employee Selection Criteria** defined under **Manager Search Defaults** configured at the organization level defines the **Filter** fields available for the manager to search upon.

This example illustrates the fields and controls on the Alerts with Related Actions. You can find definitions for the fields and controls later on this page.

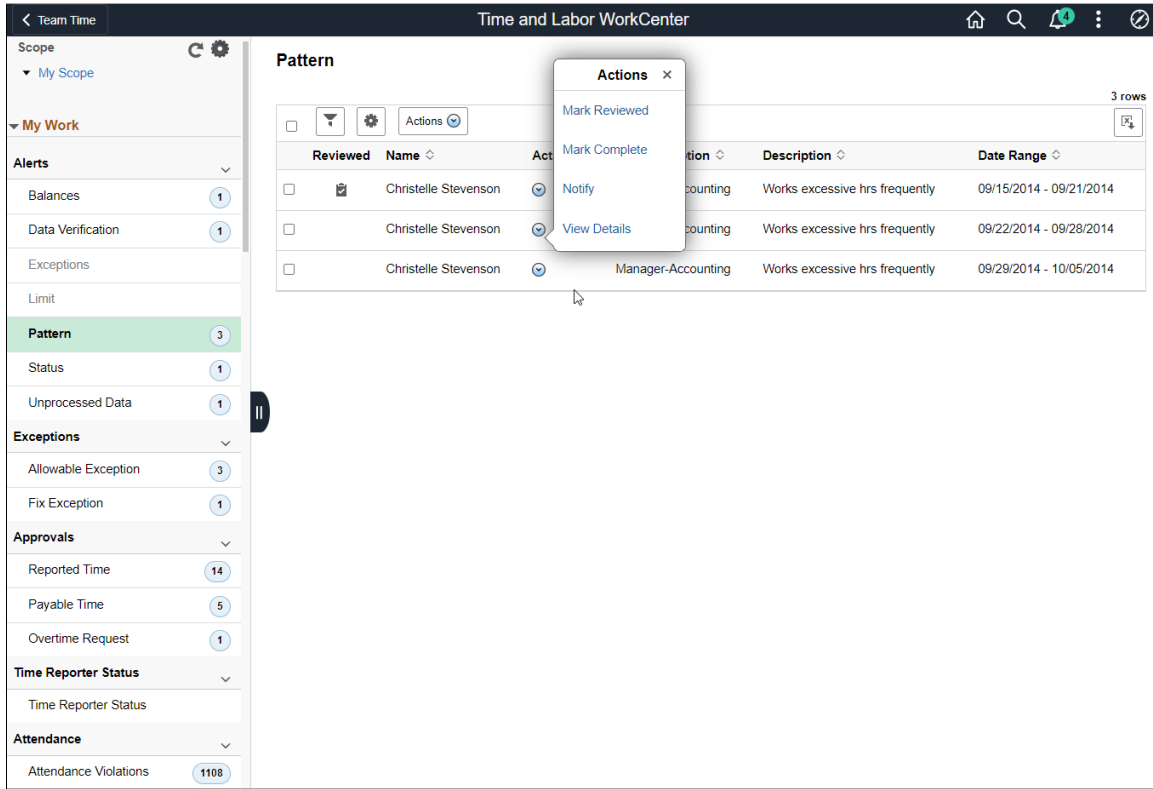

Select the related actions icon to the right side of the employee to view the related actions list.

<b>Field or Control</b>	<b>Description</b>
<b>Mark Reviewed</b>	Select to indicate that this alert has been reviewed. The screen displays the indication by showing the icon just before the employee name to show that the alerts are reviewed.
<b>Mark Complete</b>	Perform the review complete for the selected employee.
<b>Notify</b>	Perform notify for the selected employee. Selecting this opens the <b>HR Notification</b> modal to send the notification.
<b>View Details</b>	Select to navigate to a page to view the details.

This example illustrates the fields and controls on the Bulk Actions for Alerts. You can find definitions for the fields and controls later on this page.

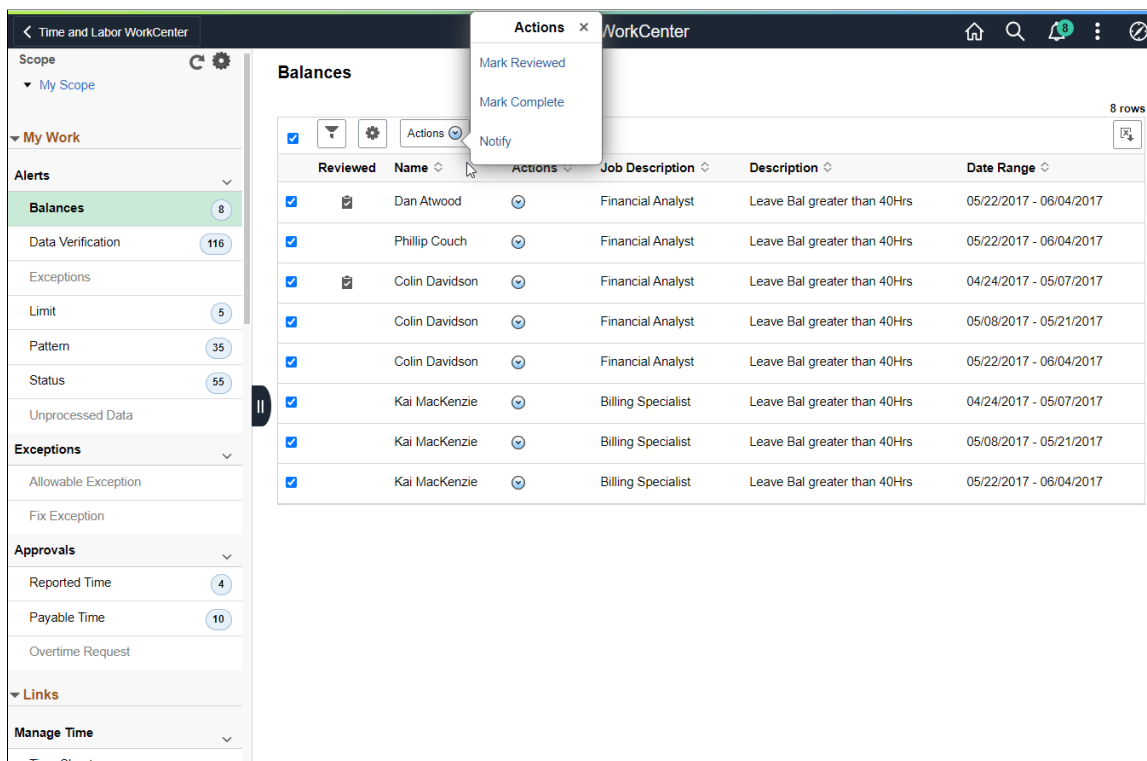

You can select one or more employees at a time to perform a bulk action at one go. The bulk actions for balances available are:

<i>Field or Control</i>	<i>Description</i>
 <b>Mark Reviewed</b>	Perform bulk review by selecting multiple employees at a time.  The screen displays the indication by showing the icon just before the employee name to show that the alerts are reviewed.
<b>Mark Complete</b>	Perform the review complete for multiple employees.
<b>Notify</b>	Perform notify for multiple employees. Selecting this opens the <b>HR Notification</b> modal to send the notification.

**Note:** The count will be updated only after the refresh of the page.

## Allowable Exception Page

Use Allowable Exception page to view the exceptions in the reported time.

Click the **Allowable Exception** link under Exceptions in the My Work group box of the Time and Labor WorkCenter.

This example illustrates the fields and controls on the Allowable Exception Page.

Allowable Exception					
Name	Actions	Job Description	Exception	Severity	Date
Kim Balingier		Data Entry Operator	TLX01700 - Full Absence & Reported time	Low	07/01/2014
Len Barnum		ST - Manager of Human Resource	TLX01540 - More than 24 hours reported	Low	05/04/2020
Len Barnum		ST - Manager of Human Resource	TLX01540 - More than 24 hours reported	Low	05/05/2020
Abdullah Declan		ST - Computer Programmer	TLX01540 - More than 24 hours reported	Low	07/09/2018
Ed Michaels		ST - Manager of Human Resource	TLX01540 - More than 24 hours reported	Low	05/04/2020
John Wright		Bartender	TLX01540 - More than 24 hours reported	Low	08/05/2010
John Wright		Bartender	TLX01540 - More than 24 hours reported	Low	05/04/2020
John Wright		ST - Computer Programmer	TLX01540 - More than 24 hours reported	Low	05/04/2020

Select the related actions icon on the right pane to open the options.

This example illustrates the fields and controls on the Allowable Exception\_Related Action. You can find definitions for the fields and controls later on this page.

The screenshot shows the 'Time and Labor WorkCenter' interface. On the left is a navigation pane with categories like 'My Work', 'Alerts', 'Exceptions', 'Approvals', and 'Attendance'. The 'Allowable Exception' section is highlighted. The main area displays a table with 2 rows. An 'Actions' dropdown menu is open over the first row (John Patterson), showing two options: 'Allow' and 'Manage Exception'.

Name	Actions	Job Description	Exception	Severity	Date
John Patterson		Manager-Revenue	TLX01540 - More than 24 hours reported	Low	04/11/2020
John Patterson		Manager-Revenue	TLX01540 - More than 24 hours reported	Low	06/16/2020

Select the related actions icon to the right side of the employee to view the related actions list. You can perform the following actions:

- **Allow:** Select to allow the exception.
- **Manage Exception:** Select to navigate to Manage Exceptions modal.

## Fix Exception Page

This example illustrates the fields and controls on the Fix Exception Page. You can find definitions for the fields and controls later on this page.

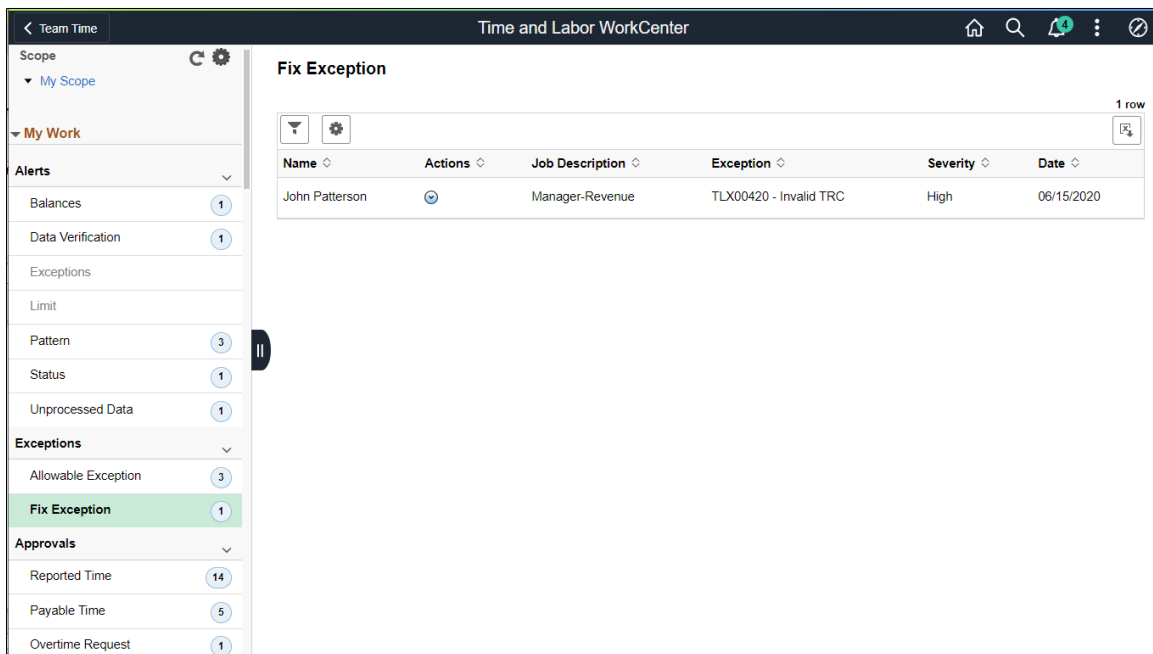

Select the related actions icon to the right side of the employee to view the related actions list. You can perform the following actions:

This example illustrates the fields and controls on the Fix Exception Page\_Related Action. You can find definitions for the fields and controls later on this page.

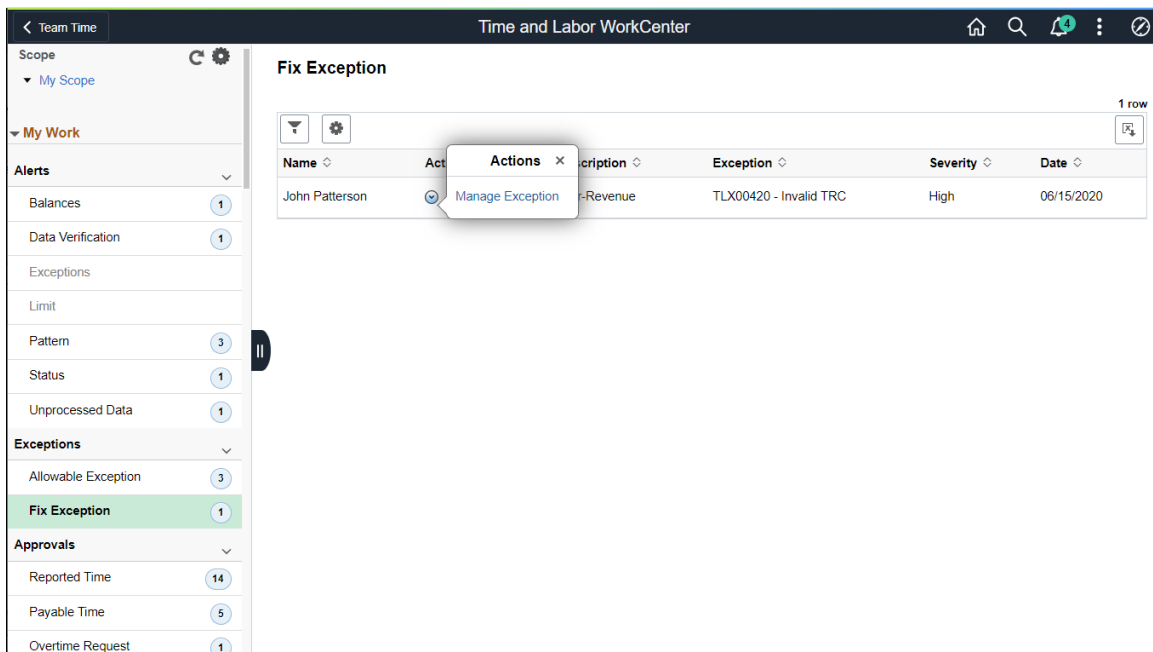

Select **Manage Exception** to navigate to Manage Exceptions modal.

## Reported Time Approvals Page

Use the Reported Time Approvals page to view the list of employees with reported time approvals.

Navigation:

Click the **Reported Time Approvals** link under Approvals in the My Work group box of the Time and Labor WorkCenter.

This example illustrates the Reported Time Approvals Page.

Pending Approvals			
<b>All</b>			3 rows
<b>Reported Time</b> Liam Gray	Quantity for Approval 16.00 Hours 04/30/2020 - 05/01/2020	Routed 02/20/2020	>
<b>Reported Time</b> Liam Gray	Quantity for Approval 8.00 Hours 06/02/2020 - 06/02/2020	Routed 02/20/2020	>
<b>Reported Time</b> Liam Gray	Quantity for Approval 116.25 Hours 02/07/2020 - 03/06/2020	Routed 02/20/2020	>

The Time Approvals page leads to the corresponding pending approvals page and are routed to Fluid AWE.

## Understanding the Links Group Box

The Links group box provides access to the key components that are required to complete Time and Labor transactions.

This example illustrates the Links Group Box.

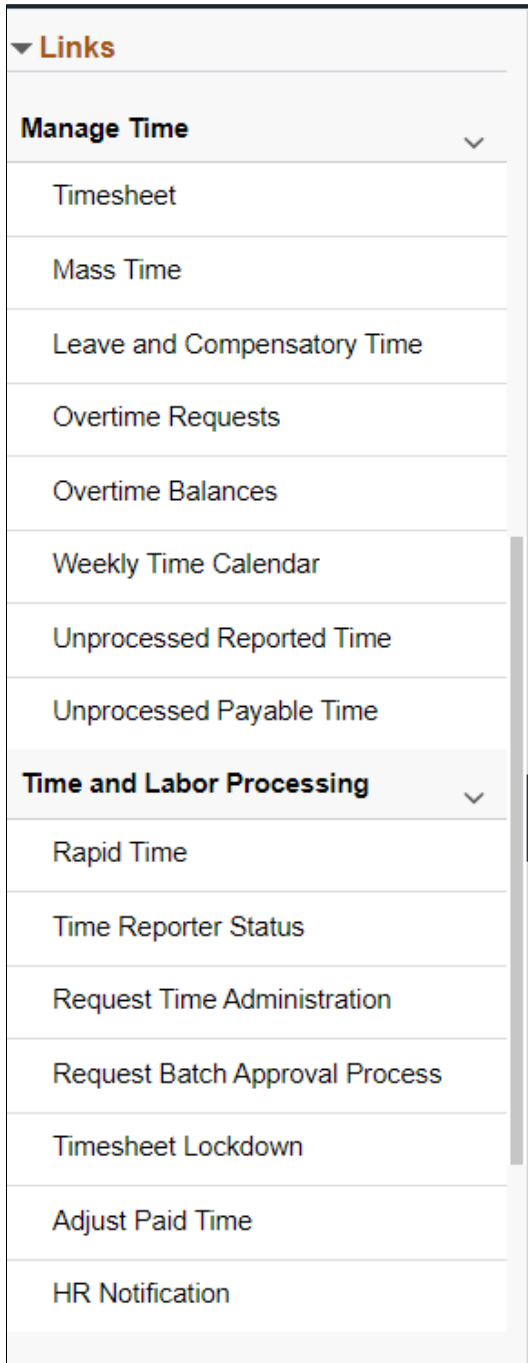

System administrators can manage links and configuration options for the Links Group Box on the “Configure Pagelets - Links Page” (Enterprise Components).

## Understanding the Queries Group Box

The Queries group box contains the Query Manager link. You can click this link to search for existing queries or create ones to use.



This example illustrates the Queries Group Box.

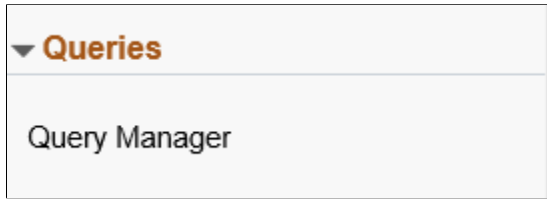

System administrators can manage links and configuration options for the Queries Group Box on the “Configure Pagelets – Queries Page” (Enterprise Components).

## Understanding the Reports/Processes Group Box

The Reports/Processes group box provides access to the Workforce Availability analytics and reports.

This example illustrates the Reports/Processes Group Box.

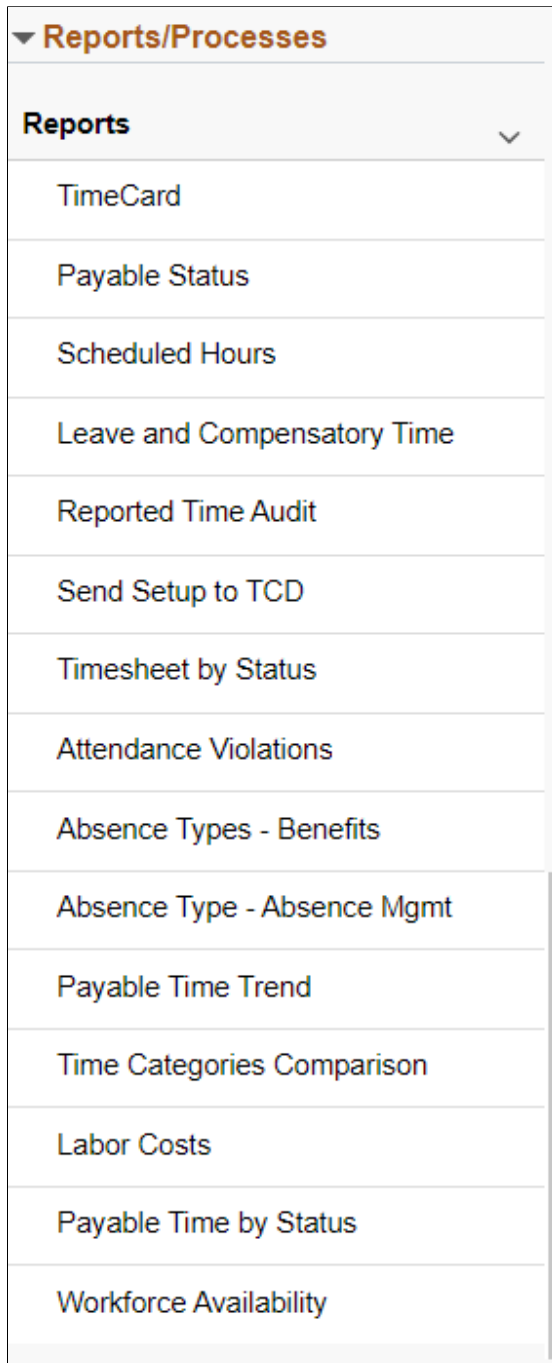

System administrators can manage links and configuration options for the Reports/Processes group box on the “Configure Pagelets – Reports/Processes Page” (Enterprise Components).

---

## Managing Time Enrollments Using Fluid

Administrators can use the fluid Time Reporter Data to create, search and manage enrollments to Time and Labor using fluid pages.

This topic provides an overview on how to create, search and manage enrollments to Time and Labor.

**Note:** The search configuration is inactive by default. For using the search feature, activate using “Setting Up Search Configuration” (Application Fundamentals).

## Pages Used to Manage Time Enrollments Using Fluid

The following video provides an overview of Manage Time Enrollments using Fluid:

Video: [PeopleSoft Fluid Time Reporter Data](#)

<b>Page Name</b>	<b>Definition Name</b>	<b>Usage</b>
<a href="#">Manage Time Reporter Data Tile</a>	HC_TL_EMPLDATA_M_FL_GBL (this is the cref for the tile)	Search and manage enrollments in Time and Labor.
<a href="#">Search Criteria Page</a>	TL_EMPLM_SCH_FL	“(Fluid) Updating Job Data” (PeopleSoft Human Resources Administer Workforce)
Employees Search Result Page	EMP_SRCH_COR_FL	Display employee search results.
<a href="#">Create Time Reporter Data Page</a> <a href="#">Manage Time Reporter Data Page</a>	TL_EMPDATA_M_FL	Create new employees into time reporters enrollment information into Time and Labor.  Update enrollment information for time reporters in Time and Labor.
<a href="#">Time Reporter - Badge Detail Page</a>	TL_BADGE_SEC_FL	Display badge information for a time reporter.
<a href="#">Time Reporter Group Membership Page</a>	TL_GRP_MEMBERSHIP_FL	To view the list of groups that the time reporter is assigned to.

## Manage Time Reporter Data Tile

Administrators can use Manage Time Reporter Data tile to navigate to the employee search page and then create and manage enrollments in Time and Labor.

Navigation:

Select Workforce Administrator from the drop down Menu and select Time and Labor Tile.

Select Time and Labor tile to open the landing page with Manage Time Reporter Data tile.

This example illustrates the fields and controls on the Manage Time Reporter Data.



Select Manage Time Reporter Data tile to open [Search Criteria Page](#).

## Search Criteria Page

The search Criteria page allows you to search an enrolled employee in Time and Labor.

When you select the Manage Time Reporter tile, the system displays the configurable Manage - Search Criteria page (EOSF\_SRCH\_FL) to search for job records using fluid.

The page first appears in the Advanced Search mode, where you can use multiple search fields and save your searches, or you can switch to the Basic Search, where you can use the **Search By** field to retrieve data. Administrators responsible for creating search configurations can modify these options according to the needs of your organization.

For more information on setting up search page configurations, refer “Setting Up Search Configuration” (Application Fundamentals).

This video provides an overview of the Configurable Search feature:

Video: [Image Highlights, PeopleSoft HCM Update Image 36: Configurable Search](#)

## Search Criteria Page

This example illustrates the Search Criteria page and recent searches.

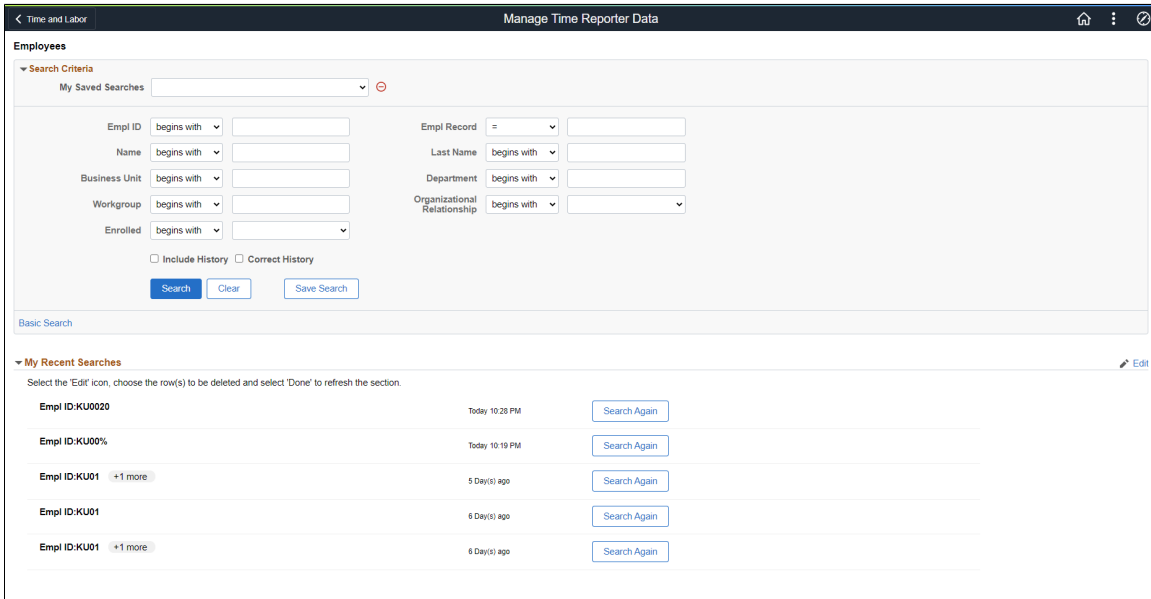

This example illustrates the Manage Job - Search Criteria page showing search results.

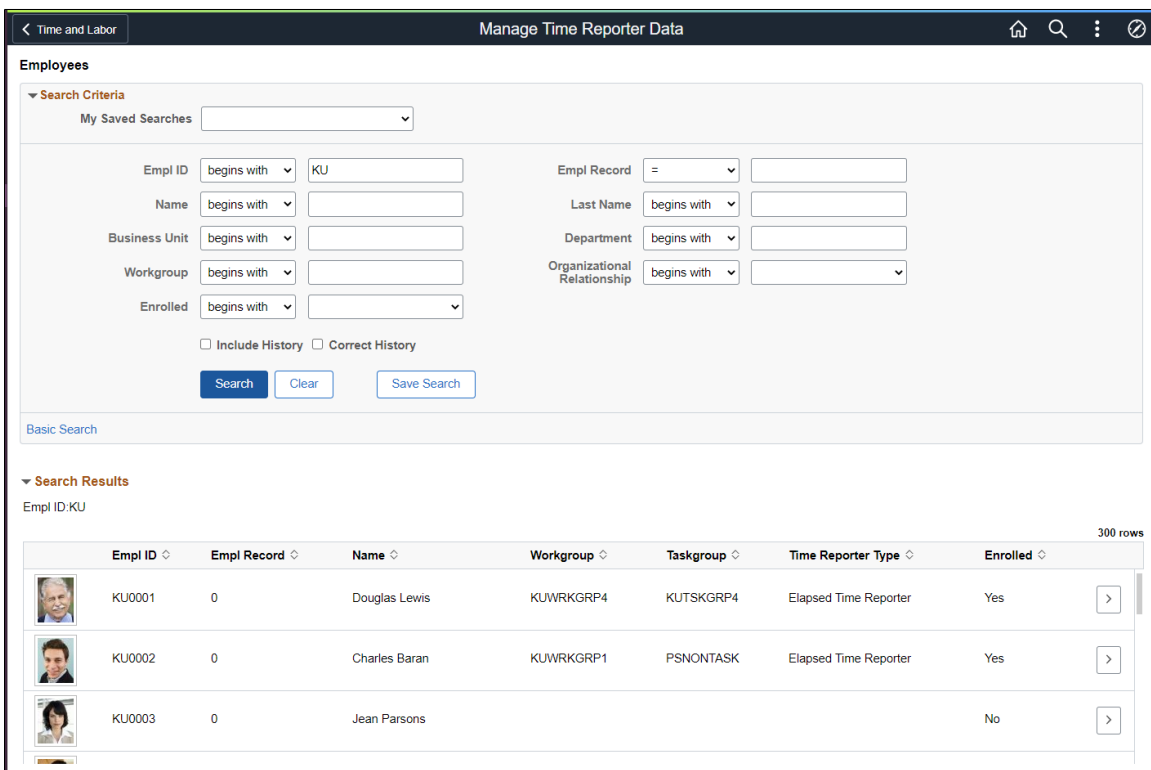

## Search Criteria

<b>Field or Control</b>	<b>Description</b>
<b>My Saved Searches</b>	View the results of a search that was saved before from the drop-down.
<b>Empl ID</b>	Employee ID
<b>Empl Record</b>	Employee Record Number
<b>Department</b>	Information about the department of business entity in an organization.
<b>Workgroup</b>	<p>Select a workgroup for the time reporter. Workgroup is a required field. It identifies the default TRC program, rule program, holiday schedule, time reporting period, and other information that the system uses when processing reported time for this person.</p> <p>If you change the workgroup, and the Assign Workgroup Schedule field is set to <i>Yes</i> on the time reporter's Assign Schedules page, the system deletes any workday overrides for the time reporter that are of a different type than the assigned schedule (that is, elapsed versus punch).</p> <p>If you change the workgroup when the Default from Workgroup check box is selected on the TL Installation page, the system updates compensatory time plan enrollment when there is a change in a compensatory time plan. The dormant compensatory time plan is inactivated and the new compensatory time plan becomes active as of the effective-dated change of the workgroup on the Maintain Time Reporter Data page.</p>
<b>Organizational Relationship</b>	Organizational relationship include <b>Employee</b> , <b>Contingent Worker</b> and <b>Person of Interest</b> , which can be selected from the drop down.
<b>Enrolled</b>	<p>Time enrolled type Yes or No.</p> <p>Returns <b>Yes</b> if employees are enrolled in Time and Labor. For others it displays as <b>No</b>. This field assists Administrators in identifying employees based on enrollment.</p>

<b><i>Field or Control</i></b>	<b><i>Description</i></b>
<b>Include History</b>	Select to retrieve all rows for this person. Although you can view all the rows, you cannot make corrections to historical rows in this mode.
<b>Correct History</b>	Select to retrieve all rows for this person. In this mode, you can make corrections to historical rows.

---

**Note:** Update/Display is the default mode that gets applied if Include History or Correct History is not selected. You can add a new top row in this mode but you cannot view historical rows. Availability to access modes are based on your security access and modes may not be available for all users.

---

## Create Time Reporter Data Page

Use the Create Time Reporter Data page to enroll a time reporter into the Time and Labor system.

Navigation:

Select the searched employee as per the enrollment status for either to create or modify the enrollment data.

Select the employees with enrollment status of **No** from the results grid. The assisting chevron navigates you to the Create Time Reporter Data page.

This example illustrates the fields and controls on the Create Time Reporter Data page. You can find definitions for the fields and controls later on this page.

**Note:** Use the Maintain Time Reporter Data page to make changes to data entered on the Create Time Reporter Data page.

For employees already enrolled in Time and Labor, you can select **Yes** assisted chevron on the search results grid to navigate to the Maintain Time Reporter Data page.

### View Time Reporter Data

<i>Field or Control</i>	<i>Description</i>
<b>Effective Date</b>	The effective date must be the same as or after the hire date or, for non-employees, the add date.



<b>Field or Control</b>	<b>Description</b>
<b>Time Reporter Type</b>	<p>Time reporter type identifies how the time reporter will enter time. It does not affect the assignment of schedules. For example, you can assign a punch schedule to a time reporter designated as an elapsed time reporter.</p> <p><b>Elapsed Time Reporter:</b> Select if your time reporter will be reporting time in hours or partial hours.</p> <p><b>Punch time Reporter:</b> Select if your time reporter will be reporting start and stop times in precise entries of date and time, recorded in seconds, minutes, hours, day, month, year, and time zone.</p>
<b>Elapsed Time Template</b>	Select the elapsed time reporting template to use for this time reporter, if different from the one assigned to the time reporter's task group.
<b>Punch Time Template</b>	<p>Select the punch time reporting template to use for this time reporter, if different from the one assigned to the time reporter's task group.</p> <p>For more information on reporting templates, see: <a href="#">Creating Time Reporting Templates</a></p>
<b>Status</b>	When you enroll a time reporter, the time reporting status is <i>Active</i> by default. Time can be reported and generated for the time reporter.

## Affiliations

<b>Field or Control</b>	<b>Description</b>
<b>Time Period ID</b>	<p>The system uses time periods to differentiate between reported time that falls within the current period and time that falls within a prior period.</p> <p>Select a time period ID only if you want the system to use a different time period ID than that assigned to the time reporter's workgroup.</p>

<b>Field or Control</b>	<b>Description</b>
<b>Workgroup</b>	<p>Select a workgroup for the time reporter. Workgroup is a required field. It identifies the default TRC program, rule program, holiday schedule, time reporting period, and other information that the system uses when processing reported time for this person.</p> <p>If you change the workgroup, and the Assign Workgroup Schedule field is set to <i>Yes</i> on the time reporter's Assign Schedules page, the system deletes any workday overrides for the time reporter that are of a different type than the assigned schedule (that is, elapsed versus punch).</p> <p>If you change the workgroup when the Default from Workgroup check box is selected on the TL Installation page, the system updates compensatory time plan enrollment when there is a change in a compensatory time plan. The dormant compensatory time plan is inactivated and the new compensatory time plan becomes active as of the effective-dated change of the workgroup on the Maintain Time Reporter Data page.</p>
<b>Taskgroup</b>	<p>A required field. It identifies the default task template, task profile, and time reporting templates that the system uses when collecting and processing reported time for this time reporter.</p> <p>If the time reporter's department is set up for commitment accounting (the <b>For Department</b> check box under <b>Commitment Accounting Flags</b> is selected), you must assign a task group that's defined for commitment accounting. When you do so, the system selects the <b>For Taskgroup</b> check box.</p> <p>Choose <i>PSNONTASK</i> if this time reporter will never be reporting task information. Choose <i>PSNONCATSK</i> for time reporters not reporting task information in a Commitment Accounting Department. (The system can still collect all the time reporting elements such as country, state, locality, badge ID, and time zone.)</p>
<b>Task Profile ID</b>	<p>Select a task profile ID for the system to use a different default task profile ID than that assigned to the time reporter's task group. Task profiles define the tasks to which a person's reported time is allocated automatically if task information is not reported.</p>

<b>Field or Control</b>	<b>Description</b>
<b>TCD Group</b> (time collection device group)	<p>If the time reporter uses a TCD, such as a time clock or badge scanner to report time, select the appropriate TCD group. The TCD group identifies the TCDs that the time reporter is authorized to use.</p> <hr/> <p><b>Note:</b> When you set up a TCD, you associate it with one or more task groups. Select one of the task groups that is associated with the TCD as the time reporter's default task group in the <b>Taskgroup</b> field. If your default task group is not associated with a TCD in your TCD group, you receive a warning message when saving the page. In addition, all reported task information is associated with a borrowed task group.</p>
<b>Restriction Profile ID</b>	<p>This field applies only if the time reporter uses a time clock device to report time. A restriction profile identifies when to allow or disallow punches in conjunction with the time reporter's schedule.</p> <p>Select a restriction profile ID in this field to apply a different restriction profile than that assigned to the time reporter's TCD group.</p>
<b>Time Zone</b>	<p>Select the time zone in which the time reporter enters time.</p> <p>The system automatically populates the field with the base time zone defined with PeopleTools Utilities.</p>
<b>Badge Detail</b>	<p>Click to access the Time Reporter - Badge Detail page and view the badge information for this time reporter. You enter badge information in Workforce Administration as a part of the hiring or data maintenance process for time reporters.</p> <p>Badge information is important for punch time reporters, who need this information to report time to the TCD.</p>

## Integrations

<b>Field or Control</b>	<b>Description</b>
<b>Send Time to Payroll</b>	<p>Select this check box to integrate Time and Labor with, and send this time reporter's payable time to, a payroll system.</p> <p>If cleared, the Time Administration process converts the time reporter's reported time to payable time and sets the payable time status to <i>No Pay</i>.</p> <p>If selected, and the time reporter's workgroup or the TRC that is used to report time does not need approval, reported time is converted to payable time with a status code of <i>Closed</i>.</p> <p>See <a href="#">Setting Up System Defaults and Loading Dates</a> and <a href="#">Payable Time Status and Reason Codes</a></p>
<b>Payable Time Start Date</b>	<p>Enter the date for the system to start creating payable time for the time reporter. This date is important for time reporters in a workgroup defined for exception time reporting who will have payable time created from schedules.</p> <p>The date you enter in this field updates the Earliest Change Date (EARLIEST_CHGDT) field on the time reporter's TL_TR_STATUS record. This is the date that the Time Administration process uses to determine the initial creation of payable time.</p> <p>For example, if you enroll your time reporter with an effective date of 01/01/2000, but you don't want the system to start creating payable time for the time reporter until 02/01/2000, enter <i>02/01/2000</i> in this field.</p> <p>If you do not select a date, the first time you run the Time Administration process for the exception time reporter, the process creates payable time as of the Time and Labor enrollment date (the first effective date for the time reporter).</p> <p>The payable start date cannot be earlier than the date that the time reporter is enrolled in Time and Labor.</p> <hr/> <p><b>Note:</b> The <i>Payable Start Date</i> field does not appear on the Maintain Time Reporter Data page because it is used once. If you change the first effective date for the time reporter on the Maintain Time Reporter Data page, the Referential Integrity process triggers the update of the Earliest Change Date field.</p> <hr/>

<i>Field or Control</i>	<i>Description</i>
<b>Commitment Accounting</b>	<p>These selects are display-only and are applicable when you integrate PeopleSoft's commitment accounting functionality with task reporting.</p> <p><b>For Taskgroup:</b> Selected automatically if the task group for the time reporter (in the <b>Taskgroup</b> field) is defined for commitment accounting.</p> <p><b>For Department:</b> Selected automatically if the time reporter's department is defined for commitment accounting in PeopleSoft Human Resources. When the <b>For Department</b> check box is selected, assign the task reporter a task group that is also defined for commitment accounting.</p> <p>Both flags must be selected or cleared before you can save the Create Time Reporter Data page.</p> <hr/> <p><b>Note:</b> If you change the effective date or the task group on this page, click the button to the right of either field to refresh the commitment accounting flags.</p> <hr/>

### Rule Elements

<i>Field or Control</i>	<i>Description</i>
<b>Rule Elements 1-5</b>	<p>Assign up to five rule elements to a time reporter. When you run the Time Administration process, the system retrieves the values of the time reporter's rule elements and makes the values available for rules processing. This feature enables you to tailor rules to a specific population of time reporters.</p>

## Manage Time Reporter Data Page

Use the Time Reporter Data page (TL\_EMPDATA\_M\_FL) to update enrollment information for time reporters in Time and Labor.

Navigation:

Select the employee search result with enrollment status **Yes** to modify the enrollment data.

For employees already enrolled in Time and Labor, selecting the chevron on the search results grid navigates you to the Maintain Time Reporter Data page

This example illustrates the fields and controls on the Manage Time Reporter Data page. You can find definitions for the fields and controls later on this page.

<b>Field or Control</b>	<b>Description</b>
<b>Group Membership</b>	Click to access the Time Reporter Group Membership page, where you can see the list of groups in which the time reporter is currently enrolled.

Most of the elements on the Maintain Time Reporter Data page are identical to those on the Create Time Reporter Data page.

## Changes That Affect the System

<b>Field or Control</b>	<b>Description</b>
<b>Time Reporter Status</b>	<p>If you change a time reporter's status to <i>Inactive</i>, time cannot be reported or generated for the time reporter.</p> <p>Updating a person's status in Human Resources has no effect on the time reporter status. If a time reporter is terminated, update the employee status through Human Resources and then process any reported time for which the time reporter has not been paid. After the time is processed, change the time reporter status to <i>Inactive</i> on the Maintain Time Reporter Data page to prevent additional time from being reported or generated.</p>
<b>Send Time to Payroll</b>	<p>Changing the Send Time to Payroll check box after payable time has been created for this time reporter may impact the payable time. See "Impact of Changing the Send Time to Payroll Check Box" for details.</p>
<b>Workgroup</b>	<p>If you change the workgroup value assigned to the time reporter, the next time you run the Time Administration process, the system will verify that the TRCs associated with the reported time belong to the TRC program associated with the new workgroup for the date reported.</p> <hr/> <p><b>Note:</b> Limit changes in workgroup assignments to the start date of a new period. Changes made in the middle of a period may cause weekly or biweekly rules associated with a time reporter to produce unpredictable results.</p> <hr/>
<b>Taskgroup</b>	<p>If you change the task group value assigned to the time reporter, the next time you run the Time Administration process, Referential Integrity validates that any task entities reported on or after the change date are associated with the new task group.</p> <hr/> <p><b>Note:</b> If you change the task group after you report and submit time (through the Rapid Time Reporting page, Mass Time pages, or TCD interface) during the period of the change, you must update the task group in the weekly reporting pages to reflect the change.</p> <hr/>

<b>Field or Control</b>	<b>Description</b>
<b>Task Profile ID</b>	If you change the task profile ID assigned to the time reporter, the next time you run the Time Administration process, the system verifies that the task profile reported through the weekly elapsed time page is associated with the employee's default task group as of the date reported.
<b>TCD Group</b> (time collection device group)	If you change the TCD group assigned to the time reporter, use the TCD interface to resend the employee information setup data to the time collection devices.
<b>Restriction Profile</b>	If you change the restriction profile ID assigned to the time reporter, use the TCD interface to resend the employee information setup data to the time collection devices.

## Time Reporter Group Membership Page

Use the Time Reporter Group Membership page (TL\_GRP\_MEMBERSHIP) to view the list of groups that the time reporter is assigned to.

Navigation:

Click the **Group Membership** link on the Maintain Time Reporter Data page.



This example illustrates the fields and controls on the Time Reporter Group Membership page. You can find definitions for the fields and controls later on this page.

## Time Reporter Group Membership

×

Douglas Lewis

ID KU0001

Empl Record 0

**Group Memberships**

Group ID	Description	Group Type
ACA_FT	ACA Full-Time	Dynamic
ACA_SAL	ACA Salaried	Dynamic
KUDY2	USA Employee Dyn Group	Dynamic
KUELM	ELM Learners	Dynamic

<b>Field or Control</b>	<b>Description</b>
<b>Group Type</b>	<p>The group type can be either <i>Dynamic</i> or <i>Static</i>.</p> <p>Dynamic groups comprise time reporters who met the group selection criteria at the time you last refreshed the dynamic group. Time reporters are automatically added and removed from dynamic groups as their ability to match the selection criteria changes.</p> <p>Static groups comprise time reporters who met a specific set of criteria at the time the group was established. Time reporters stay assigned to a static group unless you remove them.</p>

**Related Links**

[Understanding Static and Dynamic Groups](#)

## Time Reporter - Badge Detail Page

Use Time Reporter - Badge Detail modal to view the badge details.

This example illustrates the fields and controls on the Time Reporter - Badge Detail Modal

### Time Reporter - Badge Detail

×

Douglas Lewis

ID KU0001

Empl Record 0

**Badge Detail**

Effective Date	Status	Badge Type	Badge Number	Comment
07/01/2004				

---

## Managing Schedules Using Fluid

This topic provides an overview on how to manage schedules for employees using fluid.

### Pages Used to Manage Schedules using Fluid

<i>Page Name</i>	<i>Definition Name</i>	<i>Usage</i>
<u>Manage Schedule Tile</u>	HC_MNG_EMP_SCH_FL_GBL	Select to access the search criteria page and related pages for schedule actions using the Schedule Actions Summary page.
<u>Manage Schedule - Search Criteria Page</u>	EOSF_SRCH_FL	Look up employee schedules by entering search criteria manually, using Saved Searches, or My Recent Searches. This page uses the HCM Configurable Search framework to define the fields to search on and the fields that are returned from the search.

<b>Page Name</b>	<b>Definition Name</b>	<b>Usage</b>
<u>Schedule Actions Summary Page</u>	MNG_SCH_ACTION_FLU	Page that lists schedule related action options.
<u>Assign Schedule Page</u>	SCH_ASSIGN_FL	Assign a time reporter to a schedule.
<u>Schedule Assignment History Page</u>	SCH_ASSIGN_HIST_FL	View all schedule assignments for an employee, including default schedule assignments.
<u>Manage Schedule - Swap Schedules Page</u>	MNG_SCH_FL	Swap two employees' schedules for a day or for a specified date range.
<u>Manage - Replace Schedule Page</u>	MNG_SCH_FL	Schedule the replacement for an employee for a day.
	MNG_SCH_FL	Copy an employee schedule to be used by one or more employees for a day or for a specified date range.
<u>Schedule Preferences Page</u>	SCH_EE_PREF_FL	View the employee's contact and schedule preferences.
<u>Override Schedules Page</u>	MNG_EMP_SCH_FL	Override or add a schedule for an employee for a day.

## Manage Schedule Tile

Administrators and Managers can use the Manage Schedule tile to navigate to the employee search page to access Schedule Actions Summary page. Select respective pages to assign, view and manage schedules.

Navigation:

For Administrators, select Workforce Administrator from the drop down Menu. Select the Time and Labor tile to open the landing page with Manage Schedule tile.

Managers can personalize their Homepage by adding the Manage Schedule tile. Select Manager Self Service from the drop down menu and select the Manage Schedule tile.

The following video provides an overview of Fluid Manager Self Service Scheduling:

Video: [Image Highlights, PeopleSoft HCM Update Image 40: Fluid Manager Self Service Scheduling](#)

This example illustrates the Manage Schedule Tile.

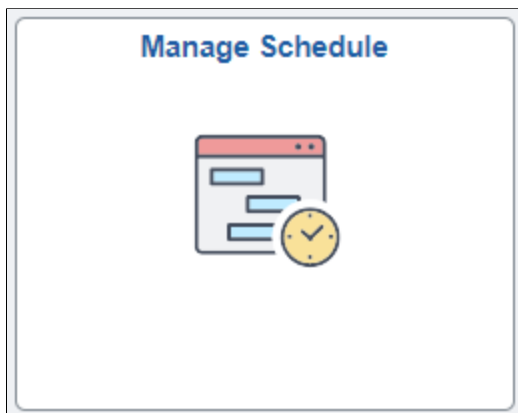

Use Manage Schedule tile to access the search page and then the Schedule Actions Summary page to view or manage schedules for employees.

## Manage Schedule - Search Criteria Page

Use the Manage Schedule - Search Criteria page to search for an enrolled employee in Time and Labor.

The page first displays the Advanced Search mode with multiple search fields, the ability to use saved searches or recent searches, and save the search results. Use the **Search By** field in Basic Search mode to retrieve data using the search criteria drop-down menu. Administrators responsible for creating search configurations can modify these options according to the needs of their organization.

For more information on setting up search page configurations, refer to “Setting Up Search Configuration” (Application Fundamentals).

This video provides an overview of the Configurable Search feature:

Video: [Image Highlights, PeopleSoft HCM Update Image 36: Configurable Search](#)

This example illustrates the fields and controls of the Manage Schedule - Search Criteria page.

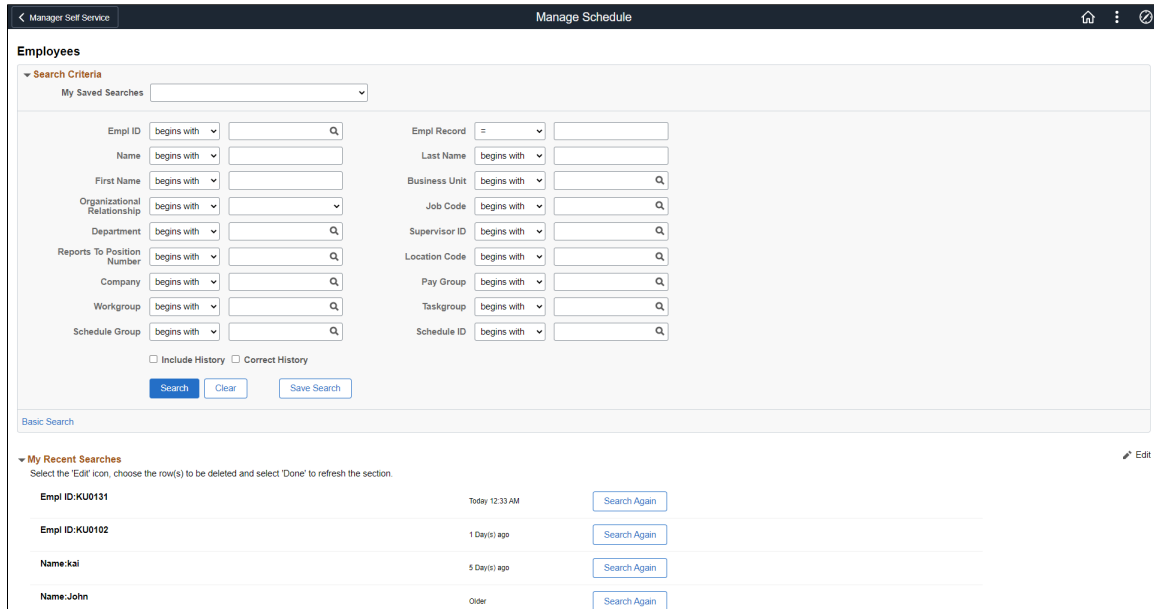

Field or Control	Description
My Recent Searches	View the results of a search that was previously used. Use the <b>Edit</b> link to delete the rows from the search history.

Select the employee from the search results to access the Schedule Actions Summary page.

## Schedule Actions Summary Page

Use the Schedule Actions Summary (MNG\_SCH\_ACTION\_FLU) to access the following pages:

- View and Assign Schedule
- View Assignment History
- Replace Schedule
- Swap Schedules
- Copy Schedule
- View Schedule Preferences
- Override Schedules

Navigation:

**Manage Schedule Tile > Employee Search**

This example illustrates the fields and controls on the Schedule Actions Summary page.

The screenshot shows the 'Schedule Actions Summary' page for John Patterson, Manager-Revenue. The page features a search bar and a list of actions:

- View and Assign Schedule**: View and manage schedule assignments or assign a new effective dated schedule.
- View Assignment History**: View history of schedule assignments, including changes to default schedule.
- Replace Schedule**: Schedule a replacement for an employee for a day.
- Swap Schedules**: Swap an employee's schedule with another for a day or specified date range.
- Copy Schedule**: Copy an employee's schedule to be used by another employee for a day or specified date range.
- View Schedule Preferences**: View the employee's contact and schedule preferences.
- Override Schedules**: Override the schedule of an employee for a day.

This example illustrates the Schedule Actions Summary page using a smartphone.

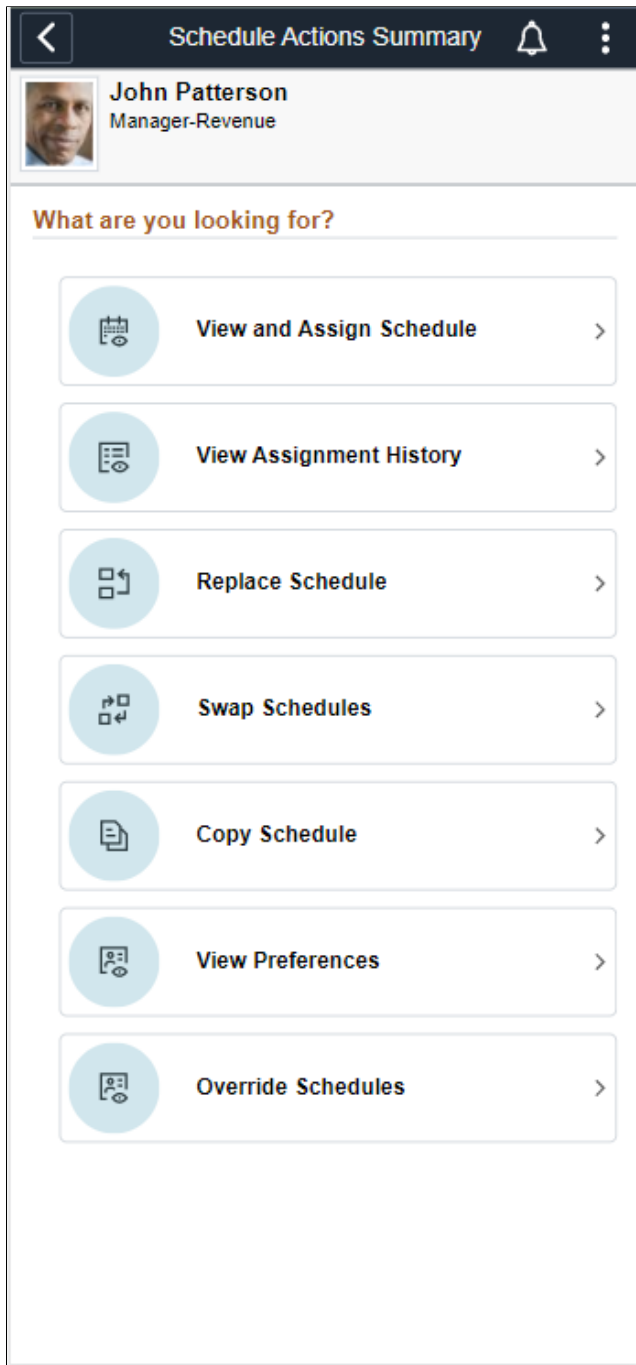

## Assign Schedule Page

Use the Assign Schedule page (SCH\_ASSIGN\_FL) to view and manage schedule assignments or assign a new effective dated schedule.

Navigation:

**Manage Schedule Tile > Employee Search > Schedule Actions Summary > View and Assign Schedule**

This example illustrates the fields and controls of the Assign Schedule Primary Page. You can find definitions for the fields and controls later on this page.

< Search Results
Assign Schedule
🏠 🔍 🔔 ⋮

**Rosanna Channing**  
Senior Accounting Manager  
[Return to selection page](#)

Update/Display
Save

**Schedule Assignment** + -

\*Effective Date  📅

---

**Primary**

\*Assignment Method

Schedule Group  🔍 United States Schedule Group      Schedule ID  🔍 Elapsed 8 Hour Day Definition  
[Lookup Schedule](#)

---

**Alternate**

\*Alternate Assignment Method

Alternate Schedule Group       Alternate Schedule ID

---

**▼ Schedule Calendar**

Primary
Alternate

< >  📅      Schedule ID KUSCHDFE1      Workgroup KUWRKGRP16      Period Total 40.00      Expand All  No

Date 09/01/2011	Day <b>Thursday</b>	Shift ID KUELPSHF1	Sched Hrs 8.00	
		Time Zone		<a href="#">▶ Details</a>
<hr/>				
Date 09/02/2011	Day <b>Friday</b>	Shift ID KUELPSHF1	Sched Hrs 8.00	
		Time Zone		<a href="#">▶ Details</a>
<hr/>				
Date 09/03/2011	Day <b>Saturday</b>	Shift ID OFF	Sched Hrs 0.00	
		Time Zone		<a href="#">▶ Details</a>
<hr/>				
Date 09/04/2011	Day <b>Sunday</b>	Shift ID OFF	Sched Hrs 0.00	
		Time Zone		<a href="#">▶ Details</a>
<hr/>				
Date 09/05/2011	Day <b>Monday</b>	Shift ID KUELPSHF1	Sched Hrs 8.00	
		Time Zone		<a href="#">▶ Details</a>
<hr/>				
Date 09/06/2011	Day <b>Tuesday</b>	Shift ID KUELPSHF1	Sched Hrs 8.00	
		Time Zone		<a href="#">▶ Details</a>
<hr/>				
Date 09/07/2011	Day <b>Wednesday</b>	Shift ID KUELPSHF1	Sched Hrs 8.00	
		Time Zone		<a href="#">▶ Details</a>



This example illustrates the Assign Schedule page using a smartphone.

The screenshot shows the 'Assign Schedule' page on a mobile device. At the top, there is a navigation bar with a back arrow, the title 'Assign Schedule', a notification bell, and a menu icon. Below this is a user profile card for John Patterson, Manager-Revenue, with a 'Return to selection page' link. A blue 'Update/Display' button is positioned above a '1 of 1' indicator. The main content area is divided into sections: 'Schedule Assignment' with '+' and '-' buttons, and 'Primary' and 'Alternate' tabs. The 'Primary' section includes fields for '\*Effective Date' (01/01/2014), '\*Assignment Method' (Select Predefined Schedule), 'Schedule Group' (K0CYM), and 'Schedule ID' (KUSCHDFE1). The 'Alternate' section includes fields for '\*Alternate Assignment Method' (Use Default Schedule) and 'Alternate Schedule Group'. A blue 'Save' button is located at the bottom of the form.

**Note:** The Alternate tab will be hidden for users who do not have an alternate schedule.

<i>Field or Control</i>	<i>Description</i>
Effective Date	Select the start date of the new schedule assignment.

<b>Field or Control</b>	<b>Description</b>
<b>Assignment Method</b>	<p>Select <i>Create Personal Schedule</i>, <i>Select Predefined Schedule</i> or <i>Use Default Schedule</i>.</p> <p>When selected, the <i>Create Personal Schedule</i> value allows you to create an effective dated personal schedule for this employee. A <b>Create Schedule</b> link is displayed on the right side of the grid. In addition, you can select a Schedule Group for the employee. The Schedule ID is automatically populated with the EmplID, Employee Record Number and three additional digits.</p> <p>The <i>Select Predefined Schedule</i> value enables you to select a Schedule Group an associated Schedule ID.</p> <p>The <i>Use Default Schedule</i> value derives a default schedule for the time reporter. For Global Payroll, the schedule defaults from the Global Payroll pay group assigned to an employee (from the Job Data record). For Time and Labor employees that are not in Global Payroll, the schedule defaults from the workgroup assigned to employees on the Maintain Time Reporter Data page when they are enrolled in Time and Labor. If no row is displayed for schedule assignment, the schedule resolution process still resolves the default schedule on the Global Payroll pay group assigned to an employee, or the default schedule on the employee's workgroup if not enrolled in a Global Payroll pay group.</p>
<b>Schedule Group</b>	<p>Schedule Groups are used to group employees with like schedules. A <b>Schedule Group</b> must be entered. For default schedules, both the workgroup and Global Payroll pay groups have Schedule Groups associated with a Schedule ID. The Schedule Group is associated with a SetID, so only valid schedules for a particular SetID that is associated to an employee are displayed.</p>
<b>Schedule ID</b>	<p>If the assignment method is <i>Select Predefined Schedule</i>, select the schedule to assign to the payee.</p> <p>If the assignment method is <i>Use Default Schedule</i>, the system displays the schedule ID that the payee inherits from the pay group.</p>
<b>Lookup Schedule</b>	<p>Open the Lookup Schedule modal to look for the schedule.</p> <p>The Lookup Schedule modal is provided to assist you in searching for the right schedule. The Lookup opens a modal which lets you search for schedule based on one or more schedule or shift attributes.</p> <p>Once you select the resultant value the schedule information will be transferred to the main page automatically.</p>
<b>Alternate Assignment Method</b>	<p>Select <i>Create Personal Schedule</i>, <i>Select Predefined Schedule</i> and <i>Use Default Schedule</i>. for alternate assignment.</p>

<b>Field or Control</b>	<b>Description</b>
	<p>A star icon appears in the Assign Schedules group box, when you assign an employee a default schedule from either a Time and Labor workgroup or a Global Payroll pay group, and the default schedule has changed over time. This default assignment can occur manually, or as a result of an employee hire triggering the Workforce Sync message to insert a default assignment row in Assign Work Schedule.</p> <p>The Assign Schedules group box displays the <b>Schedule ID</b> that is most current at the time, from the workgroup or pay group, despite the schedule assignment effective date. The display of this <b>Schedule ID</b> assists in determining which schedule the system is currently using for schedule resolution. The display of the star icon alerts you to review the History of Schedule Assignments, including Default Changes section to determine what the schedule changes are from the initial schedule assignment to the current date.</p>

This example illustrates Lookup Schedule.

### Lookup Schedule ×

**Search Criteria**

---

Empl ID

First Name

Shift ID

Shift Start Time

Schedule Group

Shift Type

Last Name

Workday ID

Shift End Time

Schedule ID

**Select Shift Days**

Monday
  Tuesday
  Wednesday
  Thursday
  Friday
  Saturday
  Sunday

**Search Results**

---

1 row

Schedule ID <input type="button" value="◇"/>	Description <input type="button" value="◇"/>

This example illustrates the Lookup Schedule Modal using smartphone.

**Lookup Schedule**
×

---

**Search Criteria**

Empl ID

Shift Type

First Name

Last Name

Shift ID

Workday ID

Shift Start Time

Shift End Time

Schedule Group

Schedule ID

**Select Shift Days**

Monday  Tuesday  Wednesday

Thursday  Friday  Saturday  Sunday

---

**Search Results**

1 row

	<input style="width: 20px; height: 20px; border: none;" type="text" value="Q"/> <input style="width: 20px; height: 20px; border: none; margin-left: 5px;" type="text" value="↕"/>
--	---

The Schedule Calendar grid displays the schedule ID, Workgroup, Period Total and field to change the date and previous and next button to view periods of the schedule.

This example illustrates the fields and controls on the Schedule Calendar grid. You can find definitions for the fields and controls later on this page.

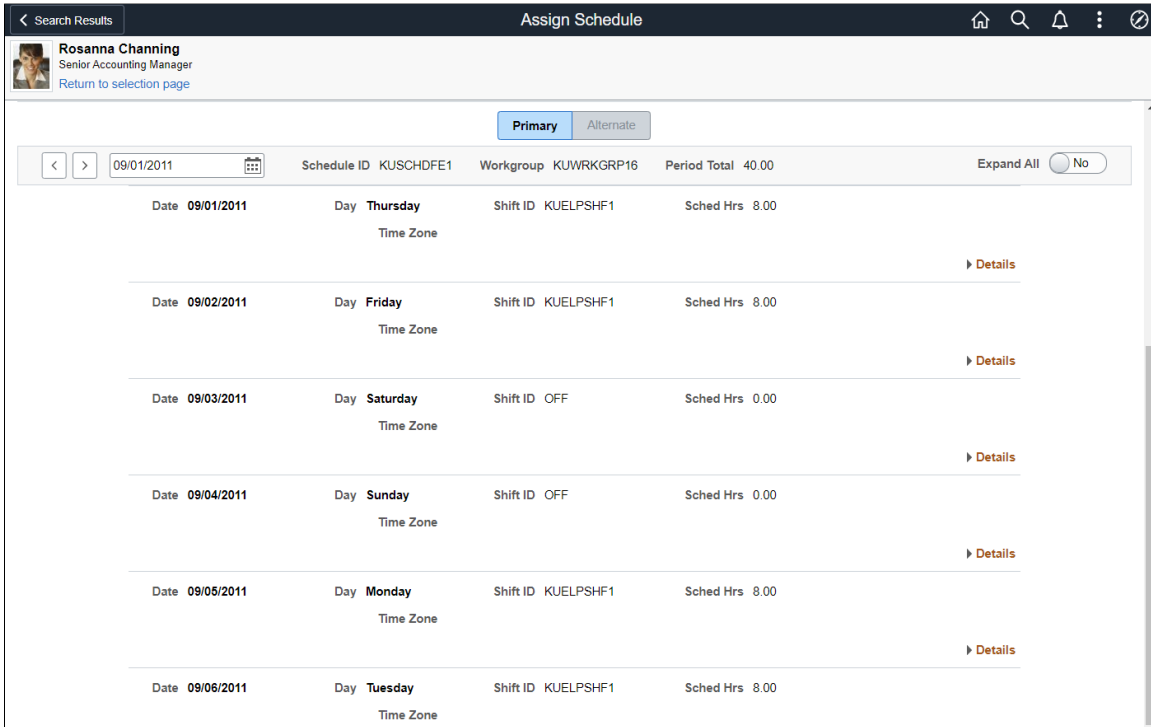

<b>Field or Control</b>	<b>Description</b>
<b>Expand All</b>	Expand all of the Schedule Calendar details under each workday.
<b>Period Total</b>	Displays the sum of the work hours for a particular period in the schedule calendar for the logged in employee.
<b>Shift Detail link</b>	Select to open the Shift Detail modal.  The Shift Detail grid lists the Shift Time tab, Time Reporting Elements tab (if a time reporting template is chosen), Task Reporting Elements tab (if the time reporting template has task template selected instead of task profile), and Chartfields tabs.

The Schedule Calendar area lists all of the elements associated to the schedule. The page also resolves the actual "day" associated with the dates of the schedule.

**Note:** If a user sets up a Shift or Schedule Definition that spans more than 24 hours, the shift displays the begin date of when the shift began.

## Schedule Assignment History Page

Use the Schedule Assignment History page (SCH\_ASSIGN\_HIST\_FL) to view history of schedule assignments, including changes to the default schedule.

This section shows all of the schedule assignments, including what default schedules may have changed either on a Global Payroll pay group or Time and Labor workgroup, if the user has a default schedule assigned.

Navigation:

**Manager Self Service > Manage Schedule Tile > Employee Search > Schedule Actions Summary > Schedule Assignment History**

This example illustrates the fields and controls on the Schedule Assignment History page.

**John Patterson**  
 Manager-Revenue  
[Return to selection page](#)

View history of Schedule Assignments, including default changes

Primary				3 rows
Effective Date	Assignment Method	Schedule Group / Description	Schedule ID / Description	
05/07/2021	Default from Paygroup	K0CYM GP Core Schedule Group	K0WRKSCH K0WRKSCH	
09/20/2018	Predefined Schedule	KUUSA United States Schedule Group	KUSCHEDTSK Schedule with Task Profile	
01/01/2014	Predefined Schedule	K0CYM GP Core Schedule Group	KUSCHDFE1 Elapsed 8 Hour Day Definition	
Alternate				1 row
Effective Date	Assignment Method	Schedule Group / Description	Schedule ID / Description	
09/20/2018	Default from Paygroup			

This example illustrates the Schedule Assignment History page using a smartphone.

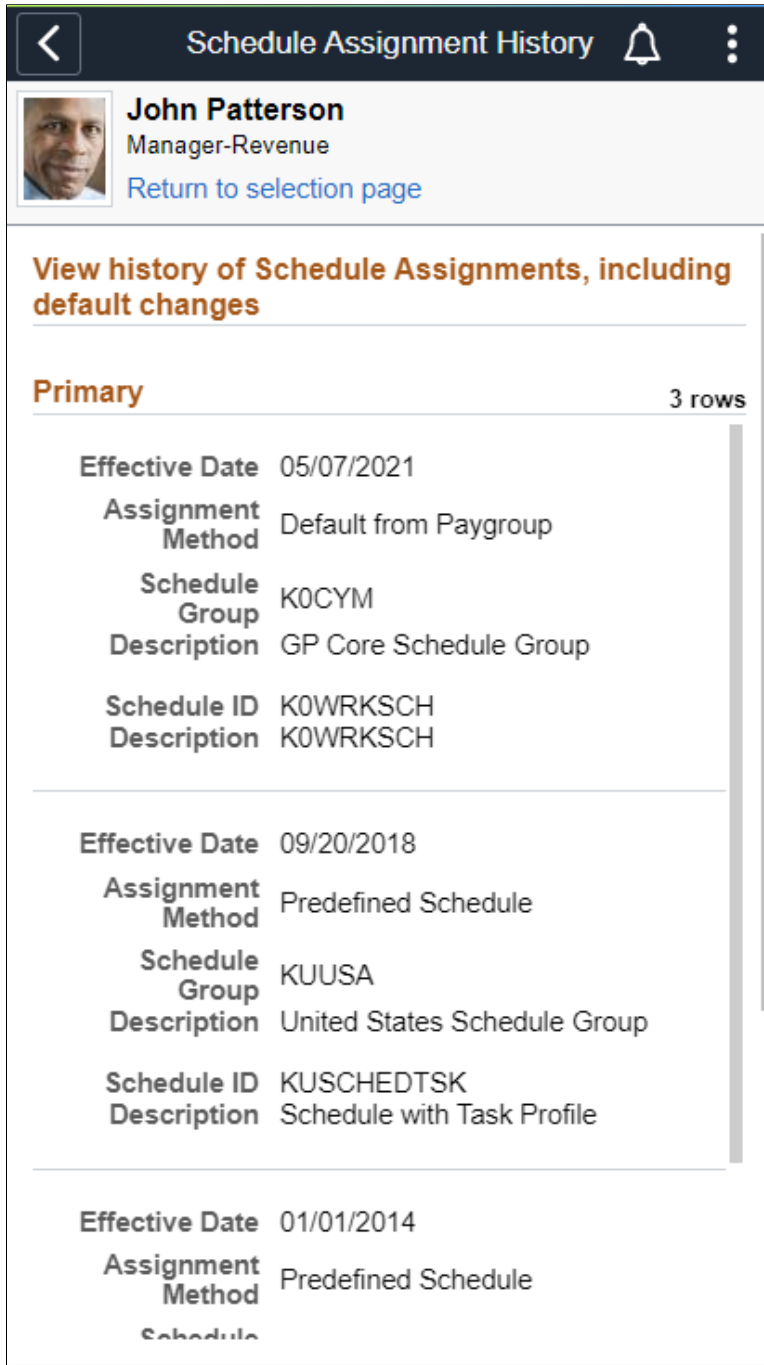

## Manage - Replace Schedule Page

Use the Replace Schedule page (MNG\_SCH\_FL) to schedule a replacement for an employee for a day.

Select the employee to be replaced from the Search Results page.

On the Replace Schedule page, change the date, if required, and select one employee to substitute the schedule for the day. By default, the current data populates.

Navigation:

**Manager Self Service > Manage Schedule Tile > Employee Search > Schedule Actions Summary > Replace Schedule**

This example illustrates the fields and controls on the Replace Schedule page. You can find definitions for the fields and controls later on this page.

**Replace Schedule**

Replacement Date: 03/07/2022

Schedule ID / Description: KUSCHDFE1  
Elapsed 8 Hour Day Definition

Replace

Replace With

Name / Job Title	Status	Schedule Id / Description	Schedule Calendar	Schedule Preferences
Edmund Donahue Manager-Accounting	Ideal Match	K0WRKSCH K0WRKSCH		
Mei Lee Accountant	Ideal Match	K0WRKSCH K0WRKSCH		
Shawn Quilligan Financial Analyst	Ideal Match	KUSCHDFE1 Elapsed 8 Hour Day Definition		
Daryl Reese Financial Analyst	Ideal Match	KUSCHDFE1 Elapsed 8 Hour Day Definition		
Vicki Zinn Accountant	Ideal Match	KUSCHDFE1 Elapsed 8 Hour Day Definition		



This example illustrates the Replace Schedule page using a smartphone

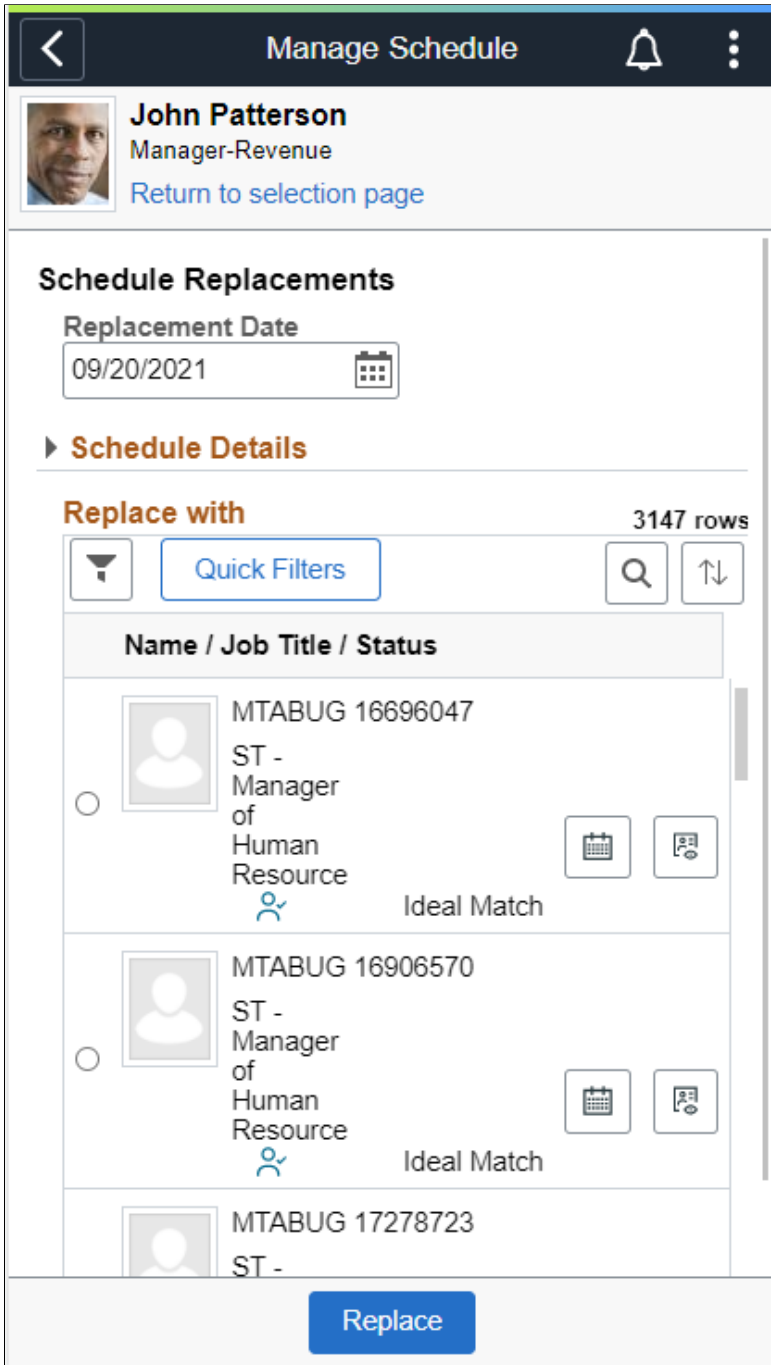

<b>Field or Control</b>	<b>Description</b>
	<p>Select to look up potential substitutes (other employees) for the specified replacement date on the employee's schedule using the Filters page (modal).</p> <p>Search fields that appear on the Filters page are enabled to be included in search criteria on the <a href="#">Manager Search Options - Select Default Criteria and Options Page</a>.</p>

<b>Field or Control</b>	<b>Description</b>
	Select to access predefined filters based on matched status.
<b>Status</b>	Identify the ideal match or employees with conflicting schedules or who are not available. By default, filters are set to <b>View All</b> .
<b>Schedule Calendar</b>	<p>Select to access the respective Schedule Calendar for the employee.</p> <p>For employees whose shifts are overridden for the dates selected, the Schedule ID/Description column will display as "Shift Overriden" and the corresponding Schedule Calendar selection will be disabled.</p>
<b>Schedule Preferences</b>	View an employee's contact and schedule preferences.

From the **Replace With** section, you can select only one employee as the replacement.

### Quick Filter

These are the pre-defined filters that target employees into defined categories.

This example illustrates the fields and controls on the Manage Schedule pages with Quick Filters. You can find definitions for the fields and controls later on this page.

**Replace Schedule**

Replacement Date: 03/07/2022

Schedule ID / Description: KUSCHDFE1  
Elapsed 8 Hour Day Definition

**Replace With** (5 rows)

Name / Job Title	Match	Schedule Calendar	Schedule Preferences
Edmund Donahue Manager-Accounting	Ideal Match	K0WRKSCH	
Mei Lee Accountant	Ideal Match	K0WRKSCH	
Shawn Quilligan Financial Analyst	Ideal Match	KUSCHDFE1 Elapsed 8 Hour Day Definition	
Daryl Reese Financial Analyst	Ideal Match	KUSCHDFE1 Elapsed 8 Hour Day Definition	
Vicki Zinn Accountant	Ideal Match	KUSCHDFE1 Elapsed 8 Hour Day Definition	

Fields or controls and descriptions for Quick Filters:

<b>Field or Control</b>	<b>Description</b>
<b>Ideal Match</b>	<p>All employees based on the Manager Self Service search filter appear in this bucket if they satisfy the following criteria:</p> <ul style="list-style-type: none"> <li>For Punch Employees their punch begin and end times do not overlap with the source employee begin and end times for the selected date range.</li> <li>For Elapsed and Punch employees, they should not have any approved absence or training for the selected date range.</li> <li>Employee does not have an OFF during the selected date range.</li> </ul>

<b>Field or Control</b>	<b>Description</b>
<b>Unavailable</b>	<p>All employees based on the Manager Self Service search filter appear in this bucket if they satisfy the following criteria:</p> <ul style="list-style-type: none"> <li>• For Elapsed and Punch employees, they should not have an approved absence or training for the selected date range.</li> <li>• Employee does not have an OFF during the selected date range.</li> </ul>
<b>Shift Conflict</b>	<p>All employees based on the Manager Self Service search filter appear in this bucket if they satisfy the following criteria:</p> <p>For Punch Employees their punch begin and end times overlaps with the source employee begin and end times for the selected date range.</p>

On Selecting **Replace**, a message indicates that the replacement was successful for the employee for the selected date.

After successful replacement, the **Replace** button appears as the **Undo Replacement** button. The replaced employee inherits the schedule of the existing employee. It also retains the original schedule to represent the previous schedule and for appropriate payment in case the employee reports absence for the day.

If a replacement already exists for the source employee or the selected employee for the date chosen, then an informational message is displayed for managers and administrators so that they are aware of it.

## Manage Schedule - Swap Schedules Page

Use the Manage Schedule - Swap Schedules page (MNG\_SCH\_FL) to swap schedules.

On the Manage Schedule - Swap Schedules page, change the start and end dates if required, and select an employee to swap the schedules for the day. By default, it populates the current day for both begin and end dates.

Navigation:

**Manager Self Service > Manage Schedule Tile > Employee Search > Schedule Actions Summary > Swap Schedules**

This example illustrates the fields and controls on the Manage Schedule - Swap Schedules page. You can find definitions for the fields and controls later on this page.

**John Patterson**  
Manager-Revenue  
[Return to selection page](#)

**Swap Schedules**

Start Date: 09/14/2021    End Date: 09/14/2021    Schedule ID / Description: KUSCHDFE1 Elapsed 8 Hour Day Definition    [Schedule Calendar](#)    [Swap](#)

Swap with: [Quick Filters](#)    13 rows

Name / Job Title	Status	Schedule Id / Description	Schedule Calendar	Schedule Preferences
Jeff Backus Finance Specialist	Ideal Match	KUSCHDFE1 Elapsed 8 Hour Day Definition		
Monica Baker Senior Finance Specialist	Ideal Match	KUSCHDFE1 Elapsed 8 Hour Day Definition		
Kim Balingier Data Entry Operator	Ideal Match	KUSCHDFE1 Elapsed 8 Hour Day Definition		
Chase Calder General Ledger Specialist	Ideal Match	KUSCHDFE1 Elapsed 8 Hour Day Definition		
Melissa Caldwell File Clerk	Ideal Match	KUSCHDFE1 Elapsed 8 Hour Day Definition		
Melissa Caldwell Clerk	Ideal Match	KOWRKSCH KOWRKSCH		
Heidi Dubas Finance Specialist	Ideal Match	KUSCHDFE1 Elapsed 8 Hour Day Definition		
Michael Knight Accounting Clerk	Ideal Match	KOWRKSCH KOWRKSCH		

This example illustrates the Manage Schedule - Swap Schedules page using a smartphone.

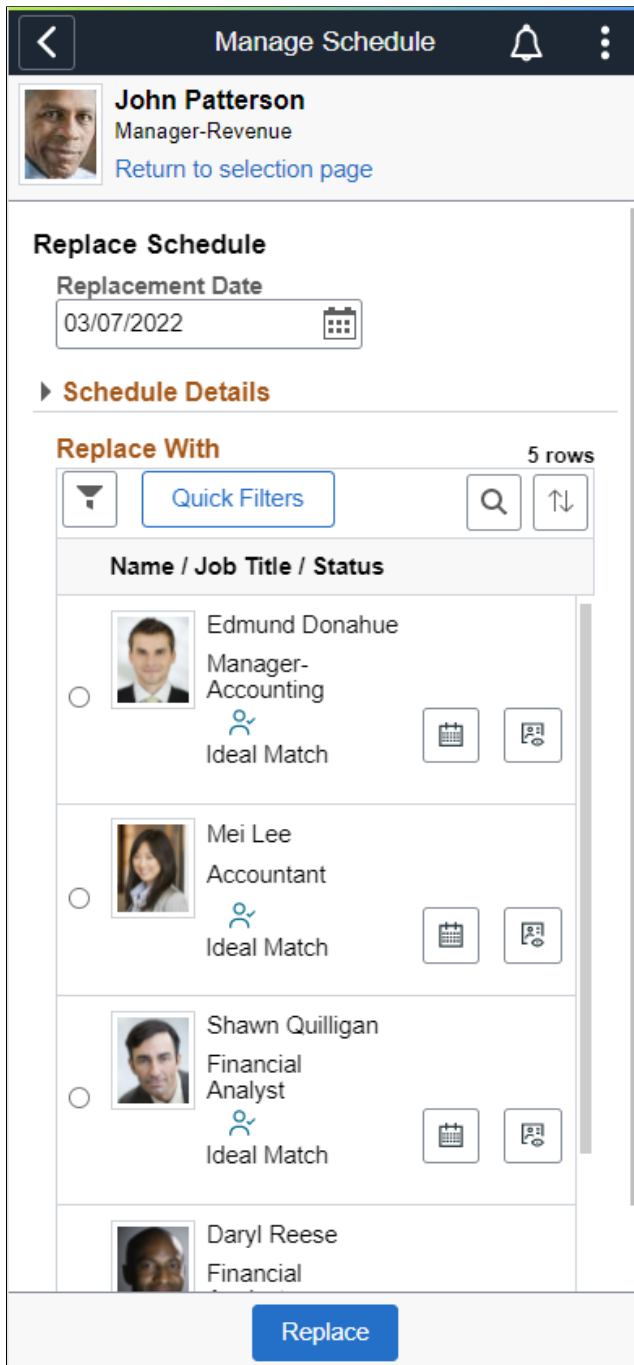

The **Swap with** grid shows the employees that are returned from the search on the Filters page.

You can select only one employee to swap.

If a swap event already exists for the source employee or the selected employee for the date chosen, then an informational message is displayed for managers and administrators so that they are aware of it.

## Manage Schedule - Copy Schedules Page

Use the Manage Schedule - Copy Schedules page (MNG\_SCH\_FL) to copy an employee's schedule to be used by another employee for a day or specified date range.

On the Manage Schedule - Copy Schedules page, change the dates if required, and select the employees to copy the schedules for. By default, it populates the current day for both begin and end dates.

Navigation:

**Manager Self Service > Manage Schedule Tile > Employee Search > Schedule Actions Summary > Copy Schedules**

This example illustrates the fields and controls on the Manage Schedule - Copy Schedules page.

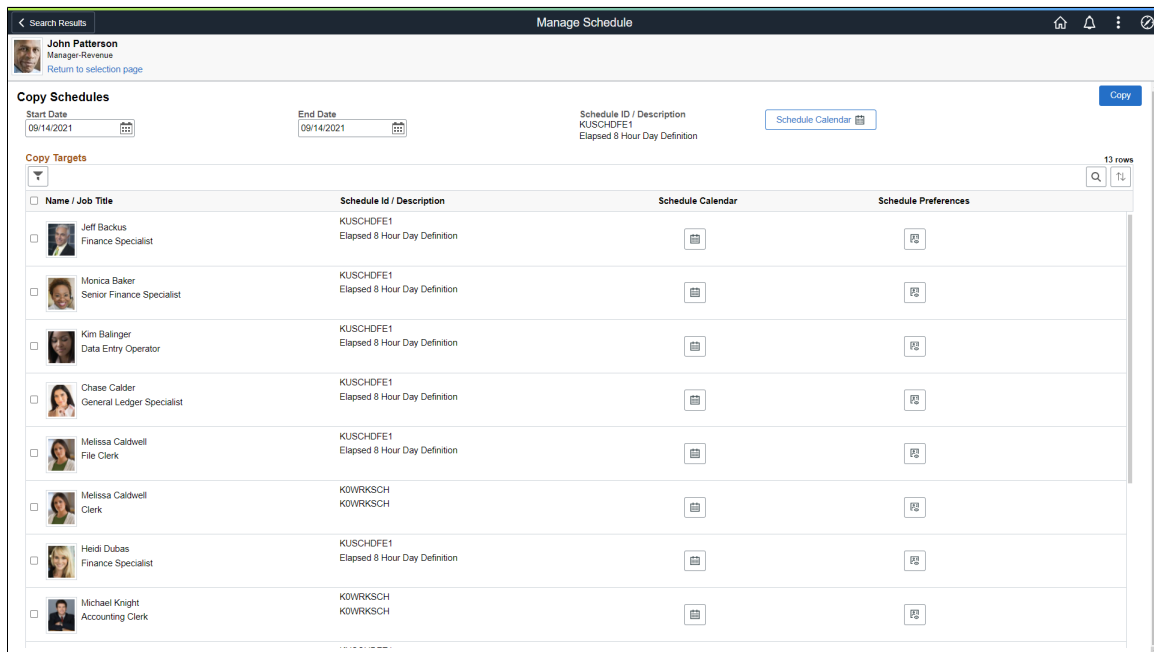

This example illustrates the Manage Schedule - Copy Schedules page using a smartphone.

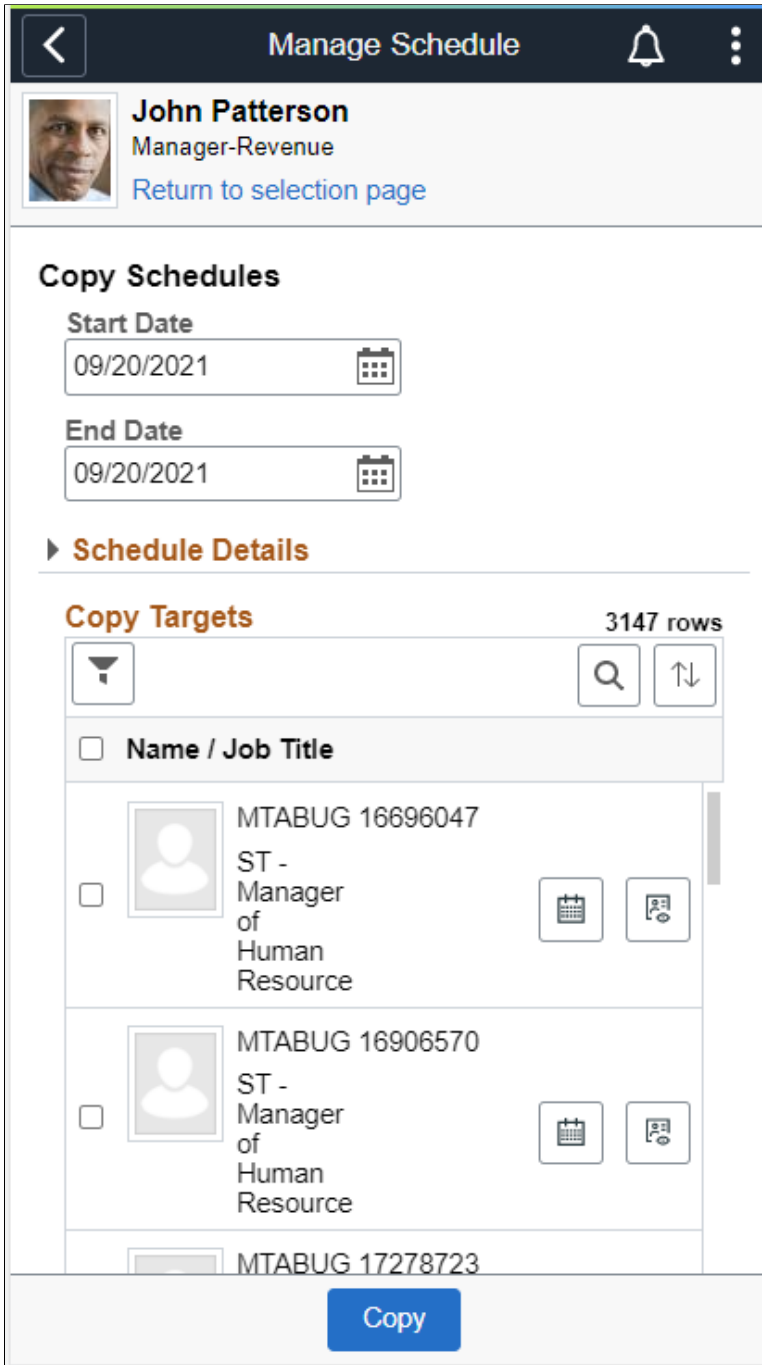

The **Copy Targets** grid shows the employees that are returned from the search on the Filters page.

## Schedule Preferences Page

Use the Schedule Preferences page (SCH\_EE\_PREF\_FL) to view the employee's contact and schedule preferences.

Navigation:



## Manager Self Service > Manage Schedule Tile > Employee Search > Schedule Actions Summary > View Schedule Preferences

This example illustrates the fields and controls on the Schedule Preferences page.

The screenshot displays the 'Schedule Preferences' page for John Patterson. At the top, there is a navigation bar with a back arrow, 'Search Results', and the page title 'Schedule Preferences'. Below this, the user's profile is shown: John Patterson, Manager-Revenue, with a 'Return to selection page' link. The 'Contact Preference' section lists a phone number (973.701.9200) and an email address (John.Patterson@oraclesample.com). The 'Schedule Preferences' section includes a toggle for 'Willing to work compressed' set to 'No'. Below this is a table with the following data:

Day Of Week	Shift	Start Time	End Time	Overtime	Double Shifts
Monday				No	No
Tuesday				No	No
Wednesday				No	No
Thursday				No	No
Friday				No	No
Saturday				No	No
Sunday				No	No

This example illustrates the Schedule Preferences Page using a smartphone.

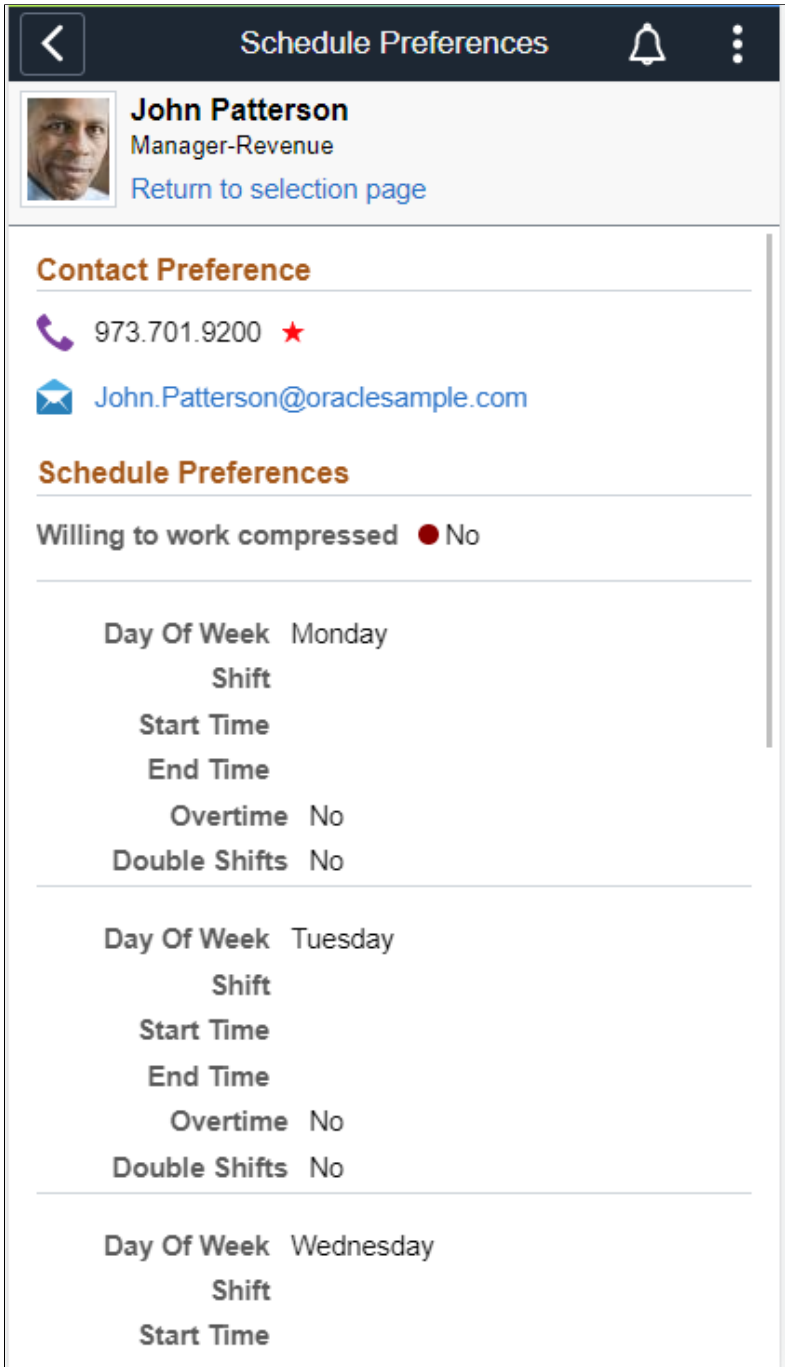

<i>Field or Control</i>	<i>Description</i>
<b>Contact Preference</b>	The manager or administrator can view the employee's preferred phone number and email address.
<b>Schedule Preferences</b>	View the shift or start and end times an employee prefers to work for each day of the week.

<b>Field or Control</b>	<b>Description</b>
<b>Willing to work compressed</b>	View if an employee is willing to work a compressed work week.
<b>Shift</b>	The managers and administrators can view the shift an employee prefers to work. This field is populated based on the particular EmplID.
<b>Start Time, End Time</b>	View the start and end times an employee prefers to work.
<b>Overtime</b>	View if an employee is willing to work overtime.
<b>Double Shifts</b>	View if an employee is willing to work double shifts.

## Override Schedules Page

Use the Override Schedules page to override the schedule of an employee for a day.

Navigation:

**Manager Self Service > Manage Schedule Tile > Employee Search > Schedule Actions Summary > Override Schedules**

Choose the date by navigating through the dates using the Previous and Next day selector on the date header, or by selecting the date and using the calendar.

Expand the **Instructions** section to view the instructions on how to use the page.

This example illustrates the fields and controls on the Override Schedules page.

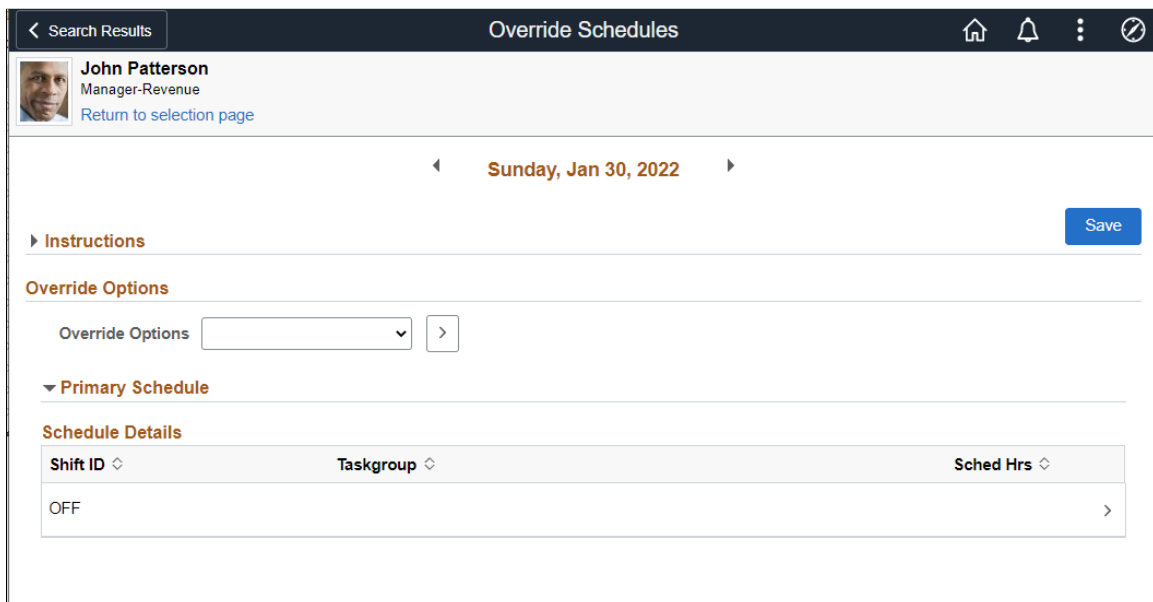

This example illustrates the override Schedules Page using a smartphone.

The screenshot displays the 'Override Schedules' page on a mobile device. At the top, there is a navigation bar with a back arrow, the title 'Override Schedules', a notification bell, and a menu icon. Below this is a user profile for John Patterson, Manager-Revenue, with a 'Return to selection page' link. The main content area features a date selector for 'Monday, Jan 31, 2022' with left and right navigation arrows. There are three expandable sections: 'Instructions', 'Override Options' (containing a dropdown menu and a right arrow), and 'Primary Schedule'. The 'Primary Schedule' section is expanded to show a table with columns 'Shift ID', 'Taskgroup', and 'Sched Hrs'. The 'Sched Hrs' column has a value of '6.00' and a right arrow. At the bottom of the page is a blue 'Save' button.

Choose the date by navigating through the dates using the Previous and Next day selector on the date header, or by selecting the date and using the calendar.

<b>Field or Control</b>	<b>Description</b>
<b>Instructions</b>	Expand section to view instructions about how to use the page.

<b>Field or Control</b>	<b>Description</b>
<b>Override Options</b>	<p>The schedule override options are in the drop-down list:</p> <ul style="list-style-type: none"> <li>• <b>Add a Primary Schedule:</b> Select to add a primary schedule.</li> <li>• <b>Add an Adhoc Schedule:</b> Select to add an adhoc schedule.</li> <li>• <b>Add an alternate Schedule:</b> Select to add an alternate schedule.</li> </ul> <hr/> <p><b>Note:</b> The alternate schedule will not show in the drop-down list for employees who do not have an alternate schedule to add.</p>
<b>Primary Schedule</b>	Schedule Type field is hidden and only primary schedules are shown.
<b>Schedule Details</b>	Shows the Schedule details.

Select **Add a Primary Schedule** to enter the details of **Shift ID**, **Off Day Indicator**, **Task Group** and **Sched Hrs**

This example illustrates the fields and controls on the Add a Primary Schedule\_Override Schedules page.

<b>Field or Control</b>	<b>Description</b>
<b>Shift ID</b>	Select to Add or change a shift.

<b>Field or Control</b>	<b>Description</b>
<b>Taskgroup</b>	Select Taskgroup details.
<b>Off Day Indicator</b>	Select the slider to indicate <b>Wok</b> or <b>Off</b> .  The <b>Off</b> selector determines that the <b>Scheduled Hrs</b> are zero, it does not change the duration of the off shift.
<b>Sched Hrs</b>	Enter the Schedule hours details.
	Click to override information and update schedule views.
<b>Schedule Details</b>	Lists the Schedule Details added. Select the line to open the Edit override schedules modal.

### Edit override schedules modal

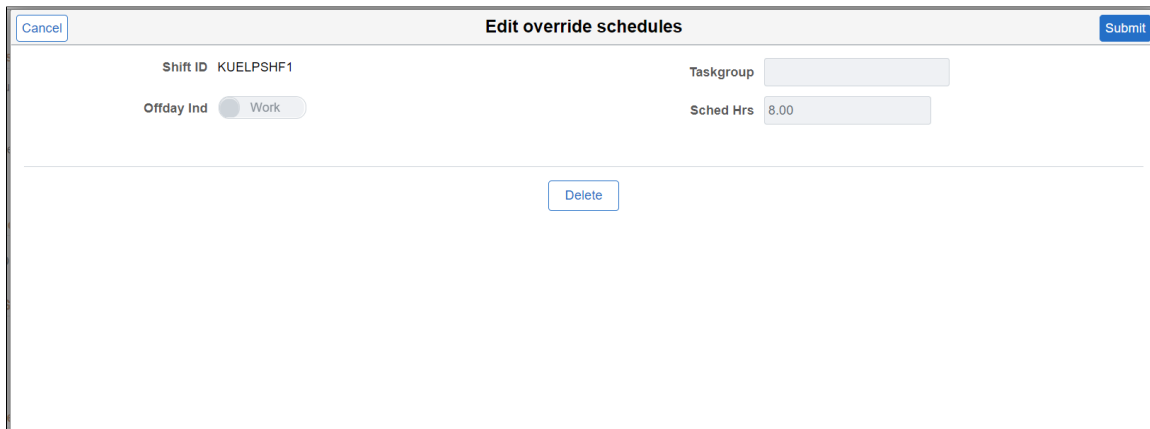

The screenshot shows the 'Edit override schedules' modal. At the top left is a 'Cancel' button and at the top right is a 'Submit' button. The modal contains the following fields and controls:

- Shift ID: KUELPSHF1
- Taskgroup: [Empty text input field]
- Offday Ind: [Work] (radio button)
- Sched Hrs: 8.00 (text input field)
- At the bottom center, there is a 'Delete' button.

Select **Submit** or **Delete** according to your need.

This example illustrates the Add a Primary Schedule using Override Schedules Page using a smartphone.

The screenshot shows a mobile application interface for "Override Schedules". At the top, there is a navigation bar with a back arrow, the title "Override Schedules", a notification bell, and a menu icon. Below the navigation bar is a user profile section for "John Patterson", Manager-Revenue, with a "Return to selection page" link. The main content area is for "Monday, Jan 31, 2022". It includes an "Instructions" section, followed by "Override Options" where "Add a Primary Schedule" is selected in a dropdown menu. Underneath is a "Primary Schedule" section with input fields for "Shift ID" and "Taskgroup", each with a search icon. There is a radio button for "Off Day Indicator" set to "Work", and a "Sched Hrs" input field. Below these are "Punch Details" with input fields for "In", "Break", "In", and "Lunch". A blue "Save" button is located at the bottom of the form.

Select the *Add an Adhoc Schedule* override option to add adhoc punch schedules.

This example illustrates the fields and controls on the Add an Adhoc Schedule page.

<b>Field or Control</b>	<b>Description</b>
	Select to reset the schedule added.
<b>Punch Details</b>	Enter punch details like In, Breaks, Lunch, Out and Time Zone.
<b>Schedule Details</b>	Display the schedule details including the punch range.



This example illustrates the Add an Adhoc Schedule Page using a smartphone.

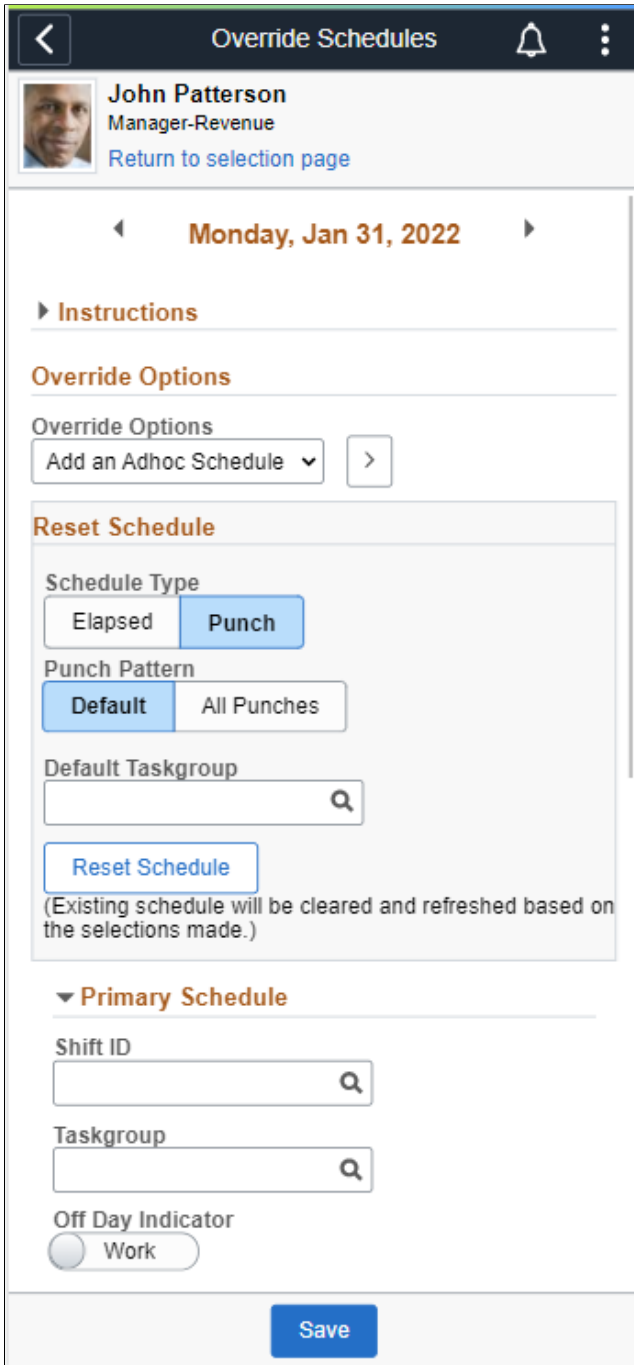

Select **All Punches** to show all the punch pattern.

---

**Note:** Multiple shifts can be entered as a schedule override for a day. If you enter a punch shift that overrides the times of another punch shift for the day, you will receive a warning message. The Alternate Schedule Detail tab is displayed only if core Global Payroll or Absence Management are installed and selected on the Installation Table – Products page.

---

This example illustrates the fields and controls on the Add an Adhoc Schedule for all Punches page.

< Search Results
Override Schedules

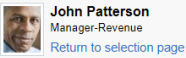

Monday, Jan 31, 2022

Save

▶ **Instructions**

**Override Options**

Override Options Add an Adhoc Schedule >

**Reset Schedule**

Schedule Type Elapsed Punch

Default Taskgroup  Q

Punch Pattern Default All Punches

Reset Schedule

(Existing schedule will be cleared and refreshed based on the selections made.)

▼ **Primary Schedule**

Shift ID  Q

Off Day Indicator  Work

Taskgroup  Q

Sched Hrs

**Punch Details**

In

1st Break

In

Lunch

In

2nd Break

In

Transfer

Out

Time Zone  Q

**Schedule Details**

Shift ID	Taskgroup	Punch Range	Sched Hrs

This example illustrates the Add an Adhoc Schedule for all PunchesPage using a smartphone.

**John Patterson**  
 Manager-Revenue  
[Return to selection page](#)

**Schedule Type**  
 Elapsed **Punch**

**Punch Pattern**  
 Default **All Punches**

**Default Taskgroup**

(Existing schedule will be cleared and refreshed based on the selections made.)

**▼ Primary Schedule**

**Shift ID**

**Taskgroup**

**Off Day Indicator**  
 Work

**Sched Hrs**

**Schedule Details**

Shift ID	Taskgroup	Sched Hrs
KUELPSHF1		8.00 >

## Managing Schedules Using Fluid for Employees

This topic provides an overview on how to request schedule change for employees using fluid.

## Pages Used to Manage Schedules using Fluid

<b>Page Name</b>	<b>Definition Name</b>	<b>Usage</b>
<u>Request Schedule Change Tile</u>	HC_SCH_EE_REQ_FL_GBL	Select to access the schedule change actions like give up your shift and trade your shift.
<u>Request Schedule Change Page</u>	SCH_EE_REQ_CHG_FL	Request schedule change page where an employee can give up or trade their shifts.
<u>Give up your Shift Page</u>	SCH_EE_REP_REQ_FL	Employee can request their manager to give up and re-assign their shift.
<u>Trade your Shift Page</u>	SCH_EE_SWAP_REQ_FL	Employee can request their manager or coworker to swap their shift with a chosen co-worker.
<u>Schedule Calendar Page</u>	SCH_CALENDAR_SCF	View periods of the employees' schedule.

### Request Schedule Change Tile

Employees can use the Request Schedule Change tile to navigate to the Request Schedule Change page.

Navigation:

For employees, select the Time tile to open the landing page with the Request Schedule Change Tile.

This example illustrates the fields and controls on the Request Schedule Change Tile

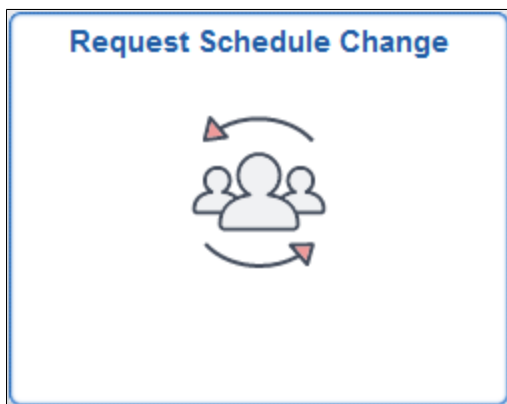

Use Request Schedule Change tile to access the Request Schedule Change page to request the schedule change.

## Request Schedule Change Page

Use the Request Schedule Change page (SCH\_EE\_REQ\_CHG\_FL) to request change in the employee's shift.

Navigation:

**Employee Self Service > Time > Request Schedule Change tile**

This example illustrates the fields and controls on the Request Schedule Change page.

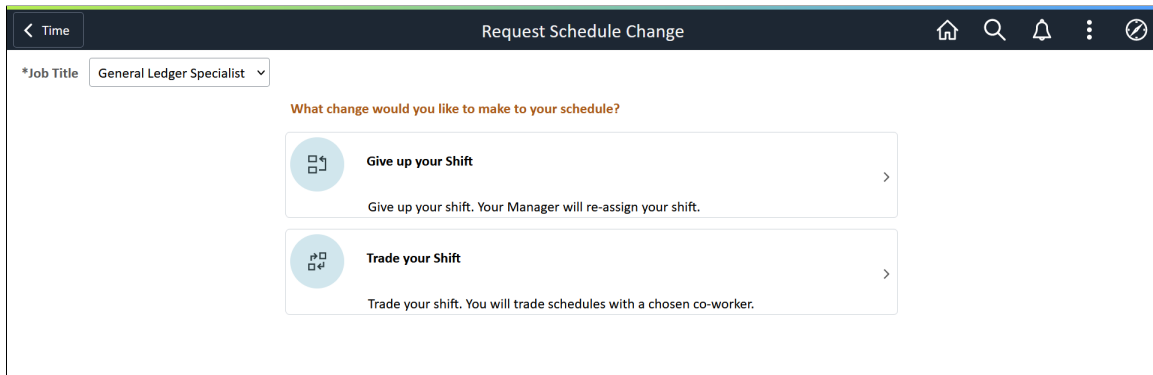

The Request Schedule Change page includes the following options to navigate to:

- Give up your Shift Page
- Trade your Shift Page

The **Job Title** field will be enabled for employees with multiple active jobs.

## Give up your Shift Page

Use the Give up your Shift page (SCH\_EE\_REP\_REQ\_FL) to request the manager to either re-assign the employee's shift or remove the shift from the employee's schedule. The term, 'Give up your Shift' is derived from the message text catalog and can be renamed.

Navigation:

**Employee Self Service > Time > Request Schedule Change Tile > Give up your Shift**

This example illustrates the fields and controls of the Give up your Shift Page. You can find definitions for the fields and controls later on this page.

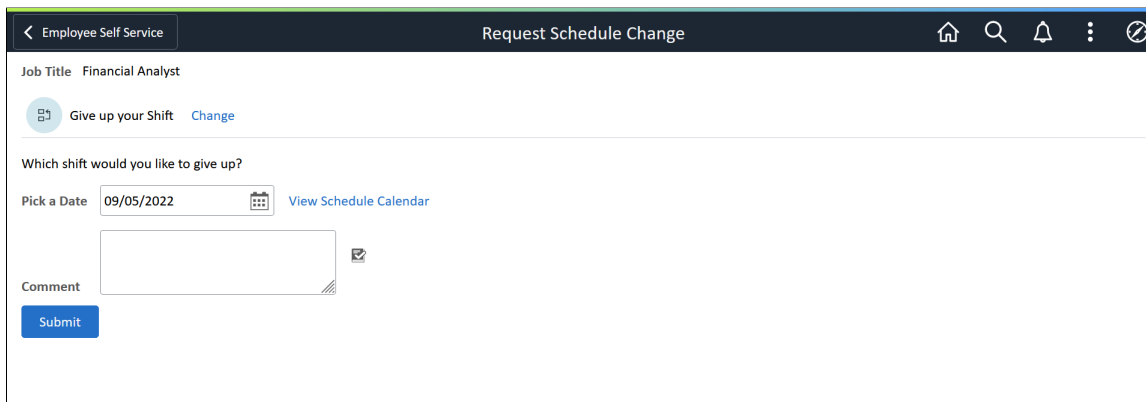

<b>Field or Control</b>	<b>Description</b>
<b>Job Title</b>	Shows the job title of the employee.
<b>Change</b>	Select to go back to the previous page.
<b>Pick a Date</b>	Select the date of the shift that employee would like to give up or request replacement for.
<b>View Schedule Calendar</b>	Opens up the employee's calendar on the <a href="#">Schedule Calendar Page</a> . By default it opens for the date chosen.
<b>Comment</b>	Allows employee to add any comment for their manager. Use the <b>Spell Check</b> icon to correct the spelling.
<b>Submit</b>	Select to submit the request to the manager and go to the Request Summary page.

**Note:** Employees will not be able to request replacement for any date in the past.

**Note:** If there is already a replacement in place for the employee for the date selected, then a message will appear and the submit button will be disabled.

If approvals are defined under the "Replace Schedule" section of the employee's work-group approval set-up then the routing will honor the approval definition defined in that set-up. For details, see [Setting Up Workgroups](#).

If Approvals are not enabled, then the request will be routed to the employee's manager based on the direct reports set-up. Refer to [Understanding the Approval Process in Time and Labor](#)

## Request Summary Page

Use the Request Summary page (SCH\_EE\_REQ\_SUM\_FL) to view the request submitted to the manager.

Navigation:

The request summary page appears on submit of a request either for Give up your shift or Trade your shift.

---

**Note:** The request summary page can also be accessed through the notifications panel on the home page when a request is raised.

---

This example illustrates the fields and controls on the Request Summary page

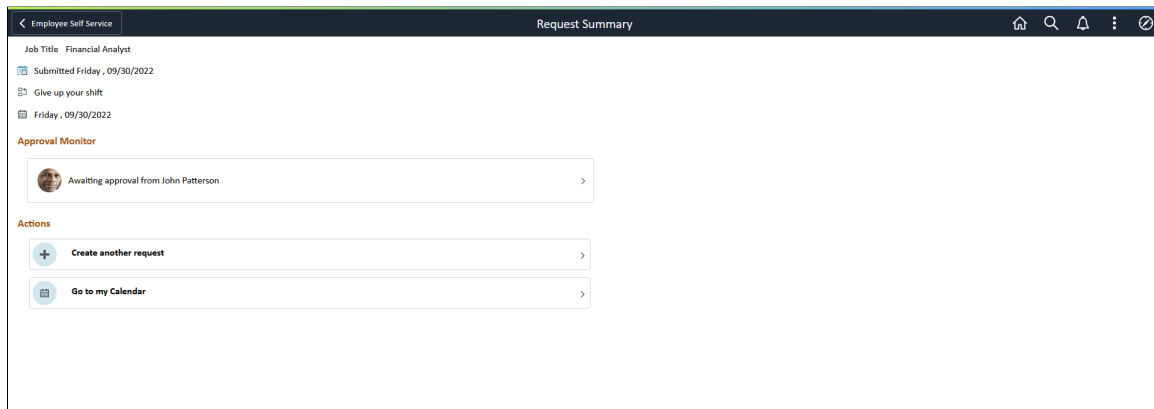

<b>Field or Control</b>	<b>Description</b>
<b>Awaiting approval from &lt;Manager&gt;</b>	<p>Opens up the approval monitor page.</p> <hr/> <p><b>Note:</b> The Approval Monitor will not be displayed if the approval is not enabled for the user at the workgroup level. The employee and the manager will be notified through the notifications panel. Manager will be redirected to the <a href="#">Manage - Replace Schedule Page</a> by clicking on the notification.</p>
<b>Create another request</b>	Allows employees to submit another request.
<b>Go to my Calendar</b>	Opens up the “Employee Calendar Views” (PeopleSoft Absence Management) of the team calendar.

## Trade your Shift Page

Use the Trade your Shift page (SCH\_EE\_SWAP\_REQ\_FL) to swap schedules with a chosen co-worker.

On the Trade your Shift page, change the begin and end dates, and select an employee to swap schedules with, for the chosen day or period. By default, it populates the current day for both begin and end dates.

Navigation:

**Employee Self Service > Time > Request Schedule Change Tile > Trade your Shift**

This example illustrates the fields and controls on the Trade Shift page. You can find definitions for the fields and controls later on this page.

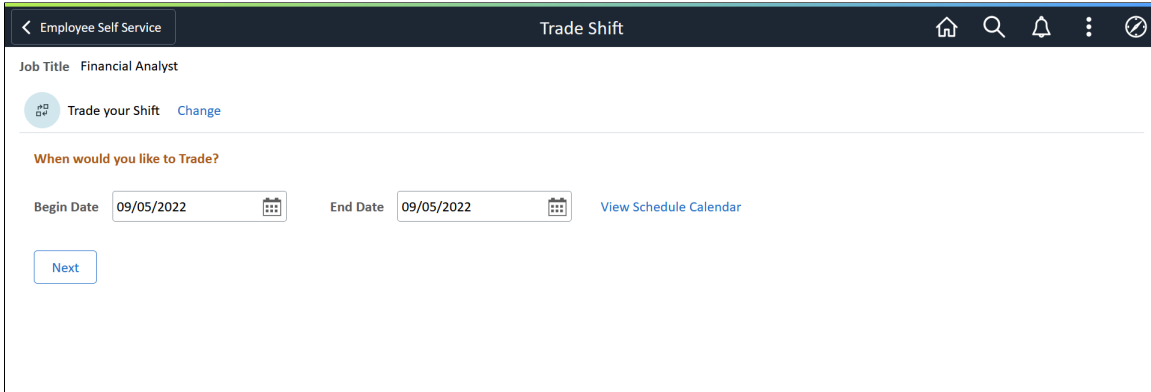

<b>Field or Control</b>	<b>Description</b>
<b>Begin Date</b>	Select the start date of the shift that employees would like to swap.
<b>End Date</b>	Select the end date of the shift that employees would like to swap.
<b>View Schedule Calendar</b>	Opens up the employee's calendar on the <a href="#">Schedule Calendar Page</a> . By default it opens for the begin date entered.
<b>Next</b>	Select to choose the list of co-workers.

Selecting the **Next** button shows the following options:

- [Display Only Employees with No Conflicts](#)
- [View All](#)

---

**Note:** If there is already a trade or give up your shift for the employee for the dates selected, then a message will appear and the submit button will be disabled.

---



This example illustrates the fields and controls on the Trade Shift Action page. You can find definitions for the fields and controls later on this page.

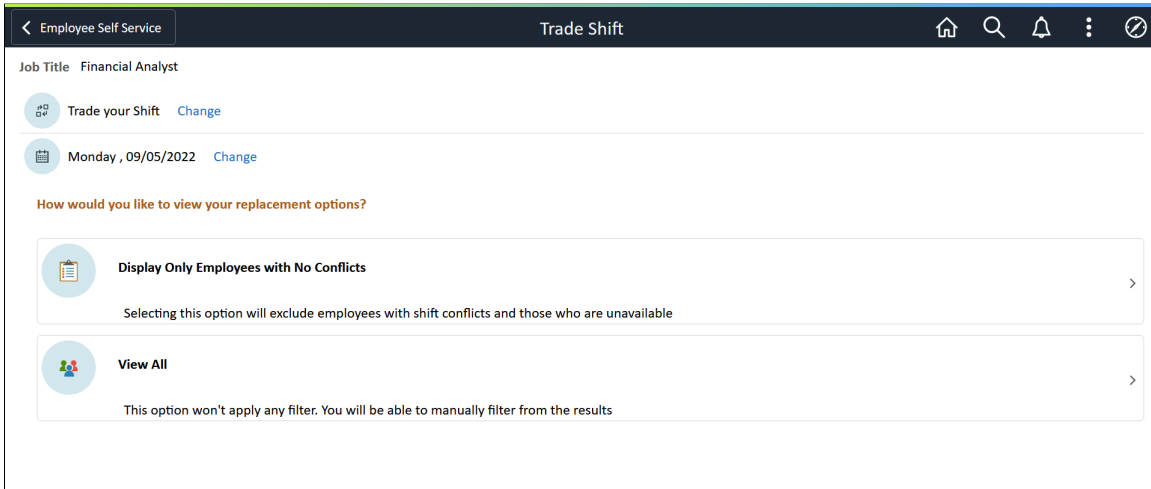

Employees will not be able to request trade shift for any date in the past.

## Schedule Calendar Page

Use the Schedule Calendar page (SCH\_CALENDAR\_SCF) to view periods of the employee's schedule.

Navigation:

Select the **View Schedule Calendar** link on the Trade your Shift page.

This example illustrates the fields and controls on the Schedule Calendar grid. You can find definitions for the fields and controls later on this page.

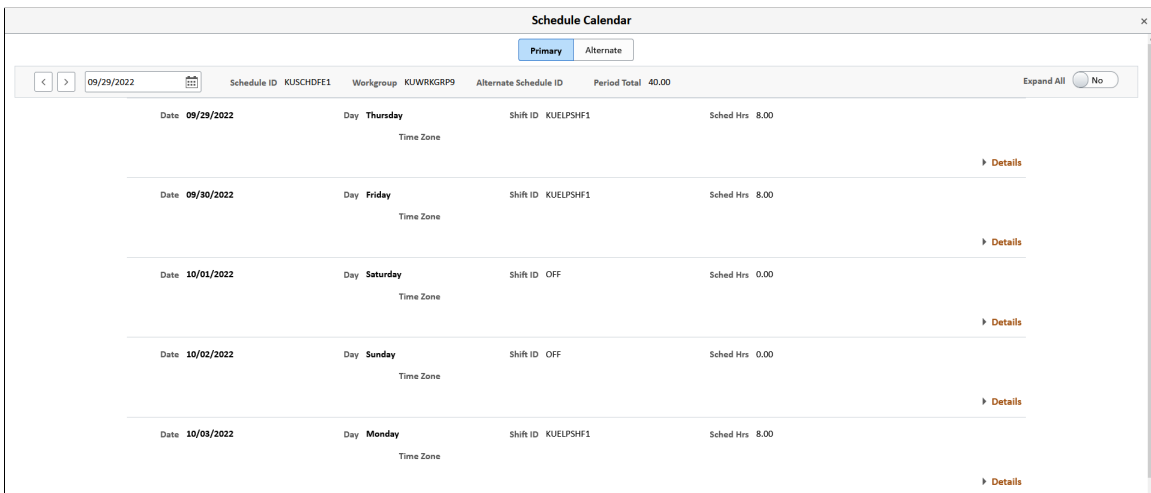

The header area of the Schedule Calendar page displays the schedule ID, Workgroup, Alternative schedule ID, Period Total values, as well as the field to change the date and buttons to navigate to previous and next weeks of the calendar.

**Note:** The Alternate tab will be inactive for users who do not have an alternate schedule.

<b>Field or Control</b>	<b>Description</b>
<b>Expand All</b>	Expand all of the Schedule Calendar details under each workday.
<b>Period Total</b>	Displays the sum of the work hours for a particular period in the schedule calendar for the logged in employee.
<b>Details link</b>	Select to open the Shift Detail modal.  The Shift Detail grid lists the Shift Time tab, Time Reporting Elements tab (if a time reporting template is chosen), Task Reporting Elements tab (if the time reporting template has task template selected instead of task profile), and Chart fields tabs.

The Schedule Calendar area lists all of the elements associated to the schedule. The page also resolves the actual "day" associated with the dates of the schedule.

## Display Only Employees with No Conflicts

This page displays the list of co-workers available for shift trade with the provided schedule and date. It excludes the employees whose shift conflicts with the requesting employee.

Use the **Change** option to navigate to the previous pages for making changes to the type of schedule change or the selected date.

This example illustrates the fields and controls on the Display Only Employees with No Conflicts page.

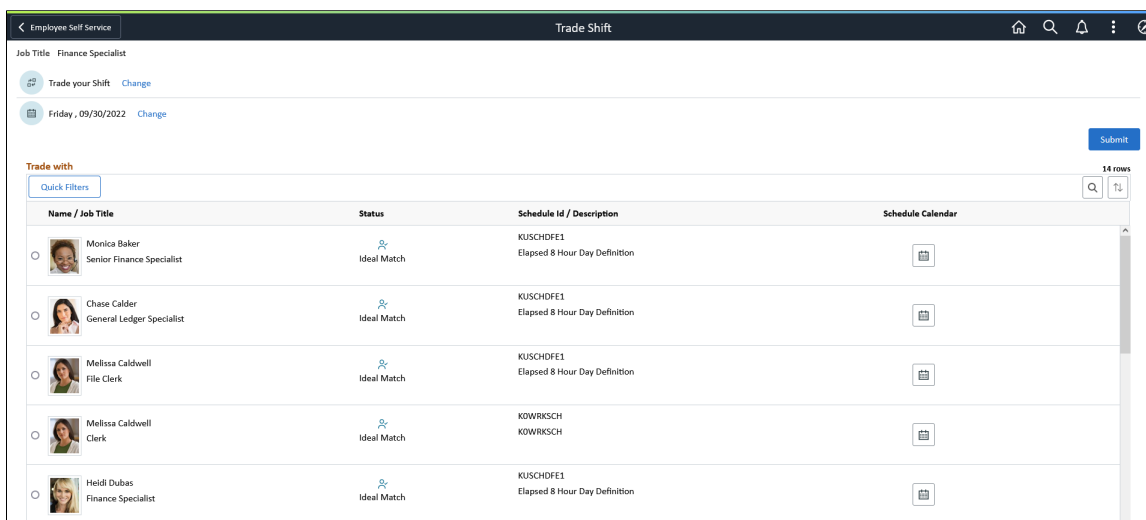

The **Trade With** grid shows the employees with no conflicts as per the selected date and shift timings.

An employee can select only one co-worker to swap their shift.

If a trade event already exists for requesting employee or the selected co-worker for the date chosen, then an informational message is displayed so that they are aware of it.

## View All

This page displays the list of all co-workers, irrespective of their availability, including shift conflicts and off shift employees.

Use the **Change** option to navigate to the previous pages for making changes to the type of schedule change or the selected date.

This example illustrates the fields and controls on the View All page.

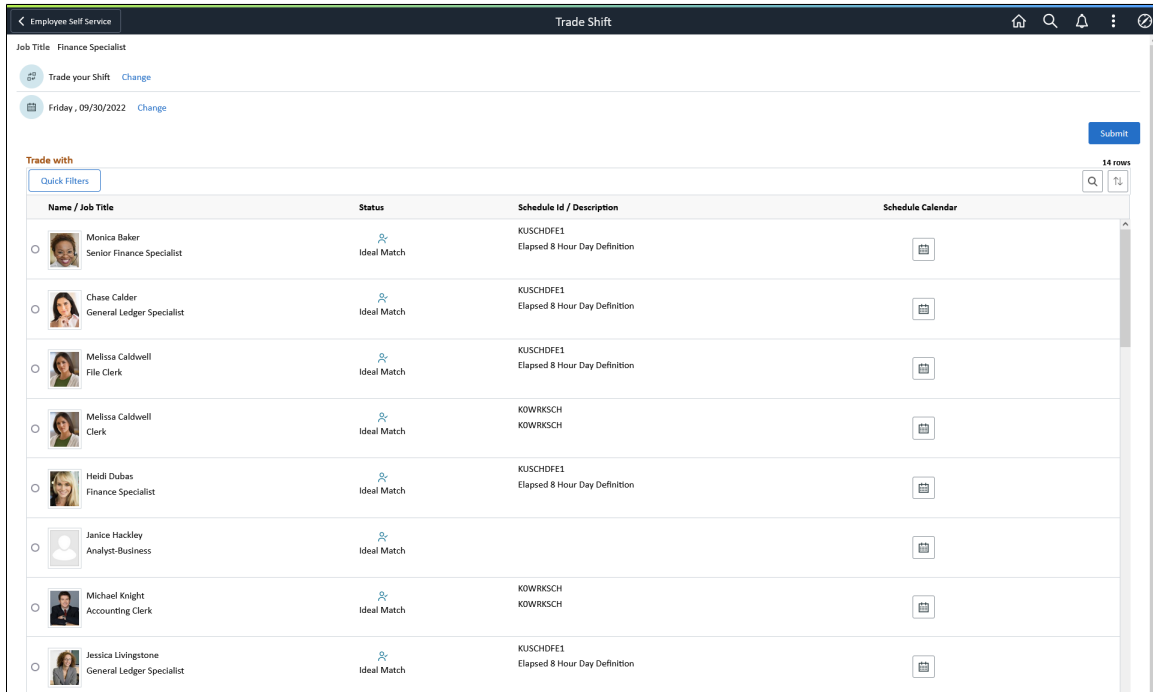

Name / Job Title	Status	Schedule Id / Description	Schedule Calendar
Monica Baker Senior Finance Specialist	Ideal Match	KUSCHDFE1 Elapsed 8 Hour Day Definition	[Calendar Icon]
Chase Calder General Ledger Specialist	Ideal Match	KUSCHDFE1 Elapsed 8 Hour Day Definition	[Calendar Icon]
Melissa Caldwell File Clerk	Ideal Match	KUSCHDFE1 Elapsed 8 Hour Day Definition	[Calendar Icon]
Melissa Caldwell Clerk	Ideal Match	KDWRKSCH KDWRKSCH	[Calendar Icon]
Heidi Dubas Finance Specialist	Ideal Match	KUSCHDFE1 Elapsed 8 Hour Day Definition	[Calendar Icon]
Janice Hackley Analyst-Business	Ideal Match		[Calendar Icon]
Michael Knight Accounting Clerk	Ideal Match	KDWRKSCH KDWRKSCH	[Calendar Icon]
Jessica Livingstone General Ledger Specialist	Ideal Match	KUSCHDFE1 Elapsed 8 Hour Day Definition	[Calendar Icon]

The **Trade With** grid shows the list of all employees irrespective of their availability with the selected date and shift timings.

The Schedule ID won't be shown for the employees who don't have a schedule assignment.

An employee can select only one co-worker who has a schedule assignment to swap shifts.

On click of the **Submit** button from the Trade Shift page, the employee can enter comments and click **Done** button to submit the changes.

This example illustrates the fields and controls on the Comment Box.

The screenshot shows a dialog box titled "Comments". At the top left is a "Cancel" button and at the top right is a "Done" button. Below the title bar, the text reads: "The following comment will be shown to your alternate and approver." Below this text is a large, empty rectangular text input field with a blue border. To the left of the input field, the text "Requester Comments" is displayed.

## Request Summary Page

Use the Request Summary page (SCH\_EE\_REQ\_SUM\_FL) to view the request submitted to the manager.

Navigation:

The request summary page appears on submit of a request either for Give up your shift or Trade your shift.

---

**Note:** The request summary page can also be accessed through the notifications panel on the home page when a schedule change request is raised.

---

This example illustrates the fields and controls on the Request Summary page

The screenshot shows the "Request Summary" page in the PeopleSoft Fluid User Interface. The page title is "Trade Shift". The user's job title is "Financial Analyst". The request was submitted on Friday, 09/30/2022. The request is for a "Trade your shift" on Tuesday, 10/04/2022 and Tuesday, 10/04/2022. Under the "Approval Monitor" section, there is a notification: "Awaiting approval from Cindy Bryson". Under the "Actions" section, there are two buttons: "Create another request" and "Go to my Calendar".

<b>Field or Control</b>	<b>Description</b>
<b>Awaiting approval</b>	Opens up the approval monitor page.  <b>Note:</b> The Approval Monitor will not be displayed if the approval is not enabled for the user at the workgroup level. The employee and the co-worker will be notified through the notifications panel.
<b>Create another request</b>	Allows employees to select and submit another request.
<b>Go to my Calendar</b>	Opens up the “Employee Calendar Views” (PeopleSoft Absence Management) of the team calendar.

## Using the PeopleSoft Fluid User Interface to Work with Time and Labor as an Administrator

This topic discusses how administrators use the PeopleSoft Fluid User Interface to perform absence-related transactions.

For general information about fluid pages in PeopleSoft HCM, see “Understanding PeopleSoft Fluid User Interface Homepages” (Application Fundamentals)

### Pages Used to Work with Time and Labor as an Administrator Using the PeopleSoft Fluid User Interface

<b>Page Name</b>	<b>Definition Name</b>	<b>Usage</b>
<u>Time and Labor Tile</u>	HC_TL_ADM_DASHBOARD_FL (this is the cref for the tile)	Select to access the dashboard containing Reported Time Audit, Time and Labor WorkCenter, Reported Time Insight, and other tiles.
<u>Time and Labor Dashboard</u>	PT_LANDINGPAGE	Access tiles for Reported Time Audit, Time and Labor WorkCenter, Reported Time Insight, and more.
<u>Reported Time Audit Page</u>	TL_AUD_RPTTIME_FL	Access the page to view current reported punch and elapsed time.
<u>Time and Labor WorkCenter Page</u>	TL_WC_APP_FL	Access various business processes to complete day-to-day work and commonly performed tasks.

<b>Page Name</b>	<b>Definition Name</b>	<b>Usage</b>
<u>Reported Time Insight Tile</u>	HC_TL_RPTD_TIME_DBRD_FL (this is the cref for the tile)	Select to access Reported Time Insight dashboard.
<u>Reported Time Insight Dashboard</u>	HC_TL_RPTD_TIME_DBRD_FL	Select to view different visualizations in Time and Labor Reported Time Insight dashboard.
<u>Manage Time Reporter Data Tile</u>	HC_TL_EMPLDATA_M_FL_GBL (this is the cref for the tile)	Search and manage Time Reporter data for the administrators using fluid pages.

## Time and Labor Tile

The Administrators use the Time and Labor tile to access the dashboard collection of tiles for Reported Time Audit, Time and Labor WorkCenter and Reported Time Insight.

Navigation:

Select Workforce Administrator from the Fluid Home page. The Time and Labor tile is available on the Workforce Administrator landing page.

This example illustrates the Time and Labor tile.



Select the Time and Labor tile to access the Time and Labor Dashboard containing a collection of tiles for Report Time Audit, Time and Labor WorkCenter, Reported Time Insight, and more.

## Time and Labor Dashboard

The Administrators use the Time and Labor dashboard to access tiles for Reported Time Audit, Time and Labor WorkCenter, Reported Time Insight, and more.

Navigation:

Select the Time and Labor Tile from the Workforce Administrator homepage.

This example illustrates the fields and controls on the Time and Labor dashboard.

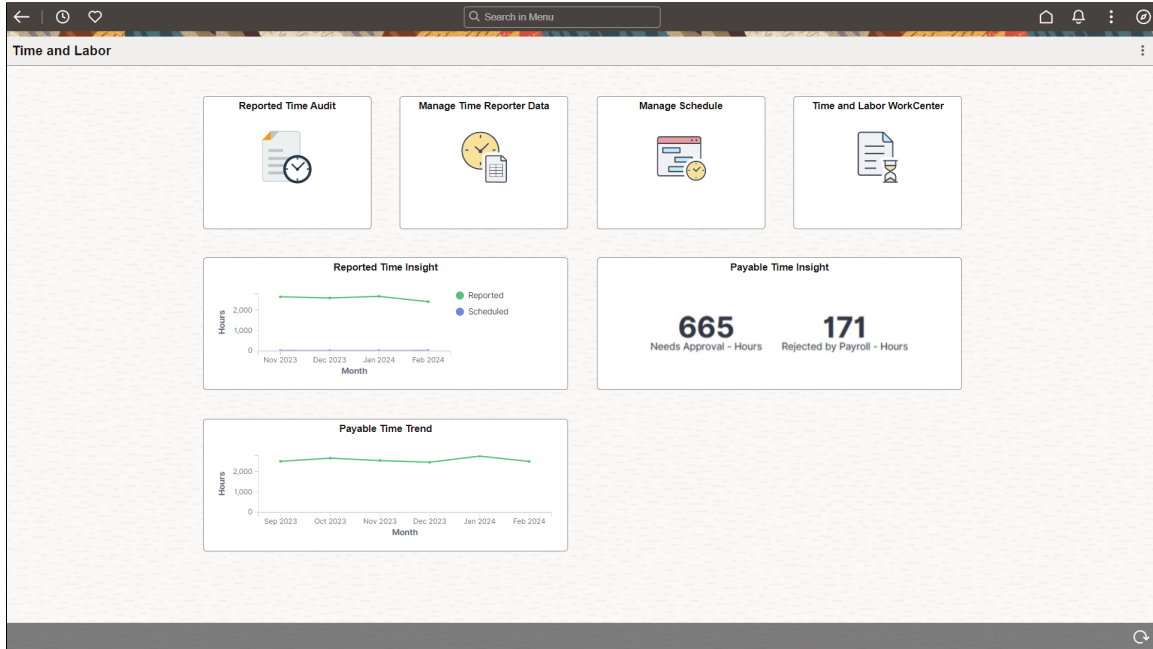

Use the links in the table to access complete documentation for each tile.

<b><i>Tile Name</i></b>	<b><i>Usage</i></b>
<a href="#"><u>Reported Time Audit Tile</u></a>	View current reported punch and elapsed time.
<a href="#"><u>Manage Time Reporter Data Tile</u></a>	Navigate to the employee search page and then create and manage enrollments in Time and Labor.
<a href="#"><u>Manage Schedule Tile</u></a>	Select to access the search criteria page and related pages for schedule actions using the Schedule Actions Summary page.
<a href="#"><u>Time and Labor WorkCenter Tile</u></a>	Access various business processes to complete day-to-day work and commonly performed tasks.
<a href="#"><u>Reported Time Insight Tile</u></a>	Select to view different visualizations in Time and Labor Reported Time Insight dashboard.
<a href="#"><u>Payable Time Insight Tile</u></a>	Review and analyze payable time using Insights visualizations.
<a href="#"><u>Payable Time Trend Tile</u></a>	Review and analyze payable time trend using Insights visualizations.

## Reported Time Audit Tile

Use Reported Time Audit tile to access the [Reported Time Audit Page](#).

Navigation:

The Reported Time Audit is available on the [Time and Labor Dashboard](#).

This example illustrates the fields and controls on the Reported Time Audit Tile.

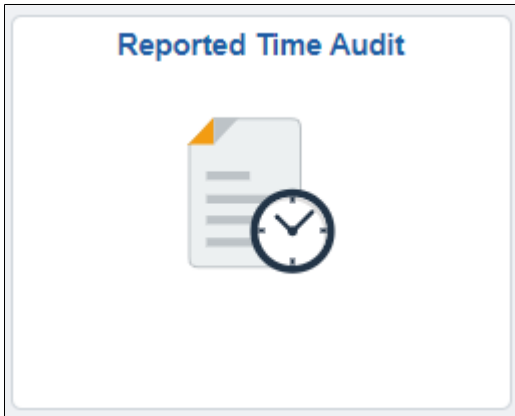

## Reported Time Audit Page

Use the Reported Time Audit page ( TL\_AUD\_RPTTIME\_FL) to view current reported punch and elapsed time.

Navigation:

Select the [Reported Time Audit Tile](#) on the [Time and Labor Dashboard](#).

The following video provides an overview of the Reported Time Audit page:

Video: [Image Highlights, PeopleSoft HCM Update Image 31: Reported Time Audit page](#)

This example illustrates the Reported Time Audit Page for Elapsed Time Reporter.

The screenshot shows the "Reported Time Audit" page in the PeopleSoft HCM interface. The page title is "Time and Labor". On the left, there is a navigation pane with "Reported Time Audit" and "Time and Labor WorkCenter". The main content area has a "Search Options" section with fields for "Name" (Patterson, John), "Job Title" (Manager-Revenue), "Start Date" (05/01/2019), and "End Date" (05/31/2019). There is a "Get Rows" button and a "Changed Value" indicator. Below this is a table with tabs for "&Overview", "&Time Reporting Elements", "Task &Reporting Elements", and "Show All". The table has columns for Status, Action, Date, Time Reporting Code, Punch Type, Quantity, Reported Status, Taskgroup, Audit User ID, Audit Date/Time, and Audit History. Two rows of data are visible:

Status	Action	Date	Time Reporting Code	Punch Type	Quantity	Reported Status	Taskgroup	Audit User ID	Audit Date/Time	Audit History
Current		05/01/2019	KUREG	Elapsed	28.00	Needs Approval	KUTSKGRP1	RCHANNING	04/30/2019 1:25:58.000000AM	
Current		05/10/2019	KUREG	Elapsed	8.00	Needs Approval	KUTSKGRP1	JPATTERSON	05/13/2019 8:25:20.000000PM	



This example illustrates the Reported Time Audit Page for Elapsed Time Reporter with history expanded.

**Search Options**

Name: Patterson, John  
 Job Title: Manager-Revenue  
 \*Start Date: 05/01/2019  
 \*End Date: 05/31/2019

Get Rows

Changed Value:  Expanded all History rows:  No

Status	Action	Date	Time Reporting Code	Punch Type	Quantity	Reported Status	Taskgroup	Audit User ID	Audit Date/Time	Audit History
Current		05/01/2019	KUREG	Elapsed	28.00	Needs Approval	KUTSKGRP1	RCHANNING	04/30/2019 1:25:58.000000AM	^
History	Change	05/01/2019	KUREG	Elapsed	24.00	Needs Approval	KUTSKGRP1	RCHANNING	04/30/2019 1:25:59.014578AM	
History	Add	05/01/2019	KUREG	Elapsed	24.00	Needs Approval	KUTSKGRP1	RCHANNING	04/30/2019 1:25:16.443413AM	
Current		05/10/2019	KUREG	Elapsed	8.00	Needs Approval	KUTSKGRP1	JPATTERSON	05/13/2019 8:25:20.000000PM	

This example illustrates the Reported Time Audit Page for Punch Time Reporter.

**Search Options**

Name: Lee, Mei  
 Job Title: Accountant  
 \*Start Date: 04/01/2019  
 \*End Date: 05/26/2019



Get Rows

Changed Value:  Expanded all History rows:  No

Status	Action	Date	Time Reporting Code	Punch Type	Punch Date Time	Quantity	Reported Status	Taskgroup	Audit User ID	Audit Date/Time
Current		04/22/2019		In	04/22/2019 7:00AM	5.50	Needs Approval	KUTSKPROJ	MLEE	04/23/2019 7:55:25.000000AM
Current		04/22/2019		Meal	04/22/2019 12:30PM	0.50	Needs Approval	KUTSKPROJ	MLEE	04/23/2019 7:55:25.000000AM
Current		04/22/2019		In	04/22/2019 1:00PM	4.00	Needs Approval	KUTSKPROJ	MLEE	04/23/2019 7:55:25.000000AM
Current		04/22/2019		Out	04/22/2019 5:00PM		Needs Approval	KUTSKPROJ	MLEE	04/23/2019 7:55:25.000000AM
Current		04/23/2019		In	04/23/2019 7:00AM	10.00	Needs Approval	KUTSKPROJ	MLEE	04/23/2019 7:55:25.000000AM
Current		04/23/2019		Out	04/23/2019 5:00PM		Needs Approval	KUTSKPROJ	MLEE	04/23/2019 7:55:25.000000AM
Current		05/13/2019		In	05/13/2019 7:00AM	3.00	Needs Approval	KUTSKPROJ	MLEE	05/13/2019 8:21:15.000000PM
Current		05/13/2019		Break	05/13/2019 10:00AM	0.16	Needs Approval	KUTSKPROJ	MLEE	05/13/2019 8:21:15.000000PM

### Search Options

Field or Control	Description
Name	Search the employee with Empl ID, First Name or last Name.

<b>Field or Control</b>	<b>Description</b>
<b>Start Date and End Date</b>	Enter the start and end date for the time you want to view. The system populates the fields with the data for all time reported from the start to the end date.
	Click after you enter the start and end dates. The system retrieves the data for all the current reported time between the start and end dates.
	Select the button <b>Yes</b> or <b>No</b> to see the audit history.
	Select to download the information in the form of a datasheet.
<b>Time Reporting Code</b>	Displays the Time Reporting Code for the reported time that has a status of either <i>Current</i> or <i>Delete</i> .
<b>Quantity</b>	Displays the quantity for the Time Reporting Code for elapsed reported time or the duration for matched punches for punch reported time.
<b>Audit Date/Time</b>	Displays Audit date and time.
<b>Audit History</b>	Click to see details of changes made to the time. If the time is current and no changes were made, you cannot edit this field. If the link is available, then changes have occurred to the time; select to view them.

This example illustrates the fields and controls on the Reported Time Audit Page\_Time Reporting Elements for Elapsed.

The screenshot shows the 'Reported Time Audit' page for 'Time Reporting Elements' for an 'Elapsed' element. The search options include Name: Patterson, John and Job Title: Manager-Revenue. The start and end dates are 05/01/2019 and 05/31/2019. The table below shows the reporting elements.

Status	Date	Time Reporting Code	Time Zone	Taskgroup	Task Profile ID	Country	State	Locality	Billable	Override Rate	Override Reason Code	Currency Code	Comp Rate Code	Badge ID	Time Collection Device ID	Rule Element 1	Rule Element 2	Rule Element 3	Rule Element 4	Rule Element 5	Source	Audit History
Current	05/01/2019	KUREG	PST	KUTSKGRP1					No													
History	05/01/2019	KUREG	PST	KUTSKGRP1					No													
History	05/01/2019	KUREG	PST	KUTSKGRP1					No													
Current	05/10/2019	KUREG	PST	KUTSKGRP1					No													

This example illustrates the fields and controls on the Reported Time Audit Page\_Time Reporting Element for Punch.

The screenshot shows the 'Reported Time Audit' page for 'Time Reporting Elements' for a 'Punch' element. The search options include Name: Lee, Mei and Job Title: Accountant. The start and end dates are 04/01/2019 and 05/26/2019. The table below shows the reporting elements.

Status	Date	Time Reporting Code	Time Zone	Taskgroup	Task Profile ID	Country	State	Locality	Billable	Override Rate	Override Reason Code	Currency Code	Comp Rate Code	Badge ID	Time Collection Device ID	Rule Elen 1
Current	04/22/2019		PST	KUTSKPROJ					No		KLMAP					
Current	04/22/2019		PST	KUTSKPROJ					No		KLMAP					
Current	04/22/2019		PST	KUTSKPROJ					No		KLMAP					
Current	04/22/2019		PST	KUTSKPROJ					No		KLMAP					
Current	04/23/2019		PST	KUTSKPROJ					No							
Current	04/23/2019		PST	KUTSKPROJ					No							
Current	05/13/2019		PST	KUTSKPROJ					No							
Current	05/13/2019		PST	KUTSKPROJ					No							

This example illustrates the fields and controls on the Reported Time Audit Page\_Task and Reporting Elements for Elapsed.

**Search Options**

Name:  \*Start Date:   
 Job Title:  \*End Date:

● Changed Value Expand all History rows  No

Status	Date	Time Reporting Code	Business Unit	Customer	Task	Product	Combination Code	Audit History
Current	05/01/2019	KUREG		CUST1				^
History	05/01/2019	KUREG		CUST1				
History	05/01/2019	KUREG		CUST1				
Current	05/10/2019	KUREG		CUST1				

This example illustrates the fields and controls on the Reported Time Audit Page\_Time Reporting Elements for Punch.

**Search Options**

Name:  \*Start Date:   
 Job Title:  \*End Date:

● Changed Value Expand all History rows  Yes

Status	Date	Time Reporting Code	Project ID	Activity ID
Current	04/22/2019			
Current	04/22/2019			
Current	04/22/2019			
Current	04/22/2019			
Current	04/23/2019			
Current	04/23/2019			
Current	05/13/2019			
Current	05/13/2019			

This example illustrates the fields and controls on the Reported Time Audit Page\_ Show All for Elapsed.

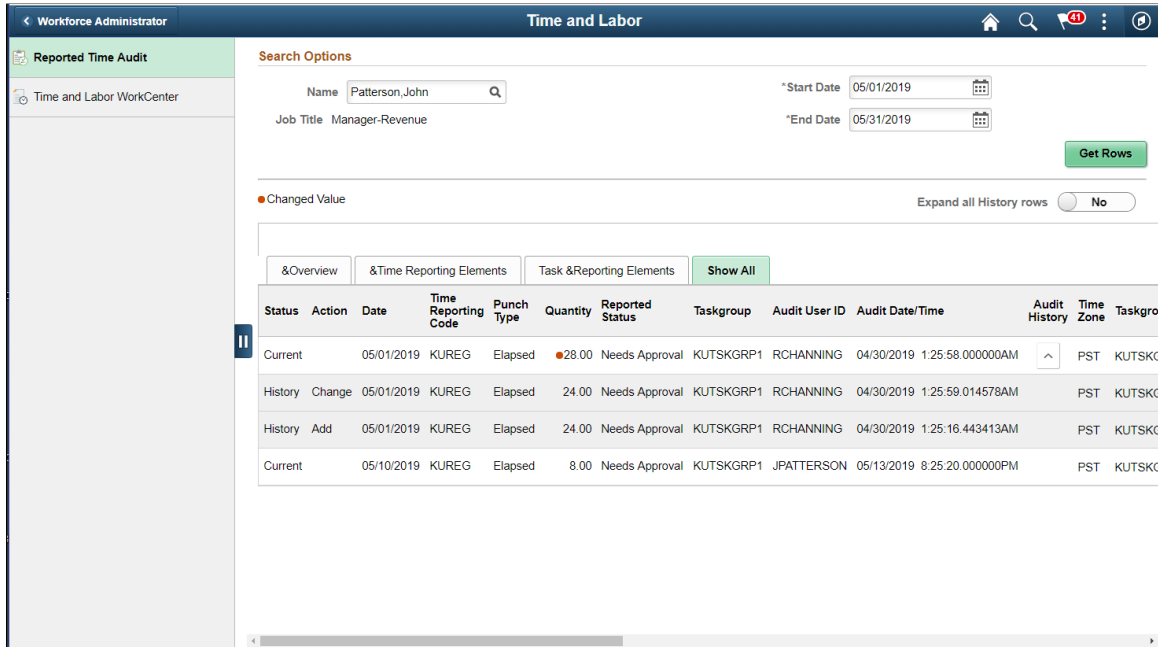

This example illustrates the fields and controls on the Reported Time Audit Page\_ Show All for Punch.

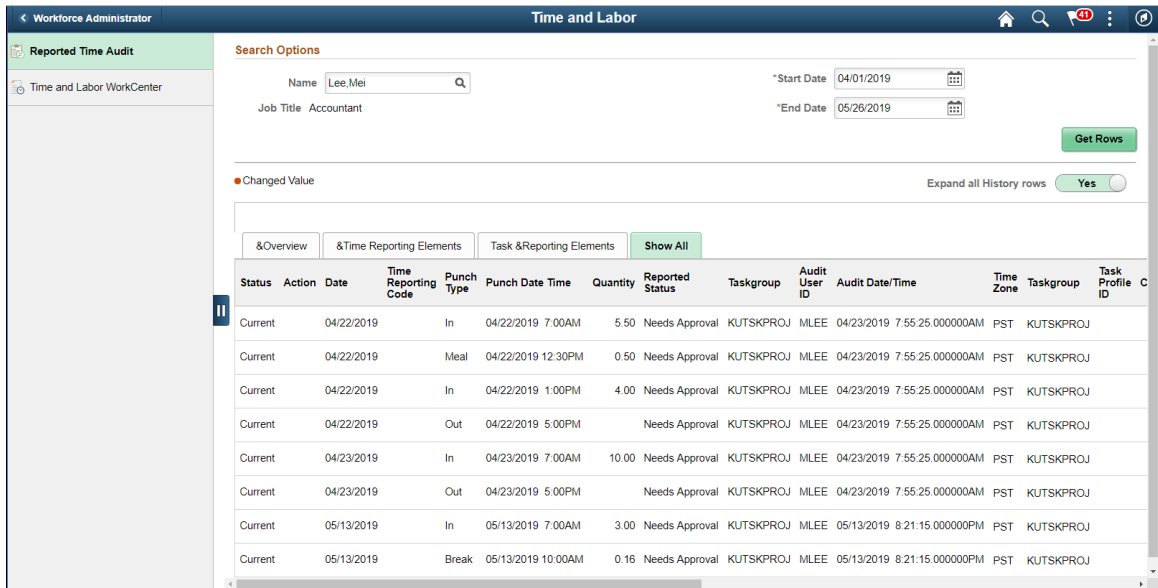

## Time and Labor WorkCenter Tile

Use the Time and Labor WorkCenter tile to access [Time and Labor WorkCenter Page](#).

Navigation:

The Time and Labor WorkCenter tile is on the [Time and Labor Dashboard](#).

This example illustrates the fields and controls on the Time and Labor WorkCenter tile.

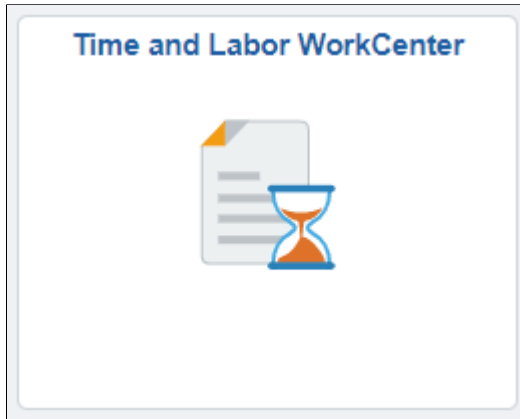

## Time and Labor WorkCenter Page

The Time and labor Fluid WorkCenter is divided into four main sections – My Work, Links, Queries, and Navigation:

Select the [Time and Labor WorkCenter Tile](#) on the [Time and Labor Dashboard](#).

Reports/Processes. You can expand each sections by clicking those sections.

For more information on how to use Classic Time and Labor WorkCenter, refer [Using the Time and Labor WorkCenter](#)

The following video provides an overview of Time and Labor WorkCenter:

Video: [PeopleSoft Benefits/Time and Labor Fluid WorkCenters](#)

This example illustrates the fields and controls on the Time and Labor WorkCenter Page.

 A screenshot of the PeopleSoft Fluid WorkCenter interface. The page title is "Time and Labor WorkCenter". On the left is a navigation sidebar with sections: "Scope" (My Scope), "My Work", "My Approvals", "My Insights", "Links", "Queries", and "Reports/Processes". The main content area is titled "Unprocessed Data" and shows a table with one row of data. The table has columns: Reviewed, Name, Actions, Job Description, Description, and Date Range.
 

Reviewed	Name	Actions	Job Description	Description	Date Range
<input type="checkbox"/>	Christelle Stevenson	⋮	Manager-Accounting	Unprocessed Payable Time	09/22/2014 - 10/03/2014

Users can personalize display options and add links to their own WorkCenter for maximum efficiency. For more information, see “Setting Up and Personalizing PeopleSoft Fluid WorkCenters” (Application Fundamentals).

## Conditional Navigation for Time and Labor WorkCenter

When administrators access the Time and Labor WorkCenter, they are taken to either the Fluid or non-Fluid version of the component depending on the user role. This behavior is known as conditional navigation.

If administrators are members of the *Time and Labor Fluid WorkCenter* user role, they are given access to the Fluid Time and Labor WorkCenter. Administrators without this role access the non-Fluid version of the WorkCenter on the [Using the Time and Labor WorkCenter](#).

The WorkCenter page is divided into two sections: the navigation panel on the left and the transaction panel on the right.

### Left Panel

The navigational panel on the left contains group boxes with links to specific transactions, menu components and other contents. These group boxes are:

- **My Work:** This group box contains six collapsible sections, *Alerts*, *Exceptions*, *Approvals*, *Time Reporter Status*, *Attendance*, and *Unprocessed Time*. For more information, see [Understanding the My Work Group Box](#).
- **My Approvals:** For more information, see
- **My Insights:** For more information, see
- **Links:** For more information, see [Understanding the Links Group Box](#).
- **Queries:** For more information, see “Configure Pagelets – Queries Page” (Enterprise Components).
- **Reports/Processes:** For more information, see “Configure Pagelets – Reports/Processes Page” (Enterprise Components).

<b>Field or Control</b>	<b>Description</b>
<b>Scope</b>	Scope determines the data to be displayed in the WorkCenter. <hr/> <b>Note:</b> If you have configured any additional scope, it will also be listed under the My Scope option. For more information on how to configure a new scope, see “Configure Scope Page” (Application Fundamentals). <hr/>
	Click to refresh the content area to display either the first page that appears when you first access the WorkCenter, or the starting page if it is specified in your personalization.

<b>Field or Control</b>	<b>Description</b>
	<p>Click to access these personalization options:</p> <ul style="list-style-type: none"> <li> <b>Personalize:</b> Select this option to personalize the WorkCenter layout.                       For more information, see “Personalize Page (Fluid)” (Application Fundamentals).                 </li> <li> <b>Maintain Scope Detail Page:</b> Select this option to modify the current scope.                 </li> <li> <b>Configure Scope:</b> Select this option to create a new scope.                       For more information, see “Configure Scope Page” (Application Fundamentals).                 </li> </ul>

This example illustrates the fields and controls on the Personalize Scope Page. You can find definitions for the fields and controls later on this page.

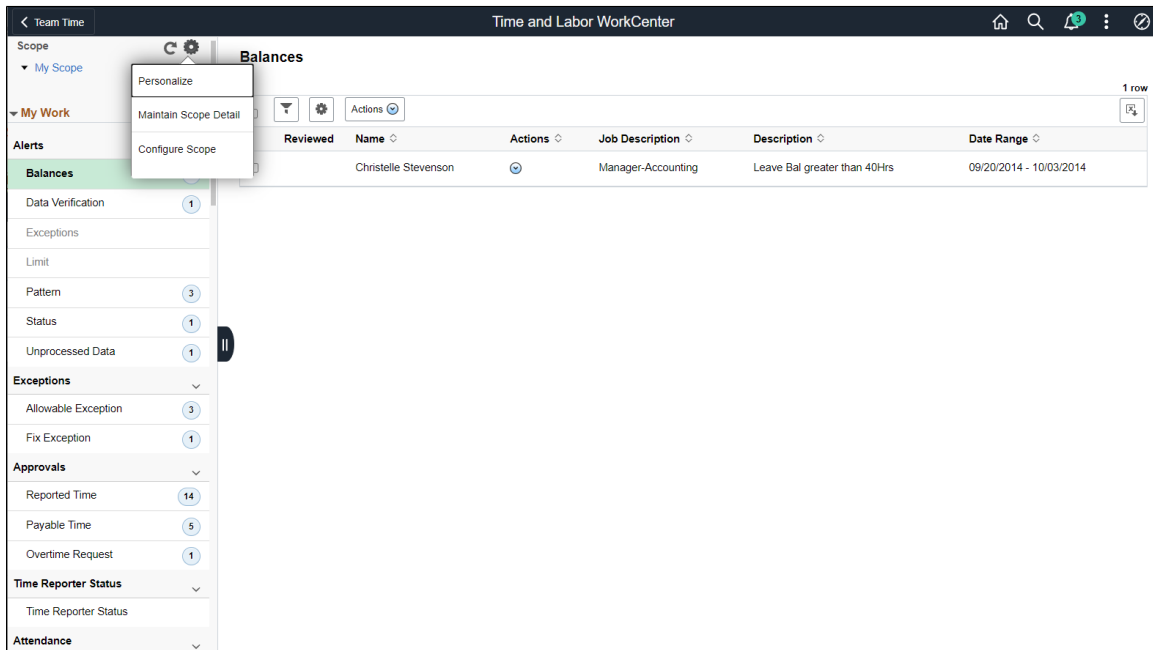



This example illustrates the sample personalized output for one of the My work items.

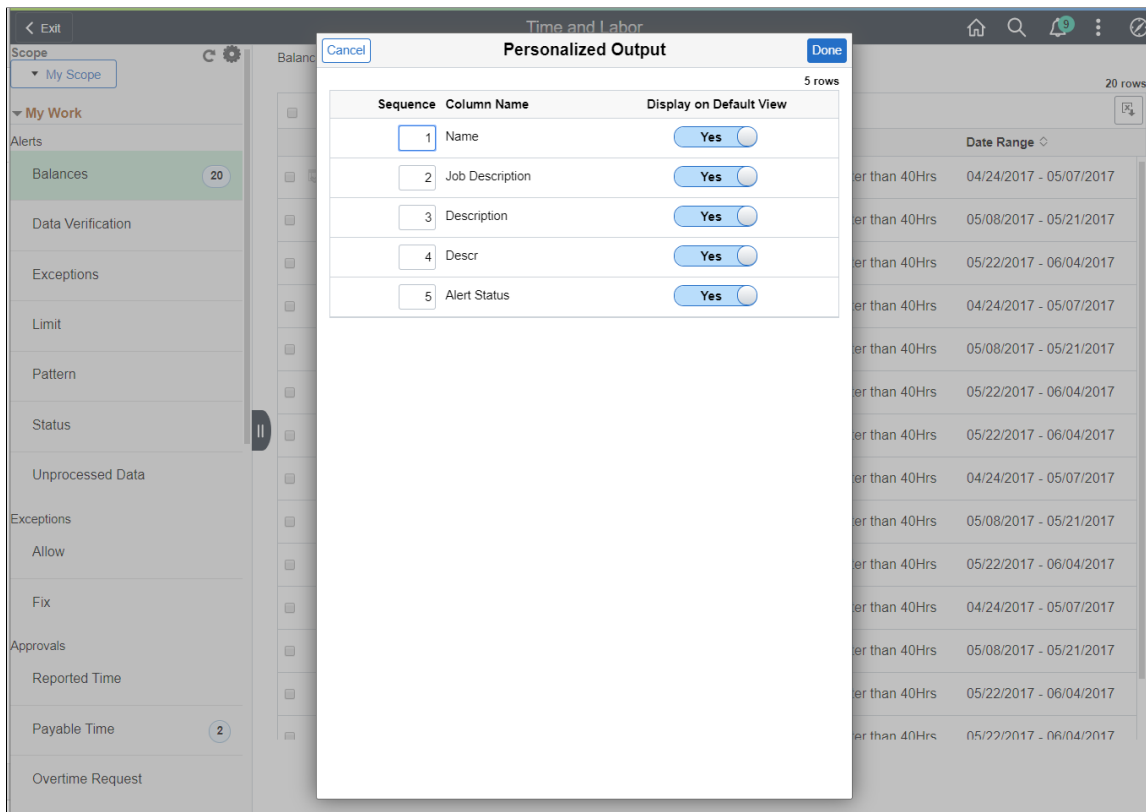

The modal for Personalized output provides an option to select the options to display on output.

### Right Panel

The transaction panel on the right is where the selected transaction result or component (work item) is displayed.

By default, **My Work** item appears when you first access the Time and Labor WorkCenter.

You can filter and personalize the output based on your requirements. Use the **Refine Filter Criteria** page to select one or more criteria to narrow the search result. The Filter icon appears green when filters have been applied to search. Use the **Personalized Output** page to modify the position of columns and to select the columns to be displayed as default for each work item. For more information, see “Personalize Page (Fluid)” (Application Fundamentals).

You can also filter and personalize the output based on your requirements. For more information, see “Setting Up and Personalizing PeopleSoft Fluid WorkCenters” (Application Fundamentals).

### Maintain Scope Detail Page

Use the Maintain Scope Detail (EOWC\_EDITVIEWWLK\_FL) page to define the scope for **My Work** items.

This example illustrates the fields and controls on the Maintain Scope Detail Page. You can find definitions for the fields and controls later on this page.

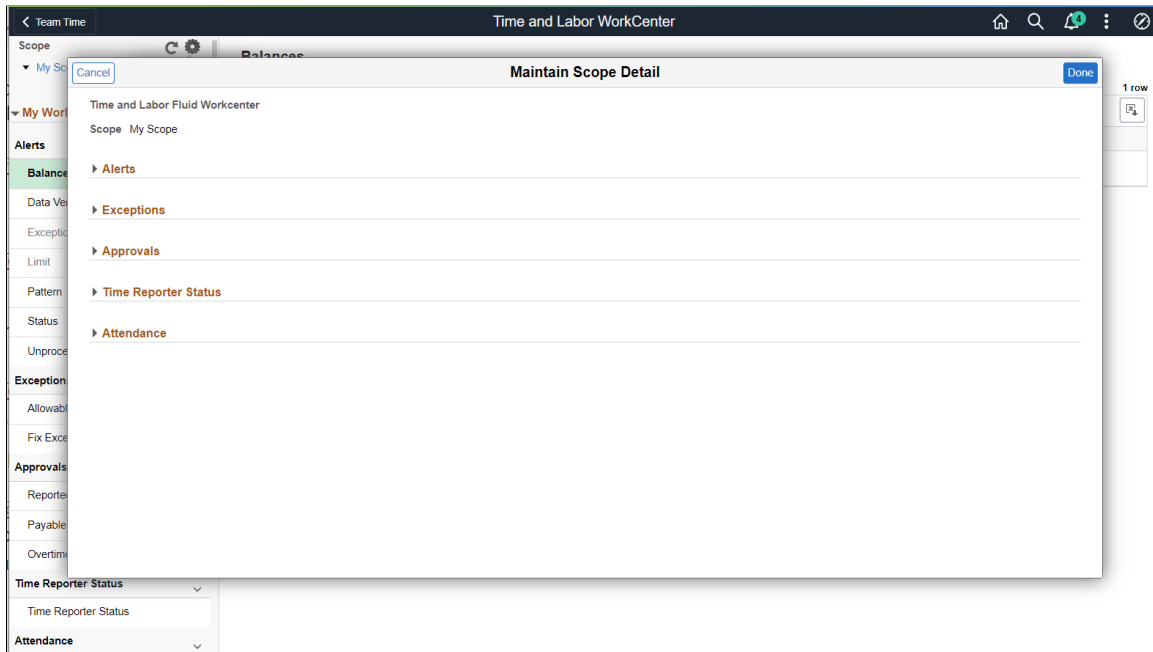

You can define the scope of alerts with Link Label, Description and Edit Filters. The Edit Filters enables you to define the scope values like date ranges.

## Understanding the My Work Group Box

The My Work group box provides Time and Labor work item links for alerts and exceptions in these group sections:

- Alerts
- Exceptions
- Approvals
- Time Reporter Status
- Attendance

---

**Note:** The Work item links are grayed out if no data is available for display.

---

### Alerts

There are seven types of alerts available: Balances, Data Verification, Exceptions, Limit, Pattern, Status and Unprocessed Data.

For more details, refer [Alert Type\\_Balances Page](#)

### Exceptions

- [Allowable Exception Page](#)

- [Fix Exception Page](#)

## Approvals

These are [Reported Time Approvals Page](#), [Payable Time page](#) and [Overtime Request time page](#) in Time and Labor Fluid WorkCenter.

## Reported Time Status

[Reported Time Status page](#)

## Attendance

- [Attendance Violations Page](#)
- [Attendance Actions Page](#)

## Reported Time Status page

Use Reported Time Status page to view the Time administration status of the employees.

This example illustrates the fields and controls on the Reported Time Status page.

Time Reporter Status								2851 rows
Name	Empl ID	Earliest Change Date	Time Administration Status	Last Update Date/Time	Last Processed	User ID	Run Control ID	
MTABUG 16696047	MTA16696047	01/01/2018	Up For Processing	12/01/2014 11:54:02PM				
MTABUG 16906570	MTA16906570	01/01/2018	Up For Processing	12/01/2014 11:57:57PM				
MTABUG 17278723	MTA17278723	01/01/2018	Up For Processing	12/01/2014 11:38:10PM				
MTABUG 17498455	MTA17498455	01/01/2018	Up For Processing	12/01/2014 11:48:59PM				
MTABUG 17672641	MTA17672641	01/01/2018	Up For Processing	12/01/2014 11:58:06PM				
MTABUG 17963655	MTA17963655	01/01/2018	Up For Processing	12/01/2014 11:51:45PM				
cfi 71966	MCFL71966	01/01/2018	Up For Processing	06/30/2015 6:31:06PM				
cfi 71966	MCFL71966	01/01/2018	Up For Processing	04/01/2016 10:52:27AM				
cfi 71966	MCFL71966	01/01/2018	Up For Processing	04/01/2016 10:54:57AM				
CFL 72006	MCFL72006	01/01/2018	Up For Processing	07/10/2015 9:49:07AM				
MTA 72014	MTA72014	01/01/2018	Up For Processing	07/16/2015 5:05:29AM				
mcfi 72046	MCFL72046	01/01/2018	Up For Processing	07/13/2015 3:24:32AM				
MCFL 72098	MCFL72098	01/01/2018	Up For Processing	07/09/2015 6:39:17PM				
MSUP 72098	MSUP72098	01/01/2018	Up For Processing	07/09/2015 6:38:13PM				

## Attendance Violations Page

Use the Attendance Violations page (HWC\_RSLT\_FL) to view the list of employees with Attendance Violations.

Navigation:

Click the **Attendance Violations** link under **Attendance** in the **My Work** group box of the Time and Labor WorkCenter.

This example illustrates the Attendance Violations Page.

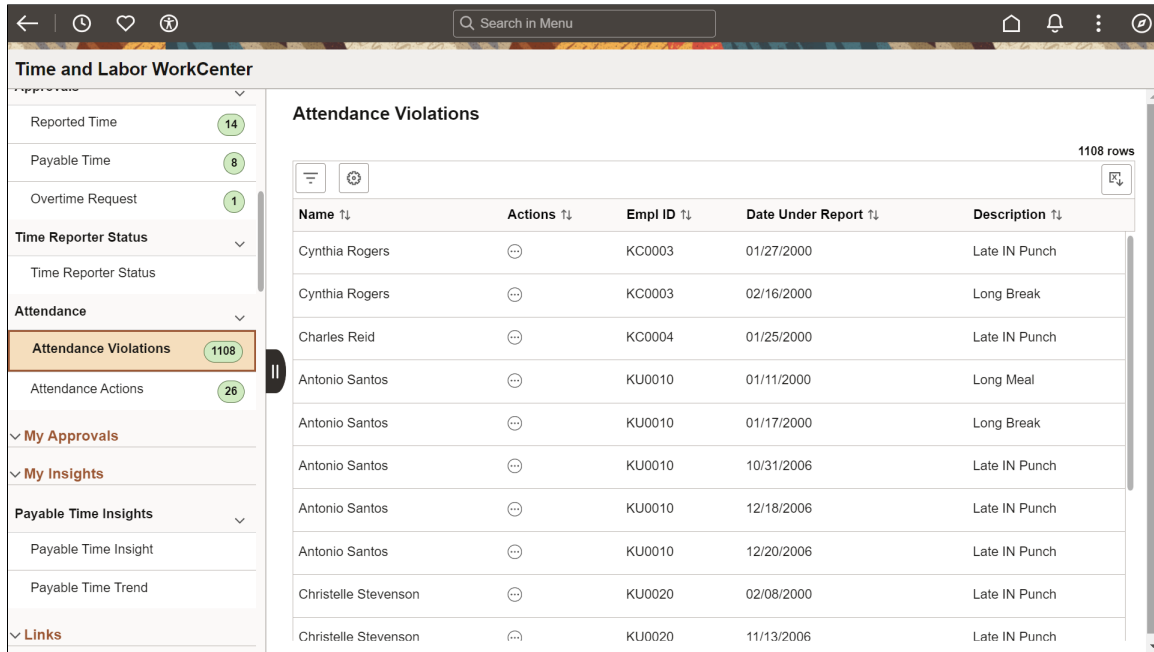

This example illustrates the fields and controls on the Attendance Violation Page\_Related Actions. You can find definitions for the fields and controls later on this page.

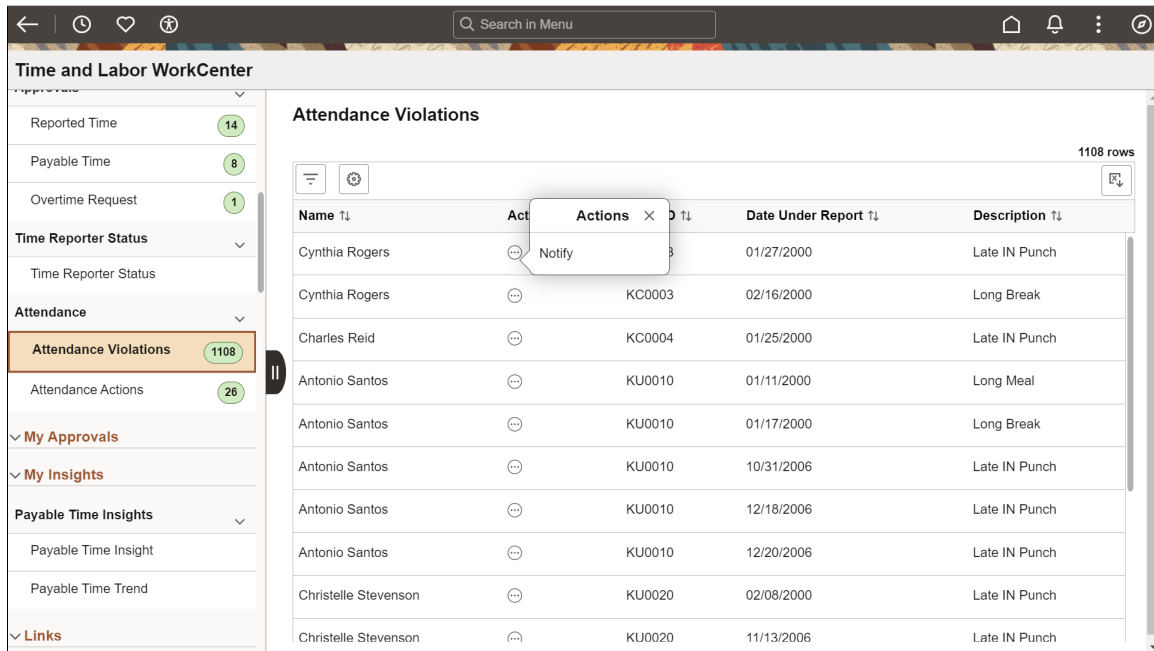

You can select the related action on the right panel to select **Notify**.

## Attendance Actions Page

Use the Attendance Actions page (HWC\_RSLT\_FL) to view the list of employees whose time requires attendance actions.

Navigation:

Click the **Attendance Actions** link under **Attendance** in the **My Work** group box of the Time and Labor WorkCenter.

This example illustrates the Attendance Actions page.

The screenshot shows the 'Attendance Actions' page within the 'Time and Labor WorkCenter'. The left sidebar contains navigation options such as 'Reported Time' (14), 'Payable Time' (8), 'Overtime Request' (1), 'Time Reporter Status', 'Attendance' (1108), and 'Attendance Actions' (26). The main content area displays a table with 26 rows of attendance actions.

Name	Actions	Empl ID	Date Under Report	Description	Action Required	Date Cleared
Rudolf James	...	MDMO207	09/24/2012	Late IN Punch	Written Warning 1	09/30/2012
Rudolf James	...	MDMO207	09/25/2012	Late IN Punch	Written Warning 2	09/30/2012
Cynthia Rogers	...	KC0003	01/27/2000	Late IN Punch	Written Warning 1	03/12/2000
Cynthia Rogers	...	KC0003	02/15/2000	Late IN Punch	Termination	05/15/2000
Cynthia Rogers	...	KC0003	02/16/2000	Late IN Punch	Termination	05/16/2000
Cynthia Rogers	...	KC0003	02/17/2000	Late IN Punch	Termination	05/17/2000
Rudolf James	...	MDMO207	09/25/2012	Early Out	Suspension	09/30/2012
Charles Reid	...	KC0004	01/25/2000	Late IN Punch	Suspension	03/25/2000
David Stanfield	...	KU0174	04/28/2016	Late IN Punch		01/01/1900
Kavia Nauven	...	MDMO200	09/11/2012	Long Meal	Verbal Warning	09/30/2012

This example illustrates the fields and controls on the Attendance Actions Page\_Related Action. You can find definitions for the fields and controls later on this page.

Name	Action	Date Under Report	Description	Action Required	Date Cleared
Rudolf James	Notify	09/24/2012	Late IN Punch	Written Warning 1	09/30/2012
Rudolf James	MDMO207	09/25/2012	Late IN Punch	Written Warning 2	09/30/2012
Cynthia Rogers	KC0003	01/27/2000	Late IN Punch	Written Warning 1	03/12/2000
Cynthia Rogers	KC0003	02/15/2000	Late IN Punch	Termination	05/15/2000
Cynthia Rogers	KC0003	02/16/2000	Late IN Punch	Termination	05/16/2000
Cynthia Rogers	KC0003	02/17/2000	Late IN Punch	Termination	05/17/2000
Rudolf James	MDMO207	09/25/2012	Early Out	Suspension	09/30/2012
Charles Reid	KC0004	01/25/2000	Late IN Punch	Suspension	03/25/2000
David Stanfield	KU0174	04/28/2016	Late IN Punch		01/01/1900
Kavla Nauven	MDMO200	09/11/2012	Lond Meal	Verbal Warning	09/30/2012

You can select the related action on the right panel to select **Notify**.

## Understanding the My Approvals Group Box

The My Approvals group box provides access to requests that are pending users' approval.

System administrators can manage links and configuration options for the My Approvals group box on the “Configure Pagelets – My Approvals Page” (Enterprise Components).

## Understanding the My Insights Group Box

The My Insights group box provides access to the insights dashboards for Time and Labor.

This example illustrates the My Insights Group Box



System administrators can manage links and configuration options for the My Insights group box on the “Configure Pagelets – My Insights Page” (Enterprise Components).

---

**Note:** A minimum of PeopleTools version 8.61 is required to support access to PeopleSoft Insights dashboards in Fluid WorkCenters.

---

For more information about Time and Labor Insights, see [Viewing Payable Time Analytics](#).

## Understanding the Links Group Box

The Links group box provides access to the key components that are required to complete Time and Labor transactions.

This example illustrates the fields and controls on the Link Group Box.

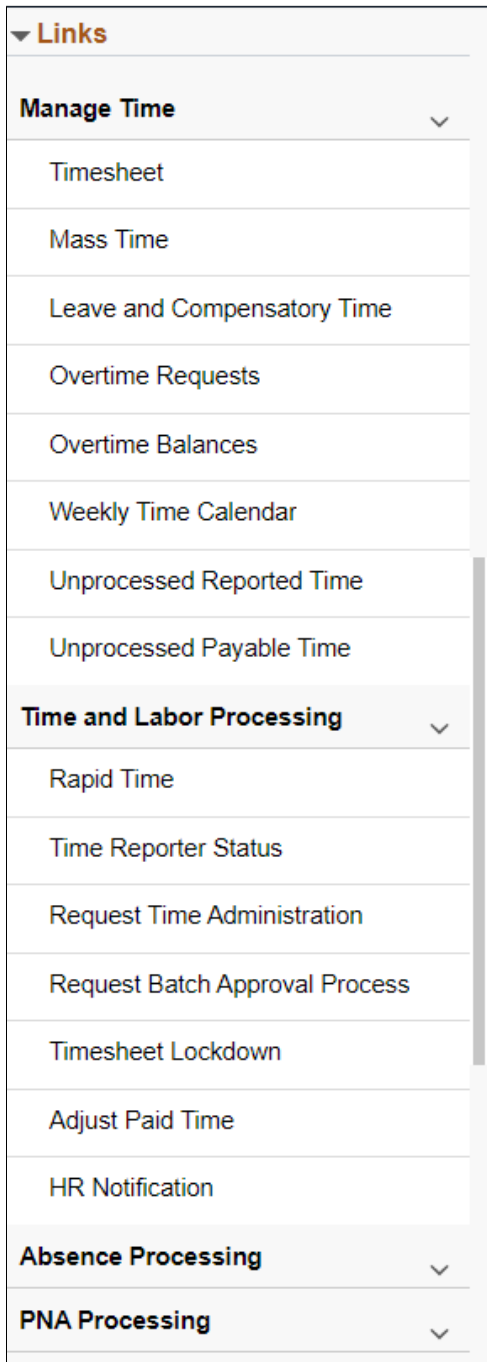

The system administrators can manage links and configuration options for the Queries Group Box on the “Configure Pagelets – Queries Page” (Enterprise Components)

## Understanding the Queries Group Box

The Queries group box contains the Query Manager link. Select to search for existing queries or create one to use.

This example illustrates the Queries Group Box.

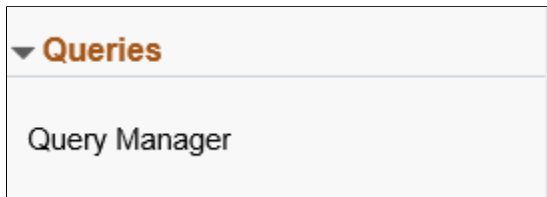

The system administrators can manage links and configuration options for the Queries Group Box on the “Configure Pagelets – Queries Page” (Enterprise Components).

## Understanding the Reports/Processes Group Box

The Reports/Processes group box provides access to the Workforce Availability analytics and reports.



This example illustrates the fields and controls on the Reports/Processes Group Box.

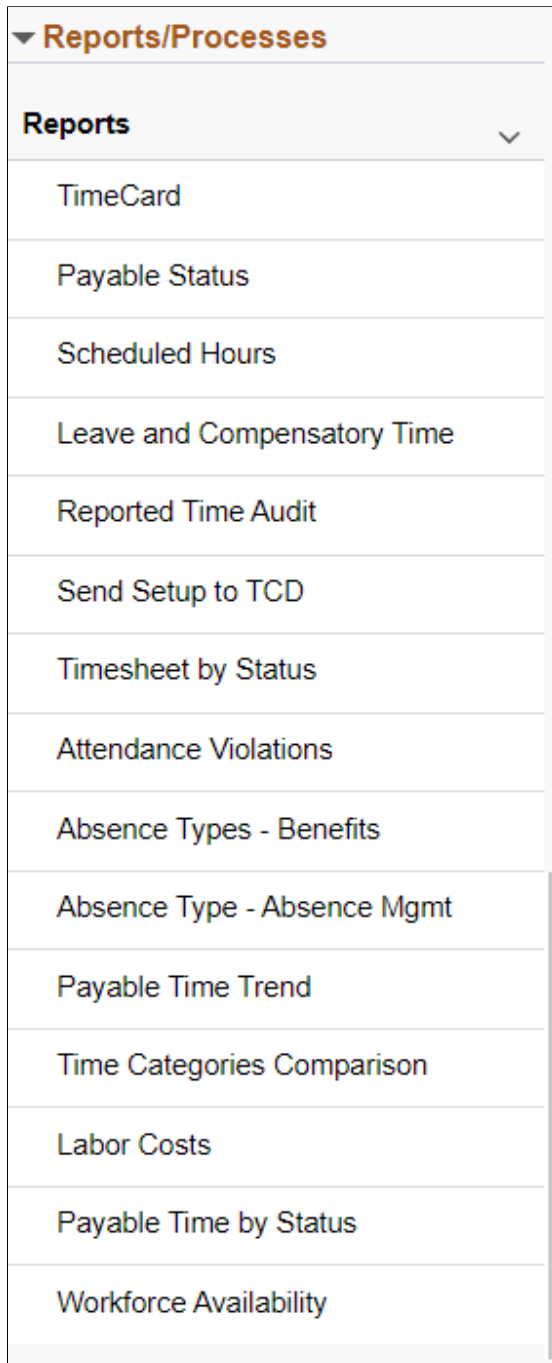

## Reported Time Insight Tile

The administrators or managers can use the Reported Time Insight tile to access the Reported Time Insight dashboard using PeopleSoft Insights for Time and Labor.

Navigation:

The Reported Time Audit Tile is on the [Time and Labor Dashboard](#).

This example illustrates the Reported Time Insight tile.



The Reported Time Insight tile depicts the reported to scheduled time ratio for the last 4 months. The last 4 months is the rolling month indicates that if the current month is March 2021, then the visualization depicts for December 2020, January 2021 and February 2021.

Based on user privileges, administrators and managers can access the visualizations delivered on the Reported Time Insight dashboard.

---

**Note:** These insights will consider only positive time reporters and excludes all exception time reporters.

---

The reported time data is the data submitted by employee, manager or administrator. The Reported Time Insight dashboard is built on the PeopleSoft Insights platform, which relies on an underlying analytics engine and search engine. Reported Time data that is visible on the dashboard comes from the `HC_TL_GBL_TIMESHEET_SCHED_FULL` search index and `HC_TL_GBL_TIMESHEET_SCHEDULE` search definition.

For information on Insights, see PeopleTools *Search Technology*, “Monitoring PeopleSoft Search Framework and Opensearch” and “Working with Insights Dashboards for PeopleSoft Application Data” documentation.

These videos provide an overview of the Insights feature:

Video: [Insights with PeopleSoft](#)

Video: [PeopleSoft HCM Insights](#)

## Deploying the Reported Time Insight Analytics

Before administrators can access the Reported Time data in Insights, the following steps should be performed:

1. Deploy the search definition `HC_TL_GBL_TIMESHEET_SCHEDULE` and search `HC_TL_GBL_TIMESHEET_FULL` (Reported Time data) index.

**(PeopleTools > Search Framework > Search Admin Activity Guide > Administration > Deploy/Delete Object**

2. Build the `HC_TL_GBL_TIMESHEET_FULL` search index.

**(PeopleTools > Search Framework > Search Admin > Activity Guide > Administration > Schedule Search Index)**

---

**Note:** The *HC\_TL\_GBL\_TIMESHEET\_FULL* search index process the data only for past 550 days (~ 1.5 years).

---

3. Deploy the Reported Time Insight Tile and Reported Time Insight dashboard.

**(PeopleTools > Search Framework > Administration > Deploy Dashboards to Insights)**

---

**Note:** The full index must be run before the dashboard can be deployed.

---

4. Assign *TL Manager Fluid* roles to administrators to managers and *TL Administrator Fluid* roles to administrators to access and view Reported Time Insight Analytics visualizations.

---

**Note:** Run the full index first time.

If there are changes to reported time, then the incremental index automatically takes care of those which includes new data, delete and update.

---

**Note:** The Schedules (*HC\_TL\_GBL\_TIMESHEET\_SCHEDULE* and *HC\_TL\_GBL\_TIMESHEET*) search indexes support real time indexing (RTI) with PeopleTools version 8.59.09 or higher. When enabled, RTI allows real-time updates to the indexed data to provide searches using the latest information. For more information about Real Time Indexing, refer to PeopleTools Search Technology, "Administering Real Time Indexing."

---

## Reported Time Insight Dashboard

The Time administrators and managers can use the Reported Time Insight dashboard to view several interactive visualizations based on the time reporting data specified for a date range for the selected group of employees.

The visualizations are used in the following ways:

- Identify if the employees follow the schedule.
- View if non-standard reporting codes are being used.
- Compare the top time reporting code with other codes.
- Identify the months people are taking more vacation, or sick leave.
- Determine the heaviest web servers load due to more time submissions.

Navigation:

Select the [Reported Time Insight Tile](#) on the [Time and Labor Dashboard](#).

This video provides an overview of the Time and Labor Insights feature:

Video: [Image Highlights, PeopleSoft HCM Update Image 38: Reported Time Insight Dashboard](#)

This example illustrates the fields and controls on the Reported Time Insight dashboard. You can find definitions for the fields and controls later on this page.

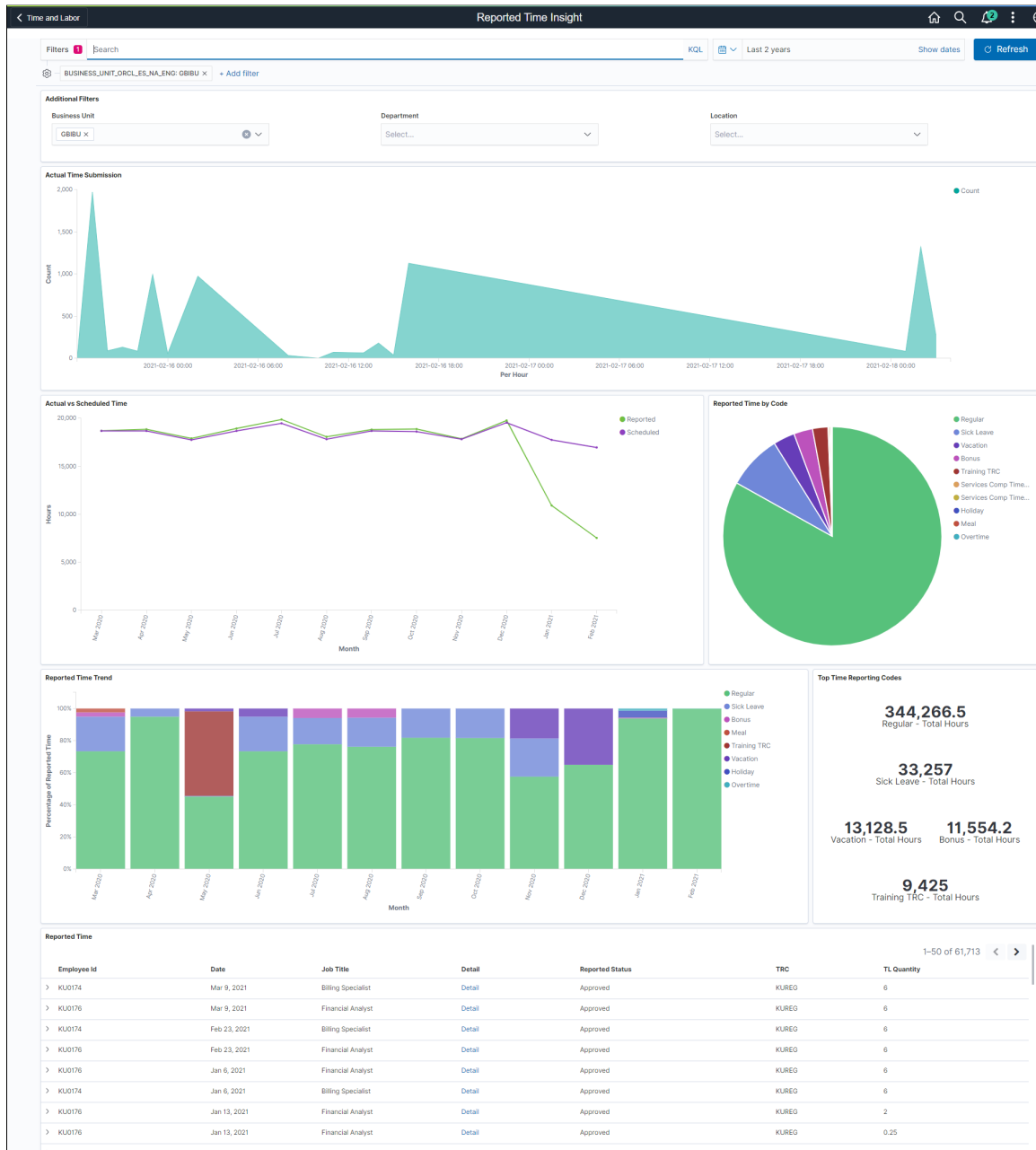

The visualizations are presented in different visual represented to best present data. There are different types of analytics which include:



- Actual Time Submission
- Actual Vs Scheduled Time
- Reported Time by Code
- Reported Time Trend

- Top Time Reporting Codes

**Note:** With any visualization, you can pause over an item to view the percentage or number counts, as desired.

### Common Element and Controls

**Note:** Filtering options apply to all visualizations, which allows administrators to drill down on all the charts at once.

<b>Field or Control</b>	<b>Description</b>
<b>Open in Insights</b>	This link appears only for users with role <b>TL Administrator Fluid</b> and <b>TL Manager Fluid</b> .
Filters search field  Change all filters icon, Change all filters icon (Change all filters), and + <b>Add filter</b>	Enter criteria to filter data on the visualizations. You can add filters in a number of ways: <ul style="list-style-type: none"> <li>• Enter them manually in the Filters search field</li> <li>• Use the + <b>Add filter</b> link to create filters using fields, operators and field values.</li> <li>• Select a chart item from a visualization.</li> <li>• Use the filter options in the Reported Time Details grid to add or exclude items.</li> <li>• Use the legend to add or exclude items.</li> </ul>
 Calendar icon Calendar icon (Calendar) or Show dates	Click to select a different time period for the analytics. You can enter it manually, or choose from commonly used date ranges provided by the system or from the recently used selections. When a new period is selected, all visualizations are refreshed automatically to reflect that change. If you have selected a commonly used date range, for example, <i>This month</i> , or <i>Week to date</i> , click the <b>Show dates</b> link to view the approximate date period in relation to the current date. For example, the current date is November 1 and the selected date range is <i>Year to date</i> . Clicking the Show dates link displays ~ <i>10 months ago</i> —> now, which indicates that the selected date range started from approximately 10 months ago and ends on the current date.

## Additional Filters

This example illustrates the fields and controls on the Additional Filters. You can find definitions for the fields and controls later on this page.

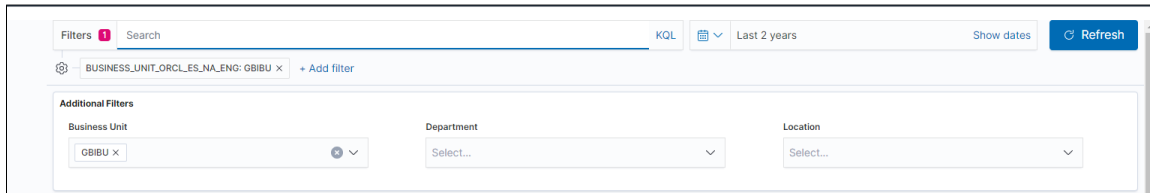

**Note:** The default filters that populates are data for the last five years.

Additional Filters allows you select filters in the areas:

- Department
- Business Unit
- Location

## Actual Time Submission Visualization

Use the Actual Time Submission visualization to view the submitted count of time with respect to the hours. It shows instantly the time is submitted.

This example illustrates the fields and controls on the Actual Time Submission.

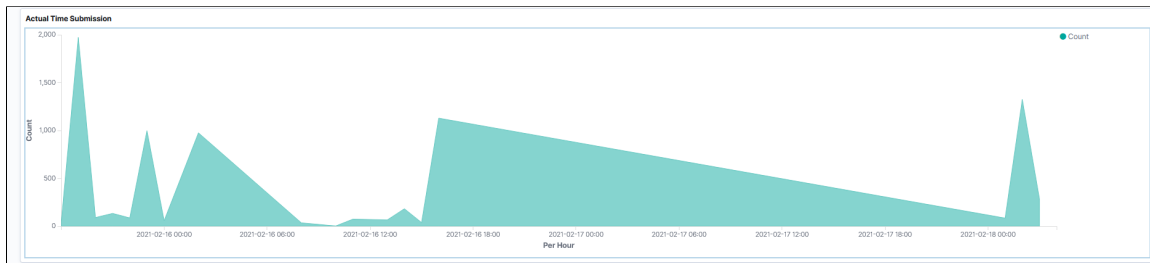

This will only display the data for the last seven days rolling period.

## Actual Vs Scheduled Time Visualization

Use Actual Vs Schedule Time visualization to view the trend of reported and scheduled time and identify if employees follow the schedule.

You can compare actual hours worked to scheduled number of hours for reported and scheduled time.

This example illustrates the fields and controls on the Actual Vs Scheduled Time.

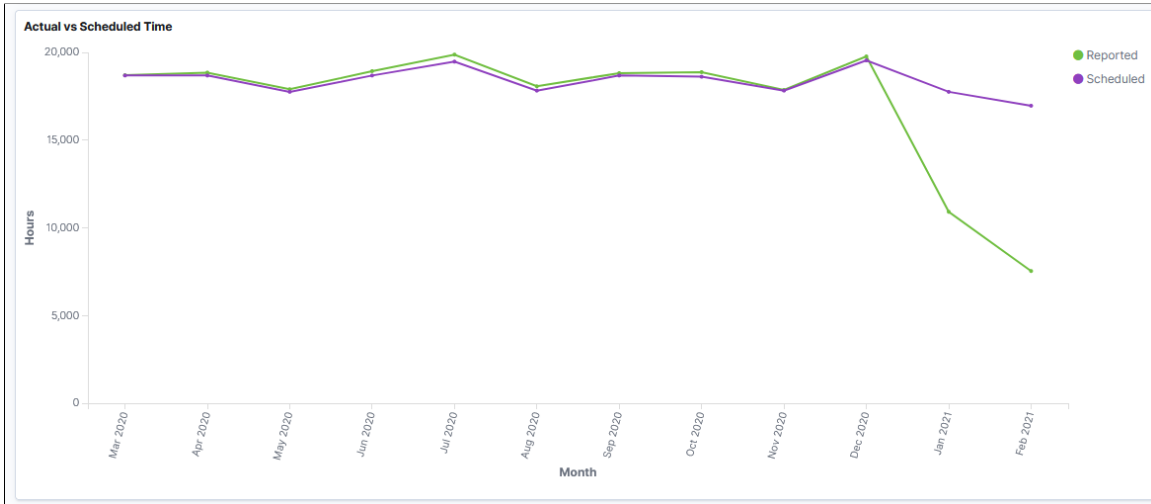

The legends represent the Reported and Scheduled Time in different colour. This displays the data for last one year rolling period which include last completed month and do not include data from the current running month.

---

**Note:** As a pre-requisite for fetching scheduled data, the scheduled search index needs to be built.

---

### Reported Time by Code

Use the Reported Time by Code to view the analytics for reported time distributed to different time reporting codes.

This example illustrates the fields and controls on the Reported Time by Code.

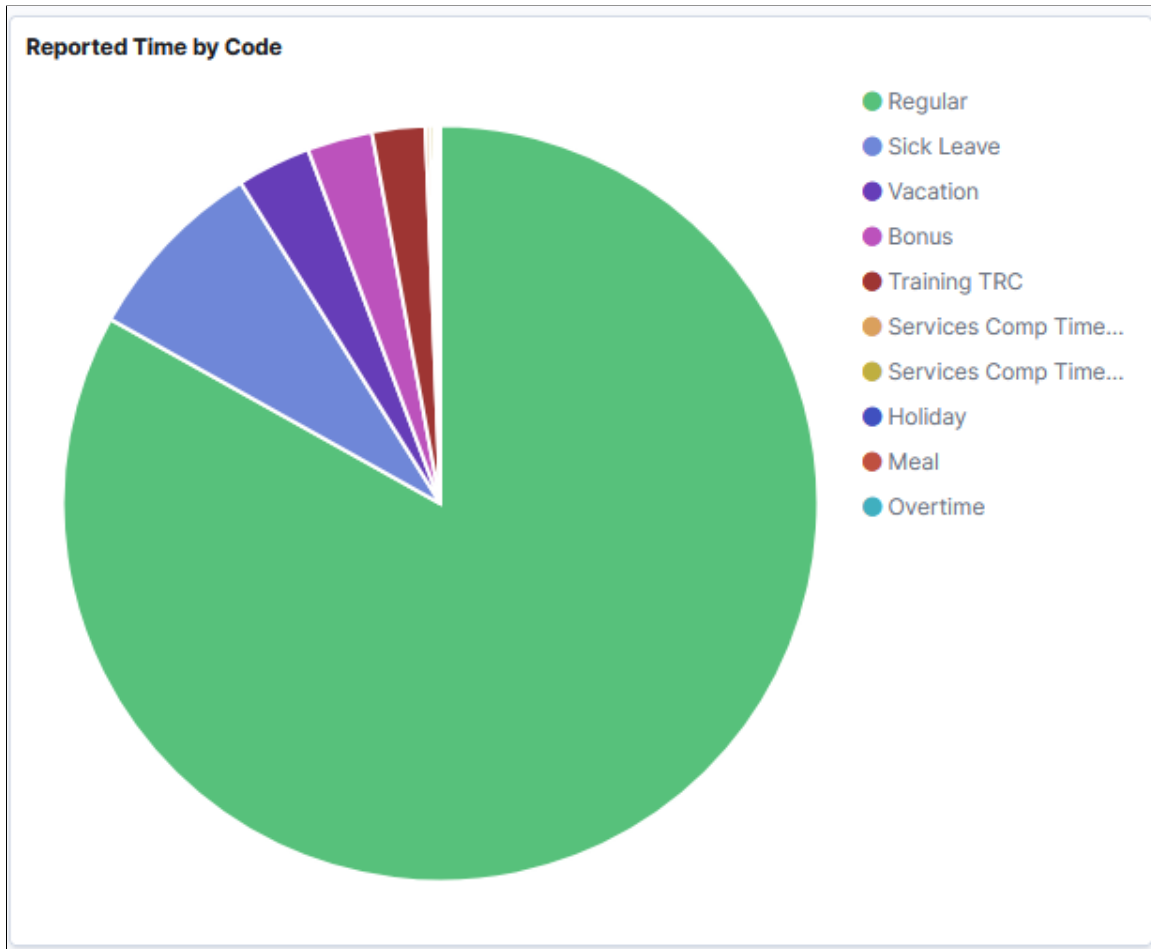

You can hover the mouse at any place on the pie chart to view the information of Time Reporting Code.

---

**Note:** The above mentioned visualization have a filter to restrict the results to the top ten values.

---

### Reported Time Trend Visualization

Use Reported Time Trend visualization to view the trend of percentage of Reported Time by the time reporting code by month.



This example illustrates the fields and controls on the Reported Time Trend.

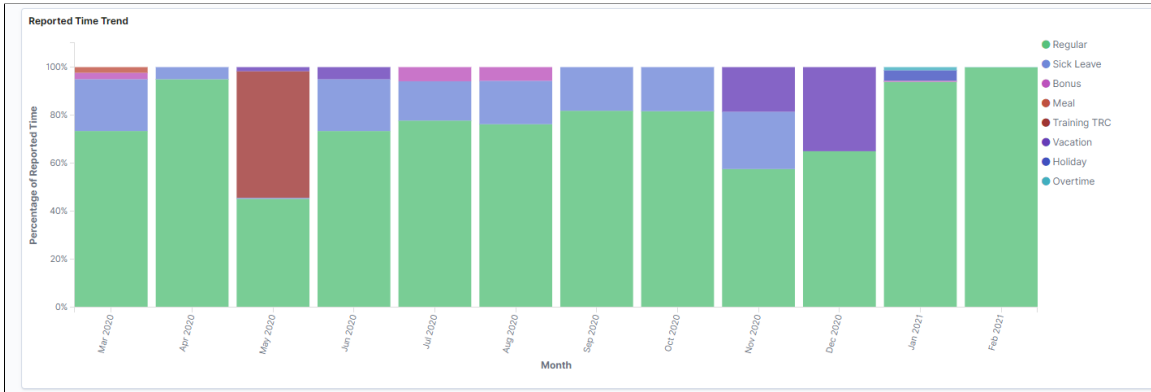

The time reporting code distributions display in different colours as you chose it from the legends. The data loaded is for the last 12 months.

### Top Time Reporting Codes

Use Top Time Reporting Codes visualizations to overall hours reported by employees.

This example illustrates the fields and controls on the Top Time Reporting Codes.

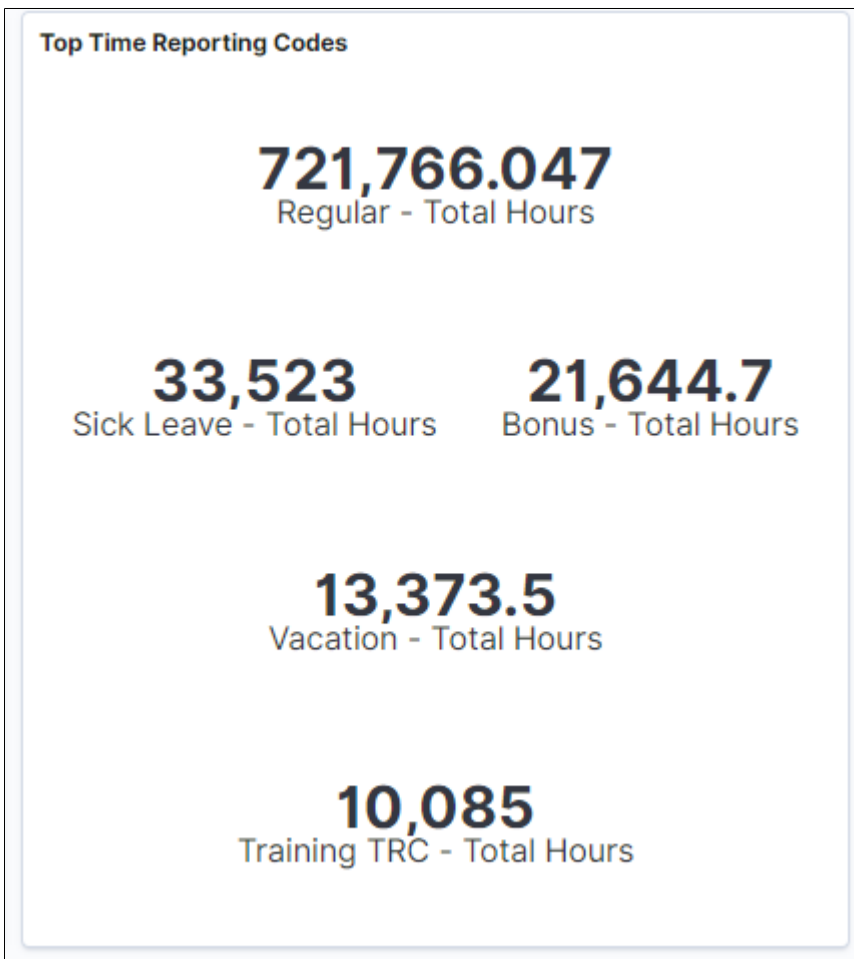

## Reported Time Details

Use Reported Time details grid to view the employee details and related information.

This example illustrates the fields and controls on the Reported Time Details. You can find definitions for the fields and controls later on this page.

Reported Time							1-50 of 13,594
Employee Id	Date	Job Title	Detail	Reported Status	TBC	TL Quantity	
> KU0174	Feb 23, 2021	Billing Specialist	Detail	Approved	KUREG	6	
> KU0176	Feb 23, 2021	Financial Analyst	Detail	Approved	KUREG	6	
> KU0174	Jan 6, 2021	Billing Specialist	Detail	Approved	KUREG	6	
> KU0176	Jan 6, 2021	Financial Analyst	Detail	Approved	KUREG	6	
> KU0174	Jan 26, 2021	Billing Specialist	Detail	Approved	KUREG	1	
> KU0174	Jan 26, 2021	Billing Specialist	Detail	Approved	KUREG	2	
> KU0174	Jan 26, 2021	Billing Specialist	Detail	Approved	KUREG	1.75	
> KU0174	Jan 28, 2021	Billing Specialist	Detail	Approved	KUREG	4	

Reported Time details is the list of information which is presented based on user needs. This is customizable according to the need of the user.

## Related Links

“Understanding Real Time Indexing in HCM” (Application Fundamentals)

---

## Viewing Payable Time Analytics

PeopleSoft Payable Time Analytics dashboards provide administrators and managers the ability to view and analyze payable time generated by Time and Labor using Insights visualizations.

There are two Payable Time dashboards, the Payable Time Insight and Payable Time Trend. The Payable Time Insight dashboard is intended for administrators and timekeepers to alert them to possible data or processing issues. The Payable Time Trend dashboard is intended for management roles to help them visualize the trends in time being paid and where there might be anomalies.

The Payable Time visualizations are built on the PeopleSoft Insights platform, which relies on an underlying analytics engine and search engine.

For information on Insights, see *PeopleTools Search Technology*, “Monitoring PeopleSoft Search Framework and OpenSearch” and “Working with Insights Dashboards for PeopleSoft Application Data” documentation.

These videos provide an overview of the Insights feature:

Video: [Insights with PeopleSoft](#)

Video: [PeopleSoft HCM Insights](#)

---

**Note:** For both the Payable Time Search and Payable Time Exceptions indexes, the Real Time Indexing (RTI) is enabled. With RTI enabled search indexes, you can get up to date data available in analytics and searches.

To use incremental index, enable the Incremental Index for Payable Time from the Time and labor installation page. For more information, see the Insight and Search Index Options section of the [Time and Labor Installation Page](#) topic.

For more information on using incremental index, see *PeopleTools Search Technology*, “Administering PeopleSoft Search Framework”.

These search indexes support RTI with PeopleTools version 8.59.07 or higher. When enabled, RTI allows real-time updates to the indexed data to provide a search using the latest information.

---

**Note:** When high volume processing occurs in Time Administration and Pay reversal processes, The RTI will be disabled. Incremental index will be scheduled automatically after the process completes and it enables the RTI.

---

**Note:** For more information about Real Time Indexing, refer to *PeopleTools Search Technology*, "Administering Real Time Indexing."

As part of Currency Conversion Setup, Payable Time Insight and Payable Time Trend Insights dashboards support only one global currency, which is US Dollars.

---

This topic provides an overview of the deployment and access of the Payable Time Analytics, and discusses how to view Insights Payable Time Analytics visualizations.

## Pages Used to View Payable Time Analytics

<b>Page Name</b>	<b>Definition Name</b>	<b>Usage</b>
<a href="#">Payable Time Insight Tile</a>	HC_TL_PAYABLE_TIME_INSIGHT_FL (this is the cref for the tile)	Access the Payable Time Insight dashboard.
<a href="#">Payable Time Insight Dashboard</a>	HC_TL_PAYABLE_TIME_INSIGHT_FL	Review and analyze payable time using Insights visualizations.
<a href="#">Payable Time Trend Tile</a>	HC_TL_PAYABLE_TIME_TREND_FL	Access the Payable Time Trend dashboard.
<a href="#">Payable Time Trend Dashboard</a>	HC_TL_PAYABLE_TIME_TREND_FL	Review and analyze payable time trend using Insights visualizations.



## Common Elements and Controls



This section lists the common elements and controls that are used in Insights analytics.

---

**Note:** Filtering options apply to all visualizations, which allows users to drill down on all the charts at once.

---

<b>Term</b>	<b>Definition</b>
<b>Open in Insights</b>	This link appears only for users with role <b>TL Administrator Fluid</b> .
 (See saved queries)	Click to save the current query text and filters that you want to reuse in the future, or select an existing query to use to update the visualizations.
<b>Search field</b>	Enter a Insights Query Language (KQL) query to filter data, if applicable.
 (Change all filters), and + <b>Add filter</b>	<p>Enter criteria to filter data on the visualizations. You can apply filters in a number of ways:</p> <ul style="list-style-type: none"> <li>• Enter Insights Query Language (KQL) queries in the Search field.</li> <li>• Use the + <b>Add filter</b> link to create filters using fields, operators and field values.</li> <li>• Use the Additional Filters delivered filter fields.</li> <li>• Select a chart item from a visualization.</li> <li>• Use the filter options in the Payable Time Details grid to add or exclude items.</li> <li>• Use the legend to add or exclude items.</li> </ul> <p>Added filters are displayed next to the + <b>Add filter</b> link for reference.</p> <p>Click the <b>Change all filters</b> icon for a list of actions that can be performed on <i>all</i> filters, for example, disable them temporarily, remove them permanently, or invert inclusion (show data that does not meet filter criteria). Click a filter item for a list of similar actions that can be performed on it individually.</p>
 (Calendar) or <b>Show dates</b>	<p>Click to select a different time period for the analytics. You can enter it manually, or choose from commonly used date ranges provided the system as well as recently used selections. When a new period is selected, all visualizations are refreshed automatically to reflect that change.</p> <p>If you have selected a commonly used date range, for example, <i>This month</i>, or <i>Week to date</i>, click the <b>Show dates</b> link to view the approximate date period in relation to the current date. For example, the current date is November 1 and the selected date range is <i>Year to date</i>. Clicking the Show dates link displays ~ <i>10 months ago</i> —&gt; <i>now</i>, which indicates that the selected date range started from approximately 10 months ago and ends on the current date.</p>

<b>Term</b>	<b>Definition</b>
 (Options)	<p>Click the Options icon in the upper right hand corner of a visualization to select one of these options:</p> <ul style="list-style-type: none"> <li>• <i>Inspect</i>: Select this option to have a slide out page appear providing the details in a grid format. You can also download data from this page.</li> <li>• <i>Maximize panel</i> or <i>Minimize</i>: Select <i>Maximize panel</i> to have the page display only this visualization in full screen. Select <i>Minimize</i> to return to the dashboard in Insights and display all visualizations.</li> </ul>
 (Toggle legend)	<p>Click this icon to hide or display the legend for the chart, if available.</p> <p>You can click an item in the legend to change its color, or add it as a filter (if applicable).</p>
Chart item (bar, pie slice, and so forth)	<p>Pause over a chart item, such as a bar item or pie slice, to view a summary of details for that item.</p> <p>Select a chart item to add a filter for it to apply to all visualizations.</p>

When you pause over a visualization, the Options and Legend (if applicable) icons are displayed on the top right and bottom left corners' respectively. Use them to inspect the chart or table, view the details of that visualization, and toggle the legend display.

For more information on working with Insights and filters, see PeopleTools *Search Technology*, “Working with Insights Dashboards for PeopleSoft Application Data” documentation.

## Understanding How to Deploy and Access the Payable Time Analytics

Before administrators can access the payable time data in Insights, the following steps should be performed:

1. Deploy the *HC\_TL\_GBL\_PAYABLETIME* and *HC\_TL\_GBL\_PAYABLETIME\_EXCPTN* (Payable Time data) indexes.

**PeopleTools > Search Framework > Search Admin Activity  
Guide > Administration > Deploy/Delete Object**

or

**(PeopleTools > Search Framework > Administration > Deploy Search Objects)**

2. Build the *HC\_TL\_GBL\_PAYABLETIME* and *HC\_TL\_GBL\_PAYABLETIME\_EXCPTN* search indexes, on building it you change the indexing type between Full Index and Incremental Index.

**PeopleTools > Search Framework > Search Admin Activity  
Guide > Administration > Schedule Search Index**

3. Deploy the Payable Time Insight tile, Payable Time Insight dashboard, Payable Time Trend tile, and Payable Time Trend dashboard.

**(PeopleTools > Search Framework > Administration > Deploy Dashboards to Insights)**

---

**Note:** The full index must be run before the dashboard can be deployed.

---

4. Assign the *TL Manager Fluid* role to administrators to managers and the *TL Administrator Fluid* role to administrators to access and view Payable Time Insight Analytics visualizations.

---

**Note:** Run the full index first time.

---

## Payable Time Insight Tile

The administrators or managers can use the Payable Time Insight tile to access the Payable Time Insight dashboard using PeopleSoft Insights for Time and Labor.

The Payable Time Insight tile displays the amount of payable time requiring approval and rejected by payroll in hours.

Users can view other statuses inside the dashboard. The reason for only showing these two statuses upfront is because these are the ones that most urgently need an administrator's attention.

Customers can modify the visualization to change or add other statuses to this tile.

This example illustrates the Payable Time Insight tile.



---

**Note:** These insights will consider only positive time reporters and excludes all exception time reporters.

---

Payable Time as well as Exceptions are results from running the Time Administration process. The Time Administration process takes Reported Time and generated Payable Time by applying the Time and Labor Rules. For more information, refer to [Time Administration](#).

## Payable Time Insight Dashboard

The Time administrators and managers can use the Payable Time Insight dashboard to view several interactive visualizations based on the time reporting time data specified for a date range for the group of employees specified by the filters.

The visualizations are used in the following ways:

- Identify the departments that generate the most overtime on average per person.
- Identify Payable Time statuses which may indicate a problem.
- Calculate the number of hours to be paid by TRC Category.
- Identify any exceptions that is block the processing of approvals.
- View the overtime trend.
- Calculate the payable shift hours.
- Identify the total of all overtime worked.

This example illustrates the fields and controls on the Payable Time Insight dashboard. You can find definitions for the fields and controls later on this page.

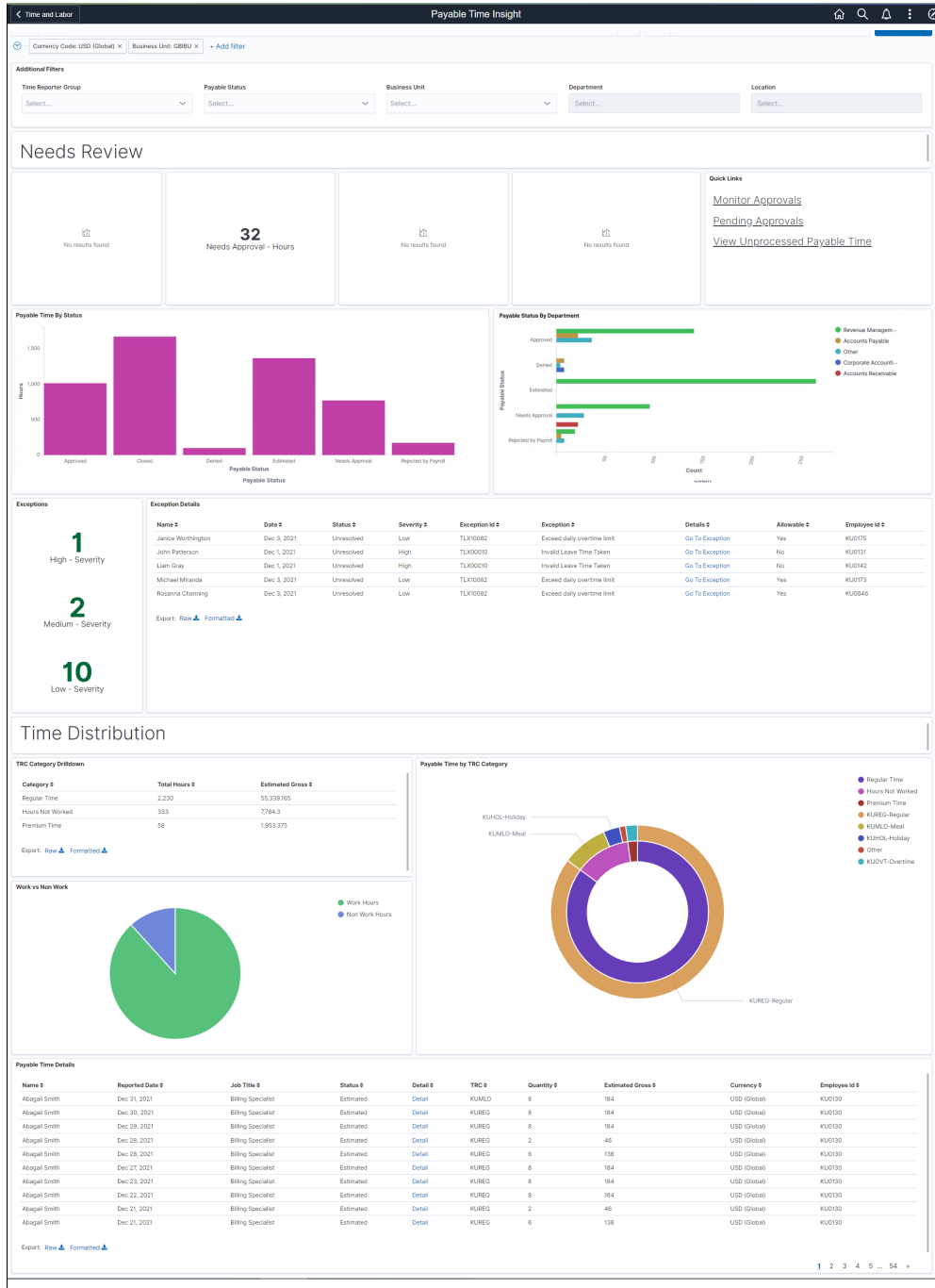

The visualizations are presented in different visual representations to best present data. There are different types of analytics which include:

- Needs Review
- Payable Time by Status
- Payable Status By Department
- Exceptions and Details



- TRC Category Drilldown
- Work Vs Non-Work
- Payable Time By TRC Category
- Payable Time Details

### Additional Filters

With any visualization, you can pause over an item to view the percentage or number counts, as desired.

Filtering options apply to all visualizations, which allows administrators to drill down on all the charts at once.

This example illustrates the fields and controls on the Additional Filters. You can find definitions for the fields and controls later on this page.



Additional Filters allows you select filters in the areas:

- Time Reporter Group
- Payable Status
- Business Unit
- Department
- Location

### Needs Review

Use the Needs Review visualization to view the Payable Time statuses which may require review.

This example illustrates the fields and controls on the Needs Review visualizations.

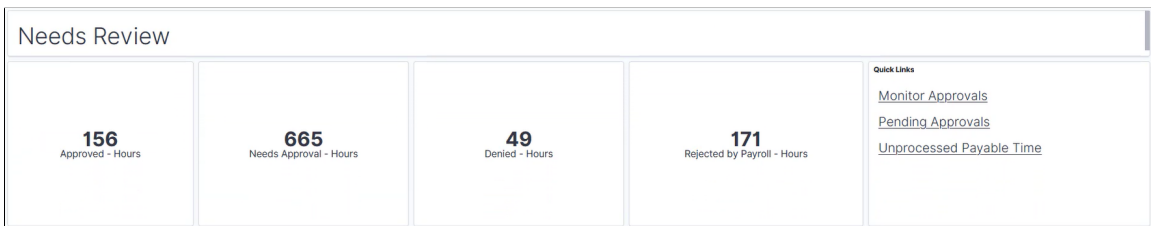

The **Quick Links** visualizations show approvals status and unprocessed payable time contains links to other pages which might be useful when reviewing the various Payable Time statuses.

---

**Note:** Quick Links show top 10 statuses in this visualization in alphabetical order. You can edit visualization and filter to include only specific statuses.

---

### Payable Time By Status Visualization

Use the Payable Time By Status visualization to view all of the payable time statuses.

This example illustrates the fields and controls on the Payable Time By Status.

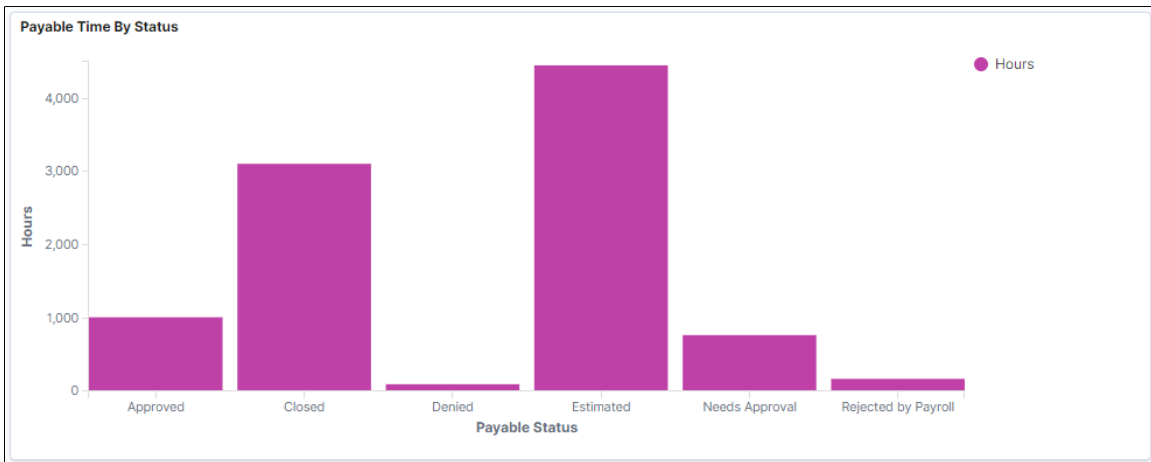

This bar chart displays the status such as approved, closed, denied, estimated, needs approval and rejected by payroll. This include all statuses that have time associated with them.

### Payable Status By Department

Use the Payable Statuses By Department visualization to view status by department.

This example illustrates the fields and controls on the Payable Status By Department visualization

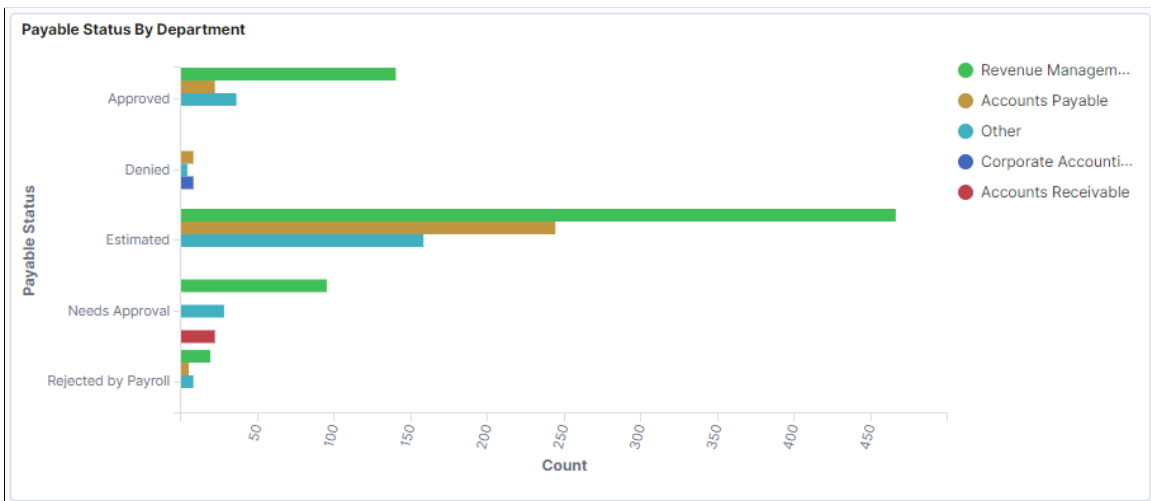

The legends represent the different departments in different colour. The corresponding counts are displayed for respective payable Time status.

### Exceptions

Use the Exceptions visualization to view the analytics for severity of high, medium and low.

This example illustrates the fields and controls on the Exceptions.

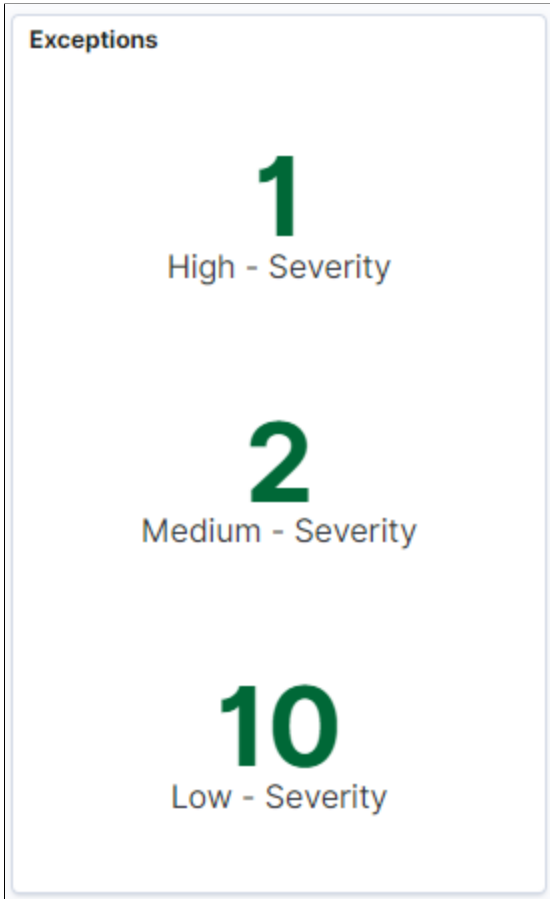

Select to see the Exception details.

### Exception Details

Use Exception Details to view details of the exceptions or to export the data in the format which is needed.

The exception index HC\_TL\_GBL\_PAYABLETIME\_EXCPTN is used for getting exceptions data.

This example illustrates the fields and controls on the Exception Details.

Name	Date	Status	Severity	Exception Id	Exception	Details	Allowable	Employee Id
Janice Worthington	Dec 3, 2021	Unresolved	Low	TLX10082	Exceed daily overtime limit	<a href="#">Go To Exception</a>	Yes	KU0175
John Patterson	Dec 1, 2021	Unresolved	High	TLX00010	Invalid Leave Time Taken	<a href="#">Go To Exception</a>	No	KU0131
Liam Gray	Dec 1, 2021	Unresolved	High	TLX00010	Invalid Leave Time Taken	<a href="#">Go To Exception</a>	No	KU0142
Michael Miranda	Dec 3, 2021	Unresolved	Low	TLX10082	Exceed daily overtime limit	<a href="#">Go To Exception</a>	Yes	KU0173
Rosanna Channing	Dec 3, 2021	Unresolved	Low	TLX10082	Exceed daily overtime limit	<a href="#">Go To Exception</a>	Yes	KU0046

Export: [Raw](#) [Formatted](#)

**Note:** The exception details show only the unresolved exceptions for which the source is Time Administration.



Select the **Go to Exception** hyperlink to access the **Manage Exceptions** page.

### TRC Category Drilldown

Use the TRC Category Drilldown to view time distribution where multiple TRCs are grouped by TRC category. The categories are based on the TRC Categories that your organization has set up.

This example illustrates the fields and controls on the TRC Category Drilldown.

Category ↕	Total Hours ↕	Estimated Gross ↕
Regular Time	2,230	55,339.165
Hours Not Worked	333	7,784.3
Premium Time	58	1,953.375

Export: [Raw](#)  [Formatted](#) 

**Note:** The TRC Categories are pulled in from the TRC Category set-up.

The inner ring contains the TRC Category while the outer ring contains the Time Reporting Codes (TRCs).

### Payable Time by TRC Category

Use Payable Time by TRC Category double doughnut visualizations to view the payable time distributed over TRC category.

This example illustrates the fields and controls on the Payable Time by TRC Category.

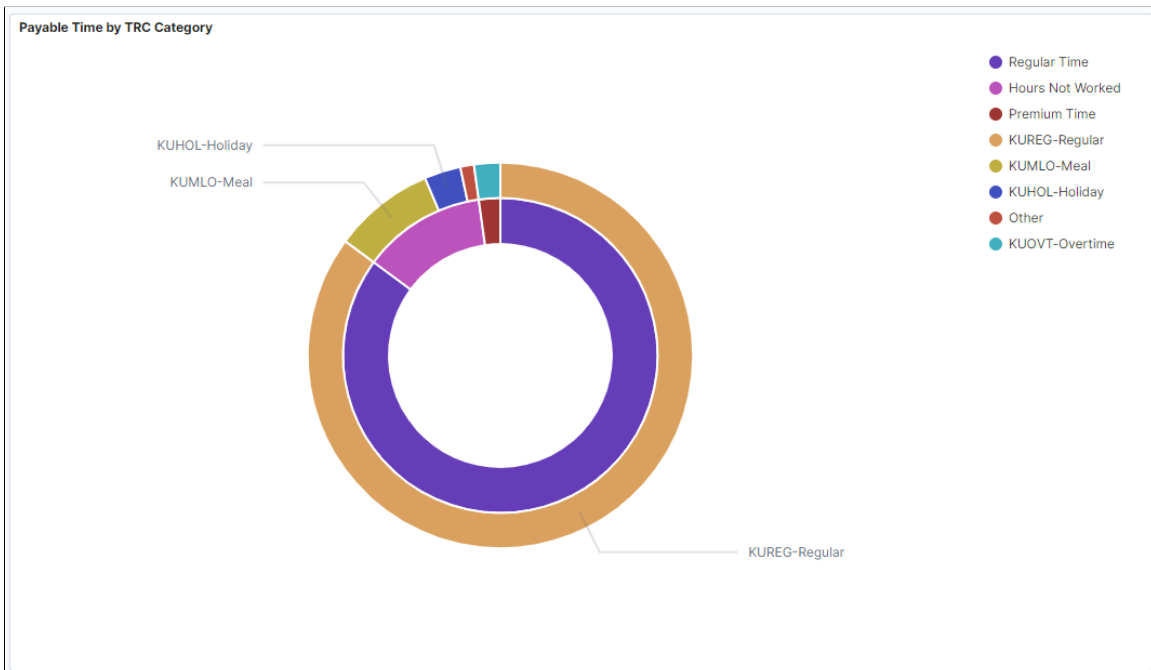

## Work vs Non Work

Use the Work vs Non Work visualization to view the distribution of work and non-work hours.

This example illustrates the fields and controls on the Work vs Non Work visualization. You can find definitions for the fields and controls later on this page.

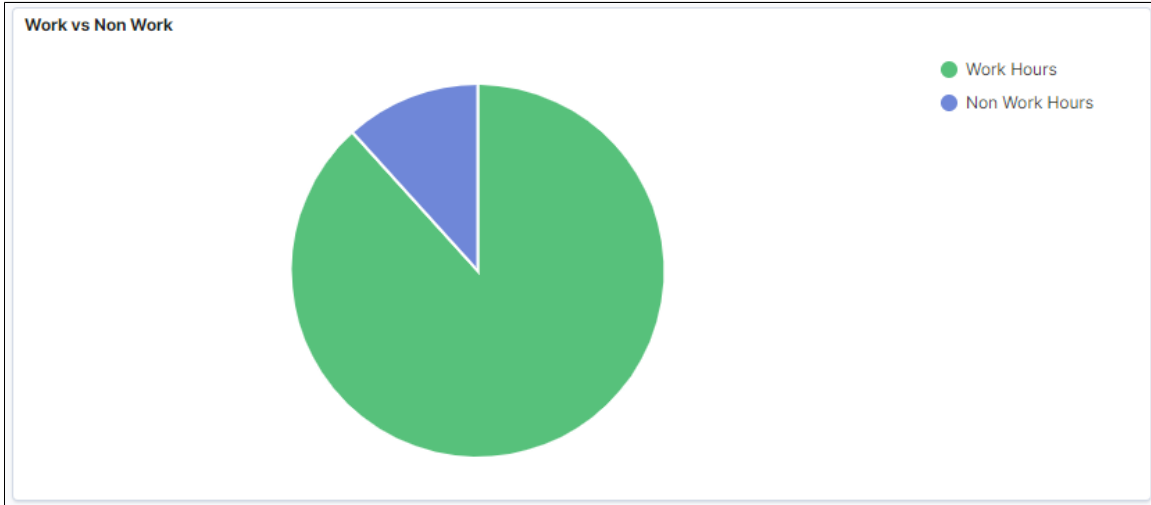

**Note:** You can configure the items to be displayed in the visualizations for Work vs Non Work. Use the WRKTRC and NONWRKTRC Value lists to categorize TRCs. For more details, refer to [Creating Value Lists](#).

## Payable Time Details

Use Payable Time Details to view the details and the data on the visualizations.

This example illustrates the fields and controls on the Payable Time Details.

Payable Time Details									
Abigail Smith	Dec 31, 2021	Billing Specialist	Estimated	Detail	KUMLD	8	184	USD (Global)	KU0130
Abigail Smith	Dec 30, 2021	Billing Specialist	Estimated	Detail	KUREG	8	184	USD (Global)	KU0130
Abigail Smith	Dec 29, 2021	Billing Specialist	Estimated	Detail	KUREG	8	184	USD (Global)	KU0130
Abigail Smith	Dec 28, 2021	Billing Specialist	Estimated	Detail	KUREG	2	46	USD (Global)	KU0130
Abigail Smith	Dec 28, 2021	Billing Specialist	Estimated	Detail	KUREG	6	138	USD (Global)	KU0130
Abigail Smith	Dec 27, 2021	Billing Specialist	Estimated	Detail	KUREG	8	184	USD (Global)	KU0130
Abigail Smith	Dec 23, 2021	Billing Specialist	Estimated	Detail	KUREG	8	184	USD (Global)	KU0130
Abigail Smith	Dec 22, 2021	Billing Specialist	Estimated	Detail	KUREG	8	184	USD (Global)	KU0130
Abigail Smith	Dec 21, 2021	Billing Specialist	Estimated	Detail	KUREG	2	46	USD (Global)	KU0130
Abigail Smith	Dec 21, 2021	Billing Specialist	Estimated	Detail	KUREG	6	138	USD (Global)	KU0130

Export: Raw [▲](#) Formatted [▲](#)

Selecting the **Detail** link takes you to Payable Time page from where you can manage the view settings.

## Payable Time Trend Tile

Use the Payable Time Trend tile to access Payable Time Trend Dashboard.

The tile displays the hours per month trend of payable time.

This example illustrates the Payable Time Trend Tile.

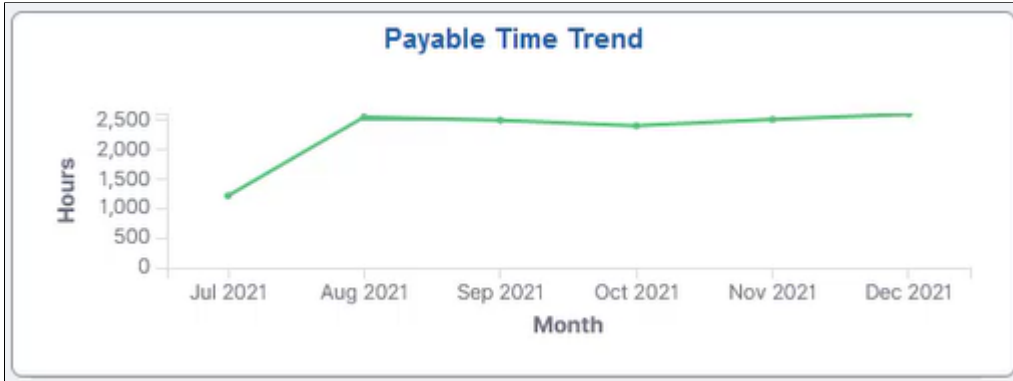

The Payable Time trend visualization displays a rolling period. It shows the past six months trend from the current months context.

## Payable Time Trend Dashboard

Use the Payable Time Trend and to view the payable time and overtime trends Dashboard and overtime trends by department.

The visualizations are used in the following ways:

- Identify the departments that generate the most payable time average overtime cost.
- View the overtime trend.

This example illustrates the fields and controls on the Payable Time Trend Dashboard.

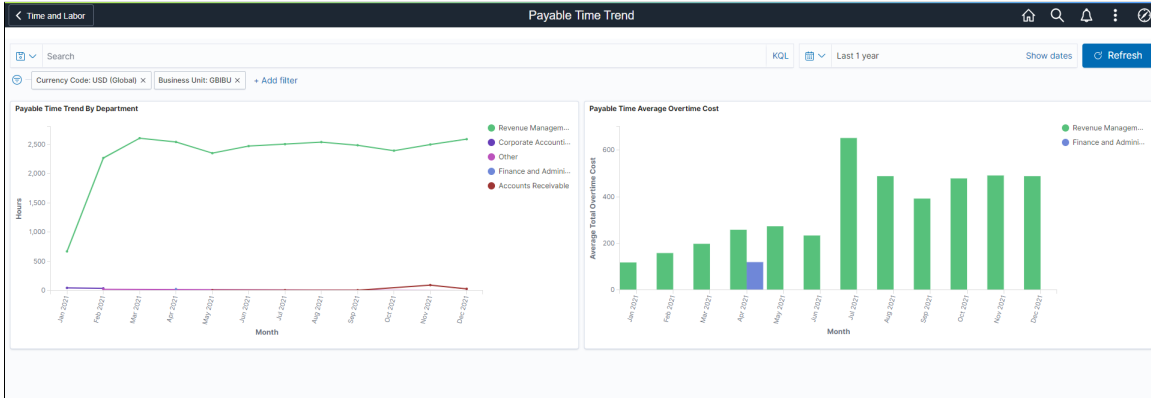

## Payable Time Trend By Department

Use Payable Time Trend By Department visualization to view the payable time trend in hours with the respective departments.

This example illustrates the fields and controls on the Payable Time Trend By department.

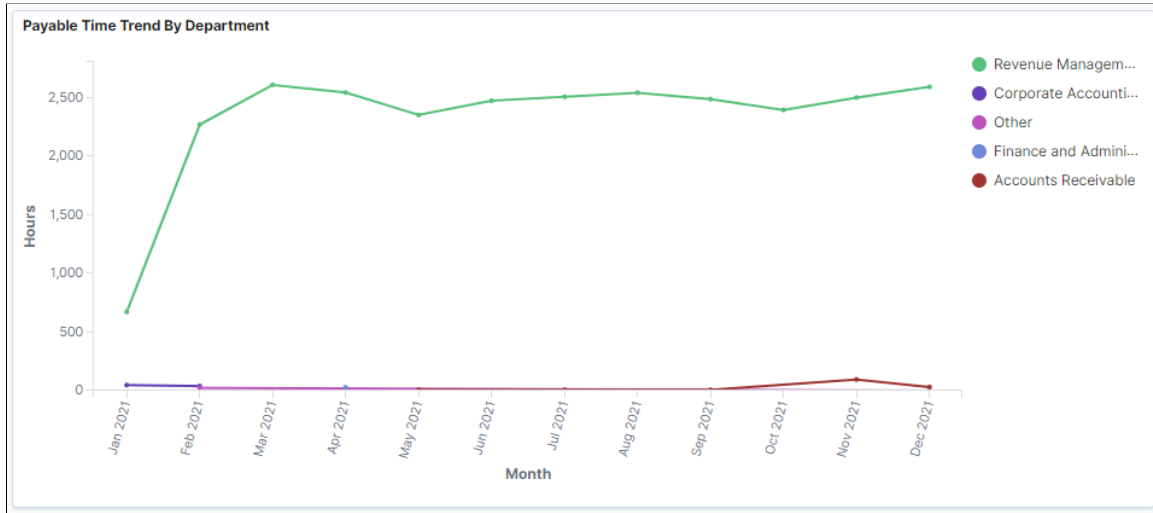

### Payable Time Average Overtime Cost

Use Payable Time Average Overtime Cost visualization to view the payable time trend of overtime cost.

This example illustrates the fields and controls on the Payable Time Average Overtime Cost.

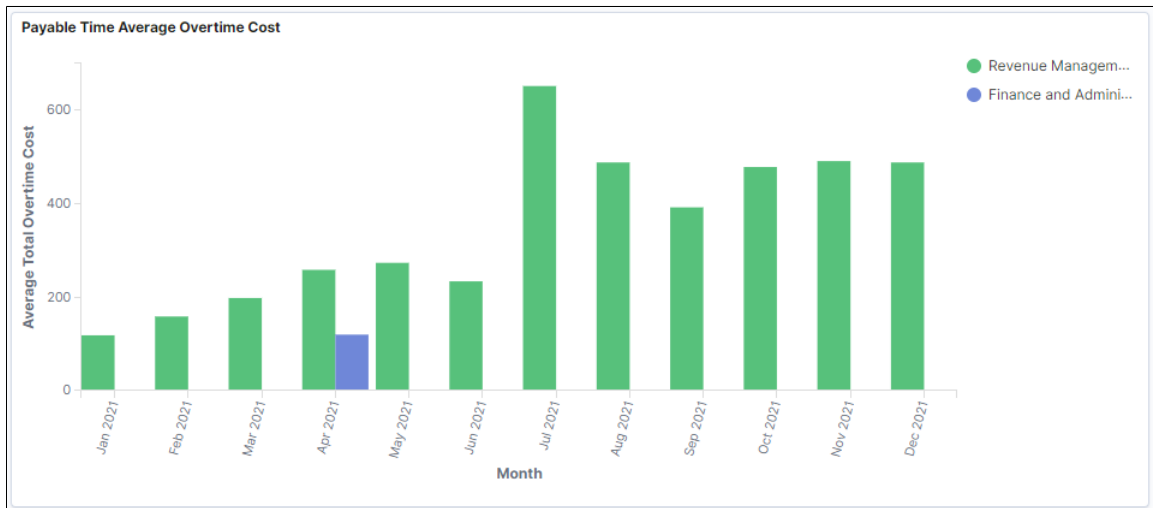

The Payable Time Average Overtime Cost visualization is for a rolling period. It shows the past twelve months average overtime cost from the current months' context by department.

## Approving Time Using Fluid Approvals

This topic describes how to approve Time using Fluid Approvals.

See also “Using PeopleSoft Fluid User Interface Self-Service Approval Transactions” (Application Fundamentals)

## Pages Used to Approve Time Using Fluid Approvals

<b>Page Name</b>	<b>Definition Name</b>	<b>Usage</b>
Approval Tile	EOAWMA_USER_FL	Tap to access the Time Approvals page.
<u>Approvals Navigation Collection</u>	EOAWMA_MAIN_FL	Select the navigation collection of the left panel to access: <ul style="list-style-type: none"> <li>• Overtime Request</li> <li>• Payable Time</li> <li>• Reported Time</li> </ul>
<u>Pending Approvals - Overtime Request</u>		Approve an overtime pending request.
<u>Overtime Request Details Page</u>	EOAWMA_TXNHDTL_FL	View Overtime request entry details.
<u>Request History</u>	TL_OT_REQHIST_SCF	View the history data of the overtime request and approvals.
<u>Approval Chain Details Page</u>	EOAWMA_APPC_SCF	View the list of approvers, transaction status and comments if any.
<u>Pending Approvals Navigation Collection page</u>	EOAWMA_MAIN_FL	Displays all the Payable Time pending approvals on the right pane.
<u>Pending Approvals_Payable Time Page</u>	EOAWMA_TXNHDTL_FL	View payable time entry details.
<u>Approval Chain Page</u>	EOAWMA_APPC_SCF	View the Payable Time history with date and comments.
<u>Pending Approval_Reported Time Page</u>	EOAWMA_TXNHDTL_FL	View Reported time entry details.
Approval Line Detail Page		Displays the report line details and the time details for a time reporter.
<u>Approval Chain Page</u>	EOAWMA_APPC_SCF	View the Reported Time history with date and comments.
<u>Approval Line Detail_Comments Page</u>	TL_TR_COMMENT_FLU	Add comments to be shown on Timesheet page.

### Approvals Navigation Collection

Use the Approval Navigation Collection (EOAWMA\_MAIN\_FL) to select the approval types from left panel.



Navigation:

On the Manager Self-Service home page, click the Approvals tile to access the Pending Approvals page.

You can access the following absence approval transactions from left panel:

- [Pending Approvals - Overtime Request](#)
- [Pending Approvals Navigation Collection page](#)
- [Pending Approval- Reported Time](#)

This example illustrates the fields and controls on the Pending Approvals Page.

View By		Type	
Promote Employee			
Dotted Line		4	
Employee Resignation		1	
Extended Absence		3	
Full/Part Time or Hours		1	
Job Offer		3	
Job Opening		3	
Leave Donations		4	
Location Change		2	
MaritalStatusChange		1	
Matrix Team		2	
Overtime Request		1	
Payable Time		6	
Performance		2	
Promote Employee		1	
Reported Time		15	
Reporting Change		1	
Request Leave of Absence		2	

Pending Approvals			
<b>All</b>			
66 rows			
<b>Reported Time</b>	Quantity for Approval 0.00 Hours	Routed	>
Abigail Smith	07/01/2014 - 07/02/2014	06/01/2014	
<b>Reported Time</b>	Quantity for Approval 28.00 Hours	Routed	>
Daryl Reese	09/22/2014 - 09/26/2014	07/03/2014	
<b>Job Opening</b>	Requester - Rosanna Channing	Routed	>
Manager-Finance	Job ID - 504033	08/07/2014	
<b>Allocate Compensation</b>	Focal 2013 Salary and Bonus	Routed	>
Group - Christelle Stevenson	Total Proposed Amount 3,182 USD	09/05/2014	
<b>Leave Donations</b>	Donate 8.00 Hours	Routed	>
Daryl Reese	Bank Voluntary	02/24/2016	
<b>Job Offer</b>	Requester - John Patterson	Routed	>
Employee Relationship Manager	Applicant - John Lee	11/07/2016	
<b>Job Offer</b>	Requester - John Patterson	Routed	>
Senior Procurement Manager	Applicant - Ellen Bontario	11/07/2016	
<b>Reported Time</b>	Quantity for Approval 10.00 Hours	Routed	>
Ronnie Carmichael	01/18/2017 - 01/18/2017	02/09/2017	
<b>Reported Time</b>	Quantity for Approval 0.00 Hours	Routed	>
Liam Gray	01/15/2017 - 01/15/2017	02/09/2017	
<b>Reported Time</b>	Quantity for Approval 8.00 Hours	Routed	>
Liam Gray	01/16/2017 - 01/16/2017	02/09/2017	
<b>Reported Time</b>	Quantity for Approval 10.00 Hours	Routed	>
Ronnie Carmichael	02/14/2017 - 02/14/2017	02/09/2017	
<b>Reported Time</b>	Quantity for Approval 8.00 Hours	Routed	>
Liam Gray	02/16/2017 - 02/16/2017	02/12/2017	
<b>Reported Time</b>	Quantity for Approval 8.00 Hours	Routed	>
Liam Gray	03/13/2017 - 03/13/2017	02/13/2017	
<b>Reported Time</b>	Quantity for Approval 10.00 Hours	Routed	>
Ronnie Carmichael	03/16/2017 - 03/16/2017	02/13/2017	

## Pending Approvals - Overtime Request

Use the Pending Approvals - Overtime Request page (EOAWMA\_MAIN\_FL) to approve an overtime request.

This topic describes how to approve Time and Labor Overtime using Fluid Approvals.

The following video provides a demonstration of how the managers can approve the overtime request of his employees.

Video: [Image Highlights, PeopleSoft Update Image 24: Time and Labor - Overtime Request Mobile Approval](#)

Navigation:

On the Manager Self-Service home page, click the Approvals tile to access the Pending Approvals page. On the left pane, you can see the Overtime Request listing. The right pane enables you to enter the approval comments.

You can approve or deny the approval requests based on the overtime summary and enter approval comments.

This example illustrates the fields and controls on the Pending Approvals - Overtime Request page.

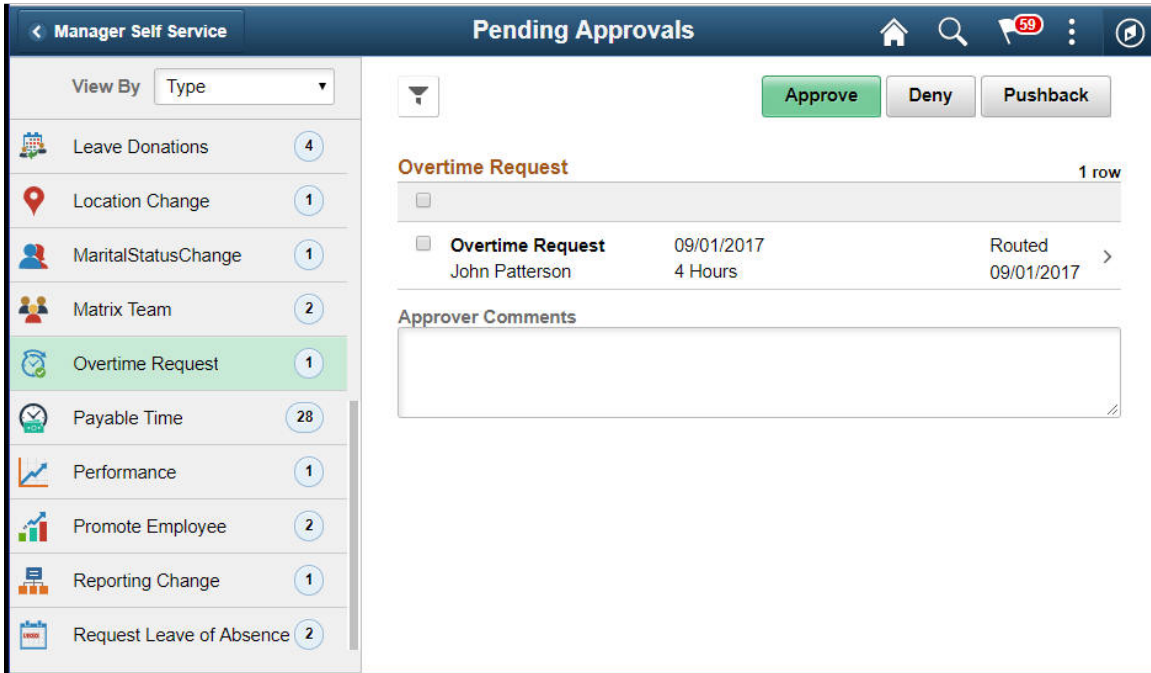

### Approval Options

The approval options on this page are common to all fluid approval transactions, as described in the documentation for the “Pending Approvals - <Transaction Details> Page” (Application Fundamentals).

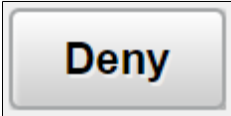
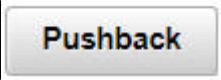
<b>Field or Control</b>	<b>Description</b>
 and 	Use these buttons to take action on the requested approval.
	Click this item to revert the approval.
<b>Approver Comments</b>	Enter any comments related to the approval action you take.

### Overtime Detail

<i>Field or Control</i>	<i>Description</i>
	Click to access the <a href="#">Overtime Request Details Page</a> to view change details before taking any approval action.

### Overtime Request Details Page

Use the Overtime Request Details page (EOAWMA\_TXNHDTL\_FL) to view overtime entry details.

Navigation:

Click the Overtime Request Details item on the Pending Approvals - Overtime Request page.

This example illustrates the fields and controls on the Overtime Request Details page.

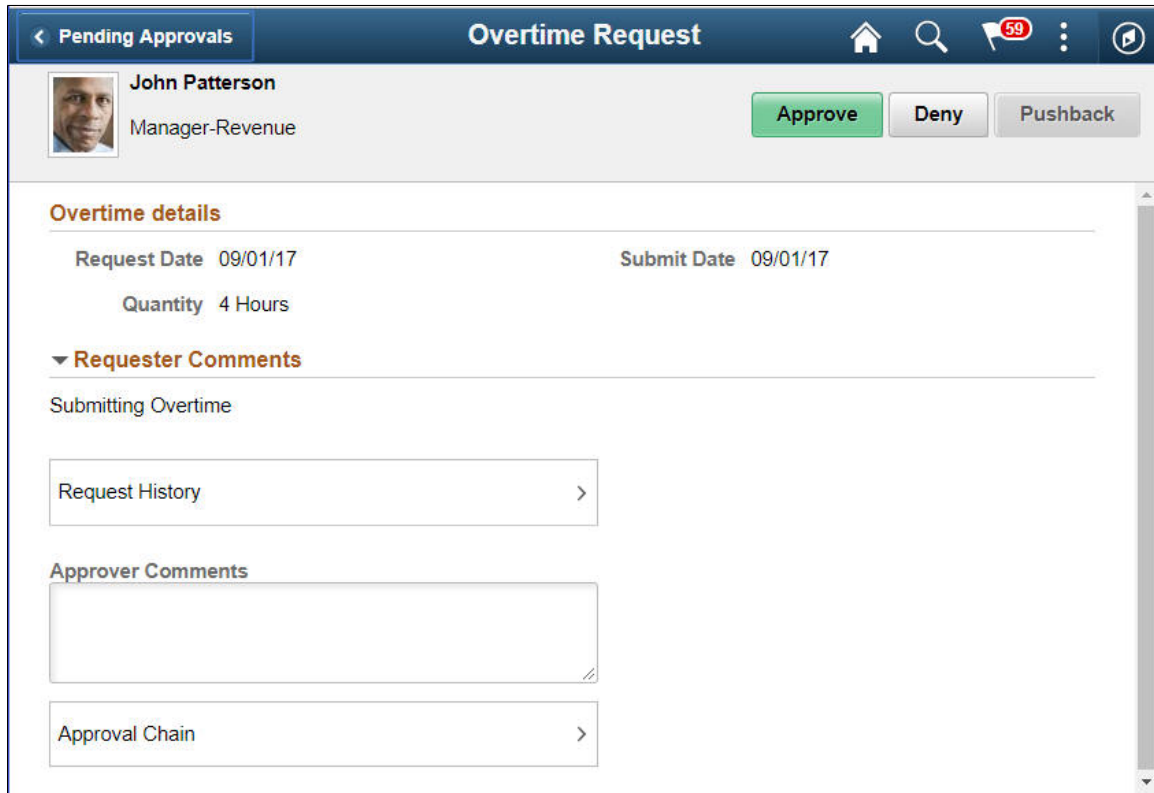

<i>Field or Control</i>	<i>Description</i>
<b>Overtime Details</b>	View request date, submit date and the time in hours.
<b>Request History</b>	Click to access the <a href="#">Approval Chain Page</a> to view Overtime Request history with date and comments.

<b>Field or Control</b>	<b>Description</b>
<b>Approver Comments</b>	Field for approvers to provide comments, if any.
<b>Approval Chain</b>	Click to access the <a href="#">Approval Chain Details Page</a> to view the information about approvers associated with the request and approval status.

## Request History

Use the Request History page (TL\_OT\_REQHIST\_SCF) to view the Overtime Request history with date and comments.

Navigation:

Click the Request History item on the Overtime Request Details page.

This example illustrates the fields and controls on the Request History page.



The screenshot shows a window titled "Request History" with a close button (X) in the top right corner. The content of the window is as follows:

<b>Request Status</b>	Needs Approval
<b>Requested By</b>	John Patterson
<b>Date</b>	09/01/2017
<b>Comments</b>	Submitting Overtime

## Approval Chain Details Page

Use the Approval Chain Details page (EOAWMA\_APPC\_SCF) to view the information about approvers associated with the request and approval status.

Navigation:

Click the Approval Chain item on the Overtime Request Details page.

This example illustrates the fields and controls on the Approval Chain Details page.

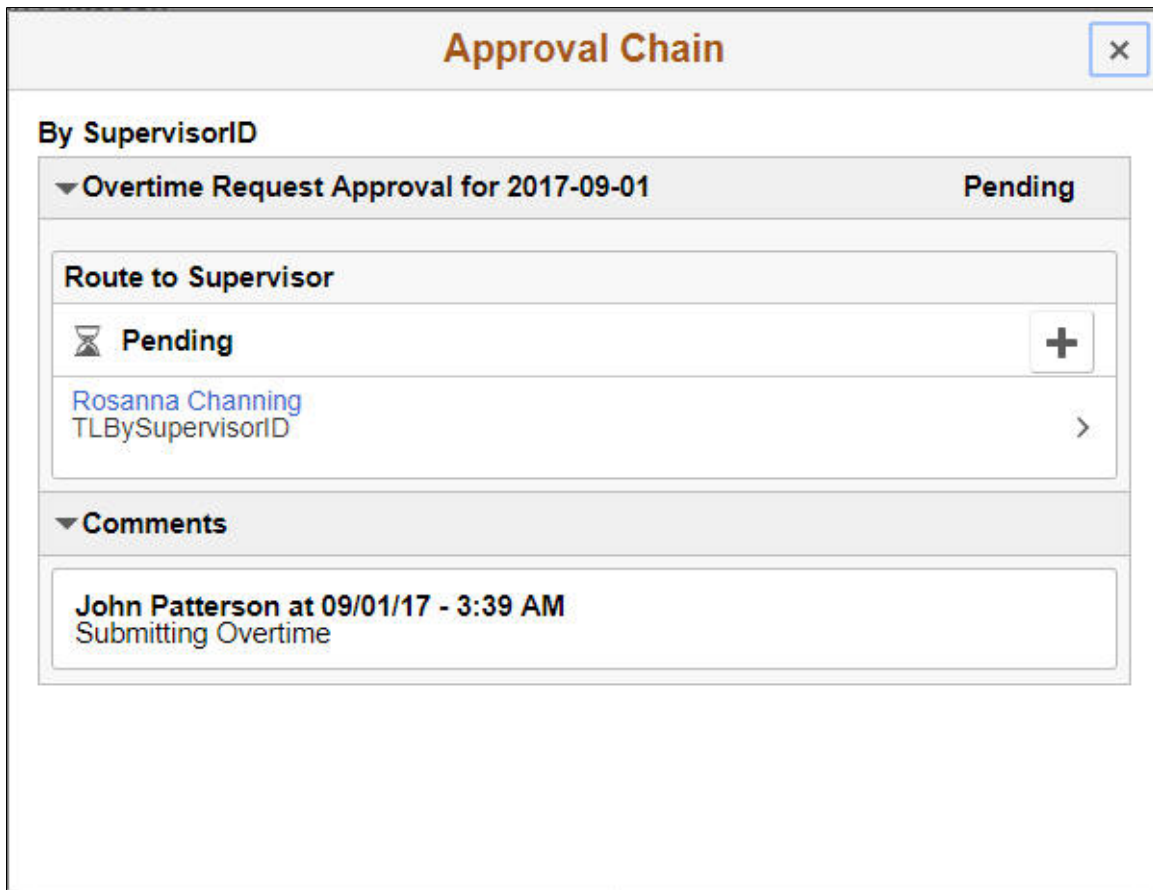

## Pending Approvals Navigation Collection page

Use the Pending Approvals Navigation Collection page (EOAWMA\_MAIN\_FL) to view all the pending approvals.

The following video provides a demonstration of how the managers can approve the payable time request of his employees.

Video: [Image Highlights, PeopleSoft Update Image 25: Time and Labor Fluid Approvals - Payable Time](#)

Navigation:

On the Manager Self-Service home page, click the Approvals tile to access the Pending Approvals page. On the left pane, you can see the Payable Time listing. The right pane enables you to view the payable time entries pending approvals.

This example illustrates the fields and controls on the Pending Approvals Navigation Collection page.

Manager Self Service		Pending Approvals	
View By	Type		
All	7	<b>All</b> <span style="float: right;">7 rows</span>	
Cancel Absence	2	<b>Cancel Absence</b>	Vacation, 8 Hours
Payable Time	5	Michael Miranda	07/25/2017
			Routed 06/19/2017 >
		<b>Cancel Absence</b>	Vacation, 8 Hours
		Michael Miranda	06/14/2017
			Routed 06/19/2017 >
		<b>Payable Time</b>	Quantity for Approval -9 Hours
		Cindy Bryson	12/11/2017 - 12/11/2017
			Routed 12/11/2017 >
		<b>Payable Time</b>	Quantity for Approval 62.5 Hours
		Cindy Bryson	12/08/2017 - 12/14/2017
			Routed 12/11/2017 >
		<b>Payable Time</b>	Quantity for Approval -9 Hours
		Kai MacKenzie	12/13/2017 - 12/15/2017
			Routed 12/11/2017 >
		<b>Payable Time</b>	Quantity for Approval -8 Hours
		Kai MacKenzie	12/15/2017 - 12/15/2017
			Routed 12/22/2017 >
		<b>Payable Time</b>	Quantity for Approval 35 Hours
		Kai MacKenzie	12/11/2017 - 12/19/2017
			Routed 12/22/2017 >

This example illustrates the fields and controls on the Pending Approvals left pane in the smartphone.

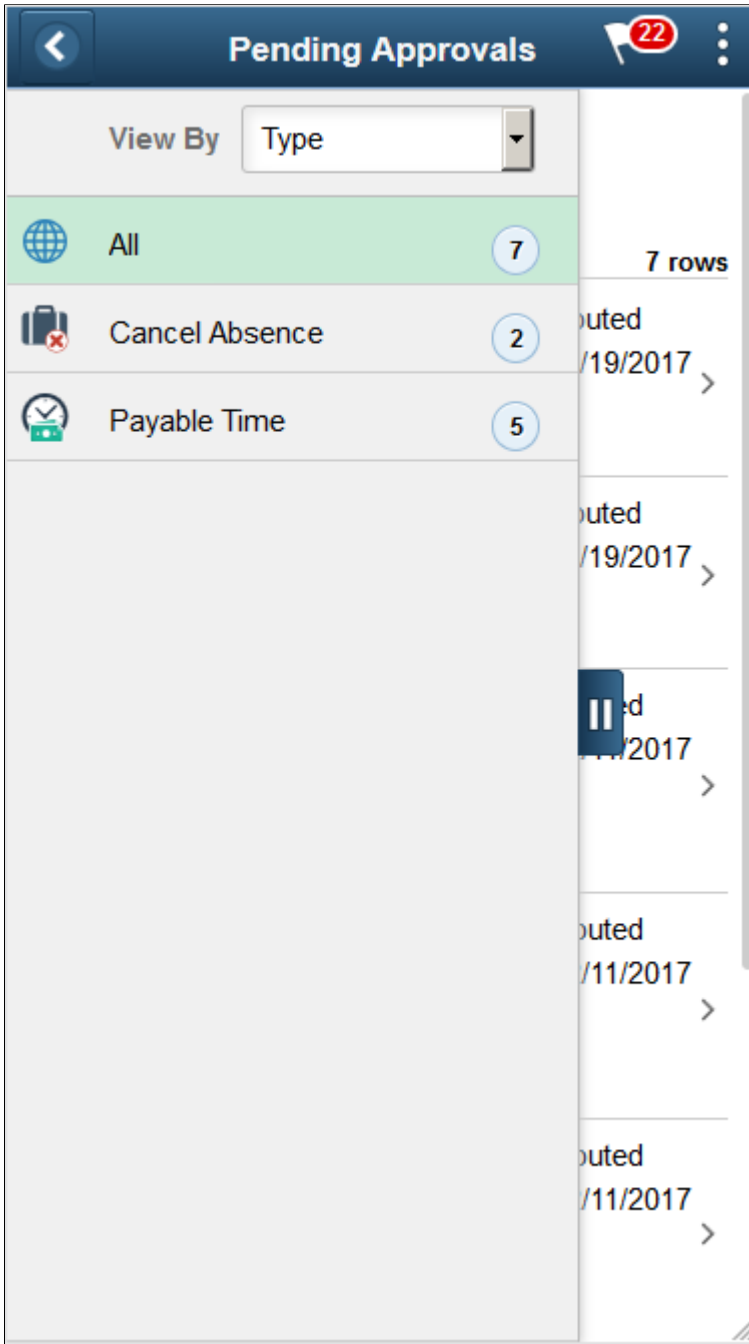

This example illustrates the fields and controls on the Pending Approvals right pane in a smartphone.



## Pending Approvals\_Payable Time Page

Use the Pending Approvals\_Payable Time page (EOAWMA\_TXNHDTL\_FL) to view payable time entry details.

Navigation:

Click the Payable Time Details item on the Pending Approvals which requires approvals.



This example illustrates the fields and controls of Pending Approvals\_Payable Time page

The screenshot shows the 'Pending Approvals' page for 'Payable Time'. At the top, the user 'Kai MacKenzie, Billing Specialist' is identified, with 'Approve' and 'Deny' buttons. A notification states '8 line(s) are pending your approval'. Below this is a 'Summary' section with 'Quantity for Approval: 35 Hours' and 'Time Period: 12/11/2017 - 12/19/2017'. The 'Payable Time Details' section has tabs for 'Pending' and 'All'. A table with 8 rows displays the following data:

Select	Report Date	Time Reporting Code	Quantity
<input type="checkbox"/>	12/11/17	KUOVT - Overtime	2 Hours
<input type="checkbox"/>	12/13/17	KUREG - Regular	8 Hours
<input type="checkbox"/>	12/13/17	KUOVT - Overtime	1 Hours
<input type="checkbox"/>	12/15/17	KUREG - Regular	6.25 Hours
<input type="checkbox"/>	12/15/17	KUMLO - Meal	.5 Hours
<input type="checkbox"/>	12/15/17	KUOVT - Overtime	3.25 Hours
<input type="checkbox"/>	12/17/17	KUOVT - Overtime	6 Hours
<input type="checkbox"/>	12/19/17	KUSIK - Sick Leave	8 Hours

This example illustrates the fields and controls of Pending Approvals\_Payable Time (2 of 2) page

This screenshot shows the second page of the 'Pending Approvals' interface. It features the same table as the first page. Below the table, there is an 'Approver Comments' text area and an 'Approval Chain' dropdown menu.

This example illustrates the fields and controls of Payable Time details (1 of 2) page in a smartphone.

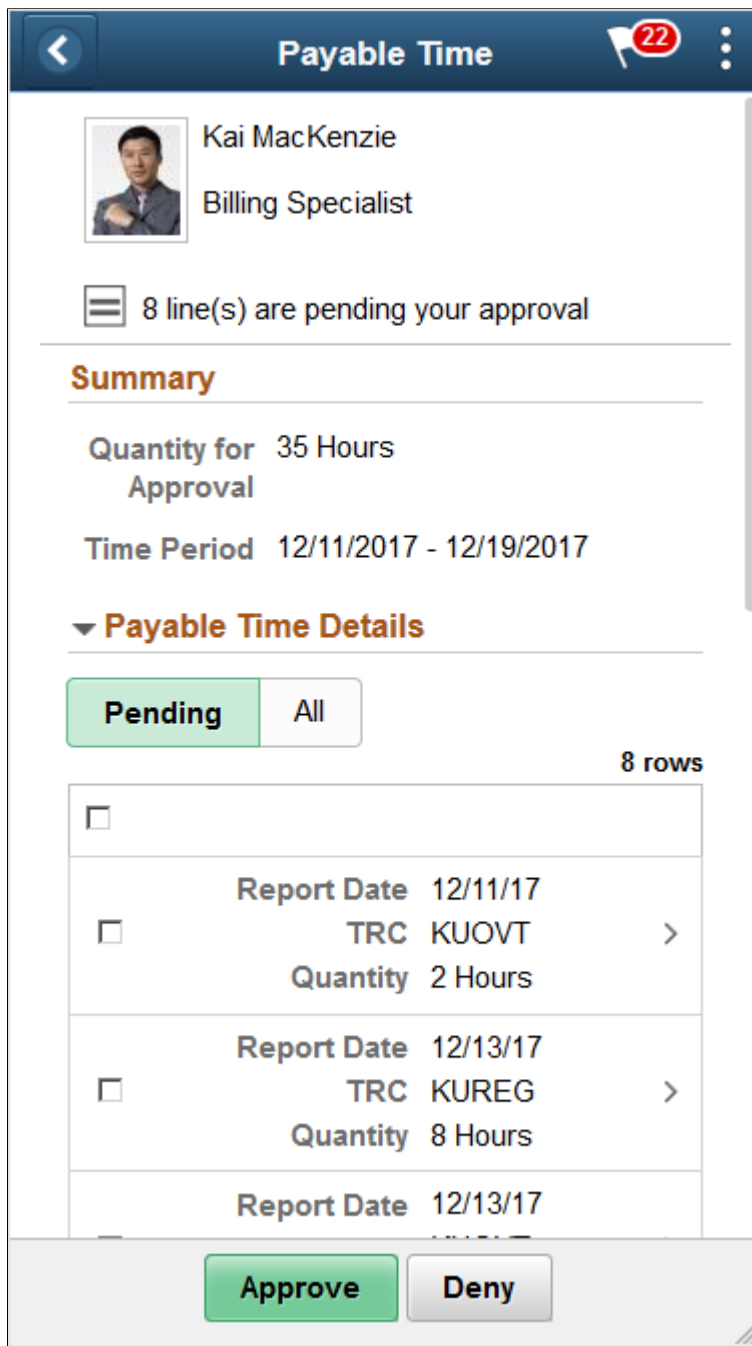

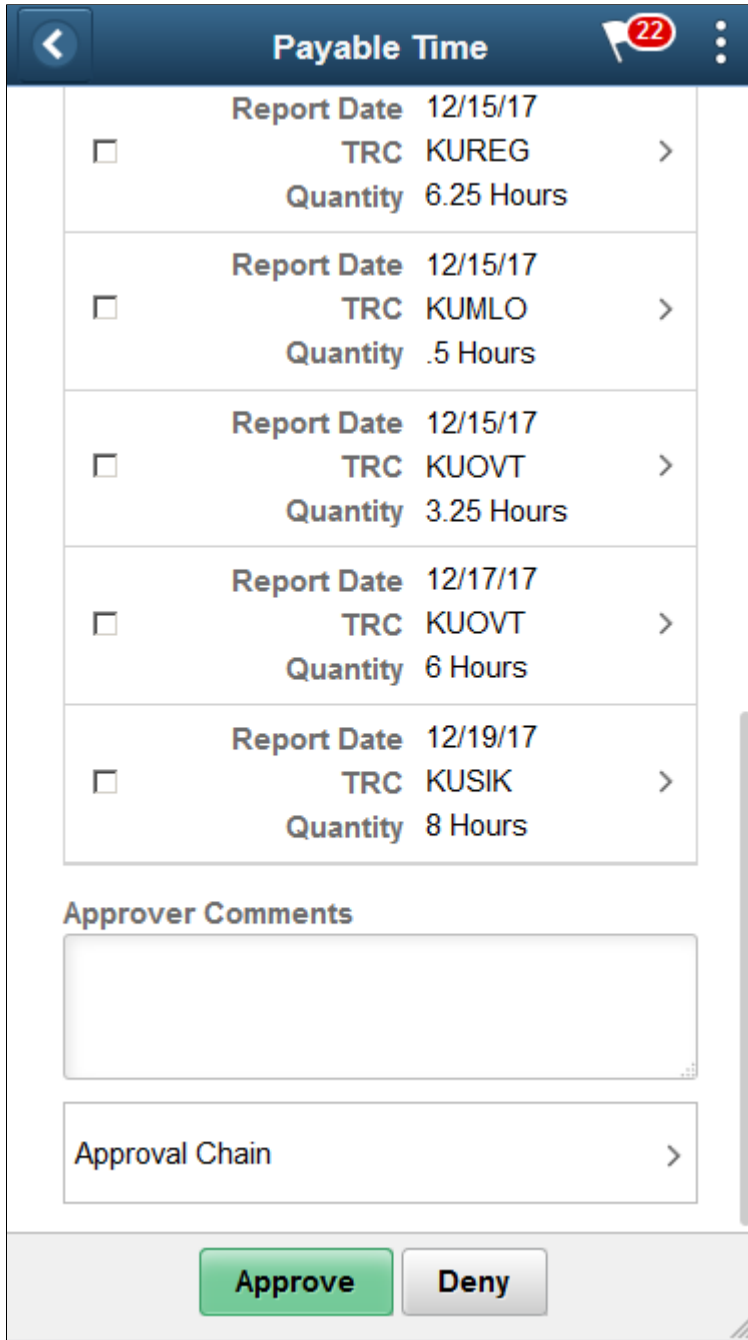

<i>Field or Control</i>	<i>Description</i>
<b>Pending</b>	Displays all the pending requests. The option for <b>Approve</b> or <b>Deny</b> is available for the selected requests.
<b>All</b>	Displays all, both pending and transacted requests from the employee.

This example illustrates the fields and controls of Payable Time details (2 of 2) page in a smartphone.



<i>Field or Control</i>	<i>Description</i>
<b>Summary</b>	Displays the sum of quantity pending approval (in hours) for the time period.
<b>Payable Time Details</b>	Shows the list of payable time entries generated for the time period that needs approval.
<b>Approver Comments</b>	Field for approvers to provide comments, if any.

<i>Field or Control</i>	<i>Description</i>
<b>Approval Chain</b>	Click to access <a href="#">Approval Chain Page</a> to view the information about approvers associated and approval status.
 and 	Use these buttons to take action on the approval.

## Approval Line Details Page

Use the Approval Time Line Details Page (EOAWMA\_TXNHDTL\_FL) to view the payable time line additional details and access the **Adjust reported time** and **Comments** link.

Navigation:

Select the on any Payable Time entry.

This example illustrates the fields and controls of Approval Line Detail page.

 **Approval Line Detail**  

---

 **Kai MacKenzie**  
Billing Specialist

---

**Payable Time Line Details**

---

**Report Date** 12/19/17

**Time** KUSIK

**Reporting Code**

**Quantity** 8 Hours

**Estimated Gross** 184 USD

**Offset** No

[Adjust Reported Time](#)  
[Comments](#)

<b>Field or Control</b>	<b>Description</b>
<b>Payable Time Line Details</b>	View date under report, time reporting code, and description time in hours and the estimated gross. <ul style="list-style-type: none"> <li>• <b>Report Date:</b> is the date for which payable time is reported.</li> <li>• <b>Time Reporting Code:</b></li> <li>• <b>Quantity:</b></li> <li>• <b>Estimated Gross</b></li> <li>• <b>Offset</b></li> </ul>
<b>Adjust reported time</b>	Select to adjust reported time using the Fluid Report time page.
<b>Comments</b>	Select to provide any comments for the day.

This example illustrates the Approve Comments Modal.

The screenshot shows a modal window titled "Approve". At the top left is a "Cancel" button, at the top right is a "Submit" button, and in the center is the word "Approve" in a large, bold, orange font. Below the title bar, the text "You are about to approve this request." is displayed. Underneath this text is a section labeled "Approver Comments" with a large, empty text input field for entering comments.

## Approval Chain Page

Use the Approval Chain page (EOAWMA\_APPC\_SCF) displays the approvers and the approval status at each step/stage or path.

Navigation:

Click the Approval Chain item on the Pending Approval\_ Reported Time Page .

This example illustrates the approval chain details page.

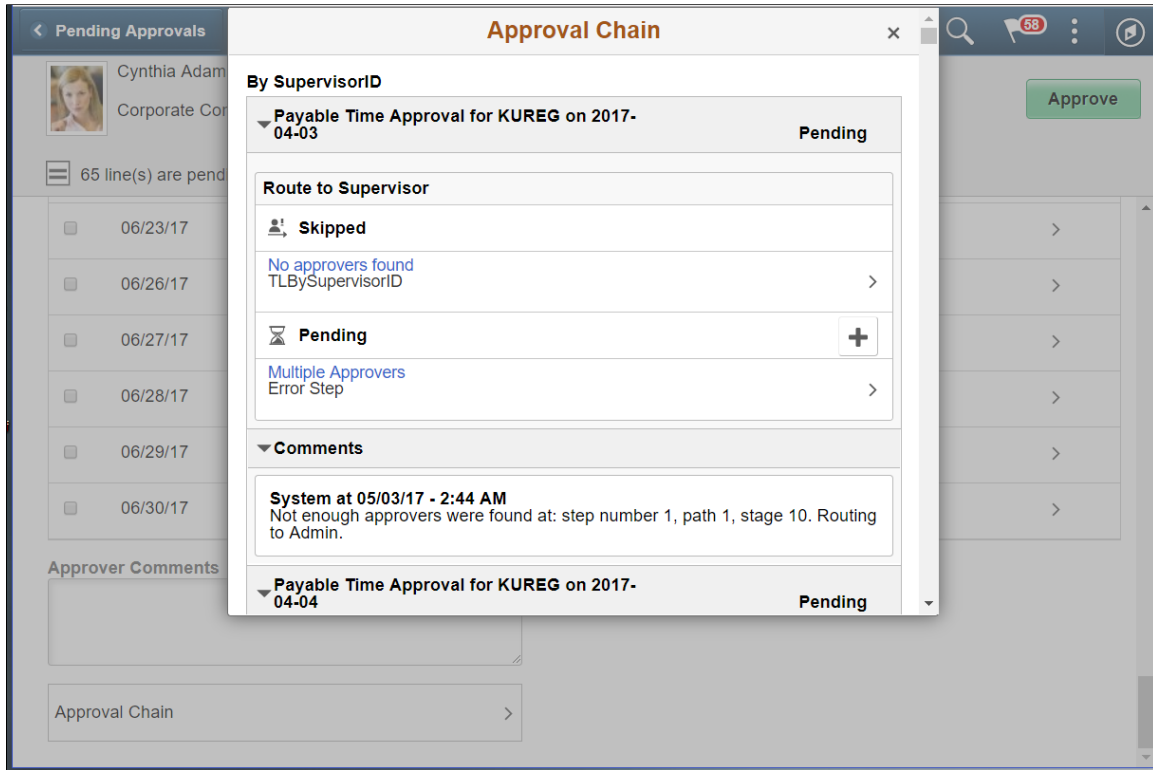

## Pending Approval- Reported Time

Use the Pending Approvals - Reported Time (EOAWMA\_TXNHDTL\_FL) page to approve the reported time.

Navigation:

On the Manager Self-Service home page, click the Approvals tile to access the Pending Approvals page. On the left pane, you can see the Reported Time listing. The right pane enables you to view the Reported time entries pending approvals.

You can access the following absence approval transactions from left panel:

This example illustrates the fields and controls on the Pending Approvals - Reported Time page.

The screenshot shows the 'Pending Approvals' page in the 'Manager Self Service' interface. The left-hand navigation menu includes options like 'All' (17), 'Absence Request' (6), 'Cancel Absence' (1), 'Life Event' (1), 'MaritalStatusChange' (5), 'Person Profile' (1), and 'Reported Time' (3), which is currently selected. The main content area displays a table of reported time entries. The table has three rows, each representing a reported time entry for 'Athena Dachshund'. Each row includes the entry type ('Reported Time'), the quantity for approval, the approval dates, and the status ('Routed').

Reported Time				3 rows
Reported Time	Quantity for Approval 7 Hours	08/22/2012 - 08/22/2012	Routed	08/25/2012 >
Reported Time	Quantity for Approval 40 Hours	04/16/2018 - 04/20/2018	Routed	04/23/2018 >
Reported Time	Quantity for Approval 34 Hours	04/23/2018 - 04/27/2018	Routed	04/23/2018 >



This example illustrates the fields and controls on the Pending Approvals - Reported Time left pane page in a smartphone.

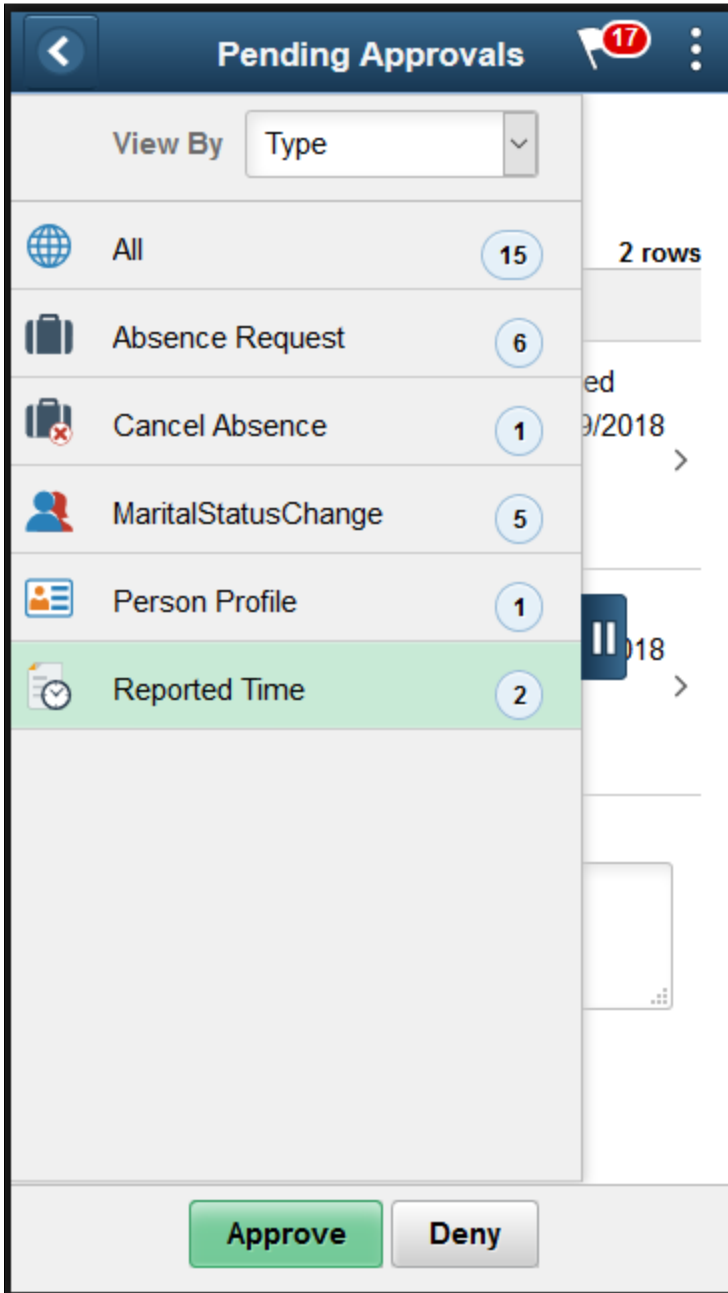

This example illustrates the fields and controls on the Pending Approvals - Reported Time right pane page in a smartphone.

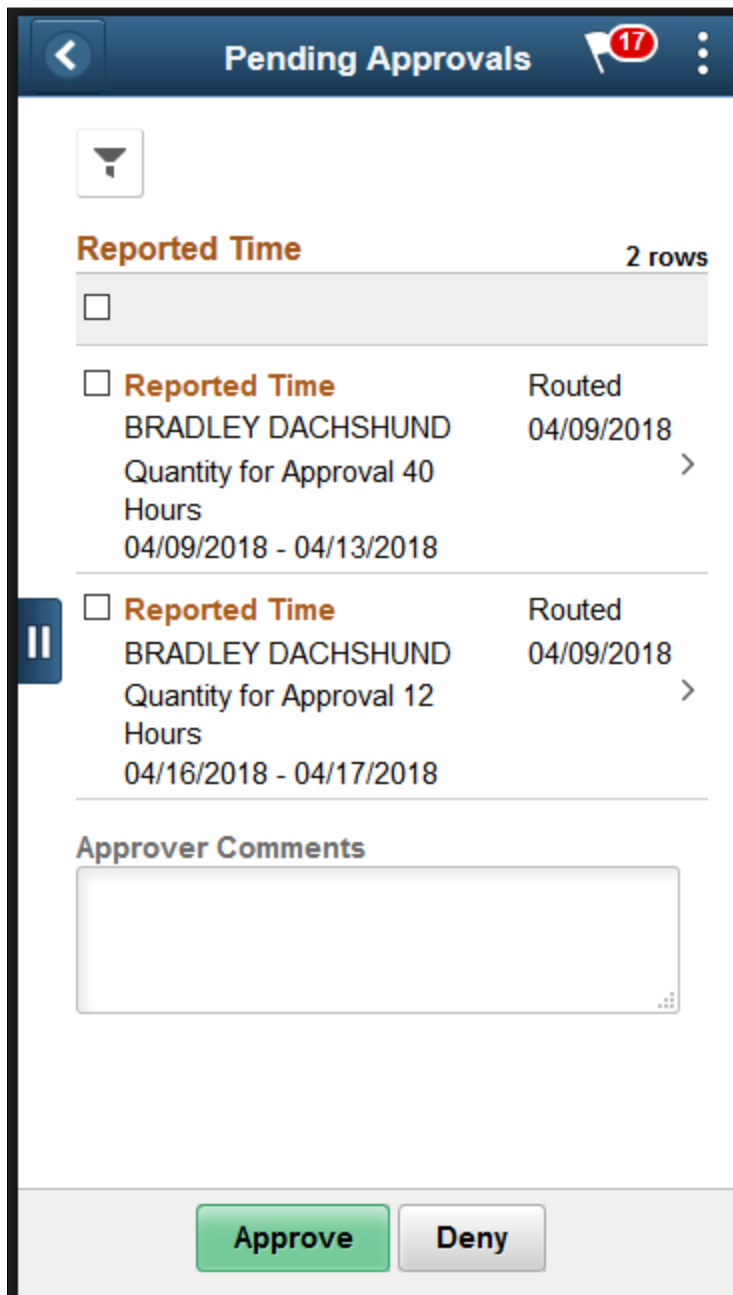

## Pending Approval\_Reported Time Page

This example illustrates the fields and controls on the Pending Approvals - Reported Time right pane page in a smartphone.

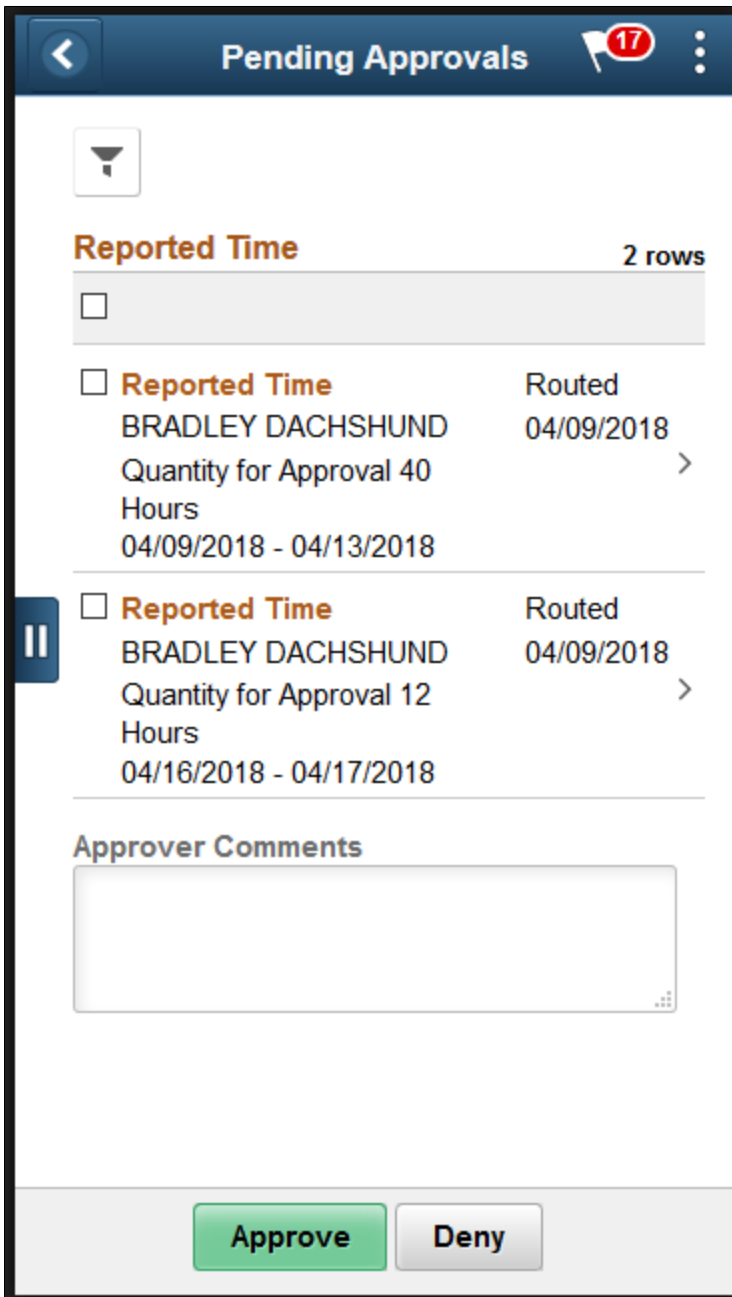

Use the Reported Time page (EOAWMA\_TXNHDTL\_FL) to view Reported time entry details.

Navigation:

Click the Reported Time Details item on the Pending Approvals which requires transaction.

This example illustrates the fields and controls of Reported Time page

**Reported Time**

John Patterson  
Manager-Revenue

4 line(s) are pending your approval

**Summary**

Time Period 09/17/2018 - 09/21/2018

Quantity for Approval 56.50 Hours      Quantity Scheduled 40.00 Hours

Quantity Submitted/ Approved 8.00 Hours      Quantity Reported 64.50 Hours

Quantity Denied 0.00 Hours

[View Legend](#)

**Reported Time Details**

Pending All

4 rows

Select	Report Date	Time Reporting Code	Quantity for Approval	Reported for Date / Scheduled for Date
<input type="checkbox"/>	09/17/2018	KUREG - Regular	8.00 Hours	8.00 Hours / 8.00 Hours
<input type="checkbox"/>	09/19/2018	KUREG - Regular	6.50 Hours	6.50 Hours / 8.00 Hours
<input type="checkbox"/>	09/20/2018	KUREG - Regular	36.00 Hours	36.00 Hours / 8.00 Hours
<input type="checkbox"/>	09/21/2018	KUREG - Regular	6.00 Hours	6.00 Hours / 8.00 Hours

Approver Comments

Approval Chain

This example illustrates the fields and controls of Reported Time details page in a smartphone.

**Reported Time** 71

John Patterson  
Manager-Revenue

3 line(s) are pending your approval

---

**Summary**

**Time Period** 06/18/2018 - 06/20/2018

**Quantity for Approval** 24.00 Hours

**Quantity Submitted/Approved** 0.00 Hours

**Quantity Denied** 0.00 Hours

**Quantity Scheduled** 24.00 Hours

**Quantity Reported** 24.00 Hours

---

**Reported Time Details**

**Pending** All

3 rows

<input type="checkbox"/>
Report Date 06/18/2018

**Approve** **Deny** **Pushback**

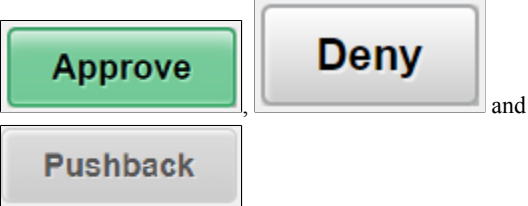
<b>Field or Control</b>	<b>Description</b>
<b>Summary</b>	<p>This summary area contains the following details:</p> <p><b>Time Period:</b> Time period for which the reported time is submitted.</p> <p><b>Quantity for approval:</b> Total hours reported by employee for the time and pending for approval.</p> <p><b>Quantity Submitted / Approved:</b> Total hours reported by user and has been approved or does not need approval.</p> <p><b>Quantity Denied:</b> Total hours reported by user and has been denied.</p> <p><b>Quantity Scheduled:</b> Total scheduled hours for the time as per users schedule definition.</p> <p><b>Quantity Reported:</b> Total hours reported by the user for the above time.</p> <hr/> <p><b>Note:</b> The values of Time period, Quantity for approval, Quantity submitted, Quantity denied should change depending on the transacted (Approve/ Deny/ Push back) lines.</p> <hr/>
<b>Pending</b>	Displays all the pending requests. The option for <b>Approve</b> or <b>Deny</b> is available for the selected requests.
<b>All</b>	Displays all, both pending and transacted requests from the employee.
<b>Reported Time Details</b>	<p>Shows the list of reported time entries generated for the time period that needs approval.</p> <p>For an Elapsed Time reporters, the grid displays the time details for the date, Time Reporting Code and the reported quantity.</p>
<b>Approver Comments</b>	Field for approvers to provide comments, if any.
<b>Approval Chain</b>	Click to access <a href="#">Approval Chain Page</a> to view the information about approvers associated and approval status.
	Use these buttons to take actions on the approval.
<b>View Legend</b>	Select the hyperlink to open <a href="#">Legend Page</a>

<b>Field or Control</b>	<b>Description</b>
	Select to open <i>Approval Line Detail Page</i> .

This example illustrates the fields and controls of Approval Line Detail page which displays the Reported Time Line Details and the Time Details for a Punch Time reporter.

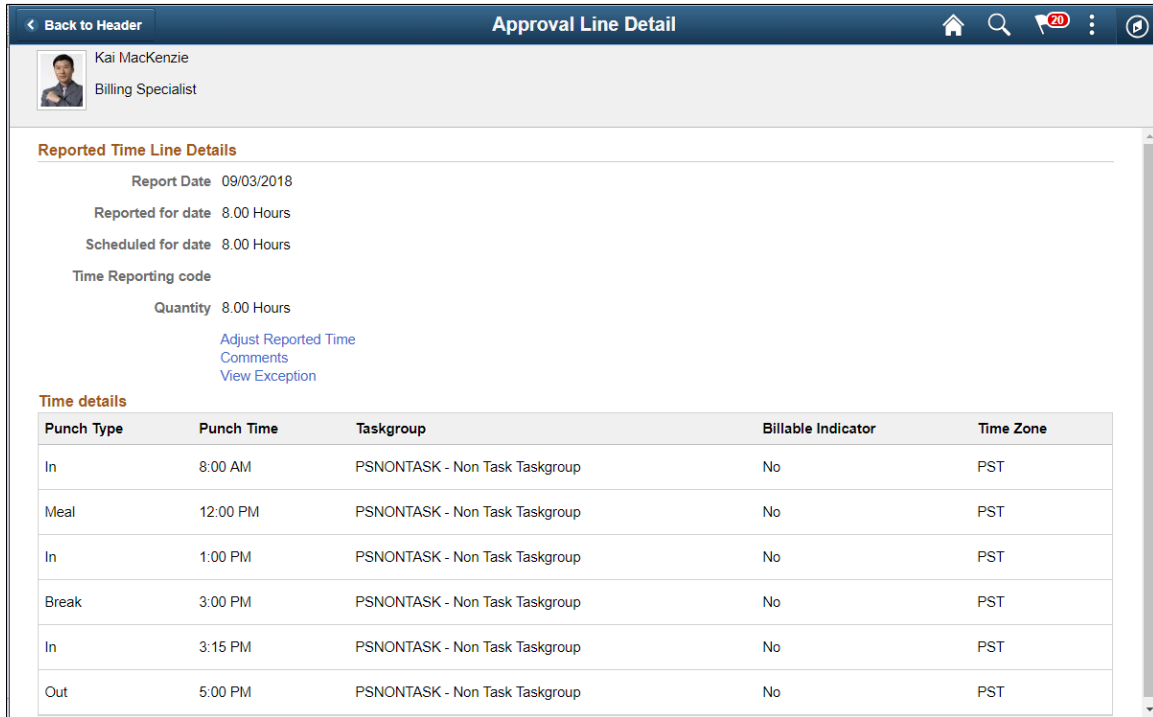

**Reported Time Line Details**

Report Date 09/03/2018

Reported for date 8.00 Hours

Scheduled for date 8.00 Hours

Time Reporting code

Quantity 8.00 Hours

[Adjust Reported Time](#)

[Comments](#)

[View Exception](#)

**Time details**

Punch Type	Punch Time	Taskgroup	Billable Indicator	Time Zone
In	8:00 AM	PSNONTASK - Non Task Taskgroup	No	PST
Meal	12:00 PM	PSNONTASK - Non Task Taskgroup	No	PST
In	1:00 PM	PSNONTASK - Non Task Taskgroup	No	PST
Break	3:00 PM	PSNONTASK - Non Task Taskgroup	No	PST
In	3:15 PM	PSNONTASK - Non Task Taskgroup	No	PST
Out	5:00 PM	PSNONTASK - Non Task Taskgroup	No	PST

Use Reported Time Details page links to perform additional actions such as adjusting reported time and adding comments.

For Punch Time Reporters, the time details grid displays the date, Time Reporting Code, Reported quantity. The Time detail displays the corresponding punch type, punch time, and additional time reporting details for that time detail.

This example illustrates the fields and controls of Approval Line Detail page which displays the Reported Time Line Details and the Time Details for an Elapsed Time reporter.

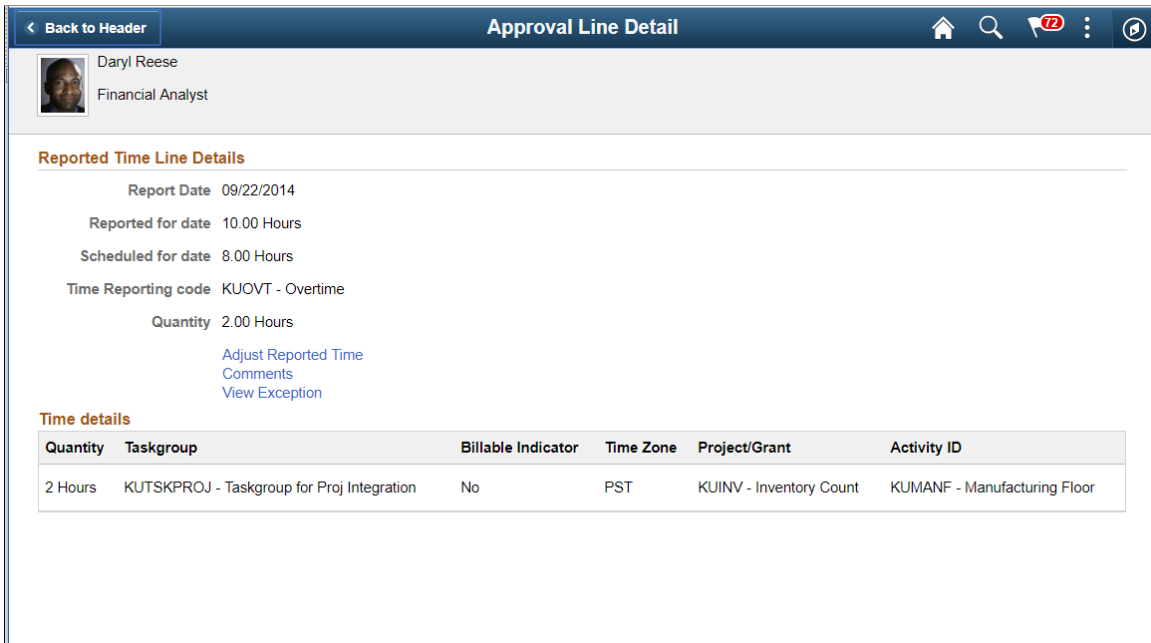

<b>Field or Control</b>	<b>Description</b>
<b>Reported Time Line Details</b>	<p>Displays the details in following section:</p> <ul style="list-style-type: none"> <li>• <b>Report Date:</b> is the date for which time is reported.</li> <li>• <b>Reported for Date:</b> Hours reported for the <b>Report Date</b>.</li> <li>• <b>Scheduled for Date:</b> Scheduled hours for a day.</li> <li>• Time Reporting Code</li> <li>• <b>Quantity:</b> Quantity in hours</li> </ul>
<b>Adjust reported time</b>	<p>Select to adjust reported time using the Fluid Report time page.</p> <p>For more details, refer <a href="#">Report Time Details Page</a></p>
<b>Comments</b>	<p>Select to provide any comments for the day using <a href="#">Approval Line Detail Comments Page</a></p>
<b>Time Details</b>	<p>For an Elapsed Time Reporter, Time details displays the additional reporting time details for the quantity reported.</p>
<b>View Exception</b>	<p>Navigate to <a href="#">View Exceptions Page</a>, if there is an exception reported.</p>



The time details submitted by the user when submitting the reported quantity for Time Reporting Code (summed value) displays under the Time Details Grid. This follows the corresponding punch type and punch time for that time detail.

The Time details grid displays the Taskgroup and other related information along with the split of quantity in hours.

## Approval Chain Page

Use the Approval Chain (EOAWMA\_APPC\_SCF) page to display the approvers and the approval status at each step/stage or path.

Navigation:

Click the Approval Chain item on the Pending Approval\_Reported Time Page .

This example illustrates the approval chain details page.

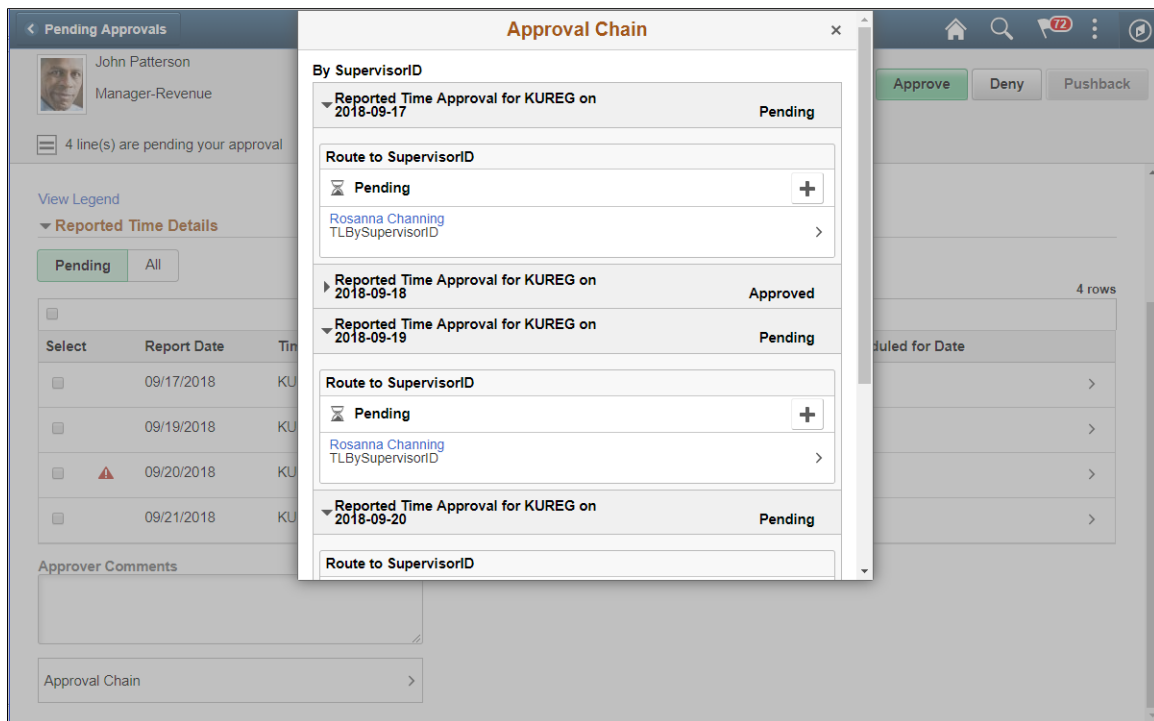

## Approval Line Detail\_Comments Page

Use the Approval Line Detail\_Comments (TL\_TR\_COMMENT\_FLU) page to enter any generic comment for the employee while viewing the Timesheet page.

Navigation:

Click the Comments link on the Approval Line Detail page.

This example illustrates the Approval Line Detail\_Comments page.

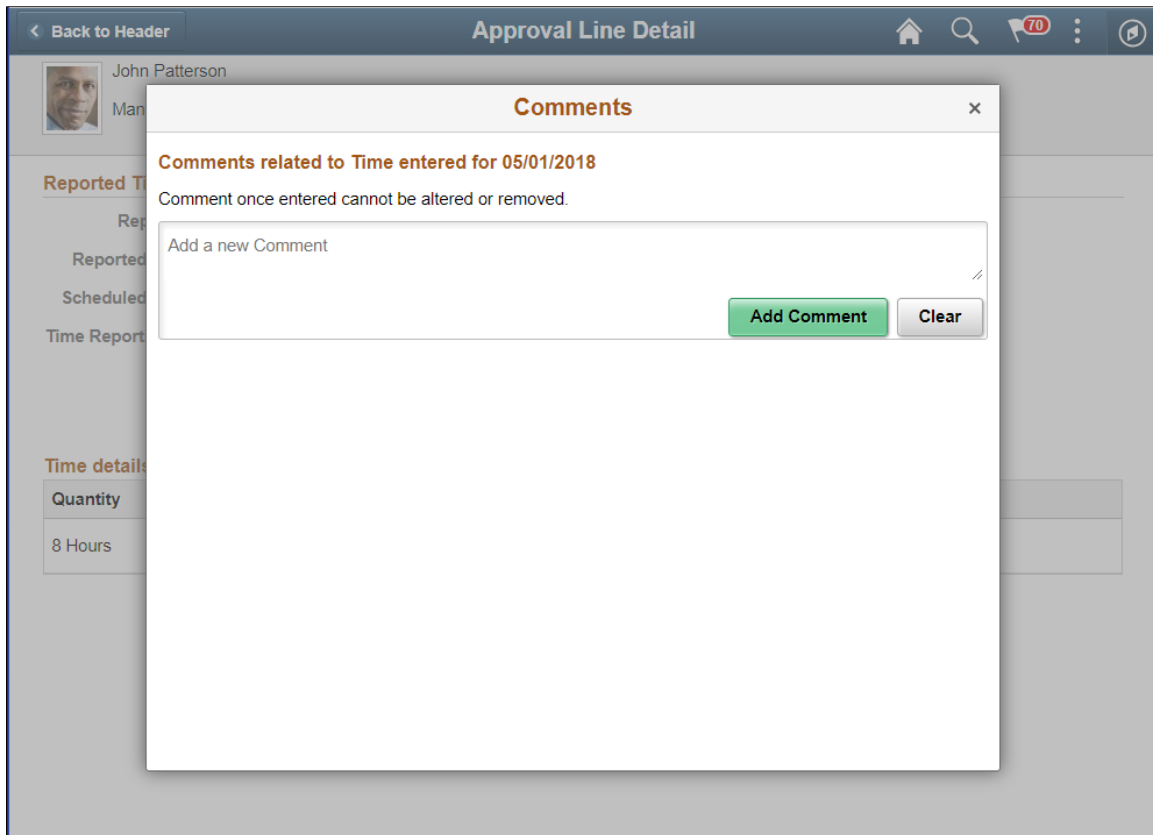

# Using Time and Labor Auto Enrollment Analytics

---

## Using Auto Enrollment Analytics for Managing Previews and Errors

### Understanding the Time and Labor Auto Enrollment Analytics

The Time and Labor Auto Enrollment Analytics enable administrators or managers to quickly analyze the time enrollments and select the transactions that they wish to load to the base tables.

The enrollment process updates the time reporter data for all hires (single or concurrent employment instances), rehires, terminations, job data changes and other configured human resource actions. While Job data changes, it triggers auto enrollments using the auto enrollment framework. You can also use the [Setting Up Auto Enrollment](#) to load Auto Enrollment data for the new hires and existing employees.

Using Time and Labor preview mode of auto enrollment feature, you can preview the enrollment information in the Fluid Interface.

When the preview mode is selected, Auto Enrollment will not post the Time and Labor Enrollments determined by the enrollment rule processing. A staging table gets populated with the enrollment information for review and you can select the transactions that you wish to load to the base tables.







### Auto Enrollment Previews and Error Tabs

The following pagelets are delivered for the Absence Analytics Dashboard.

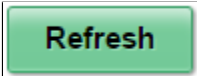
<b>Pagelet</b>	<b>Usage</b>
<a href="#">Time and Labor Auto Enrollment Tile</a>	Tap the Time and Labor Auto Enrollment tile to navigate the Auto Enrollment page. This tile displays the count of number of errors and enrollments that are ready for preview.
<a href="#">Preview Time and Labor Report</a>	Analyze the time and labor enrollment entries which are ready for preview.
<a href="#">Preview Schedule Assignment Report</a>	Analyze the time and labor schedule assignments which are ready for preview..

<b>Pagelet</b>	<b>Usage</b>
<a href="#">Errors Time and Labor Report</a>	Analyze and review the error data and take corrective actions by making use of several detailed actions which are available on the Pivot grid
<a href="#">Errors Schedule Assignment Report</a>	Analyze and review the errors which are encountered during schedule assignments.

## Common Elements Used in this Topic

<b>Field or Control</b>	<b>Description</b>
 Refresh Button	Refresh the Pivot grid reports and details to view the relevant and latest data.
 Option Menu	Use this <b>Options Menu</b> to perform the actions like <b>View Pivot Grid, Update Filters, Export Data, Chart Options, and Save.</b>
 Show Filters	Show filters on the left panel to display the <b>Enrollment Group, Location, Business Unit, Department and Company.</b>
 Hide Filters	Select to hide the filters.
 Detailed Actions	Perform the action of Posting, Mark for Processing or Rejecting enrollments at an employee level (one transaction at a time). The user can view the <b>Enrollment Group</b> and <b>Notify</b> the recipients using different delivery methods.
 Pivot Grid Chart Types	Click to display data in the chart type represented by the icon. Available chart types include vertical bar, line, pie and horizontal bar.
 Actions	Activate and perform the actions related to multiple transactions.

For more information on pivot grid functionality, see the product documentation for *PeopleTools: Pivot Grid*.

## Time and Labor Auto Enrollment Tile

Use Time and Labor Auto Enrollment tile to navigate the Auto Enrollment page. This tile displays the count of number of errors and enrollments that are ready for preview.

This example illustrates Time and Labor Auto Enrollment tile.

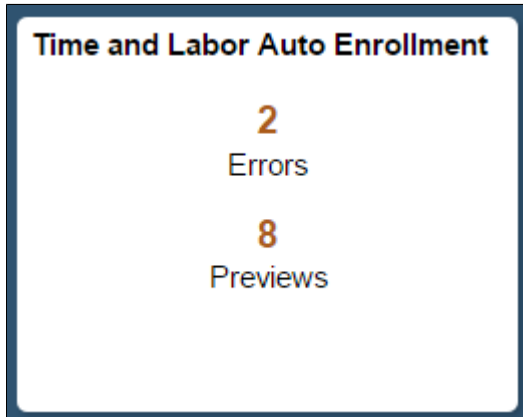

Tap the **Time and Labor Auto Enrollment** page to navigate to **Auto Enrollment** page and navigate to the enrollment data preview and errors tabs and to view the pivot grid reports.

The preview and error reports are:

- Preview Time and Labor
- Preview Schedule Assignment
- Errors Time and Labor
- Errors Schedule Assignment

## Preview Time and Labor Report

The Pivot grid report lists all the employees for whom enrollments are ready for preview in a bar chart. Enrollment Groups are listed on the X-Axis and the count of number of employees matching different Enrollment Group criteria are represented on the Y-Axis. The Pivot grid report shows all employee details in a grid located below the chart.

The Preview Time and Labor Report is the default Auto Enrollment landing page.

Navigation:

Tap the **Preview Time and Labor** tab on the Auto Enrollment Page.

This example illustrates the fields and controls on the Preview Time and Labor page.

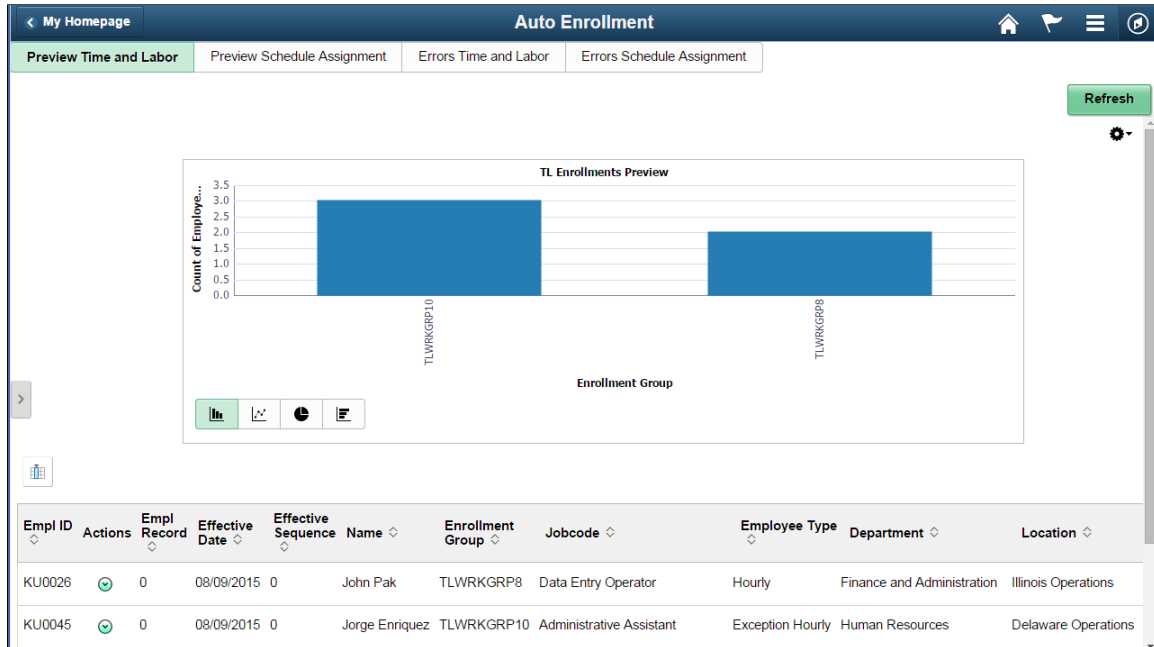

Field or Control	Description
<b>Detailed Actions</b>	Perform the action of Posting, Mark for Processing or Rejecting enrollments at an employee level (one transaction at a time). The user can view the <b>Enrollment Group</b> and <b>Notify</b> the recipients using different delivery methods.

Select anywhere on the chart to drill down the data. By default, you can use the drill down options like **Position, Union Code, Employee Type** and **Job code**.

The Details grid shows the field values - **Employee ID, Employee Record, Effective date, Effective Sequence, Name, Employee Type, Department, Location, Jobcode, Union Code, Position, Business Unit, Company, Supervisor ID, Run Control ID, Process Status** and **Enrollment Group** for which the employee has become eligible.

**Note:** You can perform Detailed Actions only by using Desktop or Tablet. The detailed actions cannot be performed using mobile (Small Form Factor) devices.

This example illustrates the Auto Enrollment Landing page when logged in using mobile devices.



At any point of time, you have access to configure various pivot grid report options and can add any additional Job data fields to the details grid, drill down options or the filter criteria by modifying the underlying PS Query.

### Preview Schedule Assignment Report

The Pivot grid report displays the schedule assignment in a bar chart. **Enrollment Groups** are listed on the x-axis and the count of number of employees matching different **Enrollment Group** criteria are

represented on the y-axis. The Pivot grid report shows all employee details in a grid located below the chart.

Navigation:

Tap the **Preview Schedule Assignment** tab on the Auto Enrollment page.

This example illustrates the fields and controls on the Preview Schedule Assignment page.

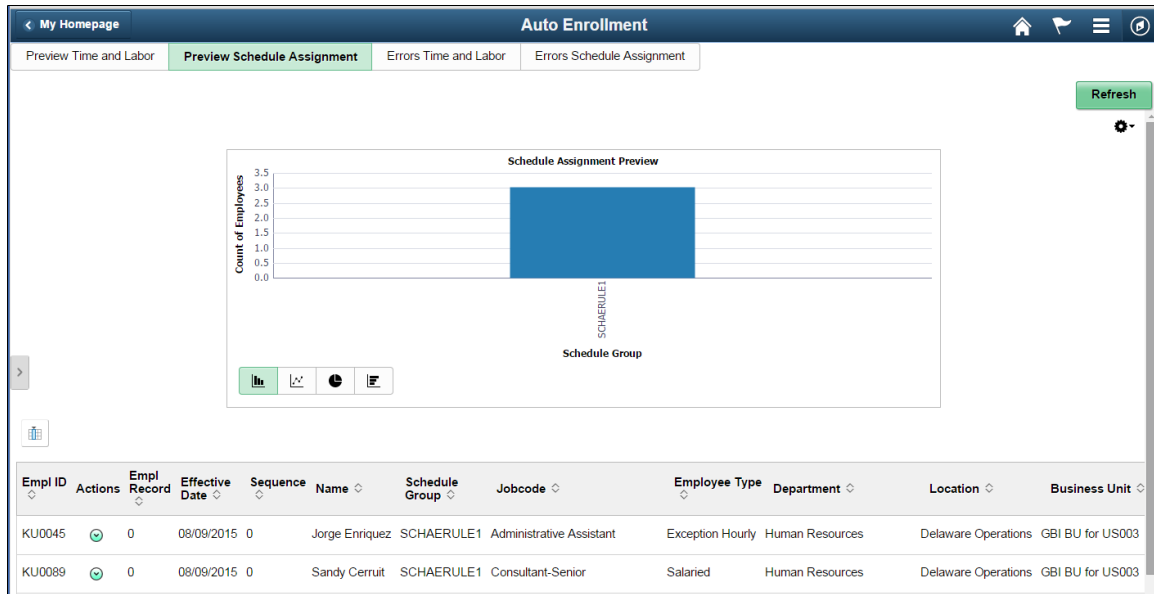

Field or Control	Description
<b>Detailed Actions</b>	Perform the action of Posting, Mark for Processing or Rejecting enrollments at an employee level (one transaction at a time). The user can view the <b>Schedule Group</b> and <b>Notify</b> the recipients using different delivery methods.

Select anywhere on the chart to drill down the data. By default, you can deliver the drill down options **Position, Union Code, Employee Type** and **Job code**.

The Details grid shows the field values - **Employee ID, Employee Record, Effective date, Sequence, Name, Employee Type, Department, Location, Jobcode, Union Code, Position, Business Unit, Company, Supervisor ID, Run Control ID, Process Status** and **Enrollment Group** for which the employee has become eligible.

At any point of time, you have access to configure various Pivot grid report options and can add any additional Job data fields to the details grid, drill down options or the filter criteria by modifying the underlying PS Query.

## Errors Time and Labor Report

The pivot grids which shows the error data encountered by auto enrollment is available under Auto Enrollment Page as a separate tab. This report is for employees who have data changes. The administrator who has access to this page can view the error data and take corrective actions by making use of several detailed actions which are available on the pivot grid.



The errors encountered during batch processing and real time processing are logged to the same error table and the user can use the same pivot grid report for reviewing the errors in either of these cases.

The pivot grid report displays the schedule assignment in a bar chart. **Enrollment Groups** are listed on the x-axis and the count of number of employees matching different **Enrollment Group** criteria are represented on the y-axis. The pivot grid report shows all employee details in a grid located below the chart.

The Auto Enrollment page shows two types of error reports. They are errors for **Time and Labor enrollments** and **Errors for Scheduled Assignment**.

Errors encountered during time reporter data enrollments are classified into following error categories **Job Deletion**, **Not Eligible Eligibility errors**, **Validation Issues** and **Retro Errors**.

The bar chart is depicted with Error Type on the x-axis and employee count on the y-axis. The Pivot grid report shows all employee details in a grid located below the chart.

Navigation:

Tap the **Errors Time and Labor** tab on the Auto Enrollment page.

This example illustrates the fields and controls on the Errors Time and Labor page.

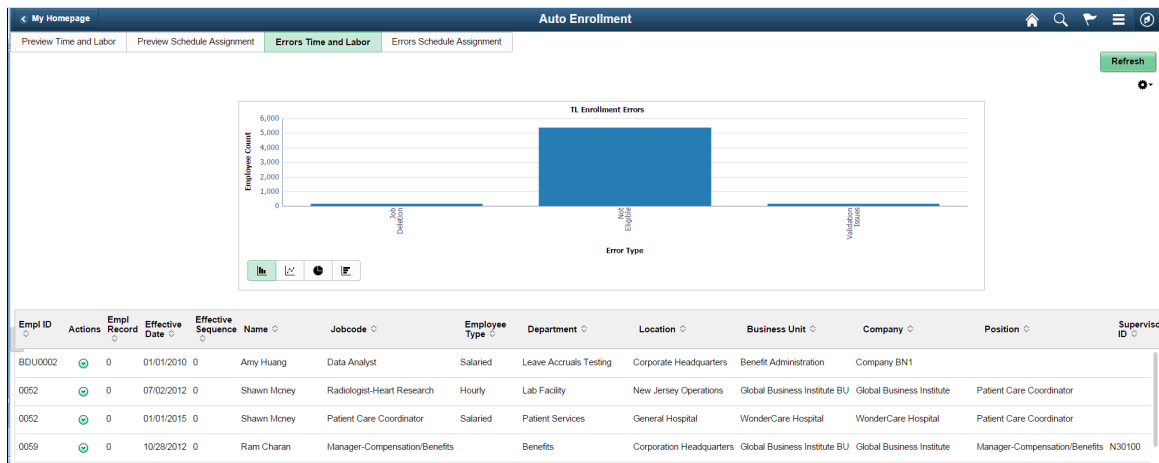

Field or Control	Description
 <b>Related Actions</b>	Preview <b>Error Detail</b> and <b>Job Data</b> as required. The user can view the <b>Enrollment Group</b> and <b>Notify</b> the recipients using different delivery methods.

Select anywhere on the chart to drill down the data. By default, you can deliver the drill down options **Position**, **Union Code**, **Employee Type** and **Job code**.

The Details grid shows the information about the employee for whom error exists and field values for **Employee ID**, **Employee Record**, **Effective date**, **Effective Sequence**, **Name**, **Employee Type**, **Department**, **Location**, **Jobcode**, **Union Code**, **Position**, **Business Unit**, **Company**, **Supervisor ID**, and **Error Type**, and **Error Open Since**.

## Errors Schedule Assignment Report

Errors which are encountered during schedule assignments are classified into the following categories **Eligibility Error**, **Not Eligible**, and **Validation Issues**.

This bar chart is depicted with Error Type on the x-axis and the employee Count on the y-axis.

Navigation:

Tap the **Errors Schedule Assignment** tab on the Auto Enrollment page.

This example illustrates the fields and controls on the Errors Schedule Assignment page.

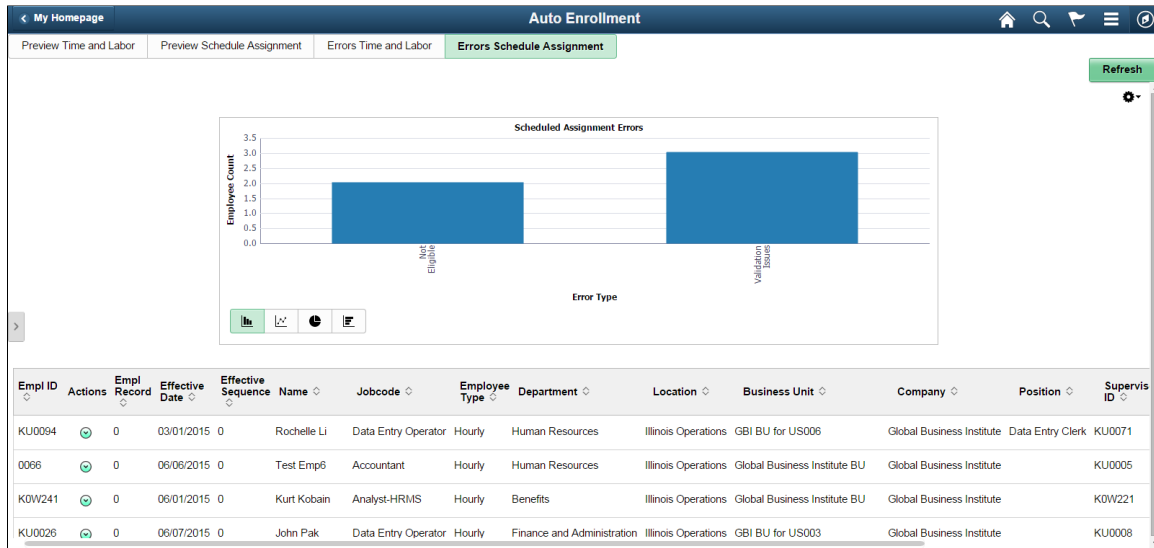

Field or Control	Description
<b>Detailed Actions</b>	Preview <b>Error Detail</b> and <b>Job Data</b> as required. The user can view the <b>Schedule Group</b> and <b>Notify</b> the recipients using different delivery methods.

Select anywhere on the chart to drill down the data. By default, you can use the drill down options **Position**, **Union Code**, **Employee Type** and **Job code**.

**Note:** Schedule assignments are done only at the time of hire or during first time enrollments, and thus Error type of **Retro** and **Job Deletion** are not applicable for Schedule Assignments

The Details grid shows the information about the employee for whom error exists and field values for **Employee ID**, **Employee Record**, **Effective date**, **Effective Sequence**, **Name**, **Employee Type**, **Department**, **Location**, **Jobcode**, **Union Code**, **Position**, **Business Unit**, **Company**, **Supervisor ID**, and **Error Type**, and **Error Open Since**.

# Using Manager Self-Service Components for Time Management and Reporting

---

## Understanding Manager Self-Service Components

The manager self-service components enable managers to review, add, update, and delete (where appropriate) time and labor information *for their direct reports*.

---

**Note:** Managers cannot access their own information using the Manager Self Service component; they use the Employee Self-Service component to report and access their time.

---

See [Understanding Self-Service Components](#).

Manager Self Service components include:

- Time and Labor WorkCenter.

The PeopleSoft Time and Labor WorkCenter enables managers to access various business processes in order to complete day-to-day work and commonly performed tasks

See [Using the Time and Labor WorkCenter](#)

- Time and Labor Launch Pad for managers (TL\_LPAD\_MSS\_PNLG).

Enables managers to view their employee information regarding reported and scheduled time for a month at a time. It also enables them to navigate to other manager self-service transaction pages.

- Manage Schedules (SCH\_MNG\_PERIOD).

Enables managers to adjust a time reporter's schedule.

See [Timesheet Display: Self-Service Versus Manager Self-Service](#).

- Assign Work Schedule (SCH\_ASSIGN).

Enables a manager to assign an employee's work schedule.

- Time Sheet (TL\_MSS\_EE\_SRCH\_PRD).

Enables managers to report or adjust their employee's time and task details for a day, week, or time period for punch and elapsed time. It also allows managers to approve or deny an employee's time.

---

**Note:** Pages of this feature have been replaced by equivalent pages in Fluid. For more information, see [Using PeopleSoft Fluid User Interface for Time Management as a Manager](#).

---

- Approve Payable Time (TL\_SRCH\_APPRV\_GRP).

Enables a manager to approve an employee's payable time.

See [Approving Payable Time](#).

- Mass Time for managers (TL\_MASS\_TIME\_ESS).

Enables managers to report an employee's time in several ways. They can report time according to the employee's schedule for a specified date or date range. They can also specify a lump sum amount to be distributed according to the employee's schedule or specify multiple time transactions, to be applied to each day in the time period.

- Overtime Requests (TL\_OT\_HISTORY\_LIST).

Enables managers to view recent overtime requests and approve or deny them.

- Overtime Request Details (TL\_OT\_RQST\_DTL).

Enables managers to view the details for an overtime request and either approve or deny the request.

- Overtime Balances (TL\_OT\_BALANCES).

Enables managers to view service dates, overtime balances for the current period and year-to-date, and overtime limits for a group of employees.

- Compensatory Time (TL\_COMPTIME\_PNL).

Enables managers to view employee compensatory time balance and compensatory time expiration information.

See [Compensatory Time Page](#).

- Exceptions (TL\_MNG\_EX\_PNL\_GRP3).

Enables managers to view, allow, and clean up exceptions associated with their employee's reported time.

See [Managing Exceptions](#).

- Payable Time Summary (TL\_TM\_MPAY\_SUMM\_PG).

Enables managers to view employee's payable time that has been calculated by the system from a schedule or reported time.

- Payable Time Detail (TL\_MNG\_PAY\_VIEW\_DT).

Enables managers to view details about their employee's payable time.

- Forecasted Time Summary (TL\_TM\_SPAY\_SUMM\_PG).

Enables managers to view a forecasted summary of their employee's payable time for a future or current period. This payable time is calculated based on the employee's schedule or time reported for a specified date.

- Forecasted Time Detail (TL\_MNG\_SPAY\_VIEW\_D).

Enables managers to view details about their employee's forecasted payable time.

- Daily, Weekly or Monthly (Time) Calendar Views (TL\_WV\_DAILY\_CAL, TL\_WV\_WEEKLY\_CAL TL\_WV\_MONTHLY\_CAL).

Enables managers to compare reported time, payable time, and scheduled time for their employees.

- Manager Search Options (TL\_MSS\_SRCH\_OPTION).

Allows a manager to specify the default search criteria and display options that will appear for employee searches, used on the various manager pages.

## Employee Selection Criteria

The **Employee Selection Criteria** grid is a common component that appears on many of the self service pages that managers use in Time and Labor. This component is described in the Using Manager Self Service for Scheduling Components section.

See [Setting Up Manager Search Options](#).

## Roles

The self service components can be used by both the employee and the manager; therefore, we deliver definitions for these roles and define a menu for each role.

---

**Note:** In this section, we use the term *employee* to refer to all people who work for and report time at the organization. This can include regular employees as well as contractors and other temporary assignment workers.

---

## Security

The user profile that you create for each individual who accesses the self-service components determines the internet pages that the user can access by default. Create user profiles by using the User Profiles component (USERMAINT). Assign a role to each user profile, which is linked to access control lists. Each access control list identifies pages that individuals can access. To modify the access for specific internet pages for each role, modify the access control list for the user's role. Define which data the user can access in the user profile.

For the Manager Self Service, Time Management pages that display a list of employees, the following determines which employees the manager has access to:

1. Determine the row security permission list that is assigned to your user ID on the User Profiles - General page.
2. If you use group security in Time and Labor, this row security permission list should be associated with dynamic and static groups that you have created.
3. If you decide not to use group security and do not have groups assigned to your row security permission list, the default is the use of departmental security.

Departmental security is derived by determining the department ID and then investigating who you have access to in the department, as well as the departments that are set up as children nodes on the departmental security tree.

- If you do use group security within Time and Labor, make sure the dynamic groups are refreshed to the date that you need, to have the most up-to-date inclusion of employees in the list.

For all pages that you use to access time reporter information in the Time and Labor system, we derive the view of time reporters based on the criteria above.

See the product documentation for *Understanding Manager Self-Service Components*.

## Navigating in Time and Labor Self-Service Pages for Managers

There are several ways to access self-service transactions:

- The Time Management page (for managers).
- Standard menu path navigation.

### Time Management Page

This page includes links to all Time and Labor self-service transactions that pertain to the manager. The user can also click a link to return to the Manager Self Service page.

This example illustrates the fields and controls on the Time Management page. You can find definitions for the fields and controls later on this page.

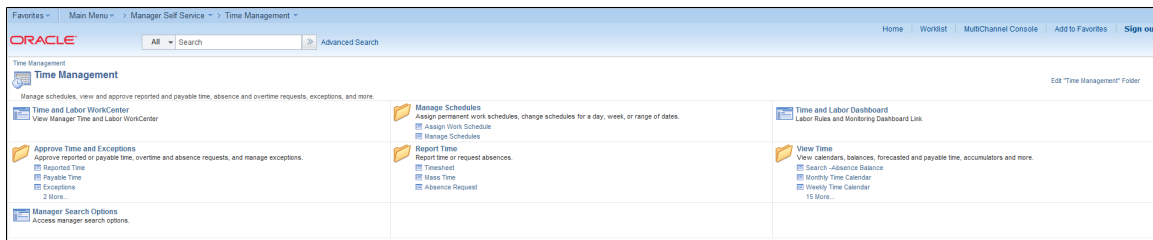

### Standard Menu Navigation

The standard menu-driven navigation is the traditional PeopleSoft access method.

This example illustrates the fields and controls on the Manager Self Service navigation. You can find definitions for the fields and controls later on this page.

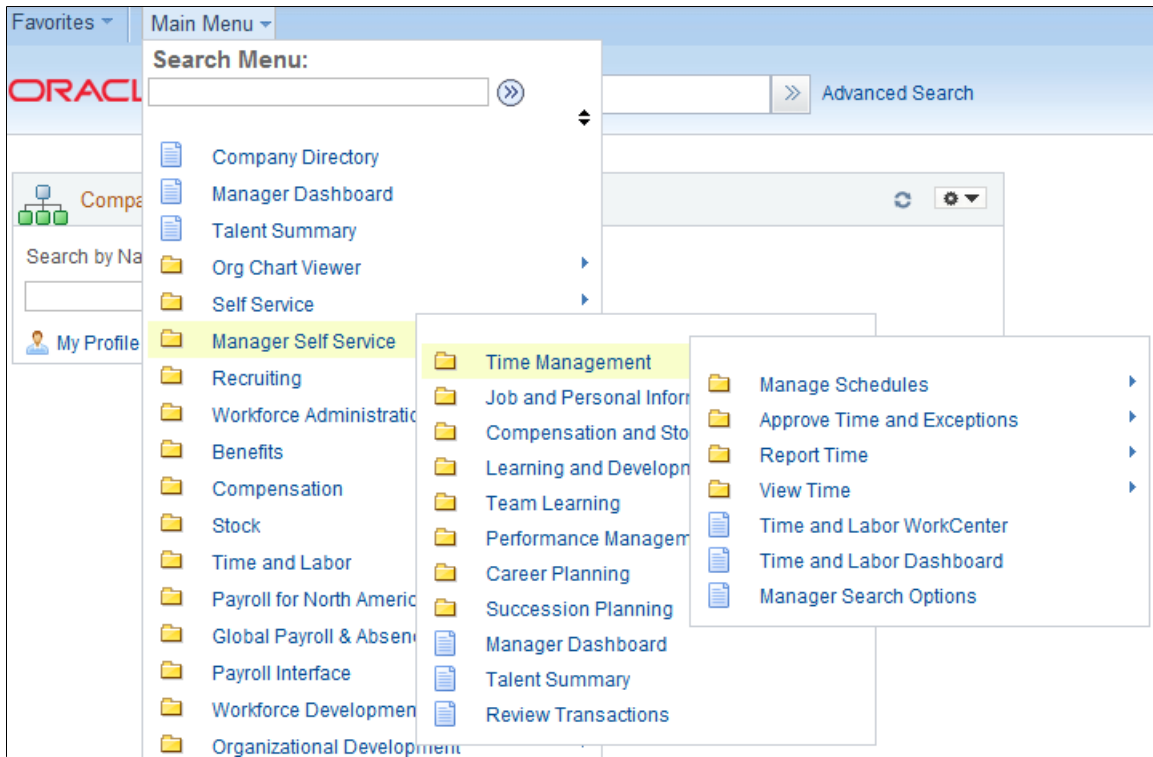

## Using Time and Labor Launch Pad Pages for Managers

This section discusses how to use the Time and Labor Launch Pad pages for Managers.

## Pages Used to Specify Time and Labor Launch Pad Information for Managers

<i>Page Name</i>	<i>Definition Name</i>	<i>Usage</i>
<u>Time and Labor Launch Pad</u>	TL_LAUNCH_PAD	<p>View which days in the specified month have payable time, forecasted payable time, reported elapsed time, reported punch time, exceptions, and recommended actions associated with each exception.</p> <p>You can change the calendar view to display the actual number of payable hours, forecasted payable hours, reported elapsed hours, reported punch hours, or scheduled hours that have been reported for each day.</p> <p>You can also click a link to review, by day, the details of the reported, payable, forecasted time, exceptions and recommended actions for the employee.</p>
<u>Application Items Page</u>	TL_APP_ITEM_PNL	Specify the items that are available within an application suite.
<u>Application Suites Page</u>	TL_APP_SUITE_PNL	Set up the application items that are available to both managers and time reporters using the <b>Go</b> field on the Time and Labor Launch Pad page.

### Time and Labor Launch Pad

Use the Time and Labor Launch Pad page (TL\_LAUNCH\_PAD) to view which days in the specified month have payable time, forecasted payable time, reported elapsed time, reported punch time, exceptions, and recommended actions associated with each exception.

You can change the calendar view to display the actual number of payable hours, forecasted payable hours, reported elapsed hours, reported punch hours, or scheduled hours that have been reported for each day. You can also click a link to review, by day, the details of the reported, payable, forecasted time, exceptions and recommended actions for the employee.

Navigation:

**Manager Self Service > Time Management > View Time > Time and Labor Launch Pad** Enter values in the **Employee Selection Criteria** grid and select the **Get Employees** button to return a list of employees. Then select the employee name link on the Time and Labor Launch Pad - Select Employee page.

See [Setting Up Manager Search Options](#).



This example illustrates the fields and controls on the Time and Labor Launch Pad page (1 of 2). You can find definitions for the fields and controls later on this page.

### Time and Labor Launch Pad

Alvina Cook  
Analyst-Budget II

Employee ID K0W233  
Empl Record 0

\*Month

Selection In View    Reported Hours    Previous Month    Next Month

Sunday	Monday	Tuesday	Wednesday	Thursday	Friday	Saturday
	1	2	3	4 Independen	5	6
7	8	9	10	11	12	13
14	15	16	17	18	19	20
21	22	23	24	25	26	27
28	29	30	31			

This example illustrates the fields and controls on the Time and Labor Launch Pad page (2 of 2). You can find definitions for the fields and controls later on this page.

Links

[Return to Select Employee](#)

[Manager Self Service](#)

[Time Management](#)

[Return to Overtime Request list page](#)

**Legend**

- X Exception
- P Reported Punched Time
- E Reported Elapsed Time
- \$ Payable Time
- F Forecasted Payable Time
- R Recommended Attendance Actions

When you first enter the Launch Pad page, the current month and year are displayed by default.

<b>Field or Control</b>	<b>Description</b>
<b>View</b>	<p>Select the information that you want to appear—the employee's actual number of forecasted payable hours, exceptions, payable hours, reported elapsed hours, or scheduled hours for each day in the specified month—and click this button.</p> <p>The calendar view changes depending on what you select. For example, suppose that you select the <i>Scheduled Hours</i> view option and 8.00 appears for one of the days in the calendar. This means that the employee is scheduled to work eight hours that day.</p>

At any given time, any day in the calendar may display the following values: *X*, *P*, *E*, *\$*, *F*, or *R*. These values indicate that there is information about reported time for that day. For example, suppose *E* appears for one day on the calendar. This means that the employee has elapsed time reported for that day. If *\$* appears, it means that payable time exists for that day. See the bottom of the Launch Pad page for a description of each of the values. If any of the days are highlighted or linked, that indicates that the day has elapsed time, punch time, payable time, exceptions or recommended attendance actions associated with that day. Click the day to view the time reporting details that exist for that day.

<b>Field or Control</b>	<b>Description</b>
<b>Forecast Payable Time</b>	<p>Start the Forecasted Payable Time process that calculates forecasted payable time for the employee by clicking this button.</p> <p>The system looks at the employee's schedule and any time they have reported for this month. It then forecasts what the payable time would be for those days and displays an <i>F</i> on the day. The forecasted time is not actually payable time, but an estimate of what the payable time would look like. To view the number of forecasted hours for that day, change the view at the top of the page to <i>Forecasted Payable Hours</i> and click the <b>View</b> button. To view the details of the forecasted time, click the link for the day that you want to view.</p>
<b>Previous Month and Next Month</b>	Use these buttons to skip to the preceding or next month.

Finally, if you want to navigate to a different part of the system to perform other transactions or just to get more information, use the **Links** field at the bottom of the page. Select the application item that you want to navigate to from the drop-down list, click the **Go** button, and navigate to the feature that you selected. Depending on how the application suites are set up, different options are available for the **Links** field.

## Application Suites Page

Use the Application Suites page (TL\_APP\_SUITE\_PNL) to set up the application items that are available to both managers and time reporters using the **Go** field on the Time and Labor Launch Pad page.

Navigation:

**Set Up HCM > Product Related > Time and Labor > Launch Pad Navigation Suites > TL Applications Suites**

This example illustrates the fields and controls on the Application Suites page. You can find definitions for the fields and controls later on this page.

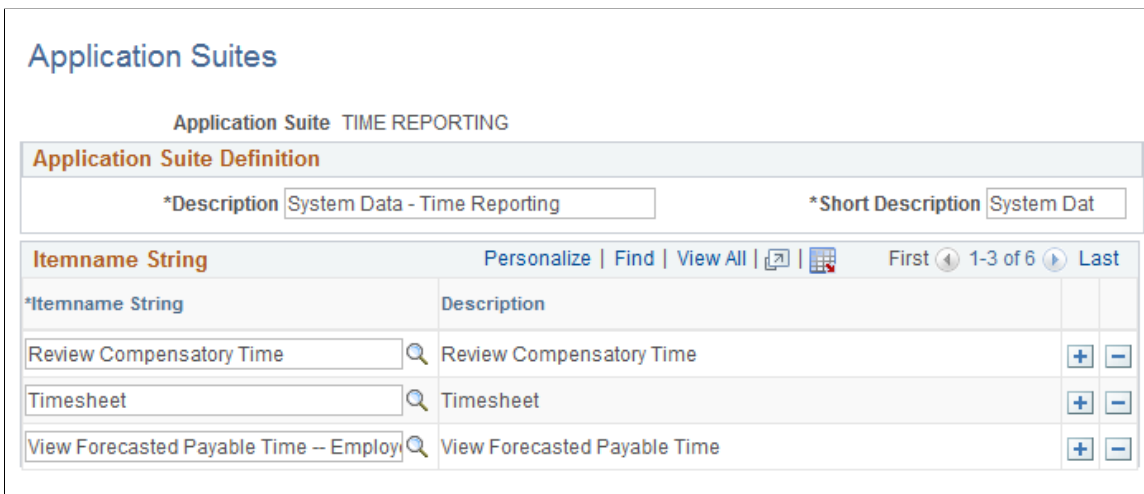

There are two application suites that apply to the Self-Service components: the Time Management Application Suite and the Time Reporting Application Suite. The Time Management Application Suite is used to set up the **Links** field on the Time and Labor Launch Pad page for managers. Likewise, the Time Reporting Application Suite is used to set up the **Links** field on the Time and Labor Launch Pad page for employees. Both suites are delivered with the system. For each one you set up, specify which application items the users (managers or employees) can access via the **Links** field on the Time and Labor Launch Pad page.

---

**Note:** Only the items for which the user has Permission List access are available in the **Links** drop-down list box. For example, the Time Management Application Suite may have access to Adjust Payable Time, but the user may not. In that case, Adjust Payable Time would not be available to that specific user in the **Links** drop-down list box.

---

**Related Links**

[Adjusting Time](#)

**Application Items Page**

Use the Application Items page (TL\_APP\_ITEM\_PNL) to specify the items that are available within an application suite.

Navigation:

**Set Up HCM > Product Related > Time and Labor > Launch Pad Navigation Suites > TL Application Items**

This example illustrates the fields and controls on the Application Items page. You can find definitions for the fields and controls later on this page.

### Application Items

**Itemname String** Manager Timesheet

**Application Item Definition**

\*Description

**Menu Name**

\*Menu Name

\*Menu Bar Name

\*Item Name

\*Panel Item Name

<i>Field or Control</i>	<i>Description</i>
<b>Save</b>	Click the <b>Save</b> button for the application items to appear in the Go function's drop-down list box on the Time and Labor Launch Pad page.

## Application Items for Managers

Eighteen application items are available to managers through the Time Management application suite:

### Application Items Descriptions

<i>Item name String</i>	<i>Description</i>
Adjust Paid Time	Select to make record-only adjustments to employee time that was already paid or closed. The changes that you make aren't processed through payroll again, but are for record keeping purposes only.
Approve Absence Requests	Select to approve the employee's absence requests.
Approve Overtime Requests	Select to approve employee requests to work overtime.
Approve Payable Time	Select to approve the employee's time for payroll.

<b><i>Item name String</i></b>	<b><i>Description</i></b>
Approve Training	Select to approve training for employees.
Manage Exceptions	Select to view and allow an employee's exceptions.
Manage Schedules - Manager	Select to override an employee's schedule.
Manager Timesheet	Select to view, report, change, or approve an employee's reported time.
Review Compensatory Time	Select to view an employee's compensatory time.
Review Scheduled Assignments	Select to review an employee's scheduled assignments.
Timesheet	Select for an employee to view, report, or change their reported time.
View Forecasted Payable Time - Employee	Select for an employee to view their forecasted payable time.
View Forecasted Payable Time – Manager	Select to view, report, or change the employee's forecasted payable time.
View Payable Time (Detail) - Employee	Select for an employee to view their payable time details.
View Payable Time (Detail) - Manager	Select to view, report, or change an employee's payable time details.
View Payable Time (Summary) - Employee	Select for an employee to view a summary of their payable time.
View Payable Time (Summary) - Manager	Select to view, report, or change a summary of an employee's payable time details.
View Schedule - Employee	Select for an employee to view their monthly schedule.

---

## Reporting Time

This section lists common elements and discusses how to assess employees' time at a summary level, enter, view, or change employee's time, use mass time, and select employees for mass time.

## Pages Used to Report Time

<b>Page Name</b>	<b>Definition Name</b>	<b>Usage</b>
<u>Report Time - Timesheet Summary Page</u>	TL_MSS_TIMESHEET	You can view all employees' time whether they need approval or not.  To approve an employee's time, you need to either display the employee's timesheet or navigate using the Approve Reported Time link.
<u>Timesheet Page</u>	TL_RPTD_PCH TL_RPTD_ELP	Report time and task details for a day, week, or time period for either punch or elapsed time reporters.
<u>Mass Time - Select Time Reporters Page</u>	TL_MASS_WHO	Managers select employees for mass time reporting.

## Common Elements Used in this Section

<b>Field or Control</b>	<b>Description</b>
<b>Time Reporting Elements and Task Reporting Elements</b>	<p>The self-service pages that <i>employees</i> use to report time include fields for selecting time reporting and task reporting elements. The employee's time reporting and task reporting templates determine which fields are displayed. If data is reported in error for invalid time or task elements (through a TCD, Mass Time, or Rapid Time Reporting pages, for example), those time reporting or task fields are also displayed so that employees can make corrections.</p> <p>The self-service pages that <i>managers</i> use to report an employee's time include fields for all time reporting elements, regardless of the employee's time reporting template. The task fields vary, depending on the employee's time reporting template: if the Task Profile option is selected on the template, the self-service pages display a task profile field; if the Task Template option is selected on the template, the self-service pages display the task fields for the task template assigned to the employee's taskgroup. If data is reported in error for invalid time task elements (through a TCD, Mass Time Reporting, or Rapid Time Reporting pages, for example), those fields are displayed on the self-service pages so that managers can make corrections.</p>

<b>Field or Control</b>	<b>Description</b>
<b>Timesheet page</b>	Both punch time and elapsed time are reported using the Timesheet navigation component. When selected through the Manager Self Service component, the Report Time - Select Employee page displays a list of the manager's employees. By clicking the employee name link, the manager can select the employee for whom to report time. The Timesheet page that appears is based on the Time Reporter Type value selected on the Create or Maintain Time Reporter Data pages, which determine whether punch or elapsed information is displayed.

## Report Time - Timesheet Summary Page

Use the Report Time - Timesheet Summary page (TL\_MSS\_TIMESHEET) to you view all employees' time whether they need approval or not.

Navigation:

**Manager Self Service > Time Management > Report Time > Timesheet > Report Time - Timesheet Summary**

This example illustrates the fields and controls on the Report Time—Timesheet Summary. You can find definitions for the fields and controls later on this page.

The screenshot displays the 'Report Time - Timesheet Summary' page. At the top, there is a navigation bar with 'Employee Selection' and 'Change View' options. Below this, a filter section includes a '\*View By' dropdown set to 'Week', a 'Date' field set to '01/01/2007', and a 'Show Schedule Information' checkbox which is checked. There are also buttons for 'Previous Week' and 'Next Week'. A 'Load More Entries' button and a 'Load All' button are present, with a status indicator showing '300 of 1558 entries loaded'. The main content area shows a table titled 'Employees For Betty Locherty, Totals From 01/01/2007 - 01/07/2007'. The table has columns for 'Last Name', 'First Name', 'Employee ID', 'Empl Record', 'Reported Hours', 'Hours to be Approved', 'Scheduled Hours', 'Exception', 'Reported Absence', 'Hours Approved or Submitted', and 'Denied Hours'. The table lists 20 employees with their respective data points.

Last Name	First Name	Employee ID	Empl Record	Reported Hours	Hours to be Approved	Scheduled Hours	Exception	Reported Absence	Hours Approved or Submitted	Denied Hours
Abhiram	Babloo	MOVT0322	0	0.00	0.00	40.00			0.00	0.00
Abrahams	Adam	MRT0002	0	0.00	0.00	40.02			0.00	0.00
Absence1	Mark	MABS1	0	0.00	0.00	40.00			0.00	0.00
Ada	Aline	KFLD01	0	0.00	0.00	40.00			0.00	0.00
Ada	Jean	KFLE01	0	0.00	0.00	40.00			0.00	0.00
Adams	Paul	MOVT0345	0	0.00	0.00	40.00			0.00	0.00
Adams	Peter	MOVT0325	0	0.00	0.00	40.00			0.00	0.00
Aditya	Kuruganti	MAD0179	0	0.00	0.00	40.00			0.00	0.00
Adler	Grace	MUTR076	0	0.00	0.00	40.00			0.00	0.00
Agar	Mary	KA3001	0	0.00	0.00	40.00			0.00	0.00
Agarwal	Rahul	MPI0233	0	0.00	0.00	40.00			0.00	0.00
Agnew	Aline	KFLD02	0	0.00	0.00	40.00			0.00	0.00
Agnew	Jean	KFLE02	0	0.00	0.00	40.00			0.00	0.00
Agresta	Alice	GXEEAM2TL57	0	0.00	0.00	35.00			0.00	0.00
Agresta	Dona	GXEEAM2TL55	0	0.00	0.00	40.00			0.00	0.00

**Note:** The previous screenshot does not display the all of the fields on the page. Scroll to the right to view the entire page on your system.

The Report Time—Timesheet Summary page is the initial interface for managers to approve or deny time for their employees. This page provides managers with the following functionality:

- Summary information about their employee's reported hours, based on the date range specified.
- Summary totals for each employee indicating hours needing approval, total reported hours, total scheduled hours, hours that have already been approved, and hours that have been denied.
- Summary totals of time reported to TRC Categories defined by the customer.
- Details of time that has been submitted by the employee versus time that is still in a saved, not submitted, status.
- Access to approve or deny time for an individual or group of employees.
- Access an employee's timesheet where a manager can view or edit details about the time reported.
- Ability to scroll from one day or week to the next to review if there are employees needing time approved.
- Ability to filter on employees with exceptions.
- Employee details such as Job Description, Department, Workgroup, or other fields specified on the manager search options page.
- Ability to navigate quickly to and from the Report Time – Timesheet Summary page.
- An icon is displayed in the **Reported Absence** column if absence data exists for an employee within the date range that you specify on the Timesheet Summary page.

Managers cannot approve absence events using the Approve Reported Time Summary page. Managers must access the employee's detailed timesheet to approve an absence event.

See [Approve Reported Time - Timesheet Summary Page](#).

The Report Time – Timesheet Summary page includes these fields:

<b>Field or Control</b>	<b>Description</b>
Employee Selection Criteria	An expandable/collapsible group box used to select a group or individual employee for approval. This group box also includes the Get Employees button. The fields displayed here are a result of the <b>Include In Criteria</b> selected on the Manager Search Options. If the Manager Search Options are blank, then the default display is derived from the 'Manager Search Defaults' on the Time and Labor Installation page.  See <a href="#">Setting Up Manager Search Options</a> .



<b>Field or Control</b>	<b>Description</b>
View By	<p>This field determines how much reported time you see in the summary list. The page refreshes each time you select an option. The options are: Day, Week, All Time Before to or All Time After.</p> <p><i>Day:</i> Select to display any reported time with a status of <i>Needs Approval</i> or <i>Denied</i> for the day specified.</p> <p><i>Week:</i> (The default). Select to display any reported time with a status of <i>Needs Approval</i> or <i>Denied</i> for the week specified. This field looks at what the user has specified on their User Preferences for the <i>Start Day of the Week</i> field. If the user has specified <i>Monday</i> as their start day of week, then the results list begins each week with a <i>Monday</i> date. For example, if the user enters a date of 03/01/04 (Tuesday) in the Date field and clicks on the refresh button, the system displays a date range of 02/28/04 (Monday) through 03/06/04 (Sunday).</p>
Date	<p>The default is today's date when you first access this page. If the <b>View By</b> option is <i>Week</i>, the system will check the User Preferences for the "Start Day of Week" specified and display the week accordingly. If the <b>View By</b> option is <i>All Time Before</i> or <i>All Time After</i>, the system looks at the date that has been entered and returns a list of employees who have time needing approval prior to or in the future of that date.</p>
Refresh button	<p>Select to refresh the page and employee list after the user changes a date.</p>
Grid Title Bar	<p>This group box title includes manager's name and the date range being viewed.</p>

<b>Field or Control</b>	<b>Description</b>
Grid columns	<p>The columns: <i>Select</i>, <i>Name</i>, <i>Reported Hours</i>, <i>Hours To Be Approved</i>, <i>Scheduled Hours</i>, <i>Exception</i>, <i>Approve/Submitted Hours</i> and <i>Denied Hours</i> are static. All of these columns will be displayed when using the view by <i>Day</i> or <i>Week</i> options.</p> <p>Users can configure up to three TRC Category columns to be displayed along with Employee Selection Criteria fields that are selected as <i>Include in List</i>.</p> <p>They include:</p> <p><i>Select</i> – Check this box to select a time reporter for approval or denial.</p> <p><i>Name</i> – Click on the individual time reporter's link to be taken to the timesheet.</p> <p><i>Reported Hours</i> – Displays the total number of hours reported.</p> <p><i>Hours To Be Approved</i> – Total hours needing approval.</p> <p><i>Scheduled Hours</i> – Displays the total number of scheduled hours.</p> <p><i>Exception</i> – Displays an icon indicating that an exception(s) exist.</p> <p><i>Approve/Submitted Hours</i> – Displays the total number of approved or submitted hours.</p> <p><i>Denied Hours</i> – Displays the total number of denied hours.</p>

## Related Links

[Approving Reported Time](#)

## Timesheet Page

Use the Timesheet page ( TL\_RPTD\_PCH ) to report time and task details for a day, week, or time period for either punch or elapsed time reporters.

Navigation:

**Click the employee name link on the Report Time – Timesheet Summary page.**

This example illustrates the fields and controls on the Timesheet page. You can find definitions for the fields and controls later on this page.

**Timesheet**

**Felix Pham** Employee ID MPC006\_MJ  
Empl Record 1  
Earliest Change Date 01/01/2007

Bartender

Select Another Timesheet

\*View By Week Previous Week Next Week

\*Date 01/01/2007 Previous Employee Next Employee

Scheduled Hours 80.00 Elapsed Timesheet

Reported Hours 0.00

Show All Punch Columns

From 01/01/2007 to 01/07/2007 ?

Comments	Day	Date	Reported Status	Howdy Work	Coffee	At My Desk	Meal Time	At My Desk	Good-Bye	Punch Total	Time Reporting Code
☞	Mon	1/1	New								
☞	Tue	1/2	New								
☞	Wed	1/3	New								
☞	Thu	1/4	New								
☞	Fri	1/5	New								
☞	Sat	1/6	New								
☞	Sun	1/7	New								

Save for Later Submit Clear Apply Rules Apply Schedule

Summary | Absence | Exceptions | Payable Time | Attendance

Reported Time Summary Personalize | Find | 1-4 of 4

Category	Total	Mon 1/1	Tue 1/2	Wed 1/3	Thu 1/4	Fri 1/5	Sat 1/6	Sun 1/7
Total Reported Hours								
Total Scheduled Hours	80.00		8.00	8.00	8.00	8.00	24.00	24.00
Schedule Deviation	80.00		8.00	8.00	8.00	8.00	24.00	24.00
No category Displayed								

<b>Field or Control</b>	<b>Description</b>
Apply Rules	<p>Click this button to launch an online process that immediately applies rules to the reported time. If the rules are applied successfully, the Payable Time is displayed in the Payable Time grid, and the payable time status is set to <i>Approved</i> or <i>Needs Approval</i>. If exceptions are created, they are displayed in the Exceptions grid.</p> <hr/> <p><b>Note:</b> This button is displayed if the <i>Run from Apply Rules Button</i> option is enabled in the <b>Real Time Rules</b> field on the Time and Labor Installation page during implementation. See: <a href="#">Setting Up System Defaults and Loading Dates</a></p>
Clear	<p>Click this button to remove entries from the grid that have not been saved or submitted. This button only appears on Punch timesheets.</p>

<b>Field or Control</b>	<b>Description</b>
Apply Schedule	<p>Select to load the employee's time entries for the specified period in the grid on this page. The system uses the employee's work schedule to populate the grid.</p> <p>If the employee has any submitted or saved entries in this time period, then this function is not available, and the <b>Apply Schedule</b> button is not displayed on the page. This prevents conflicts between entries already on the timesheet and entries that might be applied from the employee's schedule.</p> <p>The only exceptions to the rules for disabling this function and the <b>Apply Schedule</b> button are:</p> <ul style="list-style-type: none"> <li>• An Out punch, that is earlier than the scheduled In punch, from the previous period for a cross over shift is displayed in the current period.</li> <li>• Any absences are reported.</li> </ul> <hr/> <p><b>Note:</b> Based on the configuration of the time reporting template, this button may not be available. See: <a href="#">Creating Time Reporting Templates</a></p> <hr/>

### Related Links

[Timesheet Display: Self-Service Versus Manager Self-Service](#)

## Mass Time - Select Time Reporters Page

Use the Mass Time - Select Time Reporters page (TL\_MASS\_WHO) to select employees for mass time reporting.

Navigation:

**Manager Self Service > Time Management > Report Time > Mass Time > Mass Time - Select Time Reporters**

This example illustrates the fields and controls on the Mass Time – Select Time Reporters. You can find definitions for the fields and controls later on this page.

Mass Time

## Select Time Reporters

Employee Selection

Select All      Deselect All      [Next](#)

Select Time Reporters ?      Personalize | Find | View All | [2]      First ▼ 1-13 of 13 ▲ Last

Time Reporters    Demographics [...]

Select	Last Name	First Name	Employee ID	Empl Record
<input type="checkbox"/>	Pham	Benny	MPC005_S	0
<input type="checkbox"/>	Pham	Bloo	MPC003_MJ	0
<input type="checkbox"/>	Pham	Bloo	MPC003_MJ	1
<input type="checkbox"/>	Pham	Bloo	MPC003_MJ	2
<input type="checkbox"/>	Pham	Felix	MPC006_MJ	0
<input type="checkbox"/>	Pham	Felix	MPC006_MJ	1
<input type="checkbox"/>	Pham	Ginger	MPC001_S	0
<input type="checkbox"/>	Pham	Marshall	MPC010_S	0
<input type="checkbox"/>	Pham	Millie	MPC002_S	0
<input type="checkbox"/>	Pham	Prince	MPC004_S	0
<input type="checkbox"/>	Pham	Rusty	MPC007_S	0
<input type="checkbox"/>	Pham	Trixie	MPC009_S	0
<input type="checkbox"/>	Pham	Winnie	MPC008_S	0

The Mass Time Reporting feature enables a manager to report time in several different ways for their employees by using a template type format. The user is asked a series of questions about who they want to report time for, when they want to report the time for, and how they want to report that time. Depending on how the user answers the questions, the system generates time for a specific person or group and for either a specific date or a range of dates.

Managers use Mass Time Reporting to save time and keystrokes when reporting time. It enables the manager to easily report time using an employee's schedule, or to report different attributes of time for a period rather than having to enter them in manually for each day in the specified period.

Managers can use this page to report time for an employee or a group of employees using Time and Labor's Group Security. To report time for more than one person at the same time, the selected employees must share some of the same time reporting attributes. For example, suppose that you are reporting time for a group of employees using a specific time reporting code (TRC), that time reporting code must exist in the TRC programs to which the employees are assigned. Otherwise, the system generates an exception to indicate that the reported TRC is not in the specified employee's TRC program.

---

**Note:** To use Mass Time Reporting, the time reporter must be assigned to a schedule.

---

<i>Field or Control</i>	<i>Description</i>
<b>Select All</b>	Select the employees for whom you want to report time by selecting the check box beside their names once the list appears. You can also click the <b>Select All</b> button to indicate that you want to report time for all of the employees on the list.
<b>Next</b>	After selecting which employees you want to report time for, click this button to go to the next segment of the page, the Mass Time - Select Time Reporting Method page, when you finish selecting the employees.

Information on the Mass Time Reporting pages is included in the Using Self-Service Components section.

---

## Managing Time

This section discusses how to manage time.

### Pages Used to Manage Time

<i>Page Name</i>	<i>Definition Name</i>	<i>Usage</i>
<u>Payable Time Summary Page</u>	TL_TM_MPAY_SUMM	View an employee's week-by-week summary of payable time by time reporting code using this display-only page.
<u>Payable Time Detail Page</u>	TL_MNG_PAY_DET_VW	View the details of an employee's payable time. If an employee has reported time and the Time Administration process runs, it is possible that the system still doesn't create payable time. If the system creates exceptions, then it depends on the priority of the exception. Low and medium severity exceptions enable the system to create payable time; however, high severity exceptions do not.
<u>Forecasted Time Summary Page</u>	TL_TMSPAY_SUMM	View the week-by-week summary of an employee's forecasted payable time by time reporting code using this display-only page.
Forecasted Time Detail Page	TL_MNG_SPAY_DET_PN	View an employee's forecasted payable time details.

<b>Page Name</b>	<b>Definition Name</b>	<b>Usage</b>
<a href="#">Compensatory Time - Select Employee Page</a>	TL_MSS_COMP_SRCH	Search for employees where you want to view compensatory time balance and expiration information.
<a href="#">Compensatory Time Page</a>	TL_COMPTIME_PNL	View compensatory time balance and expiration information.
<a href="#">Leave and Compensatory Time Page</a>	TL_LEAV_COMP	View all of the employee's leave details for the selected period.
<a href="#">Leave and Compensatory Time Detail Page</a>	TL_LEAVCOMP_DTL	View employee-specific leave details.
<a href="#">Accumulators Page</a>	TL_ALL_ACCUMULATOR	View time reporter accumulator totals by TRC.

## Payable Time Summary Page

Use the Payable Time Summary page (TL\_TM\_MPAY\_SUMM) to view an employee's week-by-week summary of payable time by time reporting code using this display-only page.

Navigation:

**Manager Self Service > Time Management > View Time > Payable Time Summary > Payable Time Summary.** Enter employee selection criteria and click the employee **Last Name** link.

This example illustrates the fields and controls on the Payable Time Summary page. You can find definitions for the fields and controls later on this page.

**Payable Time Summary**

[Millie Pham](#) Employee ID: MPC002\_S  
 Job Title: ST - Filing Clerk Empl Record: 0

Start Date:  [Previous Week](#) [Next Week](#)  
 End Date:  [Previous Employee](#) [Next Employee](#)

Payable Time From 01/01/2007 To 01/07/2007

Time Reporting Code	Description	Total Quantity	Type	Mon 1/1	Tue 1/2	Wed 1/3	Thu 1/4	Fri 1/5	Sat 1/6	Sun 1/7	Currency
MAMRG	Regular Salary	40.00	Hours	8.00	8.00	8.00	8.00	8.00			
MHOLL	Holiday	8.00	Hours	8.00							

The Payable Time Summary page displays one week's payable time. The time is allocated by date, then by TRC, and then by task. For example, suppose an employee's task profile specifies that time should be allocated 50 percent to one task and 50 percent to another, then you would see two rows for the same date and TRC. You can view the details of how the time is allocated on the Payable Time Details page.

<b>Field or Control</b>	<b>Description</b>
<b>Start Date</b>	Seven days of information is displayed by default.
<b>Previous Employee</b> and <b>Next Employee</b>	Click to view a different employee's summary of payable time.
<b>Pending Exceptions</b>	This button appears if exceptions were generated. Click to access the Manage Exceptions page.
<b>Detail Page</b>	Click to access the Payable Time Details page.

---

**Note:** Time that has High severity level exceptions associated with it doesn't appear on this page because it is not considered payable time. Time that has Low or Medium severity level exceptions associated with it will create payable time and display on this page.

---

## Payable Time Detail Page

Use the Payable Time Detail page (TL\_MNG\_PAY\_DET\_VW) to view the details of and employee's payable time.

If an employee has reported time and the Time Administration process runs, it is possible that the system still doesn't create payable time. If the system creates exceptions, then it depends on the priority of the exception. Low and medium severity exceptions enable the system to create payable time; however, high severity exceptions do not.

Navigation:

**Manager Self Service > Time Management > View Time > Payable Time Detail > Payable Time Detail**



This example illustrates the fields and controls on the Payable Time Detail page. You can find definitions for the fields and controls later on this page.

**Payable Time Detail**

**Osmar Mutukumari** Employee ID K0W202  
Administrator-Network Services Employment Record 0

Actions ▾

Start Date    
 End Date

▶ **Payable Status Filter**

**Payable Time** ?

Overview	Time Reporting Elements	Task Reporting Elements	Cost and Approval
Date	Status	Reason Code	Time Reporting Code
Quantity	TRC Type	Estimated Gross	
09/24/2014	Needs Approval		KUREG
09/25/2014	Needs Approval		KUREG
09/26/2014	Needs Approval		KUOVT
09/26/2014	Needs Approval		KUREG
8.00	Hours	\$138.46	
8.00	Hours	\$138.46	
1.00	Hours	\$25.96	
8.00	Hours	\$138.46	

[Return to Select Employee](#)  
[Pending Exceptions](#)

This page displays each day's payable time, including the time reporting code for the time. The employee can manually enter the TRC, or the system can generate it automatically during time reporting. The system also displays the number of units, amounts, or hours for the TRC. This value must be within the minimum and maximum quantity set for the TRC. The TRC type determines if this value is amounts, units, or hours. The system displays the date of the reported time and the current status of the payable time. The payable status records the progress of payable time through its different stages.

<b>Field or Control</b>	<b>Description</b>
Start Date and End Date	Seven days of information is displayed by default. .
<b>Payable Status Filter</b>	Expand this grid to filter the display by payable time status.
<b>Pending Exceptions</b>	This button appears if exceptions were generated. Click to access the Manage Exceptions page.
<b>Time Reporting Elements</b>	Select this tab to view more payable time information.
<b>Task Reporting Elements</b>	Select this tab to view more payable time information.

## Forecasted Time Summary Page

Use the Forecasted Time Summary page (TL\_TMSPAY\_SUMM) to view the week-by-week summary of an employee's forecasted payable time by time reporting code using this display-only page.

Navigation:

**Manager Self Service > Time Management > View Time > Forecasted Time Summary > Forecasted Time Summary.** Click the employee **Last Name** link.

This example illustrates the fields and controls on the Forecasted Time Summary page. You can find definitions for the fields and controls later on this page.

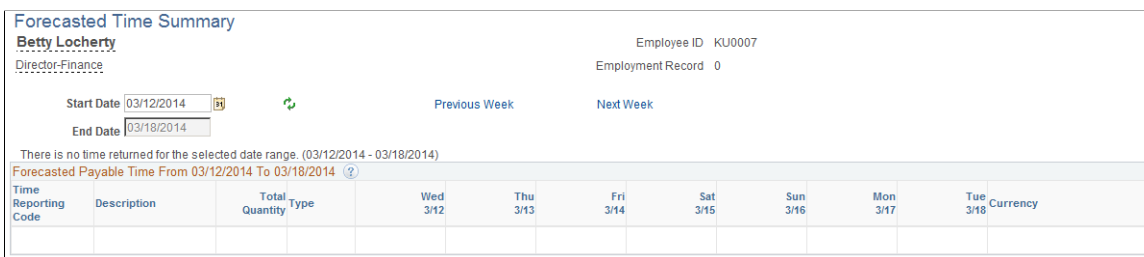

The Forecast Payable Time feature enables you to estimate what your payable time is either for the current period or for some time period in the future. It uses reported time, scheduled time, or both to calculate what the payable time is for a specified time period. For example, if you are a manager in a retail store where schedules change constantly, you are probably concerned about the number of employees who work overtime. You may want to estimate payable time for the current period and review which employees are approaching overtime limits. By using the Forecast Payable Time feature, the system looks at how many hours your employees have reported so far in the period, and also what their remaining scheduled hours are. The Forecast Payable page shows you what their estimated payable time will be and, from there, you will know if any of your employees are approaching overtime.

Payable time is forecasted in two ways:

- Forecast time for a month or for a specific date using the Time and Labor Launch Pad.
- Forecast time for a period using the Time Administration Run Control.

---

**Note:** Forecasted Payable Time is not actual Payable Time. To generate Payable Time, you must use the normal processes for creating payable time.

---

The Forecasted Time Summary page displays one week's estimated payable time. The system allocates time based on the TRC, and displays the total quantity of hours for each TRC to which time was reported or generated by the rules process within the date range specified.

<i>Field or Control</i>	<i>Description</i>
<b>Detail Page</b>	Click this link to access the Forecasted Time Details page.

## Compensatory Time - Select Employee Page

Use the Compensatory Time: Select Employee page (TL\_MSS\_COMP\_SRCH) to search for employees where you want to view compensatory time balance and expiration information.

Navigation:

**Manager Self Service > Time Management > View Time > Employee Compensatory Time > Compensatory Time**

This example illustrates the fields and controls on the Compensatory Time: Select Employee page.

Last Name	First Name	Employee ID	Empl Record	Job Title	Comp Time Off Plan	Description
Adams	Cynthia	KU0101	0	Corporate Controller	KUCTOP1	No Limit Pos/Never Expire
Agar	Mary	KA3001	0	Clerk-Shipping	KACOMP1	KAM's Compensation Plan
Artoux	Pierre	KFGE0003	0	Manager-Information Systems	KFCTOPLAN	KF Compensatory Time Off Plan
Avalon	Tom	KOMBZ007	0	Finance Specialist	KUCTOP1	No Limit Pos/Never Expire
Bains	Cindy	KU0153	0	Accounting Clerk	KUCTOP1	No Limit Pos/Never Expire
Baran	Charles	KU0002	0	Chief Operating Officer	KUCTOP3	All Options - Executive Plan
Bergsten	Darlene	K0G003	0	Analyst-Data	KUCTOP1	No Limit Pos/Never Expire
Bickham	Debroah	K0G010	0	Financial Analyst	KUCTOP1	No Limit Pos/Never Expire

Use the **Select** section to specify employee details to perform a search. regarding employee compensatory time.

Select an employee’s name link to access the Compensatory Time Page.

## Compensatory Time Page

Use the Compensatory Time page (TL\_COMPTIME\_PNL) to view compensatory time balance and expiration information.

Navigation:

Select an employee from the Compensatory Time: Select Employee page.

This example illustrates the fields and controls on the Compensatory Time page. You can find definitions for the fields and controls later on this page.

## Compensatory Time

**Helen Grimes**  
[Clerk-Shipping](#)  
[Actions](#) ▾

Previous Employee Next Employee

Employee ID KA3007  
 Employment Record 0

**Comp Time Balance Summary** ?

Compensatory Time Off Plan KACOMP1	Expiration Period Months
Date 01/12/2017	Period Count 9
Balance at Start of Day -8.00	

\* Show Time Expiring in Next 90 Days ▾

**Expiring Time Earned** ?

Expiration Date	Quantity	Ending Balance
	0.00	0.00

[Return to Select Employee](#)

[Manager Self Service](#)

[Time Management](#)

The Compensatory Time page includes the compensatory time balance as of the date specified. This balance may be positive or negative, depending on how the plan is set up and what has been reported.

<b>Field or Control</b>	<b>Description</b>
<b>Show Time Expiring in</b>	Select how far in the future you want to view compensatory time expiration information. Once you make a selection, the system displays all compensatory time with an expiration date that meets the criteria.  For example, if you select <i>Next 30 days</i> , the system displays all the compensatory time expiring within the next 30 days. If the compensatory time has no expiration date, it doesn't appear here.
<b>Expiration Date</b>	Displays the date that the employee's reported compensatory time is set to expire. The time expires at midnight of the date specified in this field.
<b>Quantity</b>	Displays the number of compensatory hours that were originally reported and are set to expire on the date specified in the <b>Expiration Date</b> field.

<b>Field or Control</b>	<b>Description</b>
<b>Ending Balance</b>	Displays the compensatory time balance at the end of the date specified in the <b>Expiration Date</b> field once the hours have expired.

## Leave and Compensatory Time Page

Use the Leave and Compensatory Time page (TL\_LEAV\_COMP) to view all of one or more employees' leave details for the selected period.

Navigation:

**Manager Self Service > Time Management > View Time > Leave/Compensatory Time Report > Leave and Compensatory Time**

This example illustrates the fields and controls on the Leave and Compensatory Time page. You can find definitions for the fields and controls later on this page.

Use the **Select** field to specify employees to include in a notification regarding the employees' leave and compensatory time. When you have selected one or more employees, use the **Notify** button to open the HR Notification window and create the notification.

**Note:** Oracle PeopleSoft delivers Notification Composer Framework to manage the setup and administration of all notifications in one central location. Once you have adopted the Notification Composer feature, you must use it to create new notifications and manage your existing notifications. Notifications delivered with HCM Image 47 or later must use Notification Composer. For more information about Notification Composer Framework, see “Understanding Notification Composer” (Enterprise Components).

When Absence Management is the job data absence system for an employee, the system uses the Absence Management leave data and the compensatory time data from Time and Labor. The following tables provide the leave and compensatory time data in this when Absence Management is installed and used:

- TL\_COMPLEAV\_TBL
- GP\_ABS\_CUR\_BAL

- GP\_ABS\_TYPE
- GP\_ABS\_TAKE
- GP\_ABS\_TAKE\_ENT

When the job data absence system for an employee not Absence Management, and the employee is enrolled in a Base Benefit leave plan, then the system displays the compensatory time leave data from Time and Labor. The following tables provide the leave and compensatory time data when Base Benefits is installed and used:

- TL\_COMPLEAV\_TBL
- LEAVE\_PLAN
- BENEF\_PLAN\_TBL

## Leave and Compensatory Time Detail Page

Use the Leave and Compensatory Time Detail page (TL\_LEAVCOMP\_DTL) to view employee-specific leave details.

Navigation:

Click the employee last name link on the Leave and Compensatory Time page

This example illustrates the fields and controls on the Leave and Compensatory Time Detail page.

**Vacation Detail**

**Baldwin Park** Employee ID MWC0009  
 ST - Computer Programmer Employment Record 0

Displays the balance of Leave/Compensatory time for an employee as of the specified date. This balance may be positive or negative, depending on how the plan is set up and what has been reported

Start Date:

End Date:

Leave and Compensatory Time									Personalize   Find   View All   <input type="button" value="🔍"/>	First 1-10 of 10 Last
Plan	Plan Description	Unit Type	Carry Over	Starting Balance	Units Earned	Units Taken	End Balance	Accrual Date		
51	Vacation	Hours		90.000000	10.000000	0.000	100.000	10/01/2010	▲	
51	Vacation	Hours		80.000000	10.000000	0.000	90.000	09/01/2010		
51	Vacation	Hours		70.000000	10.000000	0.000	80.000	08/01/2010		
51	Vacation	Hours		60.000000	10.000000	0.000	70.000	07/01/2010		
51	Vacation	Hours		50.000000	10.000000	0.000	60.000	06/01/2010		
51	Vacation	Hours		40.000000	10.000000	0.000	50.000	05/01/2010		
51	Vacation	Hours		30.000000	10.000000	0.000	40.000	04/01/2010		
51	Vacation	Hours		20.000000	10.000000	0.000	30.000	03/01/2010		
51	Vacation	Hours		10.000000	10.000000	0.000	20.000	02/01/2010		
51	Vacation	Hours		0.000000	10.000000	0.000	10.000	01/01/2010	▼	

Based on the specified **Start Date** and **End Date**, the system displays the individual transaction rows.

## Accumulators Page

Use the Accumulators page (TL\_ALL\_ACCUMULATOR) to view time reporter accumulator totals by TRC.

Navigation:

**Manager Self Service > Time Management > View Time > Accumulators > Accumulators**

This example illustrates the fields and controls on the Accumulators page. You can find definitions for the fields and controls later on this page.

### Accumulators

[Millie Pham](#) Employee ID: MPC002\_S  
 Job Title: ST - Filing Clerk Empl Record: 0

[Previous Employee](#) [Next Employee](#)

---

Start Date:  End Date:

Accumulator Details		
TRC	Description	Quantity

If you enter a range of dates in this page per employee, you will see per accumulator TRC, what the accumulated total (QTY) is associated to that TRC as of that date range. The accumulators will keep getting added to, they are not decreased from or restarted. The accumulator totals per employee are stored in TL\_IPT1\_CNT table.

---

## Using Manager Time Calendar Views

This section provides an overview of Time Calendar views, and common elements used with time calendar pages.

---

**Note:** This feature has been replaced by Workforce Availability functionality in Fluid. For more information, see [Using PeopleSoft Fluid User Interface for Time Management as a Manager](#).

---

## Pages Used to View Manager Time Calendars

<b>Page Name</b>	<b>Definition Name</b>	<b>Usage</b>
<u>View Criteria Page</u>	TL_WV_CRITERIA_SBP	Select the criteria to view on the current calendar page. The system retains the <b>Group ID</b> and <b>Show Symbols</b> selections and defaults to these each time you access the page. The system also carries these selections to the next calendar view you access using the Navigational Links. The daily calendar also retains the <b>Start Time</b> and <b>End Time</b> selections.
Legend Page	TL_WV_LEGEND_SBP	Use the legend, displayed at the bottom of each of the calendar pages, to interpret the calendar color codes, and symbols if you select <i>Show Symbols</i> as part of the view criteria. What appears in the legend depends on the viewing options defined in the calendar view setup and the options selected for viewing the current calendar. Only colors/symbols defined on the set up page and selected to display time data on the current calendar view appear here.
<u>Daily Time Calendar Page</u>	TL_WV_DAILY	Use the Daily Time Calendar page to view detailed information regarding time reporters' daily time related data for a specific date. The page defaults to the current date.
<u>Weekly and Monthly Time Calendar Pages</u>	TL_WV_WEEKLY	Use the Weekly Time Calendar page to view detailed information regarding time reporters' weekly time related data for a specific week. The page defaults to the current week period.  Use the Monthly Time Calendar page to view detailed information regarding time reporters' monthly time related data for a specific month. The page defaults to the current month period.

## Understanding Manager Time Calendars

Time and Labor time calendar views provide assistance to optimally manage workforce resources by offering up-to-the-minute information on time reporter groups and time related events. This information can include which time reporters are scheduled, those present, those available, and other information such as training and absences. This information is viewable on a daily, weekly or monthly time calendar and includes drill down capability to view lower level details.



Time and Labor time calendar views enable managers to properly determine current resource allocation and adjust resources for maximum productivity and profitability. Managers can respond quickly to changing scheduling needs and time reporter requests. Managers can also view prior periods to assess past scheduling effectiveness and resource allocation.

Each time calendar page consists of a set of instructions, a viewing options menu to select the type of information to view on the time calendar, the time calendar grid itself that displays time reporter information and a legend that details the colors and codes used in the time calendar display.

The daily time calendar view page enables managers to view daily time information broken down by the hour. This time information can include those time reporters currently present, those scheduled later in the day and those who are scheduled off or have not yet arrived. Since managers can also view current overtime allowances, immediate decisions can be made addressing the overtime concerns for an individual time reporter or a group of time reporters.

The weekly and monthly time calendar view pages enable managers to analyze recorded time data and plan future schedules. Using prior period time calendar views, managers can view time reporters' overtime hours, completed training, and absence history. Managers can use this information to review time reporters' approaching overtime limits for example, allowing managers to respond to scheduling needs and take immediate action to avoid excessive overtime. Viewing future periods on the time calendar view pages enable managers to preview scheduled training and absences and make adjustments to schedules as necessary.

---

**Note:** The absence display functionality requires the installation of PeopleSoft Absence Management. The training display functionality requires the installation of PeopleSoft Human Resources (Administer Training business process) or Learning Management and implementation of the Administer Training .

---

**Note:** Each manager calendar view page contains several sections of information. While the actual time calendar section changes based on the daily, weekly or monthly selection made, the rest of the page remains largely the same, providing general information for interpreting the calendar page. While you can select to view different groups of time reporters in the **View Criteria** section of the Time Calendar page, the system defaults to the time reporters assigned to the manager signed on to the page.

---

## Viewing Time Calendars

The time calendar view design presents a grid with each time reporter listed, by name, on the left side of the page. To the right of the **Time Reporter** column is the **Job Title** column, showing each time reporter's job title. The **Exceptions and No Show** columns display only when there is exception or "no show" information to display for a time reporter. The **No Show** column displays only on the daily calendar.

For elapsed time reporters the **Elapsed** column displays the time rather than the time slots. When more than one time event has occurred for the selected time period (more than one TRC reported) the hours of all of these events are totaled and displayed using the color/symbol for the event with the highest priority. Only reported hours are used in the calculation of total hours for the period.

For training and absence, the system displays requested and approved hours when no hours are reported. These hours are *not* included in the Sum column.

For holidays, if hours are not reported but are scheduled, the system displays the quantity of scheduled hours; otherwise, the grid displays reported hours. These hours also do not calculate in the Sum column unless the hours were reported to a TRC that is associated with a TRC List defined on the Options page.

## Common Elements Used in This Section

<b>Field or Control</b>	<b>Description</b>
Time Reporter	This display-only field shows each employee with reported time for the selected period.
Job Title	This display-only field shows the job title for each time reporter with reported time for the selected period.
Exceptions	<p>If exceptions have been generated during the Time Administration process for a time reporter for the time period, a link to the Manage Time Exceptions page (TL_MNG_EXCEPT_PNL3) will appear in this column.</p> <p>If there are no exceptions for a time reporter this column is not displayed.</p> <p>See <a href="#">Managing Exceptions</a>.</p>
No Show	Indicates a time reporter failed to show up for a scheduled shift on the current day. This appears only on the daily calendar.
Elapsed	<p>For elapsed time reporters, the <b>Elapsed</b> column displays reported hours rather than displaying hours in the time slots.</p> <p>Where more than one time event has occurred for the selected time period the hours of all events are totaled and displayed using the color/symbol for the event with the highest priority.</p>
Sum	<p>The Sum column displays the summary of total punched time and elapsed time on the time reporter row. If the <b>Show Schedule</b> option is selected, the Sum column displays the total number of scheduled hours in the schedule row for the viewing period.</p> <hr/> <p><b>Note:</b> The <b>Sum</b> column displays the summary <i>inclusive</i> of the <b>End Time</b> hour in the daily time calendar being displayed. If the selected time calendar display period is between 8 am and 2 p.m., the <b>Sum</b> column calculates <i>through</i> the <b>End Time</b> hour selected, calculating through 2:59 p.m. Change the time range for the calendar display to assure all time reported appears in the <b>Sum</b> column.</p> <hr/>
Daily Calendar, Weekly Calendar and Monthly Calendar	Each calendar viewing page contains links to the other two views. Use these links to access a different calendar viewing period.

<b>Field or Control</b>	<b>Description</b>
Go to:	The <b>Go to:</b> drop-down menu provides navigation links to these time management pages: Adjust Paid Time, Approve Absence Requests (if PeopleSoft Absence Management is installed), Approve Overtime Requests, Approve Payable Time, Assign Work Schedule, Manage Exceptions, Manage Schedules, Timesheet, View Forecasted Payable Time, View Payable Time (Detail).

## View Criteria Page

Use the View Criteria page (TL\_WV\_CRITERIA\_SBP) to select the criteria to view on the current calendar page.

The system retains the Group ID and Show Symbols selections and defaults to these each time you access the page. The system also carries these selections to the next calendar view you access using the Navigational Links. The daily calendar also retains the Start Time and End Time selections.

Navigation:

**Manager Self-Service > Time Management > View Time > Daily, Weekly or Monthly Time Calendar**

This example illustrates the fields and controls on the View Criteria group box. You can find definitions for the fields and controls later on this page.

The screenshot shows the 'View Criteria' section of a web application. It includes a date field set to '03/18/2014' with 'Previous Day' and 'Next Day' links. Below are dropdown menus for '\*Start Time' (00:00) and '\*End Time' (23:00). A 'Display Options' section contains several checkboxes: 'Show Schedule', 'Show Training Hours', 'Show Absences', 'Show Holidays', 'Show Planned Overtime', and 'Show Exceptions'. A 'Show Symbols' checkbox is also present. A 'Refresh View' button is located at the bottom right of the options section.

Each of the calendar viewing pages enables you to select the types of information you choose to view. The viewing options must first be defined on the Calendar View Options page. The available viewing options display above the calendar. This flexible design enables you to adjust the criteria so that you view exactly the information you need. By selecting the check box next to the option you want to add to the view, you can build a multi-layered view of the schedule.

**Note:** Though absence, overtime and training information can be selected to display on all calendar views, the type of information displayed depends on the period being viewed and implementation of PeopleSoft Absence Management (for absences) and PeopleSoft Human Resources Administer Training or PeopleSoft Learning Management for training data. Time and Labor uses the Scheduled Time Fullsync and Scheduled Time Sync application messages to pull training data from ELM to the HCM database. For more detailed information on these selections, see the page description for the specific view.

<b>Field or Control</b>	<b>Description</b>
Previous Day, Previous Week, Previous Month, Next Day, Next Week and Next Month	Navigate forward and backward keeping the same view criteria and time period selection.
Show Schedule	<p>Selecting this option adds a row beneath each time reporter row in the calendar grid. For each time reporter, the top row displays only reported or payable time and the bottom row displays the scheduled time as either "Workday" or "Offday." The Sum column displays the total number of scheduled hours for the time reporter. Before using this option the schedules must be created, built and assigned to time reporters.</p>
Show Holidays	<p>Select to display the holiday schedule of each time reporter.</p> <p>To derive Holiday data, first the system determines if there is a Holiday Schedule on the JOB record for the employee. If there is no Holiday Schedule on the Job record, then the system will check for a Holiday Schedule in the following order:</p> <ol style="list-style-type: none"> <li>1. If the employee is enrolled in the Global Payroll system, derive the Holiday Schedule from the Global Payroll pay group.</li> <li>2. If the employee is enrolled in the Payroll for North America system or Payroll Interface, and the selected Absence System is <i>Absence Management</i>, derive the Holiday Schedule from Global Payroll pay group.</li> <li>3. If the employee is enrolled in the Payroll for North America system or Payroll Interface, and the selected Absence System is <i>Other</i>, derive the Holiday Schedule from the Payroll for North America pay group.</li> <li>4. If there is no Holiday Schedule on the pay group, derive the Holiday Schedule from the Time and Labor Workgroup.</li> </ol> <p>Holidays display on the time row, not the schedule row. If time is reported on a holiday, the system displays the time event with the highest priority so, if "Holiday" is higher, the color and symbol for holiday displays.</p> <p>If the holiday is also a regular workday but no time is reported, the system displays the scheduled time in the reported slot with the color and symbol for holiday. Only reported hours calculate in the Sum column in this case.</p>
Show Symbols	<p>Select to display the designated time event symbols as defined on the Calendar View Options page.</p> <hr/> <p><b>Note:</b> Defining symbols is optional. If symbols have not been defined in the setup, <b>Show Symbols</b> will not be an option.</p> <hr/>

<b>Field or Control</b>	<b>Description</b>
Show Exceptions	<p>When selected, an <b>Exceptions</b> column is added in the grid and displays an Exceptions link for any time reporter with exceptions during the Time Administration Process. Clicking this link takes you to the Exceptions Information page which provides more details about the exception and enables you to manage these exceptions.</p> <p>The <b>Exceptions</b> column appears only if there are exceptions to show.</p> <p>See <a href="#">Exceptions Page</a>.</p>
Show Absences	This option either displays absences reported in Absence Management or displays reported absences in Time and Labor for Base Benefit users, who are reporting leave time.
Show Training Hours	This option works with Human Resources Administer Training and Learning Management to display requested , approved, and reported training time.
View Day, View Week, and View Month	Click to apply the selected viewing options to the current page. The system stores the <b>Group ID</b> and <b>Start Time, End Time</b> and <b>Show Symbols</b> viewing criteria so that the next time this page is accessed with the same User ID, the same options will appear. Each time the options are changed click the View Time button to refresh the calendar view.

## Daily Time Calendar Page

Use the Daily Time Calendar page (TL\_WV\_DAILY) to use the Daily Time Calendar page to view detailed information regarding time reporters' daily time related data for a specific date.

The page defaults to the current date.

Navigation:

**Manager Self-Service > Time Management > View Time > Daily Time Calendar > Daily Time Calendar**

This example illustrates the fields and controls on the Daily Time Calendar page (1 of 2). You can find definitions for the fields and controls later on this page.

The screenshot shows the 'Daily Time Calendar' interface. At the top, there is an 'Employee Selection' field. Below it, three tabs are visible: 'Daily Time Calendar' (selected), 'Weekly Time Calendar', and 'Monthly Time Calendar'. A 'View Criteria' section contains a date field set to '01/01/2007', with 'Previous Day' and 'Next Day' buttons. Below the date are dropdown menus for '\*Start Time' (00:00) and '\*End Time' (23:00). A 'Display Options' section contains several checkboxes: 'Show Schedule', 'Show Training Hours', 'Show Absences', 'Show Holidays', 'Show Planned Overtime', 'Show Exceptions', and 'Show Symbols'. A 'Refresh View' button is located at the bottom right of the display options.

This example illustrates the fields and controls on the Daily Time Calendar page (2 of 2). You can find definitions for the fields and controls later on this page.

The screenshot shows a table of employee work times. The table has columns for 'Last Name', 'First Name', 'Employee ID', 'Job Description', 'No Show', 'Elapsed', and hourly time slots from 00:00 to 08:00. The data is as follows:

Last Name	First Name	Employee ID	Job Description	No Show	Elapsed	00:00	01:00	02:00	03:00	04:00	05:00	06:00	07:00	08:00
Pham	Benny	MPC005_S	Software Test Engineers											
Pham	Bloo	MPC003_MJ	ST - Filing Clerk											
Pham	Bloo	MPC003_MJ	ST - Acclg Clerk											
Pham	Bloo	MPC003_MJ	ST - Benefits Clerk											
Pham	Felix	MPC006_MJ	Musician											
Pham	Felix	MPC006_MJ	Bartender											
Pham	Ginger	MPC001_S	ST - Payroll Clerk											
Pham	Marshall	MPC010_S	Head Nurse											
Pham	Millie	MPC002_S	ST - Filing Clerk											
Pham	Prince	MPC004_S	Software Engineering Developer											

Below the table is a 'Legend' section.

This page provides an overview of a manager's time reporters' work time on a specified day. When accessing the page, all time reporters for the manager are listed and reported time for the current day (00:00 – 23:00) is displayed.

The **Sum** column displays the total time recorded for each time reporter for the selected viewing period. For punch time reporters, the sum represents the time between each in and out punch. If no out punch exists, the lesser of either current time or the selected period end time is used as the out time for the calculation.

On the daily calendar for example, if a time reporter records an in punch at 1:00 p.m. and the selected calendar view range runs from 8:00 am to 4:00 p.m., the sum would report four hours for this time reporter. For elapsed time reporters, the **Sum** column will display reported hours that are associated to TRCs that were found in the TRC List(s) designated on the View Options page.

On the daily calendars, punch time reporters recorded punch times display in the applicable time slot using the color/symbol for the Default Reported/Payable Time. If a symbol is specified for the time event, the punch time is preceded by the symbol and a dash. If a subsequent punch time event occurs within the same time slot, the time of this next event is appended with a dash separating the times. For time slots where no actual punches occur that are subsequent to a time-in punch and prior to a time-out punch, the color/symbol alone is displayed. For a time where a scheduled event such as training also occurs (the

**Show Training** option must be selected) the color/symbol with the highest priority displays in the time slot.

<i><b>Field or Control</b></i>	<i><b>Description</b></i>
<b>Previous Day and Next Day</b>	Navigate forward and backward keeping the same view criteria and time period selection.
<b>Start Time and End Time</b>	Select the range of time you choose to view for the daily calendar. The time calendar displays the time data for the specified range incrementing in one-hour slots. Time displays in military time only. These fields do not appear on the weekly or monthly calendar views. The times you set will remain the default times when accessing the daily calendar view pages.
<b>Show Planned Overtime</b>	Select to display requested and approved overtime.  If reported time overlaps with requested or approved overtime time, the reported time appears in the hour grid and the Elapsed time column reflects the additional overtime amount.
<b>Show Training Hours</b>	Select to display the requested and approved training hours.  If training hours have been requested or approved for a time reporter, the grid displays the hours requested or approved will display, depending on the priority settings.  Only reported hours calculate in the Sum column. Hours displayed but not reported (requested, approved, scheduled) are not included in the Sum calculation.

<i><b>Field or Control</b></i>	<i><b>Description</b></i>
<b>Show Absences</b>	Select to display requested and approved absences as well as " <b>no show</b> " information. If a time reporter is scheduled to work but has not punched in and the scheduled start time has elapsed, then "no show" appears in a separate No Show column.  If reported time overlaps with requested or approved absence time, the reported time appears in the hour grid and the Elapsed time column reflects the additional absence time.  If "Half" or "All" days were selected for an absence without hours being specified, the system uses the scheduled hours to determine how many hours to display if a schedule exists.  If no schedule exists or if the day is an "Off" day, the system uses a default number of hours defined on the Calendar View Options Setup page.

## Weekly and Monthly Time Calendar Pages

Use the Weekly or Monthly Time Calendar page (TL\_WV\_WEEKLY) to view detailed information regarding time reporters' weekly or monthly time related data for a specific time period.

Navigation:

**Manager Self-Service > Time Management > View Time > Weekly Time Calendar > Weekly Time Calendar**

Navigation:

**Manager Self-Service > Time Management > View Time > Monthly Time Calendar > Monthly Time Calendar**

This example illustrates the fields and controls on the Weekly Time Calendar page (1 of 2). You can find definitions for the fields and controls later on this page.

This example illustrates the fields and controls on the Weekly Time Calendar page (2 of 2). You can find definitions for the fields and controls later on this page.

Last Name	First Name	Employee ID	Job Title	Total	Mon. 09/29/2014	Tue. 09/30/2014	Wed. 10/01/2014	Thu. 10/02/2014	Fri. 10/03/2014
Noren	Daren	KUTLWC18	Analyst-Budget I	33.00	05.00	06.00	07.00	07.00	08.00
Refina	Richie	KUTLWC04	Consultant-Senior	-	-	-	-	-	-
Romey	Vivian	KUTLWC02	Senior Manager-Finance	-	-	-	-	-	-
Roshs	Derick	KUTLWC16	Analyst-Budget I	05.00	05.00	-	-	-	-
Rozario	Albert	KUTLWC09	Analyst-Business	-	-	-	-	-	-
Salvador	Courtney	KUTLWC03	Specialist-Compensation	-	-	-	-	-	-
Shervin	Desmond	KUTLWC01	Manager-Finance	80.00	16.00	16.00	16.00	16.00	16.00
Simson	Allan	KUTLWC17	Analyst-Budget I	-	-	-	-	-	-
Stocs	Ralph	KUTLWC15	Analyst-Budget II	-	-	-	-	-	-
Terry	Clive	KUTLWC07	Analyst-Financial	-	-	-	-	-	-



**Note:** The previous screenshot does not display the entire page. Scroll to the right on your system to view all of the fields on the page.

The Weekly and Monthly Time Calendar pages provide managers with an overview of their time reporters' reported time and other time related data for a specific week or month.

If reported or payable time exists for a time reporter, the hours quantity displayed in the cell is associated to that reported or payable time. The time displays as a link in the cell. If multiple TRCs are reported by a time reporter for a specific date, the reported or payable hours appear for that date with the color and symbol for the TRC with the highest priority appearing as the link. Click this link to view details on the reported or payable time.

If no reported or payable time exists but another time event item does, the quantity and symbol (if **Show Symbols** is selected) of the next highest priority item will the cell displays.

The **Sum** column displays the total time for the selected viewing period. For punch time reporters, the sum represents the time between each in and out punch.

If no out punch exists, the system uses the end of the day (24:00); if no in punch exists, the system uses the beginning of the day (00:00).

<b>Field or Control</b>	<b>Description</b>
Previous Week and Next Week, Previous Month and Next Month	Navigate forward and backward keeping the same view criteria and time period selection.
Reported Hours / Payable Hours	Use these options to select either reported or payable hours for viewing. These options appear only on the weekly and monthly time calendar views.
Show Planned Overtime	Select to display requested and approved overtime.
Show Training Hours	Select to display the requested and approved training hours.  If training hours have been requested or approved for a time reporter, the hours requested or approved will display, depending on the priority settings.  Only reported hours calculate in the Sum column. Hours displayed but not reported (requested, approved, scheduled) will not be included in the Sum calculation.
Show Absences	Select to display requested and approved absences.  If "Half" or "All" days were selected for an absence without hours being specified, the system uses the scheduled hours to determine how many hours to display if a schedule exists.  If no schedule exists or if the day is an "Off" day, the system uses a default number of hours defined on the Calendar Options Setup page.

## Related Links

[Setting Up Manager Time Calendar View Options](#)

[Managing Exceptions](#)

[Understanding the Time Reporting Process](#)

[Understanding Self-Service Components](#)

---

## Managing Overtime Requests

This section provides an overview of self-service overtime request transactions.

**Note:** To take full advantage of this feature, it is recommended that you keep payable time up to date in order to populate Actual and Projected Overtime Hours. Also, ensure that you have time periods for the overtime limits built out as far in the future as you expect overtime to be requested.

---

## Pages Used to Manage Overtime Requests

<i>Page Name</i>	<i>Definition Name</i>	<i>Usage</i>
<a href="#">View Overtime Requests - Overtime Requests Page</a>	TL_OT_EVENTS	View an employee's overtime requests.
<a href="#">Overtime Request Details Page</a>	TL_OT_RQST_DTL	View the details of an employee's overtime request.
<a href="#">Overtime Balances Page</a>	TL_OT_BALANCES	View service dates, overtime balances for the current period and year-to-date, and overtime limits for a group of employees or your direct reports.
<a href="#">Approve Overtime Requests - Select an Employee Request Page</a>	TL_OT_MNGR_LIST	Approve, deny, or push back employees' overtime requests. You can approve or deny multiple requests at the same time.
<a href="#">Approve Employee Overtime – Overtime Request Details Page</a>	TL_OT_APPR	Approve, deny, or push back a single overtime request. You can also add comments that the employee can see.

## Understanding Overtime Request Transactions

With Time and Labor, employees can enter overtime requests for a future date through a Web browser page and receive approval or denial notices. Managers can view overtime requests through the Web, quickly check the amount of overtime that employees have worked to date, and approve or deny requests, entering comments that explain why.

Managers can approve, deny, or push back overtime requests through the Approve Overtime Requests page or the Overtime Request Details page, if the approval of overtime requests is set up in the workgroup.

## View Overtime Requests - Overtime Requests Page

Use the View Overtime Requests - Overtime Requests page (TL\_OT\_EVENTS) to view an employee's overtime requests.

Navigation:

**Manager Self Service > Time Management > View Time > Overtime Requests > View Overtime Requests**

Click the employee name link.

This example illustrates the fields and controls on the View Overtime Requests - Overtime Requests page. You can find definitions for the fields and controls later on this page.

The screenshot displays the 'View Overtime Requests' page for Carmichael Espinosa. The page includes the following elements:

- Employee Information:** Carmichael Espinosa (Consultant-Senior), Employee ID KU0015, Employment Record 0.
- View Options:** A dropdown menu for 'Month' set to '03 - March', a dropdown menu for 'Year' set to '2014', a 'View Requests' button, and a checkbox for 'View All Requests'.
- Overtime Requests Table:** A table with columns for 'Details', 'Date On Request', 'Overtime Hours', 'Date Submitted', and 'Request Status'. It shows two requests, both with a status of 'Needs Approval'.

Details	Date On Request	Overtime Hours	Date Submitted	Request Status
<a href="#">Details</a>	03/19/2014	2.00	03/18/2014	Needs Approval
<a href="#">Details</a>	03/18/2014	1.00	03/18/2014	Needs Approval

This page lists all of the employee's overtime requests and the status of each request: *Submitted*, *Needs Approval*, *Approved*, *Denied*, or *Push Back*.

To view the approval details for a request or see comments that were submitted with a request, click the **Details** link. The Overtime Request Details page appears.

## Overtime Request Details Page

Use the Overtime Request Details page (TL\_OT\_RQST\_DTL) to view the details of an employee's overtime request.

Navigation:

Click a **Details** link on the View Overtime Requests page.

This example illustrates the fields and controls on the View Overtime Requests — Overtime Requests Details page. You can find definitions for the fields and controls later on this page.

**View Overtime Requests**

**Overtime Requests**  
**Carmichael Espinosa** Employee ID KU0015  
 Consultant-Senior Employment Record 0

**Overtime Request Details** ?

Date On Request 03/19/2014 Date Submitted 03/18/2014  
 Overtime Hours 2.00  
 Request Status Needs Approval

**Approval Details**

User ID	Name	Request Status	Date	Comment
HCRUSA_KU0015	Carmichael Espinosa	Needs Approval	03/18/2014	Submitted.

**By SupervisorID**

▼ **Overtime Request Approval for 2014-03-19: Pending** [View/Hide Comments](#)

Route to Supervisor

**Pending**

**Marc Kessler**  
TLBySupervisorID

▶ **Comments**

This page is the same as the Overtime Request Details page that employees can access.

**Related Links**

[Request Overtime - Request Overtime List Page](#)

**Overtime Balances Page**

Use the Overtime Balances page (TL\_OT\_BALANCES) to view service dates, overtime balances for the current period and year-to-date, and overtime limits for a group of employees or your direct reports.

Navigation:

**Manager Self Service > Time Management > View Time > Overtime Balances**

This example illustrates the fields and controls on the Overtime Balances page. You can find definitions for the fields and controls later on this page.

**Overtime Balances**

▶ **Employee Selection**

**Overtime Information** ? Personalize | Find | View All | First 1 of 1 Last

**Time Reporters** | **Demographics** |

Last Name	First Name	Employee ID	Empl Record	Job Title	Service Date	Current Period Balance	Year To Date Balance	Current Overtime Limit
			0					

Manager Self Service  
 Time Management

## Overtime Information

<b>Field or Control</b>	<b>Description</b>
Service Date	Displays the employee's service date from the Employment record. No service date is listed for non-employees.
<b>Current Period Balance</b>	<p>The number of overtime hours in payable time from the beginning of the period to the current date. The period is the same as that defined for the overtime limit. The balance includes hours for all overtime TRCs that are included in the overtime limit definition associated with the employee's workgroup. If an overtime limit is not defined on the employee's workgroup, the current period balance is not displayed. The overtime TRCs (OT TRC List) and time period from the overtime limit are used to resolve the current period balance.</p> <hr/> <p><b>Note:</b> If the user's row security permission list is defined to use the TL system date, the system date is treated as the current date for the purpose of calculating the balance. You define row security permission lists on the Row Security Permission List page (Set Up HCM, Security, Time and Labor Security, TL Permission List Security).</p> <hr/>
<b>Year to Date Balance</b>	<p>The number of overtime hours in payable time from the beginning of the year to the current date. The balance includes hours for all overtime TRCs that are included in the overtime limit definition associated with the employee's workgroup. If an overtime limit is not defined on the employee's workgroup, the Year to Date balance is not displayed. The overtime TRCs (OT TRC List) and time period from the overtime limit are used to resolve the Year to Date period balance.</p> <hr/> <p><b>Note:</b> If the user's row security permission list is defined to use the TL system date, the system date is treated as the current date for the purpose of calculating the balance. You define row security permission lists on the Row Security Permission List page (Set Up HCM, Security, Time and Labor Security, TL Permission List Security).</p> <hr/>
<b>Current Overtime Limit</b>	<p>This column displays symbols designating overtime limit information.</p> <p>See Building and Viewing Time Period Calendars.</p>

<b>Field or Control</b>	<b>Description</b>
Overtime Exceeded	The <b>Overtime Exceeded</b> icon appears if the maximum number of overtime hours allowed for the current period according to the overtime limit definition is exceeded.
Overtime Error	The <b>Overtime Error</b> icon appears if the system cannot resolve the time period for the overtime request because the time period for the overtime limit found on the employee's workgroup is not built for the current period. Once you build the time period, the system can display the balances.

## Approve Overtime Requests - Select an Employee Request Page

Use the Approve Overtime Requests - Select an Employee Request page (TL\_OT\_MNGR\_LIST) to approve, deny, or push back employees' overtime requests.

You can approve, deny, or push back multiple requests at the same time.

Navigation:

**Manager Self Service > Time Management > Approve Time and Exceptions > Approve Overtime Requests > Approve Overtime Requests**

This example illustrates the fields and controls on the Approve Overtime Requests - Select an Employee Request page. You can find definitions for the fields and controls later on this page.

Approve Overtime Requests  
Select an Employee Request

Employee Selection

Employee Overtime Requests ? Personalize | Find | First 1-2 of 2 Last

Select	Last Name	First Name	Employee ID	Empl Record	Date On Request	Request Status	Requested OT Hours	Actual OT Hours in Period	Projected OT Hours in Period
<input type="checkbox"/>	Espinosa	Carmichael	KU0015		03/18/2014	Needs Approval	1.00		
<input type="checkbox"/>	Espinosa	Carmichael	KU0015		03/19/2014	Needs Approval	2.00		

Approval ?

Select All Deselect All Approve Deny Push Back

To approve, deny, or push back requests:

- Identify the requests to approve, deny, or push back:
  - Select the check box next to the requests, or
  - Click the **Select All** button to select all unapproved requests.

2. Click the **Approve Selected**, **Deny Selected**, or **Push Back Selected** button.

<i>Field or Control</i>	<i>Description</i>
<b>Overtime Exceeded</b>	The <b>Overtime Exceeded</b> button appears in this field when an employee has already exceeded the overtime limits for the period of the request or will exceed the limit if the request is approved.
<b>Overtime Error</b>	The <b>Overtime Error</b> button appears here if the system cannot resolve the time period for the overtime request because the time period for the overtime limit found on the employee's workgroup is not built for the current period. After you build the time period, the system can display the balances.
<b>Date on Request</b>	The date for which overtime is requested. Click a date to access the Overtime Request Details page, where you can approve or deny the request.
<b>Requested OT Hours</b> (requested overtime hours)	The number of overtime hours the employee is requesting.
<b>Actual OT Hours in Period</b> (actual overtime hours in period)	<p>The number of overtime hours reported for this period—up to and including hours reported for the overtime request date—that have been converted to payable time. (Reported time is converted to payable time by the Time Administration process.)</p> <p>For example, assume the following:</p> <ul style="list-style-type: none"> <li>• The current time reporting period is July 8 to 14.</li> <li>• Overtime hours in payable time are: July 8 is 5 hours and July 9 is 5 hours.</li> <li>• Requested overtime hours is 5 for July 9.</li> <li>• Actual overtime hours in period is 10.</li> </ul>
<b>Projected OT Hours in Period</b> (projected overtime hours in period)	<p>The sum of the Requested Overtime Hours and the Actual Overtime Hours in Period where Requested Hours does not equal Actual Hours Worked. See the following examples for more information about Projected Overtime Hours calculations.</p> <p>See <a href="#">Understanding the Time Administration Process Flow</a></p>

### Examples: Projected Overtime Hours Calculations

These examples illustrate various scenarios for Projected Overtime Calculations based on variations in requested and actual overtime hours and period definitions.

Example 1: Requested overtime hours with no actual overtime hours in the period.

- Overtime limit = 8 hours per PSMONTH Time Period.

- Current month = March 2002.
- Month for overtime requests = March 2002.

<b>Name</b>	<b>Overtime Date</b>	<b>Requested OT Hours</b>	<b>Actual OT Hours in Period</b>	<b>Projected OT Hours in Period</b>
Mary Agar	3/20/02	8	0	8
Mary Agar	3/21/02	8	0	16
Mary Agar	5/5/02	8	0	8

Example 2: Actual overtime hours in payable time that match hours requested for overtime.

- Overtime Limit = 8 hours per PSMONTH Time Period.
- Current month = March 2002.
- Month for overtime requests = March 2002.

<b>Name</b>	<b>Overtime Date</b>	<b>Requested OT Hours</b>	<b>Actual OT Hours in Period</b>	<b>Projected OT Hours in Period</b>
Mary Agar	3/1/02	8	0	8
Mary Agar	3/5/02	12	0	20
Mary Agar	3/9/02	5	8	25
Mary Agar	3/12/02	8	8	33
Mary Agar	3/17/02	7	20	40

---

**Note:** The system does not count the 20 hours of actual overtime hours in payable time because they were already requested on March 1, 2002 and March 5, 2002.

---

Example 3: Requested overtime hours and actual overtime hours in payable time that do not match requested overtime hours.

- Current month = March 2002.
- Month for overtime requests = March 2002.



<b>Name</b>	<b>Overtime Date</b>	<b>Requested OT Hours</b>	<b>Actual OT Hours in Period</b>	<b>Projected OT Hours in Period</b>
Mary Agar	3/01/02	8	0	8
Mary Agar	3/02/02	8	4	20
Mary Agar	3/10/02	8	8 (4 hrs from 3/2 & 4 hrs from 3/10/02)	32

**Note:** The system adds the actual overtime hours to the projected overtime hours if they do not match requested overtime hours.

Example 4: Requested overtime hours and additional actual overtime hours generated from rules, as well as actual overtime hours that match requested overtime hours.

- Current month = March 2002.
- Month for overtime requests = March 2002.

<b>Name</b>	<b>Overtime Date</b>	<b>Requested OT Hours</b>	<b>Actual OT Hours in Period</b>	<b>Projected OT Hours in Period</b>
Mary Agar	3/01/02	8	0	8
Mary Agar	3/02/02	8	8	16
Line not shown on page, overtime hours generated in payable time from rules.	3/04/02		16	24
Mary Agar	3/10/02	8	16	32

**Note:** On March 4, 2002, there were eight hours of overtime generated from rules, that were not requested. These are added to the projected overtime hours behind the scenes because there is no overtime request for this date. The Time Administration process has not yet been run for March 10, 2002.

## Approve Employee Overtime – Overtime Request Details Page

Use the Approve Employee Overtime – Overtime Request Details page (TL\_OT\_APPR) to approve or deny a single overtime request.

You can also add comments that the employee can see.

Navigation:

- Click the **Last Name** link of the overtime request on the Approve Overtime Requests - Select an Employee Request Page.
- Click the link provided in an email or through the worklist.

This example illustrates the fields and controls on the Approve Employee Overtime – Overtime Request Details page. You can find definitions for the fields and controls later on this page.

[Approve Employee Overtime](#)

### Overtime Request Details

**Carmichael Espinosa** Employee ID KU0015  
Consultant-Senior Empl Record 0

**Overtime Information**

Date On Request 03/18/2014 Date Submitted 03/18/2014  
 Overtime Hours 1.00  
 Request Status Needs Approval

Approval Details				
Role Name	Name	Request Status	Trans Date	Comment
Originator	Carmichael Espinosa	Needs Approval	03/18/2014	Submitted.

Comment

#### By SupervisorID

▼ **Overtime Request Approval for 2014-03-18:Pending** [View/Hide Comments](#)

Route to Supervisor

Pending

Marc Kessler  
TLBySupervisorID

▶ **Comments**

Approve
Deny
PushBack

This page is the same as the Overtime Request Details (view) page, but contains these additional fields:

<i>Field or Control</i>	<i>Description</i>
<b>Comment</b>	Explain why the request is being approved, denied, or pushed back. The information you enter here appears on the employee's Overtime Request Details page.
<b>Approve</b>	Click to approve the request.
<b>Deny</b>	Click to deny the request.

<b><i>Field or Control</i></b>	<b><i>Description</i></b>
<b>Push Back</b>	Click to push back the request.
<b>View All Overtime Requests</b>	This link takes you to a listing of all overtime requests for the employee as a reference. Use <b>Cancel</b> to return to the individual request to approve or deny.



# Using Manager Self-Service for Scheduling Components

---

## Understanding Manager Self-Service for Scheduling Components

The Manager Self-Service for Scheduling components enable managers to assign, view, change, and override work schedules (SCH\_MNG\_PERIOD).

In addition to viewing coverage, assigned shifts, and total work hours, managers can identify individuals with planned absences or training, holidays, and no shows (those employees who have not reported in for a scheduled punch shift). The manager can also view employees with multiple shifts in a day, those who have shifts that span midnight, and those which have changing task elements over a shift.

If updates need to be made to the schedule, managers can schedule replacements, swap shifts, copy schedules, and make short- and long-term schedule changes.

A generic interface to the open scheduling architecture can be accessed to load optimized work schedules or data from other systems, including training data from Learning Management.

Employees can update their schedule preferences, such as preferred contact information for schedule updates (phone or email), willingness to work a compressed work week, and daily shift preferences. When a manager wants to replace, swap, or copy a schedule, the employee preferences can be viewed to determine the best available replacement or schedule.

Time reporters are in a static or dynamic groups to which a manager has access or a manager has access to time reporter data through HCM data permission security. Managers are restricted from viewing and changing their own data on these pages:

- Manage Exceptions page
- Approve Payable Time and Approve Reported Time pages
- Manage Schedules page
- Manager Calendar Views page

---

## Setting Up Manager Search Options

This section discusses how to set up manager search options that are common to all self-service pages that managers access.

## Page Used to Set Up Manager Search Options

<i>Page Name</i>	<i>Definition Name</i>	<i>Usage</i>
<u>Manager Search Options - Select Default Criteria and Options Page</u>	TL_MSS_SRCH_OPTION	Set up preferences and display options for viewing employees. Enter the employee selection criteria you want to use when searching for employees. This search information will be the default for manager self service pages where there is an Employee Selection Criteria option. A partial value may be entered in any search field to get a list of employees with similar values.

### Manager Search Options - Select Default Criteria and Options Page

Use the Manager Search Options - Select Default Criteria and Options page (TL\_MSS\_SRCH\_OPTION) to set up preferences and display options for viewing employees.

The Manager Search Options page allows each manager to specify criteria and display options for searching employees. If a manager does not save the Options page, then the search options defaults from the Manager Search Defaults page included in the Time and Labor Installation process.

Enter the employee selection criteria you want to use when searching for employees. The search information is used as the default for manager self service pages where there is an Employee Selection Criteria option. A partial value may be entered in any search field to get a list of employees with similar values.

Navigation:

**Manager Self Service > Time Management > Manager Search Options > Manager Search Options**

This example illustrates the fields and controls on the Manager Search Options page (1 of 2). You can find definitions for the fields and controls later on this page.

**Manager Search Options**

**Select Default Criteria and Options**

Betty Locherty

<p><b>Loading of Matching Employees</b></p> <p><input type="radio"/> Auto Populate Results</p> <p><input checked="" type="radio"/> Prompt for Results</p>	<p><b>Default Criteria Presentation</b></p> <p><input type="radio"/> Show Criteria List Collapsed</p> <p><input checked="" type="radio"/> Show Criteria List Expanded</p>
---	---

Show Schedule Information

**Employee Selection Criteria** ?

Description	Selection Criterion Value	Include in Criteria	*Include in List
Time Reporter Group	<input type="text"/>	<input checked="" type="checkbox"/>	Do Not Include
Employee ID	<input type="text"/>	<input checked="" type="checkbox"/>	Include
Empl Record	<input type="text"/>	<input checked="" type="checkbox"/>	Include
Last Name	<input type="text"/>	<input checked="" type="checkbox"/>	Include
First Name	<input type="text"/>	<input checked="" type="checkbox"/>	Include
Business Unit	<input type="text"/>	<input checked="" type="checkbox"/>	Include Code Only
Job Code	<input type="text"/>	<input checked="" type="checkbox"/>	Include Code and Description

This example illustrates the fields and controls on the Manager Search Options page (2 of 2). You can find definitions for the fields and controls later on this page.

Job Description	<input type="text"/>	<input checked="" type="checkbox"/>	
Department	<input type="text"/>	<input checked="" type="checkbox"/>	Include Description Only
Supervisor ID	<input type="text"/>	<input checked="" type="checkbox"/>	Include Code Only
Reports To Position Number	<input type="text"/>	<input checked="" type="checkbox"/>	Include Code Only
Location Code	<input type="text"/>	<input checked="" type="checkbox"/>	Include Code Only
Company	<input type="text"/>	<input checked="" type="checkbox"/>	Include Code Only
North American Pay Group	<input type="text"/>	<input checked="" type="checkbox"/>	Include Code Only
Global Payroll Pay Group	<input type="text"/>	<input checked="" type="checkbox"/>	Include Code Only

This page allows each manager to specify criteria and display options for searching employees. The search information is used as the default for manager self service pages where there is an Employee Selection Criteria option. If a manager does not save the Options page, then the search options defaults from the Manager Search Defaults page included in the Time and Labor Installation process.

<b>Field or Control</b>	<b>Description</b>
Value	If the <b>Include in Criteria</b> field is selected for a particular row, make an entry, if required, in the <b>Value</b> field to use as default search criteria.

<b>Field or Control</b>	<b>Description</b>
Include in Criteria	<p>This field is used to denote whether the field is displayed as part of the criteria that can be searched on.</p> <hr/> <p><b>Note:</b> Only select <b>Workgroup</b> or <b>Taskgroup</b> if Time and Labor is installed, and you are looking for employees that are enrolled in Time and Labor.</p>
Include in List	<p>This field is used to determine if the field is displayed in the employees grid.</p> <hr/> <p><b>Note:</b> Only select <b>Workgroup</b> or <b>Taskgroup</b> if Time and Labor is installed, and you are looking for employees that are enrolled in Time and Labor.</p>
Auto Populate Option, Criteria Defaults	<p>These fields work in conjunction with each other. With <b>AutoPopulate Results</b> selected and <b>Collapse Criteria</b> selected, the grid auto populates based on the criteria and the criteria is collapsed. With <b>AutoPopulate Results</b> selected and <b>Expand Criteria</b> selected, the grid auto populates based upon the criteria and the criteria is expanded. With <b>Prompt for Results</b> selected and <b>Collapse Criteria</b> selected, the grid does not auto populate. Instead, click the <b>Get Employees</b> button to populate the employee grid; the criteria is collapsed. With <b>Prompt for Results</b> selected and <b>Expand Criteria</b> selected, the grid does not auto populate. Instead, click the <b>Get Employees</b> button to populate the employee grid; the criteria is expanded.</p>

---

**Note:** If you are entering values in the fields: **Location, Job Code, Job Title, or Department**, enter an HR Business Unit value to derive the SETID for these other fields. If you do not enter a Business Unit, the system derives the HR Business Unit from your Job Data to determine the default SETID for these values.

---

See [Manager Search Defaults Page](#).

### Data Loading in Time Management

In this region, enter the maximum number of rows that you would like the Employee search to load. Due to the complexity of the underlying data some of the search and summary pages are process intensive. The number entered controls the initial number of rows, or *chunk* uploaded, and the rows added with each incremental upload.

---

## Assigning Schedules

This section discusses how to assign a schedule to a time reporter.

---

**Note:** Employees with a future hire or rehire date will also be available for schedule assignment.

---



Both administrators and managers can set work schedules for existing employees as well as those who are hired or rehired in the future.

## Pages Used to Assign Schedules

<b>Page Name</b>	<b>Definition Name</b>	<b>Usage</b>
<a href="#">Assign Work Schedule Page</a>	SCH_ASSIGN	Assign a time reporter to a schedule.
<a href="#">Personal Schedule Definition Page</a>	SCH_DEFINITION	Create a personal schedule for a time reporter.
<a href="#">Schedule Shifts Page</a>	SCH_DEFINITION_2	Enter shift details for a personal schedule definition.
<a href="#">Schedule Calendar Page</a>	SCH_CALENDAR	Display the schedule, change the date or view the previous and next periods of the schedule.
<a href="#">Schedule Calendar Rotations Page</a>	SCH_CLND_ROTATN	Compare rotations to analyze the patterns for each rotation.

## Assign Work Schedule Page

Use the Assign Work Schedule page (SCH\_ASSIGN) to assign a time reporter to a schedule.

Navigation:

**Manager Self Service > Time Management > Manage Schedules > Assign Work Schedule > Assign Work Schedule**

This example illustrates the fields and controls on the Assign Work Schedule page. You can find definitions for the fields and controls later on this page.

**Assign Work Schedule**

Sandra Pierce <sup>▼</sup>  
Analyst-HRMS

Employee ID K0W201  
Employment Record 0

Assign Schedules <sup>?</sup> Personalize | Find | View All | <sup>⌂</sup> | <sup>📄</sup> First 1-3 of 3 Last

Effective Date	Assignment Method	Schedule Group	Schedule ID	Description	Rotation ID	Show Schedule
03/19/2014 <sup>📅</sup>	Select Predefined Schedule <sup>▼</sup>	K0CYM <sup>🔍</sup>	KUROTATE28 <sup>🔍</sup>	28 Day Schedule	MORNING <sup>▼</sup>	Show Schedule <sup>+</sup> <sup>-</sup>
03/19/2014 <sup>📅</sup>	Create Personal Schedule <sup>▼</sup>	K0CYM <sup>🔍</sup>	K0W2010000 <sup>🔍</sup>	Optional Weekend Schedule		Show Schedule <sup>+</sup> <sup>-</sup>
01/01/2000 <sup>📅</sup>	Use Default Schedule <sup>▼</sup>	K0CYM	K0WRKSCH	K0WRKSCH		Show Schedule <sup>+</sup> <sup>-</sup>

<sup>▶</sup> View history of Schedule Assignments, including default changes

The system displays the time reporter's name, ID, employee record number, and job title.

<b>Field or Control</b>	<b>Description</b>
Click for Instructions	The Click for Instructions link expands to show instructional text on using the page.
Click to Hide Instructions	Click this link to collapse the instructional text that displayed when the Click for Instructions link was selected.
<b>Assignment Method</b>	<p>Select <i>Create Personal Schedule</i>, <i>Select Predefined Schedule</i> and <i>Use Default Schedule</i>.</p> <p>When selected, the <i>Create Personal Schedule</i> value allows you to create a effective dated personal schedule for this employee. A <b>Create Schedule</b> link is displayed on the right side of the grid. In addition, you can select a Schedule Group for the employee. The Schedule ID is automatically populated with the EmplID, Employee Record Number and three additional digits.</p> <p>The <i>Select Predefined Schedule</i> value enables you to select a Schedule Group and an associated Schedule ID.</p> <p>The <i>Use Default Schedule</i> value derives a default schedule for the time reporter. For Global Payroll, the schedule defaults from the Global Payroll pay group assigned to an employee (from the JOB Data record). For Time and Labor employees that are not in Global Payroll, the schedule defaults from the workgroup assigned to employees on the Maintain Time Reporter Data page when they are enrolled in Time and Labor. If no row is displayed for schedule assignment, the schedule resolution process still resolves the default schedule on the Global Payroll pay group assigned to an employee, or the default schedule on the employee's workgroup if not enrolled in a Global Payroll pay group.</p>
<b>Schedule Group</b>	Schedule Groups are used to group employees with like schedules. A <b>Schedule Group</b> must be entered. For default schedules, both the workgroup and Global Payroll pay groups have Schedule Groups associated with a Schedule ID. The Schedule Group is associated with a SetID, so only valid schedules for a particular SetID that is associated to an employee are displayed.

<b>Field or Control</b>	<b>Description</b>
Star icon	<p>A star icon appears in the Assign Schedules group box, when you assign an employee a default schedule from either a Time and Labor workgroup or a Global Payroll pay group, and the default schedule has changed over time. This default assignment can occur manually, or as a result of an employee hire triggering the Workforce Sync message to insert a default assignment row in Assign Work Schedule.</p> <p>The Assign Schedules group box displays the <b>Schedule ID</b> that is most current at the time, from the workgroup or pay group, despite the schedule assignment effective date. The display of this <b>Schedule ID</b> assists in determining which schedule the system is currently using for schedule resolution. The display of the star icon alerts you to review the History of Schedule Assignments, Including Default Changes section to determine what the schedule changes are from the initial schedule assignment to the current date.</p>
Rotation ID	<p>If the schedule assigned to an employee is a rotating schedule, the Rotation ID field will be displayed next to the Schedule. The Rotation ID is used to determine what relative day in the schedule an employee should be assigned to.</p>
Show Schedule	<p>The Show Schedule link will take the user to the derived Schedule Calendar that can be viewed as of the effective date of the schedule assignment.</p>
View history of Schedule Assignments, including default changes	<p>Click this link to expand the section to show all of the schedule assignments, including what default schedules may have changed either on a Global Payroll pay group or Time and Labor workgroup, if the user has a default schedule assigned.</p>

This example illustrates the error message when the schedule assigned is not within the Schedule Change Limit specified in Installation pages.

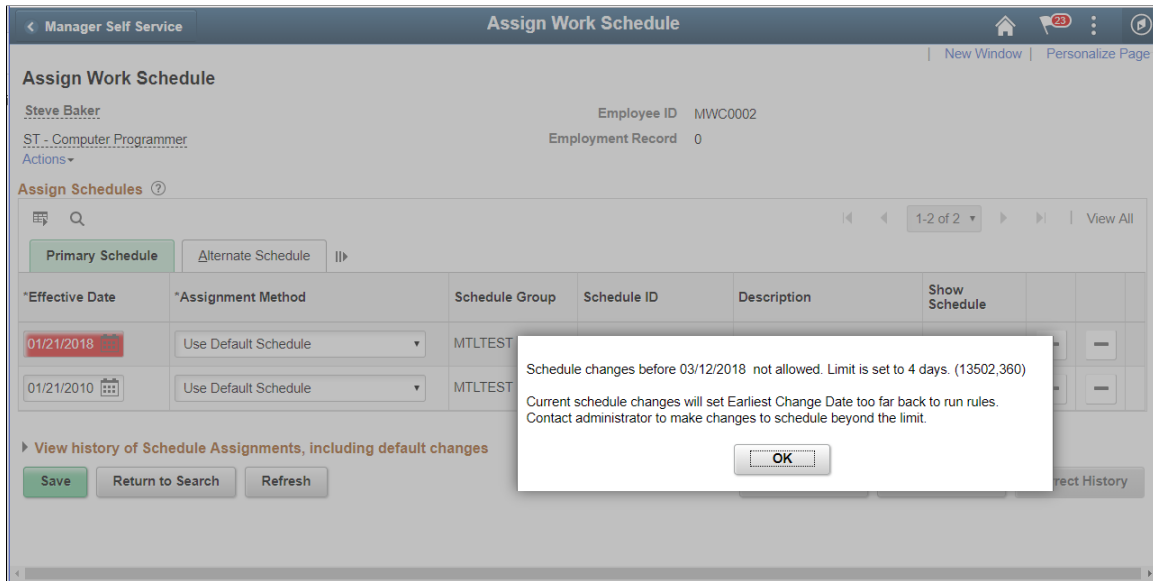

The Effective Date selected should be within the limit specified under the Schedule Change Limit in the Installation pages.

## Related Links

[Assign Schedule to a Group Page](#)

[Understanding Work Schedules](#)

## Personal Schedule Definition Page

Use the Personal Schedule Definition page (SCH\_DEFINITION) to create a personal schedule for a time reporter.

Navigation:

**Manager Self Service > Time Management > Manage Schedules > Assign Work Schedule.**

Select the Create Personal Schedule value in the Assignment Method field. Click the Create Schedule link.

This example illustrates the fields and controls on the Personal Schedule Definition page. You can find definitions for the fields and controls later on this page.

The screenshot shows a web form titled "Definition" with a sub-tab "Schedule Shifts". The user is identified as Sandra Pierce, with Empl ID K0W201 and Job Title Analyst-HRMS. The form includes a "Schedule Details" section with fields for Effective Date, Description, Definition Type, Daylight Saving Rule, Short Description, and Days in Schedule. Below this is a "Taskgroup for Time Reporting" section with fields for Default Taskgroup, Task Template ID, and Time Reporting Template ID.

<b>Field or Control</b>	<b>Description</b>
<b>Description</b>	Enter a description for this personal schedule.
<b>Definition Type</b>	Options are <i>Punch</i> , <i>Elapsed</i> , and <i>Flex</i> . See <a href="#">Creating Work Schedules and Schedule Definitions</a> .
Num Days in Schedule	Enter the number of days in this schedule pattern.
<b>Daylight Savings Rule</b>	Options are <i>Fixed Time</i> and <i>Fixed Duration</i> . The Daylight Savings Rule is relevant for punch or flex schedules. This determines when a schedule is resolved on a daylight savings day, whether the end time of the shift should remain fixed, or the number of scheduled hours (duration) should remain fixed.
<b>Default Taskgroup</b>	Enter a default Taskgroup to schedule task elements or time reporting elements with this schedule
<b>Task Template ID</b>	This value is derived from the entry in the Default Taskgroup field.
<b>Time Reporting Template ID</b>	This value is derived from the entry in the <b>Default Taskgroup</b> field and also depends on the selection in the <b>Definition Type</b> field. You can change the value in this field if the one that is derived does not provide the required time reporting elements.

Click the links for the **Task Template** and **Time Reporting Template ID** to view the templates for reference.

**Note:** Rotations cannot be defined for personal schedules as they are only used by a single employee.

## Schedule Shifts Page

Use the Schedule Shifts page (SCH\_DEFINITION\_2 ) to enter shift details for a personal schedule definition.

Navigation:

**Manager Self Service > Time Management > Manage Schedules > Assign Work Schedule** Select the Create Personal Schedule value in the Assignment Method field. Click the Create Schedule link, Schedule Shifts.

This example illustrates the fields and controls on the Schedule Shifts page. You can find definitions for the fields and controls later on this page.

<b>Field or Control</b>	<b>Description</b>
<b>More</b>	Click a link in this column to open the Shift page.  See: <a href="#">Shift Page</a>

## Schedule Calendar Page

Use the Schedule Calendar page (SCH\_CALENDAR) to display the schedule, change the date or view the previous and next periods of the schedule.

Navigation:

**Manager Self Service > Time Management > Manage Schedules > Assign Work Schedule > Click the Show Calendar link on the Schedule Shifts page.**

This example illustrates the fields and controls on the Schedule Calendar page. You can find definitions for the fields and controls later on this page.

[Help](#)

Employee ID K0W201  
 Employment Record Nbr 0  
 Schedule Group K0CYM GP Core Schedule Group  
 Schedule ID K0W20100000 Optional Weekend Schedule

Workgroup K0WAM2PNA Absence Management to PNA

---

From Date   Previous Period Next Period

Schedule Calendar Personalize | Find |  |  | First 1-7 of 7 Last

Shift Time	Configurable Totals												
Day	Date	DUR	Workday ID	Shift ID	In	Lunch	In	Out	Time Zone	Sched Hrs	Shift Detail	Shift has changing elements	
	Wednesday	03/19/2014		KU8HRS	K08HRS	8:00:00AM	12:00:00PM	1:00:00PM	5:00:00PM	PST	8.00	<a href="#">Shift Detail</a>	
	Thursday	03/20/2014		KU8HRS	K08HRS	8:00:00AM	12:00:00PM	1:00:00PM	5:00:00PM	PST	8.00	<a href="#">Shift Detail</a>	
	Friday	03/21/2014		KU8HRS	K08HRS	8:00:00AM	12:00:00PM	1:00:00PM	5:00:00PM	PST	8.00	<a href="#">Shift Detail</a>	
	Saturday	03/22/2014			OFF								
	Sunday	03/23/2014			OFF								
	Monday	03/24/2014		KU8HRS	K08HRS	8:00:00AM	12:00:00PM	1:00:00PM	5:00:00PM	PST	8.00	<a href="#">Shift Detail</a>	
	Tuesday	03/25/2014		KU8HRS	K08HRS	8:00:00AM	12:00:00PM	1:00:00PM	5:00:00PM	PST	8.00	<a href="#">Shift Detail</a>	

<b>Field or Control</b>	<b>Description</b>
From Date	Enter date or period to change the schedule calendar view.
Load Calendar	Click this button to display the schedule for a period based on the entry in the <b>From Date</b> field.

There is no process to build the schedule calendar. It is derived from the schedule definition pattern and the Time and Labor Dates table.

The Schedule Calendar page lists all of the elements associated to the schedule. The page also resolves the actual "day" associated with the dates of the schedule.

If it is a punch schedule, all of the punch types associated with the punch schedule will be displayed across the top of the page. If the punch types pattern varies from one shift to another, then the page will use the "all punch" pattern, to display all of the punches found in the PSPCHNONE time reporting template.

The DUR column is for use when Time and Labor is installed, it determines the daybreaker of the workgroup associated with the employee, and displays if the scheduled shift or time will fall on the actual day displayed (0 — zero) or the day before (-1) or the next day (+1).

If the schedule is a rotating schedule, then the Compare Rotations link displays where the user can compare rotations.

---

**Note:** If a user sets up a Shift or Schedule Definition that spans more than 24 hours, the shift displays the begin date of when the shift began.

---

## Schedule Calendar Rotations Page

Use the Schedule Calendar Rotations page (SCH\_CLND\_ROTATN) to compare rotations to analyze the patterns for each rotation.

Navigation:

Click the **Compare Rotations** link on a saved Schedule Calendar page.

This example illustrates the fields and controls on the Schedule Calendar Rotations page. You can find definitions for the fields and controls later on this page.

The screenshot shows the 'Schedule Calendar Rotations' page. At the top, it displays the following information:

- Employee ID: K0W201
- Schedule Group: K0CYM (GP Core Schedule Group)
- Schedule ID: KURotate28 (28 Day Schedule)

Below this is a 'Refresh' button and a 'From Date' field set to 03/19/2014. There are also buttons for 'Load Rotations', 'Previous Period', and 'Next Period'. A dropdown menu is set to 'Select Rotations to display'.

The main section is titled 'Rotation Details' and includes a table with the following columns: Day, Date, AFTERNOON, MIXED, MORNING, and NIGHT. The table shows a 28-day rotation pattern starting from 03/19/2014.

Day	Date	AFTERNOON	MIXED	MORNING	NIGHT
Wednesday	03/19/2014	KUMORN	KUNIGHT	KUAFTNOON	KUAFTNOON
Thursday	03/20/2014	KUMORN	KUNIGHT	KUNIGHT	KUAFTNOON
Friday	03/21/2014	KUMORN	KUNIGHT	KUNIGHT	KUAFTNOON
Saturday	03/22/2014	OFF	OFF	OFF	OFF
Sunday	03/23/2014	OFF	OFF	OFF	OFF
Monday	03/24/2014	KUAFTNOON	KUAFTNOON	KUMORN	KUNIGHT
Tuesday	03/25/2014	KUAFTNOON	KUAFTNOON	KUMORN	KUNIGHT
Wednesday	03/26/2014	KUAFTNOON	KUAFTNOON	KUMORN	KUNIGHT
Thursday	03/27/2014	KUAFTNOON	KUNIGHT	KUMORN	KUNIGHT
Friday	03/28/2014	KUAFTNOON	KUNIGHT	KUMORN	KUNIGHT
Saturday	03/29/2014	OFF	OFF	OFF	OFF
Sunday	03/30/2014	OFF	OFF	OFF	OFF
Monday	03/31/2014	KUNIGHT	KUMORN	KUAFTNOON	KUAFTNOON
Tuesday	04/01/2014	KUNIGHT	KUMORN	KUAFTNOON	KUAFTNOON
Wednesday	04/02/2014	KUNIGHT	KUMORN	KUAFTNOON	KUAFTNOON

This page enables you to compare the rotations that you select to analyze the patterns for each rotation as of the effective date of the schedule assignment. You can change the date or period to view the schedule pattern in a different time period. The schedule pattern displayed is the length of the actual schedule. If the schedule is 28 days in length, that is the actual pattern that is displayed in the Schedule Calendar.

The **Rotations Details** region offers the user all of the Rotations associated to the Schedule. The user can choose which rotations to compare in the schedule calendar display. All **Rotation IDs** are selected by default.



## Managing Schedules

This section discusses how to manage schedules.

### Pages Used to Manage Schedules

<b>Page Name</b>	<b>Definition Name</b>	<b>Usage</b>
Manager Search Options Page	TL_MSS_SRCH_OPTION	Set up preferences and display options for viewing employees. Enter the employee selection criteria you want to use when searching for employees. This search information will be the default for manager self service pages where there is an Employee Selection Criteria option. A partial value may be entered in any search field to get a list of employees with similar values.
<u>Manage Schedules Options Page</u>	SCH_MNG_OPTIONS	Set up preferences and display options for viewing schedules.
Schedule Preferences Page	SCH_EE_PREF	View an employee's contact and schedule preferences.
Daily Schedules, Weekly Schedules, Date Range Schedules Page	SCH_MNG_DAILY SCH_MNG_WEEKLY SCH_MNG_DRANGE	Adjust a time reporter's schedule.
Daily Detail Page	SCH_MNG_DAILY_DTL	Override a schedule, refresh or add a schedule for the day, or enter a new schedule for the day.
<u>Schedule Replacements Page</u>	SCH_MNG_REPLACE	Schedule a replacement for an employee for a day.
<u>Copy Schedules Page</u>	SCH_MNG_COPY	Copy an employee schedule to be used by another employee for a day or specified date range.
<u>Swap Schedules Page</u>	SCH_MNG_SWAP	Swap two employees' schedules.

<b>Page Name</b>	<b>Definition Name</b>	<b>Usage</b>
Scheduled Hours Page	TL_SCHRPT_RNCTL	Generate TL004 that provides information about a time reporter's scheduled time. It gives details such as: punch types and times for employees with a punch schedule; duration of work hours for employees with an elapsed schedule; and the values for the In, Out, Flex, and Core Period fields for time reporters with flex schedules.

## Common Elements Used in This Section

<b>Field or Control</b>	<b>Description</b>
<b>Date Fields and Link Names</b>	<p>If <i>Day</i> is selected in the <b>View By</b> field, enter or click the <b>Previous</b> or <b>Next Day</b> links to change the Date value. For Punch type employees, a bar in the Employee grid indicates the start time and end time of a shift.</p> <p>If <i>Week</i> is selected in the <b>View By</b> field, enter or click the <b>Previous</b> or Next Week links to change the Week Of value. The <b>Total Scheduled Hours</b> link with Start time and End time is displayed in the Employee grid.</p> <p>If <i>Date Range</i> is selected in the <b>View By</b> field, enter or click the <b>Previous</b> or <b>Next Range</b> links to change the Start Date, End Date, or both values. The maximum number of days a date range can span is 31. The <b>Total Scheduled Hours</b> link with Start time and End time is displayed in the Employee grid.</p>

## Manage Schedules Options Page

Use the Manage Schedule Options page (SCH\_MNG\_OPTIONS) to set up preferences and display options for viewing schedules.

Navigation:

**Manager Self Service > Time Management > Manage Schedules > Manage Schedules**

Scroll down and click the Schedule Display Options link (The page opens in a new window).

This example illustrates the fields and controls on the Manage Schedules Options page. You can find definitions for the fields and controls later on this page.





### Manage Schedule Options

Start Day for Weekly Grid

Default Display View

Maximum Rows Displayed

**Schedule Categories**

Select	Symbol
<input checked="" type="checkbox"/> Approved Training	
<input checked="" type="checkbox"/> Planned Absence	
<input checked="" type="checkbox"/> Holiday	
<input checked="" type="checkbox"/> No Show	

**Weekly/Date Range Options**

Select one option for display on Weekly and Date Range Pages

Task Data Task Element

Time Reporting Elements Time Element

Use this page to set defaults for the Manage Schedules pages.

<b>Field or Control</b>	<b>Description</b>
Start Day for Weekly Grid	Select a day of the week that a schedule should be displayed.
Default Display View	Select the default display view that the Manage Schedule page should use when entering the page. Select the <i>Day</i> value for the default Daily Schedules page (SCH_MNG_DAILY), the <i>Week</i> value for the default Weekly Schedules page (SCH_MNG_WEEKLY), and the <i>Date Range</i> value for the default Date Range Schedules page (SCH_MNG_DRANGE).
Maximum Rows Displayed	This field is display only and displays a maximum of ten employees at a time.

<b>Field or Control</b>	<b>Description</b>
Schedule Categories	<p>Select the Schedule Category values to display the respective icons on the Employee grid on the Manage Schedules pages. A legend also appears on the Manage Schedules pages with a description of each category and icon.</p> <p>Values are <i>Approved Training</i>, <i>Planned Absence</i>, <i>Holiday</i> and <i>No Shows</i>.</p> <hr/> <p><b>Note:</b> The <i>No Shows</i> value only displays for the Daily Schedules page. <i>No Shows</i> information is stored, so any <i>No Shows</i> information from the past can be viewed.</p> <hr/>
Weekly/Date Range Options	<p>Choose one value to display on the Weekly and Date Range pages. Values are <i>Task Data</i> and <i>Time Reporting Elements</i>. If using the <i>Task Data</i> and <i>Time Reporting Elements</i>, select a field value for each from the drop-down list box. From the <i>Task Data</i> drop-down list, the values are: <i>Activity ID</i>, <i>Business Unit</i>, <i>Combination Code</i>, <i>Customer</i>, <i>Department</i>, <i>Job Code</i>, <i>Location Code</i>, <i>PC Business Unit</i>, <i>Performance Measurement Business Unit</i>, <i>Position Number</i>, <i>Product</i>, <i>Project/Grant</i>, <i>Resource Category</i>, <i>Resource SubCategory</i>, <i>Resource Type</i>, <i>Task Profile ID</i>, <i>User Field 1 – 4</i>. From the <i>Time Reporting Elements</i> drop-down list, the values are: <i>Country</i>, <i>State</i>, <i>Locality</i>, <i>TRC</i>, <i>Billable Indicator</i>.</p>

**Note:** By choosing a value from Task Data or Time Reporting Elements, the employee who is scheduled with this value, appears in the daily cell of Manage Schedules for that day. If there are changing elements throughout the day, there will be an icon representing any changing elements in the shift. This is an indicator to the user that they can drill down into the Schedule Daily Detail page for more information on the daily changes.

**Note:** In order for all of the schedule category icons and other options to be displayed to the user, the user must ensure that they save this page, in order to save the options.

## Manage Schedule Options Page

Use the Manage Schedule Options page (TL\_MSS\_SRCH\_OPTION) to set up preferences and display options for viewing employees.

Enter the employee selection criteria you want to use when searching for employees. This search information will be the default for manager self service pages where there is an Employee Selection Criteria option. A partial value may be entered in any search field to get a list of employees with similar values.

Navigation:

**Manager Self Service > Time Management > Manager Search Options**

This example illustrates the fields and controls on the Weekly Schedules page (1 of 2). You can find definitions for the fields and controls later on this page.

This example illustrates the fields and controls on the Weekly Schedules page (2 of 2). You can find definitions for the fields and controls later on this page.

**Note:** The previous graphics do not show the entire page. Scroll to the right on your system to view all of the fields on the page.

When entering the page, the system displays either the Daily, Weekly, or Date Range Schedules pages, depending on the default set on the Manage Schedules Display Options page. This page also sets defaults that are used on the Schedule Replacements, Copy Schedules, and Swap Schedules pages, such as date fields and link names.

Enter values in Employee Selection Criteria and click the **Get Employees** button to filter the list of employees that requires changes or review.

Click the Instructions expand section to view instructions about how to use the page.

<b>Field or Control</b>	<b>Description</b>
<b>View By</b>	Select <i>Day</i> , <i>Week</i> , or <i>Date Range</i> to view the listed employees and their schedules using this option you select.

<b>Field or Control</b>	<b>Description</b>
<b>Date</b>	<p>If <i>Day</i> is selected in the <b>View By</b> field, enter or click the <b>Previous</b> or <b>Next Day</b> links to change the Date value.</p> <p>If <i>Week</i> is selected in the <b>View By</b> field, enter or click the <b>Previous</b> or <b>Next Week</b> links to change the Week Of value.</p> <p>If <i>Date Range</i> is selected in the <b>View By</b> field, enter or click the <b>Previous</b> or <b>Next Range</b> links to change the Start Date, End Date, or both values. The maximum number of days a date range can span is 31.</p>
Schedule Type	<p>Select the Schedule Type. Values are <i>Primary</i> or <i>Alternate</i>. If Global Payroll is not installed, the <b>Schedule Type</b> field is hidden and only primary schedules are shown.</p>
Schedule Group	<p>This field lists the schedule groups. Once a schedule group is entered, and the Refresh button clicked, the grid redisplay the employees associated to that schedule group (as determined from their Assign Work Schedule page).</p>
Coverage (only displayed on the Daily Schedule page)	<p>This field has values of <i>All</i>, <i>Scheduled</i> or <i>Unscheduled</i>. Select <i>All</i> to view all employees who are scheduled, not scheduled or who are scheduled as <i>Off</i>. Select <i>Scheduled</i> to view all employees who are scheduled for the day. Select <i>Unscheduled</i> to view all employees who either have no schedule or who are scheduled as <i>Off</i> for the day.</p>
Refresh	<p>Click this button to refresh the page.</p> <hr/> <p><b>Note:</b> All of the filters and buttons on the Manage Schedules pages are controlled by the <b>Refresh Schedules</b> button at the top of the page. Only the <b>View By</b> field automatically refreshes the page.</p> <hr/>

<b>Field or Control</b>	<b>Description</b>
Employee Grid	<p>Click the <b>employee name</b> link to transfer to the Schedule Preferences page. View the schedule preferences of the employee before making any scheduling changes.</p> <p>For punch employees, the scheduling information start time and end time are displayed on a bar. If there are multiple shifts, multiple shift icons appear and all start and end times appear on the bar. Click the <b>Scheduled Hours</b> link to open a new page and transfer to the Daily Detail page to override shift information.</p> <p>Click the <b>Schedule Hours</b> link to transfer to the Daily Schedule page. Hover text is used to display the schedule hours for punch and elapsed employees.</p> <p>For elapsed employees, schedule hours appear. In addition to the elapsed information, events such as Approved Training, Absence, and Holiday information appear in the Elapsed column as icons.</p> <p>Training and absences data can be from different sources (Training - Training Administration, Enterprise Learning Management: Absence- Absence Management, Reported Time), and detailed scheduling information appears on Daily Schedule Details.</p> <p>Total Schedule Hours for the day appear if the <i>Daily</i> value is specified for the <b>View By</b> field. If the Day is an Off day, no hours appear but the OFF text icon appears.</p> <p>If there are multiple shifts for a day, only the first shift information appears. An icon denotes that there is a second shift. The second shift and the details of the second shift appear on the Daily Schedule Details page. If the shift crosses midnight, an icon denotes shift continuation.</p> <p>On the <b>Day View</b> page, if an employee does not show up for a shift (known as a <i>no show</i>), the No Show icon appears.</p> <p>If an employee is replacing another employee for a shift or number of shifts, the R (Replaced Employee) icon appears.</p>

<b>Field or Control</b>	<b>Description</b>
	<p><b>Note:</b> The system uses the following logic to determine whether or not an employee has a holiday.</p> <p>First, the system checks to see if an employee has a holiday schedule specified on the Job Data record.</p> <p>If there is no holiday schedule specified on the Job Data record for an employee, the system checks the Pay System Flag on the Job Data record for a value of <i>Global Payroll</i>. The system then derives the holiday schedule from GP pay group.</p> <p>If the Pay System Flag has a value of <i>Payroll for North America</i> or <i>Payroll Interface</i> and Absence System is equal to <i>Absence Management</i>, the system will derive the holiday schedule from GP pay group.</p> <p>If the Pay System Flag is equal to <i>Payroll for North America</i> or <i>Payroll Interface</i> and Absence System is equal to <i>Other</i>, then the system will derive the holiday schedule from the Payroll for North America pay group.</p> <p>If there is no holiday schedule on the Payroll for North America pay group, the system derives the holiday schedule from the Time and Labor workgroup.</p> <p>This logic is used for the Manager Calendar Views pages (Daily, Weekly, Monthly), the Manage Schedules pages for managers, and the Monthly Schedule page for employees.</p>
<b>Replace Schedule</b>	Select one employee and click the <b>Schedule Replacements</b> button to find a replacement for this employee.
<b>Copy Schedules</b>	Select an employee and click the <b>Copy Schedules</b> button to copy a schedule based on this employee's.
<b>Swap Schedules</b>	Select two employees and click the <b>Swap Schedules</b> button to swap two employees' schedules.
<b>Legend</b>	The legend contains descriptions of the Manage Schedule icons. The icons default from the Manage Schedules Display Options page. In addition to the Schedule Categories, other icons displayed include Multiple Shifts, Scheduled OFF Day, Replaced Employee, Crossover Shift (for shifts that span midnight).

**Note:** The schedule actions of Schedule Replacements, Swap Schedules, Copy Schedules, and Override Schedules are audited.

## Schedule Detail Page

Use the Schedule Detail page (SCH\_MNG\_DAILY\_DTL) to override a schedule, refresh or add a schedule for the day, or enter a new schedule for the day.

Navigation:



**Manager Self Service > Time Management > Manage Schedules > Manage Schedules.** Click the link in the Daily Schedule Details column on the Daily Schedules page. On the Weekly Schedules and Date Range Schedules pages and then click the link in the Date column.

This example illustrates the fields and controls on the Schedule Detail page. You can find definitions for the fields and controls later on this page.

**Schedule Detail for 07/31/2009**

**AL CROW** Employee ID GXTLEE14  
Employment Record Number 0

---

**Instructions**

**Refresh Schedule**

\*Schedule Type  \*Punch Pattern  Default Taskgroup

(Existing schedule will be cleared and refreshed based on the above selections.)

---

**Primary Schedule**

**Schedule Detail**

Shift ID	Taskgroup	Off Shift	In	Meal	In	Out	Time Zone	Sched Hrs	More
GXH8HRS		<input checked="" type="checkbox"/>	8:00:00AM	12:00:00PM	1:00:00PM	5:00:00PM		8.00	More

**Alternate Schedule**  
No schedule data for today

**Training Details**  
No training data for today

**Absence Details**  
No absence data for today

**Holiday Details**  
No holiday data for today

You can override a schedule on this page by refreshing or adding an existing schedule for the day, or you can create a new schedule for the day.

<b>Field or Control</b>	<b>Description</b>
Schedule Type	Options in this field are <i>Punch</i> and <i>Elapsed</i> .
<b>Punch Pattern</b>	<p>This field is available If you selected the <i>Punch</i> option in the <b>Schedule Type</b> field. Options for this field are <i>Default</i> and <i>All Punches</i>.</p> <ul style="list-style-type: none"> <li><i>Default</i> displays punch types that are derived from the Default Punch Pattern on the Configurations tab of the Time and Labor Installation page, or on the Schedule Settings tab of the Global Payroll &amp; Absence Management Installation Settings page.</li> <li><i>All Punches</i> displays all available punch types (IN, BREAK, IN, MEAL, IN, BREAK, IN, TRANSFER, OUT) and provides more flexibility.</li> </ul> <p>See <a href="#">Time and Labor Installation Page</a>.</p>

<b>Field or Control</b>	<b>Description</b>
Default Task Group	<p>Enter a value in this field to display <i>Time Reporting Elements</i> and <i>Task Elements</i> or <i>Task Profile</i> values.</p> <p>Using a default taskgroup for the day is appropriate if you enter schedule changes without using a Shift ID. If making schedule overrides using a Shift ID, any taskgroup and task information from the Shift ID is derived and displayed in either the Primary Schedule or Alternate Schedule group boxes.</p> <p>The selection of <b>Schedule Type</b> and <b>Taskgroup</b> will derive the time reporting template used to default the display of <i>Time Reporting Elements</i> and <i>Task Elements</i> or <i>Task Profile</i> values for that taskgroup. If you defined the time reporting template to use the task template, these tabs are displayed in the <b>Primary Schedule</b> and <b>Alternate Schedule</b> group boxes.</p> <hr/> <p><b>Note:</b> The selection you enter in the <b>Schedule Type</b> and <b>Taskgroup</b> fields derive the time reporting template used to display <i>Time Reporting Elements</i> and <i>Task Elements</i> or <i>Task Profile</i> values for the taskgroup. If you defined the time reporting template to use the task template, these tabs are displayed in the <b>Primary Schedule</b> and <b>Alternate Schedule</b> group boxes, and may include Task Reporting Elements and Chartfields.</p> <hr/>
<b>More</b>	Click this link to open the Daily Detail – Shift Information page.
<b>Refresh Schedule</b>	<p>Click this button after you change the <b>Schedule Type Punch Pattern</b> or <b>Default Taskgroup</b> values for the day. This resets the day to enter a new schedule override.</p> <hr/> <p><b>Note:</b> Remember to save the page for the schedule change to be reflected in the Manage Schedules components.</p> <hr/>

This example illustrates the fields and controls for the Schedule Detail Page.

**Schedule Detail for 01/01/2018**

Steve Baker Employee ID MWC0002  
 Actions Job Title ST - Computer Programmer Employment Record Number 0

Schedule changes before 03/12/2018 not allowed. Limit is set to 4 days.  
 Current schedule changes will set Earliest Change Date too far back to run rules.  
 Contact administrator to make changes to schedule beyond the limit.

**Refresh Schedule**

Schedule Type Elapsed Punch Pattern Default Default Taskgroup  
 Refresh Schedule (Existing schedule will be cleared and refreshed based on the selections made.)

**Primary Schedule**

Shift ID	Taskgroup	Off Shift	Sched Hrs
MUELPSHF		<input type="checkbox"/>	8.00

**Alternate Schedule**  
No schedule data for today

**Training Details**  
No training data for today

**Absence Details**  
No absence data for today

**Holiday Details**  
No holiday data for today

Save  
[Return to Manage Schedules](#)  
 Notify

In this example, the Refresh Schedule will be greyed out as the schedule change limit is not within the specified period mentioned in Installation options and *Time Period ID* mentioned under *Workgroup Defaults* in *Workgroup - Definition Page*.

**Note:** The Manage Schedules component recognizes the date and time formats selected by the user under My Personalizations.

## Schedule Daily Detail and the Display of Shift ID

When you have set the appropriate SETID for an employee, the system displays the **Shift ID** field for that employee. The SETID is derived from the Schedule Group associated with the employee's predefined or default schedule assignment. The only time that a **Shift ID** field does not appear on the Daily Detail page is when:

- There is no row in Assign Work Schedule for the employee.
- There is no schedule ID defined on the employee's workgroup.

If the employee does not have a long term schedule, then the **Shift ID** field will not appear on the page. As a result, you need to enter the shift data manually for the day. Select the **Refresh Schedule** button to activate fields in the Primary Schedule and Alternate Schedule group boxes.

## Primary Schedule and Alternate Schedule

Any schedule information from a prior schedule change, or imported schedule information, or permanent work schedule is displayed in these group boxes. If no primary or alternate schedule detail exists for the day, it can be added using the **Refresh Schedule** button. You can enter a schedule override with a predefined shift which has the SetID of the employee's Schedule Group. You can also enter a schedule override that has only punch times or only scheduled hours for an elapsed schedule, without using shifts. If changing time reporting or task elements exist in a shift, the detail of the Shift can be accessed through a **More** link both on the Primary and Alternate Schedule sections. An icon representing **Shift has Changing Elements** appears for those shifts that have changing elements.

To enter an off shift, you can choose a predefined shift that has the **Off Shift** check box activated. If you are not using shifts, you can enter either elapsed hours with an **Off Shift** check box activated or an IN and OUT time with an **Off Shift** check box activated. The **Off Shift** check box determines that the **Scheduled Hours** are zero, it does not change the duration of the off shift.

Multiple shifts can be entered as a schedule override for a day. If you enter a punch shift that overrides the times of another punch shift for the day, you will receive a warning message.

The Alternate Schedule Detail tab is displayed only if core Global Payroll or Absence Management are installed and selected on the Installation Table – Products page.

## Training Details

This group box displays training detail information from PeopleSoft Training Administration or Learning Management. The start time and end time of the training for the day are displayed.

## Absence Details

This group box displays the duration of an absence from Global Payroll or Absence Management, or from leave reported directly on the Timesheet in Time and Labor or PeopleSoft Base Benefits.

## Holiday Details

This group box displays the name of the holiday and number of hours from the Holiday Schedule. If a holiday schedule exists for the employee on the Job Data page, it is displayed. If no holiday schedule exists on that page, the system checks if the employee is a Global Payroll employee and uses the holiday schedule from the Global Payroll pay group. If the employee is not enrolled in a Global Payroll pay group, but is enrolled in Time and Labor, the system uses the holiday schedule from the employee's Workgroup.

## Schedule Replacements Page

Use the Schedule Replacements page (SCH\_MNG\_REPLACE) to schedule a replacement for an employee for a day.

Navigation:

Select one check box in the Select column and click the **Replace Schedule** button on the Daily, Weekly, or Date Range Schedule pages.

This example illustrates the fields and controls on the Schedule Replacements page. You can find definitions for the fields and controls later on this page.

### Schedule Replacements

▶ Instructions

**Replace for**

<b>Name</b> Babloo Abhiram	<b>Empl ID</b> MOVT0322
<b>Job Title</b> Software Test Engineers	<b>Empl Record</b> 0
<b>Date</b> <input style="width: 80px;" type="text" value="07/31/2009"/>	

**Replace with** ? Personalize | Find | View 100 | | First 1-10 of 299 Last

Select	Empl ID	Empl Record	Name	Job Title
<input type="checkbox"/>	MRT0002	0	Adam Abrahams	ST - Mgr of Manufacturing
<input type="checkbox"/>	KFLD01	0	Aline Ada	Clerk
<input type="checkbox"/>	KFLE01	0	Jean Ada	Consultant - Senior
<input type="checkbox"/>	KU0101	0	Cynthia Adams	Corporate Controller
<input type="checkbox"/>	KU0423	0	Laura Adams	Nurse-Registered
<input type="checkbox"/>	KU0423	1	Laura Adams	Nurse-Registered-ICU
<input type="checkbox"/>	MOVT0345	0	Paul Adams	Software Test Engineers
<input type="checkbox"/>	MOVT0325	0	Peter Adams	Software Test Engineers
<input type="checkbox"/>	MAD0179	0	Kuruganti Aditya	ST - Manager of Payroll
<input type="checkbox"/>	MUTR076	0	Grace Adler	Manager

On the Schedule Replacements page, change the date if required and select one employee to substitute the schedule for the day. In most cases, the user would be finding a replacement for an employee who will be absent for the day. All the employees who are not in training for that time, and not absent for the day, appear in the **Replace with** grid.

After an employee is *Replaced*, an *R* is placed next to the employee in their daily cell, on any of the Manage Schedules pages - day, week or date range. The employee who is replacing the employee, inherits the schedule. The replaced employee retains the original schedule, so as to represent what the original schedule was, and for appropriate payment if the employee then reports an absence for the day.

If you decide that the replacement was a mistake, you can undo it by accessing the Daily Detail page from the Scheduled Hours link, and clicking the **Undo Replacement** button and then clicking the **OK** button on the Confirmation page. As a result, the *R* will no longer be displayed on the Manage Schedules page.

For the employee who had inherited the employee's schedule, the schedule for that day would need to be changed, if the employee is no longer replacing the employee's schedule for that day.

---

**Note:** If you selected the *Day View By Option*, the **Date** field on this page is display only.

---

## Copy Schedules Page

Use the Copy Schedules page (SCH\_MNG\_COPY) to copy an employee schedule to be used by another employee for a day or specified date range.

Navigation:

Select one check box in the Select column and click the **Copy Schedules** button on the Daily, Weekly, or Date Range Schedule pages.

This example illustrates the fields and controls on the Copy Schedules page. You can find definitions for the fields and controls later on this page.

### Copy Schedules

Copy schedule of first employee to selected employees for dates listed

**Schedule to be Copied**

<b>Name</b> Babloo Abhiram	<b>Empl ID</b> MOVT0322
<b>Job Title</b> Software Test Engineers	<b>Empl Record</b> 0

---

**Start Date**

Select	Empl ID	Empl Record	Name	Job Title
<input type="checkbox"/>	MRT0002	0	Adam Abrahams	ST - Mgr of Manufacturing
<input type="checkbox"/>	KFLD01	0	Aline Ada	Clerk
<input type="checkbox"/>	KFLE01	0	Jean Ada	Consultant - Senior
<input type="checkbox"/>	KU0101	0	Cynthia Adams	Corporate Controller
<input type="checkbox"/>	KU0423	0	Laura Adams	Nurse-Registered
<input type="checkbox"/>	KU0423	1	Laura Adams	Nurse-Registered-ICU
<input type="checkbox"/>	MOVT0345	0	Paul Adams	Software Test Engineers
<input type="checkbox"/>	MOVT0325	0	Peter Adams	Software Test Engineers
<input type="checkbox"/>	MAD0179	0	Kuruganti Aditya	ST - Manager of Payroll
<input type="checkbox"/>	MUTR076	0	Grace Adler	Manager

On the Copy Schedules page, change the Start Date and End Date if required. Select single or multiple employees to copy schedules and click the Copy button. The whole day will be copied for the date or range of dates defined. .

---

**Note:** If you selected the *Day View By* option, the **Date** field on this page is display only.

---

## Swap Schedules Page

Use the Swap Schedules page (SCH\_MNG\_SWAP) to swap two employees' schedules.

Navigation:

Select two check boxes in the Select column and click the Swap Schedules button on the Daily, Weekly, or Date Range Schedule pages.

This example illustrates the fields and controls on the Swap Schedules page. You can find definitions for the fields and controls later on this page.

### Swap Schedules

Swap schedules of the two employees selected

<b>Employee 1</b>	
<b>Name</b> Babloo Abhiram	<b>Empl ID</b> MOVT0322
<b>Job Title</b> Software Test Engineers	<b>Empl Record</b> 0
<b>Start Date</b> <input style="width: 100px;" type="text" value="07/31/2009"/>	
<b>Employee 2</b>	
<b>Name</b> Peter Adams	<b>Empl ID</b> MOVT0325
<b>Job Title</b> Software Test Engineers	<b>Empl Record</b> 0

On the Swap Schedules page, change the Start Date and End Date if required and click the Swap button. Click the Cancel button to return to the Manage Schedule page and make another selection. The whole day's schedule will be swapped between the two employees, or all the days listed if it is a range of dates.

---

**Note:** If you selected the *Day View By* option, the **Date** field on this page is display only.

---

## Integrating Training Data from Learning Management

This section discusses how to integrate Time and Labor with Learning Management.

### Learning Management

To use the ELM training data for display in the Manage Schedules and Manager Calendar pages, and the Workforce Availability pagelet, these steps should be considered:

- The learners are enrolled in the Job data record in HCM and the personal information has been messaged from HCM to ELM.
- Activate the Scheduled Time Fullsync message in the HCM and ELM database.
- Ensure Scheduled Time FullSync is run first, to get all activities and sessions over to HCM before starting to use the Scheduled Time Sync message.
- The Scheduled Time Fullsync should only be run once for initial setup. If the Scheduled Time Fullsync is run more than once, no rows will be deleted from the SCH\_EXT\_DTL table first. Any rows that are duplicate rows will be inserted into the SCH\_EXT\_REJ table.

- Activate the Scheduled Time Sync message in the HCM and ELM Database.

---

**Note:** When the Scheduled Time Fullsync message flows in from Enterprise Learning Management, it triggers the SCH\_EXT\_VALID Application Engine program in the HCM database. This program moves data from the SCH\_EXT\_STG table to the SCH\_EXT\_DTL table.

---

**Note:** The Enterprise Learning Management field on the Products page (Set Up HCM, Install, Installation Table), needs to be checked, in order for the user to view ELM training data icons in Manage Schedules, Monthly Schedules and Calendars.

---

## Scheduled Time Sync Message

The Scheduled Time Sync message in ELM is triggered by:

- Activity pages trigger a sync message. This includes session changes or additions, trainer changes, session date or time changes, dropping a learner from a session or adding a learner to a session.
- Enrollment modifications trigger a sync message. This includes the Manager Enrollment, Employee Enrollment and Administrator Enrollment components.

## ELM Data Display

A training icon will appear on a day that an employee is enrolled in training for both the Manage Schedule and Monthly Schedule pages.

The training data that is displayed in the Schedule Daily Detail section of the Manage Schedules page includes:

- The catalog item of the activity (that is the Course Code Description).
- Session Start Date and Start Time per day (that is, if training spans more than one day, there would be multiple sessions).

ELM data is derived to count employees who are reported as training for the Manager Calendar Views and the Workforce Availability pagelet.

The SCH\_EXT\_DTL and AUDIT\_SCH\_TBL records are updated for every training data change triggered from the Scheduled Time Sync message.

See the product documentation for *PeopleSoft Enterprise Learning Management PeopleBook*



# Using the Time and Labor WorkCenter

---

## Understanding Workcenters

This topic discusses:

- WorkCenters
- Common terms used with the PeopleSoft WorkCenter
- Pagelets, setup, maintenance, and personalization.

## WorkCenters

WorkCenters are designed for specific roles and provide a central area for users to access key components within PeopleSoft applications. They enable users to access various pages and keep multiple windows open while doing their daily work.

Video: [PeopleSoft WorkCenters](#)

It is the responsibility of the system administrator from your organization, to design and create links so that users can view and access specific links and pages.

For more information about setting up WorkCenters as a system administrator, see *Setting Up Pagelets for WorkCenters and Dashboards as a System Administrator*.

For information about setting up PeopleTools options for the WorkCenter, see *PeopleTools: Portal Technology*.

## Example: Time and Labor WorkCenter

This example illustrates the fields and controls on the Time and Labor WorkCenter page.

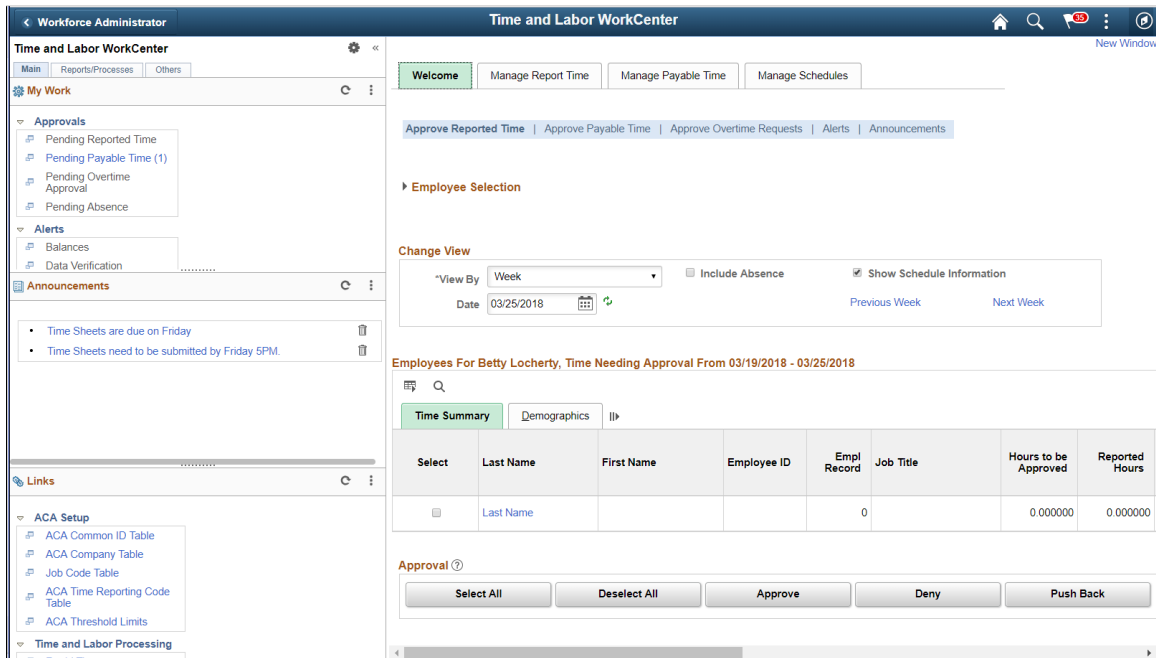

**Note:** Your WorkCenters may appear slightly different. This page shot is provided as a general example of a Time and Labor WorkCenter.

The WorkCenter navigation is located on the left side of the page and includes two main tabs: Main and Report/Processes. Some WorkCenter pagelets are common to multiple applications, and some pagelets are unique to individual applications.

Oracle's PeopleSoft development has predefined My Work links that are available to import.

### WorkCenter Tabs and Pagelets

The two primary tabs within a WorkCenter contain some common pagelets:

- Main tab:
  - My Work
  - Links
- Reports/Processes:
  - Queries
  - Reports/Processes

WorkCenters also provide a Welcome pane, which is displayed on the right side of the screen. A Welcome page explains some of the basic icons that are used throughout the WorkCenter. If a system administrator or an end user (if given access rights) selects the Starting Page check box on the Configure Pagelets component for My Work, Links, Queries, or Reports/Processes, then the option selected replaces the Welcome page in this pane.

## Common Terms Used with the PeopleSoft WorkCenter

These terms are commonly used when referring to the PeopleSoft WorkCenter:

<b>Term</b>	<b>Description</b>
Links Pagelet	A pagelet that contains links to PeopleSoft components and links to external URL's. This typically contains links that a user needs to do their daily work. An administrator can add links as needed to suit the needs of your business.
My Work Pagelet	A common pagelet that contains links to application-designed results pages. The content is filtered by administrator or end user defined criteria.
Pagelet Area	A collection of application-defined pagelets that contain links, task lists, and other content. This area is part of the PeopleTools framework but the pagelet content is defined by individual product needs.
Queries Pagelet	A common pagelet that contains links to queries (public or private) that are added by the administrator (public queries) or the end-user (public or private queries).
Reports and Processes Pagelet	A pagelet that contains links to PeopleSoft components; primarily reports and processes. This type of pagelet is controlled by the administrator.
WorkCenter	A WorkCenter is used to increase the productivity of a specific role by streamlining and simplifying their work in a central place. The left pane of a WorkCenter should help drive the transaction or work area for a user to complete their tasks based on the functional area.
Worklist	Refers to the PeopleTools worklist.
Working Zone or Transaction Area	The pagelet area where the search results or components are displayed. This area is the area that is not occupied by the pagelet area or is the entire WorkCenter if the pagelet area is hidden.

## Pagelets and Pagelet Setup, Maintenance, and Personalization

This topic provides a general, high-level description of the four types of pagelets:

- My Work Pagelet
- Links Pagelet
- Queries Pagelet

- Reports and Processes Pagelet
- Pagelet setup, maintenance, and personalization

## My Work Pagelet

The My Work section of the Main tab includes links to pages that an end user would need to access on a daily basis. The My Work section can also include exceptions and alerts, where the user would need to take some type of action.

Some links that are set up for the My Work pagelet can be subject to filter criteria that limit the amount of data that is available to a user.

The My Work section can be personalized by end users by clicking on the Pagelet Settings icon and then selecting Personalize.

## Links Pagelet

The Links section of the Main tab includes additional links to pages or other areas of interest to the user role. A system administrator can determine a list of links that are available to end users, and the end user can personalize which links they want to appear on their WorkCenter.

Links to external pages can be placed in this section as well.

## Queries Pagelet

The Query section of the Reports/Queries tab includes links to Query Manager, public queries, private queries, and pivot grids. The system administrator can determine if an end user can add public or private queries. The end user can personalize their private queries.

When a link is selected, the query or pivot grid results are displayed in the right pane of the WorkCenter or in a new window. Query results can be saved to Microsoft Excel.

## Reports and Processes Pagelet

The Reports and Processes section of the Reports/Queries tab includes links to reports and processes. The links take you to the run control page for reports, processes, and the Reporting Console.

The system administrator can determine whether an end user can configure their pagelet.

## Pagelet Setup, Maintenance, and Personalization

When setting up and maintaining a WorkCenter, there are setup options that are defined at the system administrator level and personalization options that are defined at the user level.

The system administrator must perform their setup options first, using the Enterprise Components, WorkCenter/Dashboards component. The end user performs their personalization options second, using the Personalize and Configure options in the WorkCenter.

---

# Using the Time and Labor WorkCenter

This section discusses how to use the tabs and pagelets in the Time and Labor WorkCenter.

## Time and Labor

Administrators use the Time and Labor tile to access the Time and Labor WorkCenter and Reported Time Audit.

Navigation:

The Time and Labor tile is delivered as part of the Workforce Administrator home page, but the location can change if you change the delivered home pages or if administrators personalize their home pages.

This example illustrates the Time and Labor tile.

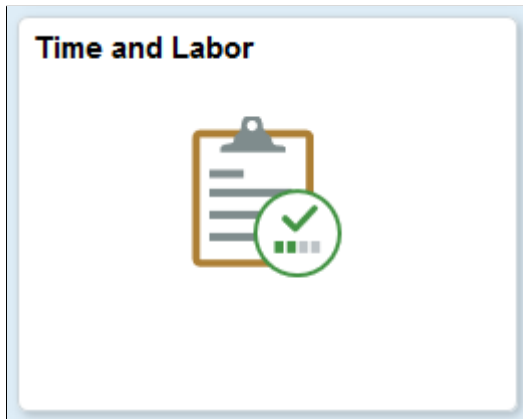

Click the Time and Labor tile to access the Time and Labor WorkCenter and Reported Time Audit.

## Accessing the Time and Labor WorkCenter

Use the Time and Labor WorkCenter to access various business processes to complete day-to-day work and commonly performed tasks:

Navigation:

- **Manager Self Service > Time Management > Time and Labor WorkCenter**
- Click the Time and Labor WorkCenter tile on the Workforce Administrator home page to access Time and Labor Fluid WorkCenter.

For more information on how to work with Time and Labor Fluid WorkCenter, refer [Time and Labor WorkCenter Page](#).

This example illustrates the fields and controls on the Time and Labor WorkCenter page.

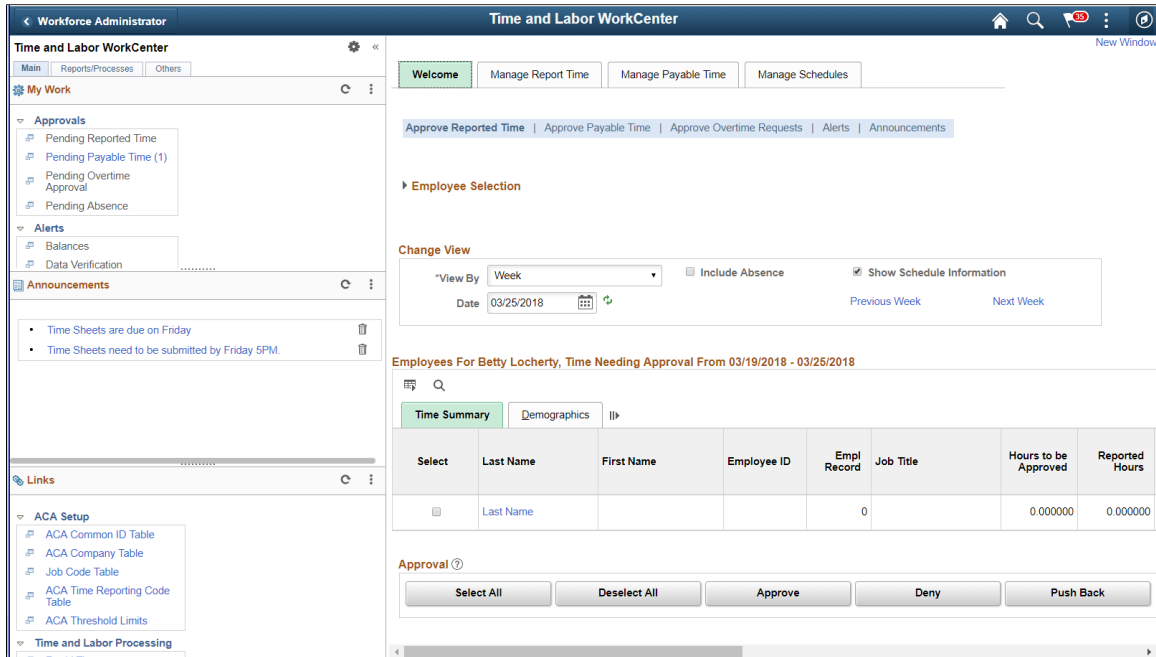

## Understanding the Tabs in the Pagelet Area of the Time and Labor WorkCenter

The left side of the page in the default configuration of the Time and Labor WorkCenter provides you with the following tabs containing different pagelets:

- **Main**

This tab contains the My Work, Announcements, and Links pagelets.

- **Reports/Processes**

This tab contains the Queries and the Reports/Processes pagelets.

- **Others**

This tab contains the Workforce Availability pagelet.

This section describes the pagelets and their contents.

## Understanding the My Work Pagelet in the Time and Labor WorkCenter

Within the Main tab in the Time and Labor WorkCenter, the default configuration of the My Work pagelet contains the following links:

- **Pending Reported Time:**

This link displays the counts for Reported Time where the user is the pending approver. The count is calculated using the PS\_TL\_APP\_PEND\_VW (Pending Reported Time Approvals) table. When you select this link, the system displays the Welcome tab - Approve Reported Time page in the WorkCenter transaction area.

- **Pending Payable Time:**

This link displays the counts for Payable Time where the user is the pending approver. The count is calculated using the PS\_TL\_APP\_PAY\_VW (Pending Payable Time Approvals) table. When you select this link, the system displays the Welcome tab - Approve Payable Time page in the WorkCenter transaction area.

- **Pending Overtime Approval:**

The count is calculated using the PS\_TL\_OT\_STATUS (Pending Over time Approvals) table. When you select this link, the system opens the View Overtime Requests - Overtime Requests page in the WorkCenter transaction area.

For more information, see: [View Overtime Requests - Overtime Requests Page](#)

- **Pending Absence:**

The count is calculated using the PS\_GP\_ABS\_APPR\_VW (Pending Absence Approvals) table. When you select this link, the system opens the Absence Requests page in the WorkCenter transaction area.

---

**Note:** The count on each of the transaction links is updated when the user takes an action or completes the transaction.

---

## Understanding the Announcements Pagelet in the Time and Labor WorkCenter

Within the Main tab in the Time and Labor WorkCenter, the default configuration of the Announcements pagelet displays the announcements for the user. When you select an occurrence link for an announcement, the system displays the Welcome tab – Announcements page in the Time and Labor WorkCenter transaction area.

## Understanding the Links Pagelet in the Time and Labor WorkCenter

Within the Main tab in the Time and Labor WorkCenter, the default configuration of the Links pagelet contains the following links to Time and Labor pages:

- **Rapid Time**

This link opens the Rapid Time page in the transaction area of the WorkCenter.

For more information, see: [Rapid Time Page](#)

- **Time Reporter Status**

This link opens the Time Reporter Status page in the transaction area of the WorkCenter.

For more information, see: [Time Reporter Status Page](#)

- **Request Time Administration**

This link opens the Request Time Administration page in the transaction area of the WorkCenter.

For more information, see: [Request Time Administration Page](#)

- **Request Batch Approval Process**

This link opens the Request Batch Approval Process page in the transaction area of the WorkCenter.

For more information, see: [Request Batch Approval Process Page](#)

- **Timesheet Lockdown**

This link opens the Timesheet Lockdown page in the transaction area of the WorkCenter.

For more information, see: [Locking Timesheets](#)

- **Adjust Paid Time**

This link opens the Adjust Paid Time page in the transaction area of the WorkCenter.

For more information, see: [Adjusting Time](#)

- **HR Notification**

This link opens the HR Notification page in the transaction area of the WorkCenter.

---

**Note:** Oracle PeopleSoft delivers Notification Composer Framework to manage the setup and administration of all notifications in one central location.

Once you have adopted the Notification Composer feature, you must use it to create new notifications and manage your existing notifications.

Notifications delivered with HCM Image 47 or later must use Notification Composer.

For more information about Notification Composer Framework, see “Understanding Notification Composer” (Enterprise Components).

---

In addition, there are links to pages in Absence Management processing, Payroll for North America processing and links to external sites.

## Understanding the Queries Pagelet in the Time and Labor WorkCenter

Within the Reports/Processes tab in the Time and Labor WorkCenter, the default configuration of the Queries pagelet contains the following links:

- **Query Manager**
- **Unprocessed Mass Elapsed Time**
- **Unprocessed Mass Punch Time**
- **Unprocessed Rapid Elapsed Time**
- **Unprocessed Rapid Punch Time**

Each of these links displays query information in the transaction area of the WorkCenter.

For more information about Query Manager, see: *PeopleTools: PeopleSoft Query*.

For more information about the unprocessed time queries, see: [Auditing Time](#)



## Understanding the Reports/Processes Pagelet in the Time and Labor WorkCenter

Within the Reports/Processes tab in the Time and Labor WorkCenter, the default configuration of the Reports/Processes pagelet contains the following links:

- **TimeCard**

This link opens the TimeCard page in the transaction area of the WorkCenter.

For more information, see: [TimeCard Page](#)

- **Payable Status**

This link opens the Payable Status page in the transaction area of the WorkCenter.

For more information, see: [Generating a Payable Status Report](#)

- **Scheduled Hours**

This link opens the Scheduled Hours page in the transaction area of the WorkCenter.

For more information, see: [Managing Schedules](#)

- **Leave and Compensatory Time**

This link opens the Leave and Compensatory Time page in the transaction area of the WorkCenter.

For more information, see: [Leave and Compensatory Time Page](#)

- **Reported Time Audit**

This link opens the Time Audit Report page in the transaction area of the WorkCenter.

For more information, see: [Reported Time Audit Page](#)

- **TCD Usage**

This link opens the TCD Usage page in the transaction area of the WorkCenter.

For more information, see: [Sending Setup Data to a TCD](#)

- **Timesheet by Status**

This link opens the Timesheet by Status page in the transaction area of the WorkCenter.

For more information, see: [Timesheet by Status Pivot Grid Page](#)

- **Attendance Violations**

This link opens the Attendance Violations page in the transaction area of the WorkCenter.

For more information, see: [Attendance Violations Pivot Grid Page](#)

- **Absence Types - Benefits**

This link opens the Absence Types - Benefits page in the transaction area of the WorkCenter.

For more information, see: [Absence Types - Benefits Pivot Grid Page](#)

- **Absence Type - Absence Management**

This link opens the Absence Type - Absence Management page in the transaction area of the WorkCenter.

For more information, see: [Absence Type - Absence Mgmt Pivot Grid Page](#)

For more information, see: [Time and Labor Reports: A to Z](#)

## **Understanding the Workforce Availability Pagelet in the Time and Labor WorkCenter**

The Workforce Availability pagelet displays within the Others tab in the Time and Labor WorkCenter. This pagelet functionality is available in the PeopleSoft Portal pack.

This pagelet provides the following features:

- **Currently Clocked In:** Displays the number of employees who are currently clocked in for the current punch shift.
- **No Show for Current Shift:** Displays the number of employees who are scheduled for the current punch shift but have not clocked in.
- **Scheduled for Current Shift:** Displays the number of employees who are scheduled for the current punch shift.
- **Reported Absent for Today:** Displays the number of employees who are reported as absent. If PeopleSoft Enterprise Global Payroll is installed, the system determines if any absences are reported in the absence pages. In addition, the system detects any leave time reporting codes (TRCs) in the PeopleSoft Enterprise Time and Labor application's reported elapsed time, which is not a Global Payroll absence.
- **Reported In Training for Today:** Displays the number of employees who have scheduled, approved training for the day. This count includes the attendance statuses from the Training Administration business process of currently attending, completed, enrolled, approved and authorized.

## **Understanding the Transaction Area of the Time and Labor WorkCenter**

The right side of the page in the default configuration of the Time and Labor WorkCenter provides you with an interface that consists of the following tabs:

- **Welcome**
- **Manage Report Time**
- **Manage Payable Time**
- **Manage Schedules**

This section describes each of the tabs and their contents.

## Understanding the Welcome Tab

This portion of the Time and Labor WorkCenter page shows the default configuration of the Welcome tab in the WorkCenter.

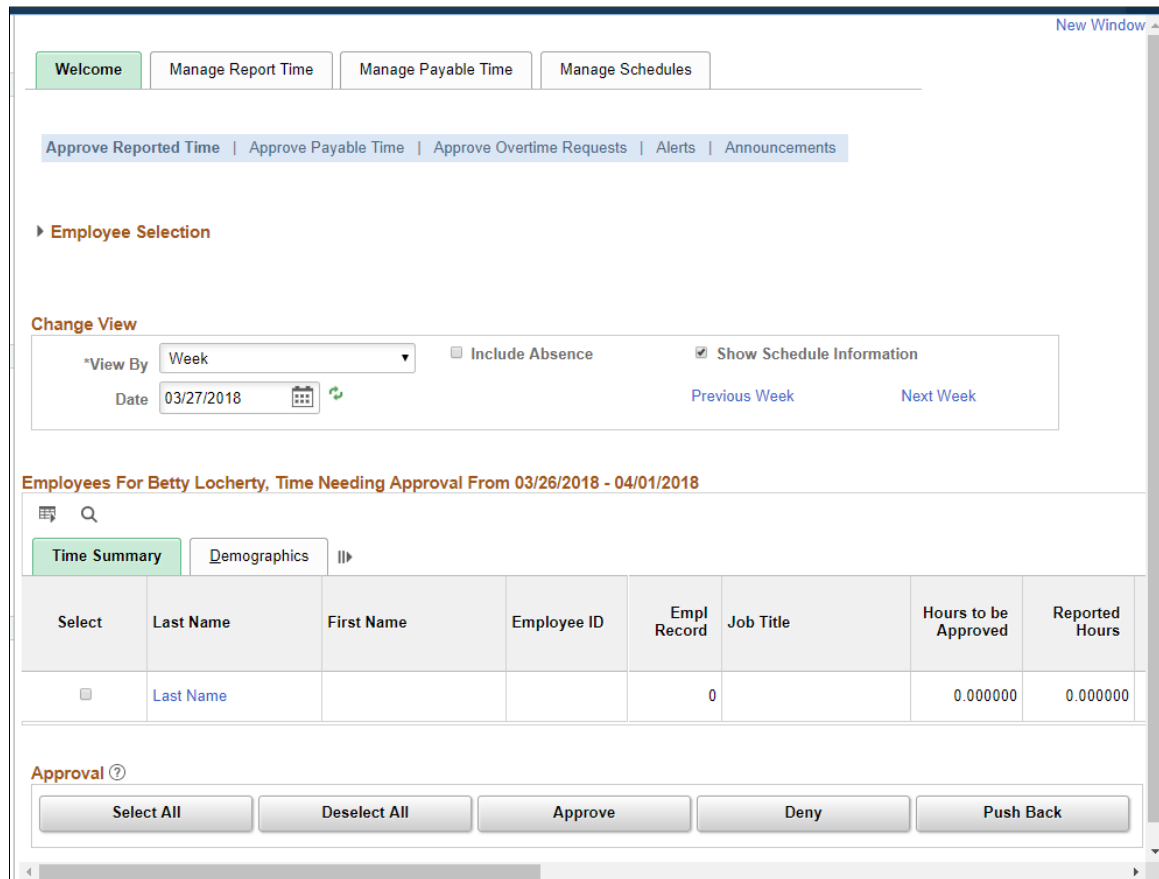

Within the default configuration of the Time and Labor WorkCenter, the Welcome tab includes the following pagelets:

- Approve Reported Time (TL\_MSS\_TIMESHEET)

**Note:** Note: When the approval framework is not implemented this page is not displayed and you cannot set up this page as part of the Tab application Setup. The system displays the Announcements page instead.

For more information, see: [Approving Reported Time](#)

- Approve Payable Time (TL\_MNG\_APRV\_SRCH)

For more information, see: [Approving Payable Time](#)

- Approve Overtime Requests (TL\_OT\_MNGR\_LIST)

For more information, see: [Managing Overtime Requests](#)

- Announcements (TL\_MNG\_ANNOUNCE)

This page displays any announcements or email notifications to targeted system users. The pagelet displays a summary of all of the announcements for the user. The system determines which

announcements are available to view based on the login user profile and the announcement “To” list and where the current date is not greater than the announcement expiration date. The announcements are displayed in ascending order by announcement expiration date. This pagelet is only available through the Time and Labor WorkCenter.

You can create adhoc announcements using the HR Notifications page (HCSC\_NOTIF\_ADHOC).

Navigation:

**Set Up HCM > Common Definitions > HR Notification > HR Notification**

## Understanding the Manage Report Time Tab

This portion of the Time and Labor WorkCenter page shows the default configuration of the Manage Report Time tab in the WorkCenter.

Last Name	First Name	Employee ID	Empl Record	Job Title	Reported Hours
16696047	MTABUG	MTA16696047	0	ST - Manager of Human Resource	0.00
16906570	MTABUG	MTA16906570	0	ST - Manager of Human Resource	0.00
17278723	MTABUG	MTA17278723	0	ST - Manager of Human Resource	0.00
17498455	MTABUG	MTA17498455	0	ST - Manager of Human Resource	0.00

Within the default configuration of the Time and Labor WorkCenter, the Manage Report tab includes the following pagelets:

- Timesheet (TL\_MSS\_TIMESHEET)

For more information, see: [Reporting Time](#)

- Mass Time (TL\_MASS\_WHO)

For more information, see: [Mass Time - Select Time Reporters Page](#)

- Unprocessed Reported Time (TL\_UNPROCESS\_SUMM)  
For more information, see: [Auditing Time](#)
- Leave and Compensatory Time (TL\_LEAV\_COMP and TL\_LEAV\_DET)  
For more information, see: [Leave and Compensatory Time Page](#)
- Overtime Requests (TL\_OT\_EVENTS)  
For more information, see: [Managing Overtime Requests](#)
- Overtime Balances (TL\_OT\_BALANCES)  
For more information, see: [Overtime Balances Page](#)

## Understanding the Manage Payable Time Tab

This portion of the Time and Labor WorkCenter page shows the default configuration of the Manage Payable Time tab in the WorkCenter.

Last Name	First Name	Employee ID	Employment Record	Job Title	Hours to be Approved	Hours Approved or Submitted
16696047	MTABUG	MTA16696047	0	ST - Manager of Human Resource	0.000000	0.000000
16906570	MTABUG	MTA16906570	0	ST - Manager of Human Resource	0.000000	0.000000
17278723	MTABUG	MTA17278723	0	ST - Manager of Human Resource	0.000000	0.000000
17498455	MTABUG	MTA17498455	0	ST - Manager of Human Resource	0.000000	0.000000
17672641	MTABUG	MTA17672641	0	ST - Manager of Human Resource	0.000000	0.000000
17963655	MTABUG	MTA17963655	0	ST - Manager of Human Resource	0.000000	0.000000
44438	MCFL	MCFL44438	0	ST President	0.000000	0.000000
71966	clt	MCFL71966	0	ST - Filing Clerk	0.000000	0.000000

Within the default configuration of the Time and Labor WorkCenter, the Manage Payable Time tab includes the following pagelets:

- Payable Time Summary (TL\_TM\_MPAY\_SUMM)  
For more information, see: [Payable Time Summary Page](#)
- Exceptions (TL\_MNG\_EXCEPT\_PNL1)  
For more information, see: [Managing Exceptions](#)
- Unprocessed Payable Time (TL\_UNPROCESS\_SUMM)

For more information, see: [Unprocessed Payable Time Page](#)

## Understanding the Manage Schedules Tab

This portion of the Time and Labor WorkCenter page shows the default configuration of the Manage Schedules tab in the WorkCenter.

Select	Last Name	First Name	Employee ID	Empl Record	Job Title	Friday 02/15/13	Saturday 02/16/13	Sunday 02/17/13	Monday 02/18/13	Tu 02
<input type="checkbox"/>	16696047	MTABUG	MTA16696047	0	ST - Manager of Human Resource	No Schedule	No Schedule	No Schedule	No Schedule	No:
<input type="checkbox"/>	16906570	MTABUG	MTA16906570	0	ST - Manager of Human Resource	No Schedule	No Schedule	No Schedule	No Schedule	No:

Within the default configuration of the Time and Labor WorkCenter, the Manage Schedules tab includes the following pagelets:

- Weekly Schedules (SCH\_MNG\_WEEKLY)  
For more information, see: [Managing Schedules](#)
- Weekly Time Calendar (TL\_WV\_WEEKLY)  
For more information, see: [Using Manager Time Calendar Views](#)

## Using Time and Labor WorkCenter Pivot Grids

This section provides an overview of Time and Labor pivot grids.

### Understanding Time and Labor Pivot Grids

PeopleSoft Pivot Grid is a PeopleTools technology that provides operational dashboard reporting in the form of a grid, chart, or both. Pivot grids enable users to visually display real-time data and organize it on the fly by performing operations such as pivoting and filtering.

Video: [PeopleSoft Actionable Operational Analytics](#)

The Time and Labor WorkCenter delivers four pivot grids that provide graphic views of operational information, enabling users to monitor business processes and take relevant actions:

- The Timesheet by Status chart displays the number of occurrences for each of the reported timesheet statuses for the specified employees and dates.
- The Attendance Violations chart shows the number of occurrences for each of the retrieved attendance violations for the specified employees and dates.
- The Absence Type - Absence Management chart shows the number of occurrences for each of the retrieved absence types (sick, vacation, etc.) for the specified employees and dates using PeopleSoft Absence Management information.
- The Absence Types - Benefits chart shows the number of occurrences for each of the retrieved absence types (sick, vacation, etc.) for the specified employees and dates using PeopleSoft Base Benefits information.

**Important!** In order to populate the TL\_JOB\_EMPL\_DAT table with Job data and Time and Labor Employee data for an employee, you must run the TL\_PG\_EMPDAT Application Engine process. . This record is used in pivot grids to retrieve job data for an employee.

Use the PeopleTools Process Request Dialog page to initiate the process. Navigate to:

**PeopleTools > Process Scheduler > System Process Requests.**

See the product documentation for *PeopleTools: PeopleSoft Process Scheduler*

For more information on the setup and capabilities of PeopleSoft Pivot Grids, see *PeopleTools: PeopleSoft Pivot Grid*.

## Common Elements for Viewing Pivot Grids

These page controls appear on all Time and Labor pivot grids:

<b>Field or Control</b>	<b>Description</b>
	<p>Click to open the Options Menu, then select from these menu items::</p> <ul style="list-style-type: none"> <li>• <i>Prompts</i>: Displays a dialog box where you can change the parameters used to define the chart’s data set.</li> <li>• <i>View Grid</i>: Opens an additional dialog box that displays the data in a grid format rather than a chart format.</li> <li>• <i>Export Data</i>: Exports the underlying PSQuery data to a spreadsheet.</li> <li>• <i>Chart Options</i>: Opens the User Charting Options dialog box, where you can change the chart labels, layout, axes, and filters.</li> <li>• <i>Save</i>: Saves the current grid and chart layout as the default view</li> </ul>

<b>Field or Control</b>	<b>Description</b>
<b>Filters</b>	Displays drop-down list boxes that you use to filter the data to be displayed in the chart.
<b>Drilldown Menu</b>	<p>When you click a data element (for example, a bar on a bar chart), a menu provides these options:</p> <ul style="list-style-type: none"> <li>• <i>Detailed View</i>: Displays a grid with the detailed data. For example, if a bar on a bar chart represents the number of job openings that were filled in a particular month, clicking Detailed View displays a grid with information about each of the included job openings.</li> <li>• <i>Drilldown To</i>: Displays the drilldown options defined for the chart. Clicking a drilldown option redraws the chart based on the selected type of data.</li> </ul>

## Pages Used to View Time and Labor Pivot Grids

<b>Page Name</b>	<b>Definition Name</b>	<b>Usage</b>
<u>Timesheet by Status Pivot Grid Page</u>	TL_RPTD_IRPT	<p>Displays the number of occurrences for each reported timesheet status for a manager's employees within the specified dates.</p> <p>Using Related Actions on the drill down grid you can access the Timesheet page.</p>
<u>Attendance Violations Pivot Grid Page</u>	TL_ATTP_IRPT	<p>Displays the number of occurrences for each of the retrieved attendance violations for a manager's employees within the specified dates.</p> <p>Using Related Actions on the drill down grid you can access the Timesheet page.</p>
<u>Absence Type - Absence Mgmt Pivot Grid Page</u>	TL_ABST_IRPT	<p>Displays the number of occurrences for each of the retrieved absence types (for example sick and vacation) for a manager's employees within the specified dates, using PeopleSoft Absence Management information.</p> <p>Using Related Actions on the drill down grid you can access the Timesheet page.</p>



<b>Page Name</b>	<b>Definition Name</b>	<b>Usage</b>
<u>Absence Types - Benefits Pivot Grid Page</u>	TL_ABST_IRPT_BC	<p>Displays the number of occurrences for each of the retrieved absence types (for example sick and vacation) for a manager's employees within the specified dates, using PeopleSoft Base Benefits information.</p> <p>Using Related Actions on the drill down grid you can access the Timesheet page.</p>
<u>Payable Time Trend Page</u>	TL_PT_TREND_IRPT	<p>Displays a detailed report for estimated gross on the basis of selected data range, using Time and Labor information. The report helps in comparing data between current time and historical payable time. For example Comparing Overtime cost during current pay period and previous pay. The default report is in the form of two-dimensional bar chart.</p> <p>Using Related Actions on the drill down grid you can access the Timesheet page.</p>
<u>Time Categories Comparison Page</u>	TL_TIME_CAT_IRPT	<p>Displays a comparison report on Payable Time based on the time categories for the duration provided.</p> <p>This allows comparing data like overtime versus regular, productive versus non-productive time.</p> <p>Using Related Actions on the drill down grid you can access the Timesheet page.</p>
<u>Labor Costs Page</u>	TL_LBR_IRPT	<p>Displays an analysis report for the labor cost in terms of productivity or time categories.</p> <p>The Labor costs pivot grid depicts a bar chart with estimated gross for the employees calculated under different department ids.</p> <p>Using Related Actions on the drill down grid you can access the Timesheet page.</p>
<u>Payable Time by Status Page</u>	TL_PYTST_IRPT	<p>Displays an insight to statuses that require monitoring and enables the user to take appropriate actions on these payable statuses.</p>

## Timesheet by Status Pivot Grid Page

Use the Timesheet by Status pivot grid (TL\_RPTD\_IRPT) to display the number of occurrences for each reported timesheet status for a manager’s employees within the specified dates.

Navigation:

- **Time and Labor > Reports > Interactive Reports > Timesheet by Status**
- **Manager Self Service > Time Management > Time and Labor WorkCenter** Select the **Reports/Processes** tab, then select the **Timesheet by Status** link.

This example illustrates the Timesheet by Status pivot grid.

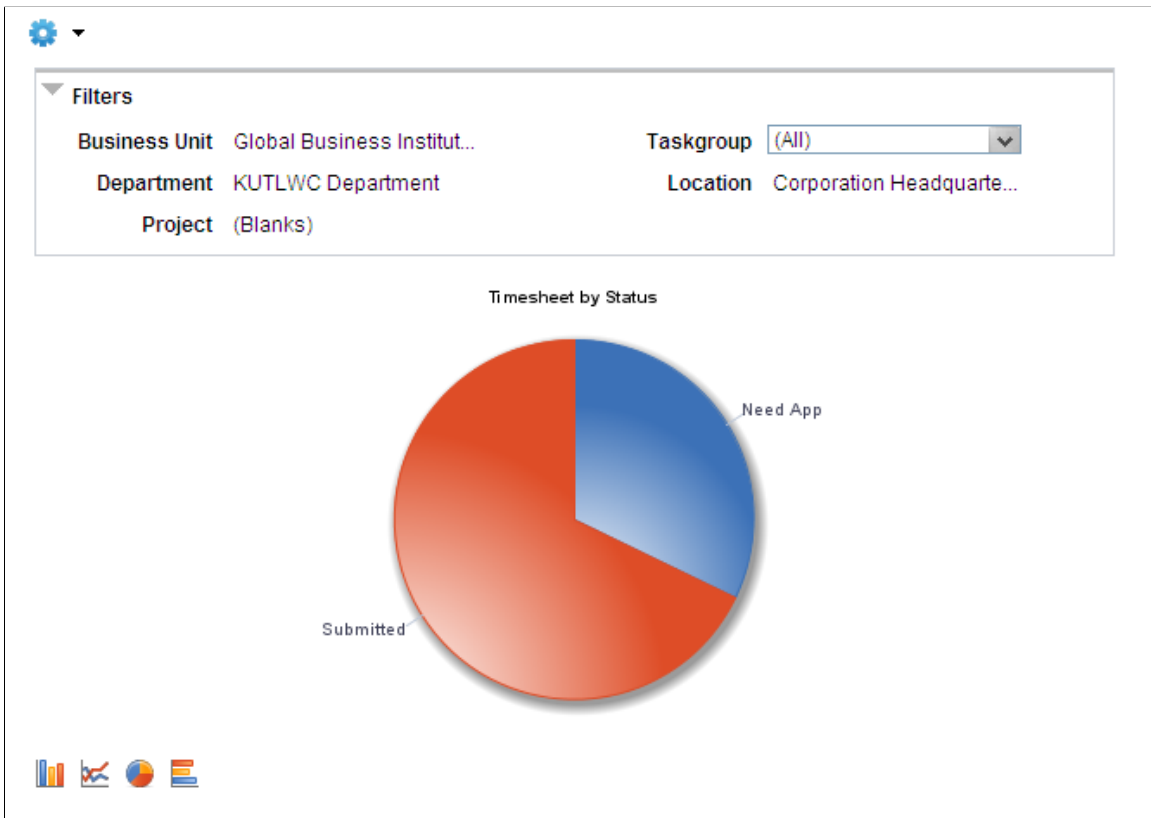

The Timesheet by Status pivot grid displays timesheet status data from TL\_RPTD\_TIME in a pie chart. A manager can view a summary of the timesheet status for all of the manager’s employees. The manager can filter the information using different levels of detail.

The grid view of this chart provides a link to the related Timesheet.

### Chart Content and Layout

<b>Option</b>	<b>Details</b>
<b>From and To</b>	Enter the starting and ending dates to define the date range for the pivot grid.

<b>Option</b>	<b>Details</b>
<b>Generate Report</b>	Select to display the pivot grid, based on the specified employees and the date range specified for the pivot grid.
 Prompts	Enter a specific value for any of the listed fields to modify the displayed pivot grid. The available fields are <b>Start Date, Dept ID, Supervisor ID, Reports to, Location, Company, Pay Group, Paygroup_GP, Workgroup, Taskgroup, Position, End Date, Time Group, Empl ID, Empl Record, First Name, Last Name, Business Unit, Job Code, Job Descr.</b>
Filters	<ul style="list-style-type: none"> <li>• Business Unit</li> <li>• Department</li> <li>• Project</li> <li>• Taskgroup</li> <li>• Location</li> </ul>
Drill-down options	<ul style="list-style-type: none"> <li>• TRC</li> <li>• Position No. (Position Number)</li> <li>• Jobcode</li> <li>• Approver Name</li> </ul>
Chart type options	<ul style="list-style-type: none"> <li>• Bar chart</li> <li>• Line chart</li> <li>• Pie chart</li> <li>• Horizontal bar chart</li> </ul>

## Attendance Violations Pivot Grid Page

Use the Attendance Violations pivot grid (TL\_ATTP\_IRPT) to view the number of occurrences for each of the retrieved attendance violations for a manager's employees within the specified dates.

Navigation:

- **Time and Labor > Reports > Interactive Reports > Attendance Violations**
- **Manager Self Service > Time Management > Time and Labor WorkCenter** Select the **Reports/Processes** tab, then select the **Attendance Violations** link.

This example illustrates the Attendance Violations pivot grid

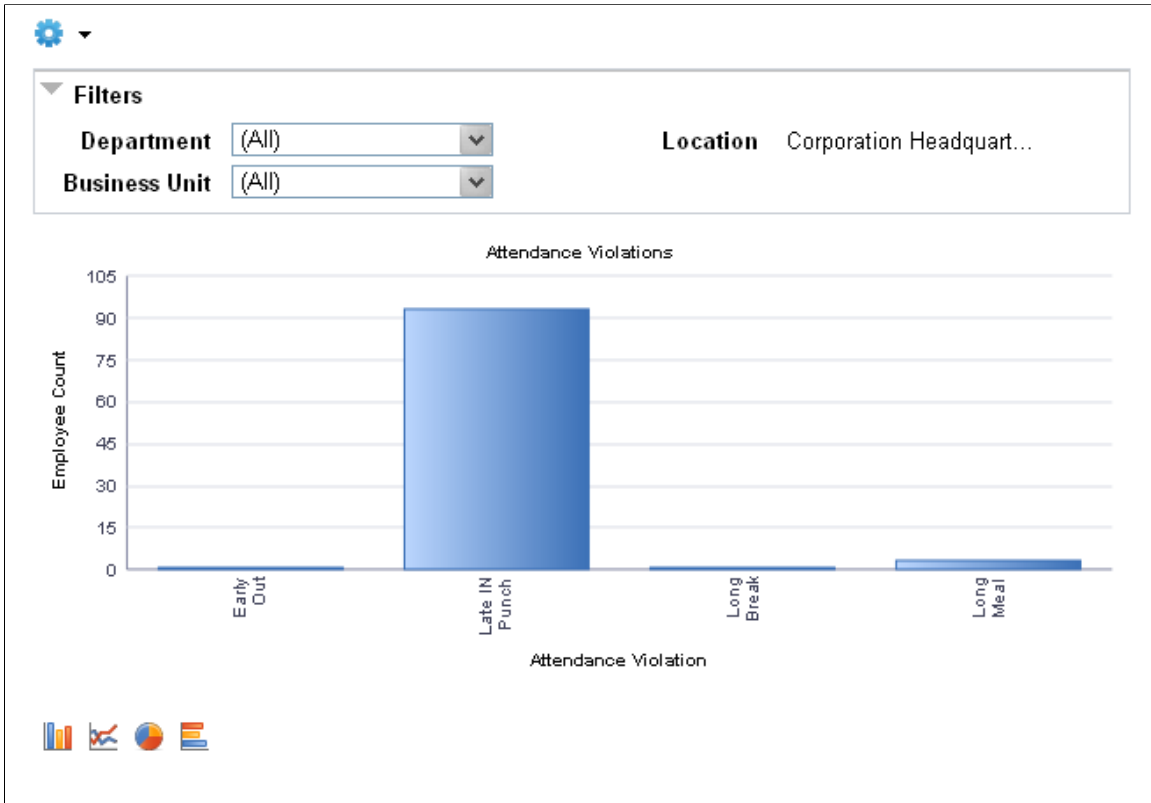

The Attendance Violations pivot grid displays the attendance violations from the TL\_Attendance table for a manager’s employees. The pivot grid displays the data in a bar chart.

The grid view of this chart provides a link to the related Timesheet.

**Important!** You must use PeopleSoft Attendance Tracking to control time and administer attendance in order to see data in this pivot grid.

For more information, see: [Defining Attendance Programs](#)

### Chart Content and Layout

The following table describes options for manipulating the chart:

<b>Option</b>	<b>Details</b>
 Prompts	Enter a specific value for any of the listed fields to modify the displayed pivot grid. The available fields are <b>Start Date, Dept ID, Supervisor ID, Reports to, Location, Company, Pay Group, Paygroup_GP, Workgroup, Taskgroup, Position, End Date, Time Group, Empl ID, Empl Record, First Name, Last Name, Business Unit, Job Code, Job Descr.</b>

<b><i>Option</i></b>	<b><i>Details</i></b>
Filters	<ul style="list-style-type: none"> <li>• Department</li> <li>• Business Unit</li> <li>• Location</li> </ul>
Drill-down options	<ul style="list-style-type: none"> <li>• Taskgroup</li> <li>• Position</li> <li>• Jobcode</li> </ul>
Chart type options	<ul style="list-style-type: none"> <li>• Bar chart</li> <li>• Line chart</li> <li>• Pie Chart</li> <li>• Horizontal bar chart</li> </ul>

## Absence Type - Absence Mgmt Pivot Grid Page

Use the Absence Type - Absence Mgmt (Absence Type - Absence Management) pivot grid (TL\_ABST\_IRPT) to view the number of occurrences for each of the retrieved absence types (sick, vacation, etc.) for a manager's employees within the specified dates, using PeopleSoft Absence Management information.

Navigation:

- **Time and Labor > Reports > Interactive Reports > Absence Type - Absence Mgmt**
- **Manager Self Service > Time Management > Time and Labor WorkCenter** Select the **Reports/Processes** tab, then select the **Absence Type - Absence Mgmt** link.

This example illustrates the Absence Type - Absence Mgmt pivot grid.



The Absence Type - Absence Mgmt pivot grid displays the Absence Management absence types used by a manager’s employees for a specified time period. The pivot grid displays the data from the GP\_ABS\_EVENT table in a bar chart.

The Day Count on the chart is shown in calendar days. The grid view of this chart provides links to the Absence Events for the displayed data.

The grid view of this chart provides a link to the related Timesheet.

**Important!** This chart relies on data from PeopleSoft Absence Management or Global Payroll in order to display the information in the chart.

### Chart Content and Layout

The following table describes options for manipulating the chart:

Option	Details
 Prompts	Enter a specific value for any of the listed fields to modify the displayed pivot grid. The available fields are <b>Start Date, Dept ID, Supervisor ID, Reports to, Location, Company, Pay Group, Paygroup_GP, Workgroup, Taskgroup, Position, End Date, Time Group, Empl ID, Empl Record, First Name, Last Name, Business Unit, Job Code, Job Descr.</b>

<b>Option</b>	<b>Details</b>
Filters	<ul style="list-style-type: none"> <li>• Department Description</li> <li>• Location Description</li> <li>• Business Description</li> <li>• Calendar Group</li> </ul>
Drill-down options	<ul style="list-style-type: none"> <li>• Absence Take</li> <li>• Absence Reason</li> </ul>
Chart type options	<ul style="list-style-type: none"> <li>• Bar chart</li> <li>• Line chart</li> <li>• Pie Chart</li> <li>• Horizontal bar chart</li> </ul>

## Absence Types - Benefits Pivot Grid Page

Use the Absence Types - Benefits pivot grid (TL\_ABST\_IRPT\_BC) to view the number of occurrences for each of the retrieved absence types (sick, vacation, etc.) for a manager's employees within the specified dates, using PeopleSoft Base Benefits information.

Navigation:

- **Time and Labor > Reports > Interactive Reports > Absence Type - Benefits Report**
- **Manager Self Service > Time Management > Time and Labor WorkCenter** Select the **Reports/Processes** tab, then select the **Absence Types - Benefits** link.

This example illustrates the Absence Types - Benefits pivot grid.

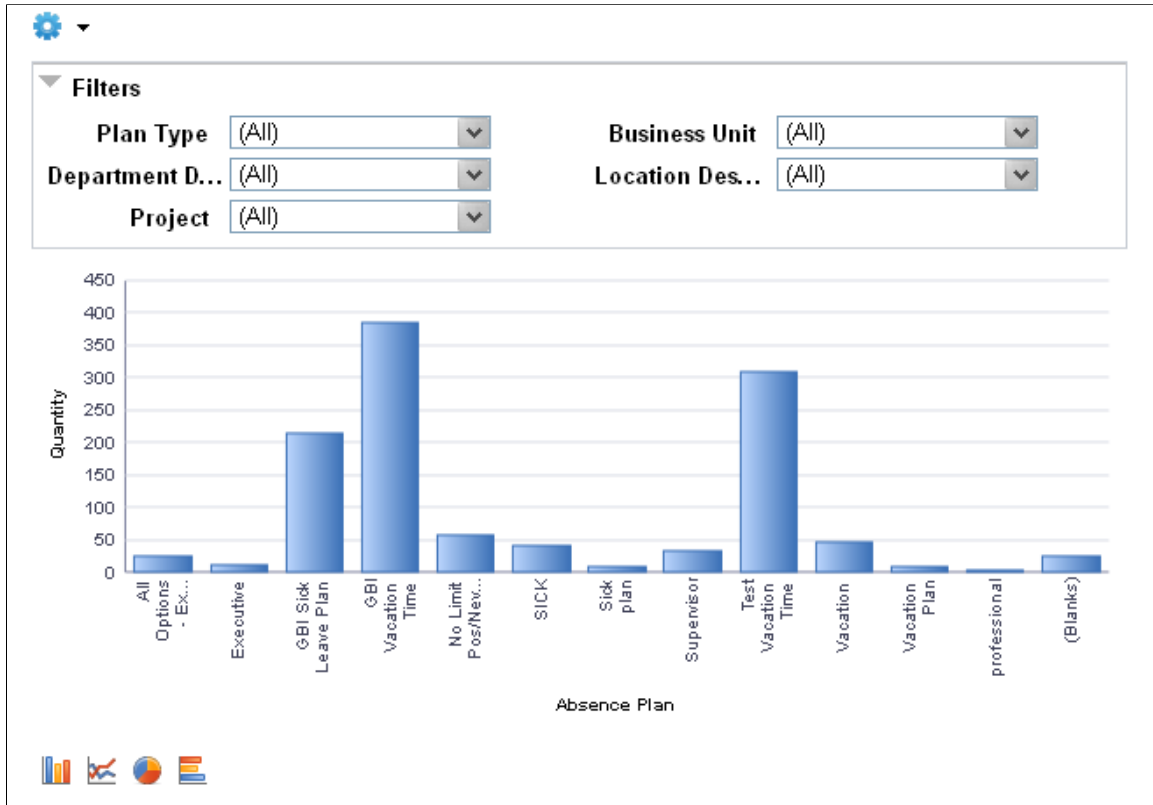

The Absence Types - Benefits pivot grid displays data from the TL\_RPTD\_TIME table in a bar chart. The Day Count on the chart is shown in calendar days. The grid view of this chart provides a link to the related Timesheet.

### Chart Content and Layout

The following table describes options for manipulating the chart:

<b>Option</b>	<b>Details</b>
 Prompts	Enter a specific value for any of the listed fields to modify the displayed pivot grid. The available fields are <b>Start Date, Dept ID, Supervisor ID, Reports to, Location, Company, Pay Group, Paygroup_GP, Workgroup, Taskgroup, Position, End Date, Time Group, Empl ID, Empl Record, First Name, Last Name, Business Unit, Job Code, Job Descr.</b>



<b>Option</b>	<b>Details</b>
Filters	<ul style="list-style-type: none"> <li>• Plan Type</li> <li>• Business Unit</li> <li>• Department Description</li> <li>• Location Description</li> <li>• Project</li> </ul>
Drill-down options	<ul style="list-style-type: none"> <li>• TRC</li> <li>• Position No. (Position Number)</li> <li>• Jobcode</li> <li>• Taskgroup</li> </ul>
Chart type options	<ul style="list-style-type: none"> <li>• Bar chart</li> <li>• Line chart</li> <li>• Pie Chart</li> <li>• Horizontal bar chart</li> </ul>

## Payable Time Trend Page

Use the Payable Time Trend pivot grid (TL\_PT\_TREND\_IRPT) page to view a detailed report for estimated gross on the basis of selected data range.

Navigation:

- **Time and Labor > Reports > Interactive Reports > Payable Time Trend Page**
- **Manager Self Service > Time Management > Time and Labor WorkCenter.** Select the **Reports/Processes** tab, then select the **Payable Time Trend** link.

This example illustrates the Absence Types - Payable Time Trend pivot grid.

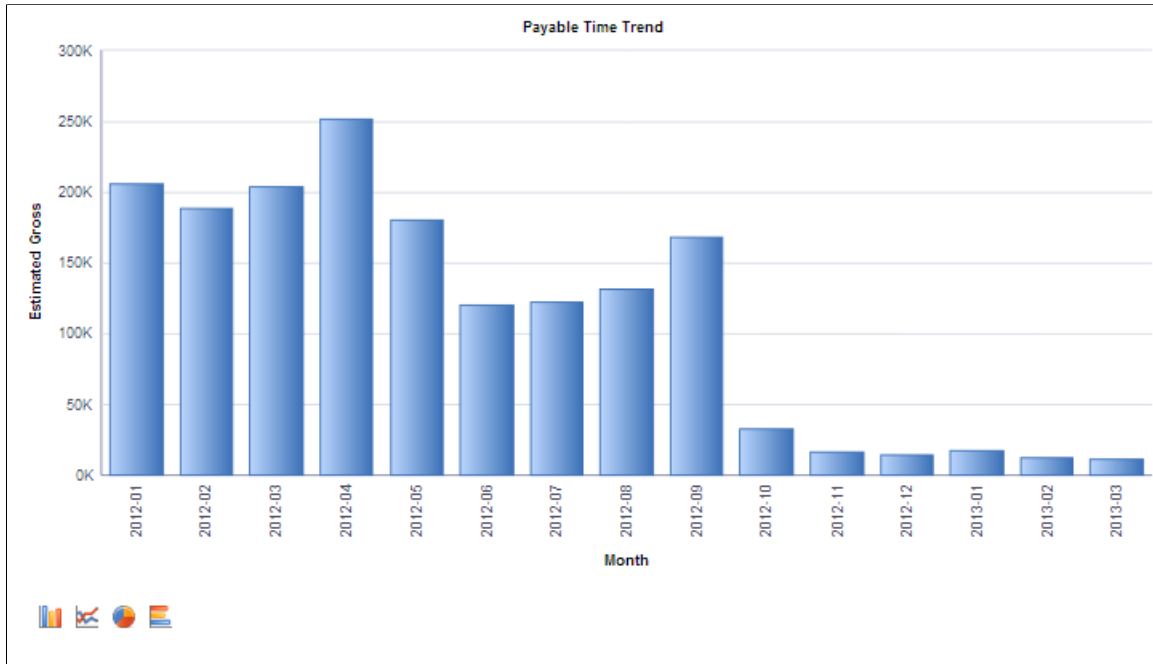

The Payable Time Trend Pivot Grid allows This allows comparing data like overtime versus regular, productive versus non-productive time.

- As the report is based on payable time table, run absence conversion for the required time period for which the user is generating the report.
- To compare between two different TRC Categories, enter values in TRC Category 1 and TRC Category 2.

### Chart Content and Layout

The following table describes options for manipulating the chart:

<b>Option</b>	<b>Details</b>
<b>From and To</b>	Enter the starting and ending dates to define the date range for the pivot grid.
<b>Generate Report</b>	Select to display the pivot grid, based on the specified employees and the date range specified for the pivot grid.
 Prompts	Enter a specific value for any of the listed fields to modify the displayed pivot grid. The available fields are <b>Start Date, Dept ID, Supervisor ID, Reports to, Location, Company, NA Pay Group, Paygroup_GP, Workgroup, Taskgroup, Position Number, End Date, Time Reporter Group, TRC Category, Employee ID, Employee RecordFirst Name, Last Name, Business Unit, Job Code, Job Description.</b>

<b>Option</b>	<b>Details</b>
Filters	<ul style="list-style-type: none"> <li>• HR Business Unit</li> <li>• Department</li> <li>• PC Project ID</li> <li>• Taskgroup</li> <li>• Location</li> <li>• Employee Type</li> <li>• Payable Status</li> <li>• Shift</li> <li>• Combo Code</li> <li>• Workgroup</li> <li>• Union Code</li> <li>• Year</li> <li>• Quarter</li> </ul>
Drill-down options	<ul style="list-style-type: none"> <li>• TRC Category</li> <li>• Employee ID</li> <li>• Pay Period End Date</li> <li>• Time Reporting Code</li> <li>• Week</li> <li>• Position Number</li> <li>• Job Description</li> <li>• Time Period ID</li> <li>• Reports To Position Number</li> <li>• Supervisor ID</li> </ul>

<b>Option</b>	<b>Details</b>
Chart type options	<ul style="list-style-type: none"> <li>• Bar chart</li> <li>• Line chart</li> <li>• Pie chart</li> <li>• Horizontal bar chart</li> </ul>

## Time Categories Comparison Page

Use the Time Categories Comparison pivot grids (TL\_TIME\_CAT\_IRPT) page to display a comparison report on Payable Time based on the time categories for the duration provided.

Navigation:

- **Time and Labor > Reports > Interactive Reports > Time by Categories Report**
- **Manager Self Service > Time Management > Time and Labor WorkCenter** Select the **Reports/Processes** tab, then select the **Time Categories Comparison** link.

This example illustrates the Absence Types - pivot grid



The Timesheet by Status pivot grid displays timesheet status data from TL\_RPTD\_TIME in a pie chart. A manager can view the summary of the timesheet status for all of the manager’s employees. The manager can filter the information using different levels of detail.

The grid view of this chart provides a link to the related Timesheet.

### Chart Content and Layout

The following table describes options for manipulating the chart:

<b>Option</b>	<b>Details</b>
<b>From and To</b>	Enter the starting and ending dates to define the date range for the pivot grid.
<b>Generate Report</b>	Select to display the pivot grid, based on the specified employees and the date range specified for the pivot grid.
 Prompts	Enter a specific value for any of the listed fields to modify the displayed pivot grid. The available fields are <b>Start Date, Dept ID, Supervisor ID, Reports to, NA Pay Group, GP Pay Group, Workgroup, Taskgroup, Position Number, End Date, Time Reporter Group, TRC Category 1 TRC Category 2, Employee ID, Empl Record, First Name, Last Name, Business Unit, Job Code, Job Description.</b>
Filters	<ul style="list-style-type: none"> <li>• Employee Type</li> <li>• Shift</li> <li>• Combo Code</li> <li>• Business Unit</li> <li>• PC Project</li> <li>• Taskgroup</li> <li>• Location</li> <li>• Workgroup</li> <li>• PC Project</li> <li>• Union Code</li> <li>• Org Relation</li> </ul>

<b><i>Option</i></b>	<b><i>Details</i></b>
Drill-down options	<ul style="list-style-type: none"> <li>• Employee ID</li> <li>• Time Reporting Code</li> <li>• Position Number</li> <li>• Job Description (Description of Job Code)</li> </ul>
Chart type options	<ul style="list-style-type: none"> <li>• Bar chart</li> <li>• Line chart</li> <li>• Pie chart</li> <li>• Horizontal bar chart</li> </ul>

## Labor Costs Page

Use the Labor Costs pivot grids (TL\_LBR\_IRPT) page to view an analysis report for the labor cost in terms of productivity or time categories.

Navigation:

- **Time and Labor > Reports > Interactive Reports > Labor Costs Report**
- **Manager Self Service > Time Management > Time and Labor WorkCenter** Select the **Reports/Processes** tab, then select the **Labor Costs** link.

This example illustrates the Absence Types - Labor Costs pivot grid

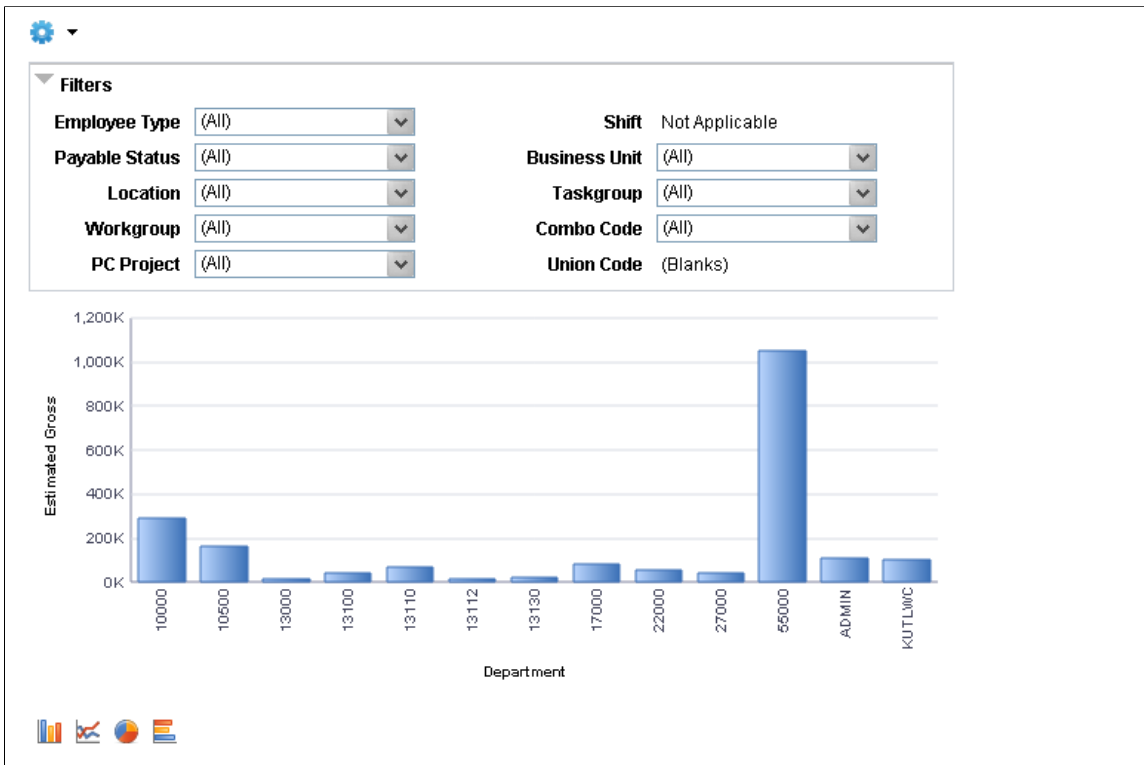

The Labor costs pivot grid depicts a bar chart with estimated gross for the employees calculated under different department ids.

The grid view of this chart provides a link to the related Timesheet.

### Chart Content and Layout

The following table describes options for manipulating the chart:

<b>Option</b>	<b>Details</b>
<b>From and To</b>	Enter the starting and ending dates to define the date range for the pivot grid.
<b>Generate Report</b>	Select to display the pivot grid, based on the specified employees and the date range specified for the pivot grid.
 Prompts	Enter a specific value for any of the listed fields to modify the displayed pivot grid. The available fields are <b>Start Date, Dept ID, Supv ID, Reports to, Location, Company, Pay Group, Workgroup, Taskgroup, Position, End Date, Time Group, TRC Category, ID, Empl Record, First Name, Last, Unit, Job Code, Job Descr.</b>

<b>Option</b>	<b>Details</b>
Filters	<ul style="list-style-type: none"> <li>• Business Type</li> <li>• Shift</li> <li>• Business Unit</li> <li>• Payable Status</li> <li>• Location</li> <li>• Taskgroup</li> <li>• Workgroup</li> <li>• Combo Code</li> <li>• PC Project</li> <li>• Union Code</li> <li>• Org Relation.</li> </ul>
Drill-down options	<ul style="list-style-type: none"> <li>• Employee ID</li> <li>• Time Reporting Code</li> <li>• Position Number</li> <li>• Job Description</li> <li>• Activity ID</li> <li>• Business Unit PC</li> <li>• Reports to Position No</li> <li>• Supervisor ID</li> <li>• Approver Name</li> </ul>
Chart type options	<ul style="list-style-type: none"> <li>• Bar chart</li> <li>• Line chart</li> <li>• Pie chart</li> <li>• Horizontal bar chart</li> </ul>



## Payable Time by Status Page

Use the Payable by Status page (TL\_PYTST\_IRPT) to get an insight to statuses that require monitoring and enables the user to take appropriate actions on these payable statuses.

Navigation:

- **Time and Labor > Reports > Interactive Reports > Payable Time by Status**
- **Manager Self Service > Time Management > Time and Labor WorkCenter** Select the **Reports/Processes** tab, then select the **Payable Time by Status** link.

This example illustrates the Absence Types - Payable Time by Status pivot grid

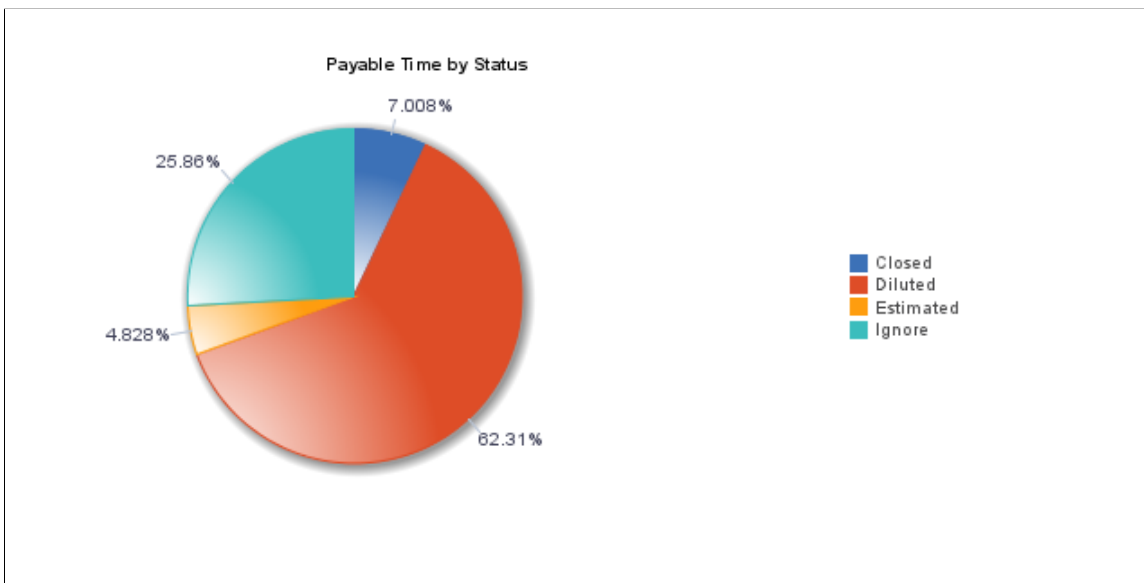

The grid view of this chart provides a link to the related Timesheet.

### Chart Content and Layout

The following table describes options for manipulating the chart:

<b>Option</b>	<b>Details</b>
<b>From and To</b>	Enter the starting and ending dates to define the date range for the pivot grid.
<b>Generate Report</b>	Select to display the pivot grid, based on the specified employees and the date range specified for the pivot grid.
 Prompts	Enter a specific value for any of the listed fields to modify the displayed pivot grid. The available fields are <b>Begin Date, Department, Supervisor ID, Reports to Position Number, Location, Company, NA Pay Group, GP Pay Group Workgroup, Taskgroup, Position Number, End Date, Time Reporter Group, Employee ID, Empl Record, First Name, Last Name, Business Unit, Job Code, Job Description.</b>

<b><i>Option</i></b>	<b><i>Details</i></b>
Filters	<ul style="list-style-type: none"> <li>• Pay Run ID</li> <li>• Calendar Group</li> <li>• Workgroup</li> <li>• Shift</li> <li>• Combo Code</li> <li>• Department</li> <li>• PC Project</li> <li>• Business Unit</li> <li>• Union Code</li> </ul>
Drill-down options	<ul style="list-style-type: none"> <li>• Employee</li> <li>• Approver</li> <li>• Supervisor ID</li> <li>• Report To</li> <li>• Task Group</li> <li>• Position Number</li> <li>• Time Reporting Code</li> </ul>
Chart type options	<ul style="list-style-type: none"> <li>• Bar chart</li> <li>• Line chart</li> <li>• Pie chart</li> <li>• Horizontal bar chart</li> </ul>

---

## Managing the Time and Labor WorkCenter

This section discusses how to specify and manage the tabs in the Time and Labor WorkCenter.

Use Tab Application pages to set up the Time and Labor WorkCenter tabs and pages.

## Understanding the Tab Application Framework

The Tab Application framework supports the following components in the Time and Labor WorkCenter:

- Approve Reported Time
- Approve Payable Time
- Approve Overtime Request
- Timesheet
- Mass Time
- Unprocessed Reported Time
- Overtime Request
- Overtime Balances
- Payable Time Summary
- Exceptions
- Unprocessed Payable Time
- Weekly Schedules and Weekly Time Calendar
- Leave and Compensatory Time
- Announcements

For more information on these components and the Time and Labor WorkCenter transaction area, see: [Understanding the Transaction Area of the Time and Labor WorkCenter](#)

## Pages Used to Manage the Time and Labor WorkCenter

<b>Page Name</b>	<b>Definition Name</b>	<b>Usage</b>
<a href="#">Configure Tab Page</a>	TL_TAB	Configure a Time and Labor WorkCenter tab and the contents of that tab.
<a href="#">Configure Tab Page Page</a>	TL_TAB_PAGE	Create or edit a tab page definition.
<a href="#">Manage Tab Application Page</a>	TL_TAB_APPL_MAN	Create, edit, or delete a Tab Application.
<a href="#">Configure Tab Application Page</a>	TL_TAB_APPL	Secondary page used to edit or create a tab application. Accessed from the Manage Tab Application page

### Configure Tab Page

Use the Configure Tab page (TL\_TAB) to define access to the Time and Labor WorkCenter tabs based on the roles and responsibilities assigned to the managers and administrators.

Navigation:

**Set Up HCM > Product Related > Time and Labor > Tab Application > Configure Tab**

This example illustrates the fields and controls on the Configure Tab page. You can find definitions for the fields and controls later on this page.

Select	Portal Label	*Page Name	Description	*Display Order	Starting Page	Page Name as Tab Label (Y/N)?
Select	Payable Time Summary	Search and Summary Page	MSS Search Page	1	<input checked="" type="checkbox"/>	<input type="checkbox"/>
Select	Unprocessed Payable Time	Unprocessed Time	Unprocessed Time Summary	2	<input type="checkbox"/>	<input type="checkbox"/>

<b>Field or Control</b>	<b>Description</b>
<b>Tab Id</b>	Unique ID to designate a tab definition
<b>Tab Label</b>	Text label displayed in a Main Tab
<b>Select</b>	Click on a link to choose a page or component to display on the tab specified in the <b>Tab Id</b> field. The system opens a modal window that you can use to browse for the page or component you want to display. Users can only see the links that they have permission to access.
<b>Page Name</b>	Select the page name to display. The system displays all of the pages included in the selected menu item and component.
<b>Display Order</b>	Use the fields in this column to specify the sequence of the displayed sub tabs.
<b>Starting Page</b>	Specify which of the pages is displayed first. You can only select one starting page.
<b>Page Name as Tab Label (Y/N)?</b>	Select to use the page name specified in this row as the tab label, rather than the portal label.

**Important!** The HCM Tab Framework does not allow some special characters - called Hot Keys - in tab labels. For example, & is considered a Hot Key. If you specify a Hot Key in a tab label, the HCM Tab Framework automatically removes the character.

**Configure Tab Page Page**

Use the Configure Tab Page page (TL\_TAB\_PAGE ) to create or edit tab page definitions. Use the fields in the Tabs region of this page to specify the main tab or tabs you want to include in a tab page.

Navigation:

**Set Up HCM > Product Related > Time and Labor > Tab Application > Configure Tab Page**

This example illustrates the fields and controls on the Configure Tab Page page. You can find definitions for the fields and controls later on this page.

### Configure Tab Page

**Tab Configuration ID** TL\_CFG\_WC

**\*Description**

*Tab Id	Tab Label	Display Order	Starting Page		
<input type="text" value="TL_MPT_TAB"/> 🔍	Manage Payable Time	<input type="text" value="3"/>	<input type="checkbox"/>	<input type="button" value="+"/>	<input type="button" value="-"/>
<input type="text" value="TL_MRT_TAB"/> 🔍	Manage Report Time	<input type="text" value="2"/>	<input type="checkbox"/>	<input type="button" value="+"/>	<input type="button" value="-"/>
<input type="text" value="TL_SCH_TAB"/> 🔍	Manage Schedules	<input type="text" value="4"/>	<input type="checkbox"/>	<input type="button" value="+"/>	<input type="button" value="-"/>
<input type="text" value="TL_WEL_TAB"/> 🔍	Welcome	<input type="text" value="1"/>	<input checked="" type="checkbox"/>	<input type="button" value="+"/>	<input type="button" value="-"/>

<i><b>Field or Control</b></i>	<i><b>Description</b></i>
<b>Tab Configuration ID</b>	This field shows a unique ID to designate a tab page definition.
<b>Tab Id</b>	Select a Tab ID, as specified on the Configure Tab page.
<b>Display Order</b>	Use this field to organize the sequence in which the tabs are displayed. You must enter a unique display order number for each Tab ID. The system displays an error message if more than one row has the same Display Order number.
<b>Starting Page</b>	Select the tab that displays first. You must select a starting tab.

**Note:** You must specify at least one Tab ID on this page, however, a tab page definition can contain up to eight tabs. When there is only one Tab ID specified, the Time and Labor WorkCenter component does not display the main tab.

## Manage Tab Application Page

Use the Manage Tab Application page(TL\_TAB\_APPL\_MAN) to create or edit tab page definitions.

This page lists any existing tab applications. You can create a new tab application by selecting the Create new Tab Application link. Selecting the Edit button for an existing tab application opens the Configure Tab Application page, where you specify the user roles that can access the tab application and the Tab Configuration ID, as specified on the Configure Tab page.

Navigation:

**Set Up HCM > Product Related > Time and Labor > Tab Application > Manage Tab Application**

This example illustrates the fields and controls on the Manage Tab Application page. You can find definitions for the fields and controls later on this page.

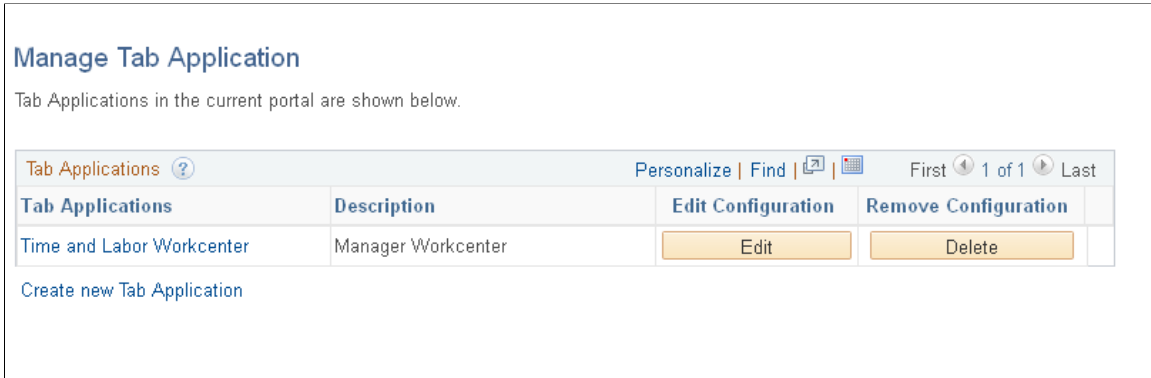

<i>Field or Control</i>	<i>Description</i>
<b>Edit</b>	Click to edit the specified Tab Application definition. The system opens the Configure Tab Application page where you can
<b>Delete</b>	Click to delete the specified Tab Application definition
<b>Create new Tab Application</b>	Click to create a new Tab Application.  Selecting the Edit button for an existing tab application opens the Configure Tab Application page, where you specify the user roles that can access the tab application and the Tab Configuration ID, as specified on the Configure Tab page.

## Configure Tab Application Page

Use the Configure Tab Application page (TL\_TAB\_APPL) to create or edit tab application definitions.

Navigation:

Click the **Edit** button in the Edit Configuration column of the Manage Tab Application page

This example illustrates the fields and controls on the Configure Tab Application page. You can find definitions for the fields and controls later on this page.

Configure Tab Application

**Configure Tab Appl (hidden)**

\*Tab Application Label

Portal Name EMPLOYEE

Portal Object Name HC\_TL\_WRKCNTN\_LAUNCH\_GBL Time and Labor WorkCenter

\*Description

Roles				Personalize   Find
*Role Name	Role Description	*Tab Configuration ID	Configuration Description	
<input type="text" value="Manager"/>	Manager	<input type="text" value="TL_CFG_WC"/>	Time and Labor Workcenter	+ -
<input type="text" value="Time &amp; Labor Admini"/>	Time & Labor Administrator	<input type="text" value="TL_ADM_WC"/>	Time & Labor WorkCenter Adm	+ -

**Special Handling Application Class**

Application Package

Application Path

Method

<b>Field or Control</b>	<b>Description</b>
<b>Tab Application Label</b>	Enter a name for the Tab Application definition. The system displays this label on the Manage Tab Application page, in the Tab Applications column.
<b>Portal Name and Portal Object Name</b>	Displays the name of the menu item selected for this Tab Application.
<b>Description</b>	Enter a description for this Tab Application
<b>Role Name</b>	Select the Role of users that can access this Tab Application. The available values in this field are the Roles that are authorized to access the menu item specified in the Portal Name field.
<b>Tab Configuration ID</b>	Select a Tab Configuration ID created on the Configure Tab Page page.
<b>Special Handling Application Class</b>	The fields in this region enable you to enter an Application Class Path and class. The Application Class performs special processing of the tab set up data. For example, in Time and Labor, when the Approval Workflow Engine is not installed, the related component is not returned for Pending Reported Time Approval and Pending Payable Time Approval.





## Chapter 32

# Using Time and Labor Dashboard

---

## Understanding Time and Labor Dashboard

This topic discusses pagelets, Setup, and working with Dashboard:



### Time and Labor Dashboard

The dashboard provides a one stop shop for a manager to process time related transactions and analytics. The dashboard contains Selection Criteria that enables you to select the data that you want to view in the dashboard. Each pagelet within the dashboard is controlled by the Selection Criteria entered. The Dashboard contains Quick Links to access the Timesheet, Payable Time Summary, Payable Time Detail, and Time Reporter Status, Analytic pagelets to review payable time and schedule deviations, and Approval pagelets to approve, deny, or push back overtime, absence, reported time, or payable time.

### Common Elements Used with Time and Labor Dashboard

These terms are commonly used when referring to the Time and Labor Dashboard:

<i>Term</i>	<i>Description</i>
Selection Criteria	To reflect the changes in the rest of the pagelets and analytics, selection Criteria fields are used. The values can be changed on the Selection Criteria and used to refresh the other pagelets on the dashboard.  This is also named as Publishing pagelet.
Subscribing Pagelet	The subscribing pagelet contains Approval pagelet and Analytics pagelet.
Approval Pagelet	A common pagelet that contains links to application-designed results pages. The content is filtered by administrator or end user defined criteria. The <b>Reported Time Approvals</b> , <b>Payable Time Approvals</b> , and <b>Overtime Requests</b> are the items in Approval pagelet.
Analytics Pagelet	A collection of application-defined pagelets that contain links, task lists, and other content. This area is part of the PeopleTools framework but the pagelet content is defined by individual product needs.

<b>Term</b>	<b>Description</b>
Quick Links	A common pagelet that contains links to queries (public or private) that are added by the administrator (public queries) or the end-user (public or private queries).
	<p>Click to refresh data display on the corresponding pagelet. Press the F5 key or the refresh button of the web browser to refresh all pagelets in the entire dashboard.</p> <hr/> <p><b>Note:</b> Refresh the dashboards for the latest operational data to be displayed.</p> <hr/>
	Click to <b>Minimize</b> and <b>Remove</b> the pagelet in the entire dashboard.

---

## Working with Time and Labor Dashboard

The Time and Labor Dashboard is a collection of pagelets that provides the user with both functional and actionable information. It is summaries of information useful for a manager regarding the managers direct and indirect reports. Using the pagelets, managers can focus on items needing their attention and to act on those items by providing an immediate update from within the dashboard or by transferring to a specific application component.

Video: [PeopleSoft Time and Labor Dashboard](#)

Use Time and Labor Dashboard (TL\_MNG\_APRV\_PG\_LT) to view a collection of pagelets that provides the user with functional and actionable information.

This example illustrates the fields and controls on the Time and Labor Dashboard.

Navigation:

**Manager Self Service > Time Management > Time and Labor Dashboard**

This example illustrates the fields and controls on the Time and Labor Dashboard page 1 of 2.

The screenshot shows the 'Time and Labor Dashboard' interface. At the top, there are 'Selection Criteria' fields for Time Reporter Group, Last Name, Workgroup, Employee ID, First Name, Empl Record, and Supervisor ID. Below this, the 'Payable Time' section features a pie chart showing 25.93% for Regular and 74.07% for Overtime, along with a summary table. The 'Reported Time Approvals' section displays a table of employee-reported time with columns for Name, TRC Category, and Quantity Type, and includes buttons for 'Approve', 'Deny', and 'Push Back'.

TRC Category	Description	Total Payable Hours	Needs Approval
REG	Regular	40.00	40.00
KOVT	Overtime	14.00	14.00

Name	TRC Category	Quantity Type
Allan Simson	Regular	28.00 Hours
Brain Marks	Regular	28.00 Hours
Courtney Salvador	Regular	48.00 Hours
Daren Noren	Regular	41.75 Hours
Denck Roshs	Regular	28.00 Hours
Ian Nihal	Regular	46.00 Hours
Richard Isaac	Regular	42.75 Hours
Richie Refina	Regular	28.00 Hours

<b>Term</b>	<b>Definition</b>
<b>Selection Criteria</b>	The changes in the fields updates the details in other pagelets. Click <b>Search</b> to update the pagelets.
<b>Reported Time</b>	<p>This pagelet displays all the Reported Time approval requests categorized by TRC Category.</p> <p>This pagelet lists the employees according to their TRC Category and you can <b>Approve</b>, <b>Deny</b> or <b>Push Back</b> the reported time, if needed.</p> <p><b>View Detail</b> link shows all the approval details of all the employees.</p> <p><b>Name</b> is a hyperlink that opens a modal window with the details under the employee for the category.</p> <p><b>Select All /Deselect All</b> selects or deselects all the rows on the grid for approval actions – <b>Approve</b>, <b>Deny</b>, and <b>Push Back</b>.</p>
<b>Payable Time</b>	This pagelet provides the payable time summary and details by TRC or TRC category for a given period of time. The period defaults to the to the current period but can be changed to a different period or date range.

This example illustrates the fields and controls on the Time and Labor Dashboard page 2 of 2.

The screenshot displays three main sections of the dashboard:

- Overtime Requests:** A table listing requests for Ian Nihal and Allan Simson on 12/26/2012, each for 4.00 hours. Below the table are buttons for 'Approve', 'Deny', and 'Push Back', and a 'View Details' link.
- Payable Time Approvals:** A section with a 'TRC Category' dropdown set to 'All Categories'. It features a 'Payable Time' table with columns for Name, TRC Category, and Quantity Type. The table lists employees: Ronald Carlo (Regular, 40.00 Hours), Gregory Godwin (Regular, 40.00 Hours), Chris Kevin (Overtime, 14.00 Hours), Chris Kevin (Regular, 80.00 Hours), and Harris Avilla (Regular, 46.25 Hours). Below the table are 'Select All' and 'Deselect All' options, followed by 'Approve', 'Deny', and 'Push Back' buttons, and a 'View Details' link.
- Schedule Deviation:** A bar chart for the period 03/03/2014 - 03/09/2014. The Y-axis is 'Labor Hours' (0 to 700). The X-axis is 'Time Reporting Period'. The chart shows four series: Scheduled Time (blue), Scheduled to Date (purple), Reported Time (orange), and Approved Time (green). Below the chart is a 'Summary' table:

Period Start Date	Scheduled Hours	Sched to Date	Reported Hours	Approved Hours	Variance Hours
03/03/2014	600.00	365.00	54.00	54.00	-312.00

<b>Term</b>	<b>Definition</b>
<b>Overtime Requests</b>	Displays all the overtime approval requests for all the employees that report to the logged in Manager. The default list is controlled by Manager Search options.
<b>Payable Time Approvals</b>	<p>This pagelet displays all the Payable Time approval requests categorized by TRC Category.</p> <p>This pagelet lists the employees according to their TRC Category and you can now <b>Approve</b> , <b>Deny</b> or <b>Push Back</b> the reported time, if needed.</p>
<b>Schedule Deviation</b>	This analytic shows data for scheduled, reported, scheduled to date and approved time by time reporting period. The date range is treated 'as is', and one set of bars will be shown for each time type (scheduled, reported, and approved). The set of bars (series) are corresponding to TRC Category, so there will be three/ four sets of bars altogether.
<b>Quick Links</b>	You can navigate to different pages like Timesheet, Payable Time Summary, Payable Time Detail and Time Reporter Status using Quick Links.

<b>Term</b>	<b>Definition</b>
<b>Absence Request</b>	<p>This pagelet lists all the AWE Absence Approval requests that are assigned based on the userid of the person entering the dashboard. This loads all absence approvals that are assigned to one user.</p> <p>This pagelet enables the direct line manager to approve, deny, or push back absence requests. Absence request are generated directly through the Employee/Manager Absence Management or Timesheet pages.</p> <p>For more details, see “Managing Manager Self Service Pages” (PeopleSoft Absence Management)</p>

## Viewing the Time and Labour Dashboard pagelets

The analytics and approval pagelets return data based on the Manager Search Options with Time and Labor Group Security or HR Security. The fields which are available on the standard Manager Search page appears on the Dashboard Selection Criteria pagelet, along with any values that have been assigned to those fields.

The Dashboard Selection Criteria pagelet is a standard Manager Self Service (MSS) search criteria page. The initial values come from the MSS page and are displayed on the search pagelet. The values can be changed on this pagelet and are used to refresh the other pagelets on the dashboard. The search pagelet does not allow the MSS values to be saved. The search pagelet drives the employee search criteria for all of the analytics and all of the approvals pagelets except Absence Requests. Absence Request uses the tools Inter-Window Communications (IWC) feature to publish the search field values to the other pagelets, which will then refresh the data using the new search criteria.

This example illustrates the fields and controls on the Reported Time Approval pagelet. You can find definitions for the fields and controls later on this page.

The Selection Criteria pagelet is the publishing pagelet. On selecting the Search button, the subscribing pagelets which include approval and analytics pagelets are refreshed according to the search values.

The following are the list of approval pagelets:

- Reported Time
- Payable Time
- Overtime Requests
- Absence Requests

## Approval pagelet for Reported Time

This pagelet displays all the reported time approval requests that requires approval actions by a manager. It groups the requests on summary level and by the Employee, TRC Category, and TRC Type. The manager can drill down all the details on each employee by selecting the employee name or by selecting the View Details link at the bottom of the pagelet.

This example illustrates the fields and controls on the Reported Time Approval pagelet. You can find definitions for the fields and controls later on this page.

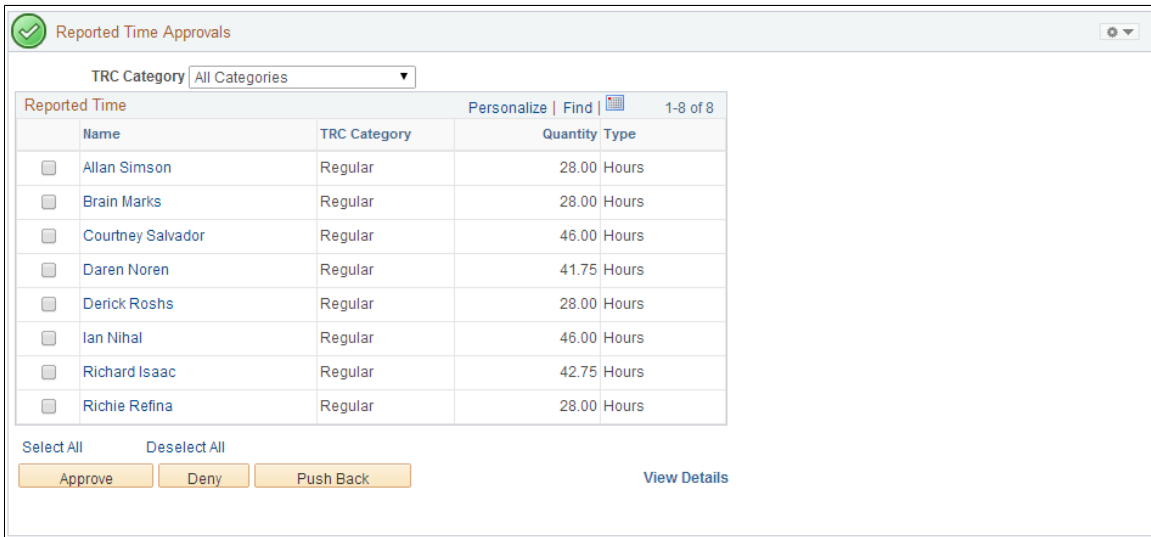

<b>Field or Control</b>	<b>Description</b>
<b>Name</b>	Name hyperlink opens a modal window with the details under the employee for the category.
<b>Select All / Deselect All</b>	To select or deselect all the rows on the grid for approval actions – Approve, Deny, and Push Back.
<b>View Details</b>	Opens a modal window which shows all the details for the entire employee on the home page.

## Approval pagelet for Payable Time

This pagelet displays all pending payable time approval requests categorized by TRC Category for a Manager. The values are inherited from the Manager Search Options settings from the Dashboard Selection Criteria pagelet. Manager has an option to select an employee or a group of employee or all employees to take necessary Approval Action from the View Details page.

This example illustrates the fields and controls on the Payable Time Approval pagelet. You can find definitions for the fields and controls later on this page.

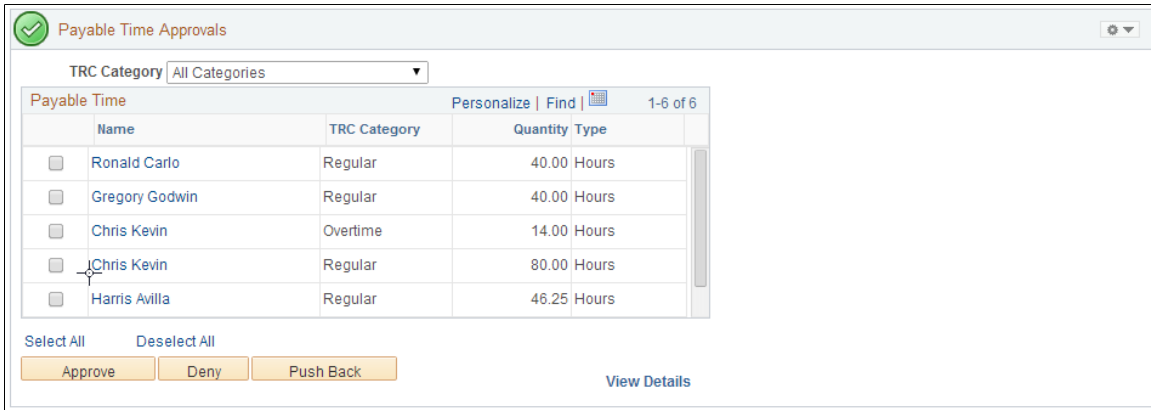

<b>Field or Control</b>	<b>Description</b>
<b>Name</b>	Name hyperlink opens a modal window with the details under the employee for the category.
<b>Select All / Deselect All</b>	To select or deselect all the rows on the grid for approval actions – Approve, Deny, and Push Back.
<b>View Details</b>	Opens a modal window which shows all the details for the entire employee on the home page.

### Approval pagelet for Overtime Requests

This pagelet displays all the overtime approval requests for all the employees who reports to a Manager.

This example illustrates the fields and controls on the Overtime Approval pagelet. You can find definitions for the fields and controls later on this page.

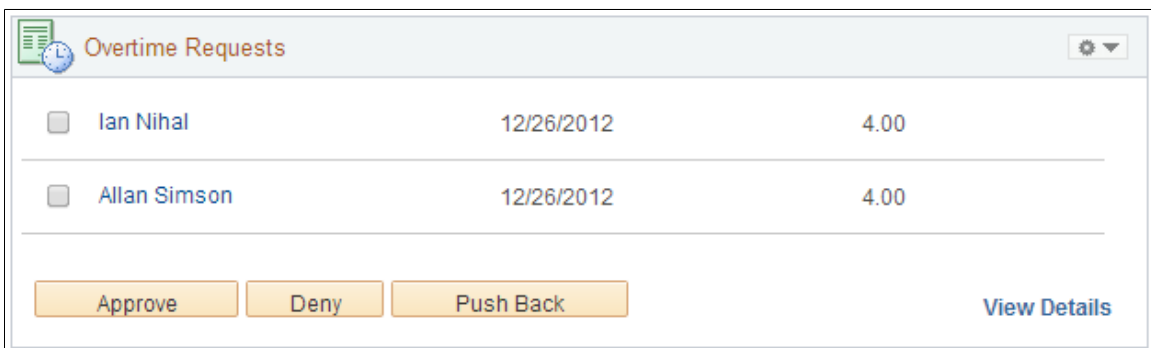

<b>Field or Control</b>	<b>Description</b>
<b>View Details</b>	Opens a modal window which shows all the details for the entire employee on the home page.

### Approval pagelet for Absence Requests

This approval pagelet supports Absence AWE transactions that originate from either Employee Self Service or Manager Self Service.

This example illustrates the fields and controls on the Absence Request Approval pagelet. You can find definitions for the fields and controls later on this page.

The screenshot shows a pagelet titled "Absence Request" with a list of requests. Each row includes a checkbox, an employee name (a hyperlink), an absence type, a date, and a duration. At the bottom of the pagelet are three buttons: "Approve", "Deny", and "Push Back", along with a "View Details" link.

Employee	Type	Date	Duration
<a href="#">Allan Simson</a>	Sick Take	03/06/2014	8 Hours
<a href="#">Richie Refina</a>	Vacations	10/05/2012	4 Hours
<a href="#">Brain Marks</a>	Vacations	10/05/2012	4 Hours
<a href="#">Derick Roshs</a>	Vacations	10/05/2012	4 Hours
<a href="#">Allan Simson</a>	Vacations	10/05/2012	4 Hours
<a href="#">Allan Simson</a>	Sick Take	10/01/2012	8 Hours
<a href="#">Richie Refina</a>	Sick Take	10/01/2012	8 Hours
<a href="#">Brain Marks</a>	Sick Take	10/01/2012	8 Hours
<a href="#">Derick Roshs</a>	Sick Take	10/01/2012	8 Hours

The name of the employee in the pagelet is a hyperlink that will take the user to the Absence detail page. This page allows the user to see the details of the individual employee. When an absence is transacted in the pagelet, the user receives a confirmation message.

<b>Field or Control</b>	<b>Description</b>
<b>View Details</b>	Opens a modal window which shows all the details for the entire employee on the home page.



## Analytics pagelets

The following are the analytics pagelets:

- Schedule Deviation
- Payable Time

### Schedule Deviation Analytics

This analytic is designed to answer business questions about the relationship of scheduled time, reported time and approved time.

- How are my reported/approved hours compared to scheduled hours?
- Which employees are not following their schedule?
- Which employees have exceeded their scheduled hours?
- Are there employees whose reported hours seem incomplete?
- What are the departments that show greater schedule deviation?
- What job codes have higher schedule deviation?

This example illustrates the fields and controls on the Schedule Deviation analytics pagelet. You can find definitions for the fields and controls later on this page.

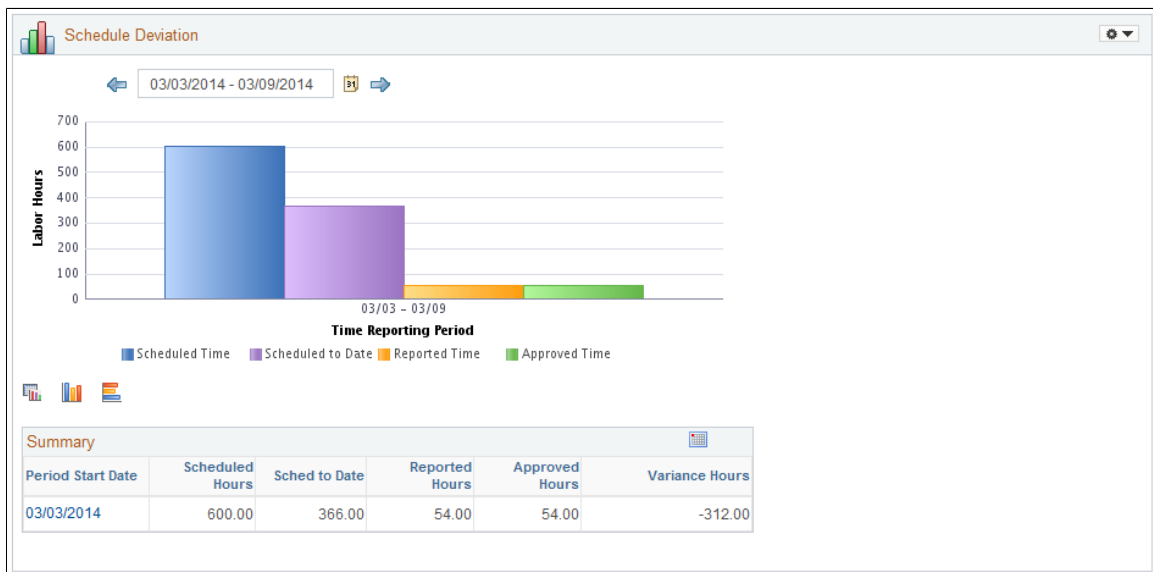

The data gathered are:

- Schedule Time
  - Schedule to Date
  - Reported Time
- and

- Approved Time.

### Analytics for Payable Time

The purpose of this analytic is to answer the following questions:

- How many hours have been calculated based on the business rules?
- How many hours of overtime have been calculated?
- Which employees have incurred overtime and how much?
- What other types of hours have the rules calculated?
- What are my estimated costs based on the business rules?

This example illustrates the fields and controls on the Payable Time analytics pagelet. You can find definitions for the fields and controls later on this page.

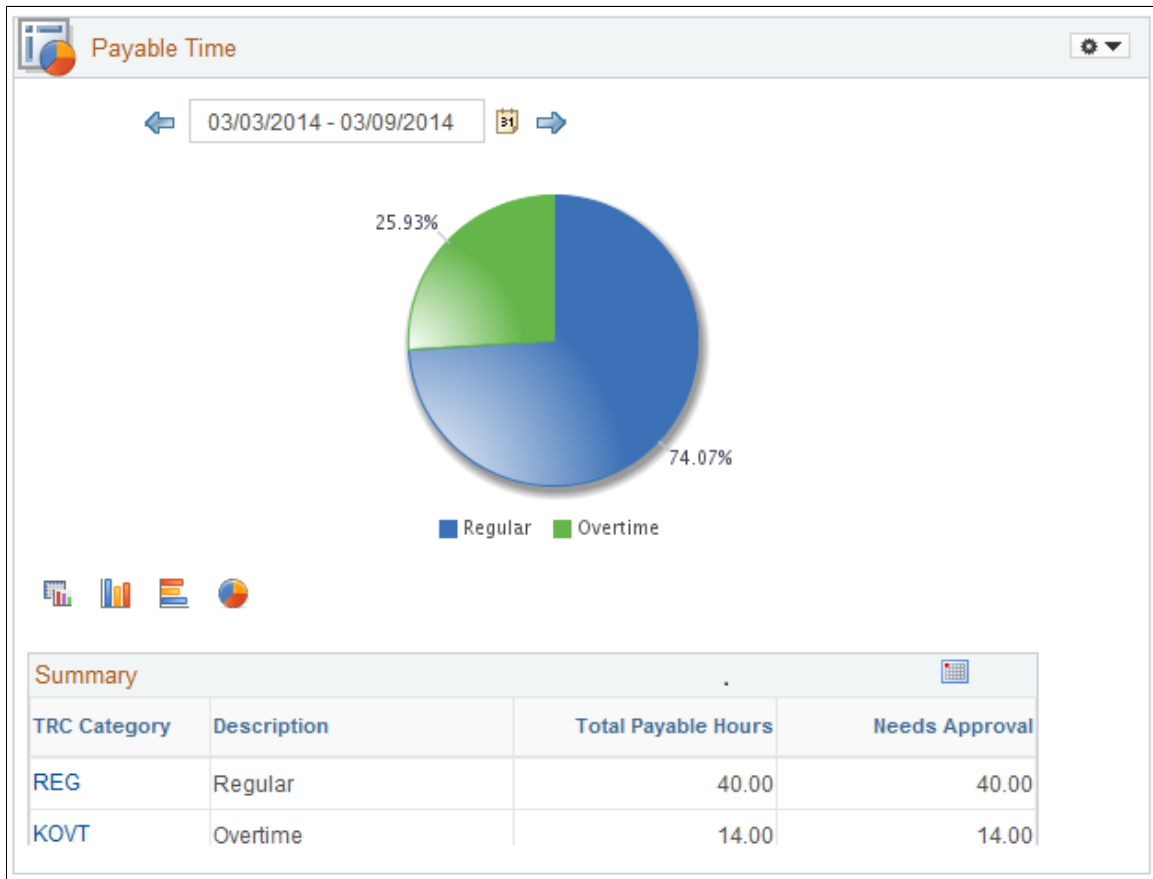

This analytic is based on the Payable Time Table. It pulls all TRC's with a TRC type of hours. The default type of chart is a pie chart.

# Exceptions and Validations

## Understanding Exceptions and Validations

The following is a list of validations and exceptions, ordered by validation definition ID number. All of these validations can be configured to run in Submit Time and Time Administration. For validations on time reporting elements that are selected to be processed in Submit Time, you can choose not to run these during the Time Administration process to increase performance time.

**Note:** All exceptions listed in this table are delivered with a high severity level except TLX01700 and TLX01710, which are delivered with a low severity level. If you modify high severity exceptions by selecting the **Allowable** check box on the Exception Definition page, in some cases payable time is still not created, even though the exception is allowed on the Manage Exceptions page.

See [Defining Exceptions](#), [Managing Exceptions](#).

<i>Nbr</i>	<i>Validation Definition ID</i>	<i>Validation Definition</i>	<i>Validation Comments</i>	<i>Exception Definition ID</i>	<i>Exception Descr.</i>
1	TLX00030	Time Reporting Status Check	Verify that the TIME_RPTG_STATUS of the time reporter on the TL_EMPL_DATA record is 'Active', as of the date reported.	TLX00030	Inactive Time Reporter Status
2	TLX00040	Valid Taskgroup	Verify that the Taskgroup is in the TL_TASKGRP_TB as of the date reported.	TLX00040	Invalid Taskgroup
3	TLX00060	Valid Task Profile ID	Verify that the Task Profile ID is in the TL_TSKPRF table as of the date reported.	TLX00060	Invalid Task Profile

<b>Nbr</b>	<b>Validation Definition ID</b>	<b>Validation Definition</b>	<b>Validation Comments</b>	<b>Exception Definition ID</b>	<b>Exception Descr.</b>
4	TLX00080	Task Prof in Borrowed Tskgrp	Verify that the Task Profile ID is in the TL_TSKGRP_PRFL table for the task group to which the time reporter has been borrowed as of the date reported.	TLX00080	Task Profile not in Taskgroup
5	TLX00090	All/ None Req'd Task Elements	Verify that either all or none of the required task elements of the task template have been reported.	TLX00090	Task Values Required
6	TLX00100	Task Elements not allowed	Verify that the time reporter does not report task elements that are not available on the task template.	TLX00100	Invalid Task Value
7	TLX00110	ACCT_CD in TL_COMM_ACCT_VW	Verify that the Combo Code reported exists in the TL_COMM_ACCT_VW when the TASK_PROFILE_ID is not reported, the Combo Code is a required field on the task template.	TLX00110	Invalid Combo Code
8	TLX00120	BUSINESS_UNIT is Reported	Verify that the BUSINESS_UNIT reported exists in the BUS_UNIT_TBL_HR table when the TASK_PROFILE_ID is not reported and BUSINESS_UNIT is a required field on the task template.	TLX00120	Invalid HR Business Unit

<b>Nbr</b>	<b>Validation Definition ID</b>	<b>Validation Definition</b>	<b>Validation Comments</b>	<b>Exception Definition ID</b>	<b>Exception Descr.</b>
9	TLX00130	BUSINESS_UNIT_PC	Verify that BUSINESS_UNIT_PC is not reported when PS/Projects is not installed.	TLX00130	Invalid Value for Task Templt
10	TLX00141	BUSINESS_UNIT_PF	Verify that the BUSINESS_UNIT_PF reported exists in the BUS_UNIT_TBL_PF table when TASK_PROFILE_ID is not reported, and PS/Projects is not installed.	TLX00141	Invalid Business Unit PF
11	TLX00150	COMPANY	Verify that the COMPANY reported exists in the COMPANY_TBL when TASK_PROFILE_ID is not reported.	TLX00150	Invalid Company
12	TLX00160	LOCATION	Verify that the LOCATION reported exists in the TL_LOCATION_VW when TASK_PROFILE_ID is not reported.	TLX00160	Invalid Location
13	TLX00170	JOBCODE	Verify that the JOBCODE reported exists in the TL_JOBCODE_VW when TASK_PROFILE_ID is not reported.	TLX00170	Invalid Jobcode
14	TLX00180	POSITION_NBR	Verify that the POSITION_NBR reported exists in the POSITION_DATA table when TASK_PROFILE_ID is not reported.	TLX00180	Invalid Position Number

<b>Nbr</b>	<b>Validation Definition ID</b>	<b>Validation Definition</b>	<b>Validation Comments</b>	<b>Exception Definition ID</b>	<b>Exception Descr.</b>
15	TLX00190	CUSTOMER	Verify that the CUSTOMER reported exists in the TL_CUSTOMER table when TASK_PROFILE_ID is not reported.	TLX00190	Invalid Customer
16	TLX00200	DEPTID	Verify that the DEPTID reported exists in the TL_DEPT_TBL_VW when TASK_PROFILE_ID is not reported.	TLX00200	Invalid Department
17	TLX00211	PRODUCT	Verify that the PRODUCT reported exists in the PRODUCT_TBL when TASK_PROFILE_ID is not reported and the COMMIT_ACCTG_FLG on the task template is 'N'.	TLX00211	Invalid Product
18	TLX00220	TASK	Verify that the TASK reported exists in the TL_TASK table when TASK_PROFILE_ID is not reported.	TLX00220	Invalid Task
19	TLX00230	ACTIVITY_ID	Verify that the ACTIVITY_ID reported exists in the TL_PROJ_ACTV_VW when TASK_PROFILE_ID is not reported and PS/Projects is installed.	TLX00230	Invalid Activity ID

<b>Nbr</b>	<b>Validation Definition ID</b>	<b>Validation Definition</b>	<b>Validation Comments</b>	<b>Exception Definition ID</b>	<b>Exception Descr.</b>
20	TLX00231	ACTIVITY_ID	Verify that the ACTIVITY_ID reported exists in the TL_ACTIVITY table when TASK_PROFILE_ID is not reported and both PS/Projects and PS/EPM are not installed.	TLX00231	Invalid Activity ID
21	TLX00232	ACTIVITY_ID	Verify that the ACTIVITY_ID reported exists in the TL_FS_ACTV_VW when TASK_PROFILE_ID is not reported, PS/EPM is installed, and PS/Projects is not installed.	TLX00232	Invalid Activity ID
22	TLX00240	RESOURCE_TYPE	Verify that RESOURCE_TYPE is not reported when PS/Projects is not installed.	TLX00240	Invalid Value for Task Templt
23	TLX00241	RESOURCE_TYPE	Verify that the RESOURCE_TYPE reported exists in TL_PROJ_RTYPE_V when TASK_PROFILE_ID is not reported and PS/Projects is installed.	TLX00241	Invalid Resource Type
24	TLX00251	PROJECT_ID	Verify that the PROJECT_ID reported exists in the TL_PROJECT table when TASK_PROFILE_ID is not reported and the COMMIT_ACCTG_FLG on task template is 'N' and PS/Projects is not installed.	TLX00251	Invalid Project ID

<b>Nbr</b>	<b>Validation Definition ID</b>	<b>Validation Definition</b>	<b>Validation Comments</b>	<b>Exception Definition ID</b>	<b>Exception Descr.</b>
25	TLX00254	PROJECT_ID	Verify that the PROJECT_ID reported exists in the TL_PROJ_TEAM_DVW when TASK_PROFILE_ID is not reported, COMMIT_ACCTG_FLG on task template is 'N', PS/Projects is installed, and ENFORCE on the PROJECT table is 'Y'.	TLX00254	Invalid Project ID
26	TLX00260	RESOURCE_CATEGORY	Verify that RESOURCE_CATEGORY is not reported when TASK_PROFILE_ID is not reported and PS/Projects is not installed.	TLX00260	Invalid Value for Task Templt
27	TLX00261	RESOURCE_CATEGORY	Verify that the RESOURCE_CATEGORY reported exists in the TL_PROJ_CATG_V2 when TASK_PROFILE_ID is not reported, PS/Projects is installed, and CATEGORY_EDIT on BUS_UNIT_TBL_PC is 'REL' indicating that Resource Category is related to Resource Type.	TLX00261	Invalid Resource Category



<b>Nbr</b>	<b>Validation Definition ID</b>	<b>Validation Definition</b>	<b>Validation Comments</b>	<b>Exception Definition ID</b>	<b>Exception Descr.</b>
28	TLX00262	RESOURCE_CATEGORY	Verify that the RESOURCE_CATEGORY reported exists in TL_PROJ_CATG_VW when TASK_PROFILE_ID is not reported, PS/Projects is installed and CATEGORY_EDIT on BUS_UNIT_TBL_PC is 'IND' indicating that Resource Category is independent of Resource Type.	TLX00262	Invalid Resource Category
29	TLX00270	RESOURCE_SUB_CAT	Verify that RESOURCE_SUB_CAT is not reported when TASK_PROFILE_ID is not reported and PS/Projects is not installed.	TLX00270	Invalid Value for Task Templt
30	TLX00280	RESOURCE_SUB_CAT	Verify that the RESOURCE_SUB_CAT reported exists in TL_PROJ_SUB_V2 when TASK_PROFILE_ID is not reported, PS/Projects is installed and SUBCATEGORY_EDIT on BUS_UNIT_TBL_PC is 'REL' indicating that Resource Subcategory is related to Resource Category.	TLX00280	Invalid Resource Subcategory

<b>Nbr</b>	<b>Validation Definition ID</b>	<b>Validation Definition</b>	<b>Validation Comments</b>	<b>Exception Definition ID</b>	<b>Exception Descr.</b>
31	TLX00281	RESOURCE_SUB_CAT	Verify that the RESOURCE_SUB_CAT reported exists in TL_PROJ_SUB_VW when TASK_PROFILE_ID is not reported, PS/Projects is installed and SUBCATEGORY_EDIT on BUS_UNIT_TBL_PC is 'IND' indicating that Resource Subcategory is independent of Resource Category.	TLX00281	Invalid Resource Subcategory
32	TLX00310	Bus Unit Rptd/ Other Flds Req	Verify that BUSINESS_UNIT is reported when TASK_PROFILE_ID is not reported and DEPTID, LOCATION and JOBCODE are required fields on the task template.	TLX00310	Required Value for Task Templt
33	TLX00320	BUSINESS_UNIT_PC	Verify that BUSINESS_UNIT_PC is reported when TASK_PROFILE_ID is not reported, PS/Projects is installed, COMMIT_ACCTG_FLG is 'N' and PROJECT is a required field on the task template.	TLX00320	Required Value for Task Templt
34	TLX00330	BUSINESS_UNIT_PF	Verify that BUSINESS_UNIT_PF is not reported when COMMIT_ACCTG_FLG is 'Y' on the task template and both PS/Projects and PS/EPM are not installed.	TLX00330	Invalid Value for Task Templt

<b>Nbr</b>	<b>Validation Definition ID</b>	<b>Validation Definition</b>	<b>Validation Comments</b>	<b>Exception Definition ID</b>	<b>Exception Descr.</b>
35	TLX00340	BUSINESS_UNIT_PF	Verify that BUSINESS_UNIT_PF is reported when TASK_PROFILE_ID is not reported, PS/Projects is not installed, COMMIT_ACCTG_FLG is 'Y', PS/EPM is installed and ACTIVITY_ID is a required field on the task template.	TLX00340	Required Value for Task Templt
36	TLX00350	POSITION_NBR	Verify that POSITION_NBR is not reported when POSITION_MGMT on INSTALLATION table is 'N'.	TLX00350	Invalid Value for Task Templt
37	TLX00361	PROJECT_ID	Verify that PROJECT_ID is not reported when both PS/Projects and PS/EPM are installed, COMMIT_ACCTG_FLG is 'N', and both BUSINESS_UNIT_PF and ACTIVITY are required fields on the task template.	TLX00361	Invalid Value for Task Templt
38	TLX00370	RESOURCE_CATEGORY	Verify that RESOURCE_CATEGORY is not reported when PS/Projects is installed but PROJECT is not available on the task template.	TLX00370	Invalid Value for Task Templt

<i><b>Nbr</b></i>	<i><b>Validation Definition ID</b></i>	<i><b>Validation Definition</b></i>	<i><b>Validation Comments</b></i>	<i><b>Exception Definition ID</b></i>	<i><b>Exception Descr.</b></i>
39	TLX00380	RESOURCE_SUB_CAT	Verify that RESOURCE_SUB_CAT is not reported when PS/Projects is installed and PROJECT is not available on task template.	TLX00380	Invalid Value for Task Templt
40	TLX00390	RESOURCE_TYPE	Verify that RESOURCE_TYPE is not reported when PS/Projects is installed and PROJECT is not available on the task template.	TLX00390	Invalid Value for Task Templt
41	TLX00400	No Tsk Elmnts with Tsk Prof	Verify that no individual Task Elements are reported when TASK_PROFILE_ID is reported.	TLX00400	Invalid entry of Task Elements
42	TLX00410	BUS_UNIT_PC vs BUS_UNIT_PF	Verify that both BUSINESS_UNIT_PC and BUSINESS_UNIT_PF are not reported at the same time.	TLX00410	Invalid Values for Task Templt
43	TLX00420	Valid TRC	Verify that the reported TRC exists in the TL_TRC_TBL.	TLX00420	Invalid TRC
44	TLX00440	TRC is in TRC Program	Verify that the TRC is in the TRC Program to which the time reporter is affiliated as of the date reported.	TLX00440	TRC is not in TRC Program

<b>Nbr</b>	<b>Validation Definition ID</b>	<b>Validation Definition</b>	<b>Validation Comments</b>	<b>Exception Definition ID</b>	<b>Exception Descr.</b>
45	TLX00450	MIN_QTY & MAX_QTY	Verify that the TL_QUANTITY reported is within the limits specified by the MIN_QTY and the MAX_QTY on the TL_TRC_TBL.	TLX00450	Quantity exceeds TRC limits
46	TLX00480	COMP_RATECD	Verify that the COMP_RATECD reported is neither of 'Percent' type nor of 'Points' type.	TLX00480	Invalid Comp Rate Code Type
47	TLX00490	Hours Type TRC & COMP_RATECD	Verify that when both Hours type TRC and COMP_RATECD are reported, the COMP_RATECD is either 'Hourly Flat Rate (HF)' type or 'Hourly Rate (HR)' type.	TLX00490	Invalid Comp Rate Code Type
48	TLX00500	Amount Type TRC & COMP_RATECD	Verify that when both Amount type TRC and COMP_RATECD are reported, COMP_RATECD is of 'Flat Amount (FA)' type.	TLX00500	Invalid Comp Rate Code Type
49	TLX00510	Units Type TRC & COMP_RATE_CD	Verify that when a Units type TRC is reported, no COMP_RATECD is reported.	TLX00510	Invalid Comp Rate Code Type
50	TLX00520	COMP_RATECD & TRC Reported	Verify that a TRC is reported when a COMP_RATECD is reported.	TLX00520	TRC needed for Comp Rate Code
51	TLX00530	COMP_RATECD	Verify that if a COMP_RATECD is reported, it is a valid COMP_RATECD.	TLX00530	Invalid Comp Rate Code

<b>Nbr</b>	<b>Validation Definition ID</b>	<b>Validation Definition</b>	<b>Validation Comments</b>	<b>Exception Definition ID</b>	<b>Exception Descr.</b>
52	TLX00560	BILLABLE_IND	Verify that BILLABLE_IND reported in Elapsed Time has the value of either 'Y' or 'N'.	TLX00560	Invalid Billable Indicator
53	TLX00570	COUNTRY	Verify that the COUNTRY reported in Elapsed Time is in the COUNTRY_TBL.	TLX00570	Invalid Country
54	TLX00590	CURRENCY_CD	Verify that the CURRENCY_CD reported in Elapsed Time is in the CURRENCY_CD_TBL.	TLX00590	Invalid Currency Code
55	TLX00600	LOCALITY	Verify that the LOCALITY reported in Elapsed Time is in the LOCAL_TAX_TBL.	TLX00600	Invalid Locality
56	TLX00620	OVERRIDE_RSN_CD	Verify that the OVERRIDE_RSN_CD reported in Elapsed Time is in the TL_OVRD_RSN_TBL.	TLX00620	Invalid Override Reason Code
57	TLX00640	RULE_ELEMENT_1	Verify that the RULE_ELEMENT_1 reported is in the TL_RULE_ELEMENT1 table.	TLX00640	Invalid Rule Element 1
58	TLX00650	RULE_ELEMENT_2	Verify that the RULE_ELEMENT_2 reported is in the TL_RULE_ELEMENT2 table.	TLX00650	Invalid Rule Element 2
59	TLX00660	RULE_ELEMENT_3	Verify that the RULE_ELEMENT_3 reported is in the TL_RULE_ELEMENT3 table.	TLX00660	Invalid Rule Element 3

<b>Nbr</b>	<b>Validation Definition ID</b>	<b>Validation Definition</b>	<b>Validation Comments</b>	<b>Exception Definition ID</b>	<b>Exception Descr.</b>
60	TLX00670	RULE_ELEMENT_4	Verify that the RULE_ELEMENT_4 reported is in the TL_RULE_ELEMENT4 table.	TLX00670	Invalid Rule Element 4
61	TLX00680	RULE_ELEMENT_5	Verify that the RULE_ELEMENT_5 reported is in the TL_RULE_ELEMENT5 table.	TLX00680	Invalid Rule Element 5
62	TLX00740	STATE	Verify that the STATE reported is in the STATE_NAMES_TBL.	TLX00740	Invalid State
63	TLX00830	COMMIT_ACCTG_FLAG vs. USE_DIST	Validate that the Commitment Accounting Flag on the time reporter's borrowed Taskgroup matches the Commitment Accounting Flag of the Department assigned in JOB, when Taskgroup is reported.	TLX00830	Invalid Reported Taskgroup
64	TLX00840	USER_FIELD_1	Validate that the USER_FIELD_1 reported exists on the TL_USER_FIELD_1 table.	TLX00840	Invalid User Field 1
65	TLX00850	USER_FIELD_2	Validate that the USER_FIELD_2 reported exists on the TL_USER_FIELD_2 table.	TLX00850	Invalid User Field 2
66	TLX00860	USER_FIELD_3	Validate that the USER_FIELD_3 reported exists on the TL_USER_FIELD_3 table.	TLX00860	Invalid User Field 3

<b>Nbr</b>	<b>Validation Definition ID</b>	<b>Validation Definition</b>	<b>Validation Comments</b>	<b>Exception Definition ID</b>	<b>Exception Descr.</b>
67	TLX00870	USER_FIELD_4	Validate that the USER_FIELD_4 reported exists on the TL_USER_FIELD_4 table.	TLX00870	Invalid User Field 4
68	TLX00880	USER_FIELD_5	Validate that the USER_FIELD_5 reported exists on the TL_USER_FIELD_5 table.	TLX00880	Invalid User Field 5
69	TLX01540	More than 24 hours reported	More than 24 hours cannot be reported for an Hours type TRC.	TLX01540	More than 24 hours reported
70	TLX01550	QTY is not zero	Validate that TL_QUANTITY is zero when an Amount type TRC is reported and the COMP_RATECD reported is of 'Flat Amount' type.	TLX01550	QTY must be zero
71	TLX01560	QTY cannot be zero	Validate that TL_QUANTITY is not zero when an Hours/Unit type TRC is reported.	TLX01560	QTY cannot be zero
72	TLX01570	QTY cannot be zero	Validate that TL_QUANTITY is not zero when an Amount type TRC is reported and no COMPRATE_CD is reported.	TLX01570	QTY cannot be zero
73	TLX01580	QTY cannot be zero	Validate that TL_QUANTITY is not zero when an Amount type TRC is reported and COMPRATE_CD reported is not of 'Flat Amount' type.	TLX01580	QTY cannot be zero



<b>Nbr</b>	<b>Validation Definition ID</b>	<b>Validation Definition</b>	<b>Validation Comments</b>	<b>Exception Definition ID</b>	<b>Exception Descr.</b>
74	TLX01590	Cannot report Override rate	Validate that OVERRIDE_RATE is not reported along with an Amount type TRC.	TLX01590	Cannot report Override Rate
75	TLX01600	Invalid Time Reporter	The reported time is earlier than the Time and Labor enrollment date.	TLX01600	Invalid Time Reporter
76	TLX01630	Comp Rate Code Validation	The Comp Rate Code reported has a rate type equal to points and is not valid.	TLX01630	Invalid Comp Rate Code
77	TLX01640	Reported Rules only TRC	The reported TRC is not valid for time entry. The TRC used is valid for Rules generated time only.	TLX01640	Invalid TRC
78	TLX01650	TRC not valid for Punch Time	The TRC reported is not a hours type TRC. Only a hours type TRC can be used to report punch time.	TLX01650	TRC not valid for Punch Time
79	TLX01660	TRC Associated with comp/leave	The TRC reported is associated with compensation / leave indicator and is invalid to use for reporting punch time.	TLX01660	TRC associated with comp/leave
80	TLX01670	HR BU not mapped to a GL BU	The reported HR Business unit is not mapped to a GL Business Unit.	TLX01670	HR BU not mapped to GL BU
91	TLX01690	Reported Absence TRC	Warns the user that absence event information can only be reported in Absence module.	TLX01690	The reported TRC is not valid for time entry. The TRC used is valid for Absence generated time only.

<i>Nbr</i>	<i>Validation Definition ID</i>	<i>Validation Definition</i>	<i>Validation Comments</i>	<i>Exception Definition ID</i>	<i>Exception Descr.</i>
82	TLX01700	Full Absence & Reported Time	When Full day absence exists and there is a reported time.	TLX01700	Time is reported for Full day Absence.?
83	TLX01710	Partial Absence & Punch Time	Triggers only if punch time of SCH source exists for the days of partial absence and the Workgroup is configured to Create Partial Work Hours. This is to warn the user that regeneration of reported time did not adjust the punch scheduled time.	TLX01710	Partial absence reported and also Reported Partial Punch Time.
84	TLX01770	Reported time in prior period	Validate if time reporter has reported time in prior period	TLX01770	Reported time in prior period
85	TLX01780	Reported time in future period	Validate if time reporter has reported time in future period	TLX01780	Reported time in future period
86	TLX01790	Reported time in prior year	Validate if time reporter has reported time in prior year.	TLX01790	Reported time in prior year

## Timesheets and Online Validations

Online validations occur when you report time using Timesheets, either Elapsed or Punch, and click the **Save for Later** button or the **Submit** button. Validation occurs as of the **Begin Date** of the time period that is being viewed (day, week, or time period). These validations depend on the settings in the Validations Options group box on the Time and Labor Installation page.

See [Time and Labor Installation Page](#).

This section discusses these validations on the Weekly Elapsed Timesheet:

- Comp rate code validations.

- TRC minimum quantity and maximum quantity validations.
- Comp time validations.
- Leave time validation.
- Additional edits.

## Comp Rate Code Validations

The validations for comp rate codes are:

- If no TRC is reported with a comp rate code, an error message is issued.
- If the comp rate code type is *Hourly* or *Flat Amount*, no override rate is allowed.
- The reported comp rate code type must be *Hourly*, *Flat Amount + Hourly*, *Flat Amount*, or *Percent*; otherwise, the comp rate code is not allowed.
- If the TRC type is *Hourly* and NA Earnings Payment type is *Both Hours and Amounts OK*, the comp rate code cannot be reported.
- If the TRC type is *Hourly* and the NA Earnings Payment type is *Either Hours or Amount OK*, the reported comp rate code type must be *Hourly*, *Hourly + Flat Amount*, or *Percent*; otherwise, the comp rate code cannot be reported.
- If the TRC type is *Amount* and comp rate code type is *Flat Amount*, then the TL quantity must be zero.
- If the TRC type is *Amount*, the NA Earnings Payment type is *Flat Amount* and the comp rate code type is not *Flat Amount*, the comp rate code is not allowed.
- If the TRC type is *Amount*, the NA Earnings Payment type is *Both Hours and Amounts OK* and the comp rate code type is *Flat Amount*, the TL quantity reported must be zero.
- If the TRC type is *Amount*, the NA Earnings Payment type is *Both Hours and Amounts OK*, and the comp rate code type is not *Flat Amount*, an error message is generated to indicate that the comp rate code type is not *Flat Amount*.
- If the TRC type is *Amount*, the NA Earnings Payment type is *Either Hours or Amounts OK*, and the comp rate code type is *Flat Amount*, the TL quantity reported must be zero.
- If TRC type is *Amount*, the NA Earnings Payment type is *Either Hours or Amounts OK*, and comp rate code type is not *Flat Amount*, an error message is generated to indicate that the comp rate code type is not *Flat Amount*.
- If the TRC type is *Unit* and NA Earnings Payment type is *Both Hours and Amounts OK*, an error message is generated to indicate that the comp rate code cannot be reported
- If the TRC type is *Unit*, the NA Earnings Payment type is *Either Hours or Amounts OK*, and the comp rate code type is *Flat Amount*, then the TL quantity must be zero.
- If the TRC type is *Unit* and the NA Earnings Payment type is *Hours*, then the comp rate code type must be *Hourly*, *Flat Amount + Hourly* or *Percent*; otherwise, an error message is generated.

- If the TRC type is *Unit* and the NA Earnings Payment type is *Units*, the comp rate code is not allowed.

See [Defining and Mapping Time Reporting Codes \(TRCs\)](#).

## TRC Minimum Quantity and Maximum Quantity Validations

If the quantity reported is not between the minimum and maximum defined on the Time Reporting Codes - Definition page, an error message is generated.

## Comp Time Validations

The validations for comp time are:

- If online validation for comp time is selected on the TL Installation page and a comp time TRC is reported, the system validates that the employee participates in a comp time plan; if not, an error message is generated.
- If the comp time earned is greater than the comp time taken and the comp balance exceeds the maximum defined, an error message is generated to indicate that the time reporter has exceeded the *Max Positive Allowed* valued defined for the comp plan.
- If the amount of comp time taken is more than the amount of comp time earned, and it exceeds the negative balance allowed for the given comp plan, an error message is generated to indicate that the time reporter can't take more than the maximum negative hours allowed.
- If comp time taken is more than the comp time earned, and the comp time plan does not allow a negative balance, an error message is generated to indicate that the time reporter can't have negative hours with this comp plan.

## Leave Time Validations

The validations for leave time are:

- If the TRC is not correctly mapped to a NA Earnings leave code, a warning message is issued that leave validation cannot occur.
- If the employee is not participating in a leave plan and reports a leave TRC, an error message is generated to indicate that the employee is not participating in a leave plan
- If an employee is not participating in a leave plan of the type to which the TRC is mapped, an error message is generated to indicate that the employee is not participating in a leave plan of leave plan type "x."
- If the user reports more leave than the leave plan allows for a negative balance, a warning message is generated that indicates the number of hours reported which exceed the negative balance.

## Additional Edits

Additional validation edits are:

- If setup changes exist for the employee during the displayed week, the days that are impacted by the effective dated change are disabled.
- The days in time reporting grid are disabled when prior period access is not allowed or is limited

- Any days that are populated by absence entries from Global Payroll and Absence Management are disabled.

## Weekly Punch Time Reporting Validations

These types of punch time reporting validations are discussed in this section:

- Prior period access.
- Mid-period data changes
- Minimal data requirements.

### Prior Period Access

The prior period access validations are:

- If prior period access is not allowed, generate this error message: New punch entries with a date value of "x" or before are not allowed.
- If punch entry is made prior to the current week, generate this error message: New punch entries with a date value before "x" are not allowed for this session.
- If punch entry is made after the current week, generate this error message: New punch entries with a date value after "x" are not allowed for this session.

### Mid-Period Data Changes

If effective dated changes exist on the Maintain Time Reporter Data page that fall within the current week, generate this error message: New punch entries with a date value on or after "x" are not allowed for this session.

### Minimal Data Requirements

Validate that punch time is entered; if not, generate an error message indicating that time is required.

Validate that punch date is entered; if not, generate an error message indicating that date is required.

## Time and Task Reporting Template Validations

These validations apply to both elapsed and punch reported time:

- If the time reporter is a task template reporter, and if any task elements that are defined as required are missing, the reported elements are validated and an error message is displayed. Task elements include *Company, Business Unit HR, Location, Department, Job Code, Position Number, Product, Customer, Task, Account Code, PC Business Unit, Business Unit PF, Project ID, Activity, Resource Type, Resource Category, Resource Subcategory*, and *User Field 1* through *User Field 5*.
- If time reporting elements that are defined as required are missing, the reported elements are validated and an error message is displayed. Time reporting elements include *Time Reporting Code, TRC*

*Type, Unit of Measure, Currency Code, Time Collection Device ID, Country, State, Locality, Billable Indicator, Badge ID, Comp Rate Code, Override Rate, Override Reason, Rule Element 1 through Rule Element 5.*

# TCD Interface

---

## Understanding the TCD Interface

This section discusses the interface process between Time and Labor and third-party data collection systems. The term *TCD* refers to the badge-based terminal that can range from a very simple TCD to a very sophisticated data collection system.

The TCD Interface uses the PeopleSoft Integration Broker to send and receive data from the TCD system. Data in Time and Labor and the TCD system are synchronized by either a full data replication or an incremental approach (changes only).

The TCD Vendor Interface process is part of the Time Reporting feature of Time and Labor. The TCD Vendor Interface process:

1. Identifies a generic set of input data to be sent to the various TCD systems. Each TCD vendor determines which data elements are needed based on the customer's business requirements and the capabilities of the devices it markets and supports.
2. Identifies a generic set of output data to be produced by the various TCD systems. The TCD vendor populates all required fields and optional fields when applicable.
3. Provides TCD vendors with the following detailed information to implement the interface process:
  - Instructions to implement the PeopleSoft Integration Broker service operation.
  - Information to interpret the input data elements and data structures and their relationships.
  - Instructions to populate the output data structures.

The frequency for passing data between the TCD system and Time and Labor is determined by your business requirements. PeopleSoft and your TCD vendor collectively determine the frequency of communications on an implementation to implementation basis.

---

**Note:** To research the technical details of any integration point (EIP) used by PeopleSoft applications, refer to the Interactive Services Repository in the Implementation Guide section of My Oracle Support.

---

## Input Data Sent to TCD Systems

Time and Labor interfaces with many data collection systems. Input data to be sent to the TCD system varies by vendor. To accommodate as many vendors as possible, PeopleSoft allows you to define a generic set of input data to pass to your TCD. The TCD vendor uses only the data it must send to TCDs to meet the customer's time reporting needs.

Time and Labor uses the definitions of TCD type to control the data going to your TCD. It does not send data that your TCD cannot process. This reduces the traffic on the network and the amount of data the TCD has to ignore.

## Time Reporter

The Time Reporter data structure contains general information about the time reporter and foreign keys to related data on other data structures that follow.

#	Data Element	Type	Length	Source	Notes
1	Empl ID	Char	11	TL_EMPL_DATA	Identifier.
2	Empl RCD#	Num	3	TL_EMPL_DATA	Identifier used in PS applications to accommodate multiple concurrent jobs (positions).
3	Badge ID	Char	20	BADGE_TABLE	Identifier.
4	Time Reporting Status	Char	1	TL_EMPL_DATA	Active or Inactive.
5	Last Name	Char	30	PERSONAL_DATA	Last name.
6	First Name	Char	30	PERSONAL_DATA	First name.
7	Hire Date	Date	10	EMPLOYMENT	Needed for calculating anniversary date.
8	Service Date	Date	10	EMPLOYMENT	Needed for determining seniority.
9	Birth Date	Date	10	PERSONAL_DATA	Needed for displaying a 'Happy Birthday' message.



<b>#</b>	<b>Data Element</b>	<b>Type</b>	<b>Length</b>	<b>Source</b>	<b>Notes</b>
10	Restriction Profile ID	Char	10	TL_TCDGRP_TBL or TL_EMPL_DATA	Identifies the employee's restriction profile. Blank means there are no restrictions for the time reporter.
11	Task Template ID	Char	10	TL_TASKGRP_TBL	Identifies the employee's task template ID.
12	Task Profile ID	Char	10	TL_EMPL_DATA	Identifies the employee's task profile.

With a few exceptions, Time and Labor obtains this information from the Employee Profile process and direct selects from tables. The Restriction Profile ID is from the TCD Group unless there is an override Restriction Profile on the Time and Labor Employee Data (TL\_EMPL\_DATA) record. The TASK\_PRFL\_TMPLT\_ID is from the Taskgroup Table based on the employee's assigned Taskgroup in TL\_EMPL\_DATA.

Time and Labor sends both Badge ID and Empl ID/Empl Rcd#. The TCD can use either in collecting data.

This record is sent as a full table and as incremental changes are made in PeopleSoft. For example, for setup of the TCD, a TCD would receive all the reporters for that TCD. If a reporter was just activated in Time and Labor Employee Data, an incremental message is sent to all TCD's in the reporters TCD group.

The Task Template ID specified on this message is in the TCD Task Template message only if the template is valid for the TCDs to which this reporter can report time.

## Schedule

The Schedule data structure contains time reporters' daily schedules.

Time reporters' daily schedules are provided to your TCD. The TCD uses this to determine when the time reporter is scheduled to punch in/out for work, meals, and breaks. Based on user-defined criteria (in restriction profiles), the TCD issues warning/error messages or prevents the user from using it.

The TCD definition defines whether this type of TCD can accept schedules. Time and Labor does not send schedules or restriction profiles if the TCD cannot accommodate them.

<b>#</b>	<b>Data Element</b>	<b>Type</b>	<b>Length</b>	<b>Source</b>	<b>Notes</b>
1	Badge ID	Char	20	TL_SCHEDULE	Identifier.

#	Data Element	Type	Length	Source	Notes
2	Emplid	Char	11	TL_EMPL_DATA	Identifier.
3	Empl Rcd#	Num	3	TL_EMPL_DATA	Identifier.
4	Punch Date Time	DateTime	See Interface Specifications	TL_SCHEDULE	Identifier.
5	Sequence Number	Num	3	TL_SCHEDULE	Identifier – needed when schedule spans multiple days.
6	Punch Type	Char	1	TL_SCHEDULE	(1 = In, 2 = Out, 3 = Meal, 4 = Break, 5 = Transfer).

**Note:** This data structure contains multiple instances of schedules per day. If the vendor requires that there is only one schedule record per day, the vendor must reformat the input data before sending to TCDs.

## Restriction Profile

The Restriction Profile data structure contains customer defined restriction information. The vendor determines which restriction profiles to send to which TCDs based on the assignments of time reporters to restriction profile on the Time Reporter data structure. The vendor should be able to send all restriction profiles received from Time and Labor to all TCDs.

The TCD requires restriction profiles to determine when to allow or disallow punches to occur.

The TCD definition defines whether this type of TCD can accept schedules. Time and Labor does not send schedules or restriction profiles if the TCD cannot process them.

#	Data Element	Type	Length	Source	Notes
1	Restriction Profile ID	Char	10	TL_RESTRCTN_TBL	Identifier.
2	Early In Restriction Ind	Char	1	TL_RESTRCTN_TBL	Y/N.
3	Early In Margin	Num	4	TL_RESTRCTN_TBL	Minutes.

<b>#</b>	<b>Data Element</b>	<b>Type</b>	<b>Length</b>	<b>Source</b>	<b>Notes</b>
4	Late In Restriction Ind	Char	1	TL_RESTRICTN_ TBL	Y/N.
5	Late In Margin	Num	4	TL_RESTRICTN_ TBL	Minutes.
6	Early Out Restriction Ind	Char	1	TL_RESTRICTN_ TBL	Y/N.
7	Early Out Margin	Num	4	TL_RESTRICTN_ TBL	Minutes.
8	Late Out Restriction Ind	Char	1	TL_RESTRICTN_ TBL	Y/N.
9	Late Out Margin	Num	4	TL_RESTRICTN_ TBL	Minutes.
10	Early Meal Restriction Ind	Char	1	TL_RESTRICTN_ TBL	Y/N.
11	Early Meal Margin	Num	4	TL_RESTRICTN_ TBL	Minutes.
12	Late Meal Restriction Ind	Char	1	TL_RESTRICTN_ TBL	Y/N.
13	Late Meal Margin	Num	4	TL_RESTRICTN_ TBL	Minutes.
14	Early Break Restriction Ind	Char	1	TL_RESTRICTN_ TBL	Y/N.
15	Early Break Margin	Num	4	TL_RESTRICTN_ TBL	Minutes.
16	Late Break Restriction Ind	Char	1	TL_RESTRICTN_ TBL	Y/N.

#	Data Element	Type	Length	Source	Notes
17	Late Break Margin	Num	4	TL_RESTRCTN_ TBL	Minutes.

## Total Hours

The Total Hours data structure contains hours already worked for the week. Total Hours includes any overtime hours earned to date for the period. PeopleSoft provides the total hours by TRC for the current period for the time reporter up to the current date.

The TCD vendor uses this information to send to TCDs to be displayed when inquired by time reporters and supervisors. The TCD definition defines whether this type of TCD can accept hours.

#	Data Element	Type	Length	Source	Notes
1	Badge ID	Char	20	BADGE_TABLE	Identifier.
2	Empl ID	Char	11	TL_EMPL_DATA	Identifier.
3	Empl RCD#	Num	3	TL_EMPL_DATA	Identifier.
4	Time Reporting Code	Char	5	TL_PAYABLE_ TIME	Identifier.
5	Total Payable Hours	Num	12.6	TL_PAYABLE_ TIME	Number.

**Note:** Total Hours information comes from the Payable Time Table. To determine total payable hours, Time Administration (Apply Rules) must be executed before such data can be published.

## Time Reporting Code

This data structure contains a list of Time Reporting Codes (TRCs) that are allowable at your TCD (such as sick, vacation, holiday, meal allowance, and so on). This is for elapsed time reporting only.

#	Data Element	Type	Length	Source	Notes
1	TCD ID	Char	10	TL_TCD_TBL	Identifies which clock gets this information.

#	Data Element	Type	Length	Source	Notes
2	Time Reporting Code	Char	5	TL_TRC_TBL	Identifier.
3	Description	Char	30	TL_TRC_TBL	Description.
4	TRC Type	Char	1	TL_TRC_TBL	Amount, Hours, or Units
5	Unit of Measure	Char	3	TL_TRC_TBL	Unit of Measure for TRC Type Units

- The interface process only extracts TRCs with the Send To TCD field = *Y*. The default for this field is *N*. Ensure that you set this field to *Y* when the TRC is to be sent to the TCD. This indicator has been added to the TL\_TRC\_TBL to avoid sending extraneous TRCs to TCDs.
- The TCD system may need to convert character codes to numeric codes before using them.
- The data in this table is derived from the TRC Program attached to the TCD.

## TCD Supervisor

This data structure contains a list of supervisors who are authorized to perform supervisor functions at various TCDs. Each TCD Group can be associated to one or more TCD supervisors. A TCD supervisor may be associated with many TCD Groups.

The TCD Interface process assigns supervisors to TCDs. The vendor does not need to derive this relationship.

#	Data Element	Type	Length	Source	Notes
1	TCD ID	Char	10	TL_TCDGPTCD_TBL	Identifies which clock gets this information.
2	Supervisor ID	Char	11	TL_TCD_SUPERV	Identifier.
3	Badge ID	Char	20	BADGE_TABLE	Identifier.
4	Supervisor PIN #	Num	20	TL_TCD_SUPERV	PIN for supervisor.

## TCD Task Profile

This data structure contains a list of Task Profiles associated with each TCD. Task Profiles contain task and cost allocation data used in the Labor Distribution process in Time and Labor. The system requires Task Profiles for positive task profile reporting. Positive task profile reporting in Time and Labor means the time reporter must indicate the type of task being performed. For example, Time reporter 111111 is assigned to TCD AAAAA. The valid Task Profiles for TCD AAAAA include Packaging, Shipping, Receiving, and Cleaning. Time reporter 11111 selects one of the Task Profiles by pressing a function key at the TCD to indicate the task being performed.

Unlike positive task profile reporting, default task profile reporting refers to time reporters who routinely perform the same tasks and their cost allocation information remains unchanged. A time reporter swipes the badge when starting and stopping work. The TCD system does not need any task information from Time and Labor for these time reporters. Cost allocation data defined on the default Task Profile in Time and Labor is used to allocate costs accordingly.

#	Data Element	Type	Length	Source	Notes
1	TCD ID	Char	10	TL_TCD_TASKGRP	Identifier.
2	Task Profile ID	Char	10	TL_TASKGRP_TBL	Identifier.
3	Task Profile Description	Char	30	TL_TSKPRF_TBL	Identifier.

The TCD Task Profile table is derived from the following Time and Labor tables:

- TCD Taskgroup – contains a list of Taskgroups associated with each TCD.
- Taskgroup Profile – contains a list of task profiles associated with each Taskgroup.
- Task Profile – contains task profile definitions. Time and Labor selects only records with SEND\_TO\_TCD = Y.

## TCD Task Template

This data structure contains a list of Task Templates associated with each TCD. Task Templates are required for positive task element reporting. Positive task element reporting requires the time reporter to enter a value for each task element on the Task Template. For example, Time reporter 111111 is assigned to TCD AAAAA. The valid Task Templates for TCD AAAAA include Packaging, Shipping, Receiving, and Cleaning. The Packaging task template includes the following task elements: Customer and Account Code. Time reporter 11111 selects one of the Task Templates by pressing a function key at the TCD to indicate the task being performed. Additionally, the time reporter is required to enter the value for Customer and Account Code when prompted.

This data structure also contains a list of Rule Elements associated with each TCD. Rule Elements are needed in cases where the type of work or the job the time reporter performs influences their pay. Rule Element reporting requires the time reporter to enter a value for each Rule Element. As far as the TCD is concerned, Rule Elements are just another form of Task Elements.

This type of reporting is more complex and requires a few tables to be sent to the TCD system. If data validation is required, PeopleSoft provides all the valid values for certain task elements.

The following tables are sent to the TCDs for positive task element reporting:

#	Data Element	Type	Length	Source	Notes
1	TCD ID	Char	10	TL_TCD_ TASKGRP_TBL	Identifier.
2	Task Template ID	Char	10	TL_TASKGRP_ TBL	Identifier.
3	Task Template Description	Char	30	TL_TSKPRF_ TMPLT	Identifier.

The TCD Task Template table is derived from the following Time and Labor tables:

- TCD Taskgroup– contains a list of Taskgroups associated with each TCD.
- Taskgroup – contains a task template ID associated with each Taskgroup.
- Task Template – contains header information for task templates.

If template reporting is used, but the TCD vendor/customer does not present a list of templates to select from, a default template is sent for each time reporter in the Time Reporter message. This default enables automatic prompt for task elements based on the time reporter at the TCD.

### Task Template Detail

#	Data Element	Type	Length	Source	Notes
1	Task Template ID	Char	10	TL_TSKPRF_ TMPLT	Identifier.
2	Task Element Code	Char	3	TL_TSKPRF_ TMPLT	Identifier.
3	Task Element Description	Char	30	TL_TASKELE_ TBL	Description.
4	Required	Char	1	TL_TSKPRF_ TMPLT	Is this element required or optional.

The Task Template Detail Table contains all the valid Task Element Codes associated with each Task Template. It is derived from the following Time and Labor tables:

- Task Template Element – contains task element codes associated with a Task Template.
- Task Element – contains task element codes and associated field names.
- PSDBFIELD (PeopleTools table) – contains field names and associated descriptions.

If the time reporter has to report Rule Elements, Time and Labor adds the Rule Element list to the end of each template. The Rule Element codes are RE1, RE2, RE3, RE4, and RE5. The Time and Labor system does not allow Task Element Codes with these values. The Required field is always *Y*.

### Task Element Code Value

#	Data Element	Type	Length	Source	Notes
1	Task Element Code	Char	3	TL_TASK_ELE_TBL	Identifier.
2	Task Element Value	Char	25	A Prompt Table	Description.
3	Task Element Value Source	Char	2	(TL/PC)	Because PROJECT values and ACTIVITY values can come from two different places, the Source field will be filled in only for those Task Element Codes.

The Task Element Code Value Table contains all the valid values associated with each Task Element Code. It is derived from the following Time and Labor tables:

- Task Template Element – contains task element codes associated with a Task Template.
- Task Element – contains task element codes and associated field names.
- PSRECFIELD (PeopleTools table) – contains record names, field names, prompt table names and other edit information. Time and Labor uses rows where the record name is TL\_TSK\_ELMT\_WRK (the name of the task derived work record)

This table also contains all the valid values associated with each Rule Element Code.

This table can be quite large. Ensure that the TCD system can process such a large volume of data.

### Reporting Element Tables

Sometimes the Time Reporter has to supply information on the location tax purposes. The time reporter or the supervisor may also have to enter override rate information. The following tables contain values for this information.



## Country Table

This table is used for positive reporting of a country other than the reporter's default.

#	<i>Data Element</i>	<i>Type</i>	<i>Length</i>	<i>Source</i>	<i>Notes</i>
1	Country Code	Char	3	COUNTRY_TBL	Identifier.
2	Descr	Char	30	COUNTRY_TBL	Description.

## State Table

This table is used for positive reporting of a state other than the reporter's default.

#	<i>Data Element</i>	<i>Type</i>	<i>Length</i>	<i>Source</i>	<i>Notes</i>
1	State Code	Char	6	STATE_NAMES_TBL	Identifier.
2	Descr	Char	30	STATE_NAMES_TBL	Description.

## Locality Table

This table is used for positive reporting of a locality other than the reporter's default.

#	<i>Data Element</i>	<i>Type</i>	<i>Length</i>	<i>Source</i>	<i>Notes</i>
1	Locality ID	Char	10	LOCAL_TAX_TBL	Identifier.
2	Descr	Char	30	LOCAL_TAX_TBL	Description.

## Rate Code Table

This table is used for positive reporting of a comp rate code in conjunction with a Time Reporting Code to specify a different compensation rate. This is used for elapsed time reporting only. Either this or the override rate is entered to adjust a reporter's compensation.

<b>#</b>	<b>Data Element</b>	<b>Type</b>	<b>Length</b>	<b>Source</b>	<b>Notes</b>
1	Rate Code	Char	6	COMP_RT_REG_VW	Identifier.
2	Descr	Char	30	COMP_RT_REG_VW	Description.

### Currency Code Table

This table is used for positive reporting of a conjunction with a Time Reporting Code, Rate Code, or Override Rate to specify a currency different from the default. This is used for elapsed time reporting only.

<b>#</b>	<b>Data Element</b>	<b>Type</b>	<b>Length</b>	<b>Source</b>	<b>Notes</b>
1	Currency Code	Char	3	CURRENCY_CD_TBL	Identifier.
2	Descr	Char	30	CURRENCY_CD_TBL	Description.

### Override Reason Code Table

This table is used in conjunction with a supervisor overriding a punch. This is used for punch time reporting only.

<b>#</b>	<b>Data Element</b>	<b>Type</b>	<b>Length</b>	<b>Source</b>	<b>Notes</b>
1	Override Reason Code	Char	5	TL_OVRD_RSN_TBL	Identifier.
2	Descr	Char	30	TL_OVRD_RSN_TBL	Description.

---

## Output Data Produced by TCD Systems

The TCD system produces the following output data to be passed to Time and Labor:

<b>#</b>	<b>Table</b>	<b>Notes</b>
1.	Punched Time Interface	Contains punched time transactions.
2.	Punched Task Interface	Contains punched task transactions related to punched time transactions (child of Punched Time).
3.	Elapsed Time Interface	Contains elapsed time transactions (such as Sick, Vacation, Holiday, and so on).
4.	Elapsed Task Interface	Contains elapsed task transactions related to elapsed time transactions (child of Elapsed Time).

Time and Labor receives this data through PeopleSoft Integration Broker.

The first step is to validate the information sent by the TCD. This includes standard format edits. This data may also come into Time and Labor through a flat file.

The next step is to translate Badge IDs to EmplIDs and create Reported Time entries.

The last step is to initiate the Validation process, which takes the data to the next step.

Because a time reporter can report time at more than one TCD, Time and Labor must be able to accept data for a time reporter from multiple sources at the same time.

## Punched Time Interface

The Punched Time data structure contains punched time transactions. The majority of time transactions are written to this data structure.

<b>#</b>	<b>Data Element</b>	<b>Type</b>	<b>Length</b>	<b>Required</b>	<b>Notes</b>
1	Badge ID	Char	20	N	The TCD must send either Badge ID or Empl ID/ Empl Rcd#.
2	Empl ID	Char	11	N	The TCD must send either Badge ID or Empl ID/ Empl Rcd#.
3	Empl RCD#	Num	3	N	The TCD must send either Badge ID or Empl ID/ Empl Rcd#.

<b>#</b>	<b>Data Element</b>	<b>Type</b>	<b>Length</b>	<b>Required</b>	<b>Notes</b>
4	Punch Date Time	DateTime	See Interface Specifications in Using Time Collection Devices	N	Identifier. This field is required if the Add/Delete indicator is <i>A</i> .
5	Delete Date	Date	10	N	Indicates the Date for an Add/Delete indication of <i>D</i> . This field is required if the Add/Delete indicator is <i>D</i> .
6	Punch Type	Char	1	N	1 = In, 2 = Out, 3 = Meal, 4 = Break, 5 = Transfer. This field is required if the Add/Delete indicator is <i>A</i> .
7	TCD ID	Char	10	Y	Indicates which TCD time transaction came from.
8	Time Zone	Char	9	N	EST, PST, MST, and so on
9	Supervisor ID	Char	20	N	Can be blank – Supervisor ID who did the override.
10	User ID	Char	8	N	Can be blank – User ID who did the override.
11	Override Reason Code	Char	5	N	Can be blank – Reason code for the override.
12	Add/Delete Indicator	Char	1	N	Can be blank – A = Add, D = Delete

#	Data Element	Type	Length	Required	Notes
13	Action Date/Time	DateTime	See Interface Specifications in Using Time Collection Devices	N	Can be blank – Date and Time when override occurred.
14	Task Profile ID	Char	10	N	Can be blank – override or positively reported.
15	Task Template ID	Char	10	N	Can be blank – Task Template used when positively reported.
16	Country	Char	3	N	Override Country
17	State	Char	6	N	Override State
18	Locality	Char	10	N	Override Locality
19	Comments	Char	254	N	

The TCD system can send either Badge IDs or Empl ID/Empl Rcd#. Time and Labor translates Badge IDs to EmplIDs.

**Note:** If the correct **Empl Rcd #** is not set up for a clock badge type on the Badge page in Workforce Administration for an employee, the Time and Labor TCD Integration assigns all time to Empl Rcd = 0 when it processes messages converting Badge to Emplid/Empl Rcd.

See “Badge Page” (PeopleSoft Human Resources Administer Workforce).

Time and Labor obtains the time zone from the TCD definition if the time zone does not come in on this record.

Time and Labor compares the Task Template ID on the Punched Time record to the Task Template ID on the Time Reporter's Taskgroup. If the Task Template IDs do not match, then Time and Labor assumes Taskgroup borrowing has occurred and finds a Taskgroup that contains the Task Template ID.

Time and Labor compares the Task Profile ID on the Punched Time record to the Task Profile IDs attached to the Time Reporter's Taskgroup. If the Task Profile IDs do not match, then the system assumes Taskgroup borrowing has occurred and finds a Taskgroup that contains the Task Profile ID.

Time and Labor creates an Audit record if the Supervisor ID on the record is not blank. The audit record will have a generic "Override at TCD" reason.

For Country, State and Locality, Time and Labor uses the values on the interface if present. If not present, the system checks the TCD definition to see if these values are specified at the TCD. If they are, Time and Labor uses the TCD definition values. In either case, the system compares these values to the Time Reporter's values in HR. Time and Labor uses these values as overrides on Reported Time if there is a difference.

In general, PeopleSoft recommends that the deletion and replacement of punches be done online in Time and Labor. However, the Add/Delete Indicator in the Punch Interface provides delete/replace functionality on the day level for an employee. Individual punches cannot be deleted through the interface, and a replacement is a delete of a day and then an add of what the day should be. For this to occur, the TCD must maintain an image of that day, so corrected punches could be sent with the whole day. When a delete is processed in the PeopleSoft system, punch date times are evaluated in the time zone in which they were reported. Here is an example of deleting a punch.

Employee 1 has the following punches on 1/1/99, and these punches have already been sent to Time and Labor:

<b>EMPLID</b>	<b>PUNCH_DATETIME</b>	<b>PUNCH_TYPE</b>	<b>Add/Delete Indicator</b>
1	1/1/99 8AM	IN	A
1	1/1/99 12PM	MEAL	A
1	1/1/99 1PM	IN	A
1	1/1/99 5PM	OUT	A

Someone at the TCD decides that the 12PM *MEAL* punch and 1PM *IN* punch need to be deleted because the employee didn't take lunch.

These are the rows Time and Labor should receive in the interface (the time on a deleted row is irrelevant):

<b>EMPLID</b>	<b>PUNCH_DATETIME</b>	<b>DELETE_DATE</b>	<b>PUNCH_TYPE</b>	<b>Add/Delete Indicator</b>
1		1/1/99		D
1	1/1/99 8AM		IN	A
1	1/1/99 5PM		OUT	A

Here is an example of replacing a punch.

Employee 2 has the following punches on 1/1/99, and these punches have already been sent to Time and Labor:

<b>EMPLID</b>	<b>PUNCH_DATETIME</b>	<b>PUNCH_TYPE</b>	<b>Add/Delete Indicator</b>
2	1/1/99 8 AM	IN	A
2	1/1/99 12 PM	MEAL	A
2	1/1/99 1 PM	IN	A
2	1/1/99 5 PM	OUT	A

Someone at the TCD decides that the 1PM *IN* punch should be a 2PM *IN* punch because Employee 2 really took a two hour lunch.

These are the new rows Time and Labor should receive in the interface:

<b>EMPLID</b>	<b>PUNCH_DATETIME</b>	<b>DELETE_DATE</b>	<b>PUNCH_TYPE</b>	<b>Add/Delete Indicator</b>
2		1/1/99		D
2	1/1/99 8AM		IN	A
2	1/1/99 12PM		MEAL	A
2	1/1/99 2PM		IN	A
2	1/1/99 5PM		OUT	A

## Punched Task Interface

The Punched Task data structure contains punched task transactions related to a punched time transaction.

<b>_#</b>	<b>Data Element</b>	<b>Type</b>	<b>Length</b>	<b>Required</b>	<b>Notes</b>
1	Badge ID	Char	20	N	The TCD must send either Badge ID or Empl ID/ Empl Rcd#.

<b>_#</b>	<b>Data Element</b>	<b>Type</b>	<b>Length</b>	<b>Required</b>	<b>Notes</b>
2	Empl ID	Char	11	N	The TCD must send either Badge ID or Empl ID/Empl Rcd#.
3	Empl RCD#	Num	3	N	The TCD must send either Badge ID or Empl ID/Empl Rcd#.
4	Punch Date Time	DateTime	See interface specifications in Using Time Collection Devices	Y	Identifier.
5	Delete Date	Date	10	N	Always is Null
6	Task Element Code	Char	3	Y	Only for positive task element reporters.
7	Task Element Value	Char	25	Y	Only for positive task element reporters.

The TCD system can send either Badge IDs or Empl ID/Empl Rcd#. Time and Labor translates Badge IDs to EmplIDs.

The TCD also passes Rule Elements on this table. Rule Elements look similar to task elements. Time and Labor distinguishes them by the element code and splits out rule elements into specific fields on the reported time record.

Mapping of task element codes may need to occur if the TCD can only process numeric values.

Only punch types of *IN* and *Transfer* should produce Punched Task records.

### **Elapsed Time Interface**

The Elapsed Time data structure contains elapsed time transactions reported at the TCDs (such as tip, vacation, sick, holiday, and so on):



<b>#</b>	<b>Data Element</b>	<b>Type</b>	<b>Length</b>	<b>Required</b>	<b>Notes</b>
1	Badge ID	Char	20	N	The TCD must send either Badge ID or Empl ID/ Empl Rcd#.
2	Empl ID	Char	11	N	The TCD must send either Badge ID or Empl ID/ Empl Rcd#.
3	Empl RCD#	Num	3	N	The TCD must send either Badge ID or Empl ID/ Empl Rcd#.
4	Date Under Report	Date	10	N	Identifier (CCYY-MM-DD). This field is required if the Add/Delete indicator is <i>A</i> .
5	Sequence Number	Num	3	Y	Identifier to make each row unique.
6	Delete Date	Date	10	N	Indicates the Date for an Add/Delete indication of <i>D</i> . This field is required if the Add/Delete indicator is <i>D</i> .
7	Add/Delete Indicator	Char	1	Y	A/D, Default = A.
8	TCD ID	Char	10	Y	Indicates which TCD time transaction came from.

<b>#</b>	<b>Data Element</b>	<b>Type</b>	<b>Length</b>	<b>Required</b>	<b>Notes</b>
9	Time Reporting Code	Char	5	Y	TCD vendors may need to convert numeric code to character code.
10	Quantity	Num	12.6	Y	This field can represent hours (in hours and tenths), amount, or units.
11	Currency Code	Char	3	N	An optional currency code for when the quantity represents money.
12	Pay Rate Override	Num	12.6	N	Can be zero. If populated, it will be used to calculate time reporter's pay.
13	Rate Code Override	Char	6	N	Override Rate Code
14	Billable Indicator	Char	1	Y	Billable Indicator for use in pay calculations (Y/N) Default=N.
15	Supervisor ID	Char	20	N	Can be blank – Supervisor ID who did the override.
16	User ID	Char	8	N	Can be blank – User ID who did the override.
17	Override Reason Code	Char	5	N	Can be blank – Reason code for the override.

<b>#</b>	<b>Data Element</b>	<b>Type</b>	<b>Length</b>	<b>Required</b>	<b>Notes</b>
18	Action Date/Time	Date Time	See interface specifications in Using Time Collection Devices	N	Can be blank – Date and Time when override occurred.
19	Task Profile ID	Char	10	N	Can be blank – override or positively reported.
20	Task Template ID	Char	10	N	Can be blank – Task Template used when positively reported.
21	Country	Char	3	N	Override Country
22	State	Char	6	N	Override State
23	Locality	Char	10	N	Override Locality
24	Comments	Char	254	N	

The TCD system can send either Badge IDs or Empl ID/Empl Rcd#. Time and Labor translates Badge IDs to EmplIDs.

Time and Labor assumes the currency code attached to the Time Reporting Code definition unless a currency code comes in on this record.

Time and Labor compares the Task Template ID on the Elapsed Time record to the Task Template ID on the time reporter's Taskgroup. If the Task Template IDs do not match, then the system assumes Taskgroup borrowing has occurred and finds a Taskgroup that contains the Task Template ID.

Time and Labor compares the Task Profile ID on the Elapsed Time record to the Task Profile IDs attached to the time reporters' Taskgroup. If the Task Profile IDs do not match, then the system assumes Taskgroup borrowing has occurred and finds a Taskgroup that contains the Task Profile ID.

Time and Labor creates an Audit record if the Supervisor ID on the record is not blank. The audit record has a generic "Override at TCD" reason.

For Country, State and Locality, Time and Labor uses the values on the interface if present. If not present, the system checks the TCD definition to see if these values are specified at the TCD. If they are, the system uses the TCD definition values. In either case, Time and Labor compares these values to the time reporter's values in HR. The system uses these values as overrides on Reported Time if there is a difference.

In general, PeopleSoft recommends that the deletion and replacement of elapsed time records be done online in Time and Labor. However, the Add/Delete Indicator in the Elapsed Time Interface provides delete/replace functionality on the day level for an employee. Individual elapsed time records cannot be deleted through the interface. A replacement is a delete and then an add of what the day should be. For this to occur, the TCD must maintain an image of that day, so corrected elapsed time records could be sent with the whole day.

Here is an example of deleting an elapsed time record.

Employee 1 has reported the following time on 1/1/99, and these records have already been sent to Time and Labor:

<i><b>EMPLID</b></i>	<i><b>DUR</b></i>	<i><b>SEQNUM</b></i>	<i><b>TRC</b></i>	<i><b>TL Quantity</b></i>	<i><b>Add/Delete Indicator</b></i>
1	1/1/99	1	REG	8	A
1	1/1/99	2	OT	2	A

Someone at the TCD decides that the OT record was mistakenly reported and should be deleted.

These are the rows Time and Labor should receive in the interface:

<i><b>EMPLID</b></i>	<i><b>DUR</b></i>	<i><b>SEQNUM</b></i>	<i><b>DELETE_ DATE</b></i>	<i><b>TRC</b></i>	<i><b>TL Quantity</b></i>	<i><b>Add/ Delete Indicator</b></i>
1			1/1/99			D
1	1/1/99	1		REG	8	A

Here is an example of replacing an elapsed time record.

Employee 2 has reported the following time on 1/1/99, and these records have already been sent to Time and Labor:

<i><b>EMPLID</b></i>	<i><b>DUR</b></i>	<i><b>SEQNUM</b></i>	<i><b>TRC</b></i>	<i><b>TL Quantity</b></i>	<i><b>Add/Delete Indicator</b></i>
2	1/1/99	1	REG	8	A
2	1/1/99	2	OT	2	A

Someone at the TCD decides 3 hours of OT were worked instead of the 2 that were reported.

These are the rows Time and Labor should receive in the interface:

<i>EMPLID</i>	<i>DUR</i>	<i>SEQNUM</i>	<i>DELETE_</i> <i>DATE</i>	<i>TRC</i>	<i>TL Quantity</i>	<i>Add/Delete</i> <i>Indicator</i>
2			1/1/99			D
2	1/1/99	1		REG	8	A
2	1/1/99	2		OT	3	A

## Elapsed Task Interface

The Elapsed Task data structure contains elapsed task transactions related to each elapsed time transaction.

<i>_#</i>	<i>Data Element</i>	<i>Type</i>	<i>Length</i>	<i>Required</i>	<i>Notes</i>
1	Badge ID	Char	20	N	The TCD must send either Badge ID or Empl ID/ Empl Rcd#.
2	Empl ID	Char	11	N	The TCD must send either Badge ID or Empl ID/ Empl Rcd#.
3	Empl RCD#	Num	3	N	The TCD must send either Badge ID or Empl ID/ Empl Rcd#.
4	Date Under Report	Date	10	Y	Identifier (CCYY-MM-DD)
5	Sequence Number	Num	3	Y	Identifier to make each row unique.
6	Delete Date	Date	10	N	Always is Null
7	Task Element Code	Char	3	Y	Only for positive task element reporters.

<b>_#</b>	<b>Data Element</b>	<b>Type</b>	<b>Length</b>	<b>Required</b>	<b>Notes</b>
8	Task Element Value	Char	25	Y	Only for positive task element reporters.

The TCD system can send either Badge IDs or Empl ID/Empl Rcd#. Time and Labor translates Badge IDs to EmplIDs.

The TCD also passes Rule Elements on this table. Rule Elements look similar to task elements. Time and Labor distinguishes the difference by the element code and splits out rule elements into specific fields on the Recorded Time record.

Mapping of task element codes may need to occur if the TCD can only use numbers.

Report counts of the various objects attached to the TCD includes counts of Time Reporters, TCD Restriction Profiles, Task Profiles, Task Templates, Task Elements, Task Element Values, Time Reporting Codes, Supervisors, Rule Elements, and Rule Element values. Use this report to monitor memory usage at the TCD.

---

## Objects Received by the TCD

### *Time Reporter*

Service Operation : TIME\_DEVICE\_EMPL\_ATT\_FULLSYNC (initialization/full table)

TIME\_DEVICE\_EMPL\_ATT\_SYNC (updates/incremental)

Service Operation Queue: TIME\_COLLECTION\_DEVICE\_SETUP

Record Definition

Record Name: TL\_EMPL\_DTA\_MSG

<b>#</b>	<b>Data Element</b>	<b>Description</b>	<b>Type</b>	<b>Length</b>
1	MSGNODENAME	Message Node Name	Char	15
2	TCD_ID	TCD ID	Char	10
3	TCD_NETWORK_ID	TCD NetworkID	Char	20
4	TCD_NODE_ID	TCD Node ID	Char	20
5	EMPLID	Empl ID	Char	11

<b>#</b>	<b>Data Element</b>	<b>Description</b>	<b>Type</b>	<b>Length</b>
6	EMPL_RCD	Empl RCD#	Num	3
7	BADGE_ID	Badge ID	Char	20
8	TIME_RPTG_STATUS	Time Reporting Status	Char	1
9	LAST_NAME	Last Name	Char	30
10	FIRST_NAME	First Name	Char	30
11	HIRE_DT	Hire Date	Date	10
12	SERVICE_DT	Service Date	Date	10
13	BIRTHDATE	Birth Date	Date	10
14	RESTRICTION_PRF_ID	Restriction Profile ID	Char	10
15	TASK_PRFL_TMPLT_ID	Task Template ID	Char	10
16	TASK_PROFILE_ID	Task Profile ID	Char	10

### *Schedule*

Service Operation: TIME\_DEVICE\_SCHEDULE\_FULLSYNC

Service Operation Queue: TIME\_COLLECTION\_DEVICE\_SETUP

Record Definition

Record Name: TL\_SCHEDULE\_MSG

<b>#</b>	<b>Data Element</b>	<b>Description</b>	<b>Type</b>	<b>Length</b>
1	MSGNODENAME	Message Node Name	Char	15
2	TCD_ID	TCD ID	Char	10
3	TCD_NETWORK_ID	TCD NetworkID	Char	20
4	TCD_NODE_ID	TCD Node ID	Char	20

#	Data Element	Description	Type	Length
5	BADGE_ID	Badge ID	Char	20
6	EMPLID	Employee ID	Char	11
7	EMPL_RCD	Employee Record Num	Num	3
8	PUNCH_DTTM	Punch Date Time	DateTime	See interface specifications in Using Time Collection Devices
9	SEQNUM	Sequence Number	Num	3
10	PUNCH_TYPE	Punch Type	Char	2

### *Restriction Profile*

Service Operation: TIME\_DEVICE\_RESTRICT\_FULLSYNC

Service Operation Queue: TIME\_COLLECTION\_DEVICE\_SETUP

### Record Definition

Record Name: TL\_RESTRICT\_MSG

#	Data Element	Description	Type	Length
1	MSGNODENAME	Message Node Name	Char	15
2	TCD_ID	TCD ID	Char	10
3	TCD_NETWORK_ID	TCD NetworkID	Char	20
4	TCD_NODE_ID	TCD Node ID	Char	20
5	RESTRICTION_PRF_ID	Restriction Profile ID	Char	10
6	RES_EARLY_IN	Early In Restriction Ind	Char	1
7	EARLY_IN_PUNCH	Early In Margin	Num	4
8	RES_LATE_IN	Late In Restriction Ind	Char	1



<b>#</b>	<b>Data Element</b>	<b>Description</b>	<b>Type</b>	<b>Length</b>
9	LATE_IN_PUNCH	Late In Margin	Num	4
10	RES_EARLY_OUT	Early Out Restriction Ind	Char	1
11	EARLY_OUT_PUNCH	Early Out Margin	Num	4
12	RES_LATE_OUT	Late Out Restriction Ind	Char	1
13	LATE_OUT_PUNCH	Late Out Margin	Num	4
14	RES_EARLY_MEAL	Early Meal Restriction Ind	Char	1
15	EARLY_MEAL	Early Meal Margin	Num	4
16	RES_LATE_MEAL	Late Meal Restriction Ind	Char	1
17	LATE_MEAL	Late Meal Margin	Num	4
18	RES_EARLY_BREAK	Early Break Restriction Ind	Char	1
19	EARLY_BREAK	Early Break Margin	Num	4
20	RES_LATE_BREAK	Late Break Restriction Ind	Char	1
21	LATE_BREAK	Late Break Margin	Num	4

*Total Hours*

Service Operation: TIME\_DEVICE\_PER\_HRS\_FULLSYNC

Service Operation Queue: TIME\_COLLECTION\_DEVICE\_SETUP

Record Definition

Record Name: TL\_TOT\_HRS\_MSG

#	Data Element	Description	Type	Length
1	MSGNODENAME	Message Node Name	Char	15
2	TCD_ID	TCD ID	Char	10
3	TCD_NETWORK_ID	TCD NetworkID	Char	20
4	TCD_NODE_ID	TCD Node ID	Char	20
5	BADGE_ID	Badge ID	Char	20
6	EMPLID	Employee ID	Char	11
7	EMPL_RCD	Employee Record Num	Num	3
8	TRC	Time Reporting Code	Char	5
9	TL_QUANTITY	Total Payable Hours	Num	12.6

### *Time Reporting Code*

Service Operation: TIME\_DEVICE\_RPTG\_CODE\_FULLSYNC

Service Operation Queue: TIME\_COLLECTION\_DEVICE\_SETUP

Record Definition

Record Name: TL\_TRC\_MSG

#	Data Element	Description	Type	Length
1	MSGNODENAME	Message Node Name	Char	15
2	TCD_ID	TCD ID	Char	10
3	TCD_NETWORK_ID	TCD NetworkID	Char	20
4	TCD_NODE_ID	TCD Node ID	Char	20
5	TRC	Time Reporting Code	Char	5
6	DESCR	Description	Char	30

### *TCD Supervisor*

Service Operation: TIME\_DEVICE\_SUPERVSR\_FULLSYNC

Service Operation Queue: TIME\_COLLECTION\_DEVICE\_SETUP

Record Definition

Record Name: TL\_TCDSUPRV\_MSG

#	Data Element	Description	Type	Length
1	MSGNODENAME	Message Node Name	Char	15
2	TCD_ID	TCD ID	Char	10
3	TCD_NETWORK_ID	TCD NetworkID	Char	20
4	TCD_NODE_ID	TCD Node ID	Char	20
5	TCD_SUPERVISR_ID	Supervisor ID	Char	20
6	BADGE_ID	Badge ID	Char	20
7	SUPERVISR_PIN_NUM	Supervisor PIN #	Num	20

*TCD Task Profile*

Service Operation: TIME\_DEVICE\_PROFILES\_FULLSYNC

Service Operation Queue: TIME\_COLLECTION\_DEVICE\_SETUP

Record Definition

Record Name: TL\_TSK\_PROF\_MSG

#	Data Element	Description	Type	Length
1	MSGNODENAME	Message Node Name	Char	15
2	TCD_ID	TCD ID	Char	10
3	TCD_NETWORK_ID	TCD NetworkID	Char	20
4	TCD_NODE_ID	TCD Node ID	Char	20
5	TASK_PROFILE_ID	Task Profile ID	Char	10

#	Data Element	Description	Type	Length
6	DESCR	Task Profile Description	Char	30

### *TCD Task Template*

Service Operation: TIME\_DEVICE\_TEMPLATES\_FULLSYNC

Service Operation Queue: TIME\_COLLECTION\_DEVICE\_SETUP

Record Definition

Record Name: TL\_TSK\_TEMP\_MSG

#	Data Element	Description	Type	Length
1	MSGNODENAME	Message Node Name	Char	15
2	TCD_ID	TCD ID	Char	10
3	TCD_NETWORK_ID	TCD NetworkID	Char	20
4	TCD_NODE_ID	TCD Node ID	Char	20
5	TASK_PRFL_TMPLT_ID	Task Template ID	Char	10
6	DESCR	Task Template Description	Char	30

1. Task Template Detail (sent in TIME\_DEVICE\_TEMPLATES\_FULLSYNC message as a child)

Record Definition

Record Name: TL\_TEMP\_DTL\_MSG

#	Data Element	Description	Type	Length
1	MSGNODENAME	Message Node Name	Char	15
2	TCD_ID	TCD ID	Char	10
3	TCD_NETWORK_ID	TCD NetworkID	Char	20
4	TCD_NODE_ID	TCD Node ID	Char	20

#	Data Element	Description	Type	Length
5	TASK_PRFL_TMPLT_ID	Task Template ID	Char	10
6	TASK_ELEMENT_CD	Task Element Code	Char	3
7	DESCR	Task Element Description	Char	30
8	CODE_REQUIRED	Required(Y/N)	Char	1

## 2. Task Element Code Value

Service Operation: TIME\_DEVICE\_TASK\_VALS\_FULLSYNC

Service Operation Queue: TIME\_COLLECTION\_DEVICE\_SETUP

Record Definition

Record Name: TL\_CD\_VALS\_MSG

#	Data Element	Description	Type	Length
1	MSGNODENAME	Message Node Name	Char	15
2	TCD_ID	TCD ID	Char	10
3	TCD_NETWORK_ID	TCD NetworkID	Char	20
4	TCD_NODE_ID	TCD Node ID	Char	20
5	TASK_ELEMENT_CD	Task Element Code	Char	3
6	TASK_ELEMENT_VALUE	Task Element Value	Char	25
7	VALUE_SOURCE	Value Source (populated only for Codes PRJ and ACT)	Char	2

## Reporting Elements Table

Service Operation: TIME\_DEVICE\_RPT\_ELMNT\_FULLSYNC (all reporting element tables are combined into one message definition)

Service Operation Queue: TIME\_COLLECTION\_DEVICE\_SETUP

Record Definition

Record Name: TL\_RPTG\_ELE\_MSG

#	Data Element	Description	Type	Length
1	MSGNODENAME	Message Node Name	Char	15
2	TCD_ID	TCD ID	Char	10
3	TCD_NETWORK_ID	TCD NetworkID	Char	20
4	TCD_NODE_ID	TCD Node ID	Char	20
5	RPTG_ELE_IND	Reporting Element Indicator - See the following possible values	Char	2
6	RPTG_ELE_CODE	Reporting Element Codes	Char	10
7	DESCR	Description	Char	30

Mapping for RPTG\_ELE\_IND

- CO – Country
- ST – State
- LY – Locality
- SH – Shift
- RT – Rate Code
- CC – Currency Code
- OV – Override Reason Code

---

## Objects Sent from the TCD

*Punched Time Interface*

Service Operation: PUNCHED\_TIME\_ADD

Service Operation Queue: PUNCHED\_TIME

## Record Definition

Record Name: TL\_PUNCH\_INTFC

<b>#</b>	<b>Data Element</b>	<b>Description</b>	<b>Type</b>	<b>Length</b>
1	BADGE_ID	Badge ID	Char	20
2	EMPLID	Empl ID	Char	11
3	EMPL_RCD	Empl RCD#	Num	3
4	PUNCH_DTTM	Punch Date Time	DateTime	See Interface Specifications in Using Time Collection Devices
5	DELETE_DATE	Delete Date	Date	10
6	PUNCH_TYPE	Punch Type	Char	1
7	TCD_ID	TCD ID	Char	10
8	TIMEZONE	Time Zone	Char	9
9	TCD_SUPERVISR_ID	Supervisor ID	Char	11
10	OPRID	User ID	Char	8
11	OVERRIDE_RSN_CD	Override Reason Code	Char	5
12	ADD_DELETE_IND	Add/Delete Indicator	Char	1
13	ACTION_DTTM	Action Date/Time	DateTime	See Interface Specifications in Using Time Collection Devices
14	TASK_PROFILE_ID	Task Profile ID	Char	10
15	TASK_PRFL_TMPLT_ID	Task Template ID	Char	10
16	COUNTRY	Country	Char	3

#	Data Element	Description	Type	Length
17	STATE	State	Char	6
18	LOCALITY	Locality	Char	10
19	TL_COMMENTS	Comments	Char	254
20	AUDIT_ACTN	For PeopleSoft Processing only; always leave field blank	Char	1

*Punched Task Interface* (sent in PUNCHED\_TIME\_ADD message as a child record)

Record Definition

Record Name: TL\_PCHTSK\_INTFC

#	Data Element	Description	Type	Length
1	BADGE_ID	Badge ID	Char	20
2	EMPLID	Empl ID	Char	11
3	EMPL_RCD	Empl RCD#	Num	3
4	PUNCH_DTTM	Punch Date Time	DateTime	26
5	DELETE_DATE	Delete Date	Date	10
6	TASK_ELEMENT_CD	Task Element Code	Char	3
7	TASK_ELEMENT_VALUE	Task Element Value	Char	30
8	AUDIT_ACTN	For PeopleSoft Processing only; always leave field blank	Char	1

*Elapsed Time Interface*

Service Operation: ELAPSED\_TIME\_ADD

Service Operation Queue: ELAPSED\_TIME

Record Definition



Record Name: TL\_ELP\_INTFC

<b>#</b>	<b>Data Element</b>	<b>Description</b>	<b>Type</b>	<b>Length</b>
1	BADGE_ID	Badge ID	Char	20
2	EMPLID	Empl ID	Char	11
3	EMPL_RCD	Empl RCD#	Num	3
4	DUR	Date Under Report	Date	10 (CCYY-MM-DD)
5	SEQNUM	Sequence Number	Num	3
6	DELETE_DATE	Delete Date	Date	10
7	ADD_DELETE_IND	Add/Delete Indicator	Char	1
8	TCD_ID	TCD ID	Char	10
9	TRC	Time Reporting Code	Char	5
10	TL_QUANTITY	Quantity	Num	12.6
11	CURRENCY_CD	Currency Code	Char	3
12	OVERRIDE_RATE	Pay Rate Override	Num	12.6
13	COMPRATE_CD	Rate Code Override	Char	6
14	BILLABLE_IND	Billable Indicator	Char	1
15	TCD_SUPERVISR_ID	Supervisor ID	Char	20
16	OPRID	User ID	Char	8
17	OVERRIDE_RSN_CD	Override Reason Code	Char	5
18	ACTION_DTTM	Action Date/Time	Date Time	26

#	Data Element	Description	Type	Length
19	TASK_PROFILE_ID	Task Profile ID	Char	10
20	TASK_PRFL_TMPLT_ID	Task Template ID	Char	10
21	COUNTRY	Country	Char	3
22	STATE	State	Char	6
23	LOCALITY	Locality	Char	10
24	TL_COMMENTS	Comments	Char	254
25	AUDIT_ACTN	For PeopleSoft Processing only; always leave field blank	Char	1

*Elapsed Task Interface* (sent in ELAPSED\_TIME\_ADD message as a child record)

Record Definition

Record Name: TL\_ELPTSK\_INTFC

#	Data Element	Description	Type	Length
1	BADGE_ID	Badge ID	Char	20
2	EMPLID	Empl ID	Char	11
3	EMPL_RCD	Empl RCD#	Num	3
4	DUR	Date Under Report	Date	10 (CCYY-MM-DD)
5	SEQNUM	Sequence Number	Num	3
6	DELETE_DATE	Delete Date	Date	10
7	TASK_ELEMENT_CD	Task Element Code	Char	3
8	TASK_ELEMENT_VALUE	Task Element Value	Char	30

<b>#</b>	<b>Data Element</b>	<b>Description</b>	<b>Type</b>	<b>Length</b>
9	AUDIT_ACTN	For PeopleSoft Processing only; always leave field blank	Char	1

### Task Element Code Mapping

<b>Task Element Code</b>	<b>Description</b>
ACT	Activity ID
ANT	Account Code
BUH	Business Unit HR (Human Resources)
BUM	Business Unit PF (Performance Measurement)
BUP	PC Business Unit (Project Costing)
COM	Company
CST	Customer
DPT	Department ID
JOB	Jobcode
LOC	Location
POS	Position Number
PRD	Product
PRJ	Project ID
RE1	Rule Element 1
RE2	Rule Element 2

<b><i>Task Element Code</i></b>	<b><i>Description</i></b>
RE3	Rule Element 3
RE4	Rule Element 4
RE5	Rule Element 5
REC	Resource Category
RES	Resource SubCategory
RET	Resource Type
TSK	Task
UF1	User Field 1
UF2	User Field 2
UF3	User Field 3
UF4	User Field 4
UF5	User Field 5

### List of Valid Time Zones

<b><i>Value</i></b>	<b><i>Description</i></b>
ACST	AUS Central Time, Darwin
AFST	Afghanistan Time, Kabul
ARST	Arabian Time, Abu Dhabi, Muscat
AST	Atlantic Time (Canada)
AZST	Azores Time, Cape Verde Is.

<b>Value</b>	<b>Description</b>
BST	Bangkok Time, Hanoi, Jakarta
CASST	Central Asia Time, Almaty, Dhaka
CAUST	Central Australia, Adelaide
CHST	China Time, Beijing, Hong Kong
CPST	Central Pacific, Magadan, Solomon Is.
CST	Central Time
CSTST	Central Time no Daylight Savings
DST	Dateline Time, Eniwetok, Kwajalein
EAUST	East Australia Time, Brisbane, Guam
EEST	East Europe Time, Bucharest
EGST	Egypt Time, Cairo
EKST	Ekaterinburg Time
ESAST	East South America Time
EST	Eastern Time
ESTST	Eastern Time no Daylight Savings, Indiana
FLEST	FLE Time, Helsinki, Riga
FST	Fiji Time, Kamchatka, Marshall Is.
GFTST	GFT Time, Athens, Istanbul, Minsk
GMT	GMT, London, Dublin, Lisbon, Edinburgh

<b>Value</b>	<b>Description</b>
GMTST	GMT Standard Time, Casablanca
HST	Hawaiian Time
IRST	Iran Time, Tehran
IST	India Time, Bombay, Calcutta, New Delhi
KST	Korea Time, Seoul
MAST	Mid-Atlantic Time
MST	Mountain Time
MSTST	Mountain Time no Daylight Savings, Arizona
MXST	Mexico Time, Mexico City, Tegucigalpa
NST	Newfoundland Time
NZST	New Zealand Time, Auckland, Wellington
PST	Pacific Time, Tijuana
RST	Russian Time, Moscow, St. Petersburg, Volgograd
SAEST	SA Eastern Time, Buenos Aires, Georgetown
SAFST	South Africa Time, Israel
SAPST	SA Pacific Time, Bogota, Lima, Quito
SAST	Saudi Arabia Time, Baghdad, Kuwait, Riyadh
SAWST	SA Western Time, Caracas, La Paz
SGST	Singapore Time

<b>Value</b>	<b>Description</b>
SLST	Sri Lanka Time, Colombo
SMST	Samoa Time, Midway Island
SST	Sydney Time, Canberra, Melbourne
TAST	Tasmania Time, Hobart
TPST	Taipei Time
TST	Tokyo Time
VST	Vladivostok Time
WASST	West Asia Time, Islamabad, Karachi, Tashkent
WAUST	West Australia Time, Perth
WEST	West Europe Time, Berlin, Rome, Paris
YST	Yakutsk Time

---

## Configuration of the Integration Broker and the TCD

This section discusses:

- Outgoing service operations from PeopleSoft to the TCD server.
- Incoming service operations from TCD server to PeopleSoft .

### Outgoing Service Operations From PeopleSoft to TCD Server

To view outbound messages and service operations, use PeopleTools Integration Broker, Integration Setup.

---

**Note:** Messages are associated with service operations, which are delivered *Inactive*. You must activate the service operations and the associated handlers, routings, and queues. Queues are delivered in *Pause* status. You must change these to *Run* on the Queue Definitions page.

---

## Service Operations

The following table lists the outbound service operations:

<b>Name</b>	<b>Description</b>
TIME_DEVICE_EMPL_ATT_FULLSYNC	Full Set of Employees for TCD
TIME_DEVICE_EMP_ATT_SYNC	Incremental update of EE to TCD
TIME_DEVICE_PERS_HRS_FULLSYNC	TCD Period TotHrs Full Sync
TIME_DEVICE_PROFILES_FULLSYNC	TCD Task Profiles Full Sync
TIME_DEVICE_RESTRICT_FULLSYNC	TCD Restriction Prof_Full Sync
TIME_DEVICE_RPTG_CODE_FULLSYNC	TCD TRC Full Sync
TIME_DEVICE_RPT_ELMNT_FULLSYNC	TCD Reporting Element FullSync
TIME_DEVICE_SCHEDULE_FULLSYNC	TCD Schedules Full Sync
TIME_DEVICE_SUPERVISOR_FULLSYNC	TCD Supervisor Full Sync
TIME_DEVICE_TASK_VALS_FULLSYNC	TCD Task Elemnt Vals Full Sync
TIME_DEVICE_TEMPLATES_FULLSYNC	TCD Task Templates Full Sync

## Queue

All the service operations above are associated with the following queue.

<b>Name</b>	<b>Description</b>
TIME_COLLECTION_DEVICE_SETUP	Time Collection Device Setup

## Configuring Outbound Setup Tables

Configure the setup tables for outbound messages and service operations by defining the:

- Task Profile

Make sure to check the **Send to TCD** box on the Task Profile page.



See [Creating Task Profiles](#).

- Taskgroup

You will only publish those task profiles with **Send to TCD** selected.

See [Creating Task Profiles](#).

- Time Reporting Code

You will only publish those task profiles with **Send to TCD** checked.

See [Defining and Mapping Time Reporting Codes \(TRCs\)](#).

- TRC Program

You will only publish those TRCs with **Send to TCD** checked on the Time Reporting Code page.

See [Defining TRC Programs](#).

- TCD Type Definition

See [Defining TCD Setup Data in Time and Labor](#).

- TCD Setup

See [Creating Task Profiles](#).

- TCD Group

See [Creating Task Profiles](#).

See the product documentation for *PeopleTools PeopleSoft Integration Broker*.

## Routing Rules

Handler/application class and OnRouteSend codes are in application classes. To see the codes, open the application package with the same name as the message. The OnRouteSend code is located under the RoutingHandler class. The handler/application class is located under the class that has the same name as the message.

## Service Operations Monitor

Information on the Service Operations Monitor is in the Integration Broker PeopleBook.

See *PeopleTools 8.52: Integration Broker PeopleBook, Using the Service Operations Monitor*

## Incoming Service Operations from the TCD Server to the PeopleSoft Server

The following are incoming service operations from the TCD server to the PeopleSoft server, and online pages to check for errors and reported time:

- Service Operations and Queue

The two service operations for incoming messages are: ELAPSED\_TIME\_ADD (Elapsed Time Interface message) and PUNCHED\_TIME\_ADD (Punched Time Interface message).

The queues for these two messages are: ELAPSED\_TIME (Elapsed Time queue) and PUNCHED\_TIME (Punched Time queue).

The handler of the service operations triggers the TL\_ST\_LOADER Application Engine process that inserts rows into the Reported Time Tables. TL\_ST\_LOADER also initiates the Validation process for the validations defined on the TL Installation page.

- TCD Error Queue

This page is located in Set Up HCM, System Administration, Utilities, Analyze Time and Labor, Review TCD Errors. Using **TCD Error Queue**, you can check any errors for the Publishing Node you are using. If there are no errors found for the node, you can see the time in the reporting pages.

See [Understanding TCDs](#).

- Report Time

This page is located in Manager Self-Service, Time management, Report Time, Timesheet. This page displays the list of employees using the **Find** feature on the grid. Select Timesheet and then click on **Name** which opens with the current date as the start of the week. you can change the **Week** begin date and click **Refresh Date**.

See [Reporting Time](#).

## Alternate Service Operation Handler and Process for PUNCHED\_TIME\_ADD Messages

The default service operation handler for PUNCHED\_TIME\_ADD triggers the TL\_ST\_LOADER process to insert the content of an incoming message into reported time. Oracle delivers the PUNCH\_ADD\_DAEMON service operation handler, and the TL\_ST\_LD\_DMN Application Engine process, which provide the following advantages over the default handler and process:

- You can configure a limit to the size of each batch of messages the system processes.
- The transactions for a given employee are kept within a single job. The system does not allow splitting employee transactions across multiple concurrent processes.

The PUNCH\_ADD\_DAEMON handler places the contents of incoming message into a staging table (TL\_ST\_PCHTIME). The handler does not automatically trigger the TL\_ST\_LD\_DMN process. You must specify a repetitive schedule for the STDAEMON job to look for and process new transactions in the staging table. There is no direct tie between incoming message and each recurrence of the STDAEMON job, so the content of each message may be split between multiple jobs. However the process prevents splitting transactions for a given employee across multiple concurrent processes.

The TL\_ST\_LD\_DMN process enables you to configure the maximum size of each batch of messages by setting the Max Punches in a Batch value on the Time and Labor Installation page. The default batch size is 2,000 transactions. The Max Punches in a Batch field is only visible after you activate the PUNCH\_ADD\_DAEMON handler.

In order to use the PUNCH\_ADD\_DAEMON handler, and the TL\_ST\_LD\_DMN process, you must perform the following steps:

1. Activate the PUNCH\_ADD\_DAEMON handler on the Handlers page (IB\_SERVICEHDLR)
2. Define the batch size for the TL\_ST\_LD\_DMN process on the Time and Labor Installation page.
3. Define, or modify, a recurrence pattern for the STDAEMON job on the Recurrence Definition page.
4. Schedule the STDAEMON job on the Schedule JobSet Definition page.

To initiate the first occurrence of the job, set the status to Active. The process has a built-in clean-up of the process monitor queue. This clean-up assumes that the Run Control ID used for the process is "TCD".

## System and Integration Broker Configuration

Make sure you configure the system and Integration Broker for this integration.

See *PeopleTools 8.52: Integration Broker PeopleBook, Understanding Creating and Implementing Integrations*

## Node and Gateway Configuration

This section provides some of the specifics for setting up nodes and gateways for the TCD interface. Use pages in the PeopleTools, Integration Broker, Integration Setup menu and PeopleTools, Integration Broker, Configuration menu to complete this configuration.

### Defining the Local Node

This table provides the specific configuration details for this integration:

<b>Page</b>	<b>Configuration Specifics</b>
Node Definitions	The Node Definition is located in PeopleTools, Integration Broker, Integration Setup, Nodes. Make sure that the <b>Node Type</b> is set to <i>PIA (internal, local)</i> and that you select both <b>Local Node</b> and <b>Active Node</b> .
Connectors	Make sure that you set <b>Connector ID</b> to <i>PSFTTARGET</i> because the local node always uses this value for the 8.4x tool set.

<b>Page</b>	<b>Configuration Specifics</b>
Routings	<p>Routings are defined in PeopleTools, Integration Broker, Integration Setup, Services Operations, Routings. Alternatively, use PeopleTools, Integration Broker, Integration Setup, Routings to define routings.</p> <p>Refer to the Integration Broker PeopleBook for more details on how to set up the routings. Once the routings are set up properly, make sure to activate them.</p> <p>If using flat file architecture, make sure that TIME_DEVICE_XXXX service operations have both <i>OutAsync</i> and <i>InAsync</i> specified with a <b>Status</b> of <i>Active</i>. Flat files are generated by the local Node for each Flat File TCD Server. The location of output is defined on the TL Installation page and the TL General Settings page.</p>

Access the Node Definitions page.

This example illustrates the fields and controls on the Node Definitions page. You can find definitions for the fields and controls later on this page.

Access this page from **PeopleTools > Integration Broker > Integration Setup > Node Definitions**. Make sure that the **Node Type** is set to *PIA (internal, local)* and that you check both **Local Node** and **Active Node**.

Access the Connectors page.

This example illustrates the fields and controls on the Connectors page. You can find definitions for the fields and controls later on this page.

Make sure that you set **Connector ID** to *PSFTTARGET* as the local node always uses this value for the tool set.

Access the Routings page.

See *PeopleTools 8.52: Integration Broker PeopleBook*

This example illustrates the fields and controls on the Routings page (1 of 2). You can find definitions for the fields and controls later on this page.

Selected	Name	Service Operation	Service Operation Version	Operation Type	Sender Node
<input type="checkbox"/>	~GEN~UPG~12150	PAYMENT_EIM_ACKNOWLEDGE	VERSION_1	Asynch	H92JALRM
<input type="checkbox"/>	~GEN~UPG~24574	PAYMENT_EIM_ISSUE	VERSION_1	Asynch	H92JALRM
<input type="checkbox"/>	~GEN~UPG~18007	PAYMENT_EIM_REQUEST	VERSION_1	Asynch	PSFT_IM
<input type="checkbox"/>	PERSON_DISABILITY_FSYNC_OUT_V3	PERSON_DISABILITY_FULLSYNC	INTERNAL	Asynch	H92JALRM
<input type="checkbox"/>	PERSON_DISABILITY_FSYNC_OUT_V2	PERSON_DISABILITY_FULLSYNC	INTERNAL	Asynch	H92JALRM
<input type="checkbox"/>	PERSON_DISABILITY_FSYNC_OUT_V1	PERSON_DISABILITY_FULLSYNC	INTERNAL	Asynch	H92JALRM
<input type="checkbox"/>	PERSON_DISABILITY_SYNC_OUT_V2	PERSON_DISABILITY_SYNC	INTERNAL	Asynch	H92JALRM
<input type="checkbox"/>	PERSON_DISABILITY_SYNC_OUT_V1	PERSON_DISABILITY_SYNC	INTERNAL	Asynch	H92JALRM
<input type="checkbox"/>	PERSON_DISABILITY_SYNC_OUT_V3	PERSON_DISABILITY_SYNC	INTERNAL	Asynch	H92JALRM
<input type="checkbox"/>	~GEN~UPG~14090	PSRF_REPORT_CREATE	VERSION_1	Asynch	PSFT_IM

This example illustrates the fields and controls on the Routings page (2 of 2). You can find definitions for the fields and controls later on this page.

First 1-10 of 13 Last				
Receiver Node	Direction	Status	Results	
PSFT_IM	Outbound	Inactive		<input type="button" value="-"/>
PSFT_IM	Outbound	Inactive		<input type="button" value="-"/>
H92JALRM	Inbound	Inactive		<input type="button" value="-"/>
PSFT_IM	Outbound	Inactive		<input type="button" value="-"/>
PSFT_IM	Outbound	Inactive		<input type="button" value="-"/>
PSFT_IM	Outbound	Inactive		<input type="button" value="-"/>
PSFT_IM	Outbound	Inactive		<input type="button" value="-"/>
PSFT_IM	Outbound	Inactive		<input type="button" value="-"/>
PSFT_IM	Outbound	Inactive		<input type="button" value="-"/>
H92JALRM	Inbound	Active		<input type="button" value="-"/>

If using flat file architecture make sure that TIME\_DEVICE\_XXXX messages have both *OutAsync* and *InAsync* specified with a **Status** of *Active*. Flat files are generated by the local Node for each Flat File TCD Server. The location of output is defined on the TL Installation Page and the TL General Settings Page.

### Defining the External TCD Nodes

This table provides the specific configuration details for this integration:

<b>Page</b>	<b>Configuration Specifics</b>
Node Definitions	TCD Nodes are required only for XML messaging. Make sure that the <b>Node Type</b> is set to <i>External</i> and that you select <b>Active Node</b> .
Connectors	<p>Make sure that you set <b>Connector ID</b> to either <i>PSFT81TARGET</i> or <i>HTTPTARGET</i>.</p> <hr/> <p><b>Note:</b> <i>PST81TARGET</i> is used for external TCD servers which are compliant with 8.1x or 8.2x PeopleTools. <i>HTTPTARGET</i> is used for TCD servers which can support 8.4x toolset documentation.</p> <hr/> <p>Click <b>Ping Node</b> to access the Ping Node Results page.</p>

<b>Page</b>	<b>Configuration Specifics</b>
Routings	<p>Make sure to specify the Time_Device_ xxxx message as <i>outsync</i> and Elapsed and Punch messages as <i>inasync</i>.</p> <p>Make sure to specify outbound and inbound transactions for the external node. The routing type should be <i>implicit</i>.</p>

Access the Node Definitions page.

## Defining the Gateway for the PeopleSoft System

Access the Gateways page.

The gateway for the Peoplesoft local node is typically `http://server/PSIGW/PeopleSoftListeningConnector`.

The gateway on TCD servers that do not support 8.4x Integration Broker is `http://xtnt05.peoplesoft.com/PSIGW/PS81ListeningConnector`. The gateway on TCD servers that do support 8.4x Integration Broker is `http://server/PSIGW/PeopleSoftListeningConnector`.

See the product documentation for *PeopleTools PeopleSoft Integration Broker*

## Enterprise Components Configuration

Use pages in the Enterprise Components, Integration Definitions menu to complete this configuration.

This table describes the specifics for configuring enterprise components for the TCD interface:

<b>Page</b>	<b>Configuration Specifics</b>
Batch Publish Rules	<p><b>Note:</b> If you are using a delivered process, only set those settings that make that process active.</p> <p>The TL_OUTTCD Application engine process uses Batch Publish Rules to publish the messages to TCD Servers. Activate the rules that you will use for TCD Interface. TL_OUTTCD Application engine also triggers service operations to be published.</p>
File Inbound	<p>Activate inbound file rule if you are using flat file integration. Make sure to set the <b>Inbound File</b> to the appropriate location and set <b>Status</b> to <i>Active</i>.</p>
Inbound File (Publish)	<p>Make sure the <b>Request ID</b> is defined. In the <b>Process Frequency</b> group box, select <b>Once</b> if you are running the process with run control ID only one time or select <b>Always</b> if you are using same run control ID repeatedly.</p>

Access the Batch Publish Rules page.

This example illustrates the fields and controls on the Batch Publish Rules search page. You can find definitions for the fields and controls later on this page.

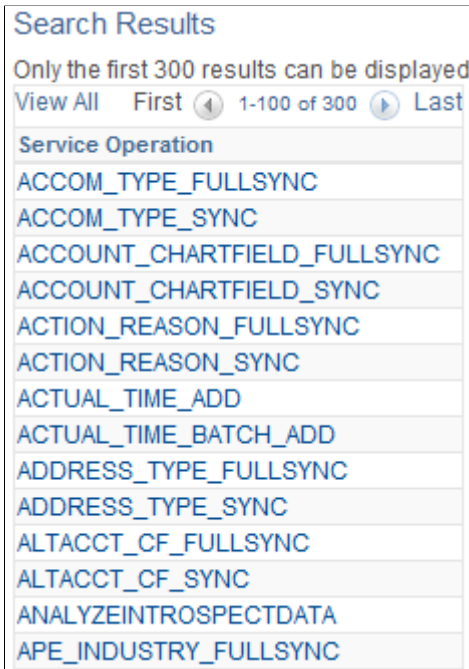

The list that appears are the messages that you can select to configure the messages to be published.

This example illustrates the fields and controls on the Batch Publish Rules page. You can find definitions for the fields and controls later on this page.

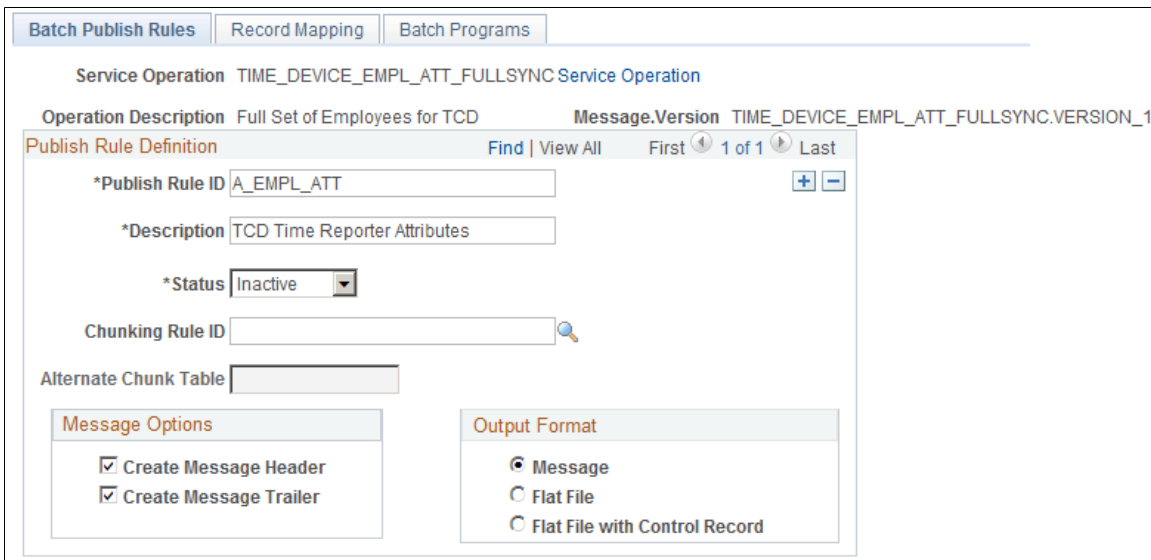

**Note:** If you are using a delivered process, only set those settings that make that process active.

Access this page from **Enterprise Components > Integration Definitions > Batch Publish Rules**. The TL\_OUTTCD Application engine process uses Batch Publish Rules to publish the messages to TCD Servers. Activate the rules, which you will use for TCD Interface. TL\_OUTTCD Application engine also triggers Messages to be published.



## Inbound File Rules

Access the File Inbound page.

This example illustrates the fields and controls on the File Inbound page. You can find definitions for the fields and controls later on this page.

File Inbound

File Identifier PUNCHED\_TIME

\*Inbound File   Index Flag

\*Status

File Layout ID

LUW Size

Program Name  Section

Create Message Header

Create Message Trailer

File Layout
Personalize | Find | View All | 
First 1 of 1 Last

	*Definition Name	*Message Name	
1	<input type="text" value="PUNCHED_TIME_ADD"/>	<input type="text" value="PUNCHED_TIME_ADD"/>	

Access this page from **Enterprise Components > Integration Definitions > Inbound File Rule**. Activate inbound file rule if you are using flat file integration. Make sure to set the **Inbound File** to the appropriate location and set **Status** to *Active*.

## Inbound File Publish

Access the Inbound File (publish) page.

This example illustrates the fields and controls on the Inbound File (publish) page. You can find definitions for the fields and controls later on this page.

The screenshot shows the 'Inbound File' configuration page. At the top, there is a 'Run' button and labels for 'Run Control ID', 'PS', 'Report Manager', and 'Process Monitor'. The main content area is divided into three sections:
 

- Process Request:** Includes a 'Find | View All' link, pagination 'First 1 of 1 Last', and input fields for '\*Request ID' (containing 'TEST') and 'Description'.
- Process Frequency:** Contains three radio button options: 'Once', 'Always' (which is selected), and 'Don't Run'.
- Parameters:** Includes a '\*File Identifier' field with a search icon, an 'Index Flag' checkbox, and a 'File Layout ID' field with the value 'Inbound File'.

Access this page from **Enterprise Components > Integration Definitions > Initiate Processes > Inbound File Publish**. Make sure the **Request ID** is defined. And in the **Process Frequency** group box, select either **Once** (if you are running the process with Run Control ID only one time, or select **Always** if you are using same Run Control ID repeatedly.)

*PeopleSoft Enterprise Components*

## Error Handling and Resolution

The following lists possible issues that may arise:

<b>Question</b>	<b>Answer</b>
Outgoing Messages from the PeopleSoft server to the TCD server: TL_OUTTCD is successful: No messages generated.	Make sure that: <ul style="list-style-type: none"> <li>—Queues are in <i>Run</i> mode.</li> <li>—Routings are specified in the service operations.</li> <li>—Service operations are active.</li> <li>—Batch Publish Rule is selected.</li> <li>—External Node and Transaction Routing Type is specified as Explicit, instead of Implicit.</li> </ul>

<b>Question</b>	<b>Answer</b>
<p>Incoming messages from the TCD server to the PeopleSoft server. This error message appeared:</p> <pre>"&lt;?xml version="1.0" ? &gt;&lt;reply&gt;&lt;operations&gt;&lt;exception&gt;&lt;title&gt;Publish Subscribe Message Exception&lt;/title&gt;&lt;defaultmsg&gt;psft. pt8.gateway.PublicationHandlerException: &lt;/ defaultmsg&gt;&lt;msgset&gt;94&lt;/msgset&gt;&lt;msgid&gt;1&lt;/ msgid&gt;&lt;parameters count="1"&gt;&lt;parm&gt;psft.pt8.gateway. PublicationHandlerException: &lt;/parm&gt;&lt;/parameters&gt;&lt;/ exception&gt;&lt;/operations&gt;&lt;/reply&gt; &lt;?xml version="1. 0" ?&gt;&lt;reply&gt;&lt;operations&gt;&lt;exception&gt;&lt;title&gt;Publish Subscribe Message Exception&lt;/title&gt;&lt;defaultmsg&gt;psft. pt8.gateway.PublicationHandlerException: &lt;/ defaultmsg&gt;&lt;msgset&gt;94&lt;/msgset&gt;&lt;msgid&gt;1&lt;/ msgid&gt;&lt;parameters count="1"&gt;&lt;parm&gt;psft.pt8.gateway. PublicationHandlerException: &lt;/parm&gt;&lt;/parameters&gt;&lt;/ exception&gt;&lt;/operations&gt;&lt;/reply&gt;"</pre>	<p>This error message signifies that the transaction is not specified for that TCD Server node.</p>
<p>Ping does not work from the People Soft server to the TCD server.</p>	<p>Make sure you are using the appropriate target connector as discussed in Node configuration.</p>
<p>How do I purge message details?</p>	<pre>DELETE FROM PSAPMSGPUBHDR; DELETE FROM PSAPMSGPUBDATA; DELETE FROM PSAPMSGPUBCON; DELETE FROM PSAPMSGSUBCON; DELETE FROM PSAPMSGPUBCERR; DELETE FROM PSAPMSGPUBERR; DELETE FROM PSAPMSGSUBCERR; DELETE FROM PSAPMSGPUBCERRP; DELETE FROM PSAPMSGPUBERRP; DELETE FROM PSAPMSGSUBCERRP; DELETE FROM PSAPMSGARCHPC; DELETE FROM PSAPMSGARCHPD; DELETE FROM PSAPMSGARCHPH; DELETE FROM PSAPMSGARCHSC;</pre>

<b>Question</b>	<b>Answer</b>
Flat files were not created for outbound messages, but messages were generated in the Service Operations Monitor.	<p>Make sure that:</p> <ul style="list-style-type: none"> <li>Routing are defined properly in the service operations.</li> <li>—Handlers are active on all the service operations.</li> <li>—You are looking at the right location, which is specified on TL Installation page (TL General setting).</li> <li>—TL_OUTTCD has not generated any errors.</li> <li>—Your Application server and process scheduler has read and write access to the file location.</li> </ul>
The flat file is not empty after the Inbound File Publish process is run.	<p>Make sure that:</p> <ul style="list-style-type: none"> <li>—The file location is properly specified on the Inbound File Rule page.</li> <li>—Inbound File Rule is active.</li> <li>—The Inbound File process run control has Process Frequency set to Always or Once (as needed).</li> <li>—You are following comma delimiter for each column.</li> <li>—The Inbound File Rule is active.</li> <li>—The file name is ELAPSED_TIME*.CSV or PUNCHED_TIME*.CSV</li> </ul>
The messages transactions are not same as in the flat file.	Make sure that each row in the flat file has a carriage return in the sense each transaction should be a new line in simple sense each line by hitting your return/key.
I am getting a large message.	When the message size exceeds the size set on the PeopleTools, Options pages, the message splits into multiple messages. For Full-sync, there would be one header followed by multiple data messages and then one trailer.
I am receiving header and footer information only.	Service Operations are active but probably TCD Type setup is not appropriate, or no data to publish Task elements and or time reporting elements or schedules.
Where can I find the Message log and the Error log?	<p>Msg Log : <a href="http://server/PSIGW/msgLog.html">http://server/PSIGW/msgLog.html</a> and,</p> <p>Error Log : <a href="http://server/PSIGW/errorLog.html">http://server/PSIGW/errorLog.html</a></p>

---

## Frequently Asked Questions

The following table addresses some frequently asked questions:

<b>Question</b>	<b>Answer</b>
Is a password necessary for the Node definition?	No, it is not. If the external node wants to enforce the password , you need to specify that on the Node Definitions page of the external node.
Do all the downloads have the TCD ID?	Yes, each TCD will get employee population and other information.
Will each TCD record its own employee information?	Yes, each TCD will get employee population and other information.
Why do I see two data messages for one full_sync publish?	If a message exceeds the allotted size, the message is divided into multiple messages. For example, if the TCD server receives the header followed by multiple data messages and then a trailer.
What is the Operator ID (char 8) in the Punched and Elapsed transactions? How do I validate this information?	Oprid : can be left blank or it is up to implementation site if they want to populate with the ID of the person who is punching.
Why don't I see the header message for TIME_DEVICE_EMPL_ATT_SYNC?	Empl Att sync will not have header and trailer as it is considered as incremental message, this is the only message which is incremental. The TCD server receives all other messages are Full Synch which will have header, data and trailer messages.



# Referential Integrity

---

## Background Processing

Time and Labor provides several batch processes to ensure that data is error-free when information changes online or when the system performs batch processing through Time Administration. Two of these processes are Referential Integrity (RI) and Time Validation. The system uses default processing to determine the correct information for processing time.

When you make a change to one object in the system, Referential Integrity process ensures that the change does not invalidate data in related objects.

RI starts working after you select the Referential Integrity check box on the Time and Labor Installation page.

The Referential Integrity process:

- Determines affected reported and payable time and time reporters.

It checks for retroactive changes to effective-dated setup data or employee-related data that could invalidate related objects or values in the system. The system uses an RI router that determines the effect of changes to reported or payable time for affected time reporters. Only online updates trigger RI processing.

- Validates time during the Time Administration process.
- Creates or resolves exceptions during the Time Administration process.

When processing data through Time and Labor, exceptions are created or resolved automatically, and payable time is recalculated as necessary.

- Updates TR status records to reevaluate payable time.

When processing data through Time and Labor, RI evaluates changes and reevaluates affected time.

- Disallows the inactivation or deletion of certain records or the change of effective-dated rows.

The system displays error messages when you try to inactivate, delete, or change an effective-dated row that invalidates the association with another table.

The Referential Integrity process checks for discrepancies and validates time for:

- Time collection device data
- Time collection groups
- Time reporter data
- TRCs

- Time reporting code programs
- Workgroups
- Taskgroups
- Task profiles
- Rule programs
- Shifts, Schedules, and schedule assignments
- Time period calendars
- Comp time plans
- Time reporter association to comp time plans
- DeptID change on the Job page
- The Department table
- Leave plans
- The Leave Plan table

The Referential Integrity process checks data when any reported or payable time exists on or after the effective-dated setup change.

### **Execute Edit Errors**

When you try to change the effective date of a setup page to a date that is greater than a prompt value on that page, you receive an error message. For example, you receive an error message if you attempt to change the effective date of the workgroup to be greater than the effective date of the TRC Program. Workgroup is the target table and the TRC Program is the prompt table.

Message number 13500,103 in the message catalog states:

"Edit Error for field %1. The Value in the column specified is not a valid value. This error may have been caused by a change to the Effective Date or to some other field which controls the list of valid values for the field in question. This error can be corrected by selecting a valid value for this field from the Prompt list, or by correcting the changes which have caused this error. Another option is to cancel the changes and start over."

The field that will be filled in the %1 is the prompt field that is negatively affected by the effective-dated change on the target table. Changing the effective date in a target table to a date greater than that in the prompt table generates an error.

This table lists the relationships between target and prompt tables.



<b>Target Table (Main Page)</b>	<b>Prompt Table (Table Assigned to Main Page)</b>
Workgroup	Rule Program ID TRC Program Compensatory Time Off Plan
Time Reporting Code	Unit of Measure NA Earnings Code Global Payroll Take Code Global Payroll Earnings Code
TRC Program	Time Reporting Code
Comp Time Plan	Time Reporting Code
Taskgroup	Task Profile
TCD Setup	TCD Type TRC Program Taskgroup
TL Empl Data (Create Time Reporter Data or Maintain Time Reporter Data)	Workgroup Taskgroup TCD Group Rule Elements 1-5
Schedule	Shift

### **Nested Effective-Dated Tables**

The RI process acts upon effective dates throughout the application. It does not enable effective-dated changes to objects that are nested in other effective-dated objects when the change invalidates the association between the two. It prevents this from occurring in these ways:

- When the nested object effective date is greater than the host object effective date, you receive an error message.

For example, the effective date of the workgroup affects the Maintain Time Reporter Data table; the minimum effective date of the workgroup cannot be later than the effective date of the Maintain Time

Reporter Data page. Also, the TRC Program effective date cannot be later than the effective date of the workgroup, TCD group, and so on.

- The system does not enable you to delete or inactivate a row that is used by another object.
- If you try to inactivate or delete an effective-dated row that uses another effective-dated object, the system verifies that the date does not invalidate the association with the nested effective-dated table.

For example, if a workgroup is associated with a time reporter and you try to inactivate that workgroup, you will get a message that states that you cannot inactivate this workgroup because time reporters are participating in it.

See message number 13500,104 in the Message Catalog. The message states:

"Effective Date change invalidates related setup data; date must be on or before %1."

The %1 represents the effective date that needs to be maintained for the integrity of the nested object.

This table lists the relationships among nested objects; the source table cannot have an effective date greater than the target table:

<b>Source Table (Prompt Table)</b> <b>Table Assigned to the Main Page</b>	<b>Target Table (Main Page)</b>
Compensatory Time Off Plan	Workgroup Comp Plan Enrollment
Time Reporting Code	TRC Program Compensatory Time Off Plan
TRC Program	Workgroup TCD Setup
Rule Program	Workgroup
Workgroup	Create/Maintain Time Reporter Data
TCD Type	TCD Setup
TCD Setup	TCD Group
TCD Restriction Profile	TCD Group
TCD Group	Create/Maintain Time Reporter Data

<b>Source Table (Prompt Table)</b> <b>Table Assigned to the Main Page</b>	<b>Target Table (Main Page)</b>
Taskgroup	Create/Maintain Time Reporter Data TCD Setup
Task Profile	Taskgroup
Taskgroup Profile	Taskgroup
Rule Elements 1-5	Create/Maintain Time Reporter Data
Job	Create/Maintain Time Reporter Data
Shift	Schedule Definition
Workday	Schedule Definition
Create/Maintain Time Reporter Data	Comp Plan Enrollment

## Referential Integrity Triggers

When you change an effective-dated setup object, these events occur:

1. The system determines whether or not that change affects any reported or payable time.

If a change affects reported or payable time, the system writes a row in a control record to identify the setup change and any validations to be run as a result.

2. The Referential Integrity process triggers the Time Validation process.

The Time Validation process checks for any reported or payable time that is negatively affected by the setup change and triggers exceptions for invalid elements. If validation is unnecessary, the Referential Integrity process triggers Time Administration to reprocess payable time that is affected by the setup change.

3. When Time Administration runs, it initiates a separate RI review process.

The RI process determines whether any rows exist in the control record to identify setup changes. If rows exist in the control record, the RI process determines which time reporters are affected by each change in the record. The affected time reporters will:

- Change their Time Administration status so that they are selected for Time Administration processing.

- Set their earliest change date to the first instance of reported or payable time that is equal to, or greater than, the effective date of the setup table change.
- Run the Time Validation process against reported time that is equal to or greater than the new earliest change date.

4. Time Administration continues processing.

The process runs rules, runs Time Administration Validation, and creates payable time based on the updated earliest change date.

**Example**

Today's date is February 28, 1990. You decide to change the TRC Program on Workgroup A for the effective date of January 1, 1990 from TRC Program A to TRC Program B.

<i>Workgroup</i>	<i>TRC Program ID</i>	<i>Effective Date</i>
Workgroup A	TRC Program A	January 1, 1980
Workgroup A	TRC Program B	January 1, 1990
Workgroup A	TRC Program A	January 1, 1995 (future time can be reported up to this next effective date)

All TRCs reported between the effective date of January 1, 1990 and January 1,1995 need review. If the TRCs reported during this period do not exist in TRC Program B, the system generates exceptions on the invalid time. Change the TRCs associated with that time or adjust the TRCs in TRC Program B to resolve these exceptions.

---

**Note:** For the RI process to correctly trigger changes to JOB Data, the DEPT\_SYNC message must be active on the ENTERPRISE\_SETUP queue, which is delivered with PeopleSoft Integration Broker.

---

*PeopleSoft Application Integration Framework and PeopleSoft Application Integration Framework*

---

## Time Administration and Referential Integrity

Time Administration does the following:

- Provides the tools to create, maintain, and apply the organization's compensation, task, and exception rules to reported and scheduled time.
- Validates instances of reported time and generates payable time.
- Creates exceptions.
- Uses the RI process to check for setup changes that may affect processed time.

- Verifies that changes, either system generated or user generated changes, do not negatively affect the system or create errors related to reported or payable time.
- Processes validations before creating payable time.

These include compensatory time, leave, TRC, task, and time reporter status validations. This ensures that the payable time is valid.

If you do not include the delivered validation definitions in your validation set, validations against reported time are not included in the Submit Time process.

**Note:** Time Administration calculates payable time for only those time reporters defined in the run control for Time Administration. The RI process updates the earliest change dates for time reporters defined in the run control. However, any other affected time reporters excluded from the current Time Administration run are reprocessed in the next Time Administration run with these time reporters.

This flow chart shows the high-level view of the Referential Integrity process and Time Administration process

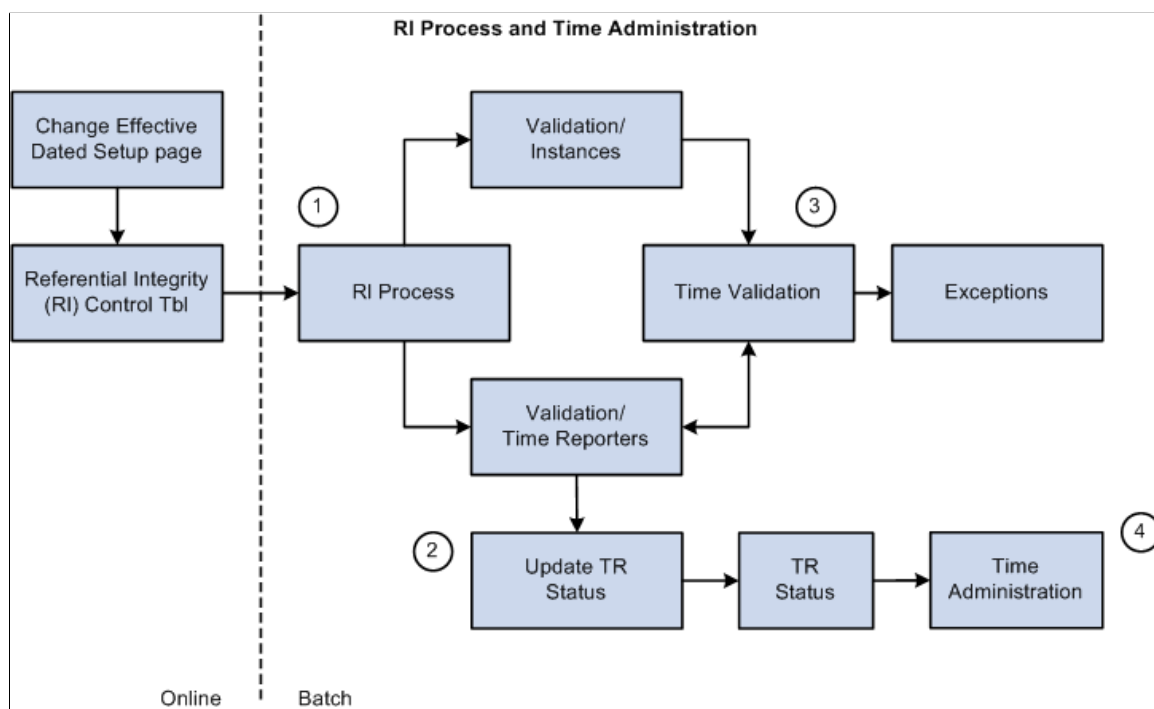

## Related Links

[Understanding Time Administration](#)

[Understanding the Time Administration Process Flow](#)

## Time Reporting Codes and Referential Integrity

When you make a change to one area of the application, the RI process makes sure the changes do not adversely affect another area of the application. It checks for retroactive changes to effective-dated setup data or employee related data that could invalidate related objects or values in the system.

## Prevention of Inactivation or Deletion of Effective-Dated Rows

This table lists the pages and conditions when the system will not allow the inactivation or deletion of effective-dated rows.

<i>Page</i>	<i>Condition</i>
TRC	<p>You cannot:</p> <ul style="list-style-type: none"> <li>• Inactivate a TRC that is associated with a TRC program.</li> <li>• Delete an effective-dated row if it invalidates the association with a TRC program.</li> <li>• Inactivate a TRC if it is associated to a Compensatory Time Off Plan.</li> <li>• Delete an effective-dated row if it invalidates the association with a Compensatory Time Off Plan.</li> </ul>
TRC Program	<p>You cannot:</p> <ul style="list-style-type: none"> <li>• Inactivate a TRC program if it is associated to a Workgroup.</li> <li>• Delete an effective-dated row if it invalidates the association to a Workgroup.</li> <li>• Inactivate a TRC program if it is associated to a Time Collection Device.</li> <li>• Delete an effective-dated row if it invalidates the association to a Time Collection Device.</li> </ul>

## Execute Edit Error Checking

You cannot change the minimum effective date on a page to be less than the minimum effective date of a field that acts as a prompt on this page.

<i>Page</i>	<i>Prompts on Page</i>
TRC	Unit of Measure, NA Earnings Code, GP Take Code, GP Earns Code
TRC Program	TRC

## Nested Effective Dates

You cannot change the effective date of the prompt table to be greater than the effective date of the target table.

<i>Prompt Table</i>	<i>Target Table</i>
TRC	TRC Program, Compensatory Time Off Plan
TRC Program	Workgroup, TCD Setup

---

## Task Reporting and Referential Integrity

When you make a change to one area of Time and Labor, the RI process makes sure the changes do not adversely affect another area of the application. It checks for retroactive changes to effective-dated setup data or employee related data that could invalidate related objects or values in the system.

## Prevention of Inactivation or Deletion of Effective-Dated Rows

This table lists the pages and conditions when the system will not allow the inactivation or deletion of effective-dated rows.

<i>Page</i>	<i>Condition</i>
Taskgroup	<p>You cannot:</p> <ul style="list-style-type: none"> <li>• Inactivate a taskgroup that is assigned to a time reporter through the Create/Maintain Time Reporter Data page.</li> <li>• Inactivate a taskgroup that is assigned to a time collection device (TCD) on the TCD Taskgroup page.</li> <li>• Delete an effective-dated row if it invalidates the association to a time reporter.</li> <li>• Delete an effective-dated row if it invalidates the association to a TCD Group.</li> </ul>
Task profile	<p>You cannot:</p> <ul style="list-style-type: none"> <li>• Inactivate a task profile that is assigned to a taskgroup.</li> <li>• Delete an effective-dated row if it invalidates the association to a taskgroup</li> </ul>

## Execute Edit Error Checking

You cannot change the minimum effective date on a page to be less than the minimum effective date of a field that acts as a prompt on this page.

<i>Page</i>	<i>Prompts on Page</i>
Taskgroup	Task Profile

## Nested Effective Dates

You cannot change the effective date of the prompt table to be greater than the effective date of the target table.

<i>Prompt Table</i>	<i>Target Table</i>
Taskgroup	Create/Maintain Time Reporter Data TCD Setup
Task Profile	Taskgroup
Taskgroup Profile	Taskgroup

---

## Time Administration and Referential Integrity Triggers

This section provides a table listing the situations in which Referential Integrity is initiated and is processed through Time Administration.

This table lists the RI triggers:

<i>Page</i>	<i>Prompt on Page</i>	<i>System Action</i>	<i>Validation ID</i>	<i>Trigger TA?</i>
Create/Maintain Time Reporter Data	Workgroup	Update	TLX00440	Y
	Taskgroup	Update	TLX00070	Y
			TLX00090	
			TLX00100	
	Task Profile	Update	TLX00070	Y



<b>Page</b>	<b>Prompt on Page</b>	<b>System Action</b>	<b>Validation ID</b>	<b>Trigger TA?</b>
	Rule Element 1-5	Update	None	Y
Comp Plan Enrollment	Compensatory Time Off Plan	Add/Del/Update	TLX00001	Y
Time Reporting Code	TRC Type – Changed to Hours	Update	TLX00490	Y
	TRC Type – Changed to Amount	Update	TLX00500	Y
	TRC Type – Changed to Units	Update	TLX00510	Y
	Maximum Quantity	Update	TLX00450	Y
	Minimum Quantity	Update	TLX00450	Y
	Flat Amount	Update	TLX00460	Y
	Rate	Update	TLX00470	Y
	Effect on Comp/Leave	Update when indicator is changed from None to Comp Earned or Comp Taken	TLX00001	Y
		Update when indicator is changed from None to Leave Taken	TLX0010	Y
TRC Program	Time Reporting Code	Add/Delete	TLX00440	Y
Workgroup	TRC Program ID	Update	TLX00440	Y
	Rule Program ID	Update	None	Y
	Comp Time Plan	Update	TLX00001	Y
	Holiday Schedule	Update	None	Y
	Schedule ID	Update	None	Y

<b>Page</b>	<b>Prompt on Page</b>	<b>System Action</b>	<b>Validation ID</b>	<b>Trigger TA?</b>
	Needs Approval	Update	None	Y
	Day Breaker	Update	None	Y
	Day Breaker Range	Update	None	Y
	Day Breaker Options	Update	None	Y
	Round Punches Before Rules	Update	None	Y
	Rounding Intervals (Mins)	Update	None	Y
	Rounding Marker (Mins)	Update	None	Y
	Round Duration After Rules	Update	None	Y
	Rounding Options (Day, None, Segment)	Update	None	Y
Task Profile	Task Profile ID	Add/Update	TLX00060	Y
Taskgroup	Taskgroup	Add	TLX00040	Y
	Task Template	Update	TLX00090	Y
			TLX00100	
	Default Task Profile ID	Update	None	Y
Taskgroup (Profile)	Task Profile ID	Inactivate	TLX00070	Y
			TLX00080	
		Add	TLX00070	Y
			TLX00080	

<b>Page</b>	<b>Prompt on Page</b>	<b>System Action</b>	<b>Validation ID</b>	<b>Trigger TA?</b>
Build Time Period Calendar	Time Period ID	Update	None	Y
Rule Program	Priority	Update	None	Y
	Rule ID	Update	None	Y
Compensatory Time Off Plan	Expiration Period	Update	TLX00001	Y
	Number	Update	TLX00001	Y
	Maximum Negative Hours Allowed	Update	TLX00001	Y
	Maximum Positive Hours Allowed	Update	TLX00001	Y
Compensatory Time Off Plan (TRC)	Time Reporting Code	Add/Delete	TLX00001	Y
Assign Work Schedule	Schedule ID	Update	None	Y
Override Scheduled Workday	Shift	Add/Update	None	Y
Job Data	All Fields	Add/Update	TLX00830*	Y
Department	Use Actuals Distribution	Update	TLX00830**	Y
Leave Plan Table	Maximum Negative Hours Allowed	Update	TLX00010	Y
	Accrued Balance Goes Negative	Update	TLX00010	Y
Leave Plans (USA)	Benefit Plan	Add/Update	TLX00010	Y
	Plan Type	Update	TLX00010	Y
	Coverage Election	UpdateECD	TLX00010	Y

\*Any effective dated change to JOB data for an employee causes the ECD for the employee to be moved back to the earliest instance of reported or payable time that is on or after the effective dated change to JOB data. When the Time Administration process is run a new row in the RI Control table validates this time for this employee, and processes validation TLX00830, which checks that the Commitment Accounting flag is in consistent with the taskgroup in reported and payable time, and the DEPTID on JOB data for the employee. The update to the RI Control table for the JOB data change is made possible through the use of the Workforce Sync message.

\*\*Any change to a department in the Department table triggers the Department Sync message to insert a row into the RI Control table to validate that no employee that is associated with the department has a change in the commitment accounting flag that is inconsistent with the commitment accounting flag of the taskgroup used in reported or payable time for that employee, as of the effective date of the change or greater.

## Understanding the TCD Interface and Referential Integrity

When you change one area of the application, referential integrity ensures that changes do not adversely affect another area of the application. The system checks for retroactive changes to effective-dated setup data or time-reporter-related data that could invalidate related objects or values.

The following sections describe referential integrity actions when certain changes, inactivations, or deletions are made during TCD processing.

### Prevention of Inactivation or Deletion of Effective-Dated Rows

The following table lists the pages and conditions when the system will not allow the inactivation or deletion of effective-dated rows.

<i>Page</i>	<i>Condition</i>
TCD Group	<p>You cannot inactivate a TCD group that is associated with a time reporter.</p> <p>You cannot delete an effective-dated row if the deletion invalidates the association to a time reporter.</p>
TCD Setup	<p>You cannot inactivate a TCD if the TCD is attached to a TCD group.</p> <p>You cannot delete an effective-dated row if it invalidates the association to a TCD group.</p>

### Execute Edit Error Checking

You cannot change the minimum effective date on a page to be less than the minimum effective date of a field that acts as a prompt on the page.

<b>Page</b>	<b>Prompts on Page</b>
TCD Setup	TCD Type TRC Program Taskgroup

## Nested Effective Dates

You cannot change the effective date of the prompt table to be greater than the effective date of the target table.

<b>Prompt Table</b>	<b>Target Table</b>
TCD Type	TCD Setup
TCD Setup	TCD Group
TCD Restriction Profile	TCD Group
TCD Group	Maintain TR Data



# Delivered Workflow for Time and Labor

---

## Delivered Workflow for Time and Labor

This section discusses Time and Labor workflow.

See the product documentation for *PeopleTools: Workflow Technology and PeopleTools: PeopleSoft Applications User's Guide*

### Overtime Request

This section discusses the Request Overtime workflow.

#### Description

<i>Information Type</i>	<i>Description</i>
Event Description	An employee completes and submits an overtime request and generates an email and/or worklist entry that is sent to the employee's manager.
Action Description	When the Worklist entry is selected (or the link in the email selected) by the manager, the system transfers the manager to the Approve Overtime Request page, where the overtime request is approved or denied. When the request is either approved or denied, the employee is notified via email.
Notification Method	Email and/or Worklist

---

**Note:** Oracle PeopleSoft delivers Notification Composer Framework to manage the setup and administration of all notifications in one central location.

Once you have adopted the Notification Composer feature, you must use it to create new notifications and manage your existing notifications.

Notifications delivered with HCM Image 47 or later must use Notification Composer.

For more information about Notification Composer Framework, see “Understanding Notification Composer” (Enterprise Components).

---

## Workflow Objects

<b>Information Type</b>	<b>Description</b>
Event	An employee submits an overtime request for approval
Workflow Action	Automatic
Role	Employee
Email Template	TriggerBusinessEvent(@&BusProc, @&Activity, @&EmailEvent)
Business Process	TL_OVERTIME
Business Activity	TL_OVERTIME
Business Event	Request overtime approval and notification.



## Chapter 37

# Time and Labor Reports

## Time and Labor Reports: A to Z

The table in this topic lists the Time and Labor reports, sorted alphanumerically by report ID. The reports listed are all SQR reports.

For more information about running these reports, refer to *PeopleTools: BI Publisher for PeopleSoft* and *PeopleTools: SQR Language Reference for PeopleSoft*.

For samples of the reports, see the [Report Samples PDF](#) that is published with this product documentation.

<b>Report ID and Report Name</b>	<b>Description</b>	<b>Navigation</b>	<b>Run Control Page</b>
TL001 Payable Status	Generate TL001 that lists all Payable time for a range of dates, sorted by the chosen Payable Statuses on the run control, to provide the manager with a picture of processed and unprocessed time.	<b>Time and Labor &gt; Reports &gt; Payable Status Report</b>	TL_RUNCTL_TL001
TL002 Generating a Time Card	Generate TL002 that displays all punch time, elapsed time rows, payable time, and unresolved exceptions for an individual employee for the period selected on the run control. The report can be run by either an individual employee, or by a group. The report also contains lines for approval signatures for both the employee and the approving supervisor.	<b>Time and Labor &gt; Reports &gt; Time Card</b>	TL_REPORTS_RNCTL
TL003 TCD Usage	Generate TL003 that totals the number elements transmitted to a Time Collection Device for time reporting. The report is a tool that can assist in the process of estimating memory usage at each time reporting device.	<b>Set Up HCM &gt; Product Related &gt; Time and Labor &gt; Time Collection Devices &gt; Send Setup to TCD</b>	TL_TCD_RUN_PNL

<b>Report ID and Report Name</b>	<b>Description</b>	<b>Navigation</b>	<b>Run Control Page</b>
TL004 Scheduled Hours Report	Generate TL004 that provides information about a time reporter's scheduled time. It gives details such as: punch types and times for employees with a punch schedule; duration of work hours for employees with an elapsed schedule; and the values for the In, Out, Flex, and Core Period fields for time reporters with flex schedules.	<b>Time and Labor &gt; Reports &gt; Scheduled Hours Report</b>	TL_SCHRPT_RNCTL
TL005 Reported Time Audit	Generate TL005 that lists all Reported time Audits for a range of Dates to provide the manager with a picture of Reported time added, modified or deleted.  An individual employee, or a group can run the report. The report also contains lines for approval signatures for both the employee and the approving supervisor.	<b>Time and Labor &gt; Reports &gt; Reported Time Audit</b>	TL_RT_AUDIT_RUNCTL
TL006 Leave Report	Generate TL006 that lists all of the leave details for a year sorted by the specified month, to provide the manager with a picture of leave taken, leave earned and the corresponding leave balances.	<b>Time and Labor &gt; Reports &gt; Leave Report</b>	TL_LCOMP_RUNCTL
TL_RT_AUDIT_RUNCTL Timesheet	Click the <b>Print Timesheet</b> link to generate a Timesheet details report. The report is available only in employee and Manager Self Service.  The report also contains lines for approval signatures for both the employee and the approving supervisor.	<ul style="list-style-type: none"> <li>• <b>Self Service &gt; Time Reporting &gt; Report Time &gt; Timesheet</b></li> <li>• <b>Manager Self Service &gt; Time Management &gt; Report Time &gt; Timesheet</b></li> </ul>	Not Applicable