PeopleSoft Campus Solutions 9.2: Campus Community Fundamentals

September 2024

This software and related documentation are provided under a license agreement containing restrictions on use and disclosure and are protected by intellectual property laws. Except as expressly permitted in your license agreement or allowed by law, you may not use, copy, reproduce, translate, broadcast, modify, license, transmit, distribute, exhibit, perform, publish, or display any part, in any form, or by any means. Reverse engineering, disassembly, or decompilation of this software, unless required by law for interoperability, is prohibited.

The information contained herein is subject to change without notice and is not warranted to be error-free. If you find any errors, please report them to us in writing.

If this is software, software documentation, data (as defined in the Federal Acquisition Regulation), or related documentation that is delivered to the U.S. Government or anyone licensing it on behalf of the U.S. Government, then the following notice is applicable:

U.S. GOVERNMENT END USERS: Oracle programs (including any operating system, integrated software, any programs embedded, installed, or activated on delivered hardware, and modifications of such programs) and Oracle computer documentation or other Oracle data delivered to or accessed by U.S. Government end users are "commercial computer software," "commercial computer software documentation," or "limited rights data" pursuant to the applicable Federal Acquisition Regulation and agency-specific supplemental regulations. As such, the use, reproduction, duplication, release, display, disclosure, modification, preparation of derivative works, and/or adaptation of i) Oracle programs (including any operating system, integrated software, any programs embedded, installed, or activated on delivered hardware, and modifications of such programs), ii) Oracle computer documentation and/or iii) other Oracle data, is subject to the rights and limitations specified in the license contained in the applicable contract. The terms governing the U.S. Government's use of Oracle cloud services are defined by the applicable contract for such services. No other rights are granted to the U.S. Government.

This software or hardware is developed for general use in a variety of information management applications. It is not developed or intended for use in any inherently dangerous applications, including applications that may create a risk of personal injury. If you use this software or hardware in dangerous applications, then you shall be responsible to take all appropriate fail-safe, backup, redundancy, and other measures to ensure its safe use. Oracle Corporation and its affiliates disclaim any liability for any damages caused by use of this software or hardware in dangerous applications.

Oracle®, Java, MySQL, and NetSuite are registered trademarks of Oracle and/or its affiliates. Other names may be trademarks of their respective owners.

Intel and Intel Inside are trademarks or registered trademarks of Intel Corporation. All SPARC trademarks are used under license and are trademarks or registered trademarks of SPARC International, Inc. AMD, Epyc, and the AMD logo are trademarks or registered trademarks of Advanced Micro Devices. UNIX is a registered trademark of The Open Group.

This software or hardware and documentation may provide access to or information about content, products, and services from third parties. Oracle Corporation and its affiliates are not responsible for and expressly disclaim all warranties of any kind with respect to third-party content, products, and services unless otherwise set forth in an applicable agreement between you and Oracle. Oracle Corporation and its affiliates will not be responsible for any loss, costs, or damages incurred due to your access to or use of third-party content, products, or services, except as set forth in an applicable agreement between you and Oracle.

Documentation Accessibility

For information about Oracle's commitment to accessibility, visit the Oracle Accessibility Program website at <https://docs.oracle.com/pls/topic/lookup?ctx=acc&id=docacc>.

Access to Oracle Support

Oracle customers that have purchased support have access to electronic support through My Oracle Support. For information, visit <https://docs.oracle.com/pls/topic/lookup?ctx=acc&id=info> or visit <https://docs.oracle.com/pls/topic/lookup?ctx=acc&id=trs> if you are hearing impaired.

Contents

- Preface: Preface.....xxxvii**
- Understanding the PeopleSoft Online Help and PeopleBooks..... xxxvii
- Hosted PeopleSoft Online Help..... xxxvii
- Locally Installed PeopleSoft Online Help..... xxxvii
- Downloadable PeopleBook PDF Files.....xxxvii
- Common Help Documentation..... xxxvii
- Field and Control Definitions..... xxxviii
- Typographical Conventions.....xxxviii
- ISO Country and Currency Codes..... xxxix
- Region and Industry Identifiers..... xxxix
- Translations and Embedded Help..... xl
- Using and Managing the PeopleSoft Online Help..... xl
- PeopleSoft CS Related Links..... xl
- Contact Us.....xl
- Follow Us.....xl
- Chapter 1: Getting Started with Campus Community.....43**
- Campus Community Overview..... 43
- Campus Community Business Processes..... 43
- Campus Community Integrations..... 45
- Campus Community Implementation..... 46
- Additional Information for Getting Started with Campus Community..... 47
- Chapter 2: Designing Campus Community..... 49**
- Designing Campus Community..... 49
- Reviewing or Defining Campus Community Installation Settings..... 50
- Prerequisites..... 50
- Page Used to Review or Define Campus Community Installation Settings..... 51
- Reviewing or Defining Default Installation Settings for Events, Relationships, SEVIS,
Checklists, National IDs, Communication Preferences, and Fluid..... 51
- Reviewing or Defining Default Installation Settings for Name and Address Types..... 58
- (NZL) Reviewing or Defining Default Installation Settings for National Student Index
Processing..... 60
- Reviewing or Defining Installation Settings For Biographic Fields..... 61
- Setting Up Additional Name Information..... 64
- Pages Used to Set Up Additional Name Information..... 65
- Understanding Additional Name Information..... 66
- Defining Name Format Types and Fields..... 66
- Configuring the Display Name..... 68
- Configuring the Formal Name..... 70
- Configuring the PeopleSoft Name..... 71
- Defining Name Types..... 72
- Defining Name Prefixes..... 73
- Defining Name Suffixes..... 74
- Defining Royal Name Prefixes..... 74
- Defining Royal Name Suffixes..... 75
- Refreshing Name Display Records..... 75
- Defining Address Types..... 76

Page Used to Define Address Types.....	77
Entering and Editing Address Types.....	77
Administering Country Codes.....	78
Understanding Country Codes.....	78
Pages Used to Administer Country Codes.....	79
Updating Country Information.....	79
Defining Address Formats.....	79
Specifying the Display and Print Format.....	84
Modifying Search Values.....	85
Adding States or Provinces.....	86
Defining National ID Types.....	86
Understanding National ID Types.....	87
Page Used to Define National ID Type.....	87
Assigning National ID Types.....	87
Setting Up and Reviewing Regulatory Regions.....	89
Page Used to Set Up and Review Regulatory Regions.....	90
Setting Up Regulatory Regions.....	90
Setting Up Holiday Schedules.....	92
Page Used to Set Up Holiday Schedules.....	92
Defining Holiday Schedules.....	92
Defining Citizen Status Codes.....	93
Page Used to Define Citizenship Status.....	94
Defining Citizenship Status.....	94
Defining Ethnic Groups.....	95
Page Used to Define Ethnic Groups.....	95
Defining Ethnic Groups.....	95
Defining Supporting Documents.....	96
Page Used to Define Supporting Documents.....	96
Defining Visas and Permits.....	97
Page Used to Define Visa and Permit Data.....	97
Setting Up Visa and Permit Data.....	97
Entering and Reviewing License Types.....	98
Page Used to Enter or Update License Types.....	98
Defining Physicians and Diagnosis Data.....	99
Setting Up for Processing Accommodations.....	99
Pages Used to Set Up for Processing Accommodations.....	99
Defining Accommodation Types.....	100
Defining Job Codes.....	101
Defining Job Code Tasks.....	102
Defining Job Locations.....	102
Reviewing Content Types and Items.....	102
Pages Used to Review Content Types and Items.....	103
Reviewing Content Types.....	103
Reviewing and Defining Content Items.....	104
Setting Up Person of Interest Types.....	105
Pages Used to Set Up Person of Interest Types.....	105
Defining and Maintaining Person of Interest Types and Relationships.....	105
Establishing Name Usages.....	106
Understanding Name Types and Usages.....	106
Page Used to Set Up Name Usages.....	109
Defining Name Usages.....	110

Establishing Name Type Defaults.....	111
Page Used to Establish Name Type Defaults.....	112
Defining Name Type Defaults.....	112
Establishing Salutations.....	112
Understanding Salutations.....	112
Pages Used to Set Up Salutations.....	113
Creating Salutations.....	113
Defining Salutation Types for Joint Communications.....	113
Establishing Address Usages.....	117
Understanding Address Usages.....	117
Page Used to Establish Address Usages.....	117
Defining or Reviewing Address Usages.....	117
Establishing Phone Usages.....	119
(CAN) Understanding Phone Usages.....	119
Page Used to Establish Phone Usage Types.....	119
Defining Phone Usage Types.....	119
Establishing Campus Locations.....	120
Page Used to Define Campus Locations.....	120
Defining Campus Addresses.....	120
Setting Up Preferences in PeopleSoft Fluid User Interface.....	121
Page Used to Set Up Preferences.....	121
Setting Up the My Preferences Tile.....	121
Establishing ID Delete Control.....	121
Establishing Search/Match Criteria.....	122
Establishing FERPA Privacy Control.....	122
Establishing 3C Deletion Policy Control.....	122
Pages Used to Establish 3C Deletion Policy Control.....	122
Setting 3C Deletion Policy Parameters.....	122
Setting 3C Deletion Policy Exceptions.....	123
Chapter 3: Setting Up ID Delete Control.....	125
Understanding ID Delete Control.....	125
Common Elements Used in Setting Up ID Delete Control.....	125
Controlling the Deletion of Individual IDs.....	126
Page Used to Control the Deletion of Individual IDs.....	126
Defining Priority Data.....	126
Controlling the Deletion of Organization IDs.....	127
Page Used to Control the Deletion of Organization IDs.....	127
Defining Priority Data.....	127
Chapter 4: Setting Up Search/Match.....	129
Understanding Search/Match.....	129
Understanding Automatic Search.....	131
Understanding Automatic Search Conditions.....	131
Setting Up Search/Match.....	132
Pages Used to Set Up Search/Match.....	132
Defining Search Rule Codes.....	134
Defining Search Parameters.....	136
Defining Search Permissions.....	138
Viewing or Adding Search/Match Result Fields.....	139
Configuring Search/Match Results.....	140
Entering Search Results Details.....	142
Defining Search Results Exceptions.....	143

Configuring Search Result Permissions.....	144
Chapter 5: Setting Up External Search/Match.....	147
Understanding External Search/Match.....	147
How to Search.....	147
Search Results.....	149
Prerequisites for Setting Up External Search/Match.....	150
Setting Up External Search/Match Functionality.....	151
Pages Used to Set Up External Search/Match Functionality.....	151
Configuring External Core Data Integration.....	152
Configuring External Search/Match Options.....	153
Configuring External Search Match Web Services (Distinct Ownership model).....	155
Chapter 6: Setting Up Affiliations.....	161
Understanding Affiliations Setup.....	161
Prerequisites for Setting Up Affiliations.....	162
Defining Affiliations.....	162
Pages Used to Define Affiliations.....	162
Creating Affiliation Codes.....	163
Setting Triggers.....	170
Setting Context Data.....	171
Defining Affiliation Status.....	172
Page Used to Define Affiliation Status.....	172
Setting Up Affiliation Status Details.....	173
Defining Affiliation Rankings.....	173
Page Used to Define Affiliation Rankings.....	174
Assigning Rankings to Affiliation Codes.....	174
Mapping Institution Departments to Affiliations.....	175
Page Used to Map Institution Departments to Affiliations.....	175
Mapping Departments to Institutions.....	175
Setting Up the Affiliations Gantt Chart.....	175
Page Used to Set Up the Affiliations Gantt Chart.....	175
Setting Up the Person Affiliations Chart View.....	175
Setting Up Affiliation Routing.....	178
Page Used to Set up Affiliation Routing.....	178
Setting Up Routings.....	179
Chapter 7: Setting Up Biographical Information.....	181
Setting Up Names, Addresses, and Phone Numbers.....	181
Setting Up Personal Attributes.....	181
Pages Used to Set Up Personal Attributes.....	181
(NZL) Setting Up Statistics New Zealand Ethnic Codes.....	182
(NZL) Mapping Statistics New Zealand Ethnic Codes to PeopleSoft Ethnic Groups.....	182
(NZL) Setting Up SDR Country of Citizenship Codes.....	183
(NZL) Mapping SDR Country of Citizenship Codes to PeopleSoft Country Codes.....	183
(NZL) Map SDR Residency Values to PeopleSoft Residency Values.....	183
(NZL) Setting Up Codes for Iwi Tribes.....	184
Defining Religious Preference Codes.....	184
Setting Up Decedent Data.....	185
Setting Up Self-Service Ethnicity Reporting.....	185
Page Used to Set Up Self-Service Ethnicity Reporting.....	185
Setting Up Self-Service Ethnicity Options.....	185
Setting Up FERPA Privacy Control.....	194
Setting Up Individual Relationships.....	194

Pages Used to Set Up Individual Relationships.....	194
Defining Reciprocal Relationships.....	194
Enabling Marital Status Verification.....	196
Setting Up Relations to the Institution.....	197
Page Used to Set Up Relations to the Institution.....	197
Defining Legacy Affiliation Types.....	197
Setting Up Emergency Contacts Data.....	198
(USA) Setting Up Work Experience Classification Codes.....	198
Pages Used to Set Up Work Experience Classification Codes.....	199
Adding or Reviewing SIC Codes.....	199
Adding SOC Codes.....	199
Chapter 8: (AUS) Setting Up and Managing USI Processes.....	201
Understanding USI.....	201
Processing USI Information as Administrator.....	201
Pages Used by Administrators to Access USI Records.....	201
Verifying USI Records.....	202
Running the Bulk USI Process.....	203
Reviewing a Bulk USI Request.....	204
Cleaning Up USI Records.....	205
Setting Up USI Submission Details.....	205
Pages Used to Set Up USI.....	205
Setting up USI AUS Information.....	206
Setting up Integration With the USI Agency Website.....	206
Chapter 9: (NZL) Setting Up for NSI Processing.....	209
Understanding NSI Processing Setup.....	209
Accessing the NSI Website.....	210
Setting Up NSI Change Processing.....	210
Enabling NSI Change Processing.....	210
Activating PeopleTools Integration Broker for NSI.....	210
Scheduling the NSI Suspense Future Program.....	210
Chapter 10: (USA) Setting Up PeopleSoft SEVIS Solution Visa Processing for J and F/M Visas.....	213
Setting Up SEVIS Visa Processing.....	213
Pages Used to Set Up SEVIS Visa Processing.....	213
Defining Your Institution.....	214
Mapping to SEVIS Country Data.....	220
Mapping to SEVIS Visa Types.....	221
Mapping to SEVIS Name Suffixes.....	222
Mapping to SEVIS Event Types.....	222
Defining SEVIS File Error Messages.....	227
Setting Up F and M Visas Processing.....	227
Pages Used to Set Up F and M Visas Processing.....	228
Setting Up SEVIS School Codes.....	229
Defining the Institution for a School Code.....	230
Setting Up SEVIS School Code Security.....	231
Setting Up U.S. Department of State Postal Codes.....	231
Setting Up Port of Entry Data.....	232
Mapping SEVIS Visa Types to Levels of Education.....	232
Setting Up SEVIS Fee Codes.....	233
Creating an I-20 Form Template.....	234
Setting Up J Visas Processing.....	235

Pages Used to Set Up J Visas Processing.....	236
Setting Up Program Sponsors.....	237
Setting Up Site of Activity Codes.....	238
Defining the Default Site of Activity.....	239
Setting Up Program Sponsor Security.....	240
Setting Up International Organization Codes.....	240
Setting Up U.S. Government Agency Codes.....	240
Setting Up Position Codes.....	241
Setting Up J Visa Termination Reasons.....	241
Setting User Defaults for Visa Processing.....	242
Page Used for Setting User Defaults Visa Processing.....	242
Setting School Code or Program Sponsor User Defaults.....	242
Chapter 11: Setting Up Service Indicators.....	243
Understanding Service Indicator Setup.....	243
Setting Up Service Impacts.....	243
Page Used to Set Up Service Impacts.....	243
Defining Service Impact Codes.....	243
Setting Up Service Indicator Codes and Reasons.....	246
Pages Used to Set Up Service Indicator Codes and Reasons.....	246
Creating Service Indicator Codes.....	246
Defining and Associating Service Indicator Reasons.....	249
Viewing Service Indicators for Third-Party Integration Data.....	253
Page Used to View Service Indicators for Third-Party Integration Data.....	253
Viewing Service Indicator Data for a Third-Party Integration.....	253
Chapter 12: Setting Up FERPA Privacy Control.....	255
Understanding FERPA Privacy Control.....	255
Making Data Available for FERPA Privacy Control.....	256
Page Used to Make Data Available for FERPA Privacy Control.....	256
Setting Data for FERPA Privacy Control.....	256
Making Publications Available for Privacy Exceptions.....	261
Understanding Publications as Privacy Control Exceptions.....	261
Pages Used to Make Publications Available for Privacy Control Exceptions.....	261
Defining Publication Categories.....	261
Chapter 13: Using FERPA Web Services.....	263
Understanding FERPA as a Service.....	263
Prerequisites for Using FERPA Web Services.....	263
Inbound and Outbound Services.....	264
Inbound FERPA Service.....	264
Outbound FERPA Service.....	266
FERPA Service Trigger Components.....	269
FERPA Service Messages.....	272
Entities.....	275
Chapter 14: Setting Up Personal Identification Data.....	279
Setting Up Citizenship, Visa, and Permit Data.....	279
Setting Up Residency Rules.....	279
Pages Used to Set Up Residency Rules.....	279
Defining Residency Rules.....	280
Defining Residency Rule Exceptions.....	280
Chapter 15: Setting Up Health Data.....	281
Setting Up Physicians.....	281
Pages Used to Define Physicians.....	281

Entering Physician Names.....	282
Setting Up Diagnosis Codes.....	282
Page Used to Define Diagnosis Codes.....	283
Setting Up Accommodations.....	283
Setting Up Immunization and Health Test Types.....	283
Pages Used to Set Up Immunization and Health Test Codes.....	283
Defining Immunization Test Codes.....	284
Defining Health Test Codes.....	284
Chapter 16: Setting Up Participation Data.....	287
Setting Up Athletic Participation.....	287
Page Used to Set Up Athletic Participation.....	287
Defining an Athletic Participation Code.....	287
Setting Up Extracurricular Activities.....	287
Page Used to Set Up Extracurricular Activities.....	288
Defining an Extracurricular Activity Code.....	288
Setting Up Honors and Awards.....	289
Page Used to Set Up Honors and Awards.....	289
Setting Up Memberships, Licenses, and Certificates.....	289
Chapter 17: Setting Up Organization Data.....	291
Defining Organization Groups and Contacts.....	291
Understanding Group Types.....	291
Pages Used to Define Groups and Contacts.....	291
Defining Organization Group Types.....	292
Defining Contact Types.....	292
Creating or Loading External Organization Codes.....	293
Understanding External Organization Codes.....	293
Page Used to Create External Organization Codes.....	293
Loading or Defining External Codes for Organization Types.....	293
Setting Up External Subject Categories and Term Sessions.....	294
Understanding External Subjects, Terms, and Courses.....	294
Pages Used to Set Up External Subject Categories and Term Sessions.....	295
Defining External Subject Categories.....	295
Defining External Term Sessions.....	296
Setting Up External Education Comments.....	297
Page Used to Define External Education Comments.....	298
Defining External Education Comments.....	298
Setting Up Organization Types.....	299
Page Used to Define the Organization Type.....	299
Defining the Organization Type.....	299
Setting Up NAICS Codes.....	301
Page Used to Define NAICS Codes.....	302
Defining NAICS Codes.....	302
Setting Up ATP Country Names and School Types.....	302
Pages Used to Set Up ATP Country Names and School Types.....	303
Mapping ATP Country Names.....	303
Mapping ATP School Types.....	304
Chapter 18: Setting Up Administrative Functions.....	305
Understanding Administrative Functions.....	305
Reviewing Administrative Functions.....	309
Page Used to Review Administrative Functions.....	309
Reviewing Administrative Function Codes.....	309

Determining Variable Data Fields.....	310
Page Used to Determine Variable Data Fields.....	310
Viewing Variable Data Fields Associated with a Function.....	310
Chapter 19: Setting Up the Population Selection Process.....	311
Understanding Population Selection.....	311
Setting Up Selection Tools.....	311
Page Used to Set Up Selection Tools.....	311
Setting Up a Selection Tool.....	311
Defining and Mapping Contexts.....	316
Pages Used to Define and Map Contexts.....	317
Defining an Application-Specific Context.....	317
Defining a Context.....	318
Mapping a Context Definition to the Population Selection Process.....	321
Mapping an Equation to a Context.....	325
Chapter 20: Using the File Parser Process.....	327
Understanding the File Parser Process.....	327
Setting Up Field Conversion Definitions.....	327
Pages Used to Set Up Field Conversion Definitions.....	328
Setting Up a Field Conversion Definition.....	328
Copying a Field Value Conversion Definition.....	330
Setting Up Context Definitions.....	330
Pages Used to Set Up Context Definitions.....	330
Setting Up a Context Definition.....	331
Viewing the Record Tree.....	338
Copying a Context Definition.....	339
Setting Up File Mapping Definitions.....	339
Pages Used to Set Up File Mapping Definitions.....	339
Creating a File Definition.....	340
Define a File Layout.....	343
Mapping the File and Converting the Data.....	348
Previewing the Record Tree.....	356
Previewing the Converted Data.....	358
Running the File Parser Process.....	359
Page Used to Run the File Parser Process.....	359
Running the File Parser Process.....	359
Mapping the File Parser Process for Population Selection.....	360
Page Used to Map File Parser for Population Selection.....	361
Mapping the File Parser Process for Population Selection.....	361
Cross-references to Application-specific File Parser Content.....	369
Financial Aid.....	369
Recruiting and Admissions.....	370
Student Records.....	370
Campus Community.....	370
Creating Calculated Mapping Application Class Objects.....	370
Creating an Application Package.....	370
Creating an Application Class.....	371
Accessing Staged Field Values.....	371
Accessing File Field Values.....	373
Commonly Used Calculated Mapping Application Class Objects.....	377
External Organization ID.....	377
Activity Description.....	379

Degree Description.....	380
Subject Description.....	382
Write Transaction Map.....	384
Remove Special Characters for Last Name Search.....	385
Remove Special Characters for First Name Search.....	386
Troubleshooting Tips.....	387
Chapter 21: Using Constituent Web Services.....	393
Understanding Constituent Web Services.....	393
Prerequisites for Using Constituent Web Services.....	395
Outbound and Inbound Services.....	395
Outbound Services.....	396
Inbound Services.....	398
Configuring Constituent Event Triggers.....	400
Configuring Notification Handlers.....	401
Configuring Integration with External Systems.....	402
Configuring REST POST Constituent Staging Service.....	402
Testing the REST POST Constituent Staging Service.....	404
Chapter 22: Setting Up Student Groups.....	409
Understanding Student Groups.....	409
Setting Up a Student Group.....	409
Page Used to Set Up a Student Group.....	409
Setting Up a Student Group.....	409
Setting Up Student Group Security.....	410
Page Used to Set Up Student Group Security.....	410
Setting Up a User ID's Student Group Security.....	410
Viewing a Student Group by Group.....	411
Page Used to View a Student Group by Group.....	411
Viewing Student Groups by Group.....	411
Manually Assigning a Student to Student Groups.....	411
Page Used to Manually Assign a Student to Student Groups.....	412
Assigning a Student to a Student Group.....	412
Assigning a Group of Students to a Student Group.....	413
Page Used to Assign a Group of Students to a Student Group.....	413
Running the Student Group Process.....	413
Viewing Student Groups by Student.....	416
Page Used to View a Student Group by Student.....	416
Viewing a Student Group by Student.....	416
Chapter 23: Setting Up Communications.....	419
Understanding Communications Setup.....	419
Prerequisites for Setting Up Communications.....	422
Defining Letter Codes.....	422
Page Used to Define Letter Codes.....	423
Setting Up a Letter Code.....	423
Defining Communication Contexts and Categories.....	430
Pages Used to Define Communication Contexts and Categories.....	431
Defining a Communication Context.....	431
Defining a Communication Category.....	433
Defining 3C Groups.....	434
Pages Used to Define 3C Groups.....	434
Defining a 3C Update/Inquiry Group.....	435
Defining a Communication 3C Group.....	436

Defining Communication Speed Keys.....	436
Page Used to Define Communication Speed Keys.....	437
Defining a Communication Speed Key.....	437
Setting Up the Communication Generation Process.....	439
Understanding the Communication Generation Process Setup.....	440
Pages Used to Set Up the Communication Generation Process.....	440
Creating a Template.....	443
Creating Valid PeopleSoft Queries and Application Classes.....	443
Creating a Data Source File.....	447
Creating a Report Definition.....	451
Defining Organization Communication Recipient Usages.....	452
Chapter 24: Setting Up Comments.....	455
Understanding Comment Setup.....	455
Prerequisites for Setting Up Comments.....	455
Common Elements Used to Set Up Comments.....	455
Setting Up Comment Categories.....	455
Page Used to Set Up Comments.....	456
Defining Comment Category Codes.....	456
Defining 3C Update/Inquiry Groups.....	457
Page Used to Define 3C Update/Inquiry Groups.....	457
Defining a 3C Update/Inquiry Group.....	457
Setting Up Comment 3C Groups.....	458
Page Used to Set Up Comment 3C Groups.....	458
Chapter 25: Setting Up Checklists.....	459
Understanding Checklist Setup.....	459
Prerequisites for Setting Up Checklists.....	461
Setting Up Checklist Items.....	461
Page Used to Set Up Checklist Items.....	461
Defining Checklist Items.....	461
Enabling File Uploads for Applications in Fluid User Interface.....	470
Associating Checklist Items with Administrative Functions.....	471
Page Used to Associate Checklist Items with Administrative Functions.....	471
Associating Items with a Function.....	471
Setting Up Checklist Tracking Groups.....	473
Page Used to Set Up Tracking Groups.....	473
Creating a Tracking Group.....	473
Setting Up Checklist Templates.....	474
Page Used to Set Up Checklist Templates.....	474
Creating a Checklist Template.....	474
Defining 3C Update/Inquiry Groups for Checklists.....	479
Setting Up Checklist 3C Groups.....	479
Page Used to Set Up Checklist 3C Groups.....	479
Creating a Checklist 3C Group.....	479
Chapter 26: Setting Up To Do Lists.....	481
Setting Up To Do Lists Using PeopleSoft Fluid User Interface.....	481
Page Used to Set Up To Do Lists.....	481
Configuring the To Do List Page.....	481
Chapter 27: Setting Up Committee Templates.....	483
Understanding Committee Templates.....	483
Setting Up Committee Types and Roles.....	483
Page Used to Set Up Types and Roles.....	483

Defining a Committee Type and Assigning Member Roles.....	484
Chapter 28: Setting Up Evaluation Management.....	487
Understanding Evaluation Management.....	487
Understanding Evaluation Management Setup.....	488
Defining Evaluation Categories.....	488
Page Used to Define Evaluation Categories.....	489
Setting Up Evaluation Categories.....	489
Copying Evaluation Setup.....	490
Page Used to Copy Evaluation Setup.....	490
Copy Setup Scenarios.....	490
Defining Evaluation Statuses.....	495
Page Used to Define Evaluation Statuses.....	495
Setting Up Evaluation Status.....	495
Defining Recommendations.....	495
Page Used to Define Recommendations.....	496
Setting Up Evaluation Recommendations.....	496
Defining Rating Components.....	496
Page Used to Define Rating Components.....	496
Setting Up Rating Components.....	496
Defining Committees for Evaluation Management.....	497
Defining Rating Schemes.....	498
Page Used to Define Rating Schemes.....	498
Setting Up Evaluation Rating Schemes.....	498
Defining Evaluation Committees.....	501
Page Used to Define Committees.....	502
Linking Existing Committees to Evaluation Committees.....	502
Defining Links for Self-Service Pages.....	502
Page Used to Define Links.....	503
Setting Up Links.....	503
Defining Committee Schemes.....	504
Pages Used to Define Committee Schemes.....	504
Aligning Committees With Schemes.....	505
Setting Up Self-Service Options.....	508
Defining Individual Evaluator Schemes.....	510
Pages Used to Define Individual Evaluator Schemes.....	510
Assigning Individuals to Evaluator Schemes.....	510
Setting Up Self-Service Options.....	512
Setting Up Evaluation Codes.....	514
Page Used to Set Up Evaluation Codes.....	514
Defining Evaluation Code Details.....	515
Setting Up Evaluation Schemes.....	526
Setting Up Evaluation Statuses.....	533
Setting Up Self-Service Options.....	535
Setting Up Evaluation Management Security.....	536
Page Used to Set Up Evaluation Management Security.....	536
Defining Security Settings for Evaluations.....	536
Setting Up and Using Rules for the Evaluation Management System.....	536
Understanding the Rules Engine and the Entity Registry.....	537
Setting Up and Using Rule Categories for the Evaluation Management System.....	539
Using Data Sets.....	543
Setting Up and Using Rule Groups.....	544

Using Sample Rules.....	551
Evaluation Management System/Rules Engine Integration: Rating Component Calculation and Rating Scheme Calculation Rule Groups.....	560
Evaluation Management System/Rules Engine Integration: Early Result Rule Group.....	567
Modifying and Using System Data Rules.....	573
Chapter 29: Setting Up Campus Event Planning.....	575
Understanding Campus Events.....	575
Defining Campus Events.....	575
Pages Used to Define Campus Events.....	576
Defining Event Types.....	576
Defining Event Resource Codes.....	576
Defining Event Staff Codes.....	576
Creating an Event Template.....	577
Pages Used to Create an Event Template.....	577
Creating an Event Meeting Template.....	577
Assigning the Meeting Resources.....	578
Assigning the Type of Meeting Staff.....	579
Chapter 30: Managing System IDs.....	581
Understanding ID Management.....	581
Creating System IDs.....	582
Deleting Individual IDs.....	582
Prerequisites.....	582
Pages Used to Delete Individual IDs.....	582
Selecting Individual IDs to Delete.....	583
Changing Individual IDs.....	583
Page Used to Change Individual IDs.....	584
Changing an Individual ID.....	584
Reviewing Changed or Deleted Individual ID Records.....	585
Deleting Organization IDs.....	586
Understanding Organization ID Deletion.....	586
Page Used to Delete Organization IDs.....	586
Selecting the Organization ID to Delete.....	586
Changing an External Organization ID.....	586
Page Used to Change Organization IDs.....	587
Selecting the Organization ID to Change.....	587
Updating ID Types.....	587
Understanding ID Type Updates.....	587
Page Used to Update ID Types.....	588
Running the Update ID Type Process.....	588
Chapter 31: Setting Up List of Values.....	589
Understanding Get List of Values Web Service Operation.....	589
Setting Up List of Values.....	595
Page Used to Set Up List of Values.....	595
Setting Up List of Values.....	595
Chapter 32: Setting Up Entity Registry.....	609
Understanding Entity Registry.....	609
Configuring Entity Types.....	610
Pages Used to Configure Entity Types.....	610
Setting Up Entity Types.....	611
Viewing Entities for an Entity Type.....	615
Setting Up Entity Registry.....	616

Pages Used to Set Up Entity Registry.....	616
Configuring the Entity Registry.....	617
Setting Up Entity Properties.....	628
Setting Up Entity Property Details.....	636
Creating Entity Views.....	638
Generating the Entity Schema.....	642
Generating the Entity Code.....	643
Viewing the Entity Hierarchy.....	645
Setting Up Entity Profiles.....	647
Page Used to Set Up Entity Profiles.....	647
Configuring Entity Profiles.....	647
Synchronizing Entity Properties.....	651
Page Used to Synchronize Entity Properties.....	651
Running the Entity Property Sync Process.....	651
Executing Unit Tests for Entities.....	655
Pages Used to Execute Unit Tests for Entities.....	656
Creating an Entity Unit Test.....	656
Running Entity Unit Test Cases.....	661
Creating a New Entity.....	665
Creating or Extending Stage Records.....	666
Creating an Entity Application Class.....	667
Creating an Entity.....	670
Generating XSD Schemas.....	675
Setting Up or Verifying the Campus Solutions SOA Framework.....	678
Setting Up Logging.....	679
Entity Application Class Reference.....	679
interface SCC_COMMON:ENTITY:IEntity.....	679
abstract class SCC_COMMON:ENTITY:AbstractEntity.....	689
class SCC_COMMON:Audit.....	713
class SCC_COMMON_UTIL:BitArray.....	714
class SCC_COMMON:ENTITY:BasicEntity.....	714
class SCC_COMMON:ENTITY:StagedEntity.....	716
abstract class SCC_COMMON:ENTITY:StagedHREntity.....	720
class SCC_COMMON:ENTITY:WorkEntity.....	725
class SCC_COMMON:ENTITY:ChildEntity.....	727
class SCC_COMMON:ENTITY:EntityRegFactory.....	735
interface SCC_COMMON:ENTITY:CODEGEN:EntityGeneratorInterface.....	735
interface SCC_COMMON:ENTITY:PROPERTY:PropertySyncInterface.....	737
abstract class SCC_COMMON:ENTITY:LOG:MessageLogBase.....	739
class SCC_COMMON:ENTITY:LOG:MessageEntry.....	742
class SCC_COMMON:ENTITY:LOG:MEProp.....	744
Chapter 33: Using Entity Registry Based Constituent Web Services.....	747
Using Entity Registry Based Constituent Web Service Operations.....	747
Using Get Constituent Web Services.....	747
Using the SOAP Get Constituent Web Service Operation.....	748
Describing the SOAP Input Message: SCC_GETCONST_REQ.....	749
Describing the SOAP Output Message: SCC_GETCONST_RESP.....	749
Describing the SOAP Output Fault Message: SCC_FAULT_RESP.....	754
Using the REST Get Constituent Web Service Operation.....	754
Describing the REST Input Message: SCC_GETCONST_RE_R.....	755
Describing the REST Output Message: SCC_GETCONST_RESP.....	755

Describing the REST Output Fault Message: SCC_FAULT_RESP_R.....	755
Using Submit Constituent Web Services.....	755
Using the SOAP Submit Constituent Web Service Operation.....	755
Describing the SOAP Input Message: SCC_SUBMITCONST_REQ.....	757
Describing the SOAP Output Message: SCC_SUBMITCONST_RESP.....	760
Describing the SOAP Output Fault Message: SCC_FAULT_RESP.....	764
Using the REST Submit Constituent Web Service Operation.....	764
Describing the REST Input Message: SCC_SUBMITCONST_REQ.....	765
Describing the REST Output Message: SCC_SUBMITCONST_RESP.....	765
Describing the REST Output Fault Message: SCC_FAULT_RESP_R.....	765
Using Get Photo Web Services.....	765
Using the SOAP Get Photo Web Service Operation.....	765
Describing the SOAP Input Message: SCC_GETPHOTO_REQ.....	766
Describing the SOAP Output Message: SCC_GETPHOTO_RESP.....	767
Describing the SOAP Output Fault Message: SCC_FAULT_RESP.....	768
Using the REST Get Photo Web Service Operation.....	768
Describing the REST Input Message: SCC_GETPHOTO_REQ_R.....	769
Describing the REST Output Message: SCC_GETPHOTO_RESP.....	769
Describing the REST Output Fault Message: SCC_FAULT_RESP_R.....	769
Using Get Checklist Web Services.....	769
Using the SOAP Get Checklist Web Service Operation.....	769
Describing the SOAP Input Message: SCC_GET_CHKLST_REQ.....	770
Describing the SOAP Output Message: SCC_GET_CHKLST_RESP.....	771
Describing the SOAP Output Fault Message: SCC_FAULT_RESP.....	777
Using the REST Get Checklist Web Service Operation.....	777
Describing the REST Input Message: SCC_GET_CHECKLIST_REQ_R.....	777
Describing the REST Output Message: SCC_GET_CHKLST_RESP.....	778
Describing the REST Output Fault Message: SCC_FAULT_RESP_R.v1.....	778
Using Get Service Indicators Web Services.....	778
Using the SOAP Get Service Indicators Web Service Operation.....	778
Describing the SOAP Input Message: SCC_GET_SERVICE_IND_REQ.....	779
Describing the SOAP Output Message: SCC_GET_SERVICE_IND_RESP.....	779
Describing the SOAP Output Fault Message: SCC_FAULT_RESP.....	785
Using the REST Get Service Indicators Web Service Operation.....	785
Describing the REST Input Message: SCC_GET_SERVICE_IND_REQ_R.....	786
Describing the REST Output Message: SCC_GET_SERVICE_IND_RESP.....	786
Describing the REST Output Fault Message: SCC_FAULT_RESP_R.....	786
Using Get User Preferences Web Services.....	786
Using the SOAP Get User Preferences Web Service Operation.....	786
Describing the SOAP Input Message: SCC_GET_USERPREF_REQ.....	787
Describing the SOAP Output Message: SCC_GET_USERPREF_RESP.....	788
Describing the SOAP Output Fault Message: SCC_FAULT_RESP.....	791
Using the REST Get User Preferences Web Service Operation.....	791
Describing the REST Input Message: SCC_GET_USERPREF_REQ_R.....	792
Describing the REST Output Message: SCC_GET_USERPREF_RESP.....	792
Describing the REST Output Fault Message: SCC_GET_USERPREF_FAULT.....	792
Using Submit User Preferences Web Services.....	792
Using the SOAP Submit User Preferences Web Service Operation.....	792
Describing the SOAP Input Message: SCC_SUBMIT_USERPREF_REQ.....	793
Describing the SOAP Output Message: SCC_SUBMIT_USERPREF_RESP.....	797
Describing the SOAP Output Fault Message: SCC_FAULT_RESP.....	797

Using the REST Submit User Preferences Web Service Operation.....	797
Describing the REST Input Message: SCC_SUBMIT_USERPREF_REQ.....	798
Describing the REST Output Message: SCC_SUBMIT_USERPREF_RESP.....	798
Describing the REST Output Fault Message: SCC_SUBMIT_USERPREF_FAULT.....	798
Constituent Service Messages and Entities.....	798
Constituent Service Messages.....	798
Constituent Entities.....	803
Chapter 34: Working with the Notifications Framework.....	809
Understanding the Notifications Framework.....	809
Technical Overview.....	810
Setting Up and Consuming the Notifications Framework.....	813
Pages Used to Set Up the Notifications Framework.....	814
Configuring the Generic Templates for Notifications Framework.....	815
Configuring Notification Setup for the Generic Templates.....	819
Setting Up a Notification Consumer.....	825
Triggering the Notifications Framework.....	827
Setting Up SMS Notifications.....	830
Setting Up Integration Broker for the SMS Channel.....	832
Setting Up Push Notifications.....	836
Configuring Integration Broker to Use Socket Connector for Push Channel Delivered Services.....	838
Installing SSL Certificates and Configuring Platform Specific Server Keys.....	839
Activating All Integration Broker Objects Delivered for Push Channel.....	840
Scheduling the APNS Feedback Job.....	843
Setting Up and Using the Events Framework.....	843
Page Used to Set Up the Events Framework.....	844
Configuring an Event for the Events Framework.....	844
Triggering the Events Framework.....	845
Sending Batch Notifications and Events.....	847
Page Used to Send Batch Notifications and Events.....	848
Managing Batch Notifications and Events.....	848
Using the Worklist Batch Process.....	855
Managing Notification Preferences.....	857
Page Used to Manage Notification Preferences.....	857
Setting and Updating Notification Preferences.....	857
Setting Up Security for Admin Notifications.....	858
Pages Used to Set Up Security for Admin Notifications.....	858
Setting Up Notification Consumer Admin Access.....	859
Setting Up Notification Consumer Security.....	860
Using Admin Notifications.....	861
Page Used to Review and Manage Notifications.....	861
Reviewing and Managing Notifications.....	862
Using Online Notifications.....	864
Implementing Online Notifications.....	865
NFK Web Services GET and SEND (SCE).....	868
GET Request.....	869
SEND Request.....	871
NFK Web Services for Push Notifications.....	871
NFK Web Services for Events.....	872
SCC_NTF_GET_EVENTS_R_POST.....	873
SCC_NTF_UPDATE_EVENTS_R_POST.....	874

Testing the Notifications Framework.....	875
Page Used to Test the Notifications Framework.....	875
Purging Notifications Framework Records.....	877
Archiving Events.....	880
Chapter 35: Setting Up and Using Delegated Access Framework.....	885
Understanding Delegated Access.....	885
Delegation Terminology.....	885
Delegated Access Process.....	886
Notifications Framework and Delegated Access.....	889
New User Registration Framework and Delegated Access.....	902
New User Registration Context.....	902
CTM and Delegated Access.....	904
Associating a CTM Transaction Code with Delegated Access.....	905
Processing New User Registration and Delegated Access Transactions.....	906
Entity Registry and Delegated Access.....	907
Contact and Transaction Statuses.....	908
Revoking Proxy Access.....	910
Delegated Access Validation.....	913
Using Proxy Access Validation.....	914
Understanding Proxy Access Validation.....	914
Page Used to Validate Proxy Access.....	917
Validating Proxy Access in Real Time.....	917
Validating Proxy Access in Batch.....	917
Configuring Delegation Transactions.....	920
Pages Used to Configure Delegation Transactions.....	920
Configuring Delegation Transactions.....	920
Reviewing Delivered Delegation Transactions.....	928
Using the Review Shared Information Pages.....	929
Pages Used to Access the Review Shared Information Pages.....	930
Using the Review Shared Information – Summary Page.....	930
Using the Review Shared Information – Details Page.....	932
Developer Reference for Setting Up Delegated Access.....	934
Step 1: Setting Up Counter for Proxy ID.....	935
Step 2: Defining the Delegator’s Terms and Conditions Message Catalog.....	935
Step 3: Defining the Proxy’s Terms and Conditions Message Catalog.....	935
(Optional) Step 4: Setting Up the CTM Transaction for Delegated Access.....	935
Step 5: Setting Up Components for Delegated Access.....	938
Step 6: Setting Up Permission Lists and Roles for the Delegated Access Components.....	942
Step 7: Setting Up Delegation Transactions.....	944
Step 8: Modifying the Proxy Terms and Conditions Page to Include Proper Constituent Fields.....	945
Step 9: Setting Up the URL to Access the New User Registration Login Page.....	946
Step 10: Setting Up New User Registration Framework or Required Proxy Security.....	947
Step 11: Modifying the Delegated Access Notification Templates.....	948
Step 12: Activating the SCC_DA Web Service.....	948
Step 13: Verifying the Existence of the Request Handler.....	950
Troubleshooting Delegated Access.....	952
Error message 158,963.....	952
Error message 158,536.....	953
Error message 158,974.....	954
Chapter 36: Setting Up and Using New User Registration Framework.....	955

Understanding New User Registration.....	955
New User Registration Terminology.....	957
Constituent Transaction Management and New User Registration.....	958
Notifications Framework and New User Registration.....	959
New User Registration Context.....	960
New User Registration Web Service Operations.....	961
Create User Account (SCC_USERREG_CREATEACCT) Service Operation.....	962
Authenticate User (SCC_USERREG_AUTHENTICATE) Service Operation.....	966
Retrieve User ID (SCC_USERREG_GET_USERID) Service Operation.....	968
Retrieve Password Hint (SCC_USERREG_GET_PSWD_HINT) Service Operation.....	969
Reset Password (SCC_USERREG_GET_PASSWORD) Service Operation.....	969
Check Authorization (SCC_CHECK_AUTH) Service Operation.....	970
Using the New User Registration Sample User Interfaces.....	972
Pages Used to Access New User Registration Sample User Interfaces.....	973
Using the New User Registration Login Sample Page.....	973
Using the New User Registration Tester Page.....	976
Using the Forgot User ID Utility.....	982
Using the Forgot Password Utility.....	983
Setting Up CTM for New User Registration.....	984
Defining Installation Options for New User Registration.....	985
Setting Up New User Registration Encryption Profiles.....	992
Generate a Key.....	992
Load the Encryption Library.....	992
Define Algorithm Chains.....	993
Define the Algorithm Keyset.....	994
Define the Encryption Profile.....	995
(Test) Encrypt a String.....	996
(Test) Decrypt the Encrypted String.....	997
Setting Up New User Registration Context.....	998
Provisioning Access Through the Gatekeeper.....	1005
Deploying New User Registration.....	1006
Developer Reference to Deploy New User Registration.....	1010
Step 1: Initial Setup for New User Registration.....	1010
Step 2: Validating the CTM Transaction Delivered for New User Registration.....	1016
(Optional) Step 3: Defining New User Registration Contexts.....	1016
Step 4: Designing Your Registration or Login page.....	1017
Step 5: Setting Up a Kiosk.....	1017
Step 6: Ensuring that the New User Registration Web Services are Running.....	1021
Step 7: Creating a URL to Access the New User Registration Login page.....	1022
Step 8: Provisioning the Gatekeeper Permission List to all of Your Users.....	1022
Step 9: Configuring the Forgot User ID Utility.....	1024
Step 10: Configuring the Forgot Password Utility.....	1025
Troubleshooting New User Registration.....	1027
Chapter 37: Working with the Rules Engine.....	1029
Understanding the Rules Engine.....	1029
Rules Engine Components.....	1029
High Level Description of the Rules Engine.....	1030
Rules Engine Manager and Entity Registry.....	1030
Additional Rules Engine Features.....	1036
Setting Up the Rules Engine.....	1038
Pages Used to Setup the Rules Engine.....	1038

Setting Up Rules Engine Install Options.....	1040
Defining Rule Category Security.....	1042
Defining Color Codes for Rules Engine Manager Elements.....	1047
Defining Rules Engine Statements.....	1049
Define Rules Version Reason Codes.....	1051
Setting Up Rules Engine Variables.....	1053
Defining Lists of Values for Rules Engine Variables.....	1061
Constructing Rules.....	1072
Pages Used for Constructing Rules.....	1073
Using Rules Engine Search.....	1077
Using Rule Groups Search.....	1081
Creating Functional Rules.....	1084
Adding Variables to a Rule.....	1094
Adding Criteria to a Rule.....	1099
Defining Rule Groups.....	1106
Defining Rule Triggers.....	1113
Using Statements for Evaluation and Calculation in a Rule.....	1115
Pages for Using Statements for Evaluation and Calculation in a Rule.....	1115
Understanding Statements for Evaluation and Calculation in a Rule.....	1116
Understanding Common Statement Attributes.....	1117
Understanding Statement-Specific Attributes.....	1119
Activating and Moving Statements within a Rule.....	1135
Applying Rule Concepts and Adding Statements to a Rule.....	1136
Understanding Contextual Referencing.....	1142
Building and Testing Rules.....	1146
Pages for Building and Testing Rules.....	1146
Building Rules.....	1147
Testing Rules.....	1148
Creating a New Version of a Rule.....	1151
Viewing Rule Cross References.....	1152
Running Rules in Batch.....	1153
Page Used for Running Rules in Batch.....	1153
Running Rules in Batch.....	1153
Integrating User Interfaces with the Rules Engine.....	1155
Building and Testing a Functional Rule.....	1156
Create a Trigger to Call the Functional Rule.....	1163
Generate Boilerplate Code.....	1168
Attach Generated Code to the Component Event.....	1174
Library of System-Delivered Rules Engine Objects.....	1177
Lists of Values.....	1177
System Variables.....	1178
Data Sets.....	1178
System Delivered Categories.....	1180
Entity Profiles.....	1184
Entities.....	1185
Rule Groups.....	1185
System Test Category Functions.....	1187
AIR Category Functions.....	1190
APT Category Functions.....	1191
APT Category Function Rules.....	1192
Activity Management Calculation Category Rules.....	1192

Date and Time Category Functions.....	1195
Debug Category Functions.....	1197
Entity Category Functions.....	1197
Math Functions.....	1198
String Category Functions.....	1202
Number Category Functions.....	1203
Student Records Generic Category Functions.....	1204
Create Text Message Category Functions.....	1205
Evaluation Management System (EMS) Category Rules.....	1209
Research Self Service Task Category Rule.....	1210
Service Request Functions Category Rules.....	1211
Service Requests Category Rule.....	1211
Research Functions Category Rules.....	1212
Research Candidates Category Rules.....	1212
Notification Framework Category Rules.....	1213
Chapter 38: Setting Up and Using the Generic Service Tester.....	1229
Understanding the Generic Service Tester.....	1229
Setting Up the Service Tester.....	1229
Pages Used to Set Up the Service Tester.....	1229
Configuring the Service Tester.....	1230
Copying a Service Tester Configuration.....	1231
Defining Input Parameters.....	1231
Testing Web Services.....	1232
Page Used to Test a Web Service.....	1232
Using the Generic Service Tester to Test a Web Service.....	1232
Chapter 39: Working with Common Attribute Framework.....	1237
Understanding Common Attribute Framework.....	1237
Using Application Designer to Configure a Record.....	1238
Viewing the Common Attribute Type Details.....	1243
Page Used to View the Common Attribute Type Details.....	1243
Viewing the Common Attribute Type Details.....	1243
Defining a Common Attribute.....	1244
Pages Used to Define a Common Attribute.....	1244
Creating a Common Attribute.....	1244
Defining a List of Values for a Common Attribute.....	1250
Associating a Common Attribute to a Record.....	1255
Pages Used to Associate a Common Attribute to a Record.....	1256
Associating a Common Attribute to a Record.....	1256
Setting Up Secondary Page Options.....	1260
Writing Custom Logic for Validation and Formatting.....	1263
Understanding the Common Attribute API.....	1265
Using and Creating an Attribute Filter Class.....	1266
Creating an Attribute Filter Class.....	1266
Common Attribute Framework Application Class Reference.....	1267
Attribute Manager.....	1267
Class Attribute.....	1272
Adding Common Attributes to Effective Dated Tables.....	1279
Chapter 40: Using the Shopping Cart Framework.....	1283
Understanding the Shopping Cart Framework.....	1283
Assessing Staff Skills.....	1284
Shopping Cart Service Operations.....	1284

SCC_SC_ADDITEM.....	1285
SCC_SC_CLEARCART.....	1285
SCC_SC_GETCART.....	1285
SCC_SC_GETITEM.....	1285
SCC_SC_REMOVEITEM.....	1286
SCC_SC_SAVECART.....	1286
SCC_SC_VALIDATE.....	1286
SCC_SC_CHECKOUT.....	1287
Shopping Cart Framework APIs.....	1287
Defining a Shopping Cart.....	1291
Creating Application Classes.....	1291
Setting Up Entity Registry.....	1293
Generating Code for Application Classes.....	1296
Configuring Shopping Cart.....	1297
Generating a Common XSD for the Shopping Carts.....	1299
Chapter 41: Working with Student Activity Guides.....	1303
Understanding Student Activity Guides.....	1303
Scenarios.....	1304
Understanding How Students Access Tasks in Classic Self Service.....	1305
Student Task WorkCenter.....	1307
Understanding How Students Access Tasks in Fluid Self Service.....	1308
Setting Up Activity Guide Templates.....	1308
Registration Category.....	1309
Fluid Registration Template.....	1311
Program Registration Template.....	1312
Emergency Contacts Verification Template.....	1319
Financial Agreement Template.....	1319
Configuring Tasks.....	1320
Pages Used to Configure Tasks.....	1321
Defining Template Properties.....	1321
Defining Launch Page Properties.....	1325
Defining Agreement Pages.....	1333
Defining Agreement Page Properties.....	1337
Defining Complete Page Properties.....	1338
Managing Tasks.....	1339
Pages Used to Manage Tasks.....	1339
Task Management WorkCenter.....	1340
Assigning Tasks to Students in Batch.....	1341
Managing Tasks Using the Task List Page.....	1346
Managing Instances Using the PeopleTools Components.....	1348
Viewing or Updating a Student Agreement.....	1348
Viewing Task Activity.....	1351
Using Batch Notifications Process for Sending Reminders.....	1353
Updating Tasks in Batch.....	1355
Deleting Tasks in Batch.....	1357
Chapter 42: Searching for Records and Using Search/Match.....	1359
Understanding the Difference Between Search Box Search and Search/Match.....	1359
Understanding Search Box Searches.....	1359
Using Search/Match.....	1361
Prerequisites.....	1361
Pages Used for Search/Match.....	1362

Selecting Criteria for a Search.....	1364
Viewing Search Results.....	1368
Determining Relations with an Institution.....	1372
Chapter 43: Working with Constituent Transaction Management.....	1373
Understanding CTM.....	1373
Using Staging Tables.....	1375
Constituent Staging Records.....	1376
Transaction Staging Records.....	1381
Using Self-Service and Administrator Modes for Online CTM Transactions.....	1382
New User Registration and CTM.....	1383
Integrating New User Registration with a CTM Online Transaction.....	1383
Entity Registry and CTM.....	1384
External Search/Match and CTM.....	1388
List of Values Framework and CTM.....	1389
Setting Up CTM.....	1389
Pages Used to Set Up CTM.....	1389
Setting Up Counter.....	1390
Setting Up a Transaction.....	1392
Defining the Search/Match Criteria.....	1403
File Parser and CTM.....	1406
Defining Data Update Rules.....	1409
Setting Up Affiliation Overrides for a Data Update Rule.....	1417
Setting Up CTM Transaction Security.....	1418
Processing Staged CTM Transactions.....	1419
Pages Used to Process Staged CTM Transactions.....	1420
Reviewing Constituent Information.....	1423
Reviewing Constituent Error Messages.....	1428
Constituent Statuses.....	1429
Transaction Statuses.....	1432
Running Transaction Management Process.....	1434
Specifying Search/Match Parameters for Batch Processing.....	1438
Purging Constituent and Transaction Records.....	1440
Understanding the Transaction Purge Process.....	1440
Locating the Transaction Purge Process Component.....	1441
Defining Transaction Purge Process Criteria.....	1441
Viewing the Purge Log Table.....	1445
Developer Reference for Creating a New CTM Consumer.....	1446
Step 1: Creating or Extending Staging Tables.....	1448
Step 2: Creating an Entity Application Class.....	1451
Step 3: Creating Entities.....	1453
Step 4: Creating or Maintaining Web Services.....	1453
(Optional) Step 5: Creating a Transaction Staging Component.....	1455
Step 6: Setting Up Data Update Rules.....	1458
Step 7: Setting Up a Transaction.....	1458
(Only for online transactions) Step 8: Creating a User Interface.....	1460
(Optional—only for online transactions) Step 9: Setting Up List of Values.....	1462
(Optional—for online transactions only) Step 10: Setting Up New User Registration.....	1462
(Optional—only for online transactions) Step 11: Creating a Setup Component for a CTM Consumer.....	1462
(Only for offline or batch transactions) Step 12: Setting Up File Parser.....	1464
(Optional) Step 13: Setting Up an Entity Profile for an Online Transaction.....	1464

Chapter 44: Using External Search/Match.....	1469
Understanding Using External Search Match.....	1469
Selecting Criteria for an Integrated Search.....	1469
Page Used to Select Criteria for an Integrated Search.....	1470
Entering Search Criteria.....	1471
Viewing Integrated Search Results.....	1472
Pages Used to View Integrated Search Results.....	1472
Viewing Search Results.....	1473
Viewing Biographical Details.....	1477
View Regional Details.....	1480
Conducting an Automatic Search.....	1480
Understanding External Search/Match Web Services.....	1480
Match Service.....	1481
Fetch Request and Fetch Response.....	1481
Chapter 45: Adding a Person to Your Campus Solutions Database.....	1483
Understanding System ID Assignment.....	1483
Adding an Individual to Your Database.....	1483
Adding or Updating Biographical Details Data.....	1486
Prerequisites.....	1487
Pages Used to Add or Update Biographical Details Data.....	1487
Entering Biographical Details.....	1488
Entering Regional Specific Data.....	1492
Entering Personal Information.....	1505
Chapter 46: Assigning and Managing Affiliations.....	1507
Understanding Affiliations.....	1507
Adding and Updating Affiliations.....	1508
Pages Used to Add and Update Affiliations.....	1508
Assigning and Reviewing Affiliations.....	1508
Viewing Affiliation Details.....	1509
Viewing Context Fields.....	1510
Processing Affiliations in Batch.....	1511
Page Used to Process Affiliations in Batch.....	1511
Running the Affiliations Batch Process.....	1511
Deleting Affiliations.....	1514
Understanding Affiliation Delete Functionality.....	1514
Pages Used to Delete Affiliations.....	1514
Selecting and Deleting Affiliation Codes.....	1514
Deleting Affiliations Associated With a Person.....	1516
Reviewing Affiliations.....	1516
Pages Used to Review Affiliations.....	1517
Reviewing Affiliation Data in a Tabular View.....	1517
Reviewing Affiliation Data in a Hierarchical View.....	1518
Reviewing Affiliation Data in a Chart View.....	1518
Reviewing Affiliation Data Throughout the System.....	1519
Viewing Affiliation Codes.....	1520
Page Used to View Affiliation Codes.....	1520
Reviewing Affiliation Code Details.....	1520
Viewing Affiliation Exceptions.....	1521
Page Used to View Affiliation Exceptions.....	1521
Viewing and Purging Affiliation Exception Messages.....	1521
Chapter 47: Managing Biographical Information.....	1525

Understanding Biographical Information.....	1525
Prerequisites for Managing Biographical Information.....	1526
Managing Names Data.....	1527
Pages Used to Manage Names Data.....	1527
Entering Name Types for an Individual.....	1528
Adding Long Names.....	1530
Viewing Name History.....	1530
(NLD) Entering the Name to Report for GBA.....	1530
Managing Addresses and Phone Data.....	1531
Understanding Address Management.....	1531
Prerequisites.....	1532
Pages Used to Manage Addresses.....	1532
Entering Addresses for an Individual.....	1534
Linking Addresses.....	1538
Entering Electronic Address Data.....	1539
Entering Seasonal Addresses.....	1540
Processing Seasonal Addresses.....	1541
Updating Linked Addresses.....	1541
Searching for Addresses.....	1542
Entering Phone Data.....	1543
Managing Personal Attributes Information.....	1543
Understanding the Personal Attribute Deceased Label.....	1544
Prerequisites.....	1544
Pages Used to Manage Personal Attributes Information.....	1545
Entering Ethnicity Information.....	1547
Processing Ethnicity Information Updates.....	1549
Entering Languages Information.....	1550
Entering Communication Preferences.....	1551
Entering Notification Preferences.....	1552
Entering Religious Preferences.....	1552
Entering Date of Death and Other Decedent Data.....	1553
(AUS) Entering Student Data.....	1553
Managing Relationships Data.....	1556
Prerequisites.....	1556
Pages Used to Enter Relationships Data.....	1557
Relating One Individual to Another.....	1559
Specifying Communications for the Communication Recipient Relationship.....	1562
Creating Joint Communications Relationships.....	1563
Entering Relationship Addresses.....	1566
Entering Relationship Detail Data.....	1571
Viewing a List of Relationships.....	1573
Identifying an Individual's Relationship with the Institution.....	1574
Entering Emergency Contact Data.....	1574
Pages Used to Enter Emergency Contact Data.....	1574
Entering Emergency Contact Data.....	1575
Entering Additional Phone Numbers for the Emergency Contact.....	1577
Tracking Work Experience.....	1577
Pages Used to Track Work Experience.....	1578
Entering Work Experience Data.....	1578
Chapter 48: (AUS) Managing CHESSN Data Storage.....	1581
Understanding CHESSN Data.....	1581

Storing CHESSN Data.....	1581
Pages Used to Store CHESSN Data.....	1582
Entering CHESSN Data.....	1583
Entering CHESSN Year 12 Data.....	1584
Entering CHESSN Previous HEP Data.....	1585
Entering Commonwealth Scholarships and OS-HELP Entitlement Data.....	1585
Chapter 49: (NZL) Managing NSI Data.....	1587
Understanding PeopleSoft NSI Processing.....	1587
Understanding NSI Fields.....	1591
Requesting NSNs.....	1593
Pages Used to Request NSNs.....	1593
Identifying Individuals Without NSNs.....	1593
Viewing Outgoing Suspense Data.....	1595
Extracting Data to Send to NSI.....	1597
Sending the Extract File.....	1599
Receiving NSI Data.....	1600
Pages Used to Receive NSI Data.....	1600
Downloading Data from the NSI Database.....	1600
Loading Results Data.....	1601
Reviewing Incoming Suspense Data.....	1601
Posting NSI Data.....	1608
Purging Suspense Data.....	1608
Page Used to Purge Suspense Data.....	1608
Purging Data from the NSI Suspense Table.....	1608
Processing Change Notifications.....	1608
Page Used to Process Change Notifications.....	1609
Downloading Change Notifications from NSI.....	1609
Uploading and Posting NSI Change Notifications.....	1609
Reviewing Additional NSI Data.....	1611
Page Used to Review Additional NSI Data.....	1611
Reviewing Additional NSI Data.....	1611
Chapter 50: Managing Health Information.....	1613
Understanding Health Information.....	1613
Prerequisites.....	1613
Common Elements Used in Managing Health Information.....	1613
Tracking Audiometric Exam Data.....	1615
Pages Used to Track Audiometric Exam Data.....	1615
Entering Audiometric Exam Address and Phone Data.....	1615
Entering Audiometric Exam Details.....	1615
Tracking Eye Exam Data.....	1616
Pages Used to Track Eye Exam Data.....	1616
Entering Eye Exam Details.....	1616
Tracking Physical Exam Data.....	1617
Pages Used to Track Physical Exam Data.....	1617
Entering Physical Exam Details.....	1618
Tracking Respiratory Exam Data.....	1618
Pages Used to Track Respiratory Exam Data.....	1618
Entering Respiratory Exam Details.....	1619
Processing Accommodations.....	1619
Prerequisites.....	1620
Pages Used to Process Accommodations.....	1620

Entering Accommodation Requests.....	1620
Entering Accommodation Options.....	1622
Entering Accommodation Job Tasks.....	1622
Identifying Regional Impairment and Support Services.....	1622
Page Used to Identify Regional Impairment and Support Services.....	1623
Entering Impairment Data.....	1623
Tracking Immunizations and Health Tests Data.....	1623
Prerequisites.....	1623
Common Elements Used in This Section.....	1624
Pages Used to Track Immunization and Health Data.....	1624
Entering Immunization Data.....	1624
Entering Health Test Data.....	1625
Chapter 51: Managing Personal Identification Data.....	1627
Understanding Personal Identification Data.....	1627
Entering Citizenship Data.....	1627
Understanding Citizenship and Passport Data.....	1628
Understanding Visa and Permit Data.....	1628
Prerequisites.....	1628
Pages Used to Enter Citizenship Data.....	1629
Entering Citizenship and Passport Data.....	1630
Entering Visa and Permit Data.....	1631
Visa/Payment Data NLD.....	1633
Entering Driver's License Data.....	1633
Page Used to Enter Driver's License Data.....	1633
Entering Driver's License Data.....	1634
Entering Residency Data.....	1635
Understanding Residency Data.....	1635
Prerequisites.....	1635
Pages Used to Enter Residency Data.....	1636
Entering Official Residency Data.....	1636
Entering Official Residency Location Details.....	1638
Entering Self-Reported Residency Data.....	1638
Entering Residency Appeal Data.....	1639
Entering Photographs.....	1639
Prerequisites.....	1639
Page Used to Enter Photographs.....	1640
Entering a Photograph.....	1640
Entering PINs.....	1640
Page Used to Enter Personal Identification Numbers.....	1640
Entering a Personal Identification Number.....	1640
Chapter 52: Managing Participation Data.....	1641
Understanding Participation Data.....	1641
Prerequisites for Managing Participation Data.....	1641
Entering Honors and Awards Data.....	1641
Page Used to Enter Honors and Awards Data.....	1642
Entering an Honor or Award.....	1642
Entering Licenses and Certificates Data.....	1642
Page Used to Enter License and Certificates Data.....	1643
Entering Licenses and Certificates Data.....	1643
Entering Memberships Data.....	1644
Page Used to Enter Memberships Data.....	1644

Entering Membership Data.....	1644
Entering Publications Data.....	1645
Page Used to Enter Publications Data.....	1645
Entering Publications Data.....	1645
Entering Athletic Participation Data.....	1647
Page Used to Enter Athletic Participation Data.....	1647
Entering Athletic Participation Data.....	1647
Entering Extracurricular Activities Data.....	1648
Page Used to Enter Extracurricular Activities Data.....	1648
Entering Extracurricular Activities Data.....	1648
Chapter 53: Managing FERPA Privacy Control.....	1651
Understanding FERPA.....	1651
Prerequisites for Managing FERPA Privacy Control.....	1651
Applying FERPA Control.....	1652
Pages Used to Apply FERPA Privacy Controls.....	1652
Applying or Releasing FERPA Restrictions.....	1653
Using the FERPA Quick Entry.....	1654
Releasing FERPA Data to Publications.....	1655
Determining Releasable Information.....	1656
Understanding the Determination of Releasable Information.....	1656
Pages Used to Determine Releasable Information.....	1656
Determining Releasable Biographical Data.....	1659
Chapter 54: Managing Service Indicators.....	1661
Understanding Service Indicators.....	1661
Viewing, Assigning, or Removing Service Indicators.....	1662
Pages Used to View, Assign, or Remove Service Indicators.....	1662
Viewing Service Indicators Assigned to an ID.....	1663
Assigning a Service Indicator to an ID.....	1665
Editing an Assigned Service Indicator.....	1670
Auditing Service Indicators.....	1671
Pages Used to Configure an Audit Service Indicator Search.....	1671
Configuring a Service Indicator Audit Search.....	1672
Mass Assigning or Mass Releasing Service Indicators.....	1673
Pages Used to Mass Assign or Mass Release Service Indicators.....	1673
Mass Assigning Service Indicators.....	1674
Mass Releasing Service Indicators.....	1675
Chapter 55: (USA) Managing PeopleSoft SEVIS Solution Visa Processing for J and F/M	
Visas.....	1677
Understanding SEVIS Visa Processing.....	1677
Understanding the Business Process Flow for Visa Processing.....	1677
Understanding the SEVIS Master Component.....	1680
Creating and Updating Student or Exchange Visitor and Dependent Data.....	1682
Pages Used to Create and Update Student or Exchange Visitor and Dependent Data.....	1682
Creating and Updating Biographical Data.....	1684
Creating and Updating Addresses Data.....	1685
Creating and Updating Electronic Addresses.....	1686
Creating and Updating Phone Numbers.....	1686
Creating and Updating Visa and Permit Data.....	1687
Creating and Updating Port of Entry Information for F and M Visas.....	1687
Creating and Updating Citizenship and Passport Data.....	1687
Maintaining SEVIS ID Information.....	1688

Creating and Updating Employment Authorization Information for F and M Visas.....	1689
Tracking Full Course Load Exceptions for F and M Visas.....	1700
Pages Used to Track Full Course Load Exceptions for F and M Visas.....	1700
Tracking Full Course Load Exception Rules.....	1700
Tracking External Full Course Load Exceptions.....	1701
Assigning Full Course Load Exceptions in Batch.....	1702
Creating and Updating Student Data for I-20 Forms for F and M Visas.....	1704
Pages Used to Create and Update Student Data for I-20 Forms for F and M Visas.....	1705
Entering I-20 Form Data.....	1705
Creating and Updating Exchange Visitor Data for DS-2019 Forms for J Visas.....	1719
Pages Used to Create and Update Exchange Visitor Data for DS-2019 Forms for J Visas.....	1720
Entering DS-2019 Form Data.....	1720
Using Dependent Search.....	1737
Page Used for Dependent Search.....	1737
Using Dependent Search.....	1737
Running the SEVIS Alerts Process.....	1738
Understanding Name Population.....	1738
Understanding Name Comparison.....	1740
Understanding Name Character Conversion.....	1740
Pages Used to Run the SEVIS Alerts Process.....	1750
Running the SEVIS Alerts Process for F and M Visas.....	1750
Running the SEVIS Alerts Process for J Visas.....	1774
Viewing SEVIS Alerts Process Data.....	1786
Pages Used to View SEVIS Alerts Process Data.....	1787
Selecting Data to Review.....	1788
Reviewing Alerts Data.....	1790
Entering Additional Data for an Event.....	1793
Viewing Event Errors Data.....	1794
Viewing Event History Information.....	1795
Pages Used to View Event History Information.....	1795
Viewing the Event History Summary.....	1796
Viewing Event History Detail Information.....	1796
Viewing Event Process Details.....	1797
Generating an XML File to Send to SEVIS.....	1798
Pages Used to Generate an XML File to Send to SEVIS.....	1798
Generating the XML File.....	1798
Downloading and Viewing SEVIS Results.....	1800
Pages Used to Download and View SEVIS Results.....	1801
Downloading SEVIS Import Results.....	1802
Viewing Results of the XML Upload to SEVIS.....	1803
Viewing Results of the SEVIS Download.....	1804
Viewing Individual Student or Exchange Visitor Record Results.....	1806
Viewing Individual Dependent Record Results.....	1807
Viewing Employment or Site of Activity Record Results.....	1808
Chapter 56: Understanding the 3Cs — Communications, Checklists, and Comments.....	1809
Understanding Communications, Checklists, and Comments.....	1809
Common Elements Used in The 3Cs Documentation.....	1810
Chapter 57: Using the Population Selection Process.....	1811
Understanding the Population Selection Group Box.....	1811
Using the Population Selection Process.....	1813
Pages Used for the Population Selection Process.....	1813

Example: Using Population Selection.....	1815
Running the Population Update Process.....	1822
Understanding the Population Update Process.....	1822
Page Used to Run the Population Update Process.....	1827
Selecting the Update Parameters.....	1827
Chapter 58: Using the 3C Engine.....	1831
Understanding the 3C Engine.....	1831
Defining 3C Engine Events.....	1831
Understanding 3C Engine Events.....	1832
Prerequisites.....	1832
Pages Used to Define 3C Engine Events.....	1832
Defining the 3C Engine Events.....	1833
Selecting Joint Rules Compare Fields.....	1836
Viewing Communication Keys.....	1836
Viewing Comments.....	1837
Viewing Checklists.....	1837
Defining 3C Engine Triggers.....	1837
Understanding 3C Engine Triggers.....	1837
Pages Used to Define 3C Engine Triggers.....	1838
Mapping Trigger Prompts.....	1839
Identifying Trigger Conditions.....	1839
Setting 3C Engine Security.....	1843
Understanding 3C Engine Security.....	1844
Page Used to Set 3C Engine Security.....	1844
Assigning Engine Event 3C Groups.....	1844
Viewing 3C Engine Trigger Results.....	1845
Understanding Trigger Results.....	1845
Pages Used to View 3C Engine Trigger Results.....	1845
Viewing Trigger Results.....	1846
Viewing Additional Trigger Result Details.....	1847
Running the 3C Engine Process.....	1847
Understanding the 3C Engine Process.....	1848
Pages Used to Run the 3C Engine Process.....	1848
Specifying 3C Engine Process Parameters.....	1849
Managing Duplicate Communication Assignments.....	1853
Chapter 59: Managing Communications.....	1857
Understanding Communication Management.....	1857
Understanding Joint Communications.....	1859
Prerequisites for Managing Communications.....	1861
Common Elements Used to Manage Communications.....	1861
Assigning Communications.....	1861
Pages Used to Assign Communications.....	1862
Assigning a Communication.....	1864
Reviewing or Updating Variable Data.....	1874
Adding or Deleting Enclosures.....	1874
Viewing the Communication Generated by the Communication Generation Process.....	1875
Identifying Recipients for an Organization.....	1877
Using the Letter Generation Process.....	1879
Understanding the Letter Generation Process.....	1879
Understanding the Letter Generation Sample Templates.....	1881
Prerequisites.....	1882

Pages Used for the Letter Generation Process.....	1882
Specifying General Parameters.....	1883
Specifying Date/Merge Parameters.....	1886
Specifying Checklist Parameters.....	1888
Running the Letter Generation Data Extract Process.....	1890
Using the Communication Generation Process.....	1890
Understanding the Communication Generation Process.....	1891
Understanding the Communication Generation Sample Templates.....	1892
Prerequisites for the Communication Generation Process.....	1893
Pages Used for the Communication Generation Process.....	1894
Entering Selection Parameters.....	1895
Entering Process Parameters.....	1902
Entering Email Parameters.....	1913
Entering Checklist Parameters.....	1915
Resetting Generated Communications.....	1918
Page Used to Reset Generated Communications.....	1919
Resetting a Communication.....	1919
Reviewing Communications.....	1921
Pages Used to Review Communications.....	1921
Reviewing Extract Data for a Communication.....	1925
Reviewing Extract Data for an Additional Individual Recipient.....	1926
Reviewing a Summary of Communications.....	1926
Reviewing 3C Group Access to a Communication.....	1927
Reviewing Details of a Communication.....	1928
Using the Envelope and Label Generation Process.....	1928
Understanding the Envelope and Label Generation Process.....	1928
Pages Used for the Envelope and Label Generation Process.....	1929
Entering Selection Parameters.....	1930
Entering Process Parameters.....	1934
Deleting Communications.....	1938
Understanding Communication Deletion.....	1938
Pages Used to Delete Communications.....	1939
Deleting Individual Communications.....	1940
Deleting Communications in Batch.....	1940
Chapter 60: Managing Comments.....	1943
Understanding Comments.....	1943
Prerequisites for Managing Comments.....	1943
Entering Comments.....	1943
Common Elements Used in This Section.....	1943
Pages Used to Enter Comments.....	1944
Entering Comments About an Individual.....	1945
Entering Comments About an Organization.....	1946
Reviewing or Changing Variable Data.....	1947
Reviewing Comments.....	1947
Common Elements Used in This Section.....	1947
Pages Used to View Comments.....	1948
Reviewing a Summary of Comments About an Individual.....	1949
Reviewing a Summary of Comments About an Organization.....	1949
Deleting Comments.....	1949
Page Used to Delete Comments.....	1949
Deleting Comments in Batch.....	1950

Chapter 61: Managing Checklists.....	1951
Understanding Checklists.....	1951
Prerequisites for Managing Checklists.....	1952
Common Elements Used to Manage Checklists.....	1952
Assigning Checklists to Individuals.....	1953
Pages Used to Assign Checklists to Individuals.....	1953
Assigning a Checklist to an Individual.....	1953
Reviewing or Updating Variable Data for an Individual.....	1954
Assigning Checklist Items to an Individual's Checklist.....	1955
Assigning Checklists to Organizations.....	1957
Pages Used to Assign Checklists to Organizations.....	1957
Assigning a Checklist to an Organization.....	1958
Reviewing or Updating Variable Data for an Organization.....	1958
Assigning a Checklist Item to an Organization's Checklist.....	1959
Assigning Checklists to Events.....	1960
Pages Used to Assign Checklists to Events.....	1960
Assigning a Checklist Item to an Event's Checklist.....	1961
Assigning a Checklist to an Event.....	1962
Reviewing 3C Group Access to Checklists.....	1963
Updating Checklist Item Status.....	1963
Pages Used to Update Checklist Item Status.....	1964
Manually Updating Checklist Items by ID.....	1964
Updating All or a Specific Checklist Item by Automated Process.....	1965
Updating Test Score, Transcript, or General Material Checklist Items.....	1965
Reviewing Checklists for Individuals.....	1968
Pages Used to Review Checklists for Individuals.....	1968
Viewing Detailed Checklist Data for an Individual.....	1969
Viewing a Summary of Checklist Item Status for an Individual.....	1969
Viewing a Summary of Tracking Groups for an Individual.....	1971
Viewing a Summary of Checklists in a Tracking Group for an Individual.....	1972
Viewing Tracking Group Data.....	1973
Reviewing Checklists for Organizations.....	1973
Pages Used to Review Checklists for Organizations.....	1973
Viewing Detailed Checklist Data for an Organization.....	1974
Viewing a Summary of Checklist Item Status for an Organization.....	1974
Viewing a Summary of Tracking Groups for an Organization.....	1976
Viewing a Summary of Checklists in a Tracking Group for an Organization.....	1977
Viewing Tracking Group Data.....	1978
Reviewing Checklists for Events.....	1978
Page Used to Review Checklists for Events.....	1978
Viewing All Checklist Items Assigned to an Event.....	1978
Deleting Checklists.....	1979
Page Used to Delete Checklists.....	1980
Deleting Checklists in Batch.....	1980
Chapter 62: Using the Student Services Center Component.....	1981
Setting Up the Student Services Center Component.....	1981
Page Used to Set Up the Student Services Center Component.....	1981
Setting Up the Student Services Center Component.....	1981
Viewing and Editing an Individual's Information.....	1984
Pages Used to View and Edit an Individual's Information.....	1984
Viewing an Individual's Student Center Information.....	1985

Viewing an Individual's General Information.....	1987
Viewing a Student's Admissions Information.....	1991
Viewing a Student's Transfer Credit Information.....	1995
Viewing a Student's Academics Information.....	1995
Viewing a Student's Self-Service Finances Information.....	1995
Viewing a Student's Self-Service Financial Aid Information.....	1999
Chapter 63: Adding Organizations to Your Database.....	2003
Understanding Organizations.....	2003
Creating Organization Records.....	2006
Prerequisites.....	2006
Pages Used to Create Organization Records.....	2007
Identifying the Organization.....	2008
Identifying the Organization as a School.....	2012
Identifying the Organization as a Non-Profit, Business, or Foundation.....	2014
Entering Regional Data.....	2015
Page Used to Enter Regional Data.....	2015
Entering Regional Data.....	2015
Entering School-Related Data.....	2016
Pages Used to Enter School-Related Data.....	2016
Entering Subjects Offered by the Organization.....	2016
Entering the Courses Offered within a Subject Area.....	2017
Setting Defaults for TS130 Electronic Transcripts.....	2018
Entering Affiliations with Organizations.....	2018
Prerequisites.....	2018
Page Used to Enter Affiliations with Organizations.....	2019
Entering Organization Affiliation Details.....	2019
Chapter 64: Managing Organization Data.....	2021
Understanding Organization Data.....	2021
Common Element Used to Manage Organization Data.....	2021
Entering Organization Location Data.....	2022
Prerequisites.....	2022
Pages Used to Enter Organization Location Data.....	2022
Viewing the Location Summary Data.....	2022
Identifying the Organization Location Data.....	2022
Entering Organization Department Data.....	2024
Prerequisites.....	2024
Pages Used to Enter Organization Department Data.....	2024
Viewing the Organization's Departments Summary Data.....	2025
Identifying the Organization Departments.....	2025
Entering Organization Contact Data.....	2026
Prerequisites.....	2027
Pages Used to Enter Organization Contact Data.....	2027
Viewing the Organization's Contact Summary Data.....	2027
Identifying the Organization's Contacts Data.....	2028
Identifying the Preferred Contact.....	2030
Reviewing Organization Data.....	2030
Pages Used to Review Organization Data.....	2031
Viewing Location Data.....	2032
Viewing Primary Location Data.....	2033
Viewing School Data.....	2033
Viewing Phone Data.....	2033

Viewing Department Data.....	2033
Viewing Organization Department Details.....	2034
Viewing Contacts Data.....	2034
View Organization Contact Details.....	2035
Viewing Organizations by Group Types.....	2035
Managing Organization IDs.....	2036
Entering Codes for External Organizations.....	2036
Understanding External Organization Codes.....	2036
Prerequisites.....	2036
Page Used to Enter Codes for External Organizations.....	2036
Assigning Codes to External Organizations.....	2037
Chapter 65: Loading External Organization Data.....	2039
Understanding External Data Load.....	2039
Loading External ATP Data.....	2039
Understanding ATP Data Load.....	2039
Pages Used to Load External ATP Data.....	2040
Specifying the Data Source.....	2042
Reviewing Suspense Process Options Data.....	2042
Reviewing School Address Data.....	2046
Reviewing Other School Data.....	2046
Reviewing ATP Data Suspense Messages.....	2047
Reviewing All ATP Messages.....	2047
Specifying Search Parameters.....	2047
Searching for Duplicate Records and Posting the Data.....	2049
Purging ATP Data from the Suspense File.....	2049
Loading External EPS Data.....	2050
Chapter 66: Managing Committee Data.....	2051
Prerequisites for Managing Committee Data.....	2051
Creating Committees.....	2051
Page Used to Create Committees.....	2051
Creating a Committee.....	2051
Assigning Committee Members.....	2052
Page Used to Assign Committee Members.....	2052
Assigning Members to a Committee.....	2052
Chapter 67: Using Evaluation Management.....	2053
Managing Evaluations.....	2053
Pages Used to Manage Evaluations.....	2053
Reviewing an Evaluation.....	2054
Adding Evaluation Attachments.....	2056
Calculating an Evaluation Rating Scheme.....	2057
Entering Results for an Evaluator in an Individual Evaluator Scheme.....	2058
Entering Results for an Evaluator in a Committee Evaluation Scheme.....	2060
Processing Evaluations in Batch.....	2064
Page Used to Process Evaluations in Batch.....	2064
Processing Evaluations.....	2064
Sending Timeout and Reminder Notifications to Evaluators.....	2067
Chapter 68: Using Evaluation WorkCenter.....	2069
Understanding Evaluation WorkCenter.....	2069
Modifying the Landing Page Text.....	2071
Prerequisites for using Evaluation WorkCenter.....	2071
Using Self-Service Worklist.....	2071

Entering Evaluations.....	2071
Pages Used to Enter Evaluations.....	2080
Chapter 69: Managing Campus Event Planning.....	2081
Understanding Campus Event Planning.....	2081
Common Elements Used to Manage Campus Event Planning.....	2082
Creating an Event.....	2082
Prerequisites.....	2083
Pages Used to Create an Event.....	2083
Naming an Event.....	2084
Adding Meetings to an Event.....	2085
Entering Meeting Details.....	2086
Specifying Meeting Sponsors.....	2087
Entering the Meeting Location.....	2088
Scheduling the Meeting Resources.....	2089
Scheduling Meeting Staff.....	2089
Tracking Event Attendance.....	2090
Pages Used to Track Event Attendance.....	2091
Identifying Attendees and Guests.....	2091
Specifying Meetings for an Attendee and Reviewing Attendance Status.....	2092
Entering an Attendee's Address (Optional).....	2093
Reviewing Events, Meetings, and Attendees.....	2094
Pages Used to Review Events, Meetings, and Attendance.....	2094
Reviewing Events by Facility and Meeting Date.....	2095
Reviewing Event Meetings.....	2095
Reviewing Attendees for an Event.....	2095
Reviewing Attendees by Meeting.....	2096
Reviewing Event Meetings for an Attendee.....	2096
Reviewing an Attendee's Event Summary.....	2097
Reviewing an Attendee's Event Meetings Summary.....	2097
Reviewing an Attendee's Guests.....	2097
Chapter 70: Managing External System Data About an Individual or Organization.....	2099
Understanding External System Data.....	2099
Defining External Systems.....	2099
Page Used to Define External Systems.....	2099
Defining an External System for a Person or Organization.....	2099
Entering External System IDs.....	2100
Pages Used to Enter External System IDs.....	2100
Entering an External System ID for a Person or Organization.....	2100
Chapter 71: Integrating with Oracle Fusion Cloud Student Aid Eligibility.....	2103
Understanding Integration with Oracle Fusion Cloud Student Aid Eligibility.....	2103
Setting Up Integration with Oracle Fusion Cloud Student Aid Eligibility.....	2104
Page Used to Set Up Integration with Oracle Fusion Cloud Student Financial Planning.....	2104
Exchanging Data with Oracle Fusion Cloud Student Aid Eligibility.....	2104
Pages Used to Exchange Data with Oracle Fusion Cloud Student Aid Eligibility.....	2105
Processing SAE Messages.....	2105
Reviewing the SAE Message Log.....	2109
Loading SAE Reporting Data.....	2110
Chapter 72: Integrating with Oracle Fusion Cloud Student Financial Planning.....	2113
Understanding Integration with Oracle Fusion Cloud Student Financial Planning.....	2113
Setting Up Integration with Oracle Fusion Cloud Student Financial Planning.....	2114
Pages Used to Set Up Integration with Oracle Fusion Cloud Student Financial Planning.....	2115

Activating Student Financial Planning in Campus Solutions.....	2115
Setting Up SFP Group Control.....	2117
Defining Academic Terms for SFP Projections.....	2117
Defining SFP Integration Options.....	2118
Exchanging Data with Oracle Fusion Cloud Student Financial Planning.....	2121
Pages Used to Exchange Data with Oracle Fusion Cloud Student Financial Planning.....	2121
Processing SFP Messages.....	2122
Viewing the SFP Student Program/Plan.....	2132
Reviewing the SFP Message Log.....	2133
Validating SFP Messages.....	2134
Loading SFP Reporting Data.....	2135
Reviewing and Expiring Anticipated Aid.....	2138
Pages Used to Expire Anticipated Aid.....	2138
Expiring SFP Anticipated Aid for a Single Student.....	2138
Expiring SFP Anticipated Aid in Batch.....	2139
Chapter 73: Population Selection Process Queries and Equations.....	2141
Queries for Population Selection.....	2141
Equations for Population Selection.....	2150

Preface

Understanding the PeopleSoft Online Help and PeopleBooks

The PeopleSoft Online Help is a website that enables you to view all help content for PeopleSoft applications and PeopleTools. The help provides standard navigation and full-text searching, as well as context-sensitive online help for PeopleSoft users.

Hosted PeopleSoft Online Help

You can access the hosted PeopleSoft Online Help on the [Oracle Help Center](#). The hosted PeopleSoft Online Help is updated on a regular schedule, ensuring that you have access to the most current documentation. This reduces the need to view separate documentation posts for application maintenance on My Oracle Support. The hosted PeopleSoft Online Help is available in English only.

To configure the context-sensitive help for your PeopleSoft applications to use the Oracle Help Center, see [Configuring Context-Sensitive Help Using the Hosted Online Help Website](#).

Locally Installed PeopleSoft Online Help

If you're setting up an on-premises PeopleSoft environment, and your organization has firewall restrictions that prevent you from using the hosted PeopleSoft Online Help, you can install the online help locally. Installable PeopleSoft Online Help is made available with selected PeopleSoft Update Images and with PeopleTools releases for on-premises installations, through the [Oracle Software Delivery Cloud](#).

Your installation documentation includes a chapter with instructions for how to install the online help for your business environment, and the documentation zip file may contain a README.txt file with additional installation instructions. See *PeopleSoft 9.2 Application Installation* for your database platform, "Installing PeopleSoft Online Help."

To configure the context-sensitive help for your PeopleSoft applications to use a locally installed online help website, see [Configuring Context-Sensitive Help Using a Locally Installed Online Help Website](#).

Downloadable PeopleBook PDF Files

You can access downloadable PDF versions of the help content in the traditional PeopleBook format on the [Oracle Help Center](#). The content in the PeopleBook PDFs is the same as the content in the PeopleSoft Online Help, but it has a different structure and it does not include the interactive navigation features that are available in the online help.

Common Help Documentation

Common help documentation contains information that applies to multiple applications. The two main types of common help are:

- Application Fundamentals

- Using PeopleSoft Applications

Most product families provide a set of application fundamentals help topics that discuss essential information about the setup and design of your system. This information applies to many or all applications in the PeopleSoft product family. Whether you are implementing a single application, some combination of applications within the product family, or the entire product family, you should be familiar with the contents of the appropriate application fundamentals help. They provide the starting points for fundamental implementation tasks.

In addition, the *PeopleTools: Applications User's Guide* introduces you to the various elements of the PeopleSoft Pure Internet Architecture. It also explains how to use the navigational hierarchy, components, and pages to perform basic functions as you navigate through the system. While your application or implementation may differ, the topics in this user's guide provide general information about using PeopleSoft applications.

Field and Control Definitions

PeopleSoft documentation includes definitions for most fields and controls that appear on application pages. These definitions describe how to use a field or control, where populated values come from, the effects of selecting certain values, and so on. If a field or control is not defined, then it either requires no additional explanation or is documented in a common elements section earlier in the documentation. For example, the Date field rarely requires additional explanation and may not be defined in the documentation for some pages.

Typographical Conventions

The following table describes the typographical conventions that are used in the online help.

<i>Typographical Convention</i>	<i>Description</i>
Key+Key	Indicates a key combination action. For example, a plus sign (+) between keys means that you must hold down the first key while you press the second key. For Alt+W , hold down the Alt key while you press the W key.
... (ellipses)	Indicate that the preceding item or series can be repeated any number of times in PeopleCode syntax.
{ } (curly braces)	Indicate a choice between two options in PeopleCode syntax. Options are separated by a pipe ().
[] (square brackets)	Indicate optional items in PeopleCode syntax.
& (ampersand)	When placed before a parameter in PeopleCode syntax, an ampersand indicates that the parameter is an already instantiated object. Ampersands also precede all PeopleCode variables.

Typographical Convention	Description
⇒	This continuation character has been inserted at the end of a line of code that has been wrapped at the page margin. The code should be viewed or entered as a single, continuous line of code without the continuation character.

ISO Country and Currency Codes

PeopleSoft Online Help topics use International Organization for Standardization (ISO) country and currency codes to identify country-specific information and monetary amounts.

ISO country codes may appear as country identifiers, and ISO currency codes may appear as currency identifiers in your PeopleSoft documentation. Reference to an ISO country code in your documentation does not imply that your application includes every ISO country code. The following example is a country-specific heading: "(FRA) Hiring an Employee."

The PeopleSoft Currency Code table (CURRENCY_CD_TBL) contains sample currency code data. The Currency Code table is based on ISO Standard 4217, "Codes for the representation of currencies," and also relies on ISO country codes in the Country table (COUNTRY_TBL). The navigation to the pages where you maintain currency code and country information depends on which PeopleSoft applications you are using. To access the pages for maintaining the Currency Code and Country tables, consult the online help for your applications for more information.

Region and Industry Identifiers

Information that applies only to a specific region or industry is preceded by a standard identifier in parentheses. This identifier typically appears at the beginning of a section heading, but it may also appear at the beginning of a note or other text.

Example of a region-specific heading: "(Latin America) Setting Up Depreciation"

Region Identifiers

Regions are identified by the region name. The following region identifiers may appear in the PeopleSoft Online Help:

- Asia Pacific
- Europe
- Latin America
- North America

Industry Identifiers

Industries are identified by the industry name or by an abbreviation for that industry. The following industry identifiers may appear in the PeopleSoft Online Help:

- USF (U.S. Federal)

- E&G (Education and Government)

Translations and Embedded Help

PeopleSoft 9.2 software applications include translated embedded help. With the 9.2 release, PeopleSoft aligns with the other Oracle applications by focusing our translation efforts on embedded help. We are not planning to translate our traditional online help and PeopleBooks documentation. Instead we offer very direct translated help at crucial spots within our application through our embedded help widgets. Additionally, we have a one-to-one mapping of application and help translations, meaning that the software and embedded help translation footprint is identical—something we were never able to accomplish in the past.

Using and Managing the PeopleSoft Online Help

Select About This Help in the left navigation panel on any page in the PeopleSoft Online Help to see information on the following topics:

- Using the PeopleSoft Online Help.
- Managing hosted Online Help.
- Managing locally installed PeopleSoft Online Help.

PeopleSoft CS Related Links

[Hosted Online Help Home](#)

[PeopleSoft Information Portal](#)

[My Oracle Support](#)

Contact Us

Send your suggestions to pssoft-infodev_us@oracle.com.

Please include the applications update image or PeopleTools release that you're using.

Follow Us

<i>Icon</i>	<i>Link</i>
	Watch PeopleSoft on YouTube

Icon	Link
	Follow @PeopleSoft_Info on X.
	Read PeopleSoft Blogs
	Connect with PeopleSoft on LinkedIn

Getting Started with Campus Community

Campus Community Overview

Individuals and organizations are the foundation of PeopleSoft Campus Solutions. You use Campus Community to create the records for the individuals and organizations that comprise your institution's community. After you create the records, use Campus Community to continue to update, maintain, and track information about the individuals and organizations associated with your institution.

Campus Community Business Processes

You must design and implement Campus Community before you can fully implement PeopleSoft Campus Solutions. In the planning phase of your implementation, you must carefully consider how to design names, addresses, and other basic elements in Campus Community for consistent use by all Campus Solutions applications and throughout all business processes across your institution. These design decisions provide the framework for creating all people and organization records in your database.

See [Designing Campus Community](#).

Note: For full implementation planning, you will also want to read all of the setup information in Campus Community Fundamentals, Campus Solutions Application Fundamentals, and take advantage of all PeopleSoft sources of information, including installation guides, table-loading sequences, data models, and business process maps.

By implementing Campus Community, you set up tables and options to support the management of unique IDs and to support the following business processes:

- Adding People to PeopleSoft Campus Solutions and Managing Biographical Information:

You must use the Biographical Details page of the Add/Update a Person component to enter biographical data and create records for people in your database from any of the Campus Solutions applications.

Biographical information enables you to enter the data that uniquely describes each individual, including their names, addresses, phone numbers, and personal attributes such as ethnicity, language, and religious preferences data.

Biographical data also includes FERPA privacy control, relationships, emergency contacts, and work experience data for individuals. (FERPA functionality enables you to provide and track the student's ability to control the release of their personal data, as required by the U.S. Family Educational Rights and Privacy Act regulation, but can also be used globally to manage privacy controls at any institution.)

In addition to biographical data, you can track an individual's health, identification, and participation information.

- **Managing Health Data:**

Health information enables you to track immunizations and eye, audiometric, and physical exams.

- **Managing Personal Identification Data:**

Personal identification data enables you to post photos of individuals and enter other data about items that officially and uniquely identify individuals in the community at large, including citizenship, driver's licenses, and residency status.

- **Managing Participation Data:**

Participation data enables you to enter and track an individual's athletic participation, extracurricular activities, honors and awards, and licenses, certificates, and memberships.

- **Managing System IDs:**

You can control the autonumbering of system IDs and define priority data to control the deletion of IDs in your database.

- **(NZL) Managing National Student Index (NSI) Data:**

You can load NSI data and process responses to new NSI requests and update current records and change requests.

- **Searching for Records and Using Search/Match:**

You can enter data on search dialog pages to search for records in your database. You can define various levels of search, using use Search/Match, to detect potential duplicate records before adding a new record. You can force Search/Match at save time or allow users to run ad hoc searches.

- **(USA) Managing Patriot Act SEVIS Solution (PeopleSoft PASS) Visa Processing:**

You can prepare and process required information about international students and exchange visitors and their dependents and pass it to the internet-based Student and Exchange Visitor Information System (SEVIS) maintained by U.S. Department of Homeland Security (DHS). PeopleSoft PASS enables you to collect the data, monitor changes, and report student and exchange visitor changes.

- **Managing the 3Cs — Communications, Checklists, and Comments:**

Campus Community's 3Cs enable you to create and track communications to individuals or organizations, to create and monitor checklists of items required of an individual, and to enter comments. You can use the 3C engine to automate the assignment and tracking of communications and checklists.

- **Managing Service Indicators:**

Service indicator functionality enables you to assign a positive or negative indicator to an individual's record to identify services that are available to or should be denied for that individual.

- **Managing Organization Data:**

Organization functionality enables you to create records for organizations, including identifying an organization's location, departments, and contacts data.

- Managing Committee Data:

Committee data enables you to assign members to committees and assign tasks to them.

- Managing Campus Event Planning:

Events data enables you schedule one or several meetings within an event, reserve facilities and resources for each, and invite attendees. You can also track attendance.

Campus Community Integrations

Campus Community integrates with many PeopleSoft applications including:

- PeopleSoft Financial Aid.
- PeopleSoft Recruiting and Admissions.
- PeopleSoft Gradebook.
- PeopleSoft Student Records and any associated third-party distance learning vendors.
- PeopleSoft Student Financials and any associated third-party payment processor.
- PeopleSoft Academic Advisement.
- PeopleSoft Contributor Relations.
- PeopleSoft Human Capital Management.
- PeopleSoft Financials.

The following diagram illustrates the integration between Campus Community and these applications.

PeopleSoft Campus Community integrations

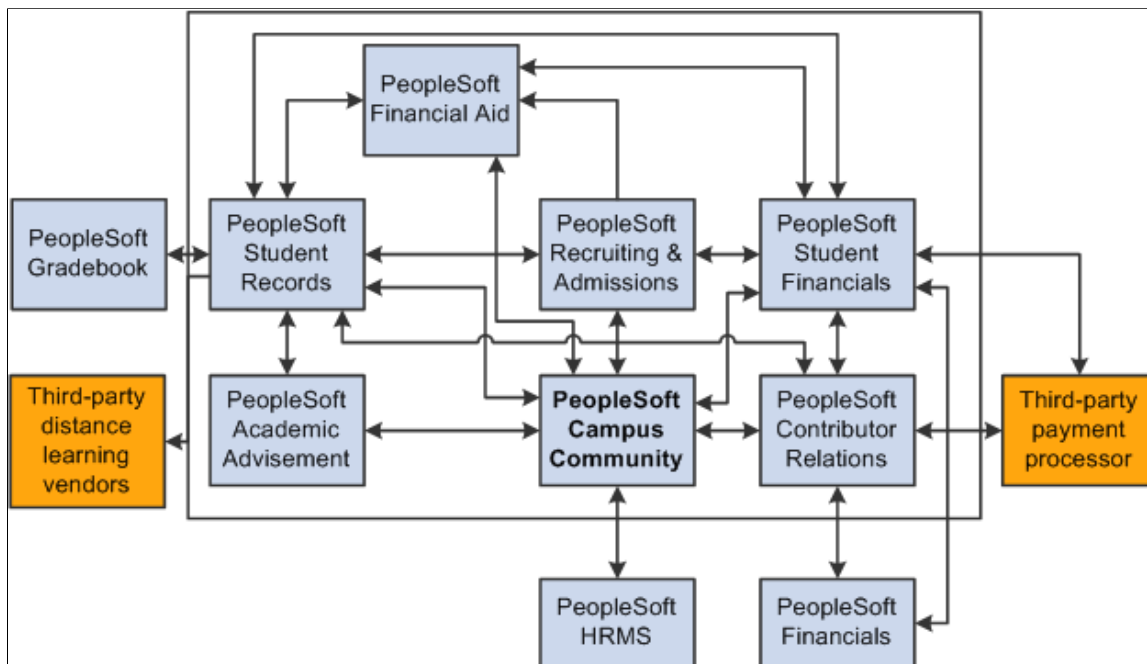

For information about integration considerations, see the implementation sections.

Note: If you implement Campus Solutions *and* a separate instance of PeopleSoft Human Capital Management, read the relevant documentation about CS-HCM Integration to understand the setup, functional, and technical implementation considerations. See:
 “Integrating Person Data” (Campus Solutions Application Fundamentals)
 “Integrating Setup Data” (Campus Solutions Application Fundamentals)
 “Monitoring Integrations Using the Integrity Utility” (Campus Solutions Application Fundamentals)
Information Center: CS-HCM Integration for PeopleSoft Enterprise Campus Solutions in My Oracle Support (ID 2091799.2).

Supplemental information about third-party application integrations is located on [My Oracle Support](#).

Campus Community Implementation

PeopleSoft Setup Manager enables you to generate a list of setup tasks for your organization based on the features that you are implementing. The setup tasks include the components that you must set up, listed in the order in which you must enter data into the component tables, and links to the corresponding documentation.

Campus Community also provides component interfaces to help you load data from your existing system into Campus Community tables. Use the Excel to Component Interface utility with the component interfaces to populate the tables.

This table lists Campus Community components that have setup component interfaces:

Component	Component Interface	References
COMM_CATG_TBL	SCC_COMM_CATG_TBL	See Defining a Communication Category .
COMM_CTXT_TBL	SCC_COMM_CTXT_TBL	See Defining a Communication Context .

See *PeopleTools: Setup Manager*

Additional Information for Getting Started with Campus Community

Essential information describing the setup and design of your system appears in two companion volumes of documentation: this documentation (*Campus Community Fundamentals*) and *Campus Solutions Application Fundamentals* documentation. Whether you are implementing one Campus Solutions application, a combination of Campus Solutions applications, or the entire Campus Solutions product line, you must become familiar with the information provided in this fundamental documentation for successful implementation.

See *Campus Solutions Application Fundamentals*

For information about deferred processing, see “Additional Information for Getting Started with Campus Solutions” (*Campus Solutions Application Fundamentals*).

Chapter 2

Designing Campus Community

Designing Campus Community

Before you can fully implement Campus Community, you must verify settings and establish elements for people and organization processing.

- Verify that your system's default settings reflect your institution's design decisions and reset them if they do not.

Reviewing these settings can provide insight into some of the values that your system automatically displays or formats. For example, reviewing the ID settings in the Installation Table component (described in *Campus Solutions Application Fundamentals*) helps you identify where seed numbers are set for the automatic sequencing and assigning of ID numbers. Reviewing the country, state, and province codes ensures that the codes that your institution uses are available and that the standard address format that is set to appear for each, will serve your institution's needs.

- Set up name and address formats and identify types to manage individual names and addresses.
- Create usages to identify which types of names or addresses to use in specific circumstances.
- Review the National ID table to determine if the predefined national ID types, which PeopleSoft ships, include the identification numbers for the countries and formats that your institution requires.

National ID numbers provide a method of identifying and tracking individuals. PeopleSoft ships national ID number formats predefined per country, including United States social security numbers (SSNs) and Canadian social insurance numbers (SINs).

- Establish salutations for use in communications with individuals in your system, set priority criteria to control the addition and deletion of records in your system, and specify the sets of data to use to detect duplicate or multiple records.
- Designate the types of information to control about individuals so that all departments in your institution can use the system to comply with government privacy regulations and any internal privacy policies.
- (NZL) Enable online NSI processing and set default values to use for the National Student Index (NSI) provider code and, current file number.
- Define the communication preferences that your institution wants to support to communicate with the student population.

After you establish these basics, you can create records and begin using the full functionality of PeopleSoft Campus Solutions.

Warning! Before adding records or entering and updating data, you must be familiar with PeopleSoft applications, including the Add, Update/Display, Include History, and Correct History modes and the PeopleSoft method of applying effective dates with active or inactive statuses.

See:

- *PeopleTools: Applications User's Guide* "Understanding Effective Dates"
- "Understanding Installation Setup and System Defaults" (Campus Solutions Application Fundamentals)

Reviewing or Defining Campus Community Installation Settings

Note: If you implement Campus Solutions *and* a separate instance of PeopleSoft Human Capital Management, read the relevant documentation about CS-HCM integration to understand the setup, functional, and technical implementation considerations. See:
"Integrating Person Data" (Campus Solutions Application Fundamentals)
"Integrating Setup Data" (Campus Solutions Application Fundamentals)
"Monitoring Integrations Using the Integrity Utility" (Campus Solutions Application Fundamentals)
Information Center: CS-HCM Integration for PeopleSoft Enterprise Campus Solutions in My Oracle Support (Doc ID 2091799.2)

To review Campus Community installation settings, use the Campus Community Installation component (INSTALLATION_CC).

This section lists prerequisites and discusses how to:

- Review or define default installation settings for events, relationships, SEVIS, checklists, national IDs and communication preferences.
- Review or define default installation settings for name and address types.
- (NZL) Review or define default installation settings for National Student Index processing.
- Configure consumer access to notification administration.
- Review or define installation settings for biographic details.

For documentation about the Notification Consumer Admin page, see [Setting Up Security for Admin Notifications](#).

Prerequisites

Some tables are delivered with predefined values in them so that default installation values can be established. If you must change default settings (for example for event types, salutations, address types, and so on) and the values that you desire are not available, you can modify or add values to those tables.

Related Links

[Defining Event Types](#)

[Establishing Salutations](#)

Understanding Biographical Information

Page Used to Review or Define Campus Community Installation Settings

Page Name	Definition Name	Navigation	Usage
Installation Default - CC	INSTALLATION_CC	Set Up SACR > Install > Campus Community Installation Installation Default - CC	Review or define Campus Community default installation settings for events, relationships, checklists, SEVIS, national IDs, communication preferences, and Fluid.
Names / Addresses	SCC_INSTALL_CC2	Set Up SACR > Install > Campus Community Installation > Names / Addresses	Review or define Campus Community default installation settings for names and addresses.
Extensions	SCC_INSTALL_EXT	Set Up SACR > Install > Campus Community Installation > Extensions	Review or define Campus Community default installation settings for New Zealand's National Student Index (NSI).
Notification Consumer Admin	SCC_NTF_INSTCON	Set Up SACR > Install > Campus Community Installation > Notification Consumer Admin	Configure Notification administration access for consumers. For information, see Setting Up Security for Admin Notifications .
Biographic Fields	SCC_BIOCFG_INSTALL	Set Up SACR > Install > Campus Community Installation > Biographic Fields	Review or define Campus Community installation settings for biographic fields displayed on the Personal page in Add/Update a Person.

Reviewing or Defining Default Installation Settings for Events, Relationships, SEVIS, Checklists, National IDs, Communication Preferences, and Fluid

Access the Installation Default - CC page (**Set Up SACR > Install > Campus Community Installation > Installation Default - CC**).

This example illustrates the fields and controls on the Installation Default - CC page (1 of 2). You can find definitions for the fields and controls later on this page.

Installation Default - CC
Names / Addresses
Extensions

Event Type Defaults

*Course Event Type:

*Default Event Type:

Usage Options

Address Usage:

Relationships

Create Reciprocal Relationship Default for All Gender:

Default Salutation Type:

Address for Primary ID: Address for Related ID:

SEVIS Defaults

Extract Batch ID:

Checklist Type

Checklist Type:

NID Type for AD and FA Loads

Country:

National ID Type:

This example illustrates the fields and controls on the Installation Default - CC page (2 of 2). You can find definitions for the fields and controls later on this page.

Communication Preferences

Support multiple languages Support multiple methods

Personalize | Find | First Last

*Language Code		
1 English	+	-
2 Spanish	+	-
3 French	+	-

Personalize | Find | First Last

*Communication Method		
1 E-Mail	+	-
2 Letter	+	-

Allow Deletes From 3C Pages

	Person	Organization
Communication	<input type="checkbox"/>	<input type="checkbox"/>
Checklists	<input type="checkbox"/>	<input type="checkbox"/>
Comments	<input type="checkbox"/>	<input type="checkbox"/>

Enable New Features

Enable Campus Community Fluid

Event Type Defaults

<i>Field or Control</i>	<i>Description</i>
Course Event Type	<p>The default value is <i>Course</i>. Do <i>not</i> change this value.</p> <p>PeopleSoft Student Records treats courses as events. Therefore, the Course Event Type field must be set to <i>Course</i> so that you can schedule classes.</p>
Default Event Type	<p>The default value is <i>Meeting</i>.</p> <p>You can override this value (using the Events component) if your institution wants to set a different default value for the type of event.</p>
Address Usage	<p>Select an Address Usage.</p> <hr/> <p>Note: This field is required if you are integrating with Oracle Student Financial Planning Cloud Service. See Setting Up Integration with Oracle Fusion Cloud Student Financial Planning</p> <hr/>

Relationships

<i>Field or Control</i>	<i>Description</i>
Create Reciprocal Relationship	<p>The system selects this check box by default. When it is selected, the system automatically creates the reciprocal relationship between the related ID and the primary ID when you create a relationship on the Relationships page between a primary ID and another ID (the related ID) within the system.</p> <p>For example, if you create a relationship between Mary Smith (the primary ID, as the mother) and Denise Strauss (the related ID, as the daughter), the system automatically creates the reciprocal relationship for Denise Strauss, identifying her as daughter with a relationship to Mary Smith, as mother.</p> <p>If you clear this check box, only Mary Smith's record reflects the mother/daughter relationship.</p>
Default for All Gender	<p>The default value is <i>A(all)</i>. Do <i>not</i> change this value.</p> <p>The system uses the value in this field to create the reciprocal relationship. Changing the value here changes genders throughout your system, which you might not intend to do.</p>

Field or Control	Description
Default Salutation Type	<p>The default value is <i>Primary</i>.</p> <p>The system displays and uses this value, which appears by default from the Joint Salutation Type page, as the salutation for two people with a relationship that are set up to receive joint communications on the Relationships page.</p>
Address for Primary ID	<p>The default value is <i>Home</i>.</p> <p>When you create a relationship between two individuals on the Relationship page, the system uses this value to display an address for the primary ID individual on the Relationship Address page.</p> <p>For example, with the default value set to <i>Home</i>, the system displays the home address for the primary ID as defined on the Addresses page, unless otherwise instructed.</p>
Address for Related ID	<p>The default value is <i>Home</i>.</p> <p>When you create a relationship between two individuals on the Relationships page, the system uses this value to display an address for the related ID individual on the Relationship Address page.</p> <p>For example, when the value is <i>Home</i>, the system displays the home address for the related ID as defined on the Addresses page, unless otherwise instructed.</p>

SEVIS Defaults

Field or Control	Description
Extract Batch ID	<p>The system displays the batch number used in the SEVIS XML file produced during the SEVIS Export process. The SEVIS Export process controls and sequentially numbers the extract batch ID value with each new run.</p> <p>See Generating an XML File to Send to SEVIS.</p>

Checklist Type

<i>Field or Control</i>	<i>Description</i>
Checklist Type	<p>Enter the checklist type that you want to use for associating a checklist with a communication. This checklist type is the only type that can be associated with a Comm Key. You associate the checklist type with a communication in the Checklist Table page.</p> <p>See Setting Up Checklist Items.</p>

NID Type for AD and FA Loads

National ID (NID) types and their formats are defined on the National ID Type Table page.

See [Defining National ID Types](#).

If the **Default** check box for an NID type is selected on the National ID Type Table page, the system uses that NID type as the default for the **National ID Type** field required when creating new people in your system. You can choose to set or not set a default NID type to use to populate this field when creating new people.

Because the **NID Type** field is required when creating new people in your system, the delivered Admission data load processes (such as ACT, ADA, AP, and so on) and the Financial Aid load processes (Financial Aid PROFILE, Need Access Process or Financial Aid ISIR) require a default National ID type. Use the **National ID Type** field in this group box to set a default National ID type for these processes to use if no default National ID type is selected on the National ID Type Table.

<i>Field or Control</i>	<i>Description</i>
Country	The system displays the installation country specified on the Installation Table component (INSTALLATION_TBL3) page.
National ID Type	<p>Enter the default value for Admissions and Financial Aid processes to use in the National ID Type field when no default value is selected on the National ID Type Table page.</p> <p>An NID value here is relevant only if your institution:</p> <ol style="list-style-type: none"> 1. Uses the delivered Admission data load processes (such as ACT, ADA, AP, and so on) or the Financial Aid load processes (Financial Aid PROFILE, Need Access Process or Financial Aid ISIR). 2. Does not want to save a default National ID when creating new IDs for which no National ID is provided inside the data load.

Communication Preferences

Use this group box only if your institution supports multiple languages or multiple methods or both multiple languages and multiple methods for communications, and you want to give administrators and self-service users the opportunity to specify the language or method by which a student prefers to receive communications from you.

Warning! Only communications generated by the Communication Generation process can use communication preferences. No other delivered processes are configured to consider either language or method preferences.

This table lists the pages and page elements affected by the selections that you make in the **Communication Preferences** group box.

Note: Pages whose object names that begin with SCC are administrator pages and pages whose object names begin with SS_CC are self-service pages.

Page	Page Elements
Communication Preferences page (SCC_COMM_PREF)	<p>The Preferred Language field appears on this page when the Support multiple languages check box is selected on the Installation Default - CC page.</p> <p>The Preferred Communication Method field appears on this page when the Support multiple methods check box is selected.</p> <hr/> <p>Note: If you do not take advantage of the communication preferences options, do not give your administrators security access to the administrative Communications Preferences page.</p> <hr/>
Campus Preferences page (SCC_PREF_CONFIG_FL)	<p>The Communication Preferences group box appears on this page if either Support multiple languages or Support multiple methods is selected on the Installation Default - CC page.</p>
Languages page (SCC_LANGUAGES)	<p>The Set Preferred Communication Language link appears when the Support multiple languages check box is selected on the Installation Default - CC page.</p> <p>The link transfers the administrative users to the Communication Preferences (SCC_COMM_PREF) page.</p>

Page	Page Elements
<p>Communication Preferences page (SS_CC_COMM_PREF)</p>	<p>The Preferred Language field appears on this page when the Support multiple languages check box is selected on the Installation Default - CC page.</p> <p>The Preferred Communication Method field appears on this page when the Support multiple methods check box is selected on the Installation Default - CC page.</p> <hr/> <p>Note: If you do not take advantage of the communication preferences options, do not give your self-service users security access to the self-service Communication Preferences page.</p> <hr/>
<p>Languages page (SS_CC_LANGUAGES_L)</p>	<p>The Set Preferred Communication Language link appears on this page when the Support multiple languages check box is selected on the Installation Default - CC page.</p> <p>The link transfers the self-service user to the self-service Communication Preferences (SS_CC_COMM_PREF) page.</p>
<p>User Preferences (SS_CC_USER_PREF)</p>	<p>The Set Communication Preferences link appears on this page when either the Support multiple languages or Support multiple methods check box is selected or when both check boxes are selected on the Installation Default - CC page.</p> <p>The link transfers the self-service user to the self-service Communication Preferences (SS_CC_COMM_PREF) page.</p>
<p>Personal Data Summary (SSS_PRSNLDATA_SUMM)</p>	<p>The Set Communication Preferences link appears on this page when either the Support multiple languages or Support multiple methods check box is selected or when both check boxes are selected on the Installation Default - CC page.</p> <p>The link transfers the self-service user to the self-service Communication Preferences (SS_CC_COMM_PREF) page.</p>
Field or Control	Description
<p>Support multiple languages and Language</p>	<p>Select the Support multiple languages check box only if your institution sets up and supports more than one language for communications. Enter each language that your system is set to support.</p>

<i>Field or Control</i>	<i>Description</i>
Support multiple methods and Communication Method	<p>Select the Support multiple methods check box only if your institution sets up and supports more than one method of communications. Enter each method.</p> <hr/> <p>Note: As of the date of this publication, the Communication Generation process supports the methods of letters and emails only.</p>

Allow Deletes from 3C Pages

Select the **Person** or **Organization** check boxes in this group box to allow users to delete individual communications, comments, and checklists for people, organizations, or both. To delete individual communications, comments, and checklists, click the trash can icon on the appropriate pages. Note that batch deletion is not affected by these settings and will delete items regardless of them.

See:

- [Deleting Communications](#)
- [Deleting Comments](#)
- [Deleting Checklists](#)

Enable New Features

<i>Field or Control</i>	<i>Description</i>
Enable Campus Community Fluid	<p>Select to indicate that fluid features for Campus Community self service has been adopted. This check box is for informational purposes only.</p> <p>See “Understanding PeopleSoft Fluid User Interface Homepages” (Campus Solutions Application Fundamentals).</p>

Reviewing or Defining Default Installation Settings for Name and Address Types

Access the Names / Addresses page (**Set Up SACR > Install > Campus Community Installation > Names / Addresses**).

This example illustrates the fields and controls on the Names / Addresses page. You can find definitions for the fields and controls later on this page.

Search/Match setup, Type Control functionality, various reports, and other functions throughout PeopleSoft Campus Solutions rely on values in the fields on this page, especially **Type of Name**, **Home Address Type**, and **Mailing Address Type**.

Names

<i>Field or Control</i>	<i>Description</i>
Type of Name	Select the name type that is the most important for your business processes to use as an individual's name.
Preferred Name Search	By default, this is not selected. If you select this, PEOPLE_SRCH will consider preferred name records as well as primary name records. Otherwise, only primary name records are included in the search results.

Addresses

<i>Field or Control</i>	<i>Description</i>
Home Address Type	Select the address type that is the most important for your business processes to use as an individual's home address.
Mailing Address Type	Select the address type that is the most important for your business processes to use as an individual's mailing address.

Related Links

[Setting Up Search/Match](#)

“Setting Up Type Control” (Campus Self Service)

(NZL) Reviewing or Defining Default Installation Settings for National Student Index Processing

Access the Extensions page (**Set Up SACR > Install > Campus Community Installation > Extensions**).

This example illustrates the fields and controls on the Extensions page. You can find definitions for the fields and controls later on this page.

The screenshot shows a web interface with three tabs: 'Installation Default - CC', 'Names / Addresses', and 'Extensions'. The 'Extensions' tab is active. Below the tabs is a header for 'New Zealand - National Student'. Underneath, there are three items: 'Provider Code' with a text box containing '7006', 'Current File Number' with a text box containing '105', and a checkbox labeled 'Enable Online NSI Processing' which is checked.

In addition to setting installation values for NSI in Campus Community, you must turn on New Zealand functionality for Student Administration on the Installation Student Administration page.

See “Selecting Country-Specific Features and Enabling CRM for Higher Education Feature” (Campus Solutions Application Fundamentals).

New Zealand – National Student

<i>Field or Control</i>	<i>Description</i>
Provider Code	Enter the code granted by Ministry of Education.
Current File Number	<p>This number is used to create a unique extract file name to send to NSI. It is also tied to all individuals whose data needs to be sent to NSI. NSI Suspense Table, the Extract, Load, Post NSI Data batch processes and the Purge NSI Suspense Table process use this number.</p> <hr/> <p>Note: Every time the Extract NSI Data process is run, this number increases by increments of one. See the Extracting NSI Data section for more information on how the file number works.</p> <hr/>

Field or Control	Description
Enable Online NSI Processing	<p>Your institution must inform the MOE of changes made to student records in your database that have an NSN. By selecting this check box, PeopleCode triggers an insert action in the NSI Suspense table every time you make a change to these student's records to either their first name, last name, middle names, gender, date of birth, residential status, or to the verification fields for name/DOB or residential status. Then, the next time the Extract NSI process runs, it will extract the changed records and submit them to MOE.</p> <hr/> <p>Note: You must select this check box if your institution is required to report changes to individual NSI records. Those records with changes are sent as part of the NSI process, Update Insert Request.</p>

Reviewing or Defining Installation Settings For Biographic Fields

If you select at least one field from this Biographic Fields page for inclusion, a **Personal** page is added to the **Add/Update a Person** page, allowing biographic fields to be secured independently of the rest of a person's data. Access to the personal page in the SCC_BIO_DEMO component is added to the HCCPCSSA1000 permission list. See [Adding or Updating Biographical Details Data](#).

Access the Biographic Details page (**Set Up SACR > Install > Campus Community Installation > Biographic Fields**).

The Biographic Fields page lists biographic fields for configuration- their inclusion, display, messages and labels.

Campus Community Installation

Installation Default - CC
Names / Addresses
Extensions
Notification Consumer Admin
Biographic Fields

Biographic Details

Field	Include Field	Display Only	Message Set	Message Number	Label	Include in Outgoing Messages	Update from Incoming Messages
Birth Gender	<input checked="" type="checkbox"/>	<input type="checkbox"/>	14060	300	Birth Gender	<input checked="" type="checkbox"/>	<input checked="" type="checkbox"/>
Gender Identity	<input checked="" type="checkbox"/>	<input type="checkbox"/>	14060	301	Gender Identity	<input checked="" type="checkbox"/>	<input checked="" type="checkbox"/>
Other Identity	<input checked="" type="checkbox"/>	<input type="checkbox"/>	14060	302	Other Identity		
Pronouns	<input checked="" type="checkbox"/>	<input type="checkbox"/>	14060	393	Pronouns	<input checked="" type="checkbox"/>	<input checked="" type="checkbox"/>
Other Pronouns	<input checked="" type="checkbox"/>	<input type="checkbox"/>	14060	306	Other Pronouns		
Sexual Orientation	<input checked="" type="checkbox"/>	<input type="checkbox"/>	14060	303	Sexual Orientation	<input checked="" type="checkbox"/>	<input checked="" type="checkbox"/>
Other Orientation	<input checked="" type="checkbox"/>	<input type="checkbox"/>	14060	304	Other Orientation		
Biographical Attribute 1	<input checked="" type="checkbox"/>	<input type="checkbox"/>	14060	309	Military Status		
Biographical Attribute 2	<input type="checkbox"/>	<input type="checkbox"/>					
Biographical Attribute 3	<input type="checkbox"/>	<input type="checkbox"/>					
Biographical Attribute 4	<input type="checkbox"/>	<input type="checkbox"/>					
Biographical Attribute 5	<input type="checkbox"/>	<input type="checkbox"/>					
Biographical Attribute 6	<input type="checkbox"/>	<input type="checkbox"/>					
Biographical Attribute 7	<input type="checkbox"/>	<input type="checkbox"/>					
Biographical Attribute 8	<input type="checkbox"/>	<input type="checkbox"/>					
Biographical Attribute 9	<input type="checkbox"/>	<input type="checkbox"/>					

Person Basic Sync

Regulatory Region United States

Field or Control	Description
Include Field	Select the check box to include it on the administration page. If selected, Message Set and Message Number become required values, and the default message for the field is displayed.
Display Only	Select this check box to make a field read-only for all users irrespective of their access. You can define some fields as Display Only while allowing other fields to be updated on the page. You can use it to allow users to view but not update values that students have added through self-service.

Field or Control	Description
Message Set and Message Number	<p>Default messages assigned to a field. You can update them, or customize message catalog entries and update default values.</p> <p>Default messages are not delivered with the Biographical Attribute fields.</p> <hr/> <p>Note: The same default messages appear in the Personal Details Configuration for the Fluid Biographic Details page.</p>
Label	<p>View the message text from the selected message. A maximum of 30 characters is recommended for labels.</p>
<p>Include in Outgoing Messages</p> <p>Update from Incoming Messages</p>	<p>The PERSON_BASIC_SYNC message uses the options you select to determine whether individual fields should be populated in outgoing messages or whether they should be updated with data from incoming messages.</p> <p>When you use these options, the Person Basic Sync region is enabled.</p> <p>In the message, these fields are included in PERS_DATA_EFFDT:</p> <ul style="list-style-type: none"> • SCC_BIRTH_GENDER as BIRTH_SEX • SCC_GENDER_ID as GENDER_IDENTITY • SCC_SEXUAL_ORI as SEXUAL_ORIENTATION • SCC_PRONOUNS as PRONOUN <hr/> <p>Note: To synchronize the data, the codes need to be the same for both the CS and HCM fields.</p>

By default, none of the fields are selected for inclusion.

For **Gender Identity**, **Sexual Orientation**, and **Preferred Pronouns**, you can choose to include a coded field that uses a list of translate values or an **Other** field that accepts free text or both. The text field appears on the page if you include both the coded field and text field, and select *Other* for the coded field.

If you want to use only the **Other** text fields, clear the **Include Field** for the coded field and use its associated delivered message for the text field instead. For example, you can clear **Include Field** for **Gender Identity** and include **Other Identity** while using the delivered message *14060,301* for Gender Identity.

Note: If only the **Other** text field is included, saving a text value causes the value of the coded field in the record to be set to Other (OT).

If a coded field (Gender Identity, Sexual Orientation, Preferred Pronouns) is set to *Display Only* and the corresponding text field (Other Identity, Other Orientation, Other Pronouns) is also being included, then the corresponding text field should also be set to *Display Only*.

Translate values of *Other*, *Prefer not to say* and *Unknown* are delivered for these fields:

- Birth Gender (SCC_BIRTH_GENDER)
- Gender Identity (SCC_GENDER_ID)
- Sexual Orientation (SCC_SEXUAL_ORI)
- Preferred Pronouns (SCC_PRONOUNS)

Institutions can create their own values to meet their data capture requirements. The Biographical Attribute fields (SCC_BIO_ATTRIB_1 to 9) are delivered with a single translate value *Unknown*. To use a Biographical Attribute field, institutions should add their own translate values as required and define a message catalog entry to be used as the field label.

Note: You can set up the Fluid Biographic Details page using Personal Details Configuration, which is separate from this configuration of the Personal administration page. For more information, see “Configuring Profile Information for PeopleSoft Fluid User Interface” (Campus Self Service).

Person Basic Sync

You have to fill out **Regulatory Region** if you set any field in **Include in Outgoing Messages**. The region you select determines the values that are included in outgoing messages. The lookup values for **Regulatory Region** are set up in **Set Up Common Objects > Install > Regulatory Region**.

Setting Up Additional Name Information

Note: If you implement PeopleSoft Campus Solutions (CS) *and* a separate instance of PeopleSoft Human Capital Management (HCM), read the relevant documentation about CS-HCM integration to understand the setup, functional, and technical implementation considerations. See:
“Integrating Person Data” (Campus Solutions Application Fundamentals)
“Integrating Setup Data” (Campus Solutions Application Fundamentals)
“Monitoring Integrations Using the Integrity Utility” (Campus Solutions Application Fundamentals)
Information Center: CS-HCM Integration for PeopleSoft Enterprise Campus Solutions in My Oracle Support (ID 2091799.2)

These topics discuss how to set up additional name information.

Pages Used to Set Up Additional Name Information

<i>Page Name</i>	<i>Definition Name</i>	<i>Navigation</i>	<i>Usage</i>
Name Format Table	NAME_FORMAT_TBL	Set Up Common Objects > Foundation Tables > Personal > Name Format Types > Name Format Table	<p>Define name format types and fields to use on name pages throughout CS.</p> <p>CS provides name format configurations that are preformatted and preparsed based on country. When you enter the format code on the Names page, the name fields are provided in the predefined format.</p> <p>There are 14 formats that you can edit. You can also add formats if required.</p>
Display Name Configuration	NAME_FORMAT_DSP	Set Up Common Objects > Foundation Tables > Personal > Name Format Types > Display Name Configuration	Configure the display name (NAME_DISPLAY) that appears throughout CS. This name is used in page headers.
Formal Name Configuration	NAME_FORMAT_FML	Set Up Common Objects > Foundation Tables > Personal > Name Format Types > Formal Name Configuration	Configure the individual's formal name (NAME_FORMAL field). This name can be used in correspondence/reporting.
PSFormat Name Configuration	NAME_FORMAT_PSF	Set Up Common Objects > Foundation Tables > Personal > Name Format Types > PSFormat Name Configuration	Configure the employee's PeopleSoft Name (NAME_PSF field). This name appears in search results.
Name Type Table	NAME_TYPE_TBL	Set Up Common Objects > Foundation Tables > Personal > Name Type > Name Type Table	Define name types and the order in which to use them.
Name Prefix Table	NAME_PREFIX_TABLE	Set Up Common Objects > Foundation Tables > Personal > Name Prefix > Name Prefix Table	Set up or review name prefixes.

Page Name	Definition Name	Navigation	Usage
Name Suffix Table	NAME_SUFFIX_TABLE	Set Up Common Objects > Foundation Tables > Personal > Name Suffix > Name Suffix Table	Set up or review name suffixes for prompting pages with names data. Alternatively, you can manually include the suffix after the individual's last name on those pages.
Royal Name Prefix	NM_ROYAL_PREFIX	Set Up Common Objects > Foundation Tables > Personal > Royal Name Prefix	Set up royal designations to precede a name.
Royal Name Suffix	NM_ROYAL_SUFFIX	Set Up Common Objects > Foundation Tables > Personal > Royal Name Suffix	Set up royal designations to follow a name.
Name Title	TITLE_TBL	Set Up Common Objects > Foundation Tables > Personal > Name Title	Set up titles to be included with names. Titles can be royal, political, religious, and so on.
Refresh Name Display	NAME_DISPLAY_RC	Set Up Common Objects > System Administration > Refresh Name Display Values	Refresh display name records with NAME_DISPLAY and NAME_FORMAL fields to reflect changes made to PeopleCode definition of those fields.

Understanding Additional Name Information

When you need to track a variety of names as part of your records, CS gives you the flexibility to define name formats and stores this information in the Name Format table.

For the Display Name, Formal Name, and PS Name, you can determine which name fields you want to use, the order in which they should appear, whether or not they are required, and any field labels, spaces, and separators. CS delivers 14 name formats but you can add or update the name formats to suit your needs.

Important! To have the system update names throughout the system, you should always run the Refresh Name Display process whenever you make a change to the Name Format Table components.

Defining Name Format Types and Fields

Access the Name Format Table page **Set Up Common Objects > Foundation Tables > Personal > Name Format Types > Name Format Table**).

This example illustrates the fields and controls on the Name Format Table page. You can find definitions for the fields and controls later on this page.

Name Format Types

Name Format Table
Display Name Configuration
Formal Name Configuration
PSFormat Name Configuration

Name Format Type 001 *Status Active

*Description English

*Short Description English

Application Class ID

Application Class Path

Name Fields

Personalize | Find | Print | Refresh

*Sequence Number	*Field Name	Field Label	Maintain Text Catalog	Required	Certified By	Autocomplete Attribute
1	NAME_PREFIX	Prefix	Maintain Text Catalog	<input type="checkbox"/>		HONORIFIC-PREFIX
2	FIRST_NAME	First Name	Maintain Text Catalog	<input checked="" type="checkbox"/>		GIVEN-NAME
3	MIDDLE_NAME	Middle Name	Maintain Text Catalog	<input type="checkbox"/>		ADDITIONAL-NAME
4	LAST_NAME	Last Name	Maintain Text Catalog	<input checked="" type="checkbox"/>		FAMILY-NAME
5	NAME_SUFFIX	Suffix	Maintain Text Catalog	<input type="checkbox"/>		HONORIFIC-SUFFIX
6	PREF_FIRST_NAME	Preferred First Name	Maintain Text Catalog	<input type="checkbox"/>		GIVEN-NAME
7	PREF_MIDDLE_NAME	Preferred Middle Name	Maintain Text Catalog	<input type="checkbox"/>		ADDITIONAL-NAME
8	PREF_LAST_NAME	Preferred Last Name	Maintain Text Catalog	<input type="checkbox"/>		FAMILY-NAME
9	PREF_NAME_PREFIX	Preferred Prefix	Maintain Text Catalog	<input type="checkbox"/>		HONORIFIC-PREFIX
10	PREF_NAME_SUFFIX	Preferred Suffix	Maintain Text Catalog	<input type="checkbox"/>		HONORIFIC-SUFFIX

First | 1-10 of 10 | Last

Add Name Field

Use this page to define name format types and fields that appear on name pages throughout CS. You can identify which fields are available for the format type, in what order they should be displayed for data entry, what labels are used, and whether or not a field is required.

Important! You should always run the [Refresh Name Display](#) process whenever you make changes in this component.

Field or Control	Description
Application Class ID and Application Class Path	Enter the application class ID and page of the application package, which store the path of the extension code. Basic name formatting and all name validation are in the PeopleCode application class HCR_NAME:NameFormat . When the basic formatting or validation is not enough for a particular name format, you can extend the class. PeopleSoft delivers extensions that are done for the <i>Chinese</i> , <i>German</i> , <i>Japanese</i> , <i>Mexican</i> and <i>Netherlands</i> name formats.
Sequence Number	Enter a numeric value to indicate the default order in which you want the name fields to appear on the data entry pages for names. By default, the system sets the first row to one and incrementally increases the value by one for each additional row that you insert.

Field or Control	Description
Field Name and Field Label	Select the name fields you want to display on the Name page for this format type. The field label is stored in the Text Catalog.
Maintain Text Catalog	To view or update the label, see “Defining Text Catalogs” (Campus Self Service). To change the label for one name format only, add a row in the Context Keys and Text area on the Maintain Text Catalog page and indicate the format and text for that format.
Required	Indicate whether this field is required to be entered for this name format. Users will not be able to save a name if this field is not entered.
Certified By	(DEU, NLD) Indicate the certifying authority for the Royal Name Prefix and Suffix fields. Valid values are defined on the Royal Name Prefix and Royal Name Suffix pages.
Autocomplete Attribute	Define a value that will be used for the autocomplete attribute on the HTML pages for name entries. This allows browsers to autopopulate the field.

Configuring the Display Name

Access the Display Name Configuration page (**Set Up Common Objects > Foundation Tables > Personal > Name Format Types > Display Name Configuration**).

This example illustrates the fields and controls on the Display Name Configuration page. You can find definitions for the fields and controls later on this page.

Name Format Table
Display Name Configuration
Formal Name Configuration
PSFormat Name Configuration

Name Format Type 001 Description English

Name Fields
Personalize | Find | First 1-6 of 6 Last

Field Label	Include in Display Name?	Position Number	Space Before?	Pre Separator	Post Separator	Display Type
Preferred First Name	<input checked="" type="checkbox"/>	1	<input type="checkbox"/>			
Last Name	<input checked="" type="checkbox"/>	2	<input checked="" type="checkbox"/>			
Prefix	<input type="checkbox"/>		<input type="checkbox"/>			
First Name	<input type="checkbox"/>		<input type="checkbox"/>			
Middle Name	<input type="checkbox"/>		<input type="checkbox"/>			
Suffix	<input type="checkbox"/>		<input type="checkbox"/>			

Formatted Name

Field Order Preferred First Name Last Name

Example Doug Lewis

Refresh Name

Use this page to configure how to display the name that appears throughout CS.

The fields that appear in the Name Fields group box are the ones you added on the [Name Format Table](#) page.

Important! You should always run the [Refresh Name Display](#) process whenever you make changes in this component.

<i>Field or Control</i>	<i>Description</i>
Include in Display Name	Select this check box to ensure that this field value displays when showing the individual's Display name (NAME_DISPLAY field). When you select this option, other fields on this row will become available.
Position Number	Enter a numeric value to indicate the order in which you want the name fields to appear on the formatted Display name page. By default, the system sets the first included field to one and incrementally increases the value by one for each additional field that is included.
Space Before	Select this check box to indicate that there should be a space before this name field. For example, if a name field displays after another field, you may want to ensure that there is a space between the field values by selecting this option.

Field or Control	Description
Pre Separator or Post Separator	Enter a character that should display before or after this field value. For example, if you are showing the name for a person in Japan, you can choose to enclose the alternate character name for the person in parenthesis.
Display Type	<p>For the Name Suffix, Name Prefix, Title, Name Royal Suffix, and Name Royal Prefix fields, the system enables you to select how to show the field value. Options include:</p> <ul style="list-style-type: none"> • <i>Long Description</i> • <i>Short Description</i> • <i>Value</i> <p>By default, <i>Value</i> is selected. This means that the actual code is used and will not be translated when it is included in the Display name, (e.g., <i>Mrs Jane Smith</i> will be displayed in English and also in French. If the <i>Short Description</i> or <i>Long Description</i> is selected, the translated value will be used. For example, a display name showing <i>Mister John Smith</i> in English would read <i>Monsieur John Smith</i> in French).</p>

Formatted Name

Field or Control	Description
Field Order	Displays the order based on Position Number.
Example	Shows a sample name based on Position Number.
Refresh Name	Click this button to have the Example field show how the name appears with the current settings.

Configuring the Formal Name

Access the Formal Name Configuration page (**Set Up Common Objects > Foundation Tables > Personal > Name > Format Types > Formal Name Configuration**).

This example illustrates the fields and controls on the Formal Name Configuration page. You can find definitions for the fields and controls later on this page.

The screenshot shows the 'Formal Name Configuration' page. At the top, there are navigation tabs: 'Name Format Table', 'Display Name Configuration', 'Formal Name Configuration' (selected), and 'PSFormat Name Configuration'. Below the tabs, the page title is 'Name Format Type 001' and the description is 'English'. The main section is titled 'Name Fields' and contains a table with the following columns: 'Field Label', 'Include in Formal Name?', 'Position Number', 'Space Before?', 'Pre Separator', 'Post Separator', and 'Display Type'. The table has six rows: 'Prefix', 'First Name', 'Last Name', 'Middle Name', 'Suffix', and 'Preferred First Name'. The 'Prefix', 'First Name', and 'Last Name' rows have 'Include in Formal Name?' checked and 'Space Before?' checked. The 'Middle Name', 'Suffix', and 'Preferred First Name' rows have both 'Include in Formal Name?' and 'Space Before?' unchecked. Below the table, there is a 'Formatted Name' section with 'Field Order' set to 'Name Prefix First Name Last Name' and an 'Example' of 'Mr Douglas Lewis'. A 'Refresh Name' button is located at the bottom of this section.

Field Label	Include in Formal Name?	Position Number	Space Before?	Pre Separator	Post Separator	Display Type
Prefix	<input checked="" type="checkbox"/>	1	<input type="checkbox"/>			Value
First Name	<input checked="" type="checkbox"/>	2	<input checked="" type="checkbox"/>			
Last Name	<input checked="" type="checkbox"/>	3	<input checked="" type="checkbox"/>			
Middle Name	<input type="checkbox"/>		<input type="checkbox"/>			
Suffix	<input type="checkbox"/>		<input type="checkbox"/>			
Preferred First Name	<input type="checkbox"/>		<input type="checkbox"/>			

Formatted Name

Field Order Name Prefix First Name Last Name

Example Mr Douglas Lewis

Refresh Name

Use this page to build the individual's formal name (NAME_FORMAL field). This name can be used in correspondence/reporting.

The setup for this page is similar to that on the [Display Name Configuration](#) page.

Important! You should always run the [Refresh Name Display](#) process when you make changes in this component.

Configuring the PeopleSoft Name

Access the PSFormat Name Configuration page (**Set Up Common Objects > Foundation Tables > Personal > Name > Format Types > PSFormat Name Configuration**).

This example illustrates the fields and controls on the PSFormat Name Configuration page. You can find definitions for the fields and controls later on this page.

Name Format Type 001 Description English

Name Fields Personalize | Find | [Print] [Grid] First 1-6 of 6 Last

Field Label	Include in PSFormat Name?	Position Number	Space Before?	Pre Separator	Post Separator	Display Type
Last Name	<input checked="" type="checkbox"/>	1	<input type="checkbox"/>			
Suffix	<input checked="" type="checkbox"/>	2	<input checked="" type="checkbox"/>			Value
Preferred First Name	<input checked="" type="checkbox"/>	3	<input checked="" type="checkbox"/>			
Middle Name	<input checked="" type="checkbox"/>	4	<input checked="" type="checkbox"/>			
Prefix	<input type="checkbox"/>		<input type="checkbox"/>			
First Name	<input type="checkbox"/>		<input type="checkbox"/>			

Formatted Name

Field Order Last Name Name Suffix Preferred First Name Middle Name

Example Lewis Jr. Doug Richard

Refresh Name

Use this page to build the employee's PeopleSoft Name (NAME field). This name appears in search results.

The NAME field uses the PeopleSoft Name field format, which automatically removes any spaces before and after the first comma that is included in the name. Because of this, there is no use selecting the **Space Before** option for a name component immediately following or preceding the first comma separator.

The setup for this page is similar to that on the [Display Name Configuration](#) page.

Important! You should always run the [Refresh Name Display](#) process when you make changes in this component.

Defining Name Types

Access the Name Type Table page (**Set Up Common Objects > Foundation Tables > Personal > Name Type > Name Type Table**).

This example illustrates the fields and controls on the Name Type Table page. You can find definitions for the fields and controls later on this page.

Name Type Table							
Name Type		Personalize	Find	View All	First	1-10 of 11	Last
Order by	Name Type CD	*Name Type			*Short Name		
1	PRI	Primary			Primary	+	
2	PRF	Preferred			Preferred	+	
3	LEG	Legal			Legal	+	-
4	DEG	Degree			Degree	+	-
5	MDN	Maiden			Maiden	+	-
6	OTH	Other			Other	+	-
7	FR2	Former2			Former2	+	-
8	FTR	Father			Father	+	-
9	FR1	Former1			Former1	+	-
10	MTR	Mother			Mother	+	-

Field or Control	Description
Order By	Enter the order in which the system should make this name type available.

You won't be able to delete or reorder the Primary and Preferred name types because they are system data.

If you make changes to this table, you should consider if you need to make changes to the corresponding description for the name type in FERPA Setup for the NAMES_FERPA_VW record table (Set Up SACR > Product Related > Campus Community > Establish People Processing > Setup > FERPA Control).

Defining Name Prefixes

Access the Name Prefix Table page (Set Up Common Objects > Foundation Tables > Personal > Name Prefix > Name Prefix Table).

This example illustrates the fields and controls on the Name Prefix Table page. You can find definitions for the fields and controls later on this page.

Name Prefix Table							
Name Prefix			Personalize	Find	First	1-6 of 6	Last
	*Name Prefix	Short Description	*Description				
1	<input type="text" value="Dr"/>	<input type="text" value="Dr"/>	<input type="text" value="Doctor"/>	<input type="button" value="+"/>	<input type="button" value="-"/>		
2	<input type="text" value="Miss"/>	<input type="text" value="Miss"/>	<input type="text" value="Miss"/>	<input type="button" value="+"/>	<input type="button" value="-"/>		
3	<input type="text" value="Mr"/>	<input type="text" value="Mr"/>	<input type="text" value="Mister"/>	<input type="button" value="+"/>	<input type="button" value="-"/>		
4	<input type="text" value="Mrs"/>	<input type="text" value="Mrs"/>	<input type="text" value="Mrs"/>	<input type="button" value="+"/>	<input type="button" value="-"/>		
5	<input type="text" value="Ms"/>	<input type="text" value="Ms"/>	<input type="text" value="Ms"/>	<input type="button" value="+"/>	<input type="button" value="-"/>		

Field or Control	Description
Name Prefix	<p>Enter a name prefix. When you enter names for people in the Campus Solutions Personal Information pages, you can reference these standard name prefixes.</p> <p>The system displays the prefixes you enter here as part of the person's name.</p>

Note: Name prefixes are not effective-dated, nor do they have a status associated with them.

Defining Name Suffixes

Access the Name Suffix Table page (**Set Up Common Objects > Foundation Tables > Personal > Name Suffix > Name Suffix Table**).

The fields on this page are similar to the fields on the Name Prefix page. Refer to the Defining Name Prefixes topic.

See [Defining Name Prefixes](#)

Defining Royal Name Prefixes

Access the Royal Name Prefix page (**Set Up Common Objects > Foundation Tables > Personal > Royal Name Prefix**).

This example illustrates the fields and controls on the Royal Name Prefix Table page. You can find definitions for the fields and controls later on this page.

Royal Name Prefix							
Certified By NEN							
Royal Name Prefix		Personalize	Find	View 100	First	1-15 of 223	Last
*Name Royal Prefix	*Status	Short Description	*Description				
1 'a	Active	'a	'a	+	-		
2 'd	Active	'd	'd	+	-		
3 'i	Active	'i	'i	+	-		
4 'l	Active	'l	'l	+	-		
5 's	Active	's	's	+	-		
6 't	Active	't	't	+	-		

Field or Control	Description
Certified By	The system displays the value you selected to access the page, such as <i>NEN</i> for Dutch prefixes.
Royal Name Prefix	Enter a Royal Name Prefix, using up to 15 characters.
Status as of Effective Date	Royal name prefixes are not effective-dated, so to retire a prefix code, change the status to <i>Inactive</i> .

Defining Royal Name Suffixes

Access the Royal Name Suffix page (**Set Up Common Objects > Foundation Tables > Personal > Royal Name Suffix**).

The fields on this page are similar to the fields on the Royal Name Prefix page.

See [Defining Royal Name Prefixes](#)

Refreshing Name Display Records

Access the Refresh Name Display page (**Set Up Common Objects > System Administration > Refresh Name Display Values**).

This example illustrates the fields and controls on the Refresh Name Display page. You can find definitions for the fields and controls later on this page.

Refresh Name Display

Run Control ID: NG01 Report Manager Process Monitor Run

Update All Name Formats? Name Format Type ▼

Use this page to Refresh display name records with NAME_DISPLAY and NAME_FORMAL fields to reflect changes made to PeopleCode definition of those fields.

<i>Field or Control</i>	<i>Description</i>
Update All Name Formats	By default, this check box selected. When this check box is selected, existing names for all formats (and all name types) are updated based on the Name Format Table configuration for the type.
Name Format Type	This field is enabled when Update All Name Formats is selected. You can select an active name format type. If you select a single name format, existing names for that format (for all name types) are updated based on the Name Format Table configuration for the type.

Defining Address Types

Note: If you implement Campus Solutions *and* a separate instance of PeopleSoft Human Capital Management, read the relevant documentation about CS-HCM integration to understand the setup, functional, and technical implementation considerations. See:

- “Integrating Person Data” (Campus Solutions Application Fundamentals)
- “Integrating Setup Data” (Campus Solutions Application Fundamentals)
- “Monitoring Integrations Using the Integrity Utility” (Campus Solutions Application Fundamentals)

Information Center: CS-HCM Integration for PeopleSoft Enterprise Campus Solutions in My Oracle Support (ID 2091799.2)

This topic discusses how to define address types.

Page Used to Define Address Types

<i>Page Name</i>	<i>Definition Name</i>	<i>Navigation</i>	<i>Usage</i>
Address Type Table	ADDR_TYPE_TBL	Set Up Common Objects > Foundation > Tables > Personal > Address Type > Address Type Table	Define address types and the tables in Personal use Address

Entering and Editing Address Types

Access the Address Type Table page (**Set Up Common Objects > Foundation > Tables > Personal > Address Type > Address Type Table**).

This example illustrates the fields and controls on the Address Type Table page. You can find definitions for the fields and controls later on this page.

Address Type Table				
Address Type Personalize Find View All 				
*Order by	Addr Type CD	Address Type	Short Type	
<input type="text" value="1"/>	HOME	Home	Home	<input type="button" value="+"/> <input type="button" value="-"/>
<input type="text" value="2"/>	MAIL	Mailing	Mail	<input type="button" value="+"/> <input type="button" value="-"/>
<input type="text" value="3"/>	BUSN	Business	Business	<input type="button" value="+"/> <input type="button" value="-"/>
<input type="text" value="4"/>	CHK	Check	Check	<input type="button" value="+"/> <input type="button" value="-"/>
<input type="text" value="5"/>	DORM	Dormitory	Dorm	<input type="button" value="+"/> <input type="button" value="-"/>
<input type="text" value="6"/>	LEGL	Legal	Legal	<input type="button" value="+"/> <input type="button" value="-"/>
<input type="text" value="7"/>	CAMP	Campus	Campus	<input type="button" value="+"/> <input type="button" value="-"/>
<input type="text" value="8"/>	OTH	Other	Other	<input type="button" value="+"/> <input type="button" value="-"/>
<input type="text" value="9"/>	BILL	Billing	Billing	<input type="button" value="+"/> <input type="button" value="-"/>
<input type="text" value="10"/>	OTH2	Other 2	Other 2	<input type="button" value="+"/> <input type="button" value="-"/>

<i>Field or Control</i>	<i>Description</i>
Order By	Enter the order in which the system should make this address available.

Note: You cannot edit the Home, Mailing, Business, Check, Billing, and Other 2 address types because they are system data.

Administering Country Codes

Note: If you implement Campus Solutions *and* a separate instance of PeopleSoft Human Capital Management, read the relevant documentation about CS-HCM integration to understand the setup, functional, and technical implementation considerations. See:
“Integrating Person Data” (Campus Solutions Application Fundamentals)
“Integrating Setup Data” (Campus Solutions Application Fundamentals)
“Monitoring Integrations Using the Integrity Utility” (Campus Solutions Application Fundamentals)
Information Center: CS-HCM Integration for PeopleSoft Enterprise Campus Solutions in My Oracle Support (Doc ID 2091799.2)

These topics provide an overview of country codes and discuss how to:

- Update country information.
- Define address formats.
- Specify the display and print format.
- Modify search values.
- Add states or provinces.

Understanding Country Codes

On many pages in PeopleSoft Campus Solutions, a country appears as part of the address, such as for a person or school.

Countries are represented as codes, such as CAN for Canada, and they are listed in the Country Table component. In the Country field on any page, the system displays a default country code, which you can change. The Org Defaults by Permission List component and the Business Unit Options Defaults component (BUS_UNIT_OPT_HR) can affect this default code.

You can define the information that users should capture for addresses in specific countries using the Country Address Format page (ADDRESS_TABLE).

The Country Table page includes an extensive list of predefined countries and codes. The Country Address Format component maintains the address field layout for each country.

You can exclude countries and states with their respective codes from Address prompts in accordance with the current ISO list. For example, Yugoslavia (YUG) and Netherlands Antilles (ANT) have been removed from the list. For more information, see “Excluding Country and State Values from Addresses” in “Configuring Profile Information for PeopleSoft Fluid User Interface” (Campus Self Service).

If you need to, a new country code can be added to the Country Table and the appropriate address format setup in Country Address Format.

Pages Used to Administer Country Codes

<i>Page Name</i>	<i>Definition Name</i>	<i>Navigation</i>	<i>Usage</i>
Country Table	COUNTRY_DEFN	Set Up Common Objects > Install > Country Table	Review or update country descriptions and codes.
Entry and Validation	ADDR_FORMAT_TABLE	Set Up Common Objects > Install > Country Address Format > Entry and Validation	Define address fields and validation for a country.
Display and Print	ADDR_FORMAT_DISP	Set Up Common Objects > Install > Country Address Format > Display and Print	Specify the address format for the country that's selected from the Country Table.
Search Values	EO_ADDR_VALIDAT	Set Up Common Objects > Install > Country Address Format > Search Values	Modify valid address values for the country.
State or Province Table	STATE_DEFN	Set Up Common Objects > Install > State/Province > State or Province Table	Add a state, province or equivalent entity for the country that is selected from the Country Table.

Updating Country Information

Access the Country Description page (**Set Up Common Objects > Install > Country Table**).

<i>Field or Control</i>	<i>Description</i>
2-Char Country Code (two-character country code)	Enter the code if applicable.
EU Member State (European Union member state)	Select if this is an EU member state.

Defining Address Formats

Access the Entry and Validation page (**Set Up Common Objects > Install > Country Address Format > Entry and Validation**).

This example illustrates the fields and controls on the Entry and Validation page without address search enabled and not using the dynamic page. You can find definitions for the fields and controls later on this page.

Entry and Validation | Display and Print

Country USA United States

*Address Page Name EO_ADDR_USA_SEC Secondary page for USA

Address Search ?

Enable Address Search

Enable Search Validation

Search Limit 0

Address Fields		Personalize Find [?] [X]		First	1-8 of 8	Last
Field Name	Label Override	Autocomplete Attribute	*Maximum Field Length	Required		
COUNTRY	<input type="text"/>	<input type="text"/>		<input type="checkbox"/>		
ADDRESS1	<input type="text"/>	ADDRESS-LINE1	55	<input checked="" type="checkbox"/>		
ADDRESS2	<input type="text"/>	ADDRESS-LINE2	55	<input type="checkbox"/>		
ADDRESS3	<input type="text"/>	ADDRESS-LINE3	55	<input type="checkbox"/>		
CITY	<input type="text"/>	ADDRESS-LEVEL2	30	<input checked="" type="checkbox"/>		
STATE	<input type="text"/>	ADDRESS-LEVEL1	6	<input checked="" type="checkbox"/>		
POSTAL	<input type="text"/>	POSTAL-CODE	12	<input checked="" type="checkbox"/>		
COUNTY	<input type="text"/>	<input type="text"/>	30	<input type="checkbox"/>		

Country Address Validation

Class Path EO:CA:ADDRVAL

Class ID USA

Class Method ValidateAddress

This example illustrates the fields and controls on the Entry and Validation page with address search enabled and not using the dynamic page.

Entry and Validation | Display and Print | Search Values

Country USA United States

*Address Page Name EO_ADDR_USA_SEC Secondary page for USA

Address Search ?

Enable Address Search

Enable Search Validation

Search Limit 0

Address Fields		Personalize Find [?] [X]		First	1-8 of 8	Last
Field Name	Label Override	Autocomplete Attribute	*Maximum Field Length	Required	Used in Search	
COUNTRY	<input type="text"/>	<input type="text"/>		<input checked="" type="checkbox"/>	<input checked="" type="checkbox"/>	
ADDRESS1	<input type="text"/>	ADDRESS-LINE1	55	<input checked="" type="checkbox"/>	<input type="checkbox"/>	
ADDRESS2	<input type="text"/>	ADDRESS-LINE2	55	<input type="checkbox"/>	<input type="checkbox"/>	
ADDRESS3	<input type="text"/>	ADDRESS-LINE3	55	<input type="checkbox"/>	<input type="checkbox"/>	
CITY	<input type="text"/>	ADDRESS-LEVEL2	30	<input checked="" type="checkbox"/>	<input checked="" type="checkbox"/>	
STATE	<input type="text"/>	ADDRESS-LEVEL1	6	<input checked="" type="checkbox"/>	<input checked="" type="checkbox"/>	
POSTAL	<input type="text"/>	POSTAL-CODE	12	<input checked="" type="checkbox"/>	<input checked="" type="checkbox"/>	
COUNTY	<input type="text"/>	<input type="text"/>	30	<input type="checkbox"/>	<input type="checkbox"/>	

Country Address Validation

This example illustrates the fields and controls on the Entry and Validation page using the dynamic page without valid address set up.

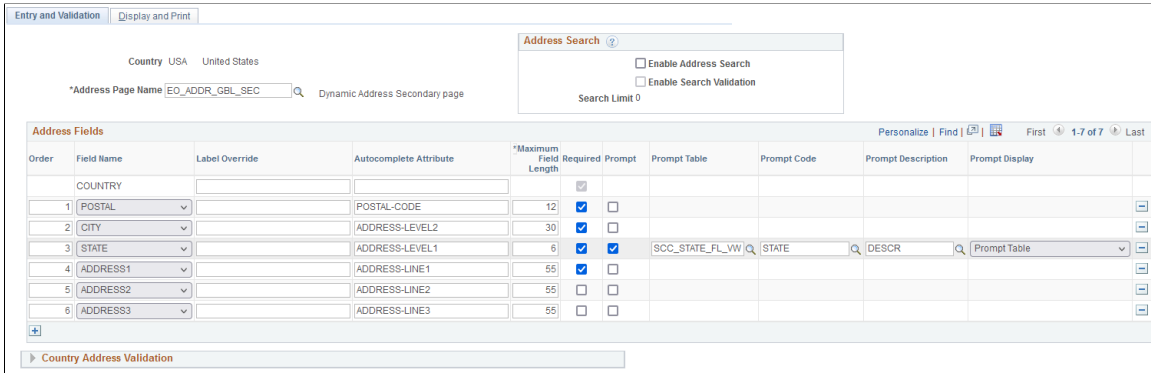

This example illustrates the fields and controls on the Entry and Validation page using the dynamic page with search value and valid address set up.

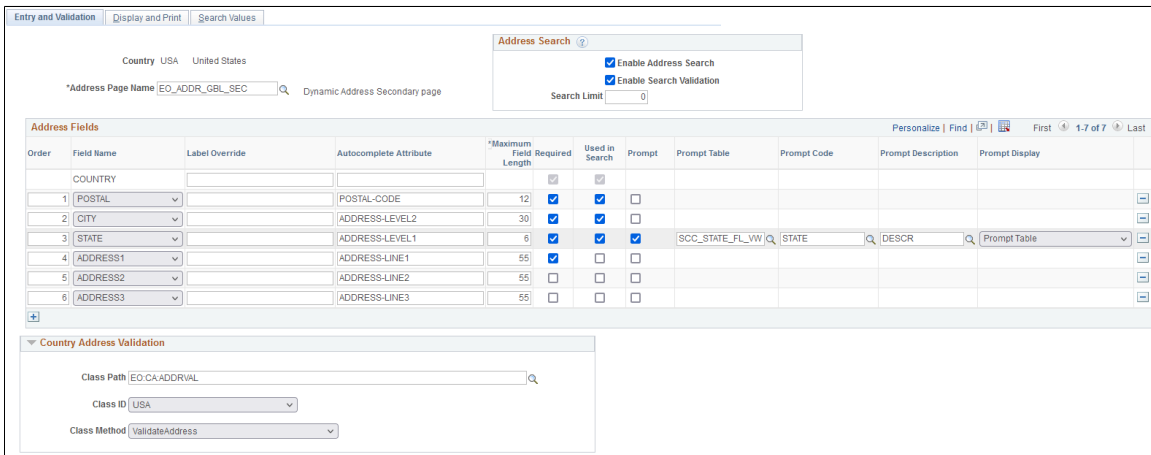

Use this page to specify address fields and validation for a country.

Field or Control	Description
Address Page Name	<p>Select an address page from the list of available options. The system will display the list of fields on that page in the Address Fields table.</p> <p>For Country records without address formats in Campus Solutions, you can select either the Address Entry - Dynamic page (EO_ADDR_GBL_SEC) or one of the existing pages to populate the address fields.</p>

Address Search

This group is available for all countries to give you the option to set up search values and valid address.

Field or Control	Description
Enable Address Search	If you select this, the Search Values page is enabled, and the other fields in Address Search are enabled. Used in Search appears in the Address Fields table.
Enable Search Validation	This is enabled only when you select <i>Enable Address Search</i> . If you select this, addresses are validated against Search Values. A warning appears when a match isn't found.
Search Limit	This is enabled only when you select <i>Enable Address Search</i> . If you define a value, that value is used to limit the number of search results in the address lookup.

Address Fields

These fields are available for all address page types, unless otherwise indicated. Here you will see the address fields that are available based on the **Address Page Name** you select.

If you select *Address Entry - Dynamic page (EO_ADDR_GBL_SEC)*, this table is populated based on the fields currently defined for the country. If you select the dynamic page for a country that doesn't have any format fields, the Address Fields table will initially be empty. But you can add fields as you need them.

Field or Control	Description
Order	This appears only for the dynamic page. You can change the order of the fields except for Country, which is always displayed first.
Field Name	This displays the address format fields for the country. For the dynamic page, there's a drop-down list to change the field. For other pages, the values are read-only.
Label Override	Enter a different label to override the default field label, if required for this country.
Autocomplete Attribute	The attributes defined here are applied to self-service pages when users enter a new address. This allows some web browsers to automatically fill in address fields when users enter an address based on the values the user saved in the browser settings.

Field or Control	Description
Maximum Field Length	This appears for all pages to let you set dynamic field sizing. For existing formats, this value is populated and defaults to the maximum number of characters available for a field, if a field is added.
Required	This appears for all pages. For Country, this check box is selected and is read-only. You can select this for other fields as required.
Used in Search	Available only when you select <i>Enable Address Search</i> . The fields you select appear on the Search Values page. For Country, this check box is selected by default and is read-only.
Prompt	This appears only for the dynamic page. Select this if you want to definite a prompt for any address field. The prompt table setup is delivered for STATE for countries that have delivered values in the State Table.
Prompt Table	This is enabled and required if you select <i>Prompt</i> .
Prompt Code Prompt Description Prompt Display	These are enabled if you select <i>Prompt</i> and provide a value in Prompt Table.
Delete Add	These appear only for the dynamic page.

Country Address Validation

You can extend or overwrite the delivered methods or add validation for a country that doesn't have a delivered validation.

Field or Control	Description
Class Path	The delivered app package is EO:CA:ADDVAL.
Class ID	Enter the name of the application class that contains the method to be invoked.

Field or Control	Description
Class Method	Enter the name of the method to be invoked. The framework uses the ValidateAddress method for the delivered classes.

Specifying the Display and Print Format

Access the Display and Print page (Set Up Common Objects > Install > Country Address Format > Display and Print).

This example illustrates the fields and controls on the Display and Print page. You can find definitions for the fields and controls later on this page.

Country CHE Switzerland

Field Name	Include in Display	Include in Print	Line Number	Position Number	Use Description	Pre Separator	Post Separator
COUNTRY	<input type="checkbox"/>	<input type="checkbox"/>			<input type="checkbox"/>		
ADDRESS1	<input checked="" type="checkbox"/>	<input checked="" type="checkbox"/>	1	1	<input type="checkbox"/>		
ADDRESS2	<input checked="" type="checkbox"/>	<input checked="" type="checkbox"/>	2	1	<input type="checkbox"/>		
ADDRESS3	<input checked="" type="checkbox"/>	<input checked="" type="checkbox"/>	3	1	<input type="checkbox"/>		
ADDRESS4	<input checked="" type="checkbox"/>	<input checked="" type="checkbox"/>	4	1	<input type="checkbox"/>		
POSTAL	<input checked="" type="checkbox"/>	<input checked="" type="checkbox"/>	5	1	<input type="checkbox"/>		
CITY	<input checked="" type="checkbox"/>	<input checked="" type="checkbox"/>	5	2	<input type="checkbox"/>		
STATE	<input checked="" type="checkbox"/>	<input checked="" type="checkbox"/>	6	1	<input checked="" type="checkbox"/>		

Formatted Address Samples

Display Address: ADDRESS1, ADDRESS2, ADDRESS3, ADDRESS4, POSTAL CITY, Canton

Print Address: ADDRESS1, ADDRESS2, ADDRESS3, ADDRESS4, POSTAL CITY, Canton

Refresh

Use this page to specify the display and print address formats for the country that you selected from the Country Table.

Field or Control	Description
Field Name	Displays the available address fields.
Include in Display	Select to include this field when an address appears in read-only mode. If your organization wants to display addresses in a format that's different from how addresses appear during data entry, then deselect the check box to exclude a particular field.
Include in Print	Select to print this field whenever an address in this country is printed.
Line Number	Enter the line on the page on which this field should appear.

Field or Control	Description
Position Number	Indicate this field's position in the selected line.
Use Description	Select to display a full description for this field instead of code, where applicable.
Pre Separator and Post Separator	Enter separator characters for the address elements if applicable. For example, use an em dash.

Formatted Address Samples

This section displays how the address appears online and in print format using the current settings.

Field or Control	Description
Refresh	Click to update the display according to your current settings. The samples use the field's description (e.g. State) if you select <i>Use Description</i> . Otherwise, it uses the field name.

Modifying Search Values

Access the Search Values page (**Set Up Common Objects > Install > Country Address Format > Search Values**).

This example illustrates the fields and controls on the Search Values page. You can find definitions for the fields and controls later on this page.

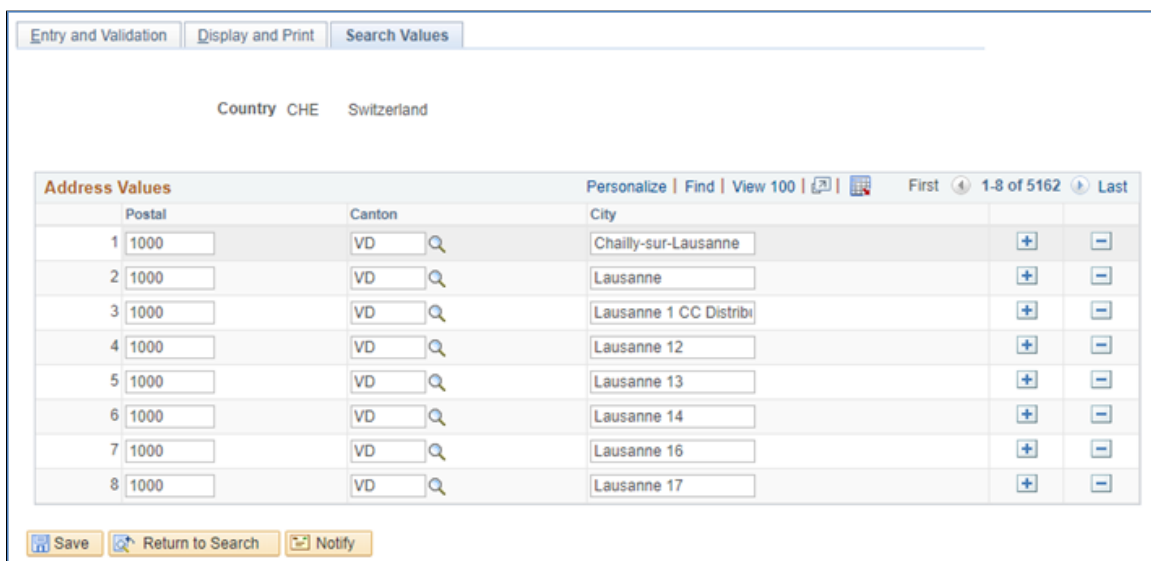

Use this page to make corrections, deletions, or incremental additions to specify the valid address values for the country.

A **Find Address** link appears on the Address and Edit Address fluid pages if you selected **Enable Address Search** on the Entry and Validation page *and* at least one value is supplied in Search Values.

As delivered, this page is populated for Japan, Switzerland, Italy, and the Netherlands.

Address Values

When you select **Enable Search Validation** on the Entry and Validation page, address entries are checked against the values stored on this page to verify that the search address fields match. You can also use this to add valid combinations of address fields.

Adding States or Provinces

Access the State or Province Table page (**Set Up Common Objects > Install > State/Province > State/Province Table**).

Campus Solutions delivers the State/Province table with all states, provinces, and equivalent geographical entities for all supported countries. The codes are based on standard postal codes. You can add codes for other countries as necessary.

You use this information in many address fields in the system.

Field or Control	Description
Postal Abbreviation	The state or province code is automatically displayed.
Numeric Code	Enter the numeric code, if applicable. The U.S. federal government assigns a numeric code to each state for reporting purposes. You do not need to enter numeric codes for new Canadian provinces.

Defining National ID Types

Note: If you implement Campus Solutions *and* a separate instance of PeopleSoft Human Capital Management, read the relevant documentation about CS-HCM integration to understand the setup, functional, and technical implementation considerations. See:

- “Integrating Person Data” (Campus Solutions Application Fundamentals)
- “Integrating Setup Data” (Campus Solutions Application Fundamentals)
- “Monitoring Integrations Using the Integrity Utility” (Campus Solutions Application Fundamentals)

Information Center: CS-HCM Integration for PeopleSoft Enterprise Campus Solutions in My Oracle Support (Doc ID 2091799.2)

This topic provides an overview of national ID types and discusses how to assign a national ID type to a country code.

Understanding National ID Types

Use the National ID Type page to assign a national ID type to a country code and provide a default or a dummy national ID for a country to use when a person or applicant ID is unavailable.

Many countries track some form of national ID. Each type of national ID has unique formatting requirements. The PeopleSoft Campus Solutions application delivers the National ID Type table with the appropriate types for supported countries.

When you select a country code on a page where you are entering a national ID, the system refers to the information defined on this page to enter a default national ID type (if selected) or to ensure that you select a valid one. The system also validates the national ID you enter against the format you specify here. If you do not enter the correct number of digits or letters for a country's national ID, the system displays a warning message.

Note: The initial two characters of a National Insurance Number for the United Kingdom (GBR) are validated against prefix values listed on the NID PREFIX GBR page (**Set Up Common Objects > Install > Product and Country Specific > NID Prefix GBR**). For more information, see *PeopleSoft HCM: Application Fundamentals*, “NID Prefix GBR page”.

Note: Application pages containing the National ID field perform an additional system check to determine the proper display by referring to the User Defined File (UDF) format. Specify these formats in PeopleSoft Application Designer.

Note: (CAN and USA) The delivered national ID type for Canada and the United States is *PR* (which corresponds to the Canadian Social Insurance Number and the American Social Security Number, respectively). You cannot delete this value.

Page Used to Define National ID Type

<i>Page Name</i>	<i>Definition Name</i>	<i>Navigation</i>	<i>Usage</i>
National ID Type Table	NID_TYPE_TABLE	Set Up Common Objects > Foundation Tables > Personal > National ID Type > National ID Type Table	Define or review default National ID values for a country.

Assigning National ID Types

Access the National ID Type Table page (**Set Up Common Objects > Foundation Tables > Personal > National ID Type > National ID Type Table**).

This example illustrates the fields and controls on the National ID Type Table page. You can find definitions for the fields and controls later on this page.

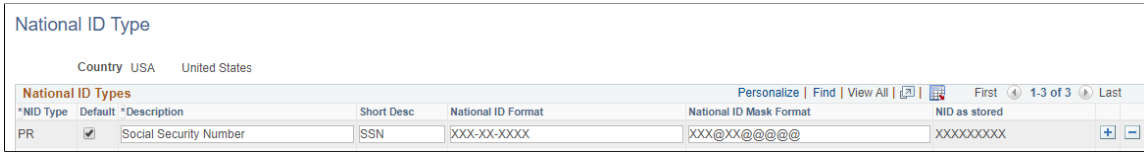

Field or Control	Description
NID Type (National ID type)	<p>Enter the types of national IDs you will use to identify individuals.</p> <p>If you do not require a national ID type for a country, create a value of <i>NO</i> and leave the National ID Format field blank. National ID Type is often a required field on other Campus Solutions pages and this gives you a value to enter for individuals from this particular country.</p>
Default	<p>Select to have the system use this NID Type as the default national ID type for individuals from this country. You do not have to designate a default national ID type for a country but without a designated default, users must specify a type every time they enter a national ID in the system.</p>
National ID Format	<p>Indicate the default format for the national ID. Use the following values:</p> <ul style="list-style-type: none"> • <i>X</i> or <i>Z</i> when the user can enter an alphanumeric or blank value. • <i>A</i> and any lower case letter when the user must enter a letter. • <i>9</i> when the user must enter a numeric value. • If you leave this field blank, users can enter any value (or no value at all) for this national ID type. <hr/> <p>Note: In addition to the general formatting that you set up here, PeopleCode record logic performs special data validation on BEL, BRA, CAN, CHE, FRA, GBR, MEX, NLD, USA, DEU, ESP, MYS, and ITA national IDs.</p>

Field or Control	Description
National ID Mask Format	<p>Indicate the format for masking the National ID, in the following manner:</p> <ul style="list-style-type: none"> • X, to indicate the characters that should be masked • @, to indicate the characters that should not be masked <p>For example, if someone’s National ID is 123-45-6789 and the masking format is XXX@XX@@@@, the ID is displayed as XXX-XX-6789.</p> <p>The length of the mask format must be equal to the length of the National ID.</p>
NID as Stored (National ID as stored)	Shows how the NID is stored in the system. Match this value to the field display formats in Application Designer.

Related Links

[Adding or Updating Biographical Details Data](#)

Setting Up and Reviewing Regulatory Regions

This topic discusses how to set up regulatory regions.

Note: If you implement Campus Solutions *and* a separate instance of PeopleSoft Human Capital Management, read the relevant documentation about CS-HCM Integration to understand the setup, functional, and technical implementation considerations.

See:

“Integrating Person Data” (Campus Solutions Application Fundamentals)

“Integrating Setup Data” (Campus Solutions Application Fundamentals)

“Monitoring Integrations Using the Integrity Utility” (Campus Solutions Application Fundamentals)

Information Center: CS-HCM Integration for PeopleSoft Enterprise Campus Solutions in My Oracle Support (Doc ID 2091799.2)

Page Used to Set Up and Review Regulatory Regions

<i>Page Name</i>	<i>Definition Name</i>	<i>Navigation</i>	<i>Usage</i>
Regulatory Region	REG_REGION	Set Up Common Objects > Install > Regulatory Region	<p>Define or review regulatory region descriptions and security access.</p> <p>Campus Solutions provides predefined regulatory regions for Canada, the United States, Canadian provinces, and other areas. Use this page to set up <i>additional</i> regulatory regions.</p>

Setting Up Regulatory Regions

Access the Regulatory Region page (**Set Up Common Objects > Install > Regulatory Region**).

This example illustrates the fields and controls on the Regulatory Region page. You can find definitions for the fields and controls later on this page.

The screenshot shows the 'Regulatory Region' page with the following fields and controls:

- Regulatory Region:** AUS
- *Description:** Australia
- Country:** AUS (with a search icon) and Australia
- Security Access:** Available to All (dropdown menu)
- Default Record Group SetIDs:**
 - SetID: AUS (with a search icon) and Australia
 - OR
 - Clone from Existing Regulatory Region: (empty text box)

Regulatory regions are used to set up ethnic groups, and later when you enter ethnicity data for a student.

See:

- [Defining Ethnic Groups](#)
- [Entering Ethnicity Information](#)

<i>Field or Control</i>	<i>Description</i>
Country	<p>Select a country.</p> <p>When you create a regulatory region, you must specify the country to which the region belongs. This enables country-specific edits even when a state-level or provincial-level region is used in a system transaction. If the country you want to add is not in the list of values, add that country to the system using the Country Table.</p>
Security Access	<ul style="list-style-type: none"> • Available To All: Users can select this region. • Not Available To Anyone: No users can select this region. • With Global Security Only: Only users who have access to that region's country functionality assigned to their primary permission list can select that region. <hr/> <p>Note: If you choose not to maintain the country-level data security, then select Available To All or Not Available To Anyone to provide universal access to regulatory regions. To simplify maintenance, availability is established only once for each regulatory region and is used for all transactions.</p> <hr/>

Default Record Group Set IDs

Use this group box to specify the set IDs that make up this regulatory region. Since regulatory region is used to drive set processing in some applications, regulatory region is a set control value. The default record group set IDs establish an initial set processing relationship for this new regulatory region.

<i>Field or Control</i>	<i>Description</i>
Set ID	<p>When you add a regulatory region, the Set ID field is enabled, and the Clone From Existing Regulatory Region field is disabled. Campus Solutions sets a default ID in the set ID field that is the same as the regulatory region code that you just defined. If you have not defined a set ID that matches this code, select another applicable ID for your regulatory region from the list of valid values. The set IDs in the list were set up using the TableSetID table. You can select only from those IDs.</p> <hr/> <p>Note: Before you can specify set IDs, you must define set IDs, record groups, set control values, and TableSet record group controls, using the components in the PeopleTools > Utilities > System Administration menu.</p> <hr/>

<i>Field or Control</i>	<i>Description</i>
Clone from Existing Regulatory Region	<p>You can clone the set IDs attached to this new regulatory region from an existing regulatory region. Use this option if the new regulatory region that you are defining requires the same default record group set IDs as those that you have already created for another region.</p> <p>Enter the regulatory region that you want to clone.</p>

Setting Up Holiday Schedules

This topic discusses how to define holiday schedules.

Note: If you implement Campus Solutions *and* a separate instance of PeopleSoft Human Capital Management, read the relevant documentation about CS-HCM Integration to understand the setup, functional, and technical implementation considerations.

See:

“Integrating Person Data” (Campus Solutions Application Fundamentals)

“Integrating Setup Data” (Campus Solutions Application Fundamentals)

“Monitoring Integrations Using the Integrity Utility” (Campus Solutions Application Fundamentals)

Information Center: CS-HCM Integration for PeopleSoft Enterprise Campus Solutions on My Oracle Support (Doc ID 2091799.2)

Page Used to Set Up Holiday Schedules

<i>Page Name</i>	<i>Definition Name</i>	<i>Navigation</i>	<i>Usage</i>
Holiday Schedule	HOLIDAY_SCHED_TBL	Set Up Common Objects > Foundation Tables > Organization > Holiday Schedule	Define holiday schedules.

Defining Holiday Schedules

Access the Holiday Schedule page (**Set Up Common Objects > Foundation Tables > Organization > Holiday Schedule**).

This example illustrates the fields and controls on the Holiday Schedule page.

Holiday Schedule

Holiday Schedule: PSS

Schedule Information

*Description:

Short Description:

Holiday Details Personalize | Find | View 100 | | First 180-186 of 186 Last

*Holiday	Description	Number of Hours	Holiday Type	Start Time	Time End	
03/19/2015	Spring Break	24.00	Standard			
05/25/2015	Memorial Day	24.00	Standard			
07/03/2015	Independence Day	24.00	Standard			
09/07/2015	Labor Day	24.00	Standard			
11/26/2015	Thanksgiving Day	24.00	Standard			
11/27/2015	Thanksgiving Holiday	24.00	Standard			

You can define as many holiday schedules as you need.

Holiday schedules that you define here are available in the Holiday Schedule field on the Term Table page (**Set Up SACR > Foundation Tables > Term Setup > Term/Session Table > Term Table**).

Related Links

“Defining Terms, Sessions, and Session Time Periods” (Campus Solutions Application Fundamentals)

Defining Citizen Status Codes

Note: If you implement Campus Solutions *and* a separate instance of PeopleSoft Human Capital Management, read the relevant documentation about CS-HCM integration to understand the setup, functional, and technical implementation considerations. See:

“Integrating Person Data” (Campus Solutions Application Fundamentals)

“Integrating Setup Data” (Campus Solutions Application Fundamentals)

“Monitoring Integrations Using the Integrity Utility” (Campus Solutions Application Fundamentals)

Information Center: CS-HCM Integration for PeopleSoft Enterprise Campus Solutions on My Oracle Support (Doc ID 2091799.2)

This topic discusses how to define citizenship statuses.

Page Used to Define Citizenship Status

<i>Page Name</i>	<i>Definition Name</i>	<i>Navigation</i>	<i>Usage</i>
Citizen Status Table	CITIZEN_STATUS	Set Up Common Objects > Foundation Tables > Personal > Citizen Status > Citizen Status Table	Define codes for country citizenship.

Defining Citizenship Status

Access the Citizen Status Table page (**Set Up Common Objects > Foundation Tables > Personal > Citizen Status > Citizen Status Table**).

This example illustrates the fields and controls on the Citizen Status Table page. You can find definitions for the fields and controls later on this page.

Citizen Status Table

Country USA United States

Country Citizenship Definition
Personalize | Find | View All | |
First 1-8 of 9 Last

	*Status	*Description	Short Description		
1	1	Native	Native	+	-
2	2	Naturalized	Naturaliz.	+	-
3	3	Alien Permanent	Alien Perm	+	-
4	4	Alien Temporary	Alien Temp	+	-
5	5	Permanent Resident	Resident	+	-
6	6	Employment Visa	Work VISA	+	-
7	7	Canadian Citizen	Canadian	+	-
8	8	Other	Other	+	-

<i>Field or Control</i>	<i>Description</i>
Country	The system displays the country code that you entered to access the page. Define citizenship status codes for this country.
Status	Enter the citizenship status code that you want to define. Enter as many citizenship codes as needed.

Related Links

[Entering Citizenship Data](#)

Defining Ethnic Groups

Note: If you implement Campus Solutions *and* a separate instance of PeopleSoft Human Capital Management, read the relevant documentation about CS-HCM integration to understand the setup, functional, and technical implementation considerations. See:
 “Integrating Person Data” (Campus Solutions Application Fundamentals)
 “Integrating Setup Data” (Campus Solutions Application Fundamentals)
 “Monitoring Integrations Using the Integrity Utility” (Campus Solutions Application Fundamentals)
 Information Center: CS-HCM Integration for PeopleSoft Enterprise Campus Solutions on My Oracle Support (Doc ID 2091799.2)

This topic discusses how to define ethnic groups.

Page Used to Define Ethnic Groups

Page Name	Definition Name	Navigation	Usage
Ethnic Groups	ETHNIC_GROUP_TBL	Set Up Common Objects > Product Related > Workforce Administration > Ethnic Groups	Define ethnic groups.

Defining Ethnic Groups

Access the Ethnic Groups page (**Set Up Common Objects > Product Related > Workforce Administration > Ethnic Groups**).

This example illustrates the fields and controls on the Ethnic Groups page. You can find definitions for the fields and controls later on this page.

<i>Field or Control</i>	<i>Description</i>
Ethnic Category	<p>Select the category with which you want to associate the ethnic group. You can associate many ethnic groups with the same ethnic category.</p> <p>Ethnic Category is enabled only for certain regulatory regions (AUS, HKG, HXUSA, MYS, SGP and USA).</p> <p>PeopleSoft delivers some ethnicity groups predefined and associated with U.S. recognized ethnic group categories. These categories are translate values. Do not modify these delivered values. Modifications to these translate values could require substantial programming effort. You can, however, create additional ethnic groups and associate them with existing ethnic categories to reflect the diverse ethnicities that comprise your campus community.</p>

Related Links

[Setting Up Personal Attributes](#)

[Entering Ethnicity Information](#)

Defining Supporting Documents

This section discusses how to define supporting documents.

Page Used to Define Supporting Documents

<i>Page Name</i>	<i>Definition Name</i>	<i>Navigation</i>	<i>Usage</i>
Supporting Documents	SUPPORT_DOC_TABLE	Set Up Common Objects > Common Definitions > Letters and Documents > Supporting Documents	Define identification codes for documents, such as birth certificates, that are required to obtain I-9 verification for individuals.

Related Links

[Entering Citizenship Data](#)

Defining Visas and Permits

Note: If you implement Campus Solutions *and* a separate instance of PeopleSoft Human Capital Management, read the relevant documentation about CS-HCM integration to understand the setup, functional, and technical implementation considerations. See:

- “Integrating Person Data” (Campus Solutions Application Fundamentals)
- “Integrating Setup Data” (Campus Solutions Application Fundamentals)
- “Monitoring Integrations Using the Integrity Utility” (Campus Solutions Application Fundamentals)

Information Center: CS-HCM Integration for PeopleSoft Enterprise Campus Solutions on My Oracle Support (Doc ID 2091799.2)

This section discusses how to set up visa and permit data.

Page Used to Define Visa and Permit Data

<i>Page Name</i>	<i>Definition Name</i>	<i>Navigation</i>	<i>Usage</i>
Visa/Permit Table	VISA_PERMIT_TABLE	Set Up Common Objects > Product Related > Workforce Administration > Visas/Permits > Visa/Permit Table	Define codes for visas and permits required for non-citizens and their dependents.

Setting Up Visa and Permit Data

Access the Visa/Permit Table page (**Set Up Common Objects > Product Related > Workforce Administration > Visas/ Permits > Visa/Permit Table**).

This example illustrates the fields and controls on the Visa/Permit Table. You can find definitions for the fields and controls later on this page.

The screenshot shows the 'Visa/Permit Table' interface. At the top, it displays 'Country NLD Netherlands' and 'Visa/Permit Type VD1 Visa for The Netherlands'. Below this is a 'Visa/Permit Data' section with a search bar and navigation controls. The fields include:

- *Effective Date: 01/01/1980 (with a calendar icon)
- *Status: Active (dropdown menu)
- *Description: Visa for The Netherlands
- Short Description: Visa
- *Visa/Permit Classification: Visa (dropdown menu)
- Comment: Residence permit

 Below the data section is a 'Supporting Documents Needed' section with a search bar and navigation controls. It shows one document: '1 PSSPRT Passport and Photos'.

<i>Field or Control</i>	<i>Description</i>
Visa/Permit Classification	Select the appropriate visa or permit classification.
Supporting Documents Needed	Select the appropriate supporting document needed to obtain the visa or permit.

Related Links

[Entering Citizenship Data](#)

Entering and Reviewing License Types

Page Used to Enter or Update License Types

<i>Page Name</i>	<i>Definition Name</i>	<i>Navigation</i>	<i>Usage</i>
Drivers License Type	DRIVE_LIC_TBL	Set Up Common Objects > Product Related > Workforce Administration > Drivers License Type	Enter or update the types of licenses that you are tracking.

Defining Physicians and Diagnosis Data

For information about how to define physicians and diagnosis data, see:

- [Setting Up Physicians](#)
- [Setting Up Diagnosis Codes](#)

Setting Up for Processing Accommodations

You can set up codes for the types of accommodations that your institution makes for individuals with health restrictions and disabilities, such as purchasing special equipment or making structural changes to a classroom. You can use these codes to track the types of accommodations that your institution is requested or required to make, changes that your institution approves, and the party who is responsible for them.

In addition to the pages discussed here, to process accommodations you must also set up regulatory regions and diagnosis codes.

See:

- [Setting Up and Reviewing Regulatory Regions](#)
- [Setting Up Diagnosis Codes](#)

Note: If you implement Campus Solutions *and* a separate instance of PeopleSoft Human Capital Management, read the relevant documentation about CS-HCM Integration to understand the setup, functional, and technical implementation considerations.

See:

“Integrating Person Data” (Campus Solutions Application Fundamentals)

“Integrating Setup Data” (Campus Solutions Application Fundamentals)

“Monitoring Integrations Using the Integrity Utility” (Campus Solutions Application Fundamentals)
Information Center: CS-HCM Integration for PeopleSoft Enterprise Campus Solutions on My Oracle Support (Doc ID 2091799.2).

Related Links

[Processing Accommodations](#)

Pages Used to Set Up for Processing Accommodations

<i>Page Name</i>	<i>Definition Name</i>	<i>Navigation</i>	<i>Usage</i>
Accommodation Type Table	ACCOM_TYPE_TABLE	Set Up Common Objects > Product Related > Workforce Administration > Labor Administration > Accommodation Type	Set up codes for the types of accommodations that your institution makes for individuals with health restrictions and disabilities.

Page Name	Definition Name	Navigation	Usage
Job Code Profile	JOBCODE_TBL1_GBL	Set Up Common Objects > Foundation Tables > Job Attributes > Job Code Table > Job Code Profile	Define or review job codes. Job codes are used on the Accommodation Job Task page within Campus Community.
Job Task Table	JOB_TASK_TABLE	Set Up Common Objects > Foundation Tables > Job Attributes > Job Task Table	Add or edit job tasks that are then associated with a job code in the Job Code Task Table.
Job Code Task Table	JOBCODE_TASK_TABLE	Set Up Common Objects > Foundation Tables > Job Attributes > Job Code Task Table	Define or review job tasks associated with a job code. Job code tasks are used on the Accommodation Job Task page within Campus Community.
Location Address	LOCATION_TABLE1	Set Up Common Objects > Foundation Tables > Organization > Location Address	Identify or review physical locations. Job locations are used on the Accommodation Job Task page within Campus Community. <hr/> Note: Do not confuse this location page with the Location Addresses (LOC_ADDR_TABLE) page on which you set up campus location addresses (Set Up SACR, Product Related, Campus Community, Establish People Processing, Setup, Location Address Table). <hr/>

Defining Accommodation Types

Access the Accommodation Type Table (**Set Up Common Objects > Product Related > Workforce Administration > Labor Administration > Accommodation Type**).

This example illustrates the fields and controls on the Accommodation Type Table.

Accomodation Type Table				
Accommodation Type: KU0017				
Accomodation Type Details		Personalize	Find	View All
*Effective Date	*Status	*Description	Short Description	
01/01/1990	Active	Lower Elevator buttons	Lowr Buttn	

Defining Job Codes

Access the Job Code Profile page (**Set Up Common Objects > Foundation Tables > Job Attributes > Job Code Table > Job Code Profile**).

This example illustrates the fields and controls on the Job Code Profile page.

Job Code Profile	Evaluation Criteria	Market Pay Match	Default Compensation	Non-Base Compensation
SetID: SHARE	Job Code: 120000	Business Units that use this Setid		
Job Code Profile Find First 1 of 1 Last				
*Effective Date:	07/03/1996	*Status:	Active	Go To Row
*Job Title:	Administrator			
Short Job Title:	Admnstr			
Detailed Job Description				
Job Function Code:	<input type="text"/>	Job Subfunction:	<input type="text"/>	
Job Family:	KADMIN	Standard Work Period:	W	
*Standard Hours:	40.00	*Manager Level:	Other	
Workers' Comp Code:	<input type="text"/>	<input type="checkbox"/> Medical Checkup Required		
*Comp Freq:	A			
Regular/Temporary:	Regular			
Union Code:	<input type="text"/>			
<ul style="list-style-type: none"> ▶ Singapore ▶ Canada ▶ Germany ▶ United Kingdom ▶ Italy ▶ Malaysia ▶ USA ▶ Australia ▶ Brazil ▶ Argentina 				
Updated on: 05/23/06 2:07:56PM Updated By: SAMPLE Betty Locherty				

Use this page to define job codes for use on the Accommodation Job Task page in Campus Community.

The Job Code Profile page is the only page in this component you need to set up.

Defining Job Code Tasks

Access the Job Code Task Table page (**Set Up Common Objects > Foundation Tables > Job Attributes > Job Code Task Table**).

This example illustrates the fields and controls on the Job Code Task Table page.

You must first add or edit job tasks on the Job Task Table page. Then, use the Job Code Task Table page to associate job codes with job tasks.

Job codes are used in processing accommodations (on the Accommodation Job Task page) within Campus Community.

Defining Job Locations

Access the Location Address page (**Set Up Common Objects > Foundation Tables > Organization > Location Address**).

See “Setting Up Locations” (Campus Solutions Application Fundamentals).

Reviewing Content Types and Items

This topic discusses how to review content types and items such as memberships, language skills, and licenses or certifications.

Pages Used to Review Content Types and Items

<i>Page Name</i>	<i>Definition Name</i>	<i>Navigation</i>	<i>Usage</i>
Content Catalog -Content Types	JPM_CAT_TYPES	Set Up Common Objects > Product Related > Profile Management > Content Catalog > Content Types	Review the properties of content types.
Content Catalog – Item Details	JPM_CAT_ITEMS	Set Up Common Objects > Product Related > Profile Management > Content Catalog > Content Items	Define or review content items details for the selected content type.

Reviewing Content Types

Access the Content Catalog - Content Types page (**Set Up Common Objects > Product Related > Profile Management > Content Catalog > Content Types**).

This example illustrates the fields and controls on the Content Catalog - Content Types page. You can find definitions for the fields and controls later on this page.

The screenshot shows the 'Content Types' tab selected. The 'Content Type' is 'MEM' and 'System Data' is checked. The 'Description' is 'Memberships' and 'Free Form Type Only' is unchecked. Below this is a 'Properties' section with a table of field configurations.

*Field Name	*Label Text	Sys Data	Key Field	Required	
EFFDT	Effective Date	<input checked="" type="checkbox"/>	<input checked="" type="checkbox"/>	<input checked="" type="checkbox"/>	<input type="button" value="+"/>
EFF_STATUS	Status	<input checked="" type="checkbox"/>	<input checked="" type="checkbox"/>	<input checked="" type="checkbox"/>	<input type="button" value="+"/>
JPM_CAT_ITEM_ID	Membership	<input checked="" type="checkbox"/>	<input checked="" type="checkbox"/>	<input checked="" type="checkbox"/>	<input type="button" value="+"/>
JPM_CAT_TYPE	Content Type	<input checked="" type="checkbox"/>	<input checked="" type="checkbox"/>	<input checked="" type="checkbox"/>	<input type="button" value="+"/>
JPM_DESCR90	Description	<input checked="" type="checkbox"/>	<input checked="" type="checkbox"/>	<input checked="" type="checkbox"/>	<input type="button" value="+"/>
DESCRSHORT	Short Description	<input checked="" type="checkbox"/>	<input type="checkbox"/>	<input type="checkbox"/>	<input type="button" value="+"/>

The properties you select for a content type determine which fields and attributes appear on the Item Details page.

Field or Control	Description
Sys Data	Content types with this check box selected are delivered with the system.
Free Form Type Only	Select this check box if you want to create a free form content type. Note: You cannot define properties or content items for free form content types.
Property	Select the properties to add to this content type from the list of available options. You cannot delete the properties of content types that are provided as system data, but you can add other properties.
Label Text	Displays the default label text for the selected property, which you can override with a more meaningful label. The system displays the label text on the Item Details page. Note: Oracle strongly recommends that you choose a meaningful label for the property so that users clearly understand what kind of information to enter in the field on the Item Details page.

Use the Relationship Rules page only if a content type is related to other content types.

Reviewing and Defining Content Items

Access the Content Catalog – Item Details page (**Set Up Common Objects > Product Related > Profile Management > Content Catalog > Content Items**).

This example illustrates the fields and controls on the Content Catalog - Item Details page.

The screenshot displays the 'Item Details' page for a content type. At the top, it shows 'Content Type: MEM Memberships' and 'Membership: ICA'. Below this is the 'Content Items Details' section, which includes a search bar with 'Find | View All' and navigation controls for 'First', '1 of 1', and 'Last'. The main form contains the following fields:

- *Effective Date:** 01/01/1900 (with a calendar icon)
- *Status:** Active (dropdown menu)
- *Description:** Institute of Chartered Acnts (with a plus icon)
- Short Description:** Chrt Acnts
- Last Update Date/Time:** 01/24/06 1:15:52PM
- by:** SYSTEM

Use this page to review and define content items details for the selected content type.

The fields on the page vary depending on the properties of the content type. When creating new content item IDs for accomplishment-related content types such as LIC, LNG, and MEM, the ID must be unique across all accomplishment content types.

Setting Up Person of Interest Types

This topic discusses how to define and maintain person of interest types and relationships.

Pages Used to Set Up Person of Interest Types

<i>Page Name</i>	<i>Definition Name</i>	<i>Navigation</i>	<i>Usage</i>
Person of Interest Type Tbl	POI_TYPE_TBL	Set Up Common Objects > Foundation Tables > Organization > Person of Interest Types > Person of Interest Type Tbl	Define person of interest types.
Add Person of Interest	PER_POI_TRANS	Set Up Common Objects > Foundation Tables > Organization > Add a POI Relationship > Add Person of Interest	Add a person of interest relationship.
Edit POI Relationship	PER_POI_TRANS	Set Up Common Objects > Foundation Tables > Organization > Maintain a Person's POI Reln > Edit POI Relationship	Edit a person of interest relationship.
Person Org Summary	PERSON_SUMMARY	Set Up Common Objects > Foundation Tables > Organization > Personal Organizational Summary > Person Org Summary	View person of interest summary.

Defining and Maintaining Person of Interest Types and Relationships

Although Campus Solutions functionality has no dependency on Person of Interest types and relationships, POI types and relationships are used to support CS-HCM integrations.

Note: If you implement Campus Solutions *and* a separate instance of PeopleSoft Human Capital Management, read the relevant documentation about CS-HCM Integration to understand the setup, functional, and technical implementation considerations.

See:

“Integrating Person Data” (Campus Solutions Application Fundamentals)

“Integrating Setup Data” (Campus Solutions Application Fundamentals)

“Monitoring Integrations Using the Integrity Utility” (Campus Solutions Application Fundamentals)

Information Center: CS-HCM Integration for PeopleSoft Enterprise Campus Solutions on My Oracle Support (Doc ID 2091799.2).

See also *PeopleSoft HCM: Application Fundamentals*, Setting Up Person of Interest Types.

Establishing Name Usages

Important! Letter Generation (Letter Gen) is a deprecated product. It is strongly recommended that you use Communication Generation (Comm Gen) instead. For more information on Comm Gen, see [Understanding the Communication Generation Process](#)

To establish name usages, use the Name Usage Table component (NAME_USAGE_TABLE).

This section provides an overview of name types and usages and discusses how to define name usage types:

Understanding Name Types and Usages

Names are important when maintaining data about and communicating with individuals. You should configure names in your database for consistent use across your institution. To configure names, use name parts (first, middle, and last name), name types to define a name (for example, legal, maiden, primary, or preferred) and name usages to identify the order in which the name parts will be presented for that type.

Define name prefixes and suffixes (use Set Up Common Objects component) to further identify and address individuals in your campus community. Standard prefixes (Mr, Mrs, and Miss) and suffixes (Esq, MD, PhD) are predefined. You can set up additional prefixes or suffixes, including royal prefixes and suffixes.

Campus Solutions provides name format configurations that are preformatted and preparsed based on country. When you enter the format code on the Names page, the system provides name fields in the predefined format.

The following list shows the name fields and the order in which they appear for each name format. After you enter the name parts and save the record, the system displays the name, concatenated according to the specified format, in the **Name** field.

Country	Name Part
<i>(BEL) Belgium</i>	<ul style="list-style-type: none"> • Name • First Name • Last name • Initials • Preferred First Name • Title
<i>(BZL) Brazil</i>	<ul style="list-style-type: none"> • First Name • Middle Name • Last Name • Preferred First Name
<i>(CHE) Switzerland</i>	<ul style="list-style-type: none"> • Name • Name Prefix • First Name • Middle name • Last name • Name Suffix
<i>(CHN) China</i>	<ul style="list-style-type: none"> • Prefix • First Name • Middle Name • Last Name • Suffix
<i>(DEU) Germany</i>	<ul style="list-style-type: none"> • Prefix • Royal Prefix • Name • Title • First Name • Last Name • Royal Suffix

Country	Name Part
<i>(ESP) Spain</i>	<ul style="list-style-type: none"> • Name • Name Prefix • First Name • Last Name • Second Last Name
<i>(FRA) France</i>	<ul style="list-style-type: none"> • Name Prefix • First Name • Middle Name • Last Name
<i>(HGK) Hong Kong</i>	<ul style="list-style-type: none"> • Name Prefix • First Name • Preferred First • Middle Name • Last name • AC Name
<i>(ITA) Italy</i>	<ul style="list-style-type: none"> • Name • Name Prefix • First Name • Last Name
<i>(JPN) Japan</i>	<ul style="list-style-type: none"> • Name • Last Name • First Name • Name Alternate Character
<i>(MEX) Mexico</i>	<ul style="list-style-type: none"> • Name Prefix • First Name • Last Name • Second Last

Country	Name Part
<i>(NLD) Netherlands</i>	<ul style="list-style-type: none"> • Name • Name Prefix • First name • Last Name • Preferred First name • Initials • Title
<i>USA and all others (English)</i>	<ul style="list-style-type: none"> • Name • First Name • Middle Name • Last Name • Name Prefix • Name Suffix

To create usages and define the name parts for each usage, define hierarchical orders by which to search for other name types in case the name type that you specify does not exist for an individual. For example, you might create a usage of *Admit* for sending an admissions letter to an applicant. You might want to search for and use the individual's preferred first name. If no data exists for that name type, you might then want to search for and use the individual's formal name, and so on. You can create general or specific usages and specify one name type or a hierarchy of many name types within each usage.

Arrange name types in the order that they should appear in an application. For example, when you print an admissions letter and envelope, the applicant's name appears first in the salutation of the letter and then on the envelope. If you select the *Admit* usage previously described, the preferred first name (first in the hierarchical order) appears first (Dear Dave), and the formal name next in the hierarchical order appears next (David Miller).

Page Used to Set Up Name Usages

Page Name	Definition Name	Navigation	Usage
Name Usage	NAME_USAGE_TABLE	Set Up SACR > Product Related > Campus Community > Establish People Processing > Setup > Name Usage Table	Define name usages to specify the hierarchies of name types that you want to use in a specific usage.

Defining Name Usages

Access the Name Usage page (**Set Up SACR > Product Related > Campus Community > Establish People Processing > Setup > Name Usage Table**).

This example illustrates the fields and controls on the Name Usage page (1 of 2) without Joint Usage selected. You can find definitions for the fields and controls later on this page.

Name Usage Table

Name Usage: NAME USG 1

***Description:** **Joint Usage**

***Short Description:**

Usage Definition				
*Usage Order	*Name Type	Description	Part of Name	
10	PRF <input type="text"/>	Preferred	First <input type="text"/>	-
20	PRI <input type="text"/>	Primary	Full <input type="text"/>	-

This example illustrates the fields and controls on the Name Usage page (2 of 2) with Joint Usage selected. You can find definitions for the fields and controls later on this page.

Name Usage Table

Name Usage: NAME USG 1

***Description:** **Joint Usage**

***Short Description:**

Usage Definition			
*Usage Order	*Salutation Type	Description	
10	PRI <input type="text"/>	Primary	-

Warning! The Name Usage Table is a fundamental table shared across all applications in PeopleSoft Campus Solutions. Coordinate carefully with other departments to define and update the Name Usage table to ensure that these values meet the needs across your institution.

<i>Field or Control</i>	<i>Description</i>
Joint Usage	<p>Select this check box to set this name usage for joint communication, or clear the check box to set it for general name usage.</p> <p>The elements that appear in the Usage Definition area of the page vary depending on whether you select the Joint Usage check box. If the Joint Usage check box is selected, the Salutation Type field becomes available.</p> <p>Create joint usages if your institution uses the Joint Communication Management feature. The joint name usages are used to define what salutation type you want to use on a letter sent jointly to two individuals when you use the letter generation process.</p>

Usage Definition

<i>Field or Control</i>	<i>Description</i>
Usage Order	<p>Displays the order in which the system will search for and use the associated data. The system displays the sequential usage order each time that you add a new row.</p> <p>You can change the numbers to rearrange the order in which the system searches for and uses the name or salutation types.</p>
Name Type and Part of Name	<p>If Joint Usage is not selected, the Name Type and Part of Name fields appear. Enter the type of name to use and select the name part to use within the specified name type.</p>
Salutation Type	<p>If Joint Usage is selected, the Salutation Type field appears.</p>
Salutation Type	<p>Enter the salutation type for which you want the system to search. Salutation types are defined on the Joint Communications page.</p>

Related Links

[Understanding Communication Management](#)

Establishing Name Type Defaults

To establish name type defaults, use the Name Type Defaults component (NAME_TYPDFLT_TABLE).

This section discusses how to establish the name types to create by default when adding a new person ID.

Page Used to Establish Name Type Defaults

<i>Page Name</i>	<i>Definition Name</i>	<i>Navigation</i>	<i>Usage</i>
Name Type Defaults	NAME_TYPE_DFLT_TBL	Set Up SACR > Product Related > Campus Community > Establish People Processing > Setup > Name Type Defaults	Define name types to create by default when adding a new person ID.

Defining Name Type Defaults

Access the Name Type Defaults page (**Set Up SACR > Product Related > Campus Community > Establish People Processing > Setup > Name Type Defaults**).

Add each name type that your institution wants a user to define when they create a personal record for an individual.

Establishing Salutations

To establish salutations, use the Salutation Table component (SALUTATION_TABLE) and Joint Salutation Type Table component (SALU_TYPE_SETUP).

This section provides an overview of salutations and discusses how to:

- Create salutations.
- Define salutation types for joint communications.

Understanding Salutations

You can set up salutations and salutation types for use in generating communications. The salutation types that you define are available for use on the Joint Communication Management page in the Relationship component. You can reduce joint communications data entry by setting fields within a salutation type to define how two names will appear in the address and the greeting of a joint communication.

For example, if you select the salutation type of *Primary* select the **Two separate lines** check box, and define and format the name type as *Primary*. Then, when you select the salutation of *Primary* on the Joint Communication Management page, the system places each of the two individual's (primary) names on separate lines.

Also use salutation setup to maintain consistent use of a salutation type, assuring that all users entering data for joint communications use the same rules to enter the names. For example, if you set up a salutation type of *Friend* and define it to use only the individuals' first names, users can use the *Friend* salutation type to consistently use the same more personal greeting where appropriate in joint communications.

Pages Used to Set Up Salutations

<i>Page Name</i>	<i>Definition Name</i>	<i>Navigation</i>	<i>Usage</i>
Salutations	SALUTATION_TABLE	Set Up SACR > Product Related > Campus Community > Establish People Processing > Setup > Salutation Table	Create the salutations to make available in your system. The Joint Salutation Type Table page uses salutations created here.
Salutation Type for Joint Communications	SALU_TYPE_SETUP	Set Up SACR > Product Related > Campus Community > Establish People Processing > Setup > Joint Salutation Type Table	Define salutation types to make available for joint communications. The Joint Communication Management page (in the Relationships component) and the Name Usage page use the salutation types created here.

Creating Salutations

Access the Salutations page (**Set Up SACR > Product Related > Campus Community > Establish People Processing > Setup > Joint Salutation Type Table**).

This example illustrates the fields and controls on the Salutations page. You can find definitions for the fields and controls later on this page.

Salutations

Salutation: Dear Mr

***Description:**

Short Description:

Note: When you create a salutation, do not include punctuation in the salutation.

Defining Salutation Types for Joint Communications

Access the Salutation Type for Joint Communications page (**Set Up SACR > Product Related > Campus Community > Establish People Processing > Setup > Joint Salutation Type Table**).

This example illustrates the fields and controls on the Salutation Type for Joint Communications page. You can find definitions for the fields and controls later on this page.

Salutation Type for Joint Communications

Salutation Type: PRI ***Used for:** All Relationships

***Description:** Primary ***Short Description:** Primary

Salutation Types Find | View All First 1 of 2 Last

***Type Usage:** Address Block Name + -

Salutation Type Usage Detail Find | View All First 1 of 1 Last

***Effective Date:** 01/01/1900 ***Status:** Active + -

Two separate lines

Name 1

Gender: Unknown **Salutation:**

Name Usage Detail

*Name Order	Type of Name	Part of Name		
10	Primary	First	+	-
20	Primary	Middle	+	-
30	Primary	Last	+	-

Name 2

Gender: Unknown **Salutation:**

Name Usage Detail

*Name Order	Type of Name	Part of Name		
10	Primary	First	+	-
20	Primary	Middle	+	-
30	Primary	Last	+	-

<i>Field or Control</i>	<i>Description</i>
Used For	Select the relationship (<i>All Relationships</i> or <i>Spouse Only</i>) for which this salutation should be available on the Joint Communication Management page. For example, if you specify <i>All Relationships</i> , this salutation will be available for all. If you are setting up a joint salutation format that will create something like <i>Mr. and Mrs. Smith</i> , select <i>Spouse Only</i> to make this salutation a valid choice only when a spousal relationship exists.

114

Copyright © 1988, 2024, Oracle and/or its affiliates.

Salutation Types

<i>Field or Control</i>	<i>Description</i>
Type Usage	<p>Select the area of the joint communication where this salutation type should be used. For each salutation type that you create, set up one <i>Address Block Name</i> usage and one <i>Salutation</i> usage.</p> <p><i>Address Block Name</i>: The salutation that appears in the address area of the joint communication.</p> <p><i>Salutation</i>: The salutation that appears in the greeting of the joint communication.</p> <p>Values for this field are delivered with your system as translate values. Do not modify these values in any way. Any modifications to these values could require substantial programming effort.</p>

Salutation Type Usage Detail

<i>Field or Control</i>	<i>Description</i>
Two separate lines	<p>Select this check box to print each of the two names on a separate line for this salutation. For example:</p> <p>John Smith</p> <p>Mary Fletcher</p>

Name 1; Name 2

Use fields in the Name 1 and Name 2 areas to configure each name for this joint communication salutation type.

Warning! Select gender and salutation carefully for each name. If you select a salutation directed to a specific gender and neither individual in the relationship is that gender, you could inadvertently offend the recipients. For example, if you select the gender of *Female* and the salutation of *Dear Ms.* but neither individual in the relationship is female, the result might be *Dear Ms. Robert Smith and David Jones.* Using the Salutation Type for Joint Communications page reduces data entry only. Users should always validate that the names are correct and that the salutations reflect the appropriate genders.

Field or Control	Description
Gender	<p>Use gender to control the order in which the recipient names appear in this salutation.</p> <p><i>Female:</i> The system places the female name first in the salutation.</p> <p><i>Male:</i> The system places the male name first.</p> <p><i>Unknown:</i> The system places the names in the order in which they are listed in the Relationships component and based on the gender specified for the individual on the Biographical Details page.</p> <p>If you do not specify a gender, the system places the primary ID name first and the related ID name next.</p>
Salutation	<p>Select the salutation opening (for example, <i>Dear Mr.</i>, <i>Dear Ms.</i>, or <i>Mr. and Mrs</i>) to precede this Name 1 or Name 2 individual's name.</p> <p>For example, if you select <i>Dear Mr.</i> for Name 1 and <i>Dear Mrs.</i> for Name 2, and you selected the two separate lines check box, the salutation would look like this:</p> <p>Dear Mr. John Smith</p> <p>Dear Mrs. Mary Fletcher</p>

Name Usage Detail

Field or Control	Description
Name Order	<p>Displays the order in which the system searches for and uses the associated data. The system assigns the next sequential usage order each time that you add a new row.</p> <p>You can change the numbers to rearrange the usage order.</p>
Type of Name	Select the type of name for which to search.
Part of Name	Select the name part for which to search within the specified name type.

Establishing Address Usages

To establish address usages, use the Address Usage Table component (ADDR_USAGE_TABLE).

This section provides an overview of address usages, and discusses how to define or review address usages.

Understanding Address Usages

Addresses are as fundamental as names to tracking people in your database. It is important to be able to maintain multiple addresses and phone numbers for an individual, including electronic addresses and campus locations.

Define sets of address types that you routinely want to search for and use for a specific business purpose. For example, if you're sending an admissions letter, you might want to use the individual's home address for the correspondence. If no data exists for the home address type, you might want to search for and use the individual's mailing address. If no data exists for the mailing address, you might want to search for and use the individual's permanent address type, and so on.

You can enter specific campus addresses and physical locations (headquarters, satellite campuses, and remote recruiting offices) to indicate where to contact students or staff at your institution or to specify locations where classes and other events are held.

Related Links

[Understanding Biographical Information](#)

Page Used to Establish Address Usages

<i>Page Name</i>	<i>Definition Name</i>	<i>Navigation</i>	<i>Usage</i>
Address Usage	ADDR_USAGE_TABLE	Set Up SACR > Product Related > Campus Community > Establish People Processing > Setup > Address Usage Table	Define or review address usages by specifying hierarchies of address types to search for and use in a specific usage.

Defining or Reviewing Address Usages

Access the Address Usage page (**Set Up SACR > Product Related > Campus Community > Establish People Processing > Setup > Address Usage Table**).

This example illustrates the fields and controls on the Address Usage page. You can find definitions for the fields and controls later on this page.

Address Usage

Address Usage: ADMIT LTR

***Description:**

Short Description:

Usage Definition				
*Usage Order	*Usage Type	Address Type		
10	Address ▼	Home ▼	+	-
20	Address ▼	Mailing ▼	+	-
30	Address ▼	Permanent ▼	+	-
40	Address ▼	Business ▼	+	-
50	Address ▼	Dormitory ▼	+	-

Warning! The Address Usage Table is a fundamental table shared across all applications in PeopleSoft Campus Solutions. Coordinate with other departments to define and update the Address Usage table to ensure that these values meet the needs across your institution.

Field or Control	Description
Usage Order	<p>Displays the order in which the system searches for and uses the associated data. The system displays the sequential usage order each time that you add a new row.</p> <p>You can change the numbers to rearrange the usage order.</p>
Usage Type	<p>Enter either the usage type (for example, <i>Address</i> or <i>Email</i>) to identify how the address type to search for is used.</p> <p>Values for this field are delivered with your system as translate values. Except for <i>Home</i> and <i>Mail</i>, you can modify these translate values.</p> <hr/> <p>Note: When the Usage Type is <i>Email</i>, the system extracts the specified email address, but it does not produce or send an email communication.</p>
Address Type	<p>Appears when the usage type is <i>Address</i>. Select the type of address to search for (for example, <i>Billing</i>, <i>Home</i>, or <i>Mailing</i>).</p> <p>Values for this field are delivered with your system as translate values. Except for <i>Home</i> and <i>Mail</i>, you can modify these translate values.</p>

Establishing Phone Usages

To establish phone usages, use the Phone Usage Table component (PHONE_USAGE_TABLE).

This section provides an overview of phone usage types, and discusses how to define or review phone usage types.

(CAN) Understanding Phone Usages

If your system's installation country is *CAN*, phone usage values are used for ESIS Current phone reporting.

To create an address usage for ESIS Current address reporting:

1. Access the Phone Usage page.
2. Add an Address Usage of *RPT_PHONE*.
3. In the **Description** field, enter *Phone Priority for Cdn Rpts*.
4. In the **Short Description** field, enter *Cdn Reports*.
5. Using the **Usage Ord** and **Phone Type** fields, insert rows for all phone usage types.

Page Used to Establish Phone Usage Types

<i>Page Name</i>	<i>Definition Name</i>	<i>Navigation</i>	<i>Usage</i>
Phone Usage	PHONE_USAGE_TABLE	Set Up SACR > Product Related > Campus Community > Establish People Processing > Setup > Phone Usage Table	Define Canadian (CAN) reporting phone usage values for ESIS (Extended Student Information System) reporting.

Defining Phone Usage Types

Access the Phone Usage page (**Set Up SACR > Product Related > Campus Community > Establish People Processing > Setup > Phone Usage Table**).

<i>Field or Control</i>	<i>Description</i>
Usage Order	<p>Displays the order in which the system searches for and uses the associated data. The system displays the sequential usage order each time that you add a new row.</p> <p>You can change the numbers to rearrange the usage order.</p>

Field or Control	Description
Phone Type	<p>Enter the phone type to search for (for example, <i>Dormitory</i>, <i>Home</i>, or <i>Mailing</i>).</p> <p>Values for this field are delivered with your system as translate values. Except for <i>Home</i> and <i>Mailing</i>, you can modify these translate values.</p>

Establishing Campus Locations

To establish campus locations, use the Location Address Table component (LOC_ADDR_TABLE).

This section discusses how to define campus addresses for your institution.

Page Used to Define Campus Locations

Page Name	Definition Name	Navigation	Usage
Location Addresses	LOC_ADDR_TABLE	Set Up SACR > Product Related > Campus Community > Establish People Processing > Setup > Location Address Table	Define or review campus addresses for your institution.

Defining Campus Addresses

Access the Location Addresses page (**Set Up SACR > Product Related > Campus Community > Establish People Processing > Setup > Location Address Table**).

This example illustrates the fields and controls on the Location Addresses.

Location Addresses

Location Address Name: MAIN_HALL

Address Details Find | View All First 1 of 1 Last

*Effective Date: 01/01/1900 *Status: Active

*Description: MainHall

Country: USA United States

Address: 200 Testing Drive, Los Angeles, CA 90340 [Edit Address](#)

Note: Do not confuse this page with the Location Address page (**Set Up Common Objects > Foundation Tables > Organization > Location Address**).

Enter address information for this campus location.

Related Links

“Setting Up Locations” (Campus Solutions Application Fundamentals)

[Setting Up for Processing Accommodations](#)

Setting Up Preferences in PeopleSoft Fluid User Interface

This topic discusses how to set up the Campus Preferences page under the My Preferences tile on the Homepage.

Page Used to Set Up Preferences

<i>Page Name</i>	<i>Definition Name</i>	<i>Navigation</i>	<i>Usage</i>
Preferences Configuration	SCC_PREF_CONFIG_FL	Set Up SACR > Common Definitions > Self-Service > Campus Community > Preferences Configuration	Set up the Campus Preferences page to display Career, Term and Financial Aid Year fields.

For more information, see Communication Preferences in [Reviewing or Defining Campus Community Installation Settings](#).

Related Links

“Using My Preferences in PeopleSoft Fluid User Interface” (Campus Self Service)

Setting Up the My Preferences Tile

Set up the My Preferences tile on the Homepage using the Structure and Content page (**PeopleTools > Portal > OBIEE Setup > Structure and Content**).

For detailed information, see: *PeopleTools: Portal Technology*, Creating and Managing Tiles.

Related Links

“Understanding PeopleSoft Fluid User Interface Homepages” (Campus Solutions Application Fundamentals)

Establishing ID Delete Control

You can establish priority data to control and prevent the deletion of individual records in your system.

See [Deleting Individual IDs](#).

Establishing Search/Match Criteria

You can establish criteria and search orders to detect and identify duplicate records in your system.

See [Setting Up Search/Match](#).

Establishing FERPA Privacy Control

You can specify the data that your institution must control to comply with the U.S. FERPA (Family Educational Rights and Privacy Act) regulation and with any other internal privacy policies that your institution might have.

See [Applying FERPA Control](#).

Establishing 3C Deletion Policy Control

This section discusses how to:

- Set 3C deletion policy parameters.
- Set 3C deletion policy exceptions.

Pages Used to Establish 3C Deletion Policy Control

<i>Page Name</i>	<i>Definition Name</i>	<i>Navigation</i>	<i>Usage</i>
3C Delete Policy Manager	SCC_3CD_POL_MGR	Set Up SACR > Common Definitions > 3C Deletion > 3C Deletion Policy Manager	Set broad parameters for 3C deletion so that the system can then automatically identify and delete them with authorization.
3C Deletion Exceptions	SCC_3CD_EXCEPTION	Set Up SACR > Common Definitions > 3C Deletion > 3C Deletion Exceptions	Identify service impacts that the system must consider as exceptions to 3C deletion processes.

Setting 3C Deletion Policy Parameters

Access the 3C Delete Policy Manager page (**Set Up SACR > Common Definitions > 3C Deletion > 3C Deletion Policy Manager**).

This example illustrates the fields and controls on the 3C Deletion Policy Manager page. You can find definitions for the fields and controls later on this page.

3C Deletion Policy Manager

Run Control ID: PSUNV_ADMA [Report Manager](#) [Process Monitor](#) [Run](#)

*Institution: PSUNV

Deletion Criteria Find | View All First 1 of 1 Last

*Effective Date: 04/07/2011 *Status: Active

3C Type	Function	Communication Category	Communication Context	Letter Code	Checklist Code	Checklist Status	Comment Category	*Threshold (days)	Delete Prior to
Communication	SENR	SENR	SENR	SEN				30	03/09/2011
Checklist	ADMA				NEWA			180	10/10/2010
Comment	AWRD						AWRDGO	364	04/09/2010

The fields on this page change depending on the **3C Type** selected. Your institution's deletion parameters can be as broad or as narrowly defined as necessary. Aging thresholds can be set that apply to any 3C, using the **Threshold (days)** field. For example, financial aid communications may need to be kept longer than prospect inquiry responses and that can be reflected in this setup.

Unlike batch 3C deletion or individual deletion of communications, checklists and comments, which are controlled by 3C Group security, access to this page is controlled by PeopleTools permission lists to limit its exposure. Please note that 3C Group Security does not apply to the 3C Deletion Policy Manager.

When you click the **Run** button, the system runs the 3C Delete - Policy Manager Application Engine process (SCC_3CD_PMGR). The process sweeps through the 3C records and deletes target items and their related record rows, following the parameters set on this page.

In exceptional circumstances it may be necessary to identify particular EmplID's 3C items that the 3C Delete - Policy Manager process should avoid. You can use the 3C Deletion Exceptions page to attach a service impact via a service indicator to the EmplID's record.

Setting 3C Deletion Policy Exceptions

Access the 3C Deletion Exceptions page ([Set Up SACR](#) > [Common Definitions](#) > [3C Deletion](#) > [3C Deletion Exceptions](#)).

Service impacts identified here are recognized by the 3C deletion process as indicating EmplIDs whose 3C items are to be excepted from deletion. Note that to apply such exceptions, a service indicator that references a service impact listed here, must be applied to an EmplID.

Service impacts are defined on the Service Impact Table page. Service indicators that refer to a service impact, and would be associated with the EmplID to be exempted, are defined on the Service Indicator Table component.

Related Links

[Setting Up Service Impacts](#)

[Setting Up Service Indicator Codes and Reasons](#)

Chapter 3

Setting Up ID Delete Control

Understanding ID Delete Control

The ID Delete Control feature enables you to define priority data records to prevent users from deleting IDs with data on which others at your institution might rely. With priority data in place, the system will not permit users to delete an ID for which that data exists. A system administrator, or other user with proper security, can review the key data and then, if required, delete the ID.

Campus Solutions provides predefined ID delete control priority tables and fields for individual and organization IDs. Corresponding messages are preset to appear when you try to delete an ID with data in any of the associated control records and fields.

Note: You should *not* modify the predefined ID delete controls. You can, however, define additional priority data by adding other records and fields to control the deletion of IDs.

Common Elements Used in Setting Up ID Delete Control

<i>Field or Control</i>	<i>Description</i>
Record (Table) Name	Displays the name of the record that contains the priority data field.
Field Name	Displays the name of the field that, when data exists in it, prevents the deletion of the ID.
Message Set Number	Enter the set number of the message to display when data exists in the priority data field.
Message Number	<p>Enter the number of the message to display when data exists in the priority data field.</p> <hr/> <p>Warning! If you need to create user-configurable messages, create them in Message Sets 20,000-29,000 to prevent the system from overwriting them.</p> <hr/> <p>Note: The short description for many message numbers is the same. Review the detailed description associated with each message number in the PeopleTools Message Catalog to determine which message number displays the desired message regarding the specific field.</p> <hr/>

Controlling the Deletion of Individual IDs

To control the deletion of individual IDs, use the ID Delete Control (ID_DEL_PRVNT_TABLE) component.

This section discusses how to define priority data to control the deletion of individuals IDs.

Page Used to Control the Deletion of Individual IDs

Page Name	Definition Name	Navigation	Usage
ID Delete Control	ID_DEL_PRVNT_TABLE	<ul style="list-style-type: none"> Set Up SACR > System Administration > Database Processing > ID Delete Control Campus Community > Personal Information > ID Management > ID Delete Control 	Define priority data to control the deletion of individual IDs from your database.

Defining Priority Data

Access the ID Delete Control page (Set Up SACR > System Administration > Database Processing > ID Delete Control).

This example illustrates the fields and controls on the ID Delete Control page. You can find definitions for the fields and controls later on this page.

ID Delete Control						
Control Record/Fields						
	*Record (Table) Name	*Field Name	*Message Set Number	*Message Number		
1	ACCOUNT_SF	EMPLID	14000	40	+	-
2	GP_PYE_PRC_STAT	EMPLID	1000	113	+	-
3	PAY_LINE	EMPLID	1000	113	+	-
4	RECRUITERS	RECRUITER_ID	14000	176	+	-
5	RELATIONSHIPS	EMPLID	14000	389	+	-
6	STDNT_CAREER	EMPLID	14000	177	+	-
7	STUDENT_AID	EMPLID	14000	178	+	-

The ID on each of the following control records and the associated messages are delivered predefined as priority data:

- ACCOUNT_SF
- RECRUITERS
- RELATIONSHIPS
- STDNT_CAREER
- STUDENT_AID

Note: If you implement Campus Solutions and PeopleSoft Human Capital Management (HCM), the GP_PYE_PRC_STAT and PAY_LINE priority data are used in HCM.

Read the relevant documentation about CS-HCM Integration to understand the setup, functional, and technical implementation considerations. See:

“Integrating Person Data” (Campus Solutions Application Fundamentals)

“Integrating Setup Data” (Campus Solutions Application Fundamentals)

“Monitoring Integrations Using the Integrity Utility” (Campus Solutions Application Fundamentals)

See *Information Center: CS-HCM Integration for PeopleSoft Enterprise Campus Solutions* in My Oracle Support (ID 2091799.2).

You should not delete any of the rows of predefined control records. Keep these as your base ID delete control records for individual IDs and define additional priority data as necessary.

To define an additional control record, or to add an additional field from the same record, click the **Plus** button at the level where you want to add it. The system enters a new row and renumbers the sequence of control records. Select the record name, field name, and message data. The new row is not added until you click **Save**.

Controlling the Deletion of Organization IDs

To control the deletion of organization IDs, use the Organization Delete Control (ORG_DEL_PRVN_TABLE) component.

This section discusses how to define priority data to control the deletion of organization IDs.

Page Used to Control the Deletion of Organization IDs

<i>Page Name</i>	<i>Definition Name</i>	<i>Navigation</i>	<i>Usage</i>
Organization ID Delete Control	ORG_DEL_PRVN_TABLE	Campus Community > Organization > Define Organization Data > Organization ID Delete Control	Define priority data to control the deletion of organization IDs in your database.

Defining Priority Data

Access the Organization ID Delete Control page (**Campus Community > Organization > Define Organization Data > Organization ID Delete Control**).

This example illustrates the fields and controls on the Organization ID Delete Control page. You can find definitions for the fields and controls later on this page.

Organization ID Delete Control				
Customize Find First 1-8 of 8 Last				
*Record (Table) Name	*Field Name	*Set	*Msg	
ORG_CNTCT_PHN	EXT_ORG_ID	14000	166	-
ORG_CONTACT	EXT_ORG_ID	14000	166	-
ORG_DEPT	EXT_ORG_ID	14000	166	-
ORG_DEPT_PHN	EXT_ORG_ID	14000	166	-
ORG_GROUPING	EXT_ORG_ID	14000	166	-
ORG_INST_TBL	EXT_ORG_ID	14000	166	-
ORG_LOCATION	EXT_ORG_ID	14000	166	-
ORG_LOC_PHONES	EXT_ORG_ID	14000	166	-

The ID field on each of the following control records and the associated messages are delivered predefined as priority data:

- ORG_CNTCT_PHN
- ORG_CONTACT
- ORG_DEPT
- ORG_DEPT_PHN
- ORG_GROUPING
- ORG_INST_TBL
- ORG_LOCATION
- ORG_LOC_PHONES

You can delete any of the rows of predefined control records. However, you should keep these as your base ID delete control records for organization IDs and define additional priority data as necessary.

To define additional priority data rows, click **Add**. The system adds a new row at the bottom of the page. Select the record name, field name, and message data. The new row is not added until you click **Save**.

Chapter 4

Setting Up Search/Match

Understanding Search/Match

Note: If you implement Campus Solutions *and* a separate instance of PeopleSoft Human Capital Management, read the relevant documentation about CS-HCM Integration to understand the setup, functional, and technical implementation considerations. See:

“Integrating Person Data” (Campus Solutions Application Fundamentals)

“Integrating Setup Data” (Campus Solutions Application Fundamentals)

“Monitoring Integrations Using the Integrity Utility” (Campus Solutions Application Fundamentals)

See *Information Center: CS-HCM Integration for PeopleSoft Enterprise Campus Solutions* in My Oracle Support (ID 2091799.2).

To use the full functionality of your system, you must maintain the integrity of your database. With users from many departments entering data, you want to minimize the entry of duplicate or multiple records. Search/Match enables you to define criteria to check for duplicate or multiple ID records. The searchable ID types (called Search Types) are:

- Person (EmplID).
 - Organization (organization IDs within PeopleSoft Campus Solutions).
-

Note: Campus Solutions provides these ID types as translate values inside the SM_TYPE field. They are delivered as *Active*, but you can inactivate them depending on the applications that you license. Do not, however, add or delete ID type values.

For each of the three ID types, departments or business areas can, based on user security roles, define their own search criteria to perform a search. The criteria can include defining search rules and placing them in the desired order within a search parameter. Each department or business area can also set what data to display in the results to identify a possible matching ID. Departments and business areas can set up multiple search result codes and give security access to all users or restrict it to specific users who have a certain security role assigned.

You can also set rules and parameters to permit only ad hoc searches to enable users with the appropriate security, to perform custom searches without the constraints of predefined criteria.

Data returned in a search result can contain sensitive information. You can control whether to entirely or partially mask a field or display the entire field. The masking configuration can be controlled with user security access. With search results and display controls defined, users can perform Search/Match to determine if a record already exists before adding one.

You can also enforce the use of Search/Match by setting Search/Match to trigger when a user enters data and saves a new ID. You can choose to either display a warning message alerting the user that at least one ID in the database matches the data entered, or transfer the user directly to the list of IDs that match the criteria. When you enforce Search/Match at save time, the user does not need to navigate to the Search/Match component and re-enter the data to determine whether the ID exists.

You define search rules to identify which fields to search for and how to use them to perform the search. You can use one or multiple search rules. If you use multiple search rules, Search/Match applies the rules in the order that you define. Starting with the first rule, if the system finds at least one match according to that rule, it will stop searching. However, if it finds no match for that rule, it will continue to the next rule, and so on.

Also, if you use multiple search rules, you should order the rules from the most restrictive to the least restrictive. For example, rule 1 could return matching IDs when first name, last name, phone number and national ID exactly match. Rule 4 could return matching IDs when only the first and last name match. In this example, rule 4 could return more potential matching IDs than rule 1. The search rule used by Search/Match could therefore be used as an indicator to users of how significant the returned results are.

A search parameter is a set of one or more search rules that you order sequentially with the lowest (or first) search order level as the most restrictive, and the highest (or last) search order level as the least restrictive. A search parameter must be created even if it contains only one search rule.

When a user runs the search, the system searches according to these rules and search orders until it either encounters a potential duplicate or executes all search sequences and finds no potential duplicate.

Use search result codes to specify the data that you want Search/Match to return in the grids on the Search Results page for the potential matching IDs that it finds. You can define field-level security for fields that you consider sensitive. For example, you might allow some users to see the full birth date, but restrict other users to see only the year (or nothing at all), depending on the Primary Permission List in their user profile.

Some search rules, search parameters, and search results are delivered with your system. You can use these as they are, modify them, or add as many as you need.

Warning! Adding new search fields require significant programming effort and is not recommended.

In Campus Solutions, Search/Match is called inside these batch programs when loading data into your system:

Application Engine Program: Search/Match/Post Test Scores (SAD_TEST_PST).

COBOL Program: ISIR Load process (FAPSAR00.cbl, FAPSARRC.cbl, and FAP00SLD.cbl).

SQR Programs:

- Search/Match/Post Process (ADTRNPST.SQR and ADAPPST.SQR).
- Profile Load (FAPFIN04.SQR and FAPFIN05.SQR).

SQR programs are limited to a maximum of 40 search fields inside a single search rule and a maximum of 30 search rules inside a search parameter. Cobol programs and application engine programs do not have these limitations.

Related Links

[Using Search/Match](#)

Understanding Automatic Search

Automatic search reinforces the use of Search/Match when you create a new ID in a transaction page. To trigger an automatic search from the transaction page, associate the component that contains that page with an active search parameter. When the user enters all of the necessary data to create a new ID on that page and saves the transaction record, Search/Match begins automatically. The system uses the predefined search parameter and the data entered by the user as search criteria. If Search/Match does not find matching IDs, the system saves the transaction successfully. If Search/Match finds at least one matching ID, the system either displays the search results inside a grid on the Search Results page or displays a warning message telling the user that at least one matching ID was found, depending on the setup.

If the component name is associated with a search parameter code only, Search/Match displays a warning message indicating that at least one matching ID was found and on which search order the matching IDs were found. The user is then instructed to either click **OK** to continue saving the new ID or to click **Cancel** to avoid saving the transaction and investigate further. In this case, the user can choose to navigate manually to the Search/Match page, enter the search data, and perform the search.

If the component name is associated with a search parameter code and a search result code, Search/Match displays the search results inside a grid on the Search Results page. This enables users to review the potential duplicate IDs without having to manually navigate to the Search/Match page. After reviewing the results on the Search Results page, the user clicks **Return** and is instructed to either click **OK** to continue saving the new ID or to click **Cancel** to avoid saving the transaction and investigate further.

Note: For PeopleSoft Campus Solutions, this setup is valid only when creating person IDs or organization IDs from the following components: SCC_BIO_DEMO, ADM_PROSPECT_PROG, ADM_APPL_ENTRY1, QUICK_ADMIT or ORGANIZATIONS.

Warning! To display the Search Results page at save time, you must have a security role with access to the component interface HCR_SM_SEARCH.

See:

- *PeopleTools: Security Administration*
- [Viewing Search Results](#)

Understanding Automatic Search Conditions

Search/Match uses phone and email values to perform the search only when a phone or email value is marked as preferred. Therefore, to use PhoneRule and EmailAddressRule inside a search rule triggered automatically when you save a new ID, the ID must have a preferred phone number and preferred email address.

For PeopleSoft Campus Solutions, Search/Match uses the address type fields that the user enters when AddressTypeRule is not included inside a search rule triggered when saving a new person ID but Address1Rule, Address2Rule, Address3Rule, Address4Rule, CityRule, CountryRule, CountyRule, PostalRule or StateRule are included. Even if AddressTypeRule is included in a search rule, if you enter more than one address type when creating a new ID, Search/Match reviews the home address type value specified on the Installation - Campus Community page to know which address fields to use to perform the search. If a home address value is not specified on the Installation - Campus Community page, Search/Match uses the first address type that you enter.

Setting Up Search/Match

This section discusses how to:

- Define search rule codes.
- Define search parameters.
- Define search permissions.
- View or add Search/Match result fields.
- Configure Search/Match results.
- Enter search results details.
- Define search results exceptions.
- Configure search result permissions.

Note: If you implement Campus Solutions *and* a separate instance of PeopleSoft Human Capital Management, read the relevant documentation about CS-HCM Integration to understand the setup, functional, and technical implementation considerations. See:
 “Integrating Person Data” (Campus Solutions Application Fundamentals)
 “Integrating Setup Data” (Campus Solutions Application Fundamentals)
 “Monitoring Integrations Using the Integrity Utility” (Campus Solutions Application Fundamentals)
 See *Information Center: CS-HCM Integration for PeopleSoft Enterprise Campus Solutions* in My Oracle Support (ID 2091799.2).

Pages Used to Set Up Search/Match

<i>Page Name</i>	<i>Definition Name</i>	<i>Navigation</i>	<i>Usage</i>
Search/Match Rule	HCR_SM_RULE	Set Up SACR > System Administration > Utilities > Search/Match > Search/Match Rules	Define sets of fields to search for and identify how to search for them.
Search Parameters	HCR_SM_PARM	Set Up SACR > System Administration > Utilities > Search/Match > Search/Match Parameters > Search Parameters	Combine and order search rules. The combination (called the search parameter) is what the users select prior to performing a search to determine the search fields that they are permitted to search on.

Page Name	Definition Name	Navigation	Usage
Search Permissions	HCR_SM_PERM	Set Up SACR > System Administration > Utilities > Search/Match > Search/Match Parameters > Search Permissions	Identify who can use the search parameter to perform the search. Also identify which component names, if any, should use the search parameter as part of saving a new ID in the database.
Search/Match Result Fields	HCR_SM_RSLT_FLDS	Set Up SACR > System Administration > Utilities > Search/Match > Search/Match Result Fields	View or add fields that are available to define the search results.
Search Results	HCR_SM_RESULT	Set Up SACR > System Administration > Utilities > Search/Match > Search/Match Results > Search Results	Specify which result fields to include in the search results and control how to display their values. <hr/> Note: Be careful not to confuse this page with the page also called <i>Search Results</i> with a similar object name (HCR_SM_RESULTS), which is the page on which Search/Match displays returns from a search. <hr/>
Search Results Detail	HCR_SM_RDTL_PG	Click the Page Navigation button that appears on the Search Results page when you select the Use Detail Page option.	Define the page to use to view more information about a specific ID returned by Search/Match.
Search Results Exceptions	HCR_SM_RESULT_EXCP	Click the Exceptions link on the Search Results page.	Define field-level security exceptions to the data display control that is set on the Search Results Permissions page.
Search Result Permissions	HCR_SM_RSLT_PERM	Set Up SACR > System Administration > Utilities > Search/Match > Search/Match Results > Search Result Permissions	Identify who should have access to this search result code. Also identify which component, if any, Search/Match should use this result code when a new ID is added and a potential duplicate ID is found.

Defining Search Rule Codes

Access the Search/Match Rule page (**Set Up SACR > System Administration > Utilities > Search/Match > Search/Match Rules**).

This example illustrates the fields and controls on the Search/Match Rule page. You can find definitions for the fields and controls later on this page.

Search/Match Rule

Search Rule Code: PSCS_10 **Search Type:** Person

***Description:** **Ad Hoc Search**

Search Fields									
*Sequence	Search Field	Field Description	Required	Usage	Start Position	Number of Characters	Length		
1	Address1Rule	Address Line 1	✓	Begins With	1	5	55	+	-
2	CityRule	City	✓	Begins With	1	10	30	+	-
3	FirstNameSrchrRule	First Name Search	✓	Begins With	1	3	30	+	-
4	LastNameSrchrRule	Last Name Search	✓	Begins With	1	5	30	+	-
5	DateOfBirthRule	Date of Birth	✓	Equals			10	+	-
6	GenderRule	Gender	✓	Equals			1	+	-
7	NationalIDRule	National Id	✓	Equals			20	+	-

Field or Control	Description
Ad Hoc Search	<p>Select to permit custom ad hoc searches from this search rule.</p> <p>An ad hoc search enables users to bypass the institution's predefined search standards to perform a custom search without predefined operands and without limiting the characters to evaluate. For example, an ad hoc search might be <i>first name equals John</i>; whereas, a non-ad hoc search might be set to search only on the first three characters of the first name (in this case, <i>Joh</i>).</p>

Search Fields

Search fields are delivered with your system.

Warning! Adding new search fields require significant programming effort and is not recommended.

Field or Control	Description
Sequence	Enter the order in which you want the search fields to appear when used inside a search parameter.

Field or Control	Description
Search Field and Field Description	<p>Select each search field that you want to assign to this search rule code. When you exit the field, the system displays the associated description. Search fields are the fields on which users are permitted to search.</p> <p>Search fields are delivered with your system. Adding or modifying a search field value requires a significant programming effort. Do not attempt to delete a search field.</p> <hr/> <p>Note: When you include name, national ID, phone, email, or address fields in the rule without the types (Name Type, National ID Type, phone type, email type or address type), the system searches on all national IDs, phones, emails or addresses in the system for that individual.</p> <hr/>
Required	<p>Select this check box to require a value in the search field to find a potential match on this search rule. Selecting this check box is useful for making the rule more restrictive.</p> <p>If the check box is not selected, the system accepts blank or nonexistent for this field inside this search rule. For example, if all the fields inside a search rule are marked as required, the user must provide data for each of those search fields to find a match on this rule. However, if the Required check box is not selected, for example, for Date of Birth, the user can still search on that search rule without specifying a date of birth.</p>
Usage	<p>Identify how you want the search to evaluate the field value:</p> <p><i>Begins With:</i> The value must begin with this data. When you select this value, the Start Position field appears with a default value of <i>1</i>, and the Number of Characters fields are available for you to define. You cannot modify the start position default value.</p> <p><i>Contains:</i> The value must contain this data but can be preceded or followed by other data. When you select this value, the Start Position field appears with a default value of <i>1</i>, and the Number of Characters fields are available for to you define.</p> <p><i>Equals:</i> The value must be exactly equal to this data.</p> <p><i>Not Used:</i> Do not use this field value in this search.</p>

Field or Control	Description
Start Position and Number of Characters	<p>Enter the character position where you want the compare to start, and enter the number of characters from that start position to include in the compare.</p> <p>For example, if the usage selected for National ID is <i>Contains</i>, and you enter a start position of 3 and the number of characters of 5, the system compares against the 3rd, 4th, 5th, 6th, and 7th characters in the field value. It will return matching IDs for which the National ID contains these 5 characters.</p> <p>If the usage selected was <i>Begins With</i>, the start position is a default value of 1. You need to specify how many characters from the first character that Search/Match should use to perform the search.</p>
Length	<p>Indicates the number of characters in the search field. When you exit a particular field in the Search Field column, the system displays the total number of characters in the associated field.</p>

See [Understanding Search/Match](#).

Defining Search Parameters

Access the Search Parameters page (**Set Up SACR > System Administration > Utilities > Search/Match > Search/Match Parameters > Search Parameters**).

This example illustrates the fields and controls on the Search Parameters page. You can find definitions for the fields and controls later on this page.

Search Parameters
Search Permissions

Search Parameter: PSCS_TRADITIONAL **Search Type:** Person

Description: **Status:** **Ad Hoc Search**

Search/Match Rules			Customize Find	First	1-5 of 5	Last
Search Order	*Search Rule Code	Rule Code Description				
10	PSCS_10	Name,Addr,City,Bday,Gender,SSN	View Definition	+		-
20	PSCS_20	SSN Only	View Definition	+		-
30	PSCS_30	Name,Bday,Gender	View Definition	+		-
40	PSCS_40	Name,Gender	View Definition	+		-
50	PSCS_50	Name Only	View Definition	+		-

Field or Control	Description
Ad Hoc Search	<p>Select to permit only custom ad hoc searches from this search parameter.</p> <p>An ad hoc search enables users to bypass the institution's predefined search standards to perform a custom search without predefined operands and without limiting the characters to evaluate. For example, an ad hoc search might be <i>first name equals John</i>; whereas, a non-ad hoc search might be set to search only on the first three characters of the first name (in this case, <i>Joh</i>).</p> <hr/> <p>Note: Automatic search cannot be performed from a search parameter set to permit ad hoc searches.</p>

Search/Match Rules

Field or Control	Description
Search Order	<p>Enter the order in which to apply the search rule codes of this search parameter. Enter the most restrictive search rule in the lowest order number and the least restrictive search rule in the highest order number.</p> <p>You can reorder the search rules at any time. When you reorder the rules and save the page, the system displays the rules in the most recent numerical order that you entered.</p> <p>Search/Match processes the lowest order search rule first; if it finds one or more possible matches, it stops the search and returns the results. If it finds no results, it continues to the next search rule, and so on.</p> <p>In the search results, the system displays the search order number that corresponds to the search rule where potential matching IDs are found.</p> <p>You can use only one search rule for an ad hoc search; therefore Search Order fields do not appear when the Ad Hoc Search check box is selected.</p>
Search Rule Code and Rule Code Description	<p>Enter the search rule code to use. When you exit the field, the system displays the search rule description. You must enter at least one search rule to create a valid search parameter.</p>
View Definition	<p>Click this link to access the Search/Match Rule page on which you can view or edit the rule definition.</p>

Defining Search Permissions

Access the Search Permissions page (**Set Up SACR > System Administration > Utilities > Search/Match > Search/Match Parameters > Search Permissions**).

This example illustrates the fields and controls on the Search Permissions page. You can find definitions for the fields and controls later on this page.

Search Parameter: PSCS_TRADITIONAL **Search Type:** Person

Description: CS_Person_Traditional **Status:** Active **Ad Hoc Search**

Search Parameters Access

Full Access

Restricted Security Access Customize | Find | First 1 of 1 Last

	*Role Name	Role Description		
1	<input type="text"/>		<input type="button" value="+"/>	<input type="button" value="-"/>

Search/Match Used in Transaction Customize | Find | First 1-3 of 3 Last

	*Component Name	Component Description		
1	ADM_APPL_ENTRY1	Add Application	<input type="button" value="+"/>	<input type="button" value="-"/>
2	QUICK_ADMIT	Quick Admit	<input type="button" value="+"/>	<input type="button" value="-"/>
3	SCC_BIO_DEMO	CS Person Maintenance	<input type="button" value="+"/>	<input type="button" value="-"/>

Search Parameters Access

<i>Field or Control</i>	<i>Description</i>
Full Access	Select to enable all users to use the search parameter code.

Restricted Security Access

This area appears only when the **Full Access** check box is not selected.

<i>Field or Control</i>	<i>Description</i>
Role Name and Role Description	Restrict the use of this search parameter code to users that have specific roles inside their security profile.

Search/Match Used in Transaction

<i>Field or Control</i>	<i>Description</i>
<p>Component Name and Component Description</p>	<p>If you want to enforce the use of Search/Match when adding a new ID, select the component name where adding a new ID occurs. The system will then initiate Search/Match when a user enters the data to create a new ID and saves the transaction. You can restrict the search to specific components whether you give permissions to all roles or only to specific roles.</p> <hr/> <p>Note: A component name can be associated with only one search parameter. However, the same search parameter can be used inside several component names. Select all components where the search parameter should be used.</p> <hr/> <p>If Search/Match finds potential matching IDs that correspond to the data entered, the system returns a warning message indicating that one or more matching IDs was found at search order number XX.</p> <hr/> <p>Note: This field is available only when the Search Type is <i>Person</i> or <i>Organization</i>.</p> <hr/> <p>See Understanding Automatic Search.</p>

Viewing or Adding Search/Match Result Fields

Access the Search/Match Result Fields page (**Set Up SACR > System Administration > Utilities > Search/Match > Search/Match Result Fields**).

This example illustrates the fields and controls on the Search/Match Result Fields page. You can find definitions for the fields and controls later on this page.

Search/Match Result Fields

Search Result Field: DateOfBirth **Search Type:** Person

Description: Date of Birth **Effective Dated**

Search Result Data		
Record Name:	PERSON	PERSON record
Field:	BIRTHDATE	Date of Birth

System Data - not available for update

Many Search/Match result fields are delivered predefined and are available for you to use when defining search result codes. The text *System Data - not available for update* appears for these fields on the Search/Match Result Fields page. You cannot edit the data for the predefined search fields. You can, however, select additional fields to make available for your search result codes.

When you select *Add a New Value* and enter a name for the results field, the Search/Match Result Fields page appears with enterable fields for you to select the record and field to make available within the search results. To control how the values for a field appear in the results, use the Search/Match Results setup page.

Note: When search result fields are created based on records that are either effective-dated or type-related (such as address type, email type, phone type, and so on), Search/Match returns a row for each of the dates (history, current, and future dates) and types. For example, the field Gender is included in the PERS_DATA_EFFDT record. If you use Gender as a search result field, then a person with multiple rows on PERS_DATA_EFFDT will display multiple rows with the same gender in the search results grid. This is to make sure the evaluation of potential duplicate IDs occurs across all dates and types applicable to each ID. If your institution prefers to see a limited number of rows, you can create the search result fields based on a view that includes logic to limit the effective date to display only current information or logic to return only a specific type (for example select address information where Address Types is Home).

Configuring Search/Match Results

Access the Search Results page (**Set Up SACR > System Administration > Utilities > Search/Match > Search/Match Results > Search Results**).

This example illustrates the fields and controls on the Search Results page. You can find definitions for the fields and controls later on this page.

Search Results
Search Result Permissions

Search Result Code: PSCS_TRAD_MASK **Search Type:** Person

***Description:** **Status:**

Result Set

Use Detail Page Page Navigation

Search/Match Result Fields										
Sequence	*Result Field	Field Description	Display Option	Number of Characters	Day	Month	Year	Length		
1	NameType	Name Type	Display Entire Field					3	Exceptions	+ -
2	EffectiveDate	Name Effective Date	Display Entire Field					10	Exceptions	+ -
3	FirstName	First Name	Display Entire Field					30	Exceptions	+ -
4	MiddleName	Middle Name	Display Entire Field					30	Exceptions	+ -
5	LastName	Last Name	Display Entire Field					30	Exceptions	+ -
6	NationalID	National ID	Display Last	4				20	Exceptions	+ -
7	DateOfBirth	Date of Birth	Display Partial Date		<input type="checkbox"/>	<input type="checkbox"/>	<input checked="" type="checkbox"/>	10	Exceptions	+ -
8	Gender	Gender	Display Entire Field					1	Exceptions	+ -
9	CampusID	Campus ID	Display First	2				16	Exceptions	+ -

Result Set

<i>Field or Control</i>	<i>Description</i>
Use Detail Page	<p>Select this check box to display a Detail link beside each ID returned from a search.</p> <p>When you select Use Detail Page, the Page Navigation button appears.</p>
Page Navigation	<p>This button appears only when the Use Detail Page check box is selected.</p> <p>Click to access the Search Results Detail page, on which you can define the page to which you want users to be directed to see more details about a specific ID.</p> <hr/> <p>Note: To be transferred to the page that you define here, the user must have security access to the page.</p> <hr/>

Search/Match Result Fields

<i>Field or Control</i>	<i>Description</i>
Sequence	<p>Enter the order by which the system displays results in the in the Search/Match results grid. You can reorder the result fields at any time. When you reorder the fields and save the page, the system displays the result fields in the most recent numerical sequence that you entered.</p>
Result Field and Field Description	<p>Select the data to return with the search results. Fields used to perform the search (search fields) can be different from the fields needed to review the results (result fields).</p> <p>The result fields are defined in the Search/Match Result Fields page.</p>

Field or Control	Description
Display Option	<p>Displays the default display control for that field. You can override this. Select <i>Display Entire Field</i> or <i>Mask Entire Field</i> to display or hide the entire field value respectively . The other options are:</p> <p><i>Display First</i>: Displays the first specified number of characters of the field value. When you select this, the Number of Characters field appears. You must enter the number of characters to display from the beginning of the field value.</p> <p><i>Display Last</i>: Displays the last specified number of characters of the field value. When you select this, the Number of Characters field appears. You must enter the number of characters to display from the end of the field value.</p> <p><i>Display Partial Date</i>: Displays the specified parts of a date field value. When you select this, the Day, Month, Year check boxes appear. You must select which parts of the date to display. For example if you select <i>Year</i>, only the year will appear.</p>
Number of Characters	Enter the number of first or last characters of a field value to display.
Day, Month, Year	Select the parts of the date to display for a date value.
Length	Displays the number of characters possible for the field value.
Exceptions	Click this link to access the Exceptions page, on which you can define field-level exceptions to these results.

Entering Search Results Details

Access the Search Results Detail page (click the **Page Navigation** button that appears on the Search Results page when you select the **Use Detail Page** option).

This example illustrates the fields and controls on the Search Results Detail page. You can find definitions for the fields and controls later on this page.

Search/Match Results

Search Results Detail Page

Search Result Code: PSCS_TRAD_MASK **Search Type:** Person

Description: CS_Pers Traditional Result Mask **Status:** Active

Detail Page Parameters

Menu Name:

Menu Bar Name:

Item Name:

Page Name:

Action Mode:

Detail Page Parameters

<i>Field or Control</i>	<i>Description</i>
Menu Name, Menu Bar Name, Item Name, and Page Name	Select each item that corresponds to the page that you want to use to provide more details about a specific ID.
Action Mode	Select the action mode to define in which mode you want your users to access the detail page. Options are: <i>Add</i> <i>Correction</i> <i>Data Entry</i> <i>Update/Display</i> <i>Update</i>

Defining Search Results Exceptions

Access the Search Results Exceptions page (click the **Exceptions** link on the Search Results page).

This example illustrates the fields and controls on the Search Results Exceptions page. You can find definitions for the fields and controls later on this page.

Search/Match Results

Search Results Exceptions

Search Result Code: PSCS_TRAD_MASK CS_Pers Traditional Result Mask

Result Field: DateOfBirth Date of Birth

Field Level Security Exceptions			Customize Find	First	1-3 of 3	Last
Primary Permission List	Permission List Description	Display Option	Length			
EODS1000	Directory Interface	Display Entire Field	10	+		-
EOEC9010	Credit Card Interface	Display Entire Field	10	+		-
HCCPCSSA50NL	CS The Netherlands	Display Entire Field	10	+		-

You can define exceptions to the search results that you set up on the Search Results page. For example, you might have partially masked the birth date field in your search results, but you want the entire field to appear for those who have a need to know. Using primary permission lists, you can set those exceptions here.

See “Preparing for User Profiles Management” (Campus Solutions Application Fundamentals).

Field Level Security Exceptions

<i>Field or Control</i>	<i>Description</i>
Primary Permission List and Permission List Description	Select the primary permission lists of the users who will be exceptions to the result field selected. When you exit the field, the system displays the permission list description.
Display Option	Select the display option to use as the exception to the display option selected on the Search Rules page.

Configuring Search Result Permissions

Access the Search Result Permissions page (**Set Up SACR > System Administration > Utilities > Search/Match > Search/Match Results > Search Result Permissions**).

This example illustrates the fields and controls on the Search Result Permissions. You can find definitions for the fields and controls later on this page.

Search Results
Search Result Permissions

Search Result Code: PSCS_TRAD_MASK **Search Type:** Person

Description: CS_Pers Traditional Result Mask **Status:** Active

Search Result Code Access

Full Access

Restricted Security Access Customize | Find | First 1 of 1 Last

	*Role Name	Role Description	
1	<input type="text" value=""/>		+ -

Search/Match Used in Transaction Customize | Find | First 1 of 1 Last

	*Component Name	Component Description	
1	<input type="text" value="SCC_BIO_DEMO"/>	CS Person Maintenance	+ -

<i>Field or Control</i>	<i>Description</i>
Full Access	Select this check box to enable all users to use the search result code
Role Name and Role Description	Enter roles to restrict the use of this search result code to users that have this role inside their security profile.
Component	<p>This field is available only when the Search Type is <i>Person</i>.</p> <p>If you use automatic search and want to display a warning message to alert users when potential duplicate IDs exist and you want to display the results of the automatic search, select the same component name or names that you selected on the Search Permissions page for the search parameter. You can restrict the search to specific components whether you give permissions to all roles or to only specific roles.</p> <hr/> <p>Note: A component name can be associated with only one search result code. However, the same search result code can be used inside several component names. Select all components where the search result code should be used. If Search/Match finds potential matching IDs that correspond to the data entered, the system returns a Search Results page showing the matching IDs that were found.</p> <hr/> <p>See Understanding Automatic Search.</p>

Related Links

[Viewing Search Results](#)

Setting Up External Search/Match

Understanding External Search/Match

External Search/Match functionality looks and feels much like the standard Search/Match that resides in Campus Solutions (CS). However, External Search/Match integrates with any external system and enables your institution to perform searches within that external system and import records into Campus Community. The goal is to provide complete and meaningful lists of potential duplicate IDs in your entire environment, including IDs that reside outside of the CS database.

External Search/Match executes these searches with the help of two delivered web service operations. You can then use web services to import a matching constituent that does not exist inside the CS database. Web services send outbound search requests from the system of record to an external system and also receive inbound responses coming directly from the external system. As enterprise architectures grow more complex and CS may no longer be the sole source of person data entry and maintenance, searching against external systems ensures that no duplicates exist in your environment.

As with Search/Match, you can perform three types of searches with External Search/Match: applicant, person, and organization. However, the system performs applicant and organizational searches only using Search/Match at this time; you are able to search for only people when using External Search/Match as part of integration with an external system. External Search/Match allows you to search for people simultaneously against the CS database (using the current Search/Match), as well as directly inside an external system; the process displays the combined results inside CS search results pages. If your institution integrates External Search/Match with an external system that allows advanced searching capabilities (for example, External Search/Match is integrated with a data hub that has fuzzy matching capabilities), this extra search logic can be leveraged and the results returned to you contain a richer set of matching candidates.

External Search/Match reuses the same setup parameters and security configuration used for standard Search/Match functionality.

How to Search

You can perform either an online or an automatic search using External Search/Match.

To perform an online search:

1. Access the Search/Match Integrated component.
2. Select a *Search Type*, *Search Parameter*, *Search Result Code*, and other search fields as appropriate; this step is the same as the existing Search/Match.
3. After populating some or all of these fields with search data, click the **Search** or **Selective Search** button.

The system validates the external system data settings and determines whether the institution is configured for Search/Match, External Search/Match, or both. This determination causes the system to then perform the search inside the CS database and/or outside to an external system.

If the system determines that an external search should occur, then it generates the outbound search request (Match Request). That search request contains all information known about the search. The XML message might contain the search parameters used, the search fields and their values, and so on.

This diagram illustrates the Online External Search/Match process.

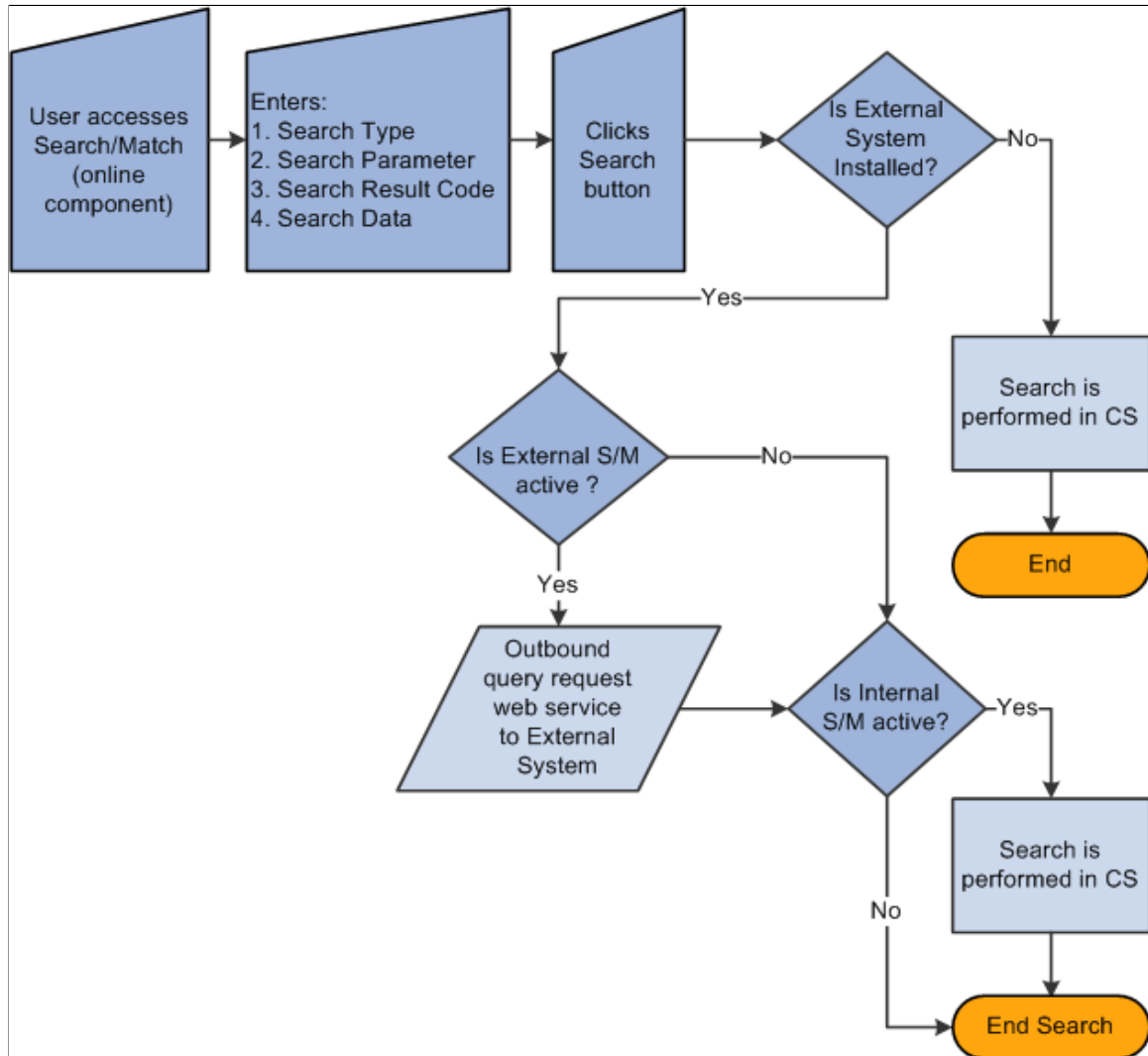

To perform an automatic search, all of the above information applies. When you enter data to create an EmplID on a CS page and then click the Save button, the system invokes additional logic to validate the external data integration settings and then triggers the Match Request.

This example illustrates an Automatic search process using the External Search/Match functionality.

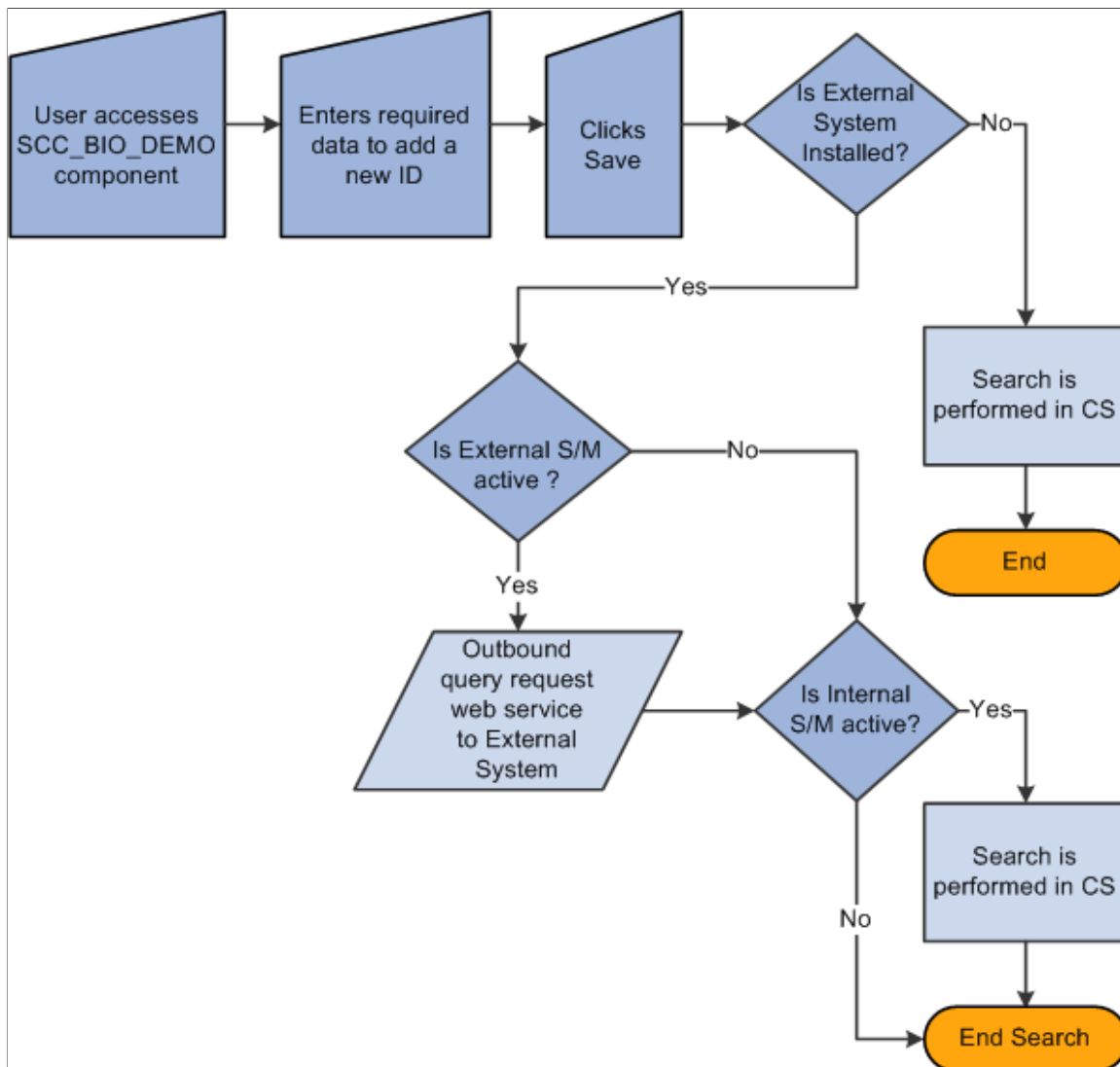

Search Results

After the external system search process completes its search for potential matches, the result data is sent to CS via the response message (Match Response). When you perform a search that triggers both the Internal Search/Match and External Search/Match processes, the system may not find results on the same search order number. The rule for External Search/Match functionality is to display all search results, beginning with the lowest search order number obtained (the most restrictive search rule where matching EmplIDs are found). The search order is determined by the Results Engine.

Before it can display your search results, the Results Engine receives the results from both the Internal Search/Match and External Search/Match processes. The engine evaluates the search order number from each system's matching candidates.

- If Internal Search/Match found matching candidates with a lower search order number than the external system, then the Results Engine displays the results from Internal Search/Match; the lowest search order indicates that it was a more restrictive search.

- If the opposite is true, then the Results Engine displays the results found from the external search.
- If both searches retrieve results on the same search order number, the Results Engine combines the search results into a single display for the user.

Regardless of whether you invoke Internal Search/Match, External Search/Match, or both, the search results appear on the Integrated Search Results page. This page contains many of the same fields as the Search Results page. In addition, the Results tab contains optional columns such as the external system ID (referred to as the Universal ID), the **EmplID** (when it exists) and the **Score%** (or the weight) of each matching candidate found if the external system provides that information. The Results tab uses the same masking configuration that is in place for Search/Match.

When External Search/Match finds a matching candidate that does not exist inside the internal system (the matching candidate is not tied to an EmplID), you can still use the Detail link to view more information about the constituent. This case triggers an outbound web service request for more information (Fetch Request). The external system receives the information and returns detailed constituent information inside its response web service (Fetch Response). The system then displays (but does not store) the detailed information inside a Detail page that enables you to review the data.

If you determine that the matching candidate is the person you are looking for, you can import the person record from the Integrated Search Results page. When you click the **Import** button, the system generates a Fetch Request (the same web service used to retrieve more details about the constituent) and uses the information contained in the Fetch Response to create the new person record inside the CS database. After you generate the person's EmplID, you can then use it to perform subsequent transactions.

See “Understanding CS-to-HCM Integration” (Campus Solutions Application Fundamentals)

See “Integrating Person Data” (Campus Solutions Application Fundamentals)

See the following documents in My Oracle Support:

- *PeopleSoft Campus Solutions Constituent Web Services Developer's Guide* (ID 1982192.1).
- *Information Center: CS-HCM Integration for PeopleSoft Enterprise Campus Solutions* on My Oracle Support (ID 2091799.2).

Related Links

[Understanding Constituent Web Services](#)

[Using Search/Match](#)

Prerequisites for Setting Up External Search/Match

While your current Search/Match setup can remain unchanged, it is recommended that you review it to maximize the search capabilities offered by the external system. For example, if the external system that integrates with External Search/Match does not store National ID information, you could remove this information from your search parameters.

- Search Parameter: Additional **Search Parameter** codes may need to be created for external system integrations with data hubs to accommodate how the transformation layer evaluates the search parameter used and the various **Search Order Numbers**.

Note: External Search/Match includes in the Match Request only the Search Order Numbers for which potential matches can be found (this is the same concept used by Search/Match).

- **Search Results:** If your results code(s) contain fields that are not stored inside your integrated external system, and if the person returned has an EmplID in the CS system, the Results Engine fetches the data inside the CS database to populate the Results tab.

For example, a user uses a **Search Results** code that contains the **Aid Year** field. If your external system does not store that information, the Results Engine uses the returned EmplID to fetch the CS database and retrieve the information. This is also true for matching candidates returned with an EmplID. If the matching candidate is not stored in the CS database (no EmplID exists), then the **Aid Year** column remains blank for that candidate.

- **Search Results** code masking configuration: The system reuses the existing setup when you use a **Search Results** code with masking configuration and the external system returns results for display.

In addition, you must set up Integration Broker to trigger the following web services:

- SCC_SM_FETCH (Search/Match fetch service).
- SCC_SM_SERVICE (External Search/Match service).

Finally, you must grant users security to the Search/Match Integrated component.

Important! If your institution has specified integration with an external system on the External Core Data Integration page, to ensure that all of your users will search the same way Oracle recommends that you revoke their security to the Search/Match component. All searching capabilities included inside the Search/Match component are included inside the Search/Match Integrated component.

Setting Up External Search/Match Functionality

This section discusses how to:

- Configure external core data integration.
- Configure External Search/Match options.
- Configure External Search/Match web services.

Pages Used to Set Up External Search/Match Functionality

<i>Page Name</i>	<i>Definition Name</i>	<i>Navigation</i>	<i>Usage</i>
External Core Data Integration	SCC_EXT_SYSTEM	Set Up SACR > Install > External Core Data Integration	Specify an external system that is integrated with CS for core person data.

Page Name	Definition Name	Navigation	Usage
External System Search Match Options	SCC_CS_HUB_INSTALL	Set Up SACR > System Administration > Utilities > Search/Match > Search Match with External Sys	Specify External Search/Match options when integrating with an external system.

Configuring External Core Data Integration

Access the External Core Data Integration page (**Set Up SACR > Install > External Core Data Install**).

Field or Control	Description
Is External System Installed	<p>Select this check box to indicate whether CS is integrated with any external system. If you do not select this check box, the other fields on the page are unavailable for input.</p> <p>When users perform a Search/Match, the system evaluates this indicator and determines whether to invoke External Search/Match functionality.</p>
Integrated External System	<p>Select an option to indicate which system is integrated:</p> <p><i>HCM installed as third party:</i> Select to indicate that CS and an HCM system are in separate instances and the administrative user has distinguished the HCM system as an External System with direct integration to it (for example, HCM 9.0, HCM 9.1, or another CS system).</p> <p><i>Other external system:</i> Select to indicate that an external system other than an HCM system has been integrated to CS. This could potentially be another third-party data hub.</p> <p><i>[Blank]:</i> Leave the field blank to indicate that CS has no external system integrated with it. This is the default setting for this field.</p>
Data Hub Name	<p>Define the name of the external system, based on the selected Integrated External System. If you selected <i>HCM installed as third party</i>, this field changes to <i>HCM Installed as Third Party</i> and is unavailable for input. However, if you selected <i>Other external system</i>, this field becomes active; enter the external system name.</p> <hr/> <p>Note: PeopleSoft assumes that only one external system will be used.</p>

Configuring External Search/Match Options

Access the External System Search Match Options page (**Set Up SACR > System Administration > Utilities > Search/Match > Search Match with External Sys**).

This example illustrates the fields and controls on the External System Search Match Options page. You can find definitions for the fields and controls later on this page.

External System Search Match Options

External Search/Match Options				
Search/Match Options				
*Search Type	*Search/Match Option	*Status		
Person	Internal Search/Match	Active	+	-
Person	External Search/Match	Active	+	-

Static Columns to display in the Results Grid				
	*Default Column Name	Display Name		
1	Employee ID	Emplid	+	-
2	Score	Score %	+	-
3	Universal ID	Hub ID	+	-
4	External Employee ID	Ext ID	+	-

If the **Is External System Installed** check box is not selected on the External Core Data Integration page, the following message appears: "Currently, no External System is configured with Campus Solutions. To configure an External System, navigate to External Core Data Integration page."

Search/Match Options

Fields in this group box determine the conditions under which the system uses Search/Match, External Search/Match, or both when adding a new person or saving an updated bio/demo page.

<i>Field or Control</i>	<i>Description</i>
Search Type	Select <i>Person</i> , <i>Applicant</i> , or <i>Organization</i> . Note: At this time, you may only select the <i>Person</i> option. The other search types are not yet integrated with External Search/Match.

Field or Control	Description
Search/Match Option	<p>Select the Search/Match functionality to use when an external system is installed:</p> <p>If you select <i>Internal Search/Match</i> and you make it <i>Active</i>, then the Search/Match process searches for person IDs inside the CS database.</p> <p>If you select <i>External Search/Match</i> and you make it <i>Active</i>, then the External Search/Match process searches for person IDs inside the integrated external system.</p> <p>If you clear the status or make the status <i>Inactive</i>, the system does not trigger a specific Search/Match tool.</p> <hr/> <p>Note: Both searches can be selected at the same time, and results from both searches appear on the same Integrated Search Results page.</p> <hr/>

Static Columns to Displays in the Results Grid

Fields in this group box contain information about additional columns to display inside the Results grid of the Integrated Search Results page.

Field or Control	Description
Default Column Name	<p>Select <i>EmplID</i>, <i>Universal ID</i>, <i>Score</i>, or <i>External Employee ID</i>.</p> <p>These are delivered translate values; do not modify them.</p> <p><i>EmplID</i> is displayed by default (just like for Search/Match).</p> <p><i>Universal ID</i> is a generic term that refers to the external system ID in use. When selected, the external system ID is displayed inside the Additional Information tab of the Results grid.</p> <p><i>Score</i> is a generic term that refers to your external system method for ranking the matches found. It is the weight or the accuracy of the results found. It is sometimes expressed by a percentage or a number. If your external system does not have ranking capability, do not select this option. When selected, the column appears first in the Results grid.</p> <p>If you select <i>Score</i>, then the system sorts search results in the Results grid by score in descending order and by EmplID in ascending order. If you do not select <i>Score</i>, then the search results appear only by EmplID in ascending order.</p> <p><i>External Employee ID</i> refers to the External HCM system EmplID. It is specifically used when the institution has selected to import external EmplIDs rather than generate a CS-unique EmplID.</p>
Display Name	<p>Enter a custom column name for the static columns that appear in the Results grid.</p>

Configuring External Search Match Web Services (Distinct Ownership model)

The following example is for requests being sent from Campus Solutions (CS) to Human Capital Management (HCM). To send requests in both directions, you can configure the same service operations in both your CS and HCM systems with outbound and inbound routings.

1. Activate the search service `SCC_SM_SERVICE`.
 - a. Log on to the Campus Solutions database and navigate to: **PeopleTools > Integration Broker > Integration Setup > Service Definitions**.
 - b. Enter `SCC_SM_SERVICE`, then click **Search**.
 - c. Select `SCC_SM_SERVICE`
 - d. In Existing Operations, click `SCC_SM_SERVICE_SYNC`.

- e. In Default Service Operation Version, make sure **Active** is selected.
 - f. Click **Service Operation Security** and verify the permission list setup.
2. Set up the handler for SCC_SM_SERVICE.
- a. Click **Handlers** and enter the following:

Note: In the distinct ownership configuration example, requests are only coming from the CS side. CS doesn't need to handle any requests so the request handler doesn't need to be configured on the CS side.

Field or Control	Description
Name	Enter <i>SearchReq</i> . Once the handler details are added, this is converted to REQUESTHDLR.
Type	OnRequest
Implementation	Application Class
Status	Active

- b. Click **Details**, then enter the following:

Field or Control	Description
Description	Search Request Handler
Package Name	SCC_HR_INTEGRATION
Path	Request_Handler
ClassID	ProcessMatchRequest
Method	OnRequest

- c. Click **OK**.

3. Set up the routings for SCC_SM_SERVICE.
- a. Click **Routings**.
 - b. Enter the routing details:

Field or Control	Description
Routing Name	For example, On CS: SCC_SM_Request_to_HR On HCM: SCC_SM_Request_from_CS
Description	On CS: Search Request to HR db On HCM: Search Request from CS db
Sender Node	On CS: CS92ESM (CS database name) On HCM: CS92ESM (CS database name)
Receiver Node	On CS: HR92ESM (HR database name) On HCM: HR92ESM (HR database name)
Log Detail	Header and Detail

- c. Click **Save**, then click **Return to Service**.
 - d. In Routing Definitions, verify that Status is *Active* and Direction is the expected value. For SCC_SM_REQUEST_TO_HR, the Direction is *Outbound*.
 - e. Click **Save**.
4. Activate the fetch service SCC_SM_FETCH.
 - a. Navigate to: **PeopleTools > Integration Broker > Integration Setup > Service Definitions**.
 - b. Enter *SCC_SM_FETCH*, then click **Search**.
 - c. Select **SCC_SM_FETCH**.
 - d. In Existing Operations, click **SCC_SM_SERVICE_SYNC**.
 - e. In Default Service Operation Version, make sure **Active** is selected.
 - f. Click **Service Operation Security** and verify the permission list setup.
 5. Set up the handler for SCC_SM_FETCH.

Note: If you're issuing requests from the CS side, there's no need to define a handler in CS. Requests are handled on the HR side. If you define a handle that's not being used, you can set it to *Inactive*.

- a. Click **Handlers** and enter the following:

Field or Control	Description
Name	Enter <i>FetchRequest</i> . Once the handler details are added, this is converted to REQUESTHDLR.
Type	OnRequest
Implementation	Application Class
Status	Active

- b. Click **Details** and enter the following:

Field or Control	Description
Description	Request Handler
Package Name	SCC_HR_INTEGRATION
Path	Request_Handler
ClassID	ProcessFetchRequest
Method	OnRequest

- c. Click **OK**.

6. Set up the routings for SCC_SM_FETCH.

- a. Click **Routings** and define the routing as follows:

Field or Control	Description
Routing Name	For example, On CS: SCC_SM_FETCH_REQ_to_HR On HCM: SCC_SM_FETCH_REQ_from_CS
Description	On CS: Fetch Request to HR db On HCM: Fetch Request from CS.db

<i>Field or Control</i>	<i>Description</i>
Sender Node	On CS: CS92ESM (CS database name) On HCM: CS92ESM (CS database name)
Receiver Node	On CS: HR92ESM (HR database name) On HCM: HR92ESM (HR database name)
Log Detail	Header and Detail

- b. Click **Save**, then click **Return to Service**.
- c. In Routing Definitions, verify that Status is *Active* and Direction is the expected value. For SCC_SM_FETCH_REQ_TO_HR, the Direction is *Outbound*.
- d. Click **Save**.

Setting Up Affiliations

Understanding Affiliations Setup

Affiliations is designed to enable institutions to create and track the roles or relationships that a constituent may have simultaneously with an institution. The configuration of business rules to create and assign these affiliations will vary from institution to institution. Setting up the affiliations feature enables each institution to tailor the specific affiliation code, create a hierarchical structure for the affiliation code, and specify how the affiliation code is managed, either manually or through application-specific transactional events.

Affiliation setup relies on PeopleTools Integration Broker, Constituent Web Services messaging, and an Affiliation Engine. There are two main concepts to consider when implementing affiliations for your institution:

1. Define your requirements.

The user needs to understand what changes in the Campus Solutions system will trigger an affiliation. These are usually data changes driven by PIA pages or batch programs. In addition, consider what conditions will trigger the assignment and removal of an affiliation.

2. Implementation of the Integration Broker message and triggering code.

When you create an affiliation, you will write PeopleCode that determines – based on the information in the message contents and possibly data in the database – whether a constituent will be assigned an affiliation or whether the affiliation will be removed.

The *PeopleSoft Campus Solutions Affiliations Developer's Guide* contains detailed information about web services in general and affiliation setup examples.

Steps for setting an affiliation in the system diagrams setting an affiliation

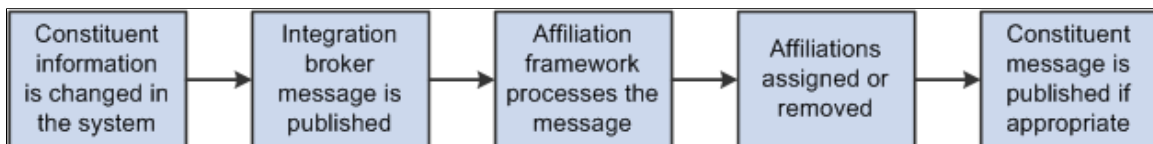

There are five high-level steps to set an affiliation:

1. A constituent's information is changed in the system.

This change might result from an applicant applying online, an administrator updating a constituent's information, or from a batch program that updated a constituent's records.

2. As a result of the information changes, an integration broker message is fired.

3. The affiliation framework listens to the Integration Broker message and adapts it to a constituent object so that the Affiliation Engine can understand and process it.

4. The Affiliation Engine evaluates the constituent object and determines whether, based on the institution's rules, an affiliation should be assigned or removed.
5. If an affiliation was assigned or removed, the system sends a constituent message to notify downstream processes that utilize affiliation data.

Affiliations functionality enables your institution to create and manage detailed, complex relationships with the people in your Campus Solutions system; it does not replace existing Relations with Institution functionality in Campus Community or Constituent Types functionality in Contributor Relations.

Related Links

[Setting Up Relations to the Institution](#)

“Defining Constituent Types” (Contributor Relations)

Prerequisites for Setting Up Affiliations

Before you can set up or use Affiliations functionality, your institution must enable Constituent Web Services. There are also more technical setup prerequisites, such as defining services and configuring Integration Broker; these steps are covered in the *PeopleSoft Campus Solutions Affiliations Developer's Guide*.

Defining Affiliations

This section discusses how to:

- Create affiliation codes.
- Setting triggers.
- Setting context data.

Pages Used to Define Affiliations

Page Name	Definition Name	Navigation	Usage
Definition	SCC_AFL_TBL	Set Up SACR > Common Definitions > Affiliations > Affiliation Setup > Definition	Define affiliation codes and the hierarchical structure of those codes.
Trigger	SCC_AFL_TRGR	Set Up SACR > Common Definitions > Affiliations > Affiliation Setup > Trigger	Define simple events that trigger the system to determine whether to assign or remove an affiliation.

Page Name	Definition Name	Navigation	Usage
Context Data	SCC_AFL_CONTEXTDAT	Set Up SACR > Common Definitions > Affiliations > Affiliation Setup > Context Data	Associate additional record/field pairs with an Affiliation code for inclusion when Affiliation event message is published.

Creating Affiliation Codes

Access the Definition page (**Set Up SACR > Common Definitions > Affiliations > Affiliation Setup > Definition**).

This example illustrates the fields and controls on the Definition page. You can find definitions for the fields and controls later on this page.

The screenshot displays the 'Definition' tab of the Affiliation Code setup page. At the top, there are tabs for 'Definition', 'Trigger', and 'Context Data'. Below these, the 'Institution' is set to 'PSUNV' (PeopleSoft University) and the 'Affiliation Code' is 'ALUMN_TMPL'. A 'Details' section contains the following fields and controls:

- *Effective Date:** 02/20/2009 (with a calendar icon)
- *Status:** Active (dropdown menu)
- *Description:** PSUNV Alumni
- Root Indicator:** (checked)
- Children Indicator:** (unchecked)
- Manual:** (unchecked)

The **Application Class** section includes:

- *Package Name:** SCC_AFFILIATIONS
- *Path:** IMPLEMENTATION
- *Application Class ID:** Alumni_template
- Application Class:** SCC_AFFILIATIONS:IMPLEMENTATION:Alumni_template

Below this, there is a **Details** field containing 'Alumni for PSUNV' and a **Sponsoring Dept** field set to 'ADVANCEMNT' (University Advancement).

Campus Solutions delivers five predefined **Affiliation Code** examples: *Alumni*, *Recruiter*, *Applicant*, *Student*, and *Non-Student Employee*. The **Application Class** and the triggering event information is already set up for these codes. You can define the details of an affiliation code, and assign it a place in a hierarchy. Hierarchies of affiliation are designated with the **Root Indicator** and **Children Indicator** check boxes.

For information about how Research Tracking leverages Affiliations, see “Setting Up Research Tracking” (Student Records).

Field or Control	Description
Package Name	<p>Select an Application Class Package ID.</p> <p>A <i>SCC_AFFILIATIONS</i> Package ID is delivered with Campus Solutions.</p>
Path	<p>Select a Qualified Package/Class Path for the selected Package Name.</p> <p>An <i>IMPLEMENTATION Qualified Package/Class Path</i> for Package ID <i>SCC_AFFILIATIONS</i> is delivered with Campus Solutions.</p>
Application Class ID	<p>Select an Application Class ID for the selected Package Name and Path.</p> <p>The <i>Alumni_template, Applicant_template, Employee_template Recruiter_template, Student_template,</i> and Application Path IDs for Package ID <i>SCC_AFFILIATIONS</i> and Qualified Package/Class Path <i>IMPLEMENTATION</i> are delivered with Campus Solutions.</p>

Field or Control	Description
Application Class	<p>Displays the Application Class created by selection of the Package Name, Path, and Application Class ID on this page and assigned for this Affiliation Code</p> <p>The Application Class field is specified on the last node or leaf of the hierarchy, at the lowest level when defining a triggered affiliation code. The class is created in App Designer and contains the implementation logic or transaction validation logic for the specific affiliation code. The system uses the class defined here to determine which affiliations are set and not set for a person.</p> <p>The PeopleSoft system delivers five application class templates. Each template file name ends with "<i>_template</i>":</p> <ul style="list-style-type: none"> • Alumni <ul style="list-style-type: none"> • Affiliation code: ALUMN_TMPL • Application class: SCC_AFFILIATIONS:IMPLEMENTATION:Alumni_template • Applicant <ul style="list-style-type: none"> • Affiliation code: APPL_TMPL • Application class: SCC_AFFILIATIONS:IMPLEMENTATION:Applicant_template • Recruiter <ul style="list-style-type: none"> • Affiliation code: RECTR_TMPL • Application class: SCC_AFFILIATIONS:IMPLEMENTATION:Recruiter_template • Non-Student Employee <ul style="list-style-type: none"> • Affiliation code: EMP_NS_TMP • Application class: SCC_AFFILIATIONS:IMPLEMENTATION:Employee_template • Student <ul style="list-style-type: none"> • Affiliation code: STDNT_TMPL • Application class: SCC_AFFILIATIONS:IMPLEMENTATION:Student_template

Field or Control	Description
	Information on how to define application class logic is contained in the <i>PeopleSoft Campus Solutions Affiliations Developer's Guide</i> .
Sponsoring Department	<p>The department that is responsible for creating the affiliation code. Note that this field is informational only.</p> <hr/> <p>Note: Root and child affiliations codes can each have their own sponsoring department; child affiliations do not necessarily need to inherit the sponsoring department of the parent affiliation code.</p> <hr/>
Root Indicator	Select this check box to indicate that the Affiliation Code is at the highest level of the affiliation hierarchy. Clear this check box to indicate that the code is a branch within the hierarchy of the specific Affiliation Code . If there are no children for this code, you must specify the application class here.
Children Indicator	<p>Select this check box to indicate that for the specific Affiliation Code, additional nodes or children exist below this branch in the affiliation hierarchy. When this check box is selected, the Application Class group box is no longer available at this level of the hierarchy, and the Child Affiliations group box appears, where you can define and view children of the affiliation.</p> <p>If no root or child indicator box is selected, the affiliation code is at the lowest level, and you must define implementation logic here (the application class).</p>
Manual	Select this check box to indicate that the affiliation code can be assigned and end dated <i>only</i> manually. The Affiliation Code is assigned and end-dated via the administrative component, Add/Update Affiliations . When you select the check box, the system removes the capability for a user to add an affiliation class and also applies a dummy event for triggering the affiliation as part of its definition. There is no underlying PeopleCode logic that determines whether the affiliation code can be assigned or end dated for triggering events. Because there is no logic associated with the affiliation code, the code cannot be used as part of affiliations batch processing and has no triggering events.

Warning! It is strongly recommended that you do not create affiliation hierarchies such that an affiliation code is dependent on another affiliation code, as it will create sequencing problems during affiliation processing.

Child Affiliations

You can enter child affiliations in two ways: click the **Add Child Code** link to actually create the child affiliation code or select a **Child Affiliation Code**, if one has already been defined.

Field or Control	Description
Add Child Code	Click this link to create a new individual child affiliation code (on a second Definition page). After you create and save the child affiliation code, the system returns to the original Definition page and the Child Affiliation Code becomes available to be selected and assigned.
Child Affiliation Code	Select an existing code to assign to the child level of the affiliation at the institution.

Single-Level Hierarchy Example

In this example, the **Root Indicator** check box is selected and the **Children Indicator** check box is clear. This specifies that there are no additional subcategories or children associated with this affiliation code. Since this is the lowest level in the hierarchy, the application class is entered here to define the transactional logic.

This example illustrates the fields and controls on the Single-level hierarchy example. You can find definitions for the fields and controls later on this page.

The screenshot shows a software interface with the following elements:

- Tabs:** Definition (selected), Trigger, Context Data
- Institution:** PSFRA French University
- Affiliation Code:** ALUMNI_MOD
- Details Panel:**
 - *Effective Date: 01/01/1900
 - *Status: Active
 - *Description: PSFRA Alumni
 - *Root Indicator:
 - *Children Indicator:
 - *Manual:
- Application Class Section:**
 - *Package Name: SCC_AFFILIATIONS
 - *Path: IMPLEMENTATION
 - *Application Class ID: Alumni_template
 - Application Class: SCC_AFFILIATIONS:IMPLEMENTATION:Alumni_template
- Details:** Alumni for PSFRA
- Sponsoring Dept:** (empty field)

Two-Level Hierarchy Example

In this example, the **Root Indicator** check box is selected and the **Children Indicator** check box is selected for the parent/root affiliation. This specifies that the root has additional subcategories or children associated with it. When you select the **Children Indicator** check box, you can then enter an associated **Child Affiliation Code** that has already been defined.

This example illustrates the fields and controls on the Two-level hierarchy example (1 of 2). You can find definitions for the fields and controls later on this page.

The screenshot shows the 'Definition' tab of an affiliation definition. The institution is 'PSESP' (PeopleSoft University Spain) and the affiliation code is 'SUPRVS'. The details section includes:

- *Effective Date:** 01/01/2000
- *Status:** Active
- Root Indicator:**
- Children Indicator:**
- Manual:**
- *Description:** Research Supervisor
- Details:** Research Supervisor
- Sponsoring Dept:** (empty)

Below the details is a 'Child Affiliations' table with one entry:

*Child Affiliation Code	*Child Effective Date	Description
PROFR	01/01/2000	Professor

There is an 'Add Child Code' link at the bottom right of the table.

The lowest level of a hierarchical affiliation does not have the check boxes for either **Root Indicator** or **Children Indicator** selected. In a two-level hierarchy, the child of the affiliation has no indicator boxes checked and the **Application Class** field contains the actual affiliation application class value.

This example illustrates the fields and controls on the Two-level hierarchy example (2 of 2). You can find definitions for the fields and controls later on this page.

The screenshot shows the 'Definition' tab of an affiliation definition. The institution is 'PSUNV' (PeopleSoft University) and the affiliation code is 'PROF_TMPL'. The details section includes:

- *Effective Date:** 01/01/1900
- *Status:** Active
- Root Indicator:**
- Children Indicator:**
- Manual:**
- *Description:** PeopleSoft University Professor
- Details:** PeopleSoft University Professor
- Sponsoring Dept:** ALL_DEPTS (Department Security China)

The **Application Class** section contains the following fields:

- *Package Name:** SSR_RS_RESEARCH
- *Path:** Util:AdministratorAffiliations
- *Application Class ID:** AdmnAffDataImpl
- Application Class:** SSR_RS_RESEARCH:Util:AdministratorAffiliations:AdmnAffDataImpl

Three-or-More-Level Hierarchy Example

In this example, both the **Root Indicator** check box and the **Children Indicator** check box are selected for the parent/root affiliation code. This specifies that the root has additional subcategories or children associated with it. When you select the **Children Indicator** check box, you can then define or enter an associated **Child Affiliation Code** that has already been defined.

This example illustrates the fields and controls on the Three-or-more level hierarchy example (1 of 3). You can find definitions for the fields and controls later on this page.

The screenshot shows a web-based interface for defining affiliation codes. At the top, there are tabs for 'Definition', 'Trigger', and 'Context Data'. Below these, the 'Institution' is set to 'PSUNV PeopleSoft University' and the 'Affiliation Code' is 'SUPRV_TMPL'. The 'Details' section includes fields for '*Effective Date' (01/01/1900), '*Status' (Active), and checkboxes for 'Root Indicator' (checked), 'Children Indicator' (checked), and 'Manual' (unchecked). A 'Details' text area contains 'Research Supervisor Root affiliation code'. Below this is a 'Sponsoring Dept' field. The 'Child Affiliations' section features a table with columns for '*Child Affiliation Code', '*Child Effective Date', and 'Description'. Two child codes are listed: 'PROF_TMPL' (PeopleSoft University Professor) and 'L1A' (Level1A). Each row has '+' and '-' buttons. An 'Add Child Code' link is at the bottom right.

*Child Affiliation Code	*Child Effective Date	Description
PROF_TMPL	01/01/1900	PeopleSoft University Professor
L1A	01/01/1900	Level1A

For the middle-level affiliation codes, the **Root Indicator** check box is cleared and the **Children Indicator** check box is selected. This specifies that the affiliation code is *not* the root and it has additional subcategories associated with it. When you select the **Children Indicator** check box, you can then enter the associated **Children Affiliation Code** that has already been defined for this affiliation code.

This example illustrates the fields and controls on the Three-or-more level hierarchy example (2 of 3). You can find definitions for the fields and controls later on this page.

Definition	Trigger	Context Data
Institution:	PSUNV	PeopleSoft University
Affiliation Code:	SUPRV_TMPL	
Details Find View All First 1 of 1 Last		
*Effective Date:	01/01/1900	*Status: Active
*Description:	PSUNV Research Supervisor	<input type="checkbox"/> Root Indicator <input type="checkbox"/> Children Indicator <input checked="" type="checkbox"/> Manual
Details:	Research Supervisor Root affiliation code	
Sponsoring Dept:	50000	Manufacturing

The lowest level of a hierarchical affiliation does not have the boxes for **Root Indicator** or **Children Indicator** selected. These are left clear and the **Application Class** contains the actual affiliation application class value.

This example illustrates the fields and controls on the Three-or-more level hierarchy example (3 of 3). You can find definitions for the fields and controls later on this page.

Definition	Trigger	Context Data
Institution:	PSUNV	PeopleSoft University
Affiliation Code:	SUPRV_TMPL	
Details Find View All First 1 of 1 Last		
*Effective Date:	01/01/1900	*Status: Active
*Description:	PSUNV Research Supervisor	<input type="checkbox"/> Root Indicator <input type="checkbox"/> Children Indicator <input checked="" type="checkbox"/> Manual
Details:	Research Supervisor Root affiliation code	
Sponsoring Dept:	50000	Manufacturing

Setting Triggers

Access the Trigger page (Set Up SACR > Common Definitions > Affiliations > Affiliation Setup > Trigger).

This example illustrates the fields and controls on the Trigger page. You can find definitions for the fields and controls later on this page.

Definition		Trigger	Context Data
Institution:	PSUNV	PeopleSoft University	
Affiliation Code:	ALUMN_TMPL	PSUNV Alumni	
Details Find View All First 1 of 1 Last			
Effective Date:	02/20/2009		
Affiliation Event Personalize Find First 1 of 1 Last			
*Event Name	Description		
SCC_AFL_ALUMNI_CHANGED	Alumni Event	+	-

Add the **Event Name**, registered through the Constituent Event Registration component, that associates the application class with a constituent management service operation for the affiliation code. There are six delivered triggers that correspond to the system-defined affiliation templates for Alumni, Recruiter, and Non-Student Employee. These are:

- Alumni: SCC_AFL_ALUMNI_CHANGED
- Recruiter: SCC_AFL_RECRUITER_CHANGED
- Non-Student Employee: WORKFORCE_SYNC
- Applicant: SCC_AFL_APPLICANT_CHANGED
- Student: SCC_AFL_STUDENT_CHANGED (for Student Enrollment) , SCC_AFL_STUDENT1 (for Quick Admit Student)

For information about how Research Tracking leverages Affiliations, see “Setting Up Research Tracking” (Student Records).

See *PeopleSoft Campus Solutions Constituent Web Services Developer's Guide* in My Oracle Support (ID 1982192.1).

Setting Context Data

Access the Context Data page (**Set Up SACR > Common Definitions > Affiliations > Affiliation Setup > Context Data**).

This example illustrates the fields and controls on the Context Data page. You can find definitions for the fields and controls later on this page.

The Context Data tab of the Affiliation Setup component is used to associate additional record/field pairs with the Affiliation Code. These details are then included as part of the data when the Affiliation event message is published. Up to ten separate record/field pairs may be defined.

<i>Field or Control</i>	<i>Description</i>
Record Name	Select the Record Name table or Record Name for the Field Name you want to associate with the Affiliation Code .
Field Name	Select the Field Name you want to associate with the Affiliation Code and publish within the Affiliation message.

Defining Affiliation Status

This section discusses how to set up affiliation status details.

Page Used to Define Affiliation Status

<i>Page Name</i>	<i>Definition Name</i>	<i>Navigation</i>	<i>Usage</i>
Affiliation Status Setup	SCC_AFL_STTS_SETUP	Set Up SACR > Common Definitions > Affiliations > Affiliation Status Setup	Define the statuses to be assigned to affiliation codes.

Setting Up Affiliation Status Details

Access the Affiliation Status Setup page (**Set Up SACR > Common Definitions > Affiliations > Affiliation Status Setup**).

This example illustrates the fields and controls on the Affiliation Status Setup page. You can find definitions for the fields and controls later on this page.

Affiliation Status Setup

Affiliation Status: ACT

Affiliation Details						
		Customize	Find	First	1-7 of 7	Last
*Descriptor	*Short Description	*Status	Preferred			
Applied	Applied	Active	<input checked="" type="checkbox"/>	+	-	
Benefits Eligible	Benefits	Active	<input type="checkbox"/>	+	-	
Enrolled	Enrolled	Active	<input type="checkbox"/>	+	-	
In Absentia	Absent	Active	<input type="checkbox"/>	+	-	
No Show	No Show	Active	<input type="checkbox"/>	+	-	
Post Enrolled Fellow	Post Enrol	Active	<input type="checkbox"/>	+	-	
Prospective	Prospectiv	Active	<input type="checkbox"/>	+	-	

An affiliation status of *Active*, *Inactive*, or *Error* can be set for various reasons. The fields on this page enable you to further clarify a specific status that provides additional meaning to all three affiliation statuses: Active, Inactive, and Error.

You cannot delete an affiliation, but you can make it inactive.

<i>Field or Control</i>	<i>Description</i>
Preferred	Select this check box to indicate that a status' description should be the default value to appear on affiliation pages, when that status is selected.

Defining Affiliation Rankings

This section discusses how to assign rankings to affiliation codes.

Page Used to Define Affiliation Rankings

<i>Page Name</i>	<i>Definition Name</i>	<i>Navigation</i>	<i>Usage</i>
Affiliation Ranking	SCC_AFL_RANKING	Set Up SACR > Common Definitions > Affiliations > Affiliation Ranking	Manually assign a five-digit ranking to an affiliation code, per institution.

Assigning Rankings to Affiliation Codes

Access the Affiliation Ranking page (**Set Up SACR > Common Definitions > Affiliations > Affiliation Ranking**).

This example illustrates the fields and controls on the Affiliation Ranking page. You can find definitions for the fields and controls later on this page.

Affiliation Ranking

Institution PSUNV PeopleSoft University

Customize | Find |
First 1-10 of 10 Last

	Affiliation Code	Description	*Affiliation Ranking		
1	STDNT_TMPL	Student for PSUNV	01000		
2	STGRD_TMPL	Graduate Student of PSUNV	01100		
3	STUGD_TMPL	Undergrad Student for PSUNV	01200		
4	STFA_TMPL	Fine Arts Undergraduate Student of PSUNV	01210		
5	APPL_TMPL	Applicant for PSUNV	02000		
6	APGRD_TMPL		02100		
7	APUGD_TMPL	Undergrad Applicant for PSUNV	02200		
8	ALUMN_TMPL		03000		
9	INSTR_TMPL	Instructor Template	04000		
10	RECTR_TMPL		04100		

This page enables users to assign a numerical rank to all tiers of an affiliation, both root and children. There is no logic attached to the rankings that you assign.

Note: Multiple affiliation codes can have the same ranking.

Mapping Institution Departments to Affiliations

This section discusses how to map departments to institutions.

Page Used to Map Institution Departments to Affiliations

<i>Page Name</i>	<i>Definition Name</i>	<i>Navigation</i>	<i>Usage</i>
Institution Department Mapping	SCC_AFL_INS_DEP	Set Up SACR > Common Definitions > Affiliations > Institution Department Mapping	Map departments with no institution key to an affiliation.

Mapping Departments to Institutions

Access the Institution Department Mapping page (**Set Up SACR > Common Definitions > Affiliations > Institution Department Mapping**).

This page is used for affiliation codes, based on data model structures within Campus Solutions, that are not keyed by institution but rather by department (such as employee). These codes enable the user to map such a department to an institution for use within the affiliation framework structure.

Setting Up the Affiliations Gantt Chart

This section discusses how to set up the Person Affiliations Gantt chart.

Page Used to Set Up the Affiliations Gantt Chart

<i>Page Name</i>	<i>Definition Name</i>	<i>Navigation</i>	<i>Usage</i>
Chart Properties	SCC_AFL_CHART_TASK	Campus Community > Affiliations > Affiliations Gantt Chart Setup > Affiliations Gantt Setup	Define the appearance of the Person Affiliations Chart View.

Setting Up the Person Affiliations Chart View

Access the Chart Properties page (**Campus Community > Affiliations > Affiliations Gantt Chart Setup > Affiliations Gantt Setup**).

This example illustrates the fields and controls on the Chart Properties page. You can find definitions for the fields and controls later on this page.

Chart Properties

Institution: PSUNV PeopleSoft University

Chart Details

*Start Date: 01/01/2005 *End Date: 05/15/2011

Affiliation Milestone: STUDENT Milestone Symbol: Box

Chart Area Percentage: 090 %

Chart Width: 0590 Pixels Chart Height: 0500 Pixels

Affiliations per Page: 0004 Affiliations Start Row: 1

GridLine Type: Dash Dot

Chart Colors

User Controlled

Define colors to depict various Affiliations on a Gantt Chart

Personalize Find <input type="text"/> <input type="text"/> <input type="text"/> First 1-10 of 10 Last				
Affiliation Code	Chartbar Color	*Order		
ALUMN_TMPL	Yellow <input type="text"/>	1109	<input type="text"/>	<input type="text"/>
APPLICANT	Purple <input type="text"/>	1007	<input type="text"/>	<input type="text"/>
FATEST2B	Blu_Violet <input type="text"/>	9990	<input type="text"/>	<input type="text"/>
FATEST_2A	Green <input type="text"/>	9998	<input type="text"/>	<input type="text"/>
PROSPECT	Orange <input type="text"/>	1005	<input type="text"/>	<input type="text"/>
RECTR_TMPL	Blu_Violet <input type="text"/>	1002	<input type="text"/>	<input type="text"/>
STUDENT	Red_Orang <input type="text"/>	1006	<input type="text"/>	<input type="text"/>
TEST	Green <input type="text"/>	9996	<input type="text"/>	<input type="text"/>
TEST1	Magenta <input type="text"/>	1004	<input type="text"/>	<input type="text"/>
TESTAFF	Black <input type="text"/>	555	<input type="text"/>	<input type="text"/>

This page is used to define the chart details for the Person Affiliations Chart View. The Chart View is an alternate way to look at Person Affiliations in addition to the Table and Hierarchical views.

Field or Control	Description
Chart Start Date	Enter the Start Date of the period of time that the chart will display on the X-axis (horizontal). The chart only displays those affiliations that are within the range of the Start Date and End Date. If an Affiliation is not completely within the range, the Affiliation is not displayed.
Chart End Date	Enter the End Date of the period of time that the Gantt chart will display on the X-axis (horizontal).
Affiliation Milestone	Select an Affiliation to view in relationship to all other affiliations with which the person is associated. The Affiliation Milestone takes the start date of the Affiliation and denotes it as the milestone.
Milestone Symbol	Select a graphical symbol to display in the Chart for the Affiliation Milestone.
Chart Area Percentage	Enter the percentage of the page to use for the chart portion of the page; the remaining area is used for the table portion.
Chart Height	Enter the height of the chart area represented in pixels. Maximum value is 9999. Oracle recommends a value less than the display area and resolution value of the computer monitor.
Chart Width	Enter the width of the chart area represented in pixels. Maximum value is 9999. Oracle recommends a value less than the display area and resolution value of the computer monitor.
Affiliations Per Page	Enter the maximum number of Affiliations that can be displayed on the chart at one time.
Affiliation Start Row	Displays default value of 1.
Gridline Type	Select the gridline appearance.

Field or Control	Description
User Controlled	<p>Select this check box for the option of selecting the color and display order for each Affiliation displayed on the chart.</p> <hr/> <p>Note: If you select the User Controlled check box, you must select a Chartbar Color and enter a <i>unique</i> Order number for each Affiliation Code you want to display. Affiliation Codes that do not have both a Chartbar Color and Order assigned are not displayed in the Affiliations Chart View.</p> <hr/> <p>If the check box is NOT selected, the system no longer assigns a Chartbar Color, but adds a default Order number of 9999. If you do not want the Affiliation Code displayed, do not specify a color. To display the Affiliation Code, select a color and specify an order number from 1 - 9998. There are 18 available colors so if an institution has defined more than 18 Affiliation Codes, multiple Affiliation Codes will have the same Chartbar Color assigned.</p>
Chartbar Color	<p>Select a display color for the Affiliation.</p> <p>You must select one of the 18 available colors if you want the Affiliation to be displayed.</p>
Order	<p>Enter a unique number, up to 4 digits, to determine the order in which Affiliations are displayed on the chart.</p> <p>The default Order number is 9999. For an Affiliation to be displayed, you must specify an Order number between 1-9998 and a Chartbar Color. No two Affiliations can have the same order number</p>

Related Links

[Reviewing Affiliation Data in a Chart View](#)

Setting Up Affiliation Routing

This section discusses how to set up the Affiliation Routing page.

Page Used to Set up Affiliation Routing

Page Name	Definition Name	Navigation	Usage
Affiliation Routing	SCC_AFL_ROUTING	Set Up SACR > Common Definitions > Affiliations > Affiliation Routing	Associate Affiliations to nodes used for controlling the SCC_CONSTITUENT_SYNC message publish.

Setting Up Routings

Access the Affiliation Routing page (**Set Up SACR > Common Definitions > Affiliations > Affiliation Routing**).

This example illustrates the fields and controls on the Affiliation Routing page. You can find definitions for the fields and controls later on this page.

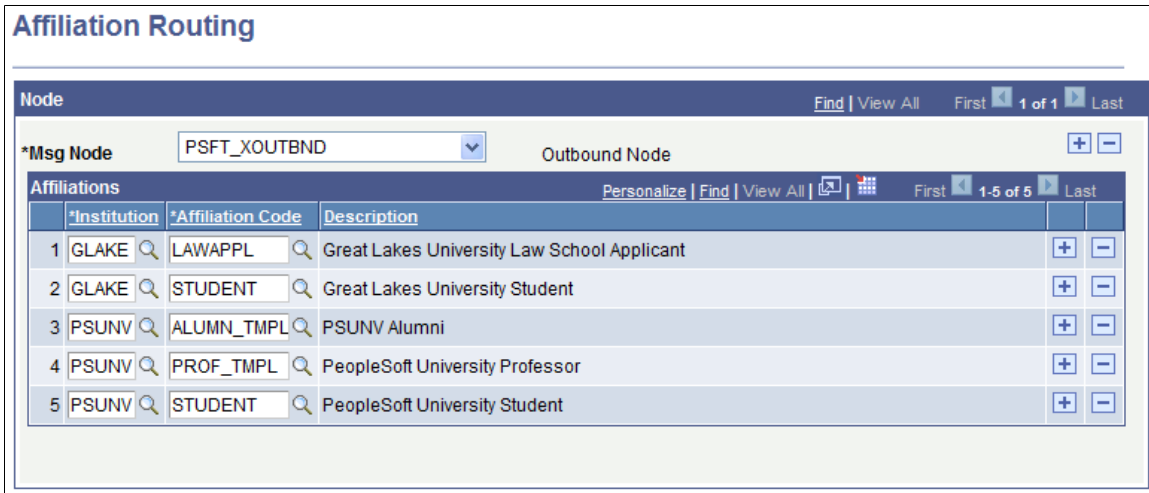

The Affiliations set on this page are used with a special message publishing handler that provides filtering control sending SCC_CONSTITUENT_SYNC Service Operation messages to external nodes. Once configured, only persons with the specified Affiliations will be published to the selected nodes.

Field or Control	Description
Msg Node	Select the node on which you want the affiliation routing settings to take effect.
Institution	Select the Institution for the affiliation code.
Affiliation Code	Select the Affiliation Code. Affiliations that you defined in Affiliation Setup are available for selection here.

See *PeopleSoft Campus Solutions Constituent Web Services Developer's Guide* in My Oracle Support (ID 1982192.1).

Chapter 7

Setting Up Biographical Information

Setting Up Names, Addresses, and Phone Numbers

See [Designing Campus Community](#).

Setting Up Personal Attributes

This section discusses how to:

- (NZL) Set up Statistics New Zealand ethnic group codes.
- (NZL) Map Statistics New Zealand ethnic codes to PeopleSoft ethnic groups.
- (NZL) Set up Single Data Return (SDR) country of citizenship codes.
- (NZL) Map SDR country of citizenship codes to PeopleSoft country codes.
- (NZL) Map SDR residency values to PeopleSoft residency values.
- (NZL) Set up codes for Iwi tribes.
- Define religious preference codes.
- Set up decedent data.

To define ethnic groups, see [Defining Ethnic Groups](#).

Pages Used to Set Up Personal Attributes

<i>Page Name</i>	<i>Definition Name</i>	<i>Navigation</i>	<i>Usage</i>
Ethnicity NZL	SSR_ETHNICITY_NZL	Set Up SACR > Product Related > Campus Community > Define Campus Community > Setup > Ethnicity NZL.	Set up Statistics New Zealand ethnic codes.
Ethnicity Map NZL	SSR_ETHNIC_MAP_NZL	Set Up SACR > Product Related > Campus Community > Define Campus Community > Setup > Ethnicity Map NZL.	Map Statistics New Zealand ethnic codes to PeopleSoft ethnic groups.

Page Name	Definition Name	Navigation	Usage
Citizenship NZL	SSR_CITIZEN_NZL	Set Up SACR > Product Related > Campus Community > Define Campus Community > Setup > Citizenship NZL	Set up SDR country of citizenship codes.
Citizenship Map NZL	SSR_CITIZEN_MAP	Set Up SACR > Product Related > Campus Community > Define Campus Community > Setup > Citizenship Map NZL	Map SDR country of citizenship codes to PeopleSoft country codes.
Residency Map NZL	SSR_RESIDENCY_MAP	Set Up SACR > Product Related > Campus Community > Define Campus Community > Setup > Residency Map NZL	Map SDR residency values to PeopleSoft residency values.
Iwi Table	SCC_TRIB_TBL	Set Up SACR > Product Related > Campus Community > Define Campus Community > Setup > Iwi Table	Set up codes for Iwi tribes.
Religious Preference Table	REL_PREF_TABLE	Set Up SACR > Product Related > Campus Community > Define Campus Community > Setup > Religious Preference Table	Define religious preference codes.

(NZL) Setting Up Statistics New Zealand Ethnic Codes

Access the Ethnicity (NZL) page (**Set Up SACR > Product Related > Campus Community > Define Campus Community > Setup > Ethnicity NZL**).

Campus Solutions provides Statistics New Zealand ethnicity codes and descriptions predefined. You can add new codes, but do not modify the delivered codes.

The code that you enter must be three digits in length.

(NZL) Mapping Statistics New Zealand Ethnic Codes to PeopleSoft Ethnic Groups

Access the Ethnicity Map NZL page (**Set Up SACR > Product Related > Campus Community > Define Campus Community > Setup > Ethnicity Map NZL**).

Field or Control	Description
Ethnicity Code (NZ)	<p>Enter the Statistics New Zealand numeric code for the ethnicity that you want to associate with this PeopleSoft ethnic group.</p> <p>This three-digit code is used to build the Ethnicity field reported in Single Data Return (SDR). This setup table maps the SSR_ETHNICITY_CODE to the ETHNIC_GRP_CD.</p>

Related Links

“Preparing for SDR Reporting” (Student Records)

(NZL) Setting Up SDR Country of Citizenship Codes

Access the Citizenship NZL page (**Set Up SACR > Product Related > Campus Community > Define Campus Community > Setup > Citizenship NZL**).

Field or Control	Description
Status	You can select a status of <i>Inactive</i> for codes that are not relevant to your institution—codes that are <i>Inactive</i> are not available for selection in the SDR Citizenship field on the Citizenship Map NZL page.

(NZL) Mapping SDR Country of Citizenship Codes to PeopleSoft Country Codes

Access the Citizenship Map NZL page (**Set Up SACR > Product Related > Campus Community > Define Campus Community > Setup > Citizenship Map NZL**).

Field or Control	Description
SDR Citizenship	<p>Select the SDR Citizenship value that you want to associate with the PeopleSoft country code.</p> <p>SDR Citizenship values are defined on the Citizenship NZL page—only values with an <i>Active</i> status are available for selection.</p> <p>This three digit code is used to build the Citizen field reported in the Single Data Return (SDR). This setup table maps SSR_Citizen to Country.</p>

(NZL) Map SDR Residency Values to PeopleSoft Residency Values

Access the Residency Map NZL page (**Set Up SACR > Product Related > Campus Community > Define Campus Community > Setup > Residency Map NZL**).

Use this page to map SDR residency values of *Y* or *N* to PeopleSoft residency values.

Field or Control	Description
NZ Residency Code	Select <i>Y</i> to indicate that the student is a New Zealand permanent resident. If this is set to <i>Y</i> , then set the AUST Residency Code field to <i>N</i> .
AUS Residency Code	Select <i>Y</i> to indicate that the student is an Australian permanent resident. If this is set to <i>Y</i> , then set the NZ Residency Code to <i>N</i> .

Values in the **Residency** field are based on the values defined on the Residency Table (RESIDENCY_TABLE) page.

See [Setting Up Residency Rules](#).

(NZL) Setting Up Codes for Iwi Tribes

Access the Iwi Tribes page (**Set Up SACR > Product Related > Campus Community > Define Campus Community > Setup > Iwi Table**).

Iwi codes are used in Single Data Return (SDR) reporting. The PeopleSoft system delivers Iwi codes and their descriptions predefined. The codes are 4 digits each, reported in a 12-character field in SDR. You can specify up to three codes for an individual, for a total of 12 characters.

Ethnic group is mapped to ethnicity code and reported in SDR. IWI is reported as is. There is no mapping from Iwi code to or from ethnic group. Iwi codes are reported from SCC_TRIBE_CODE in record SCC_IWI_TBL

Related Links

[“Preparing for SDR Reporting” \(Student Records\)](#)

Defining Religious Preference Codes

Access the Religious Preference Table page (**Set Up SACR > Product Related > Campus Community > Define Campus Community > Setup > Religious Preference Table**).

Campus solutions provides a few predefined religious preference codes. You can create additional codes for each religious preference that people at your institution might have. When you enter religious preferences for individuals, you can specify more than one.

Related Links

[Entering Religious Preferences](#)

Setting Up Decedent Data

When an individual dies, enter the date and place of death, and the death certificate number if you have it, on the Decedent Data page. When you enter and save the date of death on that page, the system displays the word *DECEASED* on each page in your database across your institution about that individual.

Note: All of the decedent's data continues to exist unless or until you delete the individual's ID.

Though you hope not to use this feature frequently, consider setting it up so it is available when the need arises.

See [Setting Up Service Impacts](#).

Setting Up Self-Service Ethnicity Reporting

This section discusses how to set up self-service ethnicity options for customers based in the USA and other countries, wanting to survey their faculty, staff, and students to collect IPEDS information.

Page Used to Set Up Self-Service Ethnicity Reporting

<i>Page Name</i>	<i>Definition Name</i>	<i>Navigation</i>	<i>Usage</i>
Self Service Ethnicity Setup	SCC_SS_ETHSTUP_USA	Set Up SACR > Common Definitions > Self Service > Self Service Ethnicity Setup	Allow and configure entry of ethnicity data on self-service pages including the Profile functional area for the PeopleSoft Fluid User Interface.

Setting Up Self-Service Ethnicity Options

Access the Self Service Ethnicity Setup page (**Set Up SACR > Common Definitions > Self Service > Self Service Ethnicity Setup**).

This example illustrates the fields and controls on the Self Service Ethnicity Setup page (1 of 3). You can find definitions for the fields and controls later on this page.

Self Service Ethnicity Setup

Answer Mapping

*Hispanic <input type="text" value="Hispanic/Latino"/>	*Not Hispanic <input type="text"/>
*American Indian or Alaska Native	<input type="text" value="American Indian/Alaska Native"/>
*Asian	<input type="text" value="Asian"/>
*Black or African American	<input type="text" value="Black/African American"/>
*Native Hawaiian or Other Pacific Islander	<input type="text" value="Native Hawaiian/Other Pacific Islander"/>
*White	<input type="text" value="White"/>
*No Response	<input type="text" value="Not Specified"/>

Functional Area Setup

Functional Area Faculty Center

Welcome/Instructions Text

*Message Set Number <input type="text" value="14000"/>	*Message Number <input type="text" value="506"/>
---	---

Message Text There are certain governmental recordkeeping and reporting requirements for the administration of civil rights laws and regulations. In order to comply with these laws, students are invited to voluntarily self identify their race or ethnicity.

The information obtained will be kept confidential and may only be used in accordance with the provisions of applicable laws, executive orders, and regulations. When reported, data will be aggregated and will not identify any specific individual.

This example illustrates the fields and controls on the Self Service Ethnicity Setup page (2 of 3). You can find definitions for the fields and controls later on this page.

First Question Text

'Message Set Number' 'Message Number'

Message Text 1) Are you Hispanic or Latino?

Second Question Text

'Message Set Number' 'Message Number'

Message Text 2) What is your race? Select one or more.

Additional Background Information

Collect Additional Information Display Primary Display Percentage

Background Question Text

Message Set Number Message Number

Message Text (Optional) Which best describes your background? Select one or more.

Ethnic Groups to Display Customize | Find | View All | First 1 of 1 Last

#	Ethnic Group	Description	
1	<input type="text" value=""/>		+ -

This example illustrates the fields and controls on the Self Service Ethnicity Setup page (3 of 3). You can find definitions for the fields and controls later on this page.

Ethnicity Page Edit Control

Display Only

Display Only Text

'Message Set Number' 'Message Number'

Message Text If the information is wrong, contact your administrator

This setup component enables institutions to define setup choices for each self-service center and the Ethnicity pages in the Fluid Profile. The choices you make here affect the options that appear on the self-service Ethnicity pages.

See “Using Self-Service Personal Attributes Data” (Campus Self Service).

Answer Mapping

The selections made for these seven Answer Mapping values apply to all three self-service centers.

Field or Control	Description
Hispanic	Select the value to be inserted into the Ethnicity records if the person answers Yes to the question "Are you Hispanic or Latino?" Only active, current Ethnic Group values with an EEO Ethnic Group = 3 (Hispanic) are returned in this prompt.
Not Hispanic	Select the value to be inserted into the Ethnicity records if the person answers No to the question "Are you Hispanic or Latino?" All active, current Ethnic Group values are returned in this prompt, including the USA value <i>NHISPA</i> (Not Hispanic), added with Ethnic Group 6. Records where SETID=SHARE are filtered out.

Field or Control	Description
<p>American Indian or Alaska Native, Asian, Black or African American, Native Hawaiian or Other Pacific Islander, White, and No Response</p>	<p>Select the value to be inserted into the Ethnicity records depending on the user's responses to the question "What is your race? Select one or more."</p> <p>The prompts return values respective to the EEO Ethnic Group related to the label as follows:</p> <p><i>American Indian or Alaska Native</i> returns only active current ethnic groups mapped to an EEO Ethnic Group = '5' (American Indian or Alaska Native).</p> <p><i>Asian</i> returns only active current ethnic groups mapped to an EEO Ethnic Group = '4' (Asian).</p> <p><i>Black or African American</i> returns only active current ethnic groups mapped to an EEO Ethnic Group = '2' (Black or African American).</p> <p><i>Native Hawaiian or Other Pacific Islander</i> returns only active current ethnic groups mapped to an EEO Ethnic Group = '7' (Native Hawaiian or Other Pacific Islander).</p> <p><i>White</i> returns only active current ethnic groups mapped to an EEO Ethnic Group = '1' (White).</p> <p><i>No Response</i> returns only active current ethnic groups mapped to an EEO Ethnic Group = '6' (Not Specified). Records where SETID=SHARE are filtered out.</p> <hr/> <p>Note: Oracle strongly recommends that you use either the delivered ethnic group for <i>Not Hispanic</i> or your created ethnic group mapped to EEO Ethnic Group = 6. Define different Answer Mapping values for the Not Hispanic and No Response fields.</p> <hr/>

Functional Area Setup

These fields are specific to the functional area selected – Student Center, Faculty Center or Profile– as determined by the selection made in the Functional Area field.

Campus Personal Information reflects the setup for either the Student Center, Faculty Center or Profile, depending on security setup for the user. For students, activate the Self Service Ethnicity component on the CC_PORTFOLIO_2 menu in a user's security setup. For faculty, activate the Self Service Ethnicity component on the CC_PORTFOLIO_3 menu in a user's security setup. If both are activated in a user's security permission lists, two Ethnicity links appear in the menu. To avoid confusion, activate only one for a user at any time. For users without access to either Faculty Center or Student Center, the Self Service Ethnicity component will be part of the CC_PORTFOLIO component in the user's permission lists.

Field or Control	Description
Functional Area	The functional area you selected on the Self Service Ethnicity Setup search page appears here. It indicates for which component the setup choices apply. The delivered values are <i>Student Center, Faculty Center, and Profile</i> .
Include IPEDS Ethnicity	Applicable only to the Profile Functional Area. Select the check box to display the Ethnicity tab/page on the Profile page. The check box is not selected by default.
Welcome Instructions/Text	<p>Enter the Message Set Number and Message Number to appear as introductory text, as well as the specific message to appear in the introductory section of the page. The Message Text field displays the text from the Message Catalog for the selected message number. The delivered message set number and message number for the Welcome Instructions are set as the defaults. The text of this message may be changed using the Message Catalog.</p> <p>For the Profile Functional Area, the Welcome/Instructions Text region is hidden and the Message Set Number and Message Number fields (SCC_MSG_SET_INTRO, SCC_MSG_NBR_INTRO) are not required to save the record. The instructional text for the Fluid Ethnicity pages are set up in the Text Catalog.</p>
First Question Text	<p>Enter the Message Set Number and Message Number to appear as the first ethnicity question on the page. The Message Text field displays the text from the Message Catalog for the selected message number. The delivered message set number and message number for the First Question are set as the defaults. The text of this message may be changed using the Message Catalog.</p> <p>For the Profile Functional Area, the First Question Text is enabled and required only if Include IPEDS Ethnicity is selected. A message 14060, 253 is delivered specifically for use on the Fluid Profile page.</p>

<i>Field or Control</i>	<i>Description</i>
Second Question Text	<p>Enter the Message Set Number and Message Number to appear as the follow-up ethnicity question on the page.</p> <p>The Message Text field displays the text from the Message Catalog for the selected message number. The delivered message set number and message number for the Second Question are set as the defaults. The text of this message may be changed using the Message Catalog.</p> <p>For the Profile Functional Area, the Second Question Text is enabled and required only if Include IPEDS Ethnicity is selected. A message 14060, 254 is delivered specifically for use on the Fluid Profile page.</p>

Additional Background Information

<i>Field or Control</i>	<i>Description</i>
Collect Additional Information	<p>Select this check box to indicate that the system displays a Background Information grid on the Self Service Ethnicity page to collect additional background detail. Collecting additional background information is optional and not required by IPEDS.</p> <p>If selected in the Profile functional area, the Ethnic Background tab/page is displayed.</p>
Display Primary	Select this check box to indicate that the system displays a Primary column in the Background Information grid.
Display Percentage	Select this check box to indicate that the system displays a Percentage column in the Background Information grid.

Field or Control	Description
Background Question Text	<p>If you selected the Collect Additional Information check box, enter the Message Set Number and Message Number to appear as the additional background question on the page.</p> <p>The Message Text field displays the text from the Message Catalog for the selected message number. The delivered message set number and message number when collecting additional background information are set as the defaults.</p> <p>The text of this message may be changed using the Message Catalog.</p> <p>For the Profile Functional Area, the Background Question Text is optional. Unless defined, no text is displayed on the Ethnic Background page. A message 14060, 256 is delivered specifically for use on the Fluid Profile page.</p>
Ethnic Groups to Display	<p>Enter ethnic group codes to appear in the Background Information grid or the Ethnic Background tab/page as available choices. Only ethnic group codes selected here are included in the Background prompt in the Self Service Ethnicity Page Background Information grid.</p>

Note: If you choose to collect additional background information, the values selected to be displayed in self service should include at least one additional ethnic group for each of the racial categories, beyond what is selected in the Answer Mapping region for each racial category. In addition, it is recommended that you provide an 'Other' option for each racial category, such as Asian–Other, American Indian or Alaska Native–Other, and so on. This provides the self-service user with a choice beyond those specific ethnic groups you have selected to display.

Ethnicity Page Edit Control

Field or Control	Description
Display Only	<p>Select this check box to indicate whether this page should be open for editing or appear as display-only information.</p>

Field or Control	Description
Display Only Text	<p>If you select the Display Only check box, and the Functional Area is not <i>Profile</i>, enter the Message Set Number and Message Number to appear on the page when the page is unavailable for editing. The Message Text field displays the text from the Message Catalog for the selected message number. The delivered message set number and message number that will be used when the page is Display Only are set as the defaults. The text of this message may be changed using the Message Catalog.</p> <p>For the Profile Functional Area, text is optional for the display-only version of the Ethnic Background page. A message 14060, 255 is delivered specifically for use on the Fluid Profile page.</p>

Setting Up Ethnicity For Non-USA Regions

If you select Profile as the functional area, the **Ethnic Groups to Display** page is displayed. You can set up a Regulatory Region other than the USA, and define Ethnic Group values for it. The default Regulatory Region is the USA.

Set up Regulatory Regions and Ethnic Groups on this page.



Field or Control	Description
Regulatory Region	Select only one regulatory region. Available values are sourced from the Regulatory Region Table (Set Up Common Objects > Install > Regulatory Region).
Ethnic Group	<p>Select ethnic groups for the regulatory region. Available values are based on the selected Regulatory Region Set ID (Set Up Common Objects > Product Related > Workforce Administration > Ethnic Groups).</p> <p>These selected ethnic group values (SCC_SS_ETH_DISP) become available for selection on the Ethnic Background Fluid page.</p>

Note: USA is the default Regulatory Region for updates related to Q1 and Q2 responses.

Setting Up FERPA Privacy Control

See [Making Data Available for FERPA Privacy Control](#).

Setting Up Individual Relationships

To set up individual relationships, use the Relationships component (RELATIONSHIP_TABLE) and the Relationship/Marital Status component (MAR_STATUS_TABLE).

This section discusses how to:

- Define reciprocal relationships.
- Enable marital status verification.

Pages Used to Set Up Individual Relationships

<i>Page Name</i>	<i>Definition Name</i>	<i>Navigation</i>	<i>Usage</i>
Relationship Table	RELATIONSHIP_TABLE	Set Up SACR > Product Related > Campus Community > Define Campus Community > Setup > Relationship Table	Define reciprocal individual relationships.
Relationship/Marital Status	MAR_STATUS_TABLE	Set Up SACR > Product Related > Campus Community > Define Campus Community > Setup > Relationship / Marital Status	Enable marital status so the system can verify the status when you create relationships between two individuals and warn you when data is inconsistent.

Defining Reciprocal Relationships

Access the Relationship Table page (**Set Up SACR > Product Related > Campus Community > Define Campus Community > Setup > Relationship Table**).

This example illustrates the fields and controls on the Relationship Table page. You can find definitions for the fields and controls later on this page.

Relationship Table

Relationship: Spouse

Gender: All Male Female Unknown

Limit Relationship:

Reciprocal Relationship

*Reciprocal Relation					-
Spouse	<input type="checkbox"/> All	<input type="radio"/> Male	<input type="radio"/> Female	<input checked="" type="radio"/> Unknown	-
Step-Daugh	<input type="checkbox"/> All	<input type="radio"/> Male	<input checked="" type="radio"/> Female	<input type="radio"/> Unknown	-
Friend	<input type="checkbox"/> All	<input type="radio"/> Male	<input type="radio"/> Female	<input checked="" type="radio"/> Unknown	-

Add

<i>Field or Control</i>	<i>Description</i>
Relationship	<p>The system displays the relationship (for example, mother, father, or employer) to modify or review.</p> <p>Values for this field are delivered with your system as translate values. Do not modify these values in any way. Any modifications to these values could require substantial programming effort.</p>
Gender	<p>Select the gender (such as male or female) that is associated with this relationship.</p> <p>For example, the associated gender for the relationship of <i>Mother</i> is usually <i>Female</i>. For the relationship of <i>Spouse</i>, the gender could be either male or female, so you would select <i>All</i>.</p> <p>Values for this field are delivered with your system as translate values. Do not modify these values in any way. Any modifications to these values could require substantial programming effort.</p>
Limit Relationship	<p>Select this check box to indicate that individuals can have only one of these relationships in your system at a time.</p> <p>For example, if you are defining the relationship of <i>Mother</i> and you select the <i>Limit Relationship</i> option, the system does not permit an individual to have more than one mother. If you are defining the relationship of <i>Spouse</i>, you probably want to select the <i>Limit Relationship</i> option to prevent an individual from having more than one spouse at a time.</p>

Reciprocal Relationship

If the Create Reciprocal Relationship check box is selected on the Campus Community Installation page, you must specify the reciprocal relationships and their associated genders here.

Field or Control	Description
Reciprocal Relation	<p>Identify the reciprocal relation associated with the relationship that you are defining. Each relationship can have up to three reciprocal relationships.</p> <p>For example, the reciprocal relationships associated with <i>Mother</i> are <i>Daughter</i> and <i>Son</i>, and for <i>StepMother</i>, <i>StepDaughter</i>, and <i>StepSon</i>. You might also include <i>Oth Relat</i> (other related) to cover those whose gender is specified as <i>Unknown</i> on the Biographical Details page. You can also choose <i>Plus Loan Borrower</i> (available only for CS/SFP integration) to cover a person other than a student who is a PLUS loan borrower.</p> <p>Values for this field are delivered with your system as translate values. Do not modify these values in any way. Any modifications to these values could require substantial programming effort.</p>
Gender	<p>Select the gender that is associated with the reciprocal relationship specified. Select either <i>All</i>, or <i>Male</i>, <i>Female</i>, or <i>Unknown</i>.</p> <p>For example, for <i>Daughter</i>, the associated gender is <i>Female</i>. For <i>Son</i>, it is <i>Male</i>.</p> <hr/> <p>Note: You can select the gender of <i>All</i> when only one reciprocal relationship exists. However, you cannot select <i>All</i> when a relationship has several reciprocals.</p> <hr/>

Enabling Marital Status Verification

Access the Relationship/Marital Status page (**Set Up SACR > Product Related > Campus Community > Define Campus Community > Setup > Relationship / Marital Status**).

Field or Control	Description
Marital Status	<p>Select the marital status to verify, usually <i>Married</i>.</p> <p>Values for this field are delivered with your system as translate values. Do not modify these values in any way. Any modifications to these values could require substantial programming effort.</p>

<i>Field or Control</i>	<i>Description</i>
Relationship	Specify the relationship type to verify in association with the specified marital status, typically the status of <i>Married</i> and the relationship of <i>Spouse</i> .

Setting Up Relations to the Institution

To set up relations to the institution, use the Legacy Table component (LEGACY_TABLE).

This section discusses how to define or review legacy affiliation types that are used to identify relations to the institution.

Page Used to Set Up Relations to the Institution

<i>Page Name</i>	<i>Definition Name</i>	<i>Navigation</i>	<i>Usage</i>
Legacy Table	INST_AFFIL_TABLE	Set Up SACR > Product Related > Campus Community > Define Campus Community > Setup > Legacy Table	Define the types of legacy affiliations that individuals can have with your institution.

Defining Legacy Affiliation Types

Access the Legacy Table page (**Set Up SACR > Product Related > Campus Community > Define Campus Community > Setup > Legacy Table**).

This example illustrates the fields and controls on the Legacy Table page. You can find definitions for the fields and controls later on this page.

Legacy Table

Affiliation: ALUM

Legacy Detail					
*Effective Date	*Status	*Description	Short Description	Include Institution Info	
01/01/1900 <small>BT</small>	Active <small>▼</small>	Alumni	Alumni	<input checked="" type="checkbox"/>	<small>+</small> <small>-</small>

Field or Control	Description
Include Institution Info	<p>Select this check box to include the academic information relevant to the specified legacy relationship when this affiliation is selected for the related individual on the Legacy Information page in the Relationship component.</p> <p>For example, if you want to know the institution that a related individual with this affiliation attended, and the academic program in which he or she was enrolled, select the <i>Include Institution Info</i> check box to ensure that the institution and academic program fields will be available on the Legacy Information page.</p>

Related Links

“Establishing Relationships” (Contributor Relations)

Setting Up Emergency Contacts Data

There is no specific setup for emergency contacts data. However, before you can enter emergency contacts for an individual. Names and addresses must be set up and the individual whose contacts you want to enter must exist in your database.

Related Links

[Entering Emergency Contact Data](#)

(USA) Setting Up Work Experience Classification Codes

To set up work experience classification codes, use the Standard Industry Table component (US_SIC_TABLE) and the Standard Occupation Table component (US_SOC_TABLE).

This section discusses how to:

- Add or review Standard Industry Classification (SIC) codes.
- Add Standard Occupation Classification (SOC) codes.

Note: If you implement Campus Solutions *and* a separate instance of PeopleSoft Human Capital Management, read the relevant documentation about CS-HCM Integration to understand the setup, functional, and technical implementation considerations. See:

“Integrating Person Data” (Campus Solutions Application Fundamentals)

“Integrating Setup Data” (Campus Solutions Application Fundamentals)

“Monitoring Integrations Using the Integrity Utility” (Campus Solutions Application Fundamentals)

See *Information Center: CS-HCM Integration for PeopleSoft Enterprise Campus Solutions* in My Oracle Support (ID 2091799.2).

Pages Used to Set Up Work Experience Classification Codes

<i>Page Name</i>	<i>Definition Name</i>	<i>Navigation</i>	<i>Usage</i>
Standard Industry Table	US_SIC_TABLE	Set Up SACR > Product Related > Campus Community > Define Campus Community > Setup > Standard Industry Table	Add or review valid Standard Industry Classification (SIC) codes.
Standard Occupation Table	US_SOC_TABLE	Set Up SACR > Product Related > Campus Community > Define Campus Community > Setup > Standard Occupation Table	Add or review the valid Standard Occupation Classification (SOC) codes.

Adding or Reviewing SIC Codes

Access the Standard Industry Table page (**Set Up SACR > Product Related > Campus Community > Define Campus Community > Setup > Standard Industry Table**).

Campus Solutions provides Standard Industrial Classification (SIC) codes loaded in the table. Your institution is responsible for making sure the codes are current and that they reflect any changes made by the U.S. Department of Labor.

See: SIC codes list from the U.S. Department of Labor

Adding SOC Codes

Access the Standard Occupation Table page (**Set Up SACR > Product Related > Campus Community > Define Campus Community > Setup > Standard Occupation Table**).

Campus Solutions provides Standard Occupational Classification (SOC) codes loaded in the table. Your institution is responsible for making sure that the codes are current and that they reflect any changes made by the U.S. Department of Labor.

See SOC codes list from the U.S. Department of Labor.

Chapter 8

(AUS) Setting Up and Managing USI Processes

Understanding USI

The Unique Student Identifier (USI) is a legislative requirement for Vocational Education and Training (VET) institutions in Australia. The USI forms a link between a student record and the national source of VET training data maintained by the National Centre for Vocational Education and Training (NCVER).

The USI is a random 10-digit alphanumeric code generated by the Australian USI agency for every student. The USI is associated with the individual student for life and is recorded for any nationally recognized VET course undertaken from 2015 onwards.

Processing USI Information as Administrator

This topic discusses how to:

- Verify a USI record.
- Run a USI Bulk Process.
- Review Bulk USI Request records.
- Clean Up USI records.

Pages Used by Administrators to Access USI Records

<i>Page Name</i>	<i>Definition Name</i>	<i>Navigation</i>	<i>Usage</i>
USI	SCC_USI_ADMIN_REQ	Campus Community > Personal Information (Student) > Biographical (Student) > Personal Attributes > USI	Verify a USI record and review previous requests.
Run USI Bulk Process	SCC_USI_BULK_ADMIN	Campus Community > Personal Information (Student) > Biographical (Student) > Personal Attributes > Run USI Bulk Process	Submit USI verification requests for up to 500 students.

Page Name	Definition Name	Navigation	Usage
Review Bulk USI Request	SCC_USI_BULK_RVW	Campus Community > Personal Information (Student) > Biographical (Student) > Personal Attributes > Review Bulk USI Process	Review Bulk USI Request results.
Clean Up USI Process	SCC_USI_ADMIN_CLEN	Campus Community > Personal Information (Student) > Biographical (Student) > Personal Attributes > Clean Up USI Process	Delete old Student USI Requests.

Verifying USI Records

Use this page to verify USI records. Also use this page to review previous successful and unsuccessful requests processed through the USI page and the Bulk USI Process, and by the student in Self-Service.

Access the USI page (**Campus Community > Personal Information (Student) > Biographical (Student) > Personal Attributes > USI**).

Note: Search by EmpID on the USI page to retrieve a student's information.

This example illustrates the fields and controls on the Unique Student Identifier page.

Unique Student Identifier

Locherty, Betty ID KU0007

Unique Student Identifier:

Personal Details

Name:

Date of Birth: 07/06/1945

Response Details

Created By:	PS
Created:	09/30/2014 5:11:59AM
Updated By:	PS
Last Updated On:	09/30/2014 5:11:59AM
<hr/>	
USI Processing:	Batch
USI Request ID:	12345
USI Application ID	2
Retrieve Date/Time	09/30/2014 5:11AM
User ID	PS
<hr/>	
USI Status:	Valid
First Name Match:	Match
Family Name Match:	Match
Single Name Match:	
Birth Date Match:	Match

Enter the USI code in the **Unique Student Identifier** box and select **Submit**. Your entry is validated by the USI check digit algorithm contained in the **Unique Student Identifier** field. The USI Agency returns a detailed response and creates a new National ID record for the USI if the verification is successful.

Running the Bulk USI Process

Use this page to run an existing Bulk USI process or create a new Run Control ID specifying the number of USI applications to process at a time.

Access the Run Bulk USI Process page (**Campus Community > Personal Information (Student) > Biographical (Student) > Personal Attributes > USI > Run Bulk USI Process**).

<i>Field or Control</i>	<i>Description</i>
Maximum Submission Size	The number of student requests to be sent in each USI web service call. The maximum is 500 requests.

Reviewing a Bulk USI Request

Review Bulk USI Request records and the status of student application records in the batch.

Access the Review Bulk USI Request page (**Campus Community > Personal Information (Student) > Biographical (Student) > Personal Attributes > USI > Review Bulk USI Request**).

This example illustrates the fields and controls on the Review Bulk USI Request page. You can find definitions for the fields and controls later on this page.

Review Bulk USI Request

Request ID: 12345

Receipt Number:

Submit Date/Time: 09/30/14 5:11AM **No of Applications:** 124

Retrieve Date/Time: 09/30/14 5:11AM **No of Failed:** 7

Select Option

Student ID
 Batch Display

View Log Messages

First EmplID: KU0007 **to:** SFAUS001 **Total EmplID:** 2

Start EmplID: KU0007 **to:** SFAUS001 ⏪ ⏩

	Empl ID	Name	USI Status	Details
1	KU0007	Locherty, Betty	Valid	Details
2	SFAUS001	Goldsmith, Anna May	Valid	Details

<i>Field or Control</i>	<i>Description</i>
Request ID	A sequence-generated unique number that can never be reused with the same OrgCode. If the maximum submission size is met, the process creates multiple Request IDs and submits each request batch separately.

<i>Field or Control</i>	<i>Description</i>
Receipt Number	The receipt number for this batch returned by the web service.
Number of Applications	The number of applications in the batch.
Number of Failed	The number of failed student USI applications in the batch.
Select Option Select Student ID or Batch Display	Select Student ID to enter and search by an ID. Select Batch Display to view details of student USI records in the batch. Use the navigation buttons to navigate through the records.

Cleaning Up USI Records

Use the Clean Up USI process to delete student USI requests and Bulk USI request records with a Retrieve Date/Time older than the value specified in the **Clean Up After Days** field.

<i>Field or Control</i>	<i>Description</i>
Clean Up After Days	The number of days after a successful verify process.

Access the Clean Up USI Process page (**Campus Community > Personal Information (Student) > Biographical (Student) > Personal Attributes > USI > Clean Up USI Process**).

Setting Up USI Submission Details

This topic discusses how to:

- Set up USI AUS information.
- Set up USI integration.

Pages Used to Set Up USI

<i>Page Name</i>	<i>Definition Name</i>	<i>Navigation</i>	<i>Usage</i>
USI Setup AUS	SCC_USI_SETUP_DTL	Set Up SACR > Product Related > Campus Community > Establish People Processing > Setup > USI Setup AUS	Record details needed to populate USI fields.

Page Name	Definition Name	Navigation	Usage
USI Integration Setup	SCC_USI_IB_SETUP	Set Up SACR > Product Related > Campus Community > Establish People Processing > Setup > USI Integration Setup	Integrate your student system with the USI web services.

Setting up USI AUS Information

Use this page to record details needed to populate Unique Student Identifier (USI) fields.

Access the USI Setup AUS page (**Set Up SACR > Product Related > Campus Community > Establish People Processing > Setup > USI Setup AUS**).

Field or Control	Description
USI Org Code	Enter the institution's organization code issued by the USI Registrar.
National ID Country	Select the country's National ID from the National ID table.
National ID Type	Select a National ID type from the National ID Type table.
Name Usage	Select the name format preferred for USI submissions.
Last Request ID Used	The last Request ID generated by the Bulk Create USI process. See Processing USI Information as Administrator for more information.

Setting up Integration With the USI Agency Website

Use this page to set up details for integration with the USI Agency website.

Access the (**USI VISA Mapping page > Set Up SACR > Product Related > Campus Community > Establish People Processing > Setup > USI Integration Setup**).

Enter appropriate values for the following fields:

Field or Control	Description
WSDL File	The location of the BatchCreateService.wsdl file from the USI Agency.
Keystore Location	The location of the KeyStore.xml file from the USI Agency.

<i>Field or Control</i>	<i>Description</i>
USI Credential ID	The credentials to use in the keystore, typically contains your Australian Business Number (ABN).
Keystore Password	The password of the keystore.xml file provided by the USI Agency.
Truststore Location	The location of the truststore/pskey file created by your institution with certificates from the AUSKey and USI websites.
Truststore Password	The password for the truststore created by your institution.

Chapter 9

(NZL) Setting Up for NSI Processing

Understanding NSI Processing Setup

The New Zealand Ministry of Education maintains the NSI and assigns National Student Numbers (NSNs). The Ministry requires that you maintain certain data for students, that you report any changes to that data, and that you request NSNs for students at your institution who do not have NSNs.

Note: It is important that you clearly understand the New Zealand Ministry of Education NSI process before you begin using PeopleSoft NSI functionality. Consult the Guide to Integrating with National Student Index (GINS) available on the Ministry of Education web site www.minedu.govt.nz. The PeopleSoft solution is based on Version 2.0 - May 2002 of the GINS document.

PeopleSoft provides batch processes to facilitate the exchange of information to and from NSI. The processes are discussed in the (NZL) Managing NSI Data section.

To facilitate NSI change reporting, you can set your PeopleSoft system to automatically add updated records to the NSI Suspense Table when online changes are made to any of the required NSI fields. The NSI Suspense Table is the repository for data that you want to send to NSI and for the data that you receive back from NSI. With updated records automatically added to the suspense table, the latest data is in one place, ready to extract and send to NSI.

To set up NSI change processing:

1. Select the **Enable Online NSI Processing** check box on the Extensions page of the CC Installation component to enable the functionality.

When this check box is selected, any changes made to an ID that is NSI enabled (step 4) will trigger Integration Broker to determine if the change is to a required NSI field. For more information, see [Understanding NSI Fields](#).

2. Activate PeopleTools Integration Broker to either insert a row inside the NSI Suspense Table at save time when a change is made with a current effective date inside the Add/Update a Person component (SCC_BIO_DEMO_DATA), or to insert a row inside the NSI Future Suspense table (SCC_NSI_SUSFUTR) when a change is made with a future effective date.
3. Run the Suspense Futures application engine program (SCCNSISUSFUT) to move data from the NSI Future Suspense table to the NSI Suspense Table when a change with a future date becomes current.
4. For each student with an NSN, confirm that the **NSI Processing Enabled** check box is selected on the Regional page of the Add/Update a Person component.

Note: The Request NSN process (CCNSIRQN), which is the process that identifies students in your database who need NSNs, selects the **NSI Processing Enabled** check box as part of the process. You can also select the check box manually.

See [Requesting NSNs](#).

Accessing the NSI Website

To access the NSI, you must request a login ID and password from the New Zealand Ministry of Education and be able to access the Ministry of Education website.

Setting Up NSI Change Processing

This section discusses how to:

- Enable NSI change processing.
- Activate PeopleTools Integration Broker for NSI.
- Schedule the NSI Suspense Future program.

Enabling NSI Change Processing

Select the **Enable Online NSI Processing** check box on the Extensions page of the CC Installation component.

See [\(NZL\) Reviewing or Defining Default Installation Settings for National Student Index Processing](#).

Activating PeopleTools Integration Broker for NSI

In PeopleSoft Application Designer, set the PERSON_BASIC_SYNC message subscription SCC_NSI_PERSON_SYNC to *Active*.

In PeopleTools Integration Broker, verify or add the transaction message PERSON_BASIC_SYNC with an *Active* status to the InAsync and OutAsync node definitions for the "internal" version.

In PeopleTools Integration Broker, verify that service operation monitor is set to PERSON_DATA with a status of *Running*.

See:

- *PeopleTools: Application Designer Developer's Guide* "Using PeopleSoft Application Designer, Viewing and Editing Definition Properties"
- *PeopleTools: Integration Broker*

Scheduling the NSI Suspense Future Program

In PeopleSoft Application Engine, schedule the Suspense Future program (SCCNSISUSFUT) with a process frequency of *Always* and a recurrence that runs once per day sometime after midnight but before the opening of business (for example, *EffectiveDateChange*).

See *PeopleTools: Application Engine* "Managing Application Engine Programs," Running Application Engine Programs.

(USA) Setting Up PeopleSoft SEVIS Solution Visa Processing for J and F/M Visas

Setting Up SEVIS Visa Processing

To set up general SEVIS visa processing, use the following components: SEVIS Setup (SEV_SETUP_TBL), Country Mapping (SEV_COUNTRY_MAP), Visa Mapping (SEV_VISA_MAP), Suffix Mapping (SEV_SUFFIX_MAP), SEVIS Event Types (SEV_EVENT_TYPE) and SEVIS File Errors (SEV_FILE_ERROR).

This section discusses how to:

- Define your institution.
- Map to SEVIS country data.
- Map to SEVIS visa types.
- Map to SEVIS name suffixes.
- Map to SEVIS event types.
- Define SEVIS file error messages.

See [Reference Manual for the Student and Exchange Visitor Information System Batch Interface, Application Program Interface \(API\)](#).

Pages Used to Set Up SEVIS Visa Processing

<i>Page Name</i>	<i>Definition Name</i>	<i>Navigation</i>	<i>Usage</i>
SEVIS Setup	SEV_SETUP_TBL	Set Up SACR > Product Related > Campus Community > SEVIS > Common Definitions > SEVIS Setup	Specify details about your institution for student F and M visas or exchange visitor J visas.
Country Mapping	SEV_COUNTRY_TBL	Set Up SACR > Product Related > Campus Community > SEVIS > Common Definitions > Country Mapping	Reference the PeopleSoft and SEVIS country information for student F and M visas or exchange visitor J visas.

Page Name	Definition Name	Navigation	Usage
Visa Mapping	SEV_VISA_TBL	Set Up SACR > Product Related > Campus Community > SEVIS > Common Definitions > Visa Mapping	Reference the PeopleSoft and SEVIS visa type information for student F and M visas or exchange visitor J visas.
Suffix Mapping	SEV_SUFFIX_TBL	Set Up SACR > Product Related > Campus Community > SEVIS > Common Definitions > Suffix Mapping	Reference the PeopleSoft and SEVIS name suffix information for student F and M visas or exchange visitor J visas.
SEVIS Event Types	SEV_EVENT_TYPE	Set Up SACR > Product Related > Campus Community > SEVIS > Common Definitions > SEVIS Event Types	Set up event types for your institution for student F and M visas or exchange visitor J visas.
SEVIS File Errors	SEV_FILE_ERROR	Set Up SACR > Product Related > Campus Community > SEVIS > Common Definitions > SEVIS Setup > SEVIS File Errors	Reference the DHS file upload error messages for student F and M visas or exchange visitor J visas.

Defining Your Institution

Access the SEVIS Setup page ((**Set Up SACR > Product Related > Campus Community > SEVIS > Common Definitions > SEVIS Setup**)).

This example illustrates the fields and controls on the SEVIS Setup page. You can find definitions for the fields and controls later on this page.

SEVIS Setup

Address Type Map

*US:	Home	▼
*Foreign:	Permanent	▼
Mailing:	Mailing	▼

Name Type Map

*Family Name:	Primary	▼
Preferred Name F/M:	Preferred	▼
Preferred Name J:	Preferred	▼
Passport Name F/M:	Other	▼
Passport Name J:	Other	▼
Dummy First Name	fnu	

SEVIS Schema Location

URL:	http://www.ice.gov/xmlschema/sevisbatch/alpha
------	---

Academic Institution

[Find](#) | [View All](#) First ◀ 1 of 2 ▶ [Last](#)

*Institution:	PSCCS	PS Community College System	+ -
---------------	-------	-----------------------------	-----

Distance Learning Instruction Mode

[Find](#) | [View All](#) First ◀ 1 of 1 ▶ [Last](#)

Instruction Mode:		+ -
-------------------	--	-----

Academic Career

[Find](#) | [View All](#) First ◀ 1 of 1 ▶ [Last](#)

*Academic Career:	CRED	Semester Credit	+ -
*Minor Populated In:	Acad Plan ▼		

<div style="background-color: #4a7ebb; color: white; padding: 2px; margin-bottom: 5px;">Minor</div> <div style="text-align: right; margin-bottom: 5px;"> Find View All First ◀ 1 of 1 ▶ Last </div> <table style="width: 100%; border-collapse: collapse;"> <tr> <td style="width: 20%;">Plan Type:</td> <td style="width: 40%;">Specialztn</td> <td style="width: 40%; text-align: right;">▼</td> <td style="width: 10%; text-align: right;">+ -</td> </tr> </table>	Plan Type:	Specialztn	▼	+ -	<div style="background-color: #4a7ebb; color: white; padding: 2px; margin-bottom: 5px;">Major</div> <div style="text-align: right; margin-bottom: 5px;"> Find View All First ◀ 1-3 of 3 ▶ Last </div> <table style="width: 100%; border-collapse: collapse;"> <tr> <td style="width: 20%;">*Academic Plan Type:</td> <td style="width: 40%;">Concentrtn</td> <td style="width: 40%; text-align: right;">▼</td> <td style="width: 10%; text-align: right;">+ -</td> </tr> <tr> <td>*Academic Plan Type:</td> <td>Major</td> <td style="text-align: right;">▼</td> <td style="text-align: right;">+ -</td> </tr> <tr> <td>*Academic Plan Type:</td> <td>Preparatn</td> <td style="text-align: right;">▼</td> <td style="text-align: right;">+ -</td> </tr> </table>	*Academic Plan Type:	Concentrtn	▼	+ -	*Academic Plan Type:	Major	▼	+ -	*Academic Plan Type:	Preparatn	▼	+ -
Plan Type:	Specialztn	▼	+ -														
*Academic Plan Type:	Concentrtn	▼	+ -														
*Academic Plan Type:	Major	▼	+ -														
*Academic Plan Type:	Preparatn	▼	+ -														

Warning! You must define all careers used in SEVIS on the SEVIS Setup page and map at least one major academic plan type for each career. If you do not do this, you cannot view the primary and secondary majors on the I-20 form for F and M visas or the subject field codes on the DS-2019 J visas form, and the alerts process extracts a blank value.

Copyright © 1988, 2024, Oracle and/or its affiliates.

215

Address Type Map

Field or Control	Description
US	Select the address type in the United States to report to SEVIS.
Foreign	(F and M visas only) Select the address type in the student's country of citizenship to report to SEVIS.
Mailing	Optional. Select the address type that is reported as the mailing address for exchange visitors (J).

Name Type Map

Field or Control	Description
Family Name	Select the name type to report to SEVIS. This name appears on the I-20 or DS-2019 form.
Preferred Name F/M	Optional. The value you set determines which name populates Preferred Name for F/M in alerts and SEVIS Master. If your institution decides not to report to SEVIS, you may choose not to populate this field. The value will be auto-populated at SEVIS.
Preferred F/M Dependents	Select whether or not to report values for dependents. By default, this check box is deselected, and is enabled <i>only</i> when a name type is defined for Preferred Name F/M .
Preferred Name J	Optional. The value you set determines which name populates Preferred Name for J in alerts and SEVIS Master. If your institution decides not to report to SEVIS, you may choose not to populate this field. The value will be auto-populated at SEVIS.
Preferred J Dependents	Select whether or not to report values for dependents. By default, this check box is deselected, and is enabled <i>only</i> when a name type is defined for Preferred Name J .

Field or Control	Description
Passport Name F/M	<p>Optional. The value you set determines which name populates Passport Name for F/M in alerts and SEVIS Master.</p> <p>If your institution decides not to report to SEVIS, you may choose not to populate this field.</p>
Passport F/M Dependents	<p>Select whether or not to report values for dependents.</p> <p>By default, this check box is deselected, and is enabled <i>only</i> when a name type is defined for Passport Name F/M.</p>
Passport Name J	<p>Optional. The value you set determines which name populates Passport Name for J in alerts and SEVIS Master.</p> <p>If your institution decides not to report to SEVIS, you may choose not to populate this field.</p>
Passport J Dependents	<p>Select whether or not to report values for dependents.</p> <p>By default, this check box is deselected, and is enabled <i>only</i> when a name type is defined for Passport Name J.</p>
Dummy First Name	<p>Optional. The value you set in this field is used as a substitute value in the First Name field for students with a single name.</p> <p>Only a single value is provided so your institution must make sure it consistently uses the same dummy value for all SEVIS students with a single name. As per SEVIS name standards, you should use the single name to populate the Last Name field.</p>

SEVIS Schema Location

<i>Field or Control</i>	<i>Description</i>
URL	<p>Enter the URL to send the data to, based on the SEVIS schema that you use (production, beta test, or alpha test). Do not put a backslash at the end of the file path.</p> <p>The Export SEVIS Events - F/M process and the Export SEVIS Events - J process inserts this location in the xml file that it produces. If you do not enter the schema location, the process will produce the xml file without the schema location and the file will be rejected by SEVIS.</p> <p>The locations for each SEVIS environment are:</p> <hr/> <p>Warning! These values may change according to updates in the API. You may need to modify them accordingly.</p> <hr/> <p>Production – http://www.ice.gov/xmlschema/sevisbatch</p> <p>Beta Test – http://www.ice.gov/xmlschema/sevisbatch/beta</p> <p>Alpha Test – http://www.ice.gov/xmlschema/sevisbatch/alpha</p>

Academic Institution

<i>Field or Control</i>	<i>Description</i>
Institution	Select the institution for which you are setting up SEVIS information.

Distance Learning Mode of Instruction

<i>Field or Control</i>	<i>Description</i>
Instruction Mode	<p>Select the mode by which Distance Learning courses are presented, for example <i>Television</i>, <i>Correspondence</i>, <i>World Wide Web</i>, and so on.</p> <p>Only one distance learning class can be used toward full time. The Auth Drop Below FC logic uses the Instruction Mode to find the distance learning class with the greatest number of units and uses it in calculating full time.</p>

Academic Career

Field or Control	Description
Academic Career	Select the academic career used at your institution.
Minor Populated In	<p><i>For F/M visa processing only. Does not apply to J visas.</i></p> <p>Select either <i>Acad Plan</i> or <i>Sub Plan</i>.</p>

Minor

For F/M visa processing only. Does not apply to J visas. The field and available choices in the **Minor** group box change according to your selection in the **Minor Populated In** field.

Field or Control	Description
Plan Type	<p>If you enter <i>Acad Plan</i> in the <i>Minor Populated In</i> field, the Plan Type field appears, and academic plans are available for selection.</p> <p>You must enter the type of academic plan. Select from:</p> <p><i>Concentrntn</i> (concentration)</p> <p><i>Honors</i></p> <p><i>Major</i></p> <p><i>Minor</i></p> <p><i>Prepratn</i> (preparation)</p> <p><i>ROTC</i> (Reserve Officer Training Corps)</p> <p><i>Specialztn</i> (specialization)</p> <p>The SEVIS Alerts – F/M process uses this value to determine which academic plan to extract as a minor.</p>

Field or Control	Description
Sub-Plan Type	<p>If you enter <i>Sub Plan</i> in the Minor Populated In field, the Sub-Plan Type field appears and subplans are available for selection.</p> <p>You must enter the type of subplan. Values are:</p> <p><i>Conc</i> (concentration)</p> <p><i>Emphasis</i></p> <p><i>Minor</i></p> <p><i>Option</i></p> <p><i>Spec</i>(specialization)</p> <p><i>Track</i></p> <p>The SEVIS Alerts - F/M process uses this value to determine which subplan to extract as a minor.</p>

Major (for F and M visas, and for J visas)

Field or Control	Description
Academic Plan Type	<p>For each academic career, select the academic plan type for the SEVIS Alerts process and the visa form logic to use.</p> <p>Select from <i>Concentrntn</i> (concentration), <i>Honors</i>, <i>Major</i>, <i>Minor</i>, <i>Prepratn</i> (preparation), <i>ROTC</i> (Reserve Officer Training Corps), and <i>Specialztn</i> (specialization).</p> <p>For F/M visas, the SEVIS Alerts – F/M process uses this logic to determine the primary and secondary majors to enter on the I-20 form.</p> <p>For J visas, the SEVIS Alerts – J process uses this logic to determine the subject field code to enter for the student category exchange visitors on the DS-2019 form.</p>

Mapping to SEVIS Country Data

Access the Country Mapping page (**Set Up SACR > Product Related > Campus Community > SEVIS > Common Definitions > Country Mapping**).

Note: The DHS defines the SEVIS country values in the lookup tables section of *Application Program Interface Document (API)*. The DHS may update the country codes from time to time. You must update or delete codes and descriptions to keep your system current with SEVIS.

Warning! The U.S. Minor Outlying Islands (UMIs) are not mapped to one DHS SEVIS country code. The PeopleSoft system uses International Standards Organization (ISO) country codes, which do not include separate country codes for each island. SEVIS, however, uses country codes defined by the Federal Information Processing Standards (FIPS 10-4), National Imagery and Mapping Agency, which include separate codes for each island – Baker Island (FQ), Holland Island (HQ), Jarvis Island (DQ), Johnston Island (JQ), Midway Island (MQ), Mavassa Island (BQ), Palmyra Island (LQ) and Wake Island (WQ). Your institution must determine the SEVIS code to map for UMIs.

Also, the following countries (listed alphabetically by FIPS code) do not exist in the PeopleSoft Country Table and are therefore not mapped: Ashmore and Cartier Islands (AT), Burma (BM), Navassa Island (BQ), Bassas Da India (BS), Central and Southern Line Islands (CL), Coral Sea Islands (CR), Czechoslovakia (CZ), Canton and Enderbury (EQ), Europa Island (EU), French Territory of the Afars and Issas (FT), German Democratic Republic (GC), Federal Republic of Germany (GE), Guernsey (GK), Gilbert and Ellice Islands (GN), Glorioso Islands (GO), Gilbert Islands (GS), Gaza Strip (GZ), Isle Of Man (IM), Clipperton Island (IP), United States Misc. Pacific Islands (IQ), Israel-Syria Demilitarized Zone (IU), Demilitarized Zone (IW), Iraq-Saudi Arabia Neutral Zone (IY), Jersey (JE), Jan Mayen (JN), Juan De Nova Island (JQ), Svalbard and Jan Mayen (JS), Kingman Reef (KQ), Spanish North Africa (ME), Montenegro (MW), Paracel Islands (PF), Spratly Islands (PG), Canal Zone (PQ), Portuguese Timor (PT), Southern Rhodesia (RH), Sikkim (SK), Swan Islands (SQ), Serbia (SR), Spanish Sahara (SS), Tromelin Island (TE), Trust Territory of The Pacific Islands (TQ), Union of Soviet Socialist Republics (UR), Uzbekistan (UZ), Democratic Republic of Viet-Nam (VN), Republic of Viet-Nam (VS), West Bank (WE), Wake Atoll (WQ), Yeman (Sanaa) (YE), Serbia and Montenegro (YI), Southern Ryukyu Islands (YQ), and Yemen (Aden) (YS).

The codes for Neutral Zone (U2), Stateless (U3), and Unknown (U5) are also not mapped.

Field or Control	Description
PS Country	Enter the country code used by the PeopleSoft system.
SEVIS Citizen/Perm Resident, SEVIS Birth Country, and SEVIS Passport Country	Enter the Federal Information Processing Standards (FIPS) country code used by SEVIS.

Mapping to SEVIS Visa Types

Access the Visa Mapping page (**Set Up SACR > Product Related > Campus Community > SEVIS > Common Definitions > Visa Mapping**).

Note: You must map each SEVIS visa type defined in *Application Program Interface (API)* to a PeopleSoft visa type. Consult the U.S. Immigrations and Customs Enforcement (ICE) web site.

Field or Control	Description
Country	Select the country to which the student is traveling. This is USA for SEVIS use.
PS Visa Type (PeopleSoft visa type)	Enter the PeopleSoft visa type code.

<i>Field or Control</i>	<i>Description</i>
SEVIS Visa Type	Enter the visa type code established by SEVIS.

Mapping to SEVIS Name Suffixes

Access the Suffix Mapping page ((Set Up SACR > Product Related > Campus Community > SEVIS > Common Definitions > Suffix Mapping).

Note: The DHS defines the SEVIS suffix values in the lookup tables section of the *Application Program Interface (API)*. The DHS may update the suffix codes from time to time. You must update or delete codes and descriptions to keep your system current with SEVIS. Consult the U.S. Immigrations and Customs Enforcement (ICE) web site.

<i>Field or Control</i>	<i>Description</i>
PS Name Suffix (PeopleSoft name suffix)	Select a name suffix from the available options.
SEVIS Suffix	Enter the corresponding DHS SEVIS name suffix for the selected PeopleSoft name suffix.

Mapping to SEVIS Event Types

Access the SEVIS Event Types page (Set Up SACR > Product Related > Campus Community > SEVIS > Common Definitions > SEVIS Event Types).

This example illustrates the fields and controls on the SEVIS Event Types page. You can find definitions for the fields and controls later on this page.

The screenshot shows the 'SEVIS Event Types' page with the following data table:

Event Type	SEVIS Event Tag	Allow Manual Addition	Form Request Available	Alerts Form Request Default	Send to SEVIS	*Default SEVIS Status	Compare Detail	Addl Data
FC	CreateStudent	<input type="checkbox"/>	<input checked="" type="checkbox"/>	<input checked="" type="checkbox"/>	<input checked="" type="checkbox"/>		<input type="checkbox"/>	Addl Data
FUATD	Program - DeferAttendance	<input type="checkbox"/>	<input checked="" type="checkbox"/>	<input checked="" type="checkbox"/>	<input checked="" type="checkbox"/>		<input checked="" type="checkbox"/>	Addl Data
FUGGE	Request CapGapExtension	<input type="checkbox"/>	<input checked="" type="checkbox"/>	<input checked="" type="checkbox"/>	<input checked="" type="checkbox"/>		<input checked="" type="checkbox"/>	No Addl
FUDAC	DisciplinaryAction	<input checked="" type="checkbox"/>	<input type="checkbox"/>				<input type="checkbox"/>	Reqd Data
FUDAD	Dependent - Add	<input type="checkbox"/>	<input checked="" type="checkbox"/>	<input checked="" type="checkbox"/>	<input checked="" type="checkbox"/>	Active	<input type="checkbox"/>	No Addl
FUDCD	Dependent - Cancel	<input type="checkbox"/>	<input type="checkbox"/>		<input checked="" type="checkbox"/>		<input type="checkbox"/>	No Addl
FUDPE	Dependent - Edit	<input type="checkbox"/>	<input checked="" type="checkbox"/>	<input checked="" type="checkbox"/>	<input checked="" type="checkbox"/>	Active	<input checked="" type="checkbox"/>	No Addl
FUDRD	Dependent - Reactivate	<input type="checkbox"/>	<input checked="" type="checkbox"/>	<input checked="" type="checkbox"/>	<input checked="" type="checkbox"/>		<input type="checkbox"/>	No Addl
FUDRP	Dependent - Reprint	<input checked="" type="checkbox"/>	<input checked="" type="checkbox"/>	<input checked="" type="checkbox"/>	<input checked="" type="checkbox"/>	Active	<input type="checkbox"/>	Reqd Data
FUDTD	Dependent - Terminate	<input type="checkbox"/>	<input type="checkbox"/>		<input checked="" type="checkbox"/>	Active	<input type="checkbox"/>	No Addl

Note: The DHS defines the SEVIS events in *Application Program Interface Document (API)*.

Field or Control	Description
Event Type	Displays the PeopleSoft event type codes for the visa category entered (either F/M visas or J visas). The SEVIS Alerts process and pages use these codes. <hr/> Warning! Do <i>not</i> change or delete event types. Doing so affects the alerts processing. <hr/>
SEVIS Event Tag	Enter the DHS description of the event. You can modify event tags.

Field or Control	Description
Allow Manual Addition	<p>Select to enable manual addition of this event type on the SEVIS Alerts Header page.</p> <p>DSOs can make manual additions on the Alerts Header page to submit certain data to SEVIS for when student updates are not detected as data changes in the PeopleSoft Campus Solutions system.</p> <p>The delivered F/M visa event types that allow manual addition are:</p> <p><i>Dependent – Reprint</i></p> <p><i>AuthDropBelowFC – Add</i></p> <p><i>AuthDropBelowFC – Cancel</i></p> <p><i>AuthDropBelowFC – Edit</i></p> <p><i>Status – Complete</i></p> <p><i>Reprint</i></p> <p><i>Disciplinary Action</i></p> <p><i>Status – Terminate</i></p> <p>ROs can make manual additions on the Alerts Header page to submit certain data to SEVIS for when exchange visitor updates are not detected as data changes in the PeopleSoft Campus Solutions system.</p> <p>The delivered J visa event types that allow manual addition are:</p> <p><i>Dependent – Reprint</i></p> <p><i>Reprint</i></p> <p><i>Status – Invalid</i></p> <p><i>Status – NoShow</i></p> <p><i>Status – End</i></p> <p><i>Status – Correct Infraction</i></p> <p><i>Status – Terminate</i></p> <p><i>Status – Validate</i></p> <hr/> <p>Note: Status – End events are no longer included in the 6.23 batch schema. It is recommended that you do not select the Allow Manual Addition check box.</p> <hr/>

Field or Control	Description
Form Request Available	<p>Do not modify this.</p> <p>This check box is pre-selected or not based on the information in the <i>Application Program Interface (API)</i> document.</p> <p>When this check box is selected, it indicates that a new PDF form file (I-20 for F/M visas or DS-2019 for J visas) can be requested for this event. Also, the New Form check box becomes available on the Alerts Header page.</p>
Alerts Form Request Default	<p>Select to automatically select the New Form check box on the SEVIS Alerts Header page when this event type is detected.</p> <p>This check box is pre-selected or not based on the information in the <i>Application Program Interface (API)</i> document.</p> <p>You can modify it based on your institution's preferences.</p>
Send to SEVIS	<p>Select to automatically set the Send To field on the Alerts Header page to <i>SEVIS</i> when this event type is detected.</p> <p>The Send to SEVIS check box is available when additional data is not required for the event type. (See the Addl Data column description for a list of event types and their additional data status.)</p> <hr/> <p>Note: Following the 6.23 batch release, it is recommended to deselect the Send to SEVIS check box for FUEOD OPT Employment – Add events. These events are currently not supported.</p> <hr/>
Default SEVIS Status	<p><i>Applies to F/M visas only. Does not apply to J visas.</i></p> <p>This field appears only for events that can be triggered for a SEVIS status of <i>Active</i> or <i>Initial</i>.</p> <p>Select the status to use as the default when sending an update event if an Education Level – Change event has been previously sent to SEVIS.</p> <p>SEVIS uses this value to determine which record to update when an Education Level – Change event creates a second record with a SEVIS status of <i>Initial</i>.</p> <p>You can override the default status value on the Select Alerts to Report – F/M component.</p>
Compare Detail	<p>When selected, causes a detail subpage to be available from the Select Alerts to Report component showing the changed data that caused the event to trigger.</p> <p>This value is preset in the system based on events where data differences can trigger the event.</p>

Field or Control	Description
Addl Data additional data)	<p>Displays the value based on the event type.</p> <p><i>No Addl</i> = Additional data is neither required nor permitted.</p> <p><i>Reqd Data</i> = Additional data is required and must be entered on the Addl Data page of the Select Alerts to Report component to send the event to SEVIS.</p> <p>The F/M event types for which additional data is required are:</p> <p><i>Disciplinary Action</i></p> <p><i>Status - Terminate</i></p> <p><i>AuthDropBelowFC - Add</i></p> <p><i>AuthDropBelowFC - Edit</i></p> <p><i>Dependent - Reprint</i></p> <p><i>Reprint</i></p> <p><i>Program - Extension</i></p> <p>The J event types for which additional data is required are:</p> <p><i>Dependent - Add</i></p> <p><i>Dependent - Reprint</i></p> <p><i>Program - Shorten</i></p> <p><i>Program - EditSubject</i></p> <p><i>Reprint</i></p> <p><i>Status - Invalid</i></p> <p><i>Status - Terminate</i></p> <p><i>Status - Correct Infraction</i></p> <p><i>Status - End</i></p> <p><i>Addl Data</i> = Additional data optional on the Addl Data page of the Select Alerts to Report component.</p> <p>The F/M event types for which additional data is optional are:</p> <p><i>Program - Edit</i></p> <p><i>Program - Cancel Extension</i></p> <p><i>Education Level - Change</i></p> <p><i>Education Level - Cancel</i></p> <p><i>Personal Info</i></p> <p><i>Status - Complete</i></p>

Field or Control	Description
	<i>Program - Shorten</i> <i>Program - Defer Attendance</i> <i>Registration</i> <i>Status - Cancel</i> The J event types for which additional data is optional are: <i>Biographical</i> <i>Program - Amend</i> <i>Program - Extension</i> <i>Dependent - Edit</i> <i>Site of Activity - Edit</i>

Defining SEVIS File Error Messages

Access the SEVIS File Errors page (**Set Up SACR > Product Related > Campus Community > SEVIS > Common Definitions > SEVIS Setup > SEVIS File Errors**).

Note: The DHS defines the SEVIS file errors in the Appendix B: SEVIS Batch Process Error Codes section in *Application Program Interface (API)*. The DHS may update the error messages from time to time. You must update or delete codes and descriptions to keep your system current with SEVIS.

Field or Control	Description
File Error	Enter the DHS error code. Enter the error codes and their descriptions that are used on the PeopleSoft SEVIS Import Results pages. If there are errors, SEVIS includes the file upload error code in the transaction log result files that it returns to you.
Description	Enter the DHS description of the error code.

Setting Up F and M Visas Processing

To set up F and M visas processing, use the following components: SEVIS School Code Table (SEV_SCHL_CD_TBL), Dept of State Post Code Table (SEV_DOS_TBL), Port of Entry Table (SEV_POE_TBL), Fee Code Table (SEV_FEE_TBL), I-20 Template (SEV_I20_TMPLT), and Visa/Level of Education Map (SEV_LVL_VSA_TBL).

This section discusses how to do the following for student F and M visas:

- Set up SEVIS school codes.
- Define the institution for a school code.
- Set up SEVIS school code security.
- Set up U.S. Department of State postal codes.
- Set up port of entry data.
- Map SEVIS visa types to levels of education.
- Set up SEVIS fee codes.
- Create an I-20 form template.

Pages Used to Set Up F and M Visas Processing

<i>Page Name</i>	<i>Definition Name</i>	<i>Navigation</i>	<i>Usage</i>
School Code Table	SEV_SCHL_CD_TBL	Set Up SACR > Product Related > Campus Community > SEVIS > F/M Visa > School Code Table	Set up school and designated school officials information for F and M student visas.
School Code Institution Table	SEV_SCHL_CD2_TBL	Set Up SACR > Product Related > Campus Community > SEVIS > F/M Visa > School Code Table > School Code Institution Table	Set up academic institution and academic career information for F and M student visas.
SEVIS School Code Security	SEV_SCHLCD_SCTY	Set Up SACR > Security > Secure Student Administration > User ID > SEVIS > School Code Security	Set F and M visas school code security access for a user.
Dept of State Post Code Table	SEV_DOS_TBL	Set Up SACR > Product Related > Campus Community > SEVIS > F/M Visa > Dept of State Post Code Table	Reference the Department of State post code information for F and M student visas.
Port of Entry Table	SEV_POE_TBL	Set Up SACR > Product Related > Campus Community > SEVIS > F/M Visa > Port of Entry Table	Reference the DHS port of entry information for F and M student visas.

Page Name	Definition Name	Navigation	Usage
Visa/Level of Education Map	SEV_LVL_VISA_TBL	Set Up SACR > Product Related > Campus Community > SEVIS > F/M Visa > Visa/Level of Education Map	Determine the levels of education that are available for F and M classification students on the I-20 form. For example, the Flight Training level is only valid for M-1 students.
Fee Code Table	SEV_FEE_TBL	Set Up SACR > Product Related > Campus Community > SEVIS > F/M Visa > Fee Code Table	Set up the fee code information to use with the I-20 template for student F and M visas.
I-20 Template	SEV_I20_TEMPLATE	Set Up SACR > Product Related > Campus Community > SEVIS > F/M Visa > I-20 Template	Set up default information to include in I-20 forms for student F and M visas.

Setting Up SEVIS School Codes

Access the School Code Table page (**Set Up SACR > Product Related > Campus Community > SEVIS > F/M Visa > School Code Table**).

School Information

Enter information here to match the information that you record in the DHS SEVIS RTI for your school certification. The data that you enter is for internal purposes and appears in display-only mode on the I-20 form pages.

Field or Control	Description
School Code Description	Enter the description for the school code entered.
Address 1, City, State	Enter the address for the school code entered.
School Official (name)	Enter the contact school official.
Title	Enter the title of the person named as school official.
Approval Date	Enter the date on which the institution's certification was granted.

PDSO/DSO

Field or Control	Description
ID	<p>Enter the ID number of the primary designated school official (PDSO) or the DSO named.</p> <p>The available values include only IDs for the DSO or PDSO SEVIS user IDs that exist in the External System ID table.</p>

Note: Each designated school official's SEVIS user ID information must be set up in the External System ID table to populate the ID fields here. When setting up the SEVIS user ID information in the External System ID table, use *DSO/PDSO SEVIS User ID* as the external system type. You typically identify the primary and other DSOs when completing the I-17 certification process. Obtain the primary DSO and other DSO SEVIS user ID information from the DHS.

See [Entering External System IDs](#).

Field or Control	Description
Title	Enter the title of the primary designated school official or the designated officer named.
Primary DSO (primary designated school official)	<p>Select to indicate that this is the primary designated school official.</p> <p>You must select one person as the primary DSO or you cannot save the information on this page.</p>

Defining the Institution for a School Code

Access the School Code Institution Table page ([Set Up SACR](#) > [Product Related](#) > [Campus Community](#) > [SEVIS](#) > [F/M Visa](#) > [School Code Table](#) > [School Code Institution Table](#)).

Warning! You must enter all institutions and careers affiliated with each school code. If you do not enter all of the institutions and careers affiliated with each school code, academic information is not reported to SEVIS.

Academic Institution

Field or Control	Description
Academic Institution	Select each institution that is affiliated with the school code.

Academic Career

<i>Field or Control</i>	<i>Description</i>
Career	Select each career that is affiliated with the institution and school code.

Setting Up SEVIS School Code Security

Access the School Code Security page (**Set Up SACR > Security > Secure Student Administration > User ID > SEVIS > School Code Security**).

The SEVIS school code secures many of the F and M visa pages in PeopleSoft's SEVIS component.

<i>Field or Control</i>	<i>Description</i>
SEVIS School Code	Select the SEVIS school codes to which this user should have access.
Access Code	The access code is set to <i>Read/Write</i> . You cannot change this.
All Access	Click to assign this ID access to all SEVIS school codes.

Setting Up U.S. Department of State Postal Codes

Access the Dept of State Post Code Table page (**Set Up SACR > Product Related > Campus Community > SEVIS > F/M Visa > Dept of State Post Code Table**).

Note: The DHS defines the Dept of State (DoS) postal code values in the lookup tables section of *Application Program Interface (API)*. The DHS may update the DoS post codes from time to time. You must update or delete codes and descriptions to keep your system current with SEVIS.

See [Reference Manual for the Student and Exchange Visitor Information System Batch Interface, Application Program Interface \(API\)](#).

<i>Field or Control</i>	<i>Description</i>
DoS Post Code (Department of State postal code)	Enter the country code established by the U.S. Department of State for a particular country.
Description	Enter the full name of the country.

Setting Up Port of Entry Data

Access the Port of Entry Table page (**Set Up SACR > Product Related > Campus Community > SEVIS > F/M Visa > Port of Entry Table**).

Note: The DHS defines the port of entry values in the lookup tables section of *Application Program Interface (API)*. The DHS may update the port of entry codes from time to time. You must update or delete codes and descriptions to keep your system current with SEVIS.

See [Reference Manual for the Student and Exchange Visitor Information System Batch Interface, Application Program Interface \(API\)](#).

<i>Field or Control</i>	<i>Description</i>
Port of Entry	Enter the port of entry code for a particular port of entry into the United States.
Description	Enter the full name of the U.S. port of entry.

Mapping SEVIS Visa Types to Levels of Education

Access the Visa/Level of Education Map page (**Set Up SACR > Product Related > Campus Community > SEVIS > F/M Visa > Visa/Level of Education Map**).

This example illustrates the fields and controls on the Visa/Level of Education Map page. You can find definitions for the fields and controls later on this page.

The mapping that you set up on this page affects the values available in the **Level of Education** field on the I-20 form.

Warning! Do not change or delete the level of education mapping. Doing so affects the I-20 processing.

Field or Control	Description
SEVIS Visa Type	Select the appropriate SEVIS visa type based on the DHS lookup tables.
Level of Education	Select the values that are allowed for the indicated classification.

Setting Up SEVIS Fee Codes

Access the Fee Code Table page (**Set Up SACR > Product Related > Campus Community > SEVIS > F/M Visa > Fee Code Table**).

This example illustrates the fields and controls on the Fee Code Table page. You can find definitions for the fields and controls later on this page.

Fee Code Table

Find | View All First ◀ 1 of 12 ▶ Last

*SEVIS Fee Code:	<input type="text" value="BBS"/>	+	-	
*Description:	<input type="text" value="Biology - BS Expenses"/>			
Tuition and fees:	<input type="text" value="\$13250"/>			
Living expenses:	<input type="text" value="\$10755"/>			
Dependent Expenses:	<input type="text" value="\$5555"/>			
Other expenses:	<input type="text" value="\$1555"/>	Comments:	<input type="text" value="Bachelor of Science Biology"/> <input type="text" value="Lab Fees and Mandatory Health"/> <input type="text" value="Insurance"/>	
Months in an academic term:	<input type="text" value="5"/>			
Length of study:	<input type="text" value="48"/> Months			

Data on this page is used on the F and M visas I-20 Template page and serves as default values for populating the I-20 Form page.

Note: To take full advantage of I-20 default value functionality, you might consider how fees and length of study vary by program and set different defaults for different programs.

Field or Control	Description
SEVIS Fee Code	Enter the fee code for the program.
Description	Enter the full name of the fee code.
Tuition and fees, Living expenses, Expenses of dependents, and Other expenses	Enter amounts for each of these expenses.

Field or Control	Description
Comments	Add comments to describe the other expenses, if any.
Months in an academic term	Enter the number of months in an academic term associated with these expenses.
Length of study	Enter the number of months for the program associated with these expenses.

Creating an I-20 Form Template

Access the I-20 Template page (**Set Up SACR > Product Related > Campus Community > SEVIS > F/M Visa > I-20 Template**).

This example illustrates the fields and controls on the I-20 Template page (1 of 2). You can find definitions for the fields and controls later on this page.

The screenshot displays the 'I-20 Template' page with the following sections and fields:

- Academic Institution:** *Academic Institution: PSCCS (PS Community College System), Fee Code: PSCCS Expenses, Level of Education: Bachelors, School Official: SEVDR07 (Girard, Sharon).
- Exceptions:** Academic Career, Fee Code, Level of Education, School Official.
- Academic Program:** Academic Program, Academic Plan, Fee Code, Level of Education, School Official.

Navigation and search controls are visible at the top of each section, including 'Find', 'View All', 'First', 'Last', and '1 of 1' or '1-2 of 2'.

This example illustrates the fields and controls on the I-20 Template page (2 of 2). You can find definitions for the fields and controls later on this page.

The screenshot displays the I-20 Template page with three main sections:

- *Academic Institution:**
 - Academic Institution: PSUNV PeopleSoft University
 - Fee Code: PSUNV Expenses
 - Level of Education: Bachelors
 - School Official: SEVDR10 Adamson, Sonja
- Exceptions:**
 - Academic Career: GRAD Graduate
 - Fee Code: Graduate Expenses
 - Level of Education: Masters
 - School Official: SEVDR02 Frumman, Wolfgang
- Academic Program:**
 - Academic Program: GLAU Graduate Liberal Arts Programs
 - Academic Plan: (empty)
 - Fee Code: Liberal Arts GRAD
 - Level of Education: Masters
 - School Official: SEVDR11 Bacon, Roberta

The I-20 template enables you to define general defaults and to specify exceptions for career and academic programs and plan levels. Values on the template serve as defaults for the School Estimates and the Designated School Official sections of the I-20 form.

The fee code values come from the Fee Code Table page. You must enter the appropriate values for the **Level of Education** and **School Official** fields.

Setting Up J Visas Processing

To set up J visas processing, use the following components: SEVIS Program Sponsor Table (SEV_PRG_SP_TBL), International Organizational Table (SEV_INT_ORG_TBL), Position Code Table (SEV_POS_CD_TBL), Site of Activity Table (SEV_SITE_ACT_TBL), US Government Agency Code (SEV_AGEN_CD_TBL), and J Visa Termination Reasons (SEV_EV_TERM_RSN).

For exchange visitor J visas, this section discusses how to:

- Set up program sponsors.
- Set up site of activity codes.
- Define the default site of activity.
- Set up program sponsor security.
- Set up international organization codes.
- Set up U.S. government agency codes.
- Set up position codes.
- Set up J visa termination reasons.

See [Reference Manual for the Student and Exchange Visitor Information System Batch Interface, Application Program Interface \(API\)](#).

Pages Used to Set Up J Visas Processing

<i>Page Name</i>	<i>Definition Name</i>	<i>Navigation</i>	<i>Usage</i>
Program Sponsor Table	SEV_PRG_SP_TBL	Set Up SACR > Product Related > Campus Community > SEVIS > J Visa > SEVIS Program Sponsor Table	Set up program sponsor and responsible officer information for exchange visitor J visas.
Site of Activity Table	SEV_SITE_ACT_TBL	Set Up SACR > Product Related > Campus Community > SEVIS > J Visa > Site of Activity Table	Set up site of activity codes to use on the J visas DS-2019 form.
Program Sponsor Table 2	SEV_PRG_SP2_TBL	Set Up SACR > Product Related > Campus Community > SEVIS > J Visa > SEVIS Program Sponsor Table > Program Sponsor Table 2	Set up academic institution and academic career information for exchange visitor J visas. Specify the default site of activity.
SEVIS Program Sponsor Security	SEV_PRG_SP_SCTY	Set Up SACR > Security > Secure Student Administration > User ID > SEVIS Pgm Sponsor Security	Set J visa program sponsor security access for an individual.
International Organizations	SEV_INT_ORG_TBL	Set Up SACR > Product Related > Campus Community > SEVIS > J Visa > International Orgs Table	Reference the international organization information to use on the J visas DS-2019 form.
US Government Agency Codes	SEV_AGEN_CD_TBL	Set Up SACR > Product Related > Campus Community > SEVIS > J Visa > US Government Agency Code Tbl	Reference the U.S. government agency information to use on the J visas DS-2019 form.
Position Code Table	SEV_POS_CD_TBL	Set Up SACR > Product Related > Campus Community > SEVIS > J Visa > Position Code Table	Reference the position codes to use on the J visas DS-2019 form.

Page Name	Definition Name	Navigation	Usage
J Visa Termination Reasons	SEV_EV_TERM_RSN	Set Up SACR > Product Related > Campus Community > SEVIS > J Visa > J Visa Termination Reasons	Set termination reasons to use for J visas termination exchange visitor events.

Setting Up Program Sponsors

Access the Program Sponsor Table page ((**Set Up SACR > Product Related > Campus Community > SEVIS > J Visa > SEVIS Program Sponsor Table**)).

Program Sponsor Information

Enter information here to match the information that you record in the DHS SEVIS RTI for your program sponsor certification. The data that you enter is for internal purposes and appears in display-only mode on the DS-2019 form pages.

Field or Control	Description
Sponsored by	Enter the name of the program sponsor.
Described as	Enter the description for the program sponsor.
Address Line 1, Address Line 2, City, State, and Postal Code	Enter the address for the program sponsor. The system uses this address as the U.S. address of the exchange visitor for the Create EV event if the exchange visitor does not provide a U.S. address.

ARO/RO

Field or Control	Description
ID	Enter the ID number of the responsible officer (RO) or the alternate responsible officer (ARO) named. The available values include only IDs for the RO or ARO SEVIS user IDs that exist in the External System ID table.

Note: Each responsible officer's SEVIS user ID information must be set up on the External System ID table to populate the ID fields here. When setting up the SEVIS user ID information on the External System ID table, use *RO/ARO SEVIS User ID* as the external system type. You typically identify your RO and AROs when completing the DS-3036 certification process. Obtain your RO and ARO SEVIS user ID information from DHS.

See [Entering External System IDs](#).

Field or Control	Description
RO (responsible officer)	Select to indicate that this person is the responsible officer. You must select one person as the RO or you cannot save the information on this page.

Setting Up Site of Activity Codes

Access the Site of Activity Table page (**Set Up SACR > Product Related > Campus Community > SEVIS > J Visa > Site of Activity Table**).

This example illustrates the fields and controls on the Site of Activity Table page. You can find definitions for the fields and controls later on this page.

Site of Activity Table

Site of Activity: ENC

Find | View All
First 1 of 1 Last

*Effective Date:	<input type="text" value="01/01/1900"/>	*Status:	<input type="text" value="Active"/>
*Description:	<input type="text" value="PeopleSoft University"/>		
*Address 1:	<input type="text" value="15821 N VENTURA BLVD"/>		
Address 2:	<input type="text" value="SUITE 200"/>		
*City:	<input type="text" value="ENCINO"/>		
*State:	<input type="text" value="CA"/> California		
*Postal Code:	<input type="text" value="91436-4444"/>		
Explanation Code:	<input type="text" value="Other override"/>		
Explanation Text:	<input type="text" value="12345676"/>		

Field or Control	Description
Status	Select <i>Active</i> or <i>Inactive</i> . The system displays only active site of activity rows in the prompt on the DS-2019 Form and SEVIS Program Sponsor pages.
Description	Enter the site of activity name. Warning! This description is submitted to SEVIS as the SiteName. Changing this field will trigger a Site of Activity – Edit event for all exchange visitors with this site of activity assigned.

<i>Field or Control</i>	<i>Description</i>
Explanation Code	Select the override reason for an address that does not pass SEVIS validation. This reason is included in the alert.
Explanation Text	Enter the reason for the override. This field is enabled only when you select Other override in the Explanation Code field.

Defining the Default Site of Activity

Access the Program Sponsor Table 2 page (**Set Up SACR > Product Related > Campus Community > SEVIS > J Visa > SEVIS Program Sponsor Table > Program Sponsor Table 2**).

Warning! You must enter all institutions and careers affiliated with each program sponsor that accepts student category exchange visitors. If you do not enter all of the institutions and careers affiliated with each program sponsor, academic information is not reported to SEVIS for student category exchange visitors.

Default Site of Activity

<i>Field or Control</i>	<i>Description</i>
Site of Activity	Select the site of activity to use as the default value when adding a new DS-2019 form.

Academic Institution

<i>Field or Control</i>	<i>Description</i>
Academic Institution	Select each institution that is affiliated with the program sponsor.

Academic Career

<i>Field or Control</i>	<i>Description</i>
Academic Career	Select each career that is affiliated with the institution and program sponsor.

Setting Up Program Sponsor Security

Access the SEVIS Program Sponsor Security page (**Set Up SACR > Security > Secure Student Administration > User ID > SEVIS Pgm Sponsor Security**).

The SEVIS program sponsor code secures many of the J visa pages in the SEVIS component.

<i>Field or Control</i>	<i>Description</i>
SEVIS Program Sponsor	Select each SEVIS program sponsor to which this user should have access.
Access Code	The access code is set to <i>Read/Write</i> . You cannot change this.
All Access	Click to assign this ID access to all SEVIS program sponsors.

Setting Up International Organization Codes

Access the International Organizations page (**Set Up SACR > Product Related > Campus Community > SEVIS > J Visa > International Orgs Table**).

Note: The DHS defines the U.S. Government agency codes that are delivered in the Lookup Tables section of *Application Program Interface (API)*. The DHS may update the international organization codes from time to time. You must update or delete codes and descriptions to keep your system current with SEVIS.

<i>Field or Control</i>	<i>Description</i>
Intl Organization Code (international organization code)	Enter the DHS code for the international organization that provides funding for exchange visitors.
Description	Enter the full name of the DHS international organization.

Setting Up U.S. Government Agency Codes

Access the US Government Agency Codes page (**Set Up SACR > Product Related > Campus Community > SEVIS > J Visa > US Government Agency Code Tbl**).

Note: The DHS defines the Position Codes that are delivered in the Lookup Tables section of *Application Program Interface (API)*. The DHS may update the agency codes from time to time. You must update or delete codes and descriptions to keep your system current with SEVIS.

Field or Control	Description
US Government Agency Code	Enter the DHS code for the U.S. government agency that provides funding for exchange visitors.
Description	Enter the full name of the DHS U.S. government agency.

Setting Up Position Codes

Access the Position Code Table page (**Set Up SACR > Product Related > Campus Community > SEVIS > J Visa > Position Code Table**).

Note: The DHS defines the position codes that are delivered in the Lookup Tables section of *Application Program Interface (API)*. The DHS may update the position codes from time to time. You must update or delete codes and descriptions to keep your system current with SEVIS.

Field or Control	Description
Position Code	Enter the DHS code for a position that exchange visitors may hold in their home country. This is reported on the DS-2019 form.
Description	Enter the full name of the DHS position.

Setting Up J Visa Termination Reasons

Access the J Visa Termination Reasons page (**Set Up SACR > Product Related > Campus Community > SEVIS > J Visa > J Visa Termination Reasons**).

Note: The DHS defines the termination reason codes that are delivered in the Lookup Tables section of *Application Program Interface (API)*. The DHS may update these codes from time to time. You must update or delete codes and descriptions to keep your system current with SEVIS.

Field or Control	Description
Termination Reason	Enter the DHS code for the exchange visitor termination reason. The SEVIS Alerts process for J visas uses the termination reasons when populating a Terminate EV event.
Description	Enter the full name of the DHS exchange visitor termination reason.

Setting User Defaults for Visa Processing

To set user defaults for visa processing, use the User Defaults component (OPR_DEFAULT_CS).

This section discusses how to set up school code or program sponsor user defaults for an individual.

Page Used for Setting User Defaults Visa Processing

Page Name	Definition Name	Navigation	Usage
User Defaults 4	OPR_DEF_TABLE_CS4	Set Up SACR > User Defaults > User Defaults 4	Set up user defaults for visa processing, set up default school codes for F and M visa processing, and set up a default program sponsor for J visa processing.

Setting School Code or Program Sponsor User Defaults

Access the User Defaults 4 page (**Set Up SACR > User Defaults > User Defaults 4**).

Note: The *Carry ID*, *Output Destination*, *Transcript Type*, and *Advisement Report Type* fields are not used for SEVIS.

SEVIS Default

The system uses the defaults that you set here to populate data in the SEVIS component. The default values that you set here can be overridden on any page in the system.

Although setting user defaults can save time, doing so is optional.

Field or Control	Description
School Code	<i>(For F/M visas)</i> Enter the default DHS SEVIS school code that you want the system to use for this ID. Default school codes are used to populate data in the SEVIS components for F/M visa processing.
Program Number	<i>(For J visas)</i> Enter the default DHS SEVIS exchange visitor program sponsor number that you want the system to use for this ID. Default program numbers are used to populate data in the SEVIS components for J visa processing.

Related Links

[Reviewing or Defining Campus Community Installation Settings](#)

Chapter 11

Setting Up Service Indicators

Understanding Service Indicator Setup

Service indicators consist of service impacts and service indicator reasons that make each service indicator unique.

You complete these steps to set up service indicators:

1. Define service impact values on the Service Impact Table page.
2. Define service indicator codes (including attaching service impact values to each service indicator) on the Service Indicator Codes page.
3. Define service indicator reason codes for each service indicator on the Service Indicator Reasons page.

Related Links

“Using Student Records Service Impacts” (Student Records)
[Viewing, Assigning, or Removing Service Indicators](#)

Setting Up Service Impacts

To set up service impacts, use the Service Impact Table component (SERVICE_TABLE).

This section discusses how to define service impact codes.

Page Used to Set Up Service Impacts

<i>Page Name</i>	<i>Definition Name</i>	<i>Navigation</i>	<i>Usage</i>
Service Impact Table	SRVC_IMPACT_TABLE	Set Up SACR > Common Definitions > Service Indicators > Service Impact Table	Define service impact codes to attach to service indicators.

Defining Service Impact Codes

Access the Service Impact Table page (**Set Up SACR > Common Definitions > Service Indicators > Service Impact Table**).

This example illustrates the fields and controls on the Service Impact Table page. You can find definitions for the fields and controls later on this page.

Service Impact Table

Institution: PSUNV PeopleSoft University

Service Impact: CENR

Service Impact Details Find | View All First 1 of 1 Last

*Effective Date: 01/01/1900 31 *Status: Active + -

*Description: Block All Enrollment Actvty

Short Description: Enrl Block

Basis of Impact: Term Date

Positive Service Impact System Function

To use the PeopleSoft-delivered services that are related to service impacts (such as blocking enrollment), you must set up but never modify the following service impact codes for every institution in your system:

- AENR
- CENR
- ENVER
- IENR

Each of these service impacts is used in a unique way within the system.

See “Using Student Records Service Impacts” (Student Records).

Service Impact Details

A service indicator is in effect for as long as its longest service impact. A service impact is in effect from the start date (for date-based business processes, such as requesting a transcript) or start term (for term-based business processes, such as financial aid disbursement). It remains in effect up to and including the end date or through the end term. If no end point is defined, the service indicator with that impact remains in effect until it is released manually.

Field or Control	Description
Basis of Impact	<p>Select the basis by which the system is to disregard this service impact.</p> <p>The Service Indicator remains on the record until you remove it; however, the system will disregard the impact as of the end of the basis of impact that is selected. Each impact must have a basis of impact.</p> <p>If the business process is term-based, select the <i>Term</i> check box for the system to disregard the impact automatically upon completion of the End Term. The end term is defined on the Add Service Indicator page, which is where you assign the service indicator to an ID.</p> <p>If the business process is date-based, select the <i>Date</i> check box for the system to disregard the impact automatically upon completion of the End Date. The end date is defined on the Add Service Indicator page, which is where you assign the service indicator to an ID.</p> <p>If the business process is both term-based and date-based, you can select both check boxes. For example, you might need to restrict enrollment activities for an individual for Fall Term 006 but only once the Drops period has begun, which is two weeks into the term. The Service Indicator code with the appropriate impact is assigned with a Start Term value of <i>Fall Term 006</i>, an End Term value of <i>Fall Term 006</i>, and a Start Date of <i>October 6</i>. Selecting both check boxes would allow this impact to restrict enrollment activities only on or after October 6 and only for Fall Term 006.</p> <p>See Assigning a Service Indicator to an ID.</p>
Positive Service Impact	<p>Select this check box to indicate that the impact provides a service, as opposed to denying or restricting one.</p>
System Function	<p>Select this check box to identify the service impact as one called by PeopleSoft program logic. For example, you must define the <i>CENR</i> service impact and select this check box for it, for each institution in your system, because it is used by enrollment process logic.</p> <p>See “Using Student Records Service Impacts” (Student Records).</p>

Setting Up Service Indicator Codes and Reasons

To set up service indicator codes and reasons, use the Service Indicator Table component (SERVICE_IND_CD_TBL).

This section discusses how to:

- Create service indicator codes.
- Define and associate service indicator reasons.

Department security is required for Service Indicator setup and functionality.

- Complete the required setup in the Security by Dept Tree.
- When changes occur in the Dept Tree, run SJT_CLASS_ALL and then run SJT_OPR_CLS.

“Managing Department Security” (Campus Solutions Application Fundamentals)

Pages Used to Set Up Service Indicator Codes and Reasons

<i>Page Name</i>	<i>Definition Name</i>	<i>Navigation</i>	<i>Usage</i>
Service Indicator Codes	SRVC_IND_CD_TABLE	Set Up SACR > Common Definitions > Service Indicators > Service Indicator Codes	Create service indicator codes for positive and negative service indicators.
Service Indicator Reasons	SRVC_IND_RSN_TABLE	Set Up SACR > Common Definitions > Service Indicators > Service Indicator Codes > Service Indicator Reasons	Define and associate reasons for a service indicator.
Service Indicator Display	SCC_SI_DISP_ROLE	Click the Secure Display by Role link on the Service Indicator Reasons page.	Select roles permitting users with those roles to view the assigned service indicator.

Creating Service Indicator Codes

Access the Service Indicator Codes page (**Set Up SACR > Common Definitions > Service Indicators > Service Indicator Codes**).

This example illustrates the fields and controls on the Service Indicator Codes page. You can find definitions for the fields and controls later on this page.

The screenshot shows the 'Service Indicator Codes' page for 'Academic Institution PSUNV' and 'PeopleSoft University'. The 'Service Indicator Code' is 'SF1'. The 'Service Indicator Details' section includes:

- *Effective Date: 01/01/1997
- *Status: Active
- *Description: Student Financial 1
- Short Description: SF 1
- Default Reason: NOPAY Tuition Not Paid
- Set No Default checkbox (unchecked)

 The 'Attributes' section includes:

- Use with: Person, Organization, Positive Service Indicator, Default Start Term (0000)
- Display Deceased Label, Display in Self-Service, Default Start Date

 The 'Service Indicator Impact' section includes:

- *Service Impact: CENR (Block All Enrollment Actv)
- Term Category: (dropdown)
- Description: (text area)

Note: Assigned serviced indicators draw on the current effective-dated service indicator definition. If a new effective-dated row is added to the service indicator definition, the changes in that row will affect existing as well as new assignments to IDs.

<i>Field or Control</i>	<i>Description</i>
Copy	Click to copy this service indicator definition, including associated service indicator impacts and service indicator reasons, to a new institution, a new service indicator code within the currently defined institution, or a new institution and code combination.

Service Indicator Details

<i>Field or Control</i>	<i>Description</i>
Default Reason	Displays the default reason associated with the service indicator. Note: The system cannot display the default reason until the reason is defined and associated with the service indicator on the Service Indicator Reasons page.

Field or Control	Description
Set No Default	Select this check box to prevent the system from displaying default values in the Service Indicator Reason Code and Department fields on the Service Indicators page.

Attributes

Field or Control	Description
Person and Organization	<p>Specify the type of IDs to which this service indicator can be assigned.</p> <p>Select the <i>Person</i> check box to allow assignment to individuals.</p> <p>Select the <i>Organization</i> check box to allow assignment to organizations.</p> <p>Select both check boxes to allow assignment to both individuals and organizations.</p>
Display Deceased Label	<p>Select this check box to display the word <i>DECEASED</i> at the top of pages about individuals to whom the indicator is assigned in the future.</p> <hr/> <p>Warning! Select the Display Deceased Label check box <i>only</i> when creating a death service indicator. Selecting this for any other service indicator could cause the system to apply the deceased label to individuals who are not deceased. If this happens, substantial manual effort might be required to remove the deceased designation from each individual's record.</p> <hr/>
Positive Service Indicator	<p>Select this check box to indicate that the service indicator identifies a privilege or service to be provided.</p> <p>For example, if you define a positive service indicator of <i>Conference Guest</i> and associate the service impact of <i>Front of Line</i>, then any person assigned the Conference Guest service indicator should receive front-of-line service at your institution.</p>
Display in Self-Service	If your institution has licensed PeopleSoft Campus Self Service, you can select this check box to cause the service indicator to appear on self-service pages.

Field or Control	Description
Default Start Term (0000)	Select this check box to set the Start Term to <i>0000</i> (Begin Service Indicator Term) when this service indicator is assigned.
Default Start Date	Select this check box to set the Start Date to <i><today's date></i> (current system date) when this service indicator is assigned.

Service Indicator Impact

Field or Control	Description
Service Impact	Enter the service that is either restricted or provided by this service indicator.
Term Category	<p>Select the single term category for which the service impact is valid.</p> <hr/> <p>Note: This value is provided for informational purposes for consideration by administrative users. Delivered processes do not consider term categories.</p> <hr/> <p>If you do not specify a term category, the service impact should be considered valid for all terms defined for the service indicator with which it is associated.</p> <p>Values for this field are delivered with your system as translate values. You can modify these translate values.</p> <p>See Assigning a Service Indicator to an ID.</p>
Description	Enter comments to further describe or identify the service impact as it relates to this service indicator.

Related Links

[Viewing, Assigning, or Removing Service Indicators](#)

Defining and Associating Service Indicator Reasons

Access the Service Indicator Reasons page (**Set Up SACR > Common Definitions > Service Indicators > Service Indicator Codes > Service Indicator Reasons**).

This example illustrates the fields and controls on the Service Indicator Reasons page. You can find definitions for the fields and controls later on this page.

This example illustrates the fields and controls on the Service Indicator Reasons page. You can find definitions for the fields and controls later on this page.

Service Indicator Reasons

Field or Control	Description
Positive Service Indicator	If the service indicator identifies a privilege or service to be provided (as opposed to denied or restricted), the system displays this check box as selected.

Reason Details

Field or Control	Description
Reason Code	Enter a code for the service indicator reason that you are creating.
Set As Default	<p>Select this check box to associate this reason with the service indicator. You can select only one default reason for each service indicator.</p> <p>When you save the page, the system displays this reason next to the Default Reason field label on the Service Indicators Codes page. When you assign the service indicator on the Service Indicator Data 1 page, the system displays this reason as the default reason unless the Set No Default check box next to the Default Reason field on the Service Indicators Codes page is selected. In this case, no default reason appears.</p>
Secure Display by Role	Click to access the Service Indicator Display page, where you can select roles to permit only users with those roles to view the assigned service indicator. Users without one of the specified roles are not able to view the assigned service indicator whether accessing the page through the icon or through the administrative menus.
Department	Enter the department at your institution that is responsible for this service indicator.
Reference	<p>Select the type of entity that identified the need for this service indicator. Values are <i>Department</i>, <i>Department and Instructor</i>, and <i>Department Bill # and Instructions</i>.</p> <p>Values for this field are delivered with your system as translate values. You can modify these translate values.</p>
Position Number	Enter the ID of the person or office that identified the need for this service impact.

Field or Control	Description
Long Description	<p>Enter comments or instructions to further describe or define this service indicator reason, or to identify what an individual must do to qualify for the removal of a negative service indicator.</p> <p>Updated for the PeopleSoft Fluid User Interface, you can format text and include external URLs or email links in this field. The text that you enter here appears as instructions for this hold on the Hold Details page in PeopleSoft Campus Self Service. The formatting is not applicable to the Classic interface pages.</p>
Fluid Field Display	<p>Used for the PeopleSoft Fluid User Interface only.</p> <p>Use the check boxes to define which optional fields are displayed on the Hold Details modal page from the Add/Edit Service Indicators. By default, the check boxes are not selected for new records.</p> <p>The Service Indicator Description, Reason Description and Reason Long Description are always displayed. If there is more than one active institution, the institution is displayed.</p> <p>Contact Name —if selected, the name of the person defined as the Contact ID in Add/Edit Service Indicator is displayed. If defined, the preferred name is displayed, otherwise the primary name is displayed. If a Contact Person rather than a Contact ID is defined, then that name is displayed. If neither Contact ID nor Contact Person are defined, the field is not displayed.</p> <p>Contact Email —if selected, the preferred email of the person defined as the Contact ID in Add/Edit Service Indicator is displayed. If a Contact ID is not defined or if a preferred email is not defined for the Contact ID, the field is not displayed.</p> <p>If a display check box is selected but a value does not exist for the particular field in the service indicator record, then the field is not displayed on the Hold Details page. If a Start Term value is <i>0000</i>, the field is not displayed.</p>

<i>Field or Control</i>	<i>Description</i>
Action Button Label	<p>Set up an optional button in the Hold Details modal page to navigate to another Fluid self-service page. If configured, also define the target Fluid page in the Menu, Component and Page fields.</p> <p>For the Action Button to be displayed on mobile devices without the need for horizontal scrolling, ensure that the label value has a maximum of 30 characters.</p>

Related Links

“Using Self-Service Service Indicators Data” (Campus Self Service)

Viewing Service Indicators for Third-Party Integration Data

This section discusses how to view service indicator data for a third-party vendor integration.

Page Used to View Service Indicators for Third-Party Integration Data

<i>Page Name</i>	<i>Definition Name</i>	<i>Navigation</i>	<i>Usage</i>
Service Indicator Summary	CC_SRVCIND_ALL	Set Up SACR > Install > CS Integration Points > CC Interface > Service Indicators	Enter or review data communicated by the Service Indicator component interface to an external vendor or other integrating application.

Viewing Service Indicator Data for a Third-Party Integration

Access the Service Indicators Summary page (click the **Secure Display by Role** link on the Service Indicator Reasons page).

This example illustrates the fields and controls on the Service Indicators Summary page. You can find definitions for the fields and controls later on this page.

Service Indicators Summary								
Roberts,John								
Srv Ind Cd	Descr	Positive	Service Indicator Active Date	Amount	Currency Code	Institution	Descr2	Department
L01	Library Fines	<input type="checkbox"/>	08/31/2004		USD	PeopleSoft University	Begin Term - Srvc Indicatr Use	University Advancement

View the service indicator data that is set to communicate to a specific third-party, such as an integration application or IVR (Interactive Voice Response) vendor.

Chapter 12

Setting Up FERPA Privacy Control

Understanding FERPA Privacy Control

The FERPA privacy control functionality is named for the U.S. Family Educational Rights and Privacy Act regulation. However, anyone can use the functionality to set privacy controls in PeopleSoft Campus Solutions.

To comply with FERPA, you must, at minimum, make directory information available for privacy control. You must review the FERPA_VW records in your system and configure them to reflect the type of information that your institution uses as directory information.

The fields shipped on each FERPA_VW record that is delivered with your system, are examples of that type of directory information.

Note: No examples are shipped for the extracurricular activities view record (ACTVTS_FERPA_VW).

If the shipped examples do not reflect your institution's directory information, you should modify the relevant FERPA_VW records and other objects to adjust the data accordingly.

You can specify additional fields on existing FERPA_VW records to include more information within the same FERPA-controlled category (address, names, personal information, and so on).

You can also use PeopleSoft Application Designer (see your PeopleTools documentation) to do the following:

Create and add new FERPA_VW records to add new categories to your system's FERPA control. You must create a FERPA_VW record for each new category and modify the following to accommodate the new record:

- Records whose names start with FERPA.
- Views whose names end with FERPA_VW.
- PeopleCode attached to FERPA pages, including:
 - DERIVED_CS.FERPA_FLAG.FCH
 - DERIVED_CS.FERPA_PB.FCH
 - FUNCLIB_CS.FERPA_FLAG.FFO
 - PERSONAL_DATA.FERPA.RIN

Remove a field from the FERPA pages. You must also modify the view text on the appropriate pages.

- Use a SQL query tool or write an SQR program to remove all occurrences of the value from the field on the FERPA_OVERRIDE data (DELETE FROM PS_FERPA_OVERRIDE WHERE FIELDNAME='SEX').
- Remove the field from all other FERPA-related pages.
- Use Application Designer to remove the value from FERPA control.

Warning! Removing name, address, phone, and email fields from FERPA views will affect the directory listings in PeopleSoft Campus Self Service Community Directory. You might need to modify the directory load process.

Related Links

[Applying FERPA Control](#)

“Searching Community Directories” (Campus Self Service)

Making Data Available for FERPA Privacy Control

To set up FERPA control, use the FERPA Control component (FERPA_CONTROL).

This section discusses how to make data available for FERPA privacy control.

Page Used to Make Data Available for FERPA Privacy Control

<i>Page Name</i>	<i>Definition Name</i>	<i>Navigation</i>	<i>Usage</i>
FERPA Control	FERPA_CONTROL	Set Up SACR > Product Related > Campus Community > Establish People Processing > Setup > FERPA Control	Review or make additional directory data and other information available to FERPA privacy control.

Setting Data for FERPA Privacy Control

Access the FERPA Control page (**Set Up SACR > Product Related > Campus Community > Establish People Processing > Setup > FERPA Control**).

This example illustrates the fields and controls on the FERPA Control page (1 of 4) - Extracurricular Activities and Addresses. You can find definitions for the fields and controls later on this page.

FERPA Control



FERPA Restriction Records

*Record (Table) Name:  + -

*Description: Control All Values

Fluid Sequence: Allow Exceptions

FERPA Restriction Record Fields

*Field Name	*Description		
<input type="text" value="A01"/> 	<input type="text" value="ArcheryXXXXXXXXXXXXXXXXXXXXXXXXXXXX"/>	<input type="button" value="+"/>	<input type="button" value="-"/>
<input type="text" value="A04"/> 	<input type="text" value="Basketball"/>	<input type="button" value="+"/>	<input type="button" value="-"/>
<input type="text" value="A12"/> 	<input type="text" value="Football"/>	<input type="button" value="+"/>	<input type="button" value="-"/>



FERPA Restriction Records

*Record (Table) Name:  + -

*Description: Control All Values

Fluid Sequence: Allow Exceptions

FERPA Restriction Record Fields

*Field Name	*Description		
<input type="text" value="CAMP"/> 	<input type="text" value="Campus"/>	<input type="button" value="+"/>	<input type="button" value="-"/>
<input type="text" value="HOME"/> 	<input type="text" value="Home"/>	<input type="button" value="+"/>	<input type="button" value="-"/>
<input type="text" value="MAIL"/> 	<input type="text" value="Mailing"/>	<input type="button" value="+"/>	<input type="button" value="-"/>

This example illustrates the fields and controls on the FERPA Control page (2 of 4) - Email Addresses and Names. You can find definitions for the fields and controls later on this page.

***Record (Table) Name** + -

***Description** Control All Values

Fluid Sequence Allow Exceptions

FERPA Restriction Record Fields

*Field Name	*Description		
<input type="text" value="CAMP"/> 🔍	<input type="text" value="Campus"/>	+	-
<input type="text" value="HOME"/> 🔍	<input type="text" value="Home"/>	+	-

***Record (Table) Name** + -

***Description** Control All Values

Fluid Sequence Allow Exceptions

FERPA Restriction Record Fields

*Field Name	*Description		
<input type="text" value="PRF"/> 🔍	<input type="text" value="Preferred"/>	+	-
<input type="text" value="PRI"/> 🔍	<input type="text" value="Primary"/>	+	-

This example illustrates the fields and controls on the FERPA Control page (3 of 4) - Personal Data. You can find definitions for the fields and controls later on this page.

***Record (Table) Name** + -

***Description** Control All Values

Fluid Sequence Allow Exceptions

FERPA Restriction Record Fields

*Field Name	*Description		
<input type="text" value="BIRTHDATE"/> 🔍	<input type="text" value="Birth Date"/>	+	-
<input type="text" value="BIRTHPLACE"/> 🔍	<input type="text" value="Birth Place"/>	+	-
<input type="text" value="MAR_STATUS"/> 🔍	<input type="text" value="Marital Status"/>	+	-
<input type="text" value="SEX"/> 🔍	<input type="text" value="Gender"/>	+	-

This example illustrates the fields and controls on the FERPA Control page (4 of 4) - Phones and Photograph. You can find definitions for the fields and controls later on this page.

***Record (Table) Name** PHONES_FERPA_VW + -

***Description** Phones Control All Values

Fluid Sequence 50 **Allow Exceptions**

FERPA Restriction Record Fields

*Field Name	*Description		
CELL 🔍	Cellular	+	-
HOME 🔍	Home	+	-

***Record (Table) Name** PHOTO_FERPA_VW + -

***Description** Photograph Control All Values

Fluid Sequence **Allow Exceptions**

FERPA Restriction Record Fields

*Field Name	*Description		
EMPLID 🔍	Empl ID	+	-
EMPLOYEE_PHOTO 🔍	Employee Photograph	+	-
PSIMAGEVER 🔍	Image Version	+	-

This example illustrates the fields and controls on the FERPA Control page (5 of 5) - Biographic Fields.

***Record (Table) Name** PERSNL_FERPA_VW + -

***Description** Personal Data Control All Values

Fluid Sequence 20 **Allow Exceptions**

FERPA Restriction Record Fields

*Field Name	*Description		
BIRTHDATE 🔍	Date of Birth	+	-
BIRTHPLACE 🔍	Birth Place	+	-
MAR_STATUS 🔍	Marital Status	+	-
SCC_BIRTH_GENDER 🔍	Birth Gender	+	-
SCC_GENDER_ID 🔍	Gender Identity	+	-
SCC_PRONOUNS 🔍	Preferred Pronouns	+	-
SCC_SEXUAL_ORI 🔍	Sexual Orientation	+	-
SEX 🔍	Gender	+	-

FERPA Restriction Records

<i>Field or Control</i>	<i>Description</i>
Record (Table) Name	<p>Enter the FERPA view record that contains the type of information that your institution uses for directories or that contains additional information that your institution wants to make available for privacy control.</p> <p>The FERPA_VW records available are defined on the CC_FERPA_SEL_VW record. You can modify the view records.</p>
Description	The system displays the description of FERPA_VW record that you entered.
Fluid Sequence	Enter a unique two-digit numeric value for records to appear on the Fluid Privacy Restrictions page. The default value is zero, indicating that no records appear on the page. Applicable to the Fluid interface only.
Allow Exceptions	Select the check box for the Exceptions option to appear on the Fluid Privacy Restrictions page. By default, the check box is unselected. Applicable to the Fluid interface only.
Control All Values	Click this button to display all of the type-based controlled fields (address, phone, name, and email) from the selected record and make them available for privacy control.

FERPA Restriction Record Fields

<i>Field or Control</i>	<i>Description</i>
Field Name	<p>Enter the name of the field, from the FERPA_VW record, that contains the information to make available for privacy control.</p> <p>When you select the record (table) name, the fields on that record become available here. If you click the Control All Values button, the system displays all the type-based controlled fields (valid for address, phone, name, and email only). You can delete and add fields to configure them to your institution's needs.</p>

<i>Field or Control</i>	<i>Description</i>
Description	<p>The system displays the description of each field from the FERPA_VW record. You can modify the descriptions here.</p> <p>These descriptions appear on the FERPA self-service page in PeopleSoft Campus Self Service. If you implement FERPA self-service, you might want to modify these descriptions.</p>

Making Publications Available for Privacy Exceptions

To make publications available for privacy exceptions, use the Institution Publications component (INST_PUB_TBL) and the Publication Categories component (INST_CATG_TBL).

This section provides an overview of making publications available for FERPA exceptions and discusses how to define publication categories:

Understanding Publications as Privacy Control Exceptions

You can make publication categories available for exceptions to FERPA privacy restrictions. Students can then elect to permit your institution to release otherwise restricted data for publication in certain types of publications created for your institution. For example, a student might restrict the release of her name, home address, and phone number but permit you to include it in your internal student community directory.

Pages Used to Make Publications Available for Privacy Control Exceptions

<i>Page Name</i>	<i>Definition Name</i>	<i>Navigation</i>	<i>Usage</i>
Institution Publications	INST_PUB_TABLE	Set Up SACR > Product Related > Campus Community > Define Campus Community > Setup > Institution Publications	Create or review codes for each of your institution's publications.
Publication Categories	INST_CATG_TABLE	Set Up SACR > Product Related > Campus Community > Define Campus Community > Setup > Publication Categories	Organize your institution's publications into categories that you can make available for exception to an individual's FERPA restrictions.

Defining Publication Categories

Access the Publication Categories page (**Set Up SACR > Product Related > Campus Community > Define Campus Community > Setup > Publication Categories**).

Description

Field or Control	Description
Description	<p>Enter the description of the publication category.</p> <p>Two publication categories are delivered with your system: <i>All Community Directories</i> and <i>Student Community Directories</i>. These are used in PeopleSoft Campus Solutions Self Service. You can add new categories and add publications to the delivered categories, but do <i>not</i> delete the delivered categories.</p> <p>See “Searching Community Directories” (Campus Self Service).</p>

Institution Publications

Field or Control	Description
Publication	<p>Enter the code for the specific publication in this category.</p> <p>You can add publications to this category on the Institution Publications page.</p>

Using FERPA Web Services

Understanding FERPA as a Service

With the increased distribution of Person data outward from Campus Solution as the system of record, institutions need the ability to determine whether students have elected to protect their information under U.S. FERPA (Family Educational Rights and Privacy Act) regulation, as well as the actual data elements they want protected. FERPA as a Service provides a publish or notify capability that indicates to external systems updates have been made to a student's denoted restrictions as well as a query and read capability that conveys the students indicated FERPA restrictions.

FERPA as a Service is designed to facilitate integration of the PeopleSoft system with external systems. The service can be divided into two categories: Inbound service and Outbound service.

- The Outbound FERPA service facilitates keeping the constituent FERPA data restrictions synchronized with an external system.

The Outbound FERPA service is an asynchronous service that will publish the FERPA data whenever it is updated in Campus Solutions.

- The Inbound FERPA service allows integrated systems to determine if FERPA restrictions are set up for a person and to retrieve what data elements those restrictions are set up for.

The Inbound FERPA service is a synchronous web service that provides the EmplID as the request parameter and it includes the FERPA flag and FERPA record/field data elements as a response.

The base message for the service consists of the person's EmplID, the FERPA flag, and the record/fields specified through the FERPA Control component (FERPA_CONTROL). Administrators must review the FERPA_VW records in their system and configure them to reflect the type of information that their institution uses as directory information. The FERPA_VW records available are defined on the CC_FERPA_SEL_VW record. These view records can be modified by the institution and include specifying additional fields to incorporate more information within the same FERPA-controlled category. In addition, administrators can create and add new FERPA_VW records to add new categories to their systems FERPA control.

Prerequisites for Using FERPA Web Services

Before using FERPA web services, review these assumptions:

- Campus Solutions is considered the system of record for FERPA restrictions.
- FERPA does not regulate whether you can move data from one system to another. It is about the public exposure of the FERPA-controlled data.

- Before you can apply and manage FERPA privacy control, you must establish FERPA privacy control fields.
- Before you can allow students to identify publications for which they release FERPA privacy restrictions, you must set up your institution's publications.
- The value of the FERPA flag (Y/N) value is exposed in both the FERPA service and the Constituent Web Service (CWS).

The default value is set to (N), no restrictions set. If any FERPA restriction record fields are specified the FERPA flag is set to (Y). The CWS does not expose WHAT record/fields are restricted.

- Customers need to build the privacy controls/filters in their integrated systems to manage publication of FERPA data to avoid exposing FERPA data to 3rd parties.

In addition, before using FERPA web services, your application server must be configured such that the publish/subscribe servers are running, and domains and gateways are configured. In addition, in order to use the PERSON_DATA queue for web services, configure the Queue Definitions page so that the PERSON_DATA Queue Status is set to Run. You must also configure the integration gateway using Integration Broker.

See *PeopleTools: Integration Broker*

Inbound and Outbound Services

The PeopleSoft Campus Solutions system delivers one outbound FERPA service operation to notify external systems of changes to Campus Solutions constituent FERPA data and one inbound FERPA service operation to read ("get") FERPA details for a single constituent.

Inbound FERPA Service

The inbound FERPA service validates the EmplID of a constituent, if present, and populates the response message with the details of the restricted data of the constituent.

This example illustrates the fields and controls on the General page: inbound service (FERPA).

General
Handlers
Routings

Service Operation: SCC_GET_FERPA
OType: Synchronous

***Operation Description:**
Operation Comments:

Object Owner ID:
Operation Alias:

User/Password Required
***Req Verification:**
[Service Operation Security](#)

Used with Think Time Methods

Default Service Operation Version

***Version:**
Version Description:
Version Comments:

Non-Repudiation
 Runtime Schema Validation

[Introspection](#)

Default
 Active

Routing Status

Any-to-Local: Exists
Local-to-Local: Does not exist

Routing Actions Upon Save

Regenerate Any-to-Local
 Generate Local-to-Local
 Transactional

Warning: Regenerating sets all routing field values to their initial state.

Message Information

Type: Request
Message.Version: [View Message](#)

Type: Response
Message.Version: [View Message](#)

Type: Fault
Message.Version: [View Message](#)

Description

Service	SCC_FERPA_SERVICE
Operation	SCC_GET_FERPA
Direction/Type	Inbound/Synchronous

Summary	Allows an external system to retrieve constituent FERPA data from the PeopleSoft system
Request Message	SCC_FERPA_REQ_MSG.V1
Response Message	SCC_FERPA_DATA_MSG.V1
Description	The Get FERPA Service takes an EmplID and returns the associated constituent FERPA restricted data. (record/fields)
Pre-Conditions	Valid EmplID
Processing	<p>This service operation performs the following processing steps:</p> <ol style="list-style-type: none"> 1. Looks up constituent FERPA restrictions based on EmplID. 2. Returns constituent FERPA restriction data records/fields.
Post-Conditions	Constituent FERPA Restriction Data Details returned.

Outbound FERPA Service

The outbound FERPA service publishes to or notifies external systems of changes to Campus Solutions FERPA data for constituents.

This example illustrates the fields and controls on the General page: outbound service (FERPA).

General
Handlers
Routings

Service Operation: SCC_FERPA_SYNC
OType: Asynchronous - One Way

***Operation Description:**
Operation Comments:

User/Password Required
***Req Verification:** None ▼
[Service Operation Security](#)

Object Owner ID: Campus Community ▼
Operation Alias:

Default Service Operation Version

***Version:** V1

Version Description:
Version Comments:

Non-Repudiation
 Runtime Schema Validation

[Introspection](#)

Default
 Active

Routing Status

Any-to-Local: Does not exist
Local-to-Local: Does not exist
Local-to-Atom: Does not exist.

Routing Actions Upon Save

Generate Any-to-Local
 Generate Local-to-Local

Message Information

Type: Request

Message.Version: SCC_FERPA_DATA_MSG.V1 🔍 [View Message](#)

***Queue Name:** PERSON_DATA 🔍 [View Queue](#)

[Add New Queue](#)

Description

Service	SCC_FERPA_SYNC
Operation	SCC_FERPA_SYNC
Direction/Type	Outbound/Asynchronous
Summary	Updates a constituents FERPA data restrictions in an external system based on the restrictions set in the PeopleSoft Campus Solutions system.
Request Message	SCC_FERPA_DATA_MSG.V1
Queue Name	PERSON_DATA

Description	This service is configured to be published to an external system when a constituent's FERPA data restrictions are created or updated. This process is designed to keep a system like a hub, in sync with the Campus Solutions system. This is an asynchronous call, so there is no return.
Pre-Conditions	Valid constituent FERPA restriction data. Triggers are set up on FERPA administrative pages and self service pages.
Processing	This service operation performs the following processing steps: <ol style="list-style-type: none"> 1. A change or creation of constituent FERPA restriction data triggers an event. 2. The event sends out a message to an external system with the related constituent FERPA restriction data.
Post-Conditions	N/A Asynchronous

Create the Subscription by adding a new Routing to the SCC_FERPA_SYNC Service operation to consume the published messages in to third party integration system.

1. Navigate to **People Tools > Integration Broker > Integration Setup > Service Operations.**
2. Search for the SCC_FERPA_SYNC Service Operation and navigate to Routings Tab.
 - a. Provide the Routing Name and click **Add** button.
 - b. Enter Description.
 - c. Sender Node: Local Node name of Campus Solutions.
 - d. Receiver Node: any External Node name.
 - e. Navigate to Connector Properties tab.

Gateway ID	Select Integration Gateway	
Connector ID	HTTPTARGET	
Connector Properties:		
HTTPPROPERTY	Method	POST
HTTPPROPERTY	SOAPUpContent	Y
HEADER	Content-Type	text/xml

HEADER	SOAPAction	<soapactionstring>
PRIMARYURL	URL	<endpoint url of the service provided in third party system> ex: http://hostname:port/ServiceName

This example illustrates the fields and controls on the Routings page (FERPA).

This example illustrates the fields and controls on the Connector Properties page (FERPA).

FERPA Service Trigger Components

There are currently three pages within the Campus Solutions where FERPA restrictions can be set. Two administrative pages (FERPA and FERPA Quick Entry) and one Self Service page (FERPA Restrictions).

There are many pages where users can view the FERPA restrictions, but these pages do not allow access to create or update the current restrictions set for a person.

Administrative Page: FERPA

<i>Field or Control</i>	<i>Description</i>
Navigation	<p>Campus Community > Personal Information > Biographical > Person FERPA > FERPA</p> <p>Campus Community > Personal Information (Student) > Biographical (Student) > Student FERPA > FERPA</p>
Page	FERPA
Component	FERPA

This example illustrates the fields and controls on the FERPA page. You can find definitions for the fields and controls later on this page.

FERPA

Ralph Crowe ID: CC0001

FERPA When selected, the following information will be restricted from release (with the noted exceptions for Release to Publications) according to FERPA guidelines and policies.

FERPA Restrictions

*Record (Table) Name: ADDR_FERPA_VW Addresses + -

*Field Name: BILL Billing + -

▼ Restriction Exceptions (by Publication Category)

- Add

*Field Name: CAMP Campus + -

▼ Restriction Exceptions (by Publication Category)

All Community Directories - Add

*Field Name: HOME Home + -

▼ Restriction Exceptions (by Publication Category)

Student Community Directories - Add

Administrative Page: FERPA Quick Entry

<i>Field or Control</i>	<i>Description</i>
Navigation	<p>Campus Community > Personal Information > Biographical > Person FERPA > FERPA Quick Entry</p> <p>Campus Community > Personal Information (Student) > Biographical (Student) > Student FERPA > FERPA Quick Entry</p>
Page	FERPA_ADMIN_QENTRY
Component	FERPA_ADMIN_QENTRY

This example illustrates the fields and controls on the first section of the FERPA Quick Entry page.

FERPA Quick Entry

Ralph Crowe

When selected, the following information will be restricted from release (with the noted exceptions for Release to Publications) according to FERPA guidelines and policies.

Restrict All Fields
Release All Restrictions

Restriction Categories

Extracurricular Activities

Restrict	
<input checked="" type="checkbox"/>	Archery Release to Publication
<input type="checkbox"/>	Basketball
<input type="checkbox"/>	Football

Restrict All
Release All

Self Service Page: FERPA Restrictions

<i>Field or Control</i>	<i>Description</i>
Navigation	Self Service > Campus Personal Information > FERPA Restrictions
Page	SS_CC_FERPA

Field or Control	Description
Component	SS_CC_FERPA_SETUP

This example illustrates the fields and controls on the first section of the FERPA Restrictions page.

Betty Locherty

FERPA Restrictions

Edit FERPA/Directory Restrictions

Under the Family Educational Rights and Privacy Act, you have the right to restrict the release of certain categories of information. To restrict information, check Restrict next to the description. To restrict all types of a certain category, click Restrict All for that category. To restrict all types of all categories, click Restrict All Fields at the top of the page.

Note that when you choose to restrict the release of information, that information will not be released to any source, including publications such as telephone directories or other institutional publications.

To provide exceptions to the restriction of the release of information, click Release To Publication.

restrict all fields
release all restrictions

Restriction Categories

Extracurricular Activities

restrict all
release all

Restrict	
<input type="checkbox"/>	Archery
<input type="checkbox"/>	Basketball
<input type="checkbox"/>	Football

FERPA Service Messages

FERPA web services uses two types of messaging. The system generates outbound messages when a Constituent's FERPA data is changed in Campus Solutions. A change in any data element in the FERPA message definition raises this condition. The system publishes the FERPA message so that any integrated external system can be informed. When a third-party or external system needs to query the Campus Solutions database to view data, the system generates a query message. This is a synchronous inbound request/response get service, in which a third party raises a query or data request and the Campus Solutions system delivers a response that contains the requested data details.

FERPA web services deliver the following messages, which are defined using PeopleTools Integration Broker:

- SCC_FERPA_REQ_MSG
- SCC_FERPA_DATA_MSG

Message Property	Value
Message	SCC_FERPA_REQ_MSG
Version	V1
Message Alias	<i>Not Applicable (N/A)</i>
Description	Ferpa Request Message
Message Type	Container based Message
Part Message	SCC_ENTITY_FERPA_REQ

Message Property	Value
Message	SCC_FERPA_DATA_MSG
Version	V1
Message Alias	<i>Not Applicable (N/A)</i>
Description	Ferpa Data Message
Message Type	Container based Message
Part Message	SCC_ENTITY_FERPA_DATA

Message Property	Value
Message	SCC_ENTITY_FERPA_REQ
Version	V1
Message Alias	<i>Not Applicable (N/A)</i>
Description	Ferpa Entity Request Part Message

Message Property	Value
Message Type	Non Rowset based Part Message

Message Property	Value
Message	SCC_ENTITY_FERPA_DATA
Version	V1
Message Alias	<i>Not Applicable (N/A)</i>
Description	Ferpa Entity Data Part Message
Message Type	Non Rowset based Part Message

Sample Request Message:

```
<?xml version="1.0"?>
<SCC_FERPA_REQ_MSG xmlns:xs="http://www.w3.org/2001/XMLSchema">
  <SCC_ENTITY_FERPA_REQ>
    <EMPLID>AA0002</EMPLID>
  </SCC_ENTITY_FERPA_REQ>
</SCC_FERPA_REQ_MSG>
```

Sample Data Message:

```
<?xml version="1.0"?>
<SCC_FERPA_DATA_MSG>
  <SCC_ENTITY_FERPA_DATA>
    <EMPLID>AA0002</EMPLID>
    <FERPA>Y</FERPA>
    <SCC_FERPA_OVRD_VW>
      <RECNAME>Extracurricular Activities</RECNAME>
      <SCC_FERPA_OVERRIDE>
        <FIELDNAME>Archery</FIELDNAME>
        <SCC_FERPA_PUB_CATG>
          <INST_PUB_CATG>Directories</INST_PUB_CATG>
        </SCC_FERPA_PUB_CATG>
      </SCC_FERPA_OVERRIDE>
      <SCC_FERPA_OVERRIDE>
        <FIELDNAME>Basketball</FIELDNAME>
        <SCC_FERPA_PUB_CATG>
          <INST_PUB_CATG>Directories</INST_PUB_CATG>
        </SCC_FERPA_PUB_CATG>
        <SCC_FERPA_PUB_CATG>
          <INST_PUB_CATG>All Community Directories</INST_PUB_CATG>
        </SCC_FERPA_PUB_CATG>
      </SCC_FERPA_OVERRIDE>
      <SCC_FERPA_OVERRIDE>
        <FIELDNAME>Football</FIELDNAME>
        <SCC_FERPA_PUB_CATG>
          <INST_PUB_CATG>Student Community
            Directories</INST_PUB_CATG>
        </SCC_FERPA_PUB_CATG>
      </SCC_FERPA_OVERRIDE>
    </SCC_FERPA_OVRD_VW>
  </SCC_ENTITY_FERPA_DATA>
```

</SCC_FERPA_DATA_MSG>

Entities

The following entities are delivered:

SCC_FERPA_REQ

Entity ID:	<i>Not Applicable (N/A)</i>
Name:	SCC_FERPA_REQ
Status:	Active
Entity Type:	Basic Entity
Description:	Ferpa Request Entity
AppClass:	<i>Not Applicable (N/A)</i>
Prod Record:	SCC_PERS_SA_VW
Element (XML):	SCC_ENTITY_FERPA_REQ
Child Entities:	<i>Not Applicable (N/A)</i>

SCC_FERPA_DATA

Entity ID:	<i>Not Applicable (N/A)</i>
Name:	SCC_FERPA_DATA
Status:	Active
Entity Type:	Basic Entity
Description:	Ferpa Data Entity
AppClass:	<i>Not Applicable (N/A)</i>
Prod Record:	SCC_PERS_SA_VW
Element (XML):	SCC_ENTITY_FERPA_DATA

Child Entities:	SCC_FERPA_OVRD_VW
-----------------	-------------------

SCC_FERPA_OVRD_VW

Entity ID:	<i>Not Applicable (N/A)</i>
Name:	SCC_FERPA_OVRD_VW
Status:	Active
Entity Type:	Basic Entity
Description:	Ferpa Override View Entity
AppClass:	<i>Not Applicable (N/A)</i>
Prod Record:	FERPA_OVRD_VW
Element (XML):	SCC_FERPA_OVRD_VW
Child Entities:	SCC_FERPA_OVERRIDE

SCC_FERPA_OVERRIDE

Entity ID:	<i>Not Applicable (N/A)</i>
Name:	SCC_FERPA_OVERRIDE
Status:	Active
Entity Type:	Basic Entity
Description:	Ferpa Override Entity
AppClass:	<i>Not Applicable (N/A)</i>
Prod Record:	FERPA_OVERRIDE
Element (XML):	SCC_FERPA_OVERRIDE
Child Entities:	SCC_FERPA_PUB_CATG

SCC_FERPA_PUB_CATG

Entity ID:	<i>Not Applicable (N/A)</i>
Name:	SCC_FERPA_PUB_CATG
Status:	Active
Entity Type:	Basic Entity
Description:	Ferpa Pub Catg Entity
AppClass:	<i>Not Applicable (N/A)</i>
Prod Record:	FERPA_PUB_CATG
Element (XML):	SCC_FERPA_PUB_CATG
Child Entities:	<i>Not Applicable (N/A)</i>

Related Links

[Understanding Entity Registry](#)

Setting Up Personal Identification Data

Setting Up Citizenship, Visa, and Permit Data

For information about setting up personal identification data such as citizenship, visa, or permit data, see:

- [Defining Citizen Status Codes](#)
- [Defining Visas and Permits](#)

Note: No specific setup is required for external system ID, photos, or personal identification numbers (PINs).

Setting Up Residency Rules

To set up residency rules, use the Residency Table (RESIDENCY_TABLE) component and Residency Exception Table (RESID_EXCPT_TABLE) component.

This section discusses how to:

- Define residency rules.
- Define residency rule exceptions.

Pages Used to Set Up Residency Rules

<i>Page Name</i>	<i>Definition Name</i>	<i>Navigation</i>	<i>Usage</i>
Residency Table	RESIDENCY_TABLE	Set Up SACR > Product Related > Campus Community > Define Campus Community > Setup > Residency Table	Define codes for residency rules.
Residency Exception Table	RESID_EXCPT_TABLE	Set Up SACR > Product Related > Campus Community > Define Campus Community > Setup > Residency Exception Table	Define codes residency rule exceptions.

Defining Residency Rules

Access the Residency Table page (**Set Up SACR > Product Related > Campus Community > Define Campus Community > Setup > Residency Exception Table**).

Enter information to describe the residency code that you want to create.

Defining Residency Rule Exceptions

Access the Residency Exception Table page (**Set Up SACR > Product Related > Campus Community > Define Campus Community > Setup > Residency Exception Table**).

Enter information to describe the residency exception code that you want to create.

Chapter 15

Setting Up Health Data

Setting Up Physicians

You can set up physicians (including addresses and phone numbers) in your database so that they are available to reference when tracking health data.

Note: If you implement Campus Solutions *and* a separate instance of PeopleSoft Human Capital Management, read the relevant documentation about CS-HCM Integration to understand the setup, functional, and technical implementation considerations.

See:

“Integrating Person Data” (Campus Solutions Application Fundamentals)

“Integrating Setup Data” (Campus Solutions Application Fundamentals)

“Monitoring Integrations Using the Integrity Utility” (Campus Solutions Application Fundamentals)

Information Center: CS-HCM Integration for PeopleSoft Enterprise Campus Solutions in My Oracle Support (ID 2091799.2).

Related Links

[Understanding Health Information](#)

Pages Used to Define Physicians

Page Name	Definition Name	Navigation	Usage
Name (Physician Table)	HS_PHYSICIAN_DATA1	Set Up Common Objects > Product Related > Workforce Monitoring > Health and Safety > Physician Table	Enter or review the name of a physician or other medical professional in your database.
Address (Physician Table)	HS_PHYSICIAN_DATA2	Set Up Common Objects > Product Related > Workforce Monitoring > Health and Safety > Physician Table	Enter or review the address of a physician or other medical professional in your database.
Phone Number (Physician Table)	NE_PERS_DTAPH_SEC	Click the Phone link at the bottom of the Address (Physician Table) page.	Enter or review the phone numbers of a physician or other medical professional in your database.

Entering Physician Names

Access the Physician Table – Name page (**Set Up Common Objects > Product Related > Workforce Monitoring > Health and Safety > Physician Table**).

<i>Field or Control</i>	<i>Description</i>
Physician ID	<p>The non-employee ID that is assigned to the physician appears in this field.</p> <p>If you choose to have the system automatically assign non-employee IDs, it assigns to the physician the number that immediately follows the one in the Last HS Non-Employee ID Assgn field in the Installation Table. The number first appears as 0000000000. The actual number appears after you save the information here.</p> <hr/> <p>Warning! To avoid maintaining two different sets of non-employee IDs, PeopleSoft recommends that you either always manually assign numbers or let the system do it.</p>
Name Format	Select the relevant country for the name format you want to use for this person. The appropriate fields for the country that you enter appear on the Edit Name page.
Edit Name	Click this link to access the Edit Name page on which you enter name details in the appropriate country format.

Related Links

“Selecting General Installation Options” (Campus Solutions Application Fundamentals)

Setting Up Diagnosis Codes

You can set up codes to identify injuries and illnesses and use them to monitor health and safety incidents. Physicians often use standard terminology to describe the results of their examinations. You can set up the same standard codes, such as those that the American Medical Association has established, or enter your own institution-specific codes.

Note: If you implement Campus Solutions *and* a separate instance of PeopleSoft Human Capital Management, read the relevant documentation about CS-HCM Integration to understand the setup, functional, and technical implementation considerations.

See:

“Integrating Person Data” (Campus Solutions Application Fundamentals)

“Integrating Setup Data” (Campus Solutions Application Fundamentals)

“Monitoring Integrations Using the Integrity Utility” (Campus Solutions Application Fundamentals)

Information Center: CS-HCM Integration for PeopleSoft Enterprise Campus Solutions in My Oracle Support (ID 2091799.2).

Related Links

[Understanding Health Information](#)

Page Used to Define Diagnosis Codes

<i>Page Name</i>	<i>Definition Name</i>	<i>Navigation</i>	<i>Usage</i>
Diagnosis Table	DIAGNOSIS_TABLE	Set Up Common Objects > Product Related > Workforce Monitoring > Health and Safety > Diagnosis Table	Create or review codes for injuries and illnesses that your institution wants to track.

Setting Up Accommodations

See [Setting Up for Processing Accommodations](#).

Setting Up Immunization and Health Test Types

To set up immunization test types, use the Immunization Table component (IMMUNIZATION_TABLE). To set up health test types, use the Health Test Table component (HEALTH_TST_TABLE).

Set up codes to identify the immunization and general health tests that your institution requires or that students typically choose to report. You can use these codes to record and track an individual's immunization and general health test data.

This section discusses how to:

- Define immunization test codes.
- Define health test codes.

Pages Used to Set Up Immunization and Health Test Codes

<i>Page Name</i>	<i>Definition Name</i>	<i>Navigation</i>	<i>Usage</i>
Immunization Table	IMMUNIZATION_TABLE	Set Up SACR > Product Related > Campus Community > Define Campus Community > Setup > Immunization Table	Define or review codes for immunization tests.

<i>Page Name</i>	<i>Definition Name</i>	<i>Navigation</i>	<i>Usage</i>
Health Test Table	HEALTH_TST_TABLE	Set Up SACR > Product Related > Campus Community > Define Campus Community > Setup > Health Test Table	Define or review codes for health tests.

Defining Immunization Test Codes

Access the Immunization Table page (**Set Up SACR > Product Related > Campus Community > Define Campus Community > Setup > Immunization Table**).

Immunization Criteria

Use the fields in this group box to set up a numbered list of events or any list of items to associate with this immunization. These fields are optional.

<i>Field or Control</i>	<i>Description</i>
Criteria Number	<p>The system displays the number of the item on the list of criteria for the immunization.</p> <p>The system displays the next sequential number for each item that you add. You can use these numbers as reference IDs for items in a randomly ordered list. Or, you can override them to reorder the list of items according to the order in which the events must occur.</p>
Description	Enter the description of the item or event.

Defining Health Test Codes

Access the Health Test Table page (**Set Up SACR > Product Related > Campus Community > Define Campus Community > Setup > Health Test Table**).

Health Test Criteria

Use the fields in this group box to set up a numbered list of events or any list of items to associate with a health test. These fields are optional.

<i>Field or Control</i>	<i>Description</i>
Criteria Number	<p>The system displays the number of the item on the list of criteria for the health test.</p> <p>The system automatically enters the next sequential number for each item that you add. You can use these as reference IDs for items in a randomly ordered list or override them to reorder the list of items according to the order in which the events must occur.</p>
Description	Enter the description of the item or event.

Setting Up Participation Data

Setting Up Athletic Participation

To set up athletic participation, use the Athletic Participation Table component (ATHL_PART_TABLE). This section discusses how to set up athletic participation codes.

Page Used to Set Up Athletic Participation

<i>Page Name</i>	<i>Definition Name</i>	<i>Navigation</i>	<i>Usage</i>
Athletic Participation Table	ATHL_PART_TABLE	Set Up SACR > Product Related > Campus Community > Define Campus Community > Setup > Athletic Participation Table	Set up or review athletic participation codes.

Defining an Athletic Participation Code

Access the Athletic Participation Table page (**Set Up SACR > Product Related > Campus Community > Define Campus Community > Setup > Athletic Participation Table**).

<i>Field or Control</i>	<i>Description</i>
Current Participant	Select this check box to set the default participation associated with this code to current participant.
NCAA Eligible (National Collegiate Athletic Association eligible)	Select this check box to set the default participation associated with this code to a current eligibility to participate according to NCAA rules and regulations.

Setting Up Extracurricular Activities

To set up extracurricular activities, use the Extracurricular Activities component (EXTRA_ACTIVITY_TBL).

This section discusses how to set up extracurricular activity codes.

Page Used to Set Up Extracurricular Activities

<i>Page Name</i>	<i>Definition Name</i>	<i>Navigation</i>	<i>Usage</i>
Extracurricular Activity Table	EXTRA_ACTIVITY_TBL	Set Up SACR > Product Related > Campus Community > Define Campus Community > Setup > Extracurricular Activity Tbl	Set up or review the types of student activities to track.

Defining an Extracurricular Activity Code

Access the Extracurricular Activity Table page (**Set Up SACR > Product Related > Campus Community > Define Campus Community > Setup > Extracurricular Activity Tbl**).

Description

<i>Field or Control</i>	<i>Description</i>
Activity Type	Enter the type of activity (<i>Athletics, Student Government, Theater, Volunteer</i> and so on) that you are defining. Activity type values are delivered with your system as translate values. You can modify these translate values if necessary.

Activity Offering

<i>Field or Control</i>	<i>Description</i>
Internal and External	Select this check box to indicate that this activity is offered within and outside of your institution.
Internal	Select this check box to indicate that this activity is offered only within your institution.
External	Select this check box to indicate that this activity is offered only outside of your institution.

<i>Field or Control</i>	<i>Description</i>
Extra Activity Primacy	<p>Enter the number that describes the level of importance of this extracurricular activity. The lower the number the higher the importance.</p> <p>For example, a primacy number of <i>1</i> indicates that this is a primary or most important activity. A primacy number of <i>10</i> indicates that this is an activity of much lesser importance.</p>

Setting Up Honors and Awards

You can set up honors and awards and track them, whether earned internally or externally.

PeopleSoft Student Records tracks honors and awards and uses them for transcripts and graduation.

Related Links

“Setting Up Honors and Awards” (Student Records)

“Processing Transcripts for Individuals or Small Groups of Students” (Student Records)

Page Used to Set Up Honors and Awards

<i>Page Name</i>	<i>Definition Name</i>	<i>Navigation</i>	<i>Usage</i>
Honors/Awards Table	SA_HON_AWRD_TABLE	<ul style="list-style-type: none"> Set Up SACR > Product Related > Define Campus Community > Setup > Honors and Awards Set Up SACR > Product Related > Student Records > Student Standing and Award > Honors/Awards Table 	Set up internal and external honors and awards.

Setting Up Memberships, Licenses, and Certificates

You can set up licenses to track achievements and memberships to identify affiliations of individuals in your campus community.

See [Reviewing Content Types and Items](#).

Setting Up Organization Data

Defining Organization Groups and Contacts

To define organization groups and contacts, use the Organization Group Table component (ORG_GRP_CD_TABLE) and the Contact Type Table component (ORG_CNTCT_TYPE_TBL).

This section provides an overview of group types and discusses how to:

- Define organization group types.
- Define contact types.

Understanding Group Types

Group types and codes within each group type enable you to group similar organizations at a high level and further define them into specific categories. For example, in admissions, you can group organizations according to their academic quality by setting up a high-level group type of *Academic Quality*. Within that group type, you can further identify each organization in the group by assigning group codes of *Below Average*, *Average*, and *Highly Competitive*. Some organization group types are predefined when your system is shipped. Review these to be sure they meet your institution's needs; create others if necessary.

You can also set up the types of contact persons typically available to your institution. Contact types help you to identify the role of the contact person at each organization in your database. For example, you might indicate that the contact for Cottonwood High School is Mr. Raymond Scott, but you probably also want to specify whether he is a teacher, guidance counselor, or the principal.

Although these examples relate to schools, you can also use group types, group codes, and contact types to organize all types of organizations in your system.

Pages Used to Define Groups and Contacts

<i>Page Name</i>	<i>Definition Name</i>	<i>Navigation</i>	<i>Usage</i>
Organization Group Table	ORG_GROUP_TABLE	Campus Community > Organization > Define Organization Data > Organization Group Table	Define organization group types and associate them with group codes.

Page Name	Definition Name	Navigation	Usage
Contact Type Table	ORG_CNTC_TYP_TABLE	<ul style="list-style-type: none"> • Campus Community > Organization > Define Organization Data > Contact Type Table • Set Up SACR > Product Related > Contributor Relations > Constituent Information > Contact Type Table 	Define the type of contacts that your institution might have with the organizations.

Defining Organization Group Types

Access the Organization Group Table page ((**Campus Community** > **Organization** > **Define Organization Data** > **Organization Group Table**).

This example illustrates the fields and controls on the Organization Group Table page. You can find definitions for the fields and controls later on this page.

Organization Group Table

Organization Group Type: ACA Academic Quality

Organization Group Code: AVG

Organization Group Details					
*Effective Date	*Status	*Description	Short Description		
01/01/1900	Active	Average	Average		

Enter information to define the organization group that you want to create.

Defining Contact Types

Access the Contact Type Table page ((**Campus Community** > **Organization** > **Define Organization Data** > **Contact Type Table**).

This example illustrates the fields and controls on the Contact Type Table page. You can find definitions for the fields and controls later on this page.

Contact Type Table

Contact Type: PRN

Contact Details					
*Effective Date	*Status	*Description	Short Description		
01/01/1900	Active	Principal	Principal		

Enter information to define the organization contact type that you want to create.

Creating or Loading External Organization Codes

To create or load external organization codes, use the External Organization Code Type Table component (EXTORGCDTYPE_TABLE).

This section provides an overview of external organization codes and discusses how to load or define external codes for organization types.

Understanding External Organization Codes

Load or set up external agency codes to make them available to associate with organizations. For example, if your institution loads Enrollment Planning Service (EPS) market codes, the load process enters each code on the External Organization Code Type table. Those codes are then available for you to assign to organizations on the Organization External Codes page.

Related Links

“Loading EPS Market Codes” (Recruiting and Admissions)

Page Used to Create External Organization Codes

<i>Page Name</i>	<i>Definition Name</i>	<i>Navigation</i>	<i>Usage</i>
External Organization Code Type	EXTORGCDTYPE_TABLE	Campus Community > Organization > Define Organization Data > Ext Org Code Type Table	Load or define external codes for organization types.

Loading or Defining External Codes for Organization Types

Access the External Organization Code Type page (**Campus Community > Organization > Define Organization Data > Ext Org Code Type Table**).

Code Type Option

<i>Field or Control</i>	<i>Description</i>
EPS	Select to indicate that this code is an EPS market code.
None	Select to indicate that this code is not an EPS market code.

Setting Up External Subject Categories and Term Sessions

To set up external subject categories and term sessions, use the External Subject Table component (EXT_SUBJECT_TBL) and the External Term component (EXTERNAL_TRM_TABLE).

This section provides an overview of external subjects, terms, and categories, and discusses how to:

- Define external subject categories.
- Define external term sessions.

Understanding External Subjects, Terms, and Courses

External subjects are general subject areas that you define for the purpose of categorizing external courses.

Set up external subject categories to broadly identify the subjects offered at external institutions. Use those categories to identify which institutions offer courses in those subjects. For example, perhaps one of the entrance requirements at your institution is four years of high school English. Various high schools offer classes titled 17th Century English Literature, Mystery Writers of America, and A Journey through Time with Shakespeare. When these classes appear on a student's transcript they do not readily translate as English courses. If you create a broad external subject of *English*, you can assign these courses to it to help track your institution's English requirements. Use the School Course Classification page to record the specific course offerings for each subject area.

When you track information regarding external institutions for a prospect, applicant, or student, you should know the specific term to which that information is related. For example, when you enter external transcript or external transfer credit information, you should record the term to which the transcript information pertains. Because external institutions use various term structures, possible terms should be available to help identify that particular organization's term structure. Some external terms are redefined translate values. Review these values to verify whether they meet your institution's needs and create others if necessary. You can also set up how you want the system to convert external term sessions to your term structure.

Related Links

“Understanding Transfer Credit Processing” (Student Records)

Pages Used to Set Up External Subject Categories and Term Sessions

<i>Page Name</i>	<i>Definition Name</i>	<i>Navigation</i>	<i>Usage</i>
External Subject Table	EXT_SUBJECT_TBL	<ul style="list-style-type: none"> • Set Up SACR > Common Definitions > External Education > External Subjects • Campus Community > Organization > Define Organization Data > External Subject Table 	Define broad categories of the subjects offered at external organizations.
External Term Table	EXTERNAL_TRM_TABLE	<ul style="list-style-type: none"> • Set Up SACR > Common Definitions > External Education > External Term • Campus Community > Organization > Define Organization Data > External Term 	Define or review possible external terms sessions for external organizations.

Defining External Subject Categories

Access the External Subject Table page (**Set Up SACR > Common Definitions > External Education > External Subjects**).

<i>Field or Control</i>	<i>Description</i>
Academic Interest	<p>Select this check box to permit this code to be used as both an academic interest code and an external subject code.</p> <p>Academic interests are external subject areas in which a prospect or applicant has expressed interest that might not be offered by your program. If you want to record those interests for recruiting and analysis purposes, define them here.</p> <p>When you enter external subjects for a prospect or applicant on the Education page, all codes defined in this table are available.</p> <p>When you enter academic interests for a prospect or applicant on the Academic Interests page, only the codes that are defined as academic interests on this page are available.</p>

Related Links

“Tracking Supporting Information for Prospects and Applicants” (Recruiting and Admissions)

“Entering and Updating External Education Data” (Recruiting and Admissions)

Defining External Term Sessions

Access the External Term Table page (**Set Up SACR > Common Definitions > External Education > External Term**).

This example illustrates the fields and controls on the External Term Table page. You can find definitions for the fields and controls later on this page.

External Term Table

External Term Type: QTR Quarter

External Term: FALL Fall

Additional Information

***Description:**

Short Description:

Begin Month: September

***Term Unit Type:** ***Unit Type:**

Internal Term type Conversion Customize | Find | First 1 of 1 Last

*Term Unit Type	*Term Type Multiple
Quarter <input type="button" value="▼"/>	1.33 <input type="button" value="+"/> <input type="button" value="-"/>

Additional Information

<i>Field or Control</i>	<i>Description</i>
Begin Month	<p>Enter the month in which the external term begins.</p> <p>Values for this field are delivered with your system as translate values. Do not modify these values in any way. Any modifications to these values could require substantial programming effort.</p>
Term Unit Type	<p>Select the type of internal term unit that most closely correlates to this external term type.</p> <p>Values for this field are delivered with your system as translate values. You can modify these translate values.</p>

Field or Control	Description
Unit Type	<p>Select the credit or term type that further describes the correlation of this external term to your institution's term unit type.</p> <p>PeopleSoft Recruiting and Admissions uses this field for information only. For example, they might want to describe the external term as having a Quarter term unit type with a unit type value of <i>No Credit</i>.</p> <p>Values for this field are delivered with your system as translate values. You can modify these translate values.</p>

Internal Term Type Conversion

Field or Control	Description
Term Unit Type	Enter the external term unit type that you want the system to convert to an equivalent of the internal term unit.
Term Type Multiple	<p>Enter the factor by which the system should multiply the external term unit type to convert it to an equivalent of the specified internal term unit type.</p> <p>For example, the external term unit type of Quarter multiplied by a term type multiple of 1.33 might be the equivalent of your internal Semester term unit type. The system provides this conversion when calculating transfer credit for a manually assigned equivalent course.</p>

Related Links

“Setting Up Unit Conversions ” (Student Records)

Setting Up External Education Comments

To define default comments for external education data, use the External Education Comments component (SAD_EXT_COM_TBL).

Default comments that are defined on the External Education Comments page can be entered in the Education component, at the transcript level, career level, or for a specific course.

This section discusses how to define default comments.

Page Used to Define External Education Comments

<i>Page Name</i>	<i>Definition Name</i>	<i>Navigation</i>	<i>Usage</i>
External Education Comments	SAD_EXT_COM_TBL	Set Up SACR > Common Definitions > External Education > External Education Comments	Define default comments for external education data.

Defining External Education Comments

Access the External Education Comments page (**Set Up SACR > Common Definitions > External Education > External Education Comments**).

This example illustrates the fields and controls on the External Education Comments page. You can find definitions for the fields and controls later on this page.

External Education Comments

Academic Institution: PSUNV PeopleSoft University

Default Comment Code: TRN

Description:

Short Description:

Comment:

Incomplete Transcript: Final Evaluation Pending

Transcript Comment

Course Comment

External Career: ▼

<i>Field or Control</i>	<i>Description</i>
Default Comment Code	Enter a code for the default comment.
Description	Enter a description of the comment code.
Short Description	Enter an abbreviated description of the comment code.
Comment	Enter the default text for the comment.
Transcript Comment and Course Comment	Select to indicate that the default comment relates to a transcript or to a specific course.

<i>Field or Control</i>	<i>Description</i>
External Career	Enter the external career to which the comment relates.

Setting Up Organization Types

To define an organization type, use the External Organization Type Table component (SCC_ORG_TYP_TB).

The External Organization Type Table page defines the business structure of an organization used by an institution such as Business, Non-Profit, School, Foundation, Knowledge or Other. It also sets up the dynamic links to the various pages that a user would complete for data entry for the organization type.

This section discusses how to define the organization type.

Page Used to Define the Organization Type

<i>Page Name</i>	<i>Definition Name</i>	<i>Navigation</i>	<i>Usage</i>
External Organization Type Table	SCC_ORG_TYP_TBL	Set Up SACR > Product Related > Campus Community > Organization Processing > External Organization Type	Define the organization type.

Defining the Organization Type

Access the External Organization Type Table page (**Set Up SACR > Product Related > Campus Community > Organization Processing > External Organization Type**).

This example illustrates the fields and controls on the External Organization Type Table page. You can find definitions for the fields and controls later on this page.

External Organization Type Table

Organization Type: SCHL

Contact Find | View All First 1 of 1 Last

*Effective Date: *Status: + -

*Description:

*Short Description:

Type Navigation List Find | View All First 1 of 3 Last

*Sequence Number: *Link: + -

Menu Name: 🔍

Menu Bar Name: 🔍

Item Name: 🔍

Page Name: 🔍

Contact

<i>Field or Control</i>	<i>Description</i>
Status	Displays <i>Active</i> to indicate that a particular organization type is available. If your institution determined not to use the organization type <i>Inactive</i> displays.
Description	Enter a description of the organization type.
Short Description	Enter an abbreviated description of the organization type.

Type Navigation List

<i>Field or Control</i>	<i>Description</i>
Sequence	<p>Displays 10. This number can increase in increments of 10.</p> <p>This specifies the position of the specified link as it appears on the EXT_ORG_TABLE page (the main page used for creating/maintaining external organizations). If an external organization type needs for you to complete multiple pages to specify all the information about a specific organization type, multiple dynamic links can be displayed to specify the pages necessary to complete the information. Therefore multiple sequence numbers are used to determine how the links appear.</p>
Link	<p>Enter the name of the link.</p> <p>This link appears in the Organization Type Related group box on the Organization Table page.</p>
Menu Name	Enter the name of the menu name.
Menu Bar Name	Enter the name of the menu bar.
Item Name	Enter the item name.
Page Name	Enter the page name.

Setting Up NAICS Codes

To define NAICS codes, use the NAICS Codes component (SCC_NAICS_TBL).

The North American Industry Classification System (NAICS) replaced the U.S. Standard Industrial Classification (SIC) system in 1997 and was revised in 2001 and again in 2002. It was developed jointly by the U.S., Canada, and Mexico to compare business activity statistics across North America. This North American code indicates the type of business that the external organization conducts such as manufacturing, staffing, education.

This section discusses how to define the NAICS codes.

Page Used to Define NAICS Codes

<i>Page Name</i>	<i>Definition Name</i>	<i>Navigation</i>	<i>Usage</i>
NAICS Codes	SCC_NAICS_TBL	Set Up SACR > Product Related > Campus Community > Organization Processing > NAICS Codes	Define the NAICS codes to specify the organization classification in the definition of the external organization.

Defining NAICS Codes

Access the NAICS Codes page (**Set Up SACR > Product Related > Campus Community > Organization Processing > NAICS Codes**).

North American Industry Classification System

<i>Field or Control</i>	<i>Description</i>
Status	Enter <i>Active</i> . As these are government codes, in time, they could be replaced by a more specific code. In this instance, the code is <i>Inactive</i> .
Description	Enter a description of the code (for example, <i>21232</i> for Sand, Gravel, Clay and Ceramic and Refractory Minerals Mining and Quarrying or <i>236220</i> for Commercial Institutional Building Construction, or <i>236115</i> for New Single-Family Housing Construction (except Operative Builders).
Long Description	Enter a description. A long description usually replicates the description of the code (for example, <i>Sand, Gravel, Clay and Ceramic and Refractory Minerals Mining and Quarrying</i> or <i>Commercial Institutional Building Construction</i> , or <i>New single-Family Housing Construction (except Operative Builders)</i> .

Setting Up ATP Country Names and School Types

The ATP Load process (CCATPLOD.SQR) picks up country names and school types that are delivered in the American Testing Program (ATP) Secondary School data file load.

This section discusses the components that enable you to:

- Map ATP country names.

- Map ATP school types.

Note: The components are not delivered with values. You need to add rows to map the ATP and PeopleSoft values.

Pages Used to Set Up ATP Country Names and School Types

Page Name	Definition Name	Navigation	Usage
ATP Country Table	SCC_ATP_CNTRY_TBL	Set Up SACR > Product Related > Campus Community > Organization Processing > ATP Country Table	Map the ATP country names to the corresponding PeopleSoft country codes.
ATP School Type Table	SCC_ATP_SCH_TYPE	Set Up SACR > Product Related > Campus Community > Organization Processing > ATP School Type Table	Map the ATP school types to the corresponding PeopleSoft LS school types.

Mapping ATP Country Names

Access the ATP Country Table page (**Set Up SACR > Product Related > Campus Community > Organization Processing > ATP Country Table**).

This example illustrates the fields and controls on the ATP Country Table page. You can find definitions for the fields and controls later on this page.

ATP Country Table

Customize Find First 1-8 of 8 Last					
	ATP Country Name	Country		Description	
1	ANGOLA	AGO	🔍	Angola	+ -
2	ARGENTINA	ARG	🔍	Argentina	+ -
3	AUSTRALIA	AUS	🔍	Australia	+ -
4	BENIN	BEN	🔍	Benin	+ -
5	CANADA	CAN	🔍	Canada	+ -
6	COTE D'IVOIRE-IVORY COAST	CIV	🔍	Cote D'Ivoire	+ -
7	FRANCE	FRA	🔍	France	+ -
8	MALAYSIA	MYS	🔍	Malaysia	+ -

Mapping ATP School Types

Access the ATP School Type Table (**Set Up SACR > Product Related > Campus Community > Organization Processing > ATP School Type Table**).

This example illustrates the fields and controls on the ATP School Type Table. You can find definitions for the fields and controls later on this page.

ATP School Type Table

Customize Find First 1-5 of 5 Last						
	ATP School Type Code	Description	LS School Type	Short Description		
1	A	PUBLIC	SCD	Secondary	+	-
2	B	INDEPENDENT, NOT RELIGIOUS	CC	Community	+	-
3	C	INDEPENDENT, CATHOLIC	UKN	Unknown	+	-
4	D	OTHER INDEPENDENT, RELIGIOUS	SCD	Secondary	+	-
5	G	CORRESPONDENCE	OVS	Overseas	+	-

Related Links

“Setting Up School Types” (Recruiting and Admissions)

Setting Up Administrative Functions

Understanding Administrative Functions

Administrative functions identify the variable data or key fields associated with specific functions in the higher education environment. Throughout your system, when you select a function the associated fields or data for that function become available. With this feature, PeopleSoft helps you to ensure consistency between all records within a similar functional area across your institution. Administrative functions are also especially useful for extracting relevant data for generating letters and other communications within a specific functional area.

Warning! Campus Solutions provides predefined administrative functions on the Administrative Functions Table. You should *not* modify the delivered administrative functions. You can add administrative functions; however extensive system configuration is required to do so.

This table lists the administrative functions (and their respective codes) and variable data fields that are delivered in your system.

Code	Administrative Function	Variable Data Fields
ADMA	Admissions Application [Application Level]	<ul style="list-style-type: none"> • Academic Career • Student Career Number • Application Number
ADMP	Admissions Program [Program Level]	<ul style="list-style-type: none"> • Academic Career • Student Career Number • Application Number • Application Program Number
AVAK	Advancement Acknowledgements	<ul style="list-style-type: none"> • Designation Code • Gift Number • Initiative Code • Recognition Type • Session Number

Code	Administrative Function	Variable Data Fields
AVIN	Advancement Initiatives	<ul style="list-style-type: none"> • Audience Code • Audience Type • Initiative Code
AVMB	Advancement Membership Benefits	<ul style="list-style-type: none"> • Member Payment Number • Standard Benefit
AVMS	Advancement Membership	<ul style="list-style-type: none"> • Membership Number • Membership Organization Code
AWRD	Awarding	<ul style="list-style-type: none"> • Academic Career • Aid Year • Item Type
BDGT	Budget Maintenance	<ul style="list-style-type: none"> • Academic Career • Aid year • Effective Date (FINA) • Term
EVNT	Event	<ul style="list-style-type: none"> • Event ID • Meeting Number (optional)
FINA	Financial Aid	Aid Year
FINT	Financial Aid Term	<ul style="list-style-type: none"> • Aid Year • Term
GEN	General	None
IHC	International Health Coverage	Coverage Number
ISIR	ISIR Corrections	<ul style="list-style-type: none"> • Aid Year • Effective Date (FINA) • Effective Sequence (FINA)

Code	Administrative Function	Variable Data Fields
LOAN	Loan	<ul style="list-style-type: none"> • Aid Year • Loan Type Code • Application Sequence
NLBP	Internships NLD	Internal Contract
NLOW	Educational contracts NLD	Contract Number
PROP	Prospect Program	<ul style="list-style-type: none"> • Academic Career • Academic Program • Recruiting Center
PROS	Prospect	Academic Career
PSSV	Prospect Self Service	Academic Career
RECR	Recruiters	Academic Career
RREQ	Research Requirement	<ul style="list-style-type: none"> • Candidature Number • Assignment Type
RSCH	Research Administration	Candidature Number
RSTR	Restricted Aid	<ul style="list-style-type: none"> • Aid year • Restricted Aid ID
SENR	Student Enrollment	<ul style="list-style-type: none"> • Academic Career • Class Number • Academic Term
SFAC	Student Financials Account	<ul style="list-style-type: none"> • Business Unit • Account Number • Account Term
SFBI	Student Financials Billing	<ul style="list-style-type: none"> • Business Unit • Invoice ID

Code	Administrative Function	Variable Data Fields
SFCO	Student Financials Collections	<ul style="list-style-type: none"> • Business Unit • Collection ID
SFGR	Student Financials Groups	<ul style="list-style-type: none"> • Business Unit • Group ID
SFIT	Student Financials Item Lines	<ul style="list-style-type: none"> • Business Unit • Item Number • Line Sequence Number
SFPA	Student Financials Payments	<ul style="list-style-type: none"> • Business Unit • Payment ID Number
SFPR	Student Financials Promise	Checklist Date Time
SFRC	Student Financials Receipt	<ul style="list-style-type: none"> • Business Unit • Cashier's Office • Receipt Number
SFRF	Student Financials Refund	<ul style="list-style-type: none"> • Business Unit • Refund Number
SFTP	Student Financials Contracts	<ul style="list-style-type: none"> • Business Unit • Contract Number
SPRG	Student Program	<ul style="list-style-type: none"> • Academic Career • Career Number
STRM	Student Term	<ul style="list-style-type: none"> • Academic Career • Academic Term
SUPR	Research Supervisors	<ul style="list-style-type: none"> • Candidature Number • Supervisor Sequence
THES	Thesis Administration	<ul style="list-style-type: none"> • Candidature Number • Thesis Submission Nbr

Code	Administrative Function	Variable Data Fields
TOPC	Research Topic	<ul style="list-style-type: none"> • Candidature Number • Topic Sequence

Reviewing Administrative Functions

This section discusses how to review administrative function codes.

Page Used to Review Administrative Functions

Page Name	Definition Name	Navigation	Usage
Administrative Function Table	ADM_FUNCTION_TABLE	Set Up SACR > Common Definitions > Administrative Function Table	Review administrative functions.

Reviewing Administrative Function Codes

Access the Administrative Function Table page (Set Up SACR > Common Definitions > Administrative Function Table).

This example illustrates the fields and controls on the Administrative Function Table page. You can find definitions for the fields and controls later on this page.

Administrative Function Table

Administrative Function: ADMP

Description Find | View All | First ◀ 1 of 1 ▶ Last

*Effective Date: 01/01/1900 BT *Status: Active ▼ Variable Data + -

*Description: Admissions Program

Short Description: Adm Progm

Admin Function - People Admin Function - Organizations

Field or Control	Description
Variable Data	Click this button to access the Administrative Function Field Usage page, on which you can view a list of all the variable data fields associated with this function.

<i>Field or Control</i>	<i>Description</i>
Admin Function - People or Admin Function - Organizations	The system selects these check boxes to indicate whether the function relates to individuals or to organizations in your database.

Determining Variable Data Fields

This section discusses how to determine the data fields associated with a function.

Page Used to Determine Variable Data Fields

<i>Page Name</i>	<i>Definition Name</i>	<i>Navigation</i>	<i>Usage</i>
Administrative Function Field Usage	ADM_FUNCTION_SP	Click the Variable Data button on the Administrative Functions Table page.	View fields associated with an administrative function.

Viewing Variable Data Fields Associated with a Function

Access the Administrative Function Field Usage page (click the **Variable Data** button on the Administrative Functions Table page).

This example illustrates the fields and controls on the Administrative Function Field Usage page. You can find definitions for the fields and controls later on this page.

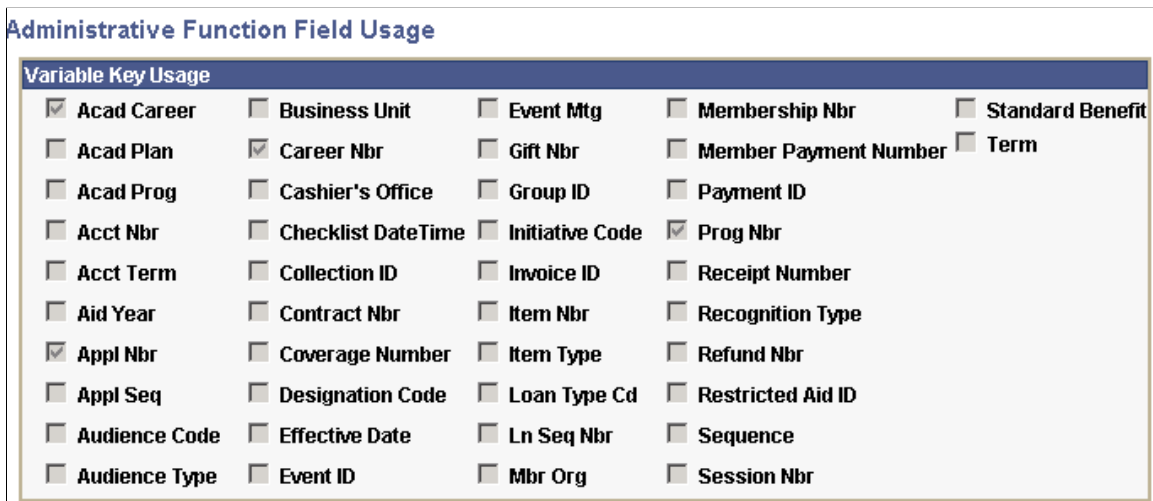

A selected check box indicates that the item is variable data for that administrative function. Administrative functions are shipped with their variable data preassigned. Any modification to these selections could require substantial programming effort.

Setting Up the Population Selection Process

Understanding Population Selection

Population selection enables you to use different tools to select IDs for a process. You can use a PS query, equation engine equation, or flat file or delimited file as a selection tool, or you can create other tools, to control which fields and records to use to identify the population. When you set up the tool in your system, you identify how many result rows to return and whether you want users to be able to preview results before running the process. Using contexts, you identify the processes for which the Population Selection feature will be available. Using context mapping, you can see which fields are mandatory or optional for the process. Inside the context, you also grant selection tool security to users.

Note: The PeopleSoft system delivers functionality for using PS queries, the equation engine, and external files as selection tools. You can create other tools, but they will require significant programming effort.

Setting Up Selection Tools

To set up selection tools, use the Selection Tool component (SCCPS_TOOL_DFN).

This section discusses how to set up selection tools.

Page Used to Set Up Selection Tools

<i>Page Name</i>	<i>Definition Name</i>	<i>Navigation</i>	<i>Usage</i>
Selection Tool	SCCPS_TOOL_DFN	Set Up SACR > System Administration > Utilities > Population Selection > Selection Tool	Identify and configure the selection tools (PS query, equation engine equation, and external file) to make available for population selection.

Setting Up a Selection Tool

Access the Selection Tool page (**Set Up SACR > System Administration > Utilities > Population Selection > Selection Tool**).

This example illustrates the fields and controls on the Selection Tool page. You can find definitions for the fields and controls later on this page.

Selection Tool	
*Selection Tool	External File
Description	Student Administration File Parser
*Status	Active
Tool Configuration	
*Application Class	SCC_POP_SELECT:MODEL:Adapters:FileParserAdapter
*Selection View	SCCPS_FILE_VW File Parser / Pop Select ww
*Selection Label	File Mapping
Maximum Results Rows	10,000 (0 = Unlimited)
	<input checked="" type="checkbox"/> Enable Preview Results
Maximum Preview Rows	300 (0 = Unlimited)
	<input checked="" type="checkbox"/> File Input Support File Option Attachment
URL Identifier	SCCFP_FILE_PARSER File Parser URL for attachment
Max File Size (Kbytes)	1,000,000
Tool Launch Parameters	
Tool URL Edit Label	Edit File Mapping
Tool URL Add Label	Create File Mapping
Menu Name	SCCFP_MENU File Parser Menu
Menu Bar Name	USE USE
Item Name	SCCFP_PS_MAP Population Selection File Map
Page Name	SCCFP_PS_FILE Pop Selection File

Values on the Selection Tool page determine which selection tools will be available from the Population Selection subpage throughout PeopleSoft Campus Solutions and how they will appear and behave.

Field or Control	Description
Selection Tool	<p>Displays the type of tool (<i>Equation Engine</i>, <i>PS Query</i>, or <i>External File</i>) that you are configuring.</p> <p>You can rename a selection tool. If you do, consider using a name that reflects the tool. Internal sequencing preserves the tool type for system use. For example, if you rename <i>External File</i> to <i>Spreadsheet</i>, the internal sequencing remains. Therefore, the system displays the appropriate fields and links for an external file when the user selects <i>Spreadsheet</i>.</p> <hr/> <p>Warning! The Population Selection process has limitations when using the external file selection tool on the OS/390 and z/OS operating systems. Files created in a different character set than the character set for the operating system on which process scheduler runs might not be processed. For example, an ASCII delimited file created in the Microsoft Windows environment cannot be processed on an EBCDIC-based OS/390 or z/OS process scheduler. The file may be processed on a NT or Unix (non-EBCDIC) process scheduler.</p>
Status	<p>The default status for each tool is <i>Active</i>.</p> <p>If your institution does not want to use or make a tool available for use, change the status of the tool to <i>Inactive</i>.</p> <p>Only active tools are available for selection in the Context Definition component.</p>

Tool Configuration

Values in this area identify the prompt sources and file destinations for a tool and the maximum results to process at a time. They also control which labels and links to use in the **Population Selection** group box.

Field or Control	Description
Application Class and Selection View	<p>Display the name of the application class delivered for the specific tool type and the view to use as the prompt from that application class. Application classes and views are predefined for delivered selection tools, and you cannot change them.</p> <p>For the equation engine tool, the Application Class is <i>SCC_POP_SELECT:MODEL:Adapters:EqtEngAdapter</i> and the Selection View is <i>SCCPS_EQTN_VW</i>.</p> <p>For the query tool, the Application Class is <i>SCC_POP_SELECT:MODEL:Adapters:PSQueryAdapter</i> and the Selection View is <i>SCCPS_PSQRY_VW</i>.</p> <p>For the external file tool, the Application Class is <i>SCC_POP_SELECT:MODEL:Adapters:FileParserAdapter</i> and the Selection View is <i>SCCPS_FILE_VW</i>.</p>
Selection Label	<p>Displays the text to use as the field label in the Population Selection group box for the prompt containing values for that selection tool.</p> <p>For the equation engine tool, the default text is <i>Equation Name</i>.</p> <p>For the query tool, the default text is <i>Query Name</i>.</p> <p>For the external file tool, the default text is <i>File Mapping</i>.</p> <p>You can change the default text.</p>
Maximum Results Rows	<p>Displays the maximum number of results rows to return. To control processing time, if the selection process returns more than the recommended maximum number of IDs, the process will not process the extra IDs. You can change the maximum number.</p> <p>For the equation engine tool, the recommended maximum is <i>100,000</i>.</p> <p>For the query tool, the recommended maximum is <i>50,000</i>.</p> <p>For the external file tool, the recommended maximum is <i>10,000</i>.</p>

Field or Control	Description
<p>Enable Preview Results and Maximum Preview Rows</p>	<p>Control whether the Preview Selection Results link appears on the Population Selection subpage.</p> <p>As delivered, this check box is selected, which causes the link to appear. When clicked, the system displays a preview of the results retrieved by the tool. You can change the maximum number of rows that appear in the preview.</p> <p>If your institution does not want to use the results preview, clear the check box. When the check box is cleared, the Maximum Preview Rows field is hidden.</p>
<p>File Input Support and File Option</p>	<p>These fields apply to external file tool only.</p> <p>The File Input Support check box is delivered turned on only for the external file tool, causing the File Option field to appear.</p> <p>You must select whether your institution wants to provide external files to the system by <i>Attachment</i> or by <i>Physical Path</i>.</p> <p>The default value, which is <i>Attachment</i>, is recommended. You can specify in the URL Identifier field, where the system should place attachments for the tool so that PeopleSoft Applications Engine and Process Scheduler can access them.</p> <p>If you select <i>Physical Path</i>, users must enter the physical file path in the Population Selection group box located on the run control page. Both the Applications Engine and Process Scheduler must be able to access this path.</p>
<p>URL Identifier</p>	<p>If you select the <i>Attachment</i> file option, you must enter the PeopleTools URL that identifies where PeopleTools should place attachments for this tool so that the Applications Engine and Process Scheduler can access it. The URL can point to an FTP server or a physical table.</p> <p>The PeopleSoft system delivers an external file tool that points to a PeopleTools URL named SCCFP_FILE_PARSER. This URL is configured to write attachments to a table named SCCFP_FILE_ATT.</p> <p>See product documentation for <i>PeopleTools: PeopleCode Developer's Guide</i>, "Understanding File Attachments and PeopleCode."</p>

<i>Field or Control</i>	<i>Description</i>
Max File Size (Kbytes) (maximum file size [kilobytes])	Displays, in kilobytes, the maximum file size that you permit users to upload. Applies to the external file selection tool only.

Tool Launch Parameters

Values in this area control where users are to be redirected from links in the **Population Selection** group box.

<i>Field or Control</i>	<i>Description</i>
Tool URL Edit Label and Tool URL Add Label	Enter text to use as a link to redirect users to where they can edit an existing query, equation, or file mapping (Tool URL Edit Label) and add a new query, equation, or file mapping (Tool URL Add Label).
Menu Name, Menu Bar Name, Item Name, and Page Name	For each of the delivered selection tools (equation engine, query, and external file), these parameters are predefined and cannot be modified. The system displays their values for your information and reference only. If you were creating a new tool, these fields would be available for you to complete.

Defining and Mapping Contexts

To define and map contexts, use the Application Specific Context (SCCPS_VARY_MAP), Context Definition (SCCPS_CNTXT_DFN), and Equation to Context Mapping (SCCPS_EQTCTXT_MAP) components.

This section discusses how to:

- Define an application-specific context.
- Define a context.
- Map a context definition to the Population Selection process.
- Map an equation to a context.

Pages Used to Define and Map Contexts

<i>Page Name</i>	<i>Definition Name</i>	<i>Navigation</i>	<i>Usage</i>
Application Specific Context	SCCPS_VARY_MAP	Set Up SACR > System Administration > Utilities > Population Selection > Application Specific Context	Identify the application keys to use to map a context to a specific process.
Context Definition	SCCPS_CNTXT_DFN	Set Up SACR > System Administration > Utilities > Population Selection > Context Definition	For a specific process, define which menu navigation should allow the Population Selection process to be used. Select the Selection Tools to make available for the process and grant users security to them.
Selection Mapping	SCCPS_CNTXT_MAP	Set Up SACR > System Administration > Utilities > Population Selection > Context Definition > Selection Mapping	Map the fields required for a process with the process results fields (not all results fields are required).
Equation to Context Mapping	SCCPS_EQTCTXT_MAP	Set Up SACR > System Administration > Utilities > Population Selection > Equation to Context Mapping	Map an equation to a Population Selection context.

Defining an Application-Specific Context

Access the Application Specific Context page (**Set Up SACR > System Administration > Utilities > Population Selection > Application Specific Context**).

This example illustrates the fields and controls on the Application Specific Context page. You can find definitions for the fields and controls later on this page.

Application Specific Context

***Application Data**

Application Prompt Setup

***Field Label**

***Prompt Record**

An application-specific context is required when different field values require different fields and records to run a process. For example, the 3C Engine process requires different fields and records to extract the

proper variable data based on the administrative function selected. The ADMA administrative function requires a set of fields different from those required by the AVIN administrative function.

You can define the key field and prompt record to use for a specific application before mapping the application to the Population Selection process.

The PeopleSoft system delivers some predefined application-specific contexts. These contexts map key values to the appropriate prompt record for the business process. You can create new contexts. You can also modify delivered contexts if the **Additions Allowed** check box on the Selection Mapping page is selected.

<i>Field or Control</i>	<i>Description</i>
Application Data	Identify the specific application data name.

Application Prompt Setup

<i>Field or Control</i>	<i>Description</i>
Field Label	Enter the field to use as the key field for selecting IDs for that application.
Prompt Record	Enter the record to use to prompt for values for the key field.

Defining a Context

Access the Context Definition page (**Set Up SACR > System Administration > Utilities > Population Selection > Context Definition**).

This example illustrates the fields and controls on the Context Definition page. You can find definitions for the fields and controls later on this page.

The screenshot shows the 'Context Definition' page with the following fields and controls:

- *Context Name:** Evaluation Management System
- Process Type:** Application Engine
- Process Name:** SCC_GE_MAINT
- Description:** Create and Maintain Evaluations
- *Status:** Active

Below the fields are two tables:

Applicable Menu Navigation

*Menu Name	*Component Name
1 SCC_GENERIC_EVALUATIONS	SCC_GE_RC_MAINT

Applicable Selection Tools

Selection Tool	Description	Full Access	Exception
1 PS Query	PeopleSoft Query Manager	<input checked="" type="checkbox"/>	Exception
2 Equation Engine	Student Administration Equation Engine	<input checked="" type="checkbox"/>	Exception
3 External File	Student Administration File Parser	<input checked="" type="checkbox"/>	Exception

Use contexts to associate population selection with a specific process and to make the **Population Selection** group box available on the run control page for that process.

<i>Field or Control</i>	<i>Description</i>
Context Name	Enter a name for the context that you are defining.
Process Type	Enter the type of process to associate with this context.
Process Name	Enter the name of the process. Only the processes of the specified process type are available.

Applicable Menu Navigation

<i>Field or Control</i>	<i>Description</i>
<p>Menu Name and Component Name</p>	<p>Identify the menus and components where the run control page for the process is located.</p> <hr/> <p>Note: The PeopleSoft system delivers some processes, such as the Mass Assign Service Indicator process, set to use only the Population Selection feature to select the IDs to process. If the process you select is one of those, all the menu and component names where the process is used are listed. For other processes, such as the 3C Engine process, where the Population Selection feature is not required and you have more than one choice of methods for selecting the IDs to process, list only the menus and components where you want to make the Population Selection feature available as choice for users.</p> <hr/>

Applicable Selection Tools

<i>Field or Control</i>	<i>Description</i>
<p>Selection Tool</p>	<p>Enter the selection tools to allow for this process.</p> <p>The selection tools that you specify will be the only selection tools available in the Selection Tool prompt in the Population Selection group box for this process. The order in which you enter the tools in the context is the order in which they will appear in the drop-down list box. If you want to encourage the use of one tool over another, consider entering them in the order of preference.</p>

Field or Control	Description
Full Access and Exception	<p>The choices that you make here, control the selection tools in the Population Selection group box that are accessible to users.</p> <p>Select the Full Access check box to give all users access to the tool. For example, if you select the <i>PS Query</i> tool and the Full Access check box, all users are able to use the PS Query selection tool from the Population Selection group box for this process.</p> <p>If the number of users to whom you want to give full access to the tool is greater than the number of users to whom you do not want to grant full access, select the Full Access check box and then click the Exception link to specify those users who should not have full access.</p> <p>If the number of users to whom you want to give limited access to the tool is greater than the number of users to whom you want to give full access, clear the Full Access check box and then click the Exception link to specify those users who should have full access.</p> <hr/> <p>Note: If you do not want to provide anyone with access to this tool, delete the row.</p> <hr/>

Mapping a Context Definition to the Population Selection Process

Access the Selection Mapping page (**Set Up SACR > System Administration > Utilities > Population Selection > Selection Mapping**).

This example illustrates the fields and controls on the Selection Mapping page. You can find definitions for the fields and controls later on this page.

Context Definition
Selection Mapping

Context Name Evaluation Management System
Status Active

Pop Selection Integration

Context varies per Application Data **Application Data** Evaluation Management Category

Additions Allowed

Process Required Fields Find | View All First 1 of 6 Last

Evaluation Management ADMISSIONS +

Category SCC_GE_TRG_APPL Eval Management ADM PopSel

Results Record SCC_GE_BND_APPL Eval Management ADM Pop Select

Data Source Records Personalize | Find | View All | First 1 of 1 Last

#	*Record (Table) Name	Record Description
1	SCC_GE_BND_APPL	Eval Management ADM Pop Select

Validate Edit Prompt Values

Required Fields Mapping Personalize | Find | View All | First 1-7 of 7 Last

Mapping Information

#	Results Record Fields	*Mapping Action	Required Fields
1	ACAD_CAREER	Direct	ACAD_CAREER
2	ADM_APPL_NBR	Direct	ADM_APPL_NBR
3	APPL_PROG_NBR	Direct	APPL_PROG_NBR
4	EMPLID	Direct	EMPLID
5	INSTITUTION	Direct	INSTITUTION
6	PROCESS_INSTANCE	Process Instance	

A context must be mapped to control how the results records are populated. Delivered contexts are pre-mapped; therefore, case values on the Selection Mapping page are display only. If your institution creates a new context definition, the fields for mapping that context are available for entry.

Pop Selection Integration

<i>Field or Control</i>	<i>Description</i>
Context varies per Application Data	When selected, the Application Data field appears and values defined on the Application Specific Context page are available in the prompt list.

Field or Control	Description
Additions Allowed	<p>This check box controls behavior for CS-delivered context definitions. If you select this check box, an Add a new row button becomes available in the Process Required Fields section, so that users may add rows to the delivered context definition. Rows delivered by CS cannot be modified and remain greyed out.</p> <p>As the context definitions you create can be modified, the Additions Allowed check box setting may be ignored for those definitions.</p>
Application Data	Select the application data to use.

Process Required Fields

In this section, the system displays the values for which required fields and records vary for the context. For example, the 3C Engine uses Administrative Function application data. The Population Selection context for the 3C Engine process needs subcontexts for each of the administrative function values. Each value requires different fields and records based on the variable data fields. The system displays the results records and required fields record for the administrative function.

Field or Control	Description
Administrative Function, Membership Type, or Population Update	<p>If the Context varies per Application Data check box is selected, a field appears in this section based on the associated Application Data value. For example, when the Application Data field is set to <i>Administrative Function</i>, the Administration Function field appears. If the Application Data field is set to <i>Membership Type</i>, for PeopleSoft Contributor Relations, then the Membership Type field appears. If the Application Data field is set to <i>Population Update</i>, the Population Update field appears.</p>
Results Record	<p>Displays the results record that contains all of the fields that are required for the process to run.</p> <p>When integrating the Population Selection feature into a process, the system uses the results record to map values extracted by the Population Selection process to the required fields.</p>

Field or Control	Description
Required Fields Record	<p>Displays the name of the bind record that contains the fields that are required for the application process to select IDs.</p> <p>The Population Selection process must extract data for these required fields. Therefore, any Equation Engine equation, PS Query, or external file created to select the IDs for the process must include the record listed here.</p> <hr/> <p>Note: Each delivered application process into which the Population Selection process has been integrated, includes a corresponding sample PS_Query prefixed with QA_CS_xx where xx is the product code.</p> <hr/>

Data Source Records

The Population Selection process selects IDs based on the required fields in the bind record and places the values in the results record for the application process. The Population Selection process selects from the resulting IDs, which are the IDs that qualify based on the required and optional fields specified within the selection tool. These required and optional fields are the fields in the data source bind record that you specify.

When using PS Query, you must specify a data source record within the query for the query to be valid for the Population Selection process. When the user selects the selection tool of *PS Query* from the standard Population Selection group box, only the queries created with the associated data source record are available.

The data source record is the same as the required field record except where more than one data source record is required. or when the required fields record includes fields that are not relevant for selection by PS Query.

Two data sources are required when data must be pulled from two tables with the same data type but where the tables cannot be joined because they do not have the same rows. When you run a process set to select both people and organization IDs, you will likely need two data source records because the people data is in one table and the organization data is in another.

The required fields record might contain a comments field, however, a comments field is usually not relevant for selection by PS Query. In that case the corresponding data source record should not include the comments field and would therefore be different from the required fields record. If you use the external file selection tool, the comments field is selected as an optional field.

You can create an Equation Engine equation using the data source record, but it is not mandatory.

Field or Control	Description
Record (Table) Name	Enter the records that contain the fields for the Population Selection process to use to select only the desired IDs.

Field or Control	Description
Validate Edit Prompt Values	<p>Select this check box to validate prompt values in a query or equation against the same values on the process run control page. This selection will prevent the Population Selection process from selecting IDs with values that are different from values on the run control page.</p> <p>For example, if the run control page includes the Institution field, and the query or equation includes a prompt for the Institution field, the Population Selection process will select only those IDs whose values are the same.</p> <p>If the prompt value is blank, the system provides the value from the run control page.</p>

Required Fields Mapping

Field or Control	Description
Results Records Fields	<p>The system lists each field on the specified results record. It displays how each field from the Required Fields Record selected is set to be mapped .</p>

Mapping an Equation to a Context

Access the Equation To Context Mapping page (**Set Up SACR > System Administration > Utilities > Population Selection > Equation to Context Mapping**).

This example illustrates the fields and controls on the Equation To Context Mapping page. You can find definitions for the fields and controls later on this page.

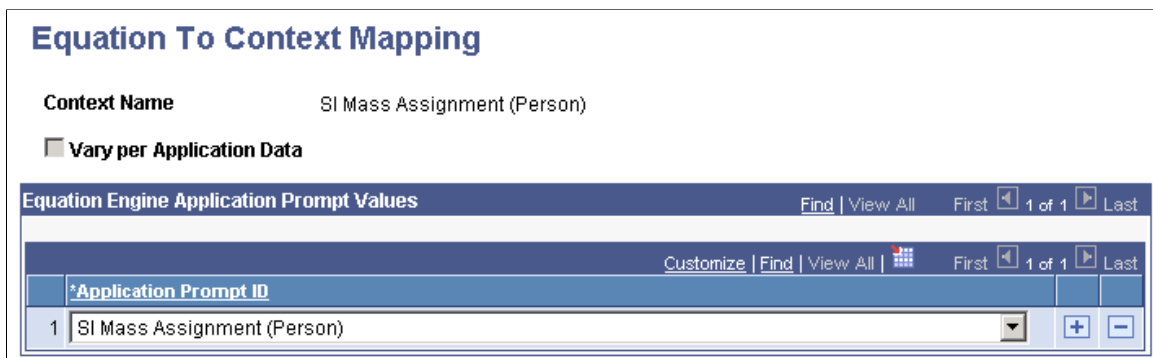

This page is applicable only when the selection tool is Equation Engine.

Equations are segmented by an attribute called an *Application Prompt*. Enter the application prompts that separate the equations for a context. Only the application prompts associated with the context are available.

When you select the selection tool of *Equation Engine* on a run control page, only the equations with the application prompt that you select here, are available. For example, if you enter the **Application Prompt ID** of *SI Mass Assignment (Person)*, then only the equations with that application prompt are available on the SI Mass Assignment run control page.

See “Preparing to Write Equations” (Campus Solutions Application Fundamentals).

Using the File Parser Process

Understanding the File Parser Process

The File Parser process enables you to convert data from an external file into PeopleSoft data and place it into tables in your Campus Solutions database. The external file can be a delimited file or a flat file. It can be a simple file with one row type or a complex file with several row types. If your institution routinely receives an external file from which you need to move data into your database, consider using the File Parser process to expedite the entry of that data. Whether the file is a small one that your institution receives daily or a large one that is received annually, the one-time setup of the File Parser process for that file can save significant data entry time.

Note: Suggested best practice: When creating File Parser definitions, it is recommended that the targeted tables be of an interim or staging classification, rather than have the File Parser process import data directly into application tables. Using interim or staging tables enable you to use existing data validation processes or create your own data validation processes. These validation processes can ensure that the data is clean before you load the data into one or more application specific tables.

To set up and use the File Parser process for an external file:

- Set up a field conversion definition that identifies a field values to convert from the external file to the target staging table.
- Set up context definitions that identify how to convert the data and in which staging tables to place the converted data to hold it for processing. Each context must also identify the parent-to-child relationship of the staging tables.
- Set up a file mapping definition that associates fields on the external file with the context definition to use.
- View the layout of each staging table, modify it, and map the fields from it to the target tables.
- Preview the hierarchical record layout and the converted data before you move the data into the staging tables.
- Run the File Parser process to convert the data and place it into the staging tables.

Setting Up Field Conversion Definitions

To set up field conversion definitions, use the Field Conversion (SCCFP_CNVR) and Copy Field Conversion Definition (SCCFP_CPY_FLD_CNVR) components.

This section discusses how to:

- Set up a field conversion definition.

- Copy a field conversion definition.

Pages Used to Set Up Field Conversion Definitions

Page Name	Definition Name	Navigation	Usage
Field Conversion Definition	SCCFP_CNVR	Set Up SACR > System Administration > Utilities > File Parser > Field Conversion Definition	Identify field values to convert from an external file.
Copy Field Value Conversion	SCCFP_CPY_FLD_CNVR	Set Up SACR > System Administration > Utilities > File Parser > Copy Field Value Conversion	Copy an existing field conversion definition, save it with a new definition name, and change it as necessary to create another definition.

Setting Up a Field Conversion Definition

Access the Field Conversion Definition page (**Set Up SACR > System Administration > Utilities > File Parser > Field Conversion Definition**).

This example illustrates the fields and controls on the Field Conversion Definition page. You can find definitions for the fields and controls later on this page.

Field Conversion Definition

Conversion Profile

Long Description

Conversion Fields Find | View All | First 7 of 39 Last

*Conversion Field + -

Record (Table) Name

*Unmatched Value Handling

Conversion Field Value Personalize | Find | View All | First 1-4 of 20 Last

	File Value	Internal Value	
1	<input type="text" value="004"/>	<input type="text" value="AFG"/> <input type="button" value="🔍"/>	<input type="button" value="+"/> <input type="button" value="-"/>
2	<input type="text" value="008"/>	<input type="text" value="ALB"/> <input type="button" value="🔍"/>	<input type="button" value="+"/> <input type="button" value="-"/>
3	<input type="text" value="010"/>	<input type="text" value="ATA"/> <input type="button" value="🔍"/>	<input type="button" value="+"/> <input type="button" value="-"/>
4	<input type="text" value="012"/>	<input type="text" value="DZA"/> <input type="button" value="🔍"/>	<input type="button" value="+"/> <input type="button" value="-"/>

Field conversion definitions are optional. They are relevant only if the external file contains field values that are different from the PeopleSoft system values. Use the Field Conversion definition to define the mapping of external file values to the internal PeopleSoft system values. For example, if the external file uses the value *FALSE* but the internal value is *F*, you should create a mapping to convert the value when the file is loaded.

Field or Control	Description
Conversion Profile	<p>Enter a name for the conversion of this external file. Consider naming the profile the same name as the external file or a name that otherwise reflects the type of data to load.</p> <p>(Optional) Enter a long description to further identify this conversion profile.</p>

Conversion Fields

Field or Control	Description
Conversion Field	<p>Enter a name for converting each field.</p> <p>Add as many conversion fields as necessary to identify each field to convert from the external file.</p>
Record (Table) Name	<p>Enter a record from which to prompt for target field names.</p> <hr/> <p>Note: This field can only be used for setup tables where the Internal Value is the only key.</p> <hr/>
Unmatched Value Handling	<p>Indicate what the File Parser process should do if it cannot map the field value of the conversion field to the field in the target staging table field value. The choices are:</p> <p><i>Default Value:</i> Use the default value that you specify.</p> <p><i>Error - Halt Processing:</i> Cease loading data into the staging table and display the message that you specify.</p>
Default Value	<p>When you enter <i>Default Value</i> in the Unmatched Value Handling field, the Default Value field appears. You must specify the default value to use.</p> <p>If you do not enter a default value, a blank or null value becomes the default value. If the value of the field cannot be mapped, the process will leave the value blank and continue mapping.</p>
Message Set Number and Message Number	<p>When you enter <i>Error - Halt Processing</i> in the Unmatched Value Handling field, the Message Set Number and Message Number fields appear. You must identify the error message to use.</p>

Conversion Field Value

<i>Field or Control</i>	<i>Description</i>
File Value	Enter each possible value for this field from the external file.
Internal Value	Enter the correlating PeopleSoft value. Select the prompt only if you have entered a value in the Record (Table) Name field. Otherwise, manually enter the internal PeopleSoft value.

Copying a Field Value Conversion Definition

Access the Copy Field Value Conversion page ((**Set Up SACR > System Administration > Utilities > File Parser > Copy Field Value Conversion**)).

After you copy a field conversion definition and save it with a different name, you can modify it as necessary to create another definition.

On the search page, select the field conversion definition to copy, and then enter the name of the new conversion definition and save the page. To edit the new definition, access it from the Field Conversion Definition page.

Setting Up Context Definitions

This section discusses how to:

- Set up a context definition.
- View the record tree.
- Copy a context definition.

Pages Used to Set Up Context Definitions

<i>Page Name</i>	<i>Definition Name</i>	<i>Navigation</i>	<i>Usage</i>
Context Definition	SCCFP_CNTXT_DFN	Set Up SACR > System Administration > Utilities > File Parser > Context Definition	Identify the field names and formats to use for converted data and the staging tables in which to place the converted data and hold for processing.
Record Tree	SCCFP_TREE_RECPRVW	Set Up SACR > System Administration > Utilities > File Parser > Context Definition > Record Tree	View the record tree to determine the hierarchical layout of the staging tables.

Page Name	Definition Name	Navigation	Usage
Copy Context Definition	SCCFP_CPY_CNTXT	Set Up SACR > System Administration > Utilities > File Parser > Copy Context Definition	Copy an existing context definition with a new definition name.

Setting Up a Context Definition

Access the Context Definition page (**Set Up SACR > System Administration > Utilities > File Parser > Context Definition**).

This example illustrates the fields and controls on the Context Definition page (1 of 2). You can find definitions for the fields and controls later on this page.

The screenshot displays the 'Context Definition' page. At the top, there are tabs for 'Context Definition' and 'Record Tree'. Below the tabs, there are input fields for '*Context Name' (Context Example) and 'Conversion Definition' (Conversion Example). The 'Staging Table Records' section shows a table with columns for '*Record' (SCC_STG_CONSTIT), 'Parent Record', and 'Sort Order' (10). A 'Synchronize Record Fields' button is visible. The 'Staging Table Fields' section contains a table with columns for 'Field Name', 'Field Type', '*Mapping Action', 'Visible for Mapping', and 'Value'. The table lists 9 fields with their respective types and mapping actions.

Field Name	Field Type	*Mapping Action	Visible for Mapping	Value
1 SCC_TEMP_ID	Number	Unique Counter	<input type="checkbox"/>	
2 SUBMITTED	Char	No Default	<input checked="" type="checkbox"/>	
3 USERID	Char	No Default	<input checked="" type="checkbox"/>	
4 EMPLID	Char	No Default	<input checked="" type="checkbox"/>	
5 SCC_TRANSAC_CD	Char	No Default	<input checked="" type="checkbox"/>	
6 BIRTHDATE	Date	No Default	<input checked="" type="checkbox"/>	
7 BIRTHPLACE	Char	No Default	<input checked="" type="checkbox"/>	
8 BIRTHSTATE	Char	No Default	<input checked="" type="checkbox"/>	
9 BIRTHCOUNTRY	Char	No Default	<input checked="" type="checkbox"/>	

This example illustrates the fields and controls on the Context Definition page (2 of 2). You can find definitions for the fields and controls later on this page.

10	DT_OF_DEATH	Date	No Default	<input checked="" type="checkbox"/>	
11	SCC_STG_STATUS	Char	Default Value	<input checked="" type="checkbox"/>	LD
12	SCC_STG_STS_DT	Date	Default Value	<input checked="" type="checkbox"/>	%Date
13	CREATED_DTTM	DTTM	No Default	<input checked="" type="checkbox"/>	
14	LASTUPDDTTM	DTTM	No Default	<input checked="" type="checkbox"/>	
15	SCC_SUBMITTED_DTTM	DTTM	No Default	<input checked="" type="checkbox"/>	
16	SCC_ROW_ADD_OPRID	Char	Default Value	<input type="checkbox"/>	%OperatorID
17	SCC_ROW_ADD_DTTM	DTTM	Default Value	<input type="checkbox"/>	%DateTime
18	SCC_ROW_UPD_OPRID	Char	Default Value	<input type="checkbox"/>	%OperatorID
19	SCC_ROW_UPD_DTTM	DTTM	Default Value	<input type="checkbox"/>	%DateTime

Field or Control	Description
Context Name	Enter a name for this set of staging tables.
Conversion Profile	<p>Enter the field conversion profile to associate with this context.</p> <p>You can enter the profile here or on the File Mapping Definition page when you map the files. If you enter a profile here, it appears as the default profile on the File Definition page. You can change it on the File Mapping Definition page. The conversion profile entered on the File Mapping Definition page takes precedence.</p>

Staging Table Records

Field or Control	Description
Record	<p>Enter the staging table to use. When you enter a table name, the system displays the fields from that table.</p> <p>Add as many staging tables as needed for this conversion context.</p>
Sort Order	Enter the order in which the table should appear in the hierarchy of staging files for mapping.
Parent Record	Enter the name of this staging table's parent record, if any.

<i>Field or Control</i>	<i>Description</i>
Synchronize Record Fields	<p>Click to compare fields in the staging table to fields in the target table.</p> <p>If the fields in the tables are different, the system adds and deletes fields in the staging table until it contains only the fields that are in the target table. The changes are for the staging table as associated with this context definition only. The system displays a message indicating the changes made to the record.</p> <hr/> <p>Important! You must perform a thorough impact analysis when applying any software updates in order to identify delivered record definitions that are being referenced by current File Parser definitions.</p> <hr/> <p>Note: If changes are made to the record, it is required that you click this button in order to successfully run the File Parser process.</p> <hr/>

Staging Table Fields - Mapping Tab

<i>Field or Control</i>	<i>Description</i>
Field Name	<p>The system lists each field in the specified staging table.</p> <p>When you synchronize the tables, the system updates the list to include only the synchronized fields.</p>

Field or Control	Description
Mapping Action	<p>Enter the value to use for this field. Values are:</p> <p><i>Default Value:</i> Enter a hard-coded value set for this field, including any variables that are supported. Supported variables include <i>%Date</i>, <i>%DateTime</i>, <i>%OperatorID</i>, <i>%EmployeeID</i>, <i>%MapID</i> (the current file parser map ID), <i>%MapName</i> (the current file parser map name), <i>%FileName</i>, and a number representing the file row number.</p> <p><i>Inherit from Parent:</i> Enter the value from the field of the same name on the parent record.</p> <p><i>No Default:</i> Enter no value. The field must be mapped from the File Mapping Definition component.</p> <p><i>Process Instance:</i> Use the current process instance.</p> <p><i>Sequence:</i> Enter a numerical sequence that is incremented by one for each record inserted.</p> <p><i>Unique Counter:</i> Use the next number from the supplied counter record or field pair.</p> <p><i>Calculated:</i> Define a user-written PeopleCode application class to calculate the field value. Examples of calculated mapping include concatenation of fields, unique sequencing, and deriving the field value from other staged values (for instance, establishing an External Org ID based on an incoming CEEB code, subject description, activity description, and so on). For more examples, see Creating Calculated Mapping Application Class Objects.</p> <p>When you select <i>Calculated</i>, the Calculated Field Application Class tab appears. Specify the application class details on this tab.</p> <hr/> <p>Important! Do not base calculated field values on other calculated fields.</p> <hr/>
Visible for Mapping	<p>Select this check box for the field to be available on pages in the File Mapping Definition component.</p> <p>If a field is premapped and the user should not change the mapping, clear the check box to prevent it from appearing on pages in the File Mapping Definition component page.</p>
Value	<p>The corresponding hard-coded value appears when the Mapping Action field is set to <i>Default Value</i>.</p>

Staging Table Fields - Format Tab

The Format tab is available only if *Date* or *Number* is selected for one or more field types.

Access the Context Definition page - Format tab.

This example illustrates the fields and controls on the Context Definition page - Format tab (1 of 2). You can find definitions for the fields and controls later on this page.

Context Definition | Record Tree

*Context Name: Conversion Definition:

Staging Table Records: Find | View All | First 1 of 36 | Last

*Record: Constituent Sort Order: + -

Parent Record: Synchronize Record Fields

Staging Table Fields: Personalize | Find | View 10 | First 1-19 of 19 | Last

Mapping	Field Name	Field Type	Field Format	Date Separator
1	SCC_TEMP_ID	Number		
2	SUBMITTED	Char		
3	USERID	Char		
4	EMPLID	Char		
5	SCC_TRANSAC_CD	Char		
6	BIRTHDATE	Date		
7	BIRTHPLACE	Char		
8	BIRTHSTATE	Char		
9	BIRTHCOUNTRY	Char		
10	DT_OF_DEATH	Date		

This example illustrates the fields and controls on the Context Definition page - Format tab (2 of 2). You can find definitions for the fields and controls later on this page.

11	SCC_STG_STATUS	Char	<input type="text" value="Upper"/>	
12	SCC_STG_STS_DT	Date	<input type="text" value="MMDDYYYY"/>	<input type="text"/>
13	CREATED_DTTM	DTTM		
14	LASTUPDDTTM	DTTM		
15	SCC_SUBMITTED_DTTM	DTTM		
16	SCC_ROW_ADD_OPRID	Char	<input type="text" value="Upper"/>	
17	SCC_ROW_ADD_DTTM	DTTM	<input type="text"/>	
18	SCC_ROW_UPD_OPRID	Char	<input type="text" value="Upper"/>	
19	SCC_ROW_UPD_DTTM	DTTM	<input type="text"/>	

Field or Control	Description
Field Format	This field appears if formatting options exist. Enter the format to use for the field value. Each field has options relevant to that data type. For example, a date type format can be DDMMYY, DDMMYYYY,DDMMYY, and so on. A character type format uses the case controls <i>Lower</i> , <i>Proper</i> , and <i>Upper</i> .
Date Separator	<p>This field appears only for date fields.</p> <p>Enter the separator, if any, to use to separate day month and year in whatever date format you enter. For example, if you enter a format of <i>MMDDYYYY</i> and a separator of /, the value might be 06/25/2007.</p> <p>The system ignores leading zeros when a separator is used. If a separator is not used, leading zeros are required.</p>

Staging Table Fields - Counter Definition Tab

The Counter Definition tab is available only if a Mapping Action of *Unique Counter* is selected for one or more field types.

Access the Context Definition page - Counter Definition tab.

This example illustrates the fields and controls on the Context Definition page - Counter Definition tab (1 of 2). You can find definitions for the fields and controls later on this page.

The screenshot displays the 'Counter Definition' tab within a software interface. At the top, there are tabs for 'Context Definition' and 'Record Tree'. Below these, the 'Context Name' is set to 'Context Example' and the 'Conversion Definition' is 'Conversion Example'. A 'Staging Table Records' section shows a record named 'SCC_STG_CONSTIT' of type 'Constituent' with a 'Sort Order' of 10. A yellow 'Synchronize Record Fields' button is present. The main area is titled 'Staging Table Fields' and includes a sub-tab 'Counter Definition'. This sub-tab contains a table with the following data:

	Field Name	Field Type	Counter Record Name	Counter Field
1	SCC_TEMP_ID	Number	SCC_STG_CTRS	SCC_TEMP_ID
2	SUBMITTED	Char		
3	USERID	Char		
4	EMPLID	Char		
5	SCC_TRANSAC_CD	Char		
6	BIRTHDATE	Date		
7	BIRTHPLACE	Char		
8	BIRTHSTATE	Char		
9	BIRTHCOUNTRY	Char		
10	DT_OF_DEATH	Date		

This example illustrates the fields and controls on the Context Definition page - Counter Definition tab (2 of 2). You can find definitions for the fields and controls later on this page.

11	SCC_STG_STATUS	Char		
12	SCC_STG_STS_DT	Date		
13	CREATED_DTTM	DTTM		
14	LASTUPDDTTM	DTTM		
15	SCC_SUBMITTED_DTTM	DTTM		
16	SCC_ROW_ADD_OPRID	Char		
17	SCC_ROW_ADD_DTTM	DTTM		
18	SCC_ROW_UPD_OPRID	Char		
19	SCC_ROW_UPD_DTTM	DTTM		

Field or Control	Description
Counter Record Name and Counter Field	Enter the record (table) and field from which to take the next sequential number.

Staging Table Fields - Calculated Field Application Class Tab

The Calculated Field Application Class tab is available only if *Calculated* is selected as the Mapping Action for one or more fields.

Access the Calculated Field Application Class tab.

This example illustrates the fields and controls on the Context Definition page - Calculated Field Application Class tab. You can find definitions for the fields and controls later on this page.

The screenshot shows the 'Context Definition' page with the 'Record Tree' tab selected. The 'Context Name' is 'Context Example' and the 'Conversion Definition' is 'Conversion Example'. Below this, the 'Staging Table Records' section shows a record for 'SCC_STG_NAMES' (Person Names) with a parent record 'SCC_STG_CONSTIT' (Constituent). A 'Synchronize Record Fields' button is visible. The 'Staging Table Fields' section is active, showing a table with the following data:

Field Name	Field Type	Root Package ID	Qualified Package/Class Path	Application Class ID
1 SCC_TEMP_ID	Number			
2 NAME_TYPE	Char			
3 COUNTRY_NM_FORMAT	Char			
4 NAME	Char	QA_CS_AD_COMMON_APP	UTIL.FieldCalculations	BuildPriNameDelim
5 NAME_INITIALS	Char			
6 NAME_PREFIX	Char			
7 NAME_SUFFIX	Char			
8 NAME_ROYAL_PREFIX	Char			
9 NAME_ROYAL_SUFFIX	Char			
10 NAME_TITLE	Char			

Supply the name of your Application Package in the **Root Package ID** column. Prompt values will then become available for the **Qualified Package/Class Path** and **Application Class ID** columns. Select the class path and path ID that reflect the calculation that you want to associate with the Record/Field Context Definition.

The PeopleCode application class for a calculated field should not be dependent on any other calculated field.

Viewing the Record Tree

Access the Record Tree page (**Set Up SACR > System Administration > Utilities > File Parser > Context Definition > Record Tree**).

This example illustrates the fields and controls on the Record Tree page (1 of 2). You can find definitions for the fields and controls later on this page.

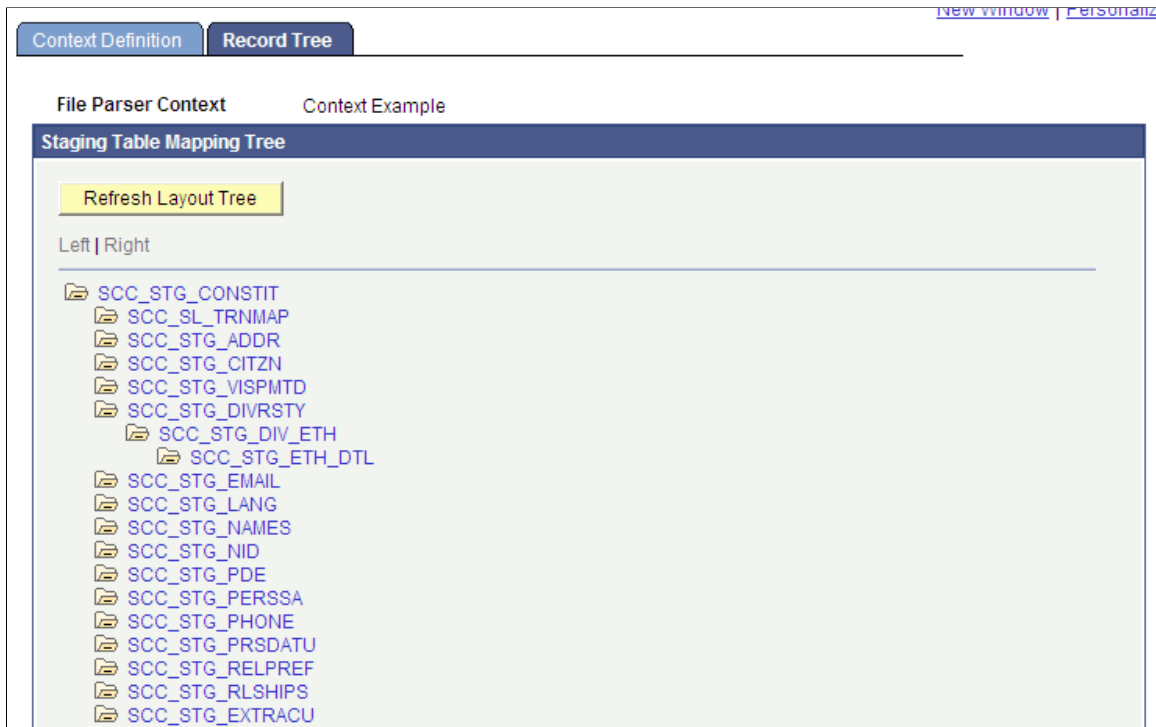

This example illustrates the fields and controls on the Record Tree page (2 of 2). You can find definitions for the fields and controls later on this page.

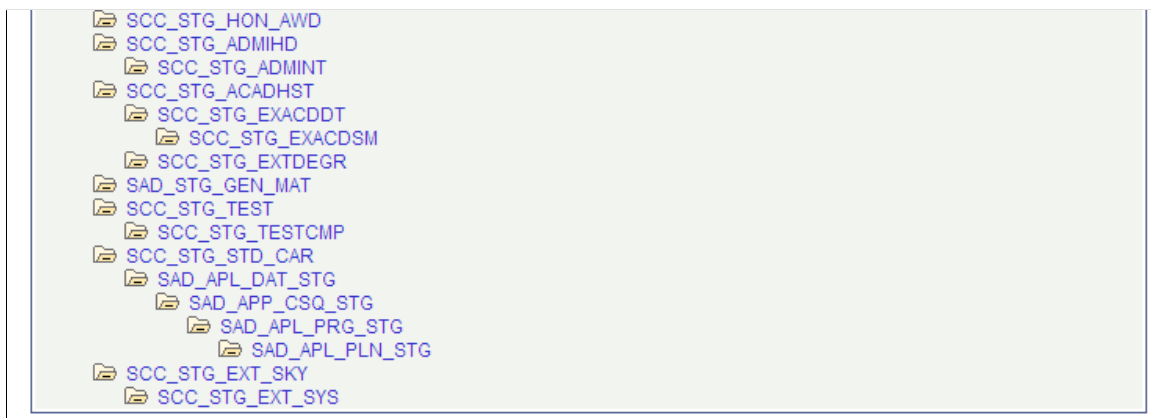

Staging Table Mapping Tree

Click the **Refresh Layout Tree** link to view the hierarchy of staging tables for this conversion. Review the tree to verify that the records are in the correct parent-child order.

Refresh the layout tree after you add staging tables or change the sort order.

Copying a Context Definition

Access the Copy Context Definition page (**Set Up SACR > System Administration > Utilities > File Parser > Copy Context Definition**).

You can copy an existing context definition and save it with a different name. You can then change the new context definition as necessary.

On the search page, select the context definition to copy. Then, enter the name of the new context definition and save the page. To edit the new definition, access it from the Context Definition page.

Setting Up File Mapping Definitions

This section discusses how to:

- Create a file definition.
- Define a file layout.
- Map the file and convert the data.
- Preview the record tree.
- Preview the converted data.

Pages Used to Set Up File Mapping Definitions

<i>Page Name</i>	<i>Definition Name</i>	<i>Navigation</i>	<i>Usage</i>
File Definition	SCCFP_FILE_DFN	Set Up SACR > System Administration > Utilities > File Parser > File Mapping Definition	Map the external file to the context containing the destination records.
File Layout	SCCFP_FILE_LAYOUT	Set Up SACR > System Administration > Utilities > File Parser > File Mapping Definition > File Layout	Identify the fields from the external file, and specify the action to use to convert data and place it on the destination staging table records.

Page Name	Definition Name	Navigation	Usage
Mapping	SCCFP_FILE_MAP	Set Up SACR > System Administration > Utilities > File Parser > File Mapping Definition > Mapping	Map the fields in the external file to fields in the destination record.
Preview Layout	SCCFP_FILE_PRVW	Set Up SACR > System Administration > Utilities > File Parser > File Mapping Definition > Preview Layout	View the record tree to determine if the correct data is set to be mapped and converted.
Preview Data	SCCFP_FILE_PRVW2	Set Up SACR > System Administration > Utilities > File Parser > File Mapping Definition > Preview Data	Identify the external file and view the data as it will be converted before running the File Parser process to place the converted data into the destination records.
Copy File Map Definition	SCCFP_CPY_MAP_DFN	Set Up SACR > System Administration > Utilities > File Parser > Copy File Map Definition	Copy an existing file map definition under a new definition name.

Creating a File Definition

Access the File Definition page (**Set Up SACR > System Administration > Utilities > File Parser > File Mapping Definition**).

This example illustrates the fields and controls on the File Definition page. You can find definitions for the fields and controls later on this page.

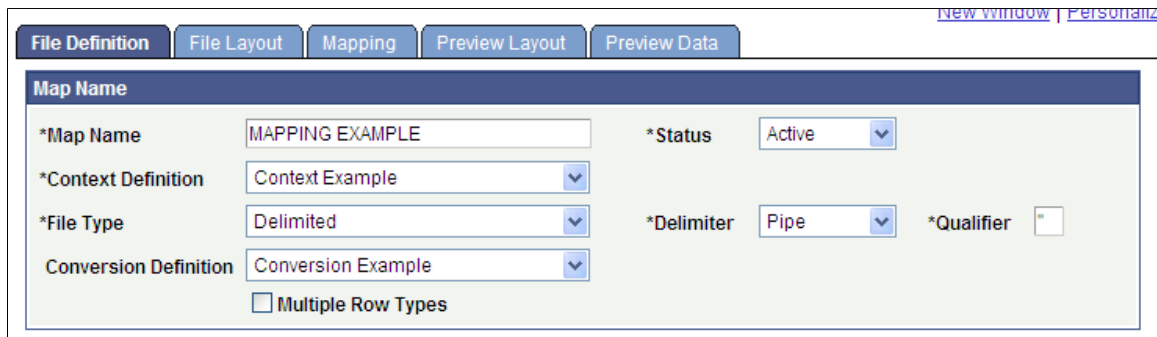

The screenshot shows the 'File Definition' page with the following fields and controls:

- Map Name** (Section Header)
- *Map Name: MAPPING EXAMPLE
- *Status: Active (dropdown)
- *Context Definition: Context Example (dropdown)
- *File Type: Delimited (dropdown)
- *Delimiter: Pipe (dropdown)
- *Qualifier: " (text input)
- Conversion Definition: Conversion Example (dropdown)
- Multiple Row Types

This is an example of a File Definition page with multiple row types:

This example illustrates the fields and controls on the File Definition page – Multiple Row Types. You can find definitions for the fields and controls later on this page.

The screenshot shows a software interface for defining file mappings. It has several tabs: File Definition (selected), File Layout, Mapping, Preview Layout, and Preview Data. The main area is titled 'Map Name' and contains the following fields:

- *Map Name: EXTERNAL AWARDS - STATE2
- *Status: Active
- *Context Definition: External Award Load
- *File Type: Delimited
- *Delimiter: Pipe
- *Qualifier: (empty)
- Conversion Definition: (empty)
- Multiple Row Types

Below these fields is a 'Row Types' table with the following data:

	Name	Section ID Value	Field Number		
1	Header	EVR_HEADER	1	+	-
2	Detail	EVR_DETAIL	1	+	-

Map Name

<i>Field or Control</i>	<i>Description</i>
Map Name	Enter a name for this mapping of the external file.
Status	<p>Enter the status of file mapping definition.</p> <p>The default value is <i>Pending</i> when the mapping definition is initially added. Only file mapping definitions with an <i>Active</i> status are available for selection when converting external file data.</p>
Context Definition	<p>Enter the context definition to use for this mapping. Context definitions are set up on the Context Definition page.</p> <p>If a conversion definition is associated with the context on the Context Definition page, the system displays the name of it in the Conversion Definition field.</p> <hr/> <p>Important! For a saved file mapping definition, if you change this field's value, the system will automatically delete the setup in both the File Layout and Mapping pages. This is because the system assumes that the target records (context) are different. Do not change this field's value unless you want to repeat your setup.</p>

Field or Control	Description
File Type	Specify the type of the external file, either <i>Flat</i> or <i>Delimited</i> . If you enter <i>Delimited</i> , you must also verify or enter values for the delimiter and the qualifier.
Delimiter	Appears only if the file type is <i>Delimited</i> . Enter the item in the external file that signifies the end of one value and the beginning of another. Values are: <i>Comma</i> <i>Pipe</i> <i>Semicolon</i> <i>Tab</i>
Qualifier	Appears only if the file type is <i>Delimited</i> . Enter the character in the external file that qualifies the end of one field and the beginning of another. The default qualifier is " (quotation mark). <hr/> Note: If the external file does not contain any field qualifier, leave the default value unchanged. This will not have any impact on processing the file. <hr/>
Conversion Definition	Enter the conversion definition to use. Conversion definitions are set up on the Field Conversion Definition page. If a conversion definition is associated with this context on the Context Definition page, the system displays it as the default value. You can change the conversion definition.
Multiple Row Types	Select if the external file contains multiple row types. For example, the external file might have a header row, a detail row, and a trailer or total row. When Multiple Row Types is selected, the File Row Type Detail group box appears, which is where you must identify each row type to which data is to be converted. <hr/> Note: The Force Insert functionality is not available when multiple row types are specified. <hr/>

Row Types

This group box is available only when the **Multiple Row Types** check box is selected.

Field or Control	Description
Name	Enter a name to describe the general purpose or type of the row.
Section ID Value	Enter the type of value that appears in the row.
Starting Position and Field Length	<p>These two fields appear when the file type is <i>Flat</i>.</p> <p>Enter the position in which the field value for the row begins in the Starting Position field, and enter the maximum character length of the field to read in the Field Length field.</p>
Field Number	<p>This field appears when the file type is <i>Delimited</i>.</p> <p>Indicate the field that contains the field value for the row.</p>

The Field Number (for delimited files), and Starting Position and Field Length (for flat files) indicate the field or column that the File Parser process should look at to determine the row type. For example, shown in the preceding exhibit, if Field Number *1* in the file has a value *EVR_HEADER* then the row type = *Header*.

Define a File Layout

Access the File Layout page (**Set Up SACR > System Administration > Utilities > File Parser > File Mapping Definition > File Layout**).

This example illustrates the fields and controls on the File Layout page - Location tab. You can find definitions for the fields and controls later on this page.

[New window](#) | [Personaliz](#)

File Definition | **File Layout** | Mapping | Preview Layout | Preview Data

Map Name: MAPPING EXAMPLE

Row Types: Find First 1 of 1 Last

Row Type: MAPPING EXAMPLE Staging Table: [Dropdown] Load Fields

File Fields: Personalize | Find | View 100 | [Icons] First 111-120 of 209 Last

Location	Format	*Sort Order	*File Field Name	Field Number	Field Type		
111		1080	ACT Best Score Math	106	Number	+	-
112		1090	ACT Best Score Math Date	107	Date	+	-
113		1100	ACT Best Score Read	108	Number	+	-
114		1110	ACT Best Score Read Date	109	Date	+	-
115		1120	ACT Best Score Science	110	Number	+	-
116		1130	ACT Best Score Science Da	111	Date	+	-
117		1140	ACT Best Score Writing	112	Number	+	-
118		1150	ACT Best Score Writing Date	113	Date	+	-
119		1160	SAT Best Score CritReas	114	Number	+	-
120		1170	SAT Best Score CritReas Da	115	Date	+	-

This example illustrates the fields and controls on the File Layout page - Format tab. You can find definitions for the fields and controls later on this page.

[New window](#) | [Personaliz](#)

File Definition | **File Layout** | Mapping | Preview Layout | Preview Data

Map Name: MAPPING EXAMPLE

Row Types: Find First 1 of 1 Last

Row Type: MAPPING EXAMPLE Staging Table: [Dropdown] Load Fields

File Fields: Personalize | Find | View 100 | [Icons] First 111-120 of 209 Last

Location	Format	*Sort Order	*File Field Name	Field Format	Trim	Date Separator	Date Day	Date Month	Decimal Position		
111		1080	ACT Best Score Math		<input type="checkbox"/>					+	-
112		1090	ACT Best Score Math Date	YYMM	<input type="checkbox"/>	/	06			+	-
113		1100	ACT Best Score Read		<input type="checkbox"/>					+	-
114		1110	ACT Best Score Read Date	MMYYYY	<input type="checkbox"/>	/	08			+	-
115		1120	ACT Best Score Science		<input type="checkbox"/>					+	-
116		1130	ACT Best Score Science Da	YYMMM	<input type="checkbox"/>	-	10			+	-
117		1140	ACT Best Score Writing		<input type="checkbox"/>					+	-
118		1150	ACT Best Score Writing Date	MMYY	<input type="checkbox"/>	/	12			+	-
119		1160	SAT Best Score CritReas		<input type="checkbox"/>					+	-
120		1170	SAT Best Score CritReas Da	YY	<input type="checkbox"/>		14	09		+	-

This example illustrates the fields and controls on the File Layout page - Propagate tab. You can find definitions for the fields and controls later on this page.

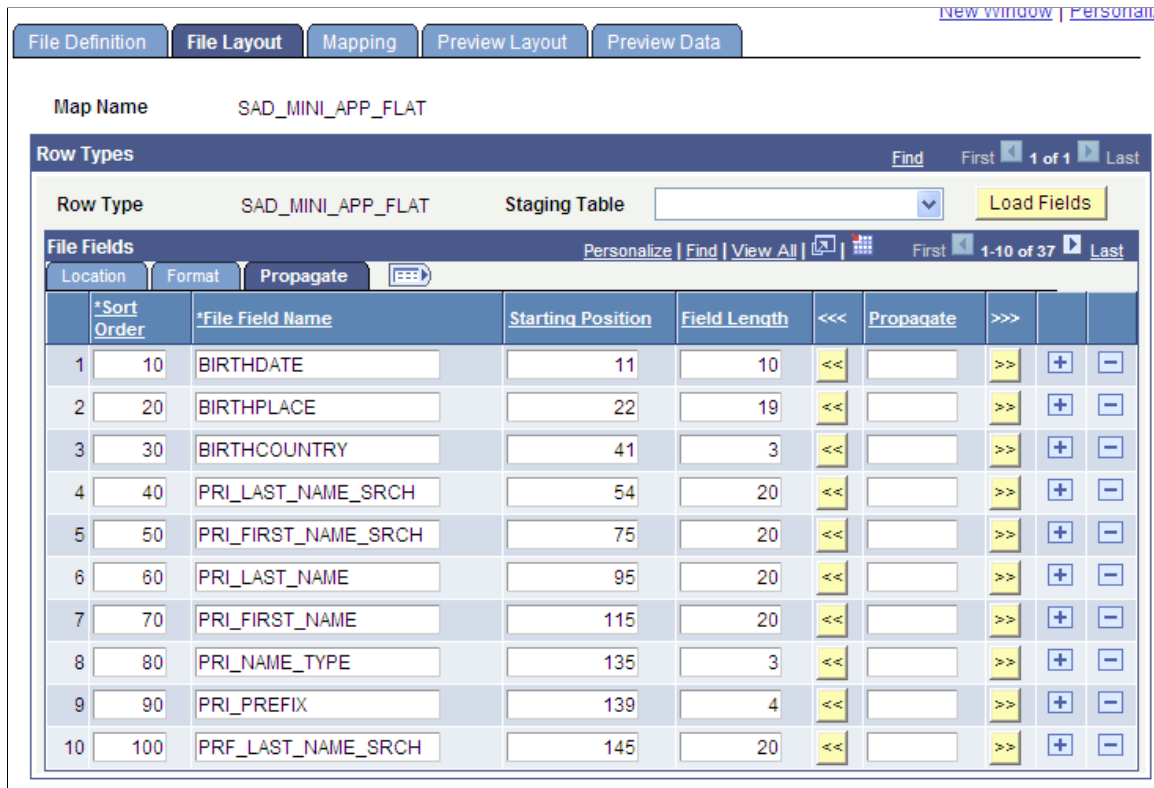

You control the layout of the file by identifying the fields on the external file to be converted. You can either enter file field names from the external file or you can load and populate the fields from the staging table, view the field controls, and make changes as needed.

Row Types

The page contains a row for each row type identified on the File Definition page. Enter data for each row type.

<i>Field or Control</i>	<i>Description</i>
Staging Table and Load Fields	<p>(Optional) Enter the name of the staging table into which data for this row type is to be placed. Only the staging tables associated with this context are available.</p> <p>Click Load Fields to load a list of the fields from the staging table into the File Fields group box.</p> <p>Loading the fields can save data entry.</p>

File Fields

The **File Fields** group box lists the field names to reference in the external file. Use these file names to map to fields on the staging tables on the Mapping page.

File Fields - Location Tab

The Location tab lists the location of the field on the external field. You can view and change the sort order, the field name, and the field type.

For a flat file, the location is the starting position and field length.

For a delimited file, the location is the field number.

Field or Control	Description
Field Type	<p>Enter the type of field to use.</p> <p>The values are:</p> <p><i>Character</i></p> <p><i>Date</i></p> <p><i>Date Time</i></p> <p><i>Number</i></p> <p><i>Signed Decimal</i></p> <p><i>Time</i></p> <hr/> <p>Note: The field type that you select here must be applicable to the corresponding field displayed on the Field Mapping Detail section of the Mapping page. For example, if setting up a field for ACT Math Score, the Field Type should be set as <i>Number</i> to correspond with the Field Type of the SCORE field on SCC_STG_TESTCMP. Fields defined with the Field Type of <i>Time</i> must be in the format of hh:mm:ss AM/PM, such as <i>12:15:42 PM</i>.</p> <hr/>

File Fields - Format Tab

The Format tab enables you to view and change field formats, trim leading and trailing spaces, enter date separators for date fields, and change decimal placement for currency amounts.



This example illustrates the fields and controls on the File Layout page - Format tab. You can find definitions for the fields and controls later on this page.

Location	Format	*File Field Name	Field Format	Trim	Date Separator	Date Day	Date Month	Decimal Position		
91	890	Parent 2 Country of Birth		<input type="checkbox"/>						+ -
92	900	Parent 2 Employer		<input type="checkbox"/>						+ -
93	910	Parent 2 Degree		<input type="checkbox"/>						+ -
94	920	Parent 2 Grad Degree		<input type="checkbox"/>						+ -
95	930	Parent 2 Country of Origin		<input type="checkbox"/>						+ -
96	940	Sec School Name		<input type="checkbox"/>						+ -
97	950	Sec Date of Entry	YYYYMM	<input type="checkbox"/>	/	15				+ -
98	960	Sec Date Graduation	YYYY	<input type="checkbox"/>		06	01			+ -
99	970	Sec CEEB Code		<input type="checkbox"/>						+ -
100	980	Sec School Address1		<input type="checkbox"/>						+ -

Field or Control	Description
Date Day	This field appears when you define a Field Type of <i>Date</i> and select a date field format that contains only month and year (for example, <i>MMYYYY</i> or <i>YYMMM</i>). Select a value (1-28) of your choice to be assigned to the incoming date value and the subsequent mapped record/field.
Date Month	This field and the Date Day field appear when a date format contains only year (for example, <i>YYYY</i> or <i>YY</i>). For the month value, select a value (1-12) of your choice, and then select a value (1-28) to be assigned to the incoming date value and the subsequent mapped record/field.

File Fields - Propagate Tab

This tab appears for flat files only. The Propagate tab enables you to adjust the starting position and length of a field when a new field is added to an existing definition.

Field or Control	Description
	Click to decrease the starting position of the field.
	Click to increase the starting position of the field.

Mapping the File and Converting the Data

Note: Note that if you are using a PDF version of this document and the graphics appear unclear, we recommend that you adjust the zoom or magnification tool of Adobe Reader.

Access the Mapping page (**Set Up SACR > System Administration > Utilities > File Parser > File Mapping Definition > Mapping**).

This example illustrates the fields and controls on the Mapping page - Mapping tab. You can find definitions for the fields and controls later on this page.

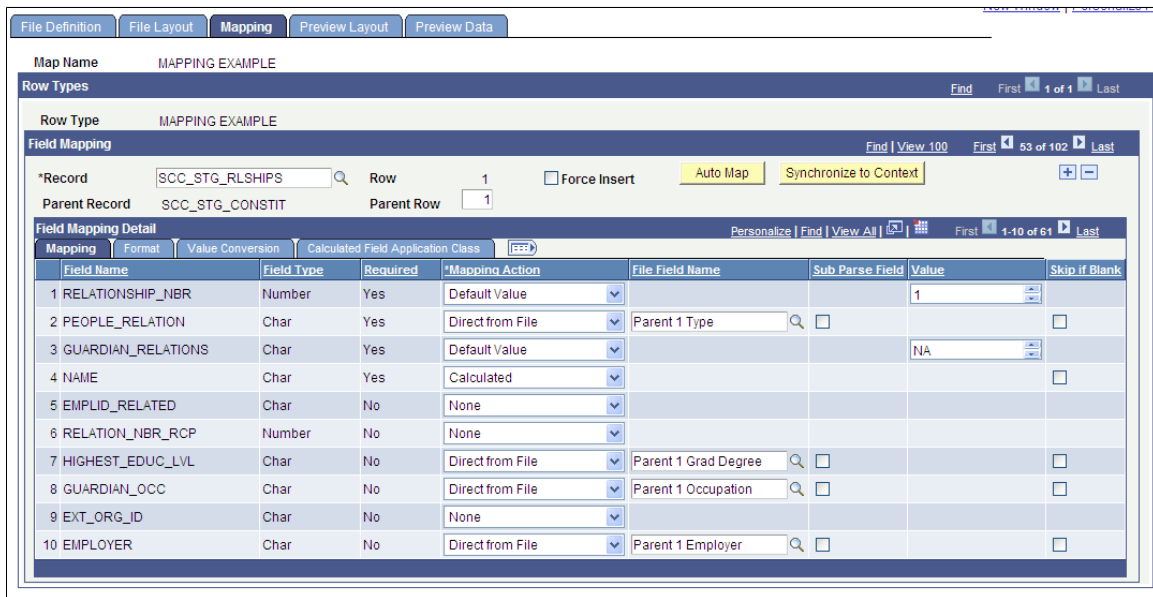

The screenshot shows the 'Mapping' tab of the File Parser interface. It displays a table of field mappings for a record with ID 'SCC_STG_RLSHIPS'. The table includes columns for Field Name, Field Type, Required status, Mapping Action, File Field Name, Sub Parse Field, Value, and Skip if Blank. The mapping actions include 'Default Value', 'Direct from File', and 'Calculated'.

Field Name	Field Type	Required	Mapping Action	File Field Name	Sub Parse Field	Value	Skip if Blank
1 RELATIONSHIP_NBR	Number	Yes	Default Value			1	<input type="checkbox"/>
2 PEOPLE_RELATION	Char	Yes	Direct from File	Parent 1 Type	<input type="checkbox"/>		<input type="checkbox"/>
3 GUARDIAN_RELATIONS	Char	Yes	Default Value			NA	<input type="checkbox"/>
4 NAME	Char	Yes	Calculated				<input type="checkbox"/>
5 EMPLID_RELATED	Char	No	None				<input type="checkbox"/>
6 RELATION_NBR_RCP	Number	No	None				<input type="checkbox"/>
7 HIGHEST_EDUC_LVL	Char	No	Direct from File	Parent 1 Grad Degree	<input type="checkbox"/>		<input type="checkbox"/>
8 GUARDIAN_OCC	Char	No	Direct from File	Parent 1 Occupation	<input type="checkbox"/>		<input type="checkbox"/>
9 EXT_ORG_ID	Char	No	None				<input type="checkbox"/>
10 EMPLOYER	Char	No	Direct from File	Parent 1 Employer	<input type="checkbox"/>		<input type="checkbox"/>

This example illustrates the fields and controls on the Mapping page - Mapping tab with the Sub Parse Field check box selected. You can find definitions for the fields and controls later on this page.

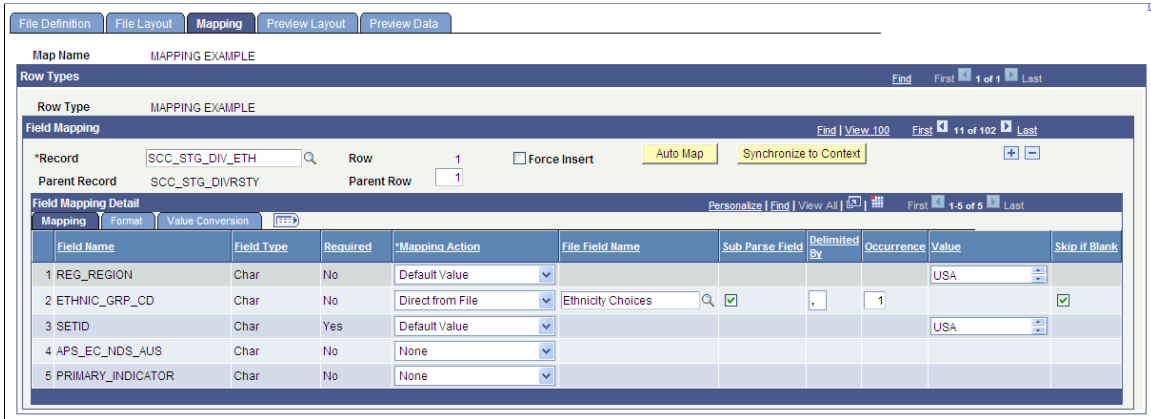

This example illustrates the fields and controls on the Mapping page - Format tab. You can find definitions for the fields and controls later on this page.



This example illustrates the fields and controls on the Mapping page - Value Conversion tab. You can find definitions for the fields and controls later on this page.

The screenshot shows the 'Mapping' page with the 'Value Conversion' tab selected. The 'Field Mapping Detail' table is as follows:

Field Name	Field Type	Conversion Field
1 RELATIONSHIP_NBR	Number	
2 PEOPLE_RELATION	Char	Parent Type
3 GUARDIAN_RELATIONS	Char	
4 NAME	Char	
5 EMPLID_RELATED	Char	
6 RELATION_NBR_RCP	Number	
7 HIGHEST_EDUC_LVL	Char	Parent Grad Degree
8 GUARDIAN_OCC	Char	Parent Occupation
9 EXT_ORG_ID	Char	
10 EMPLOYER	Char	

Enter data to define how to update the staging record when the external file is processed. Fields on the staging table may take data directly mapped from the external file or set with a default value when external file is processed.

Note: Click **Save** on the File Layout page before using the Mapping page. Saving the file mapping definition and layout causes the file field names to be available on the Mapping page.

Row Types

Each row type identified on the File Definition page and designed on the File Layout page is listed in this group box. View or enter mapping instructions for each field to map the field to the staging tables.

Field Mapping

Data in this group box defines how to update the staging tables and fields when the external file is processed.

Field or Control	Description
Record	<p>Enter the record to use as the staging table. Available records are from the related context definition.</p> <p>When the process runs, it updates the specified staging table with the fields defined in the row type and File Layout page.</p> <p>Once a staging table is selected in the Record field, based on the context definition, all visible fields from the staging table are displayed.</p> <hr/> <p>Note: If a staging table with mapped file fields has a parent record, you must include the parent record in the field mapping even if the parent has no mapped file fields. If the parent record does not contain any reference to a mapped value (that is, you have selected <i>Direct from File</i> Mapping Action for the parent record), you must select the Force Insert check box.</p>
Row	<p>Identifies the row of the staging table into which the File Parser process will insert the converted data.</p> <hr/> <p>Note: In most cases, the row number is <i>1</i>. However, sometimes one row in the file may need to be normalized into more than one row in the staging tables. For example, PeopleSoft Financial Aid's external awards have award files that contain more than one disbursement on a single file row. The External Award staging tables store disbursements in a normalized manner to support a large number of disbursements for each award. To map a single file row to more than one staging table record, you must add rows on the field mapping level. Each of these rows must be mapped to the correct file field. The disbursement table is keyed to a unique sequence and the keys must be correctly mapped. In most cases, set the Mapping Action to <i>Default Value</i>, and enter in the Value field a numeric sequence that equates to the number of disbursements.</p>

Field or Control	Description
Force Insert	<p>Select to have the File Parser process insert a record if you have not selected the <i>Direct From File</i> mapping action for any field in the record.</p> <p>Force Insert functionality allows the end user to write to a staging table while not relying on the existence of mapped value(s) from a specific file.</p> <p>When Force Insert is enabled, File Parser inserts a row into the specified staging table. File Parser presumes that the end user recognizes that the target table is a child to a parent table structure and that there is sufficient data either inherited from the parent and/or defined at the mapped level to insure data integrity.</p> <hr/> <p>Note: The Force Insert check box is not available when multiple row types are specified. A calculated field must be used to force insert a record in this case.</p>
Auto Map	<p>(Optional) Click for the system to compare fields on the File Layout page to fields in the staging table and place fields with the same name into the staging tables.</p>
Synchronize to Context	<p>(Optional) Click for the system to compare fields on the Context Definition page to fields on the Mapping page and to remove fields from the mapping that are not in the context definition. Synchronizing content is helpful when the context definition has been updated after the file mapping definition is created.</p> <hr/> <p>Note: If changes have been made to a record definition you are using, it is required that you synchronize content to successfully run the File Parser process.</p>

Field Mapping Detail - Mapping Tab

The **Mapping** tab appears for each record and displays all of the visible fields from the staging table and their mapping actions.

Field or Control	Description
Mapping Action	<p>Enter the mapping action for the process to use when updating the target staging table.</p> <p>Values are:</p> <p><i>Default Value</i> to enable you to hard code the value when the file is processed. The Value column appears where you can enter the default value to post to staging table. For example, the External Award staging table (SFA_EASTAGE_DTL) requires that a value posts to the external award report SFA_EA_REPORT_CD field. In most cases the external file will not have a corresponding field for this value. Select <i>Default Value</i> and provide appropriate value in the Value column.</p> <p><i>Direct from File</i> to update the staging table with a field defined on the File Layout page. The File Field Name column appears, and the available values are fields defined in File Layout page. You can click the Auto Map button to cause the system to populate the File Field Name fields with the available values if the File Field Name is the same as the Field Name.</p> <p><i>Inherit from Parent</i> to carry forward the value from the parent record.</p> <p><i>None</i> to take no action nor update the staging table field.</p> <p><i>Process Instance</i> to bring in the current process instance of the batch process.</p> <p><i>Sequence</i> to assign a unique sequence number, used primarily to create unique key values. Sequencing starts at 1 and increments by 1 for each row retrieved.</p> <p><i>Unique Counter</i> to assign a unique numeric index created from the next number on the referenced counter record and field. The Population Selection process uses the PeopleTools <i>GetNextNumberWithGapsCommit()</i> function to get the next value and update the record.</p> <p><i>Calculated</i> to use a PeopleCode application class that calculates the field value.</p> <p>When you select <i>Calculated</i>, the Calculated Field Application Class tab appears. Specify the application class details on this tab.</p>
File Field Name	<p>Available when Mapping Action is <i>Direct from File</i>.</p> <p>Available values are fields defined in File Layout page.</p>

Field or Control	Description
Sub Parse Field	<p>Available when Mapping Action is <i>Direct from File</i>. This attribute is used when an incoming field may contain multiple responses or answers to a specific question. For example: Question: <i>What is your ethnic background</i>. Answer: <i>I am White and Native American Indian</i>. Each of these responses would constitute a separate row in the ethnicity tables.</p> <p>When you select the Sub Parse Field check box, the Delimited By and Occurrence fields are available for entry:</p> <p>Delimited By: Specify the character that is used to separate the values within the incoming mapped field.</p> <p>Occurrence: Specify a numeric value corresponding to the occurrence within the field that you wish to assign to the specific staging table.</p> <p>Repeat this construct for as many responses that could potentially be contained within the incoming mapped field.</p>
Value	<p>Available when Mapping Action is <i>Default Value</i>.</p> <p>Enter the value in the correct format for field.</p>
Skip if Blank	<p>Select if you do not want the File Parser process to insert a blank row if the field value is blank.</p> <p>If you clear this check box, the File Parser process inserts a blank row if the field value has a blank value. For example, if you do not select this check box and a student does not provide a preferred name, the File Parser process will insert a blank name in the staging table with a name type set to <i>Preferred</i>.</p> <hr/> <p>Note: The Skip if Blank check box is available only for the following Mapping Actions: <i>Direct from File</i>, <i>Inherit from Parent</i>, and <i>Calculated</i>.</p> <hr/>

Field Mapping Detail - Format Tab

The **Format** tab appears when the mapping action is *Default Value*.

View and enter data to format the mapped fields.

Field Mapping Detail - Value Conversion Tab

The **Value Conversion** tab appears when the mapping action is *Direct from File*. You can optionally assign a conversion value to fields that are mapped directly from the external file.

Field Mapping Detail - Calculated Field Application Class Tab

When you select a Mapping Action of *Calculated* on the Mapping tab, the Calculated Field Application Class tab becomes available.

This example illustrates the fields and controls on the Mapping page - Mapping tab with a calculated Mapping Action selected. You can find definitions for the fields and controls later on this page.

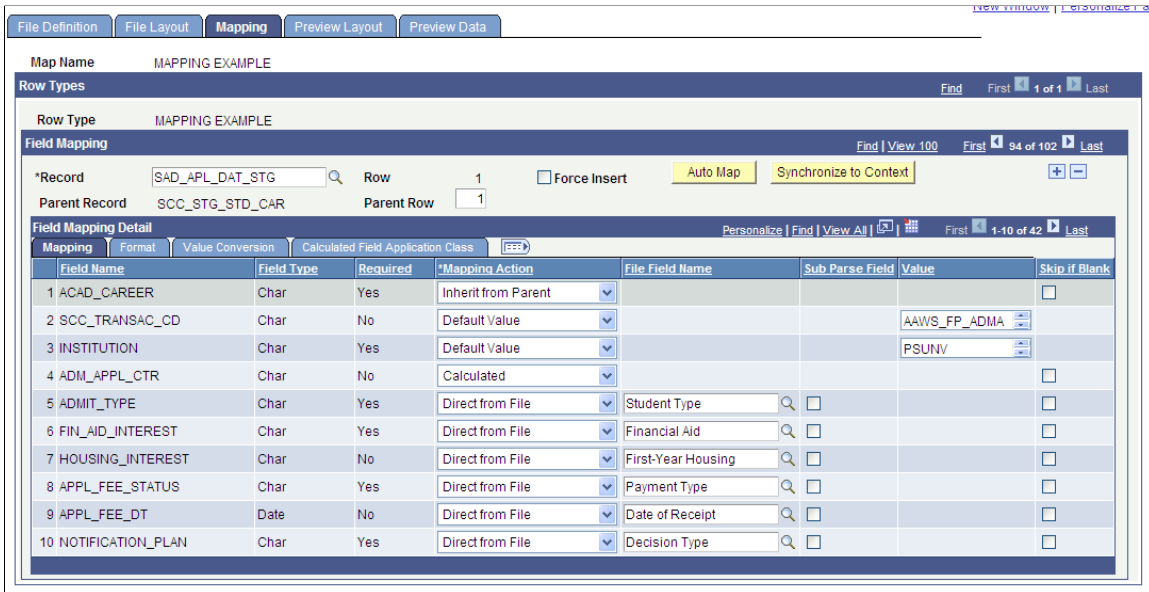

On the Calculated Field Application Class tab, you then need to provide the name of the **Application Package** that you previously defined in Application Designer under the **Root Package ID** column:

This example illustrates the fields and controls on the Mapping page - Calculated Field Application Class tab. You can find definitions for the fields and controls later on this page.

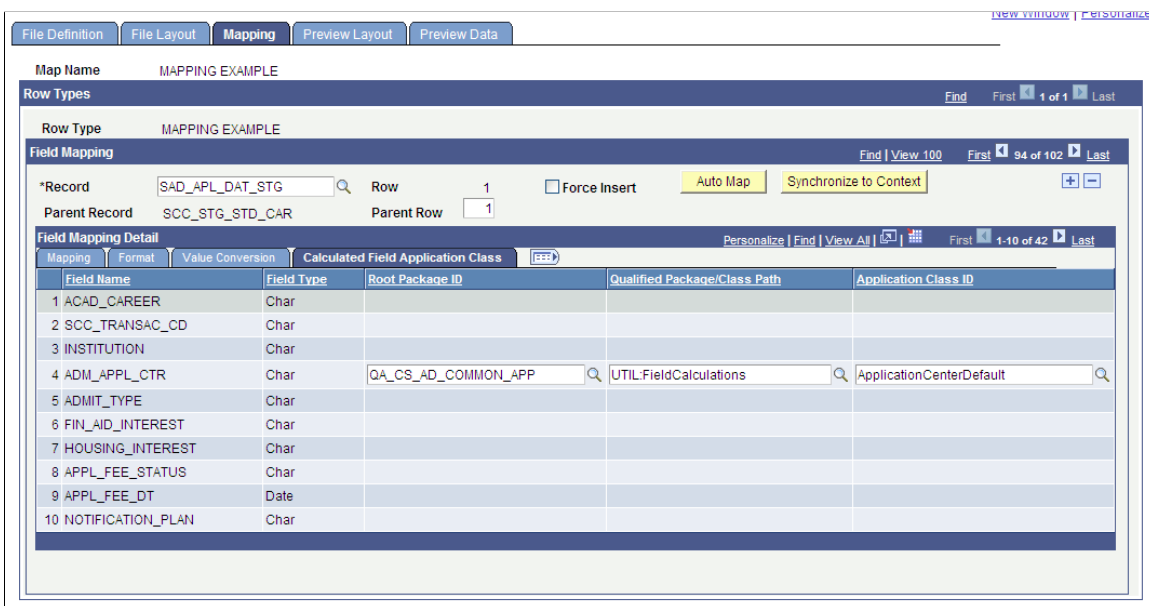

Once you select the application package that pertains to this specific calculation field, you must provide the **Qualified Package/Class Path** and the **Application Class ID**.

For ACT 2020 test results, use the application package ACT_2020.

- Root Package ID: SAD_PDL_PROCESS
- Qualified Package/Class Path: File_Parser_Calculated_Fields:ACT_2020

The following graphic illustrates how the specified field values on the Calculated Field Application Class tab relate to the user defined application package:

This example illustrates the fields and controls on the Calculated Field Application Class tab values relating to an application package. You can find definitions for the fields and controls later on this page.

The screenshot displays the 'Mapping' tab in the File Parser interface. The 'Field Mapping Detail' table is shown with the following data:

Field Name	Field Type	Root Package ID	Qualified Package/Class Path	Application Class ID
1 ACAD_CAREER	Char			
2 SCC_TRANSAC_CD	Char			
3 INSTITUTION	Char			
4 ADM_APPL_CTR	Char	QA_CS_AD_COMMON_APP	UTIL.FieldCalculations	ApplicationCenterDefault
5 ADMIT_TYPE	Char			
6 FIN_AID_INTEREST	Char			
7 HOUSING_INTEREST	Char			
8 APPL_FEE_STATUS	Char			
9 APPL_FEE_DT	Date			
10 NOTIFICATION_PLAN	Char			

Below the table, a record tree shows the hierarchy: QA_CS_AD_COMMON_APP (expanded) > UTIL (expanded) > FieldCalculations (expanded) > ApplicationCenterDefault (expanded). Blue arrows indicate the relationship between the table entries and the tree structure.

Previewing the Record Tree

Access the Preview Layout page (**Set Up SACR > System Administration > Utilities > File Parser > File Mapping Definition > Preview Layout**).

This example illustrates the fields and controls on the Preview Layout page. You can find definitions for the fields and controls later on this page.

File Definition | File Layout | Mapping | **Preview Layout** | Preview Data

Map Name MAPPING EXAMPLE

Refresh Layout Tree

Left | Right

- SCC_STG_CONSTIT - (1) - MAPPING EXAMPLE
 - [SUBMITTED - (Default Value)]
 - [USERID - (None)]
 - [EMPLID - (None)]
 - [SCC_TRANSAC_CD - (Default Value)]
 - [BIRTHDATE - (8)]
 - [BIRTHPLACE - (34)]
 - [BIRTHSTATE - (35)]
 - [BIRTHCOUNTRY - (36)]
 - [DT_OF_DEATH - (None)]
 - [SCC_STG_STATUS - (Default Value)]
 - [SCC_STG_STS_DT - (Default Value)]
 - [CREATED_DTTM - (Default Value)]
 - [LASTUPDDTTM - (Default Value)]
 - [SCC_SUBMITTED_DTTM - (None)]
- SCC_SL_TRNMAP - (1) - MAPPING EXAMPLE
 - [SCC_TRANSAC_CD - (Inherit from Parent)]
- SCC_STG_ADDR - (1) - MAPPING EXAMPLE
 - [ADDRESS_TYPE - (Default Value)]
 - [SCC_ADDRESSAREA - (None)]
 - [ADDR_TYPE_DESCR - (None)]
 - [COUNTRY - (21)]
 - [ADDRESS1 - (16)]
 - [ADDRESS2 - (17)]
 - [ADDRESS3 - (None)]
 - [ADDRESS4 - (None)]
 - [CITY - (18)]
 - [NUM1 - (None)]
 - [NUM2 - (None)]
 - [HOUSE_TYPE - (None)]
 - [ADDR_FIELD1 - (None)]
 - [ADDR_FIELD2 - (None)]
 - [ADDR_FIELD3 - (None)]
 - [COUNTY - (None)]

After you design the layout and map the file fields to the staging tables, click the **Refresh Layout Tree** button to view the hierarchy of the staging tables and fields; and determine how each field will be updated when external file is processed. You should preview the layout before you run the process to move the data into the target tables.

If the Preview Layout page displays a field with one or more numbers in parenthesis, this means the field is mapped with a Mapping Action of *Direct From File*. For Delimited File Types, the displayed number corresponds to the Field Number on the File Layout page. For example, BIRTHDATE - (8) means that this field is mapped to Field Number 8 on the File Layout page, which is Date of Birth. For

Flat File Types, the first number corresponds to the starting position of the field and the second number corresponds to the field length. For example, BIRTHDATE – (11,10) means that this field begins in position 11 and has a length of 10.

Previewing the Converted Data

Access the Preview Data page (**Set Up SACR > System Administration > Utilities > File Parser > File Mapping Definition > Preview Data**).

This example illustrates the fields and controls on the Preview Data page . You can find definitions for the fields and controls later on this page.

The screenshot shows the 'Preview Data' page for a file mapping definition. The page includes a navigation bar with tabs for 'File Definition', 'File Layout', 'Mapping', 'Preview Layout', and 'Preview Data'. Below the tabs, there is a form with the following fields and controls:

- Map Name:** MAPPING EXAMPLE
- Attached File:** Jan_2012_Blank_Fields.csv
- Buttons:** Preview Data, Add Attachment, Delete Attachment, View Attachment

The main content area displays a table of field values for a record of type SCC_STG_CONSTIT. The table has columns for Field Name and Value. The values are:

Field Name	Value
1 SUBMITTED	N
2 USERID	
3 EEMPLID	
4 SCC_TRANSAC_CD	AAWS_FP_ADMAPPLS
5 BIRTHDATE	1996-02-11
6 BIRTHPLACE	Calgary
7 BIRTHSTATE	AB
8 BIRTHCOUNTRY	CAN
9 DT_OF_DEATH	
10 SCC_STG_STATUS	LD

After mapping is complete, you can preview the data with a test file to confirm the file field layout, mapping to staging tables, and field formats and conversions. Perform this preview before you run the process to move the data to target tables. The preview feature shows only the first row of each row type.

Note: Use a small test file. Previewing with a large file would waste system resources, be too large to upload as an attachment, and potentially degrade the application server.

Field or Control	Description
Add Attachment	Click and browse to attach a sample file. The file to be attached should be small but have at least one row for each file type.
Preview Data	Click to display data in the attached file according to the specifications.

<i>Field or Control</i>	<i>Description</i>
View Attachment	Click to view the sample file with data.
Delete Attachment	Click to delete the sample file.

Running the File Parser Process

This section discusses how to run the File Parser process.

Page Used to Run the File Parser Process

<i>Page Name</i>	<i>Definition Name</i>	<i>Navigation</i>	<i>Usage</i>
Run File Parser	SCCFP_RUNCNTL	Set Up SACR > System Administration > Utilities > File Parser > Run File Parser	Enter the path to the external file to be converted, and run the process to convert the data and place it into the staging tables.

Running the File Parser Process

Access the Run File Parser page (**Set Up SACR > System Administration > Utilities > File Parser > Run File Parser**).

Enter parameters, and then run the File Parser process to convert the data and place it into the staging tables.

<i>Field or Control</i>	<i>Description</i>
File Path	Enter the path to the external file to be converted. The path must be accessible to Process Scheduler.

File List Indicator

Select this check box to indicate that the file specified in the File Path field points to a list of files to be converted.

To load multiple files, you must create a document (for example .txt) that lists all of the files that you want to load. In this document, for each file, enter the entire file path on which the file resides.

This graphic shows an example text document for the File List Indicator option:

This example illustrates the fields and controls on the Example text document for the File List Indicator option. You can find definitions for the fields and controls later on this page.

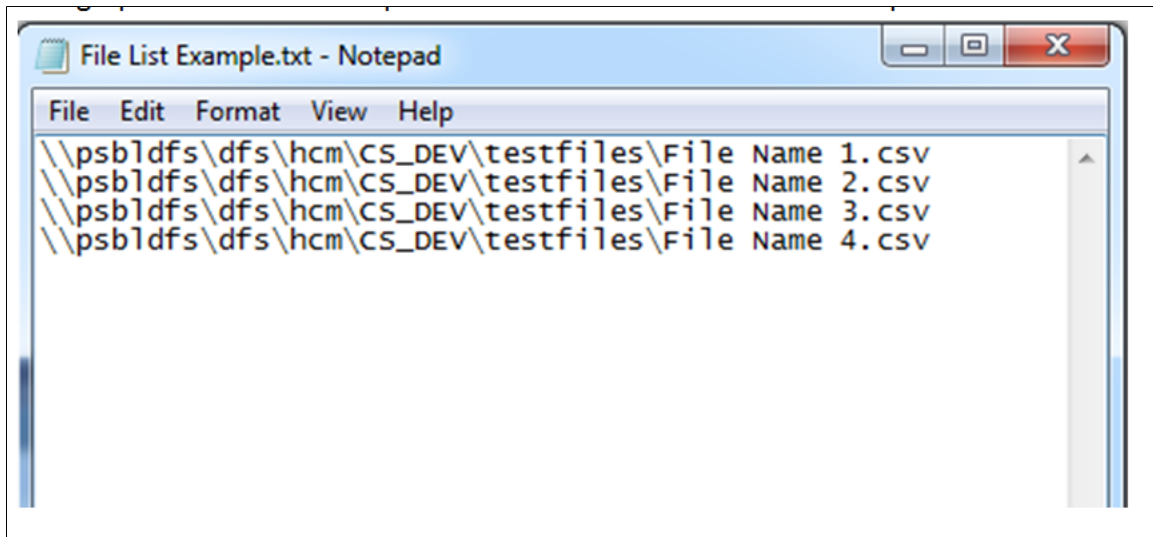

Enter the path and name of this document in the File Path field.

This is an example of the run control page with the File List Indicator selected:

This example illustrates the fields and controls on the Example of the Run File Parser page with the File List Indicator selected. You can find definitions for the fields and controls later on this page.

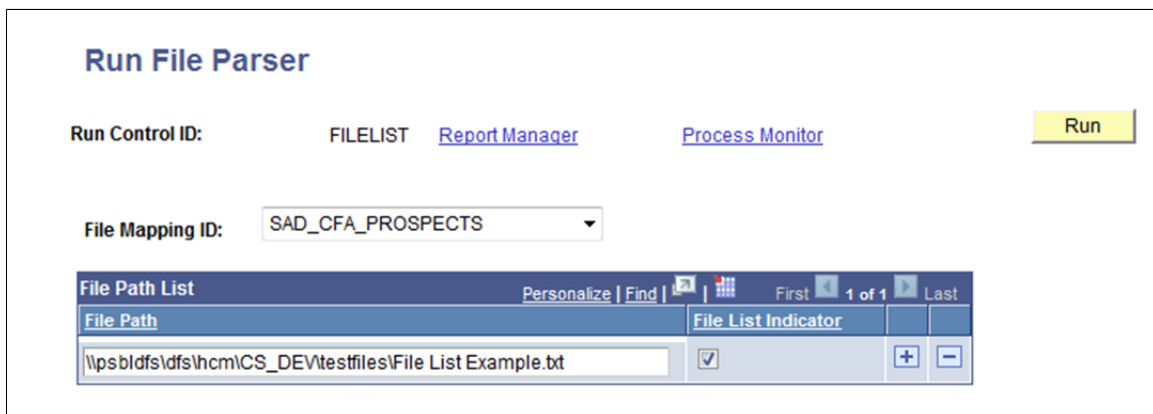

Mapping the File Parser Process for Population Selection

The Population Selection process uses the File Parser process when the selection tool for identifying the population is external file. When using an external file to select IDs for a process, you must map the fields required by the process to the target table fields for the application process that is integrated with Population Selection.

This section discusses how to map the File Parser process for Population Selection.

Related Links

[Using the Population Selection Process](#)

Page Used to Map File Parser for Population Selection

<i>Page Name</i>	<i>Definition Name</i>	<i>Navigation</i>	<i>Usage</i>
Population Selection File Map	SCCFP_PS_FILE	<p>Set Up SACR > System Administration > Utilities > File Parser > Population Selection File Map</p> <p>Click the Create File Mapping or Edit File Mapping link in the Population Selection group box on any run control page when the Population Selection tool is an external file.</p>	Map the File Parser process for integration with the Population Selection process.

Mapping the File Parser Process for Population Selection

Access the Population Selection File Map page (**Set Up SACR > System Administration > Utilities > File Parser > Population Selection File Map**).

This example illustrates the fields and controls on the Population Selection File Map - Mapping tab. You can find definitions for the fields and controls later on this page.

Population Selection File Map

File Mapping Definition

*File Mapping: Public [Created/Updated History](#)

*Required Flds:

*File Type: Field Delimiter: Field Qualifier:

Attachment:

Header Row Header Row Number:

Field Mapping

Personalize | Find | | | First 1-5 of 5 Last

Mapping	Field Name	Required	File Column Header	Field Number
1	EMPLID	Yes	<input type="text" value="ID"/>	<input type="text" value="1"/>
2	INSTITUTION	Yes	<input type="text" value="Institution"/>	<input type="text" value="2"/>
3	AID_YEAR	Yes	<input type="text" value="Aid Yr"/>	<input type="text" value="3"/>
4	ACAD_CAREER	No	<input type="text" value="Career"/>	<input type="text" value="4"/>
5	NAME	No	<input type="text" value="Name"/>	<input type="text" value="5"/>

This example illustrates the fields and controls on the Population Selection File Map - Format tab. You can find definitions for the fields and controls later on this page.

Population Selection File Map

File Mapping Definition

*File Mapping: MASS RPKG 1 STDNT Public [Created/Updated History](#)

*Required Flds: SFA_BRPKG_BIND

*File Type: Delimited Field Delimiter: Comma Field Qualifier: "

Attachment: Upload File Delete Attachment View Attachment

Header Row Header Row Number: 1 Map from Header

Field Mapping Personalize Find First 1-5 of 5 Last

Mapping	Format	Field Name	Field Format	Trim
1		EMPLID		<input checked="" type="checkbox"/>
2		INSTITUTION	Upper	<input type="checkbox"/>
3		AID_YEAR		<input type="checkbox"/>
4		ACAD_CAREER	Upper	<input type="checkbox"/>
5		NAME	Proper	<input type="checkbox"/>

If you access the Population Selection File Map page from the Population Selection group box, the system enters the required fields record from Population Selection Context for the application process, and displays the list of fields in the required fields record in the Field Mapping group box. If you manually navigated to the page, you must enter the name of the required fields records in the **Required Flds** field. When you exit the field, the system displays the fields from that record.

File Mapping Definition

<i>Field or Control</i>	<i>Description</i>
File Mapping	Enter a name for this mapping.
Public	<p>Select to make this mapping accessible for all users to use and update.</p> <p>Clear to make this mapping accessible only to the user who created it.</p> <p>A public mapping is useful for example, when a mapping can be reused for different files or for files that are refreshed regularly.</p>
Created/Updated History	Click to view a history of who updated the mapping and when.

Field or Control	Description
Required Flds (required fields)	<p>Enter the name of the record that contains the fields required to identify the population.</p> <hr/> <p>Note: If you access the page directly from a run control page for a process, the Required Flds field does not appear. The bind record containing the required fields is derived from the Population Context for the process, and the field is hidden.</p> <hr/>
File Type	<p>Specify the type of external file, either <i>Flat</i> or <i>Delimited</i>.</p> <p>If you enter <i>Delimited</i>, you must also verify or enter the delimiter and qualifier.</p> <p>File types are translate values. Do not modify these values.</p>
Field Delimiter	<p>Appears only for a file type of <i>Delimited</i>.</p> <p>Enter the value in the external file that signifies the end of one value and the beginning of another. Values are:</p> <p><i>Comma</i> (default value)</p> <p><i>Pipe</i></p> <p><i>Semicolon</i></p> <p><i>Tab</i></p> <p>Field Delimiter values are translate values. Do not modify these values.</p>
Field Qualifier	<p>Appears only for a file type of <i>Delimited</i>.</p> <p>Enter the value in the external file that qualifies the end of one field and the beginning of another. The default qualifier is " (quotation mark).</p>

Field or Control	Description
Header Row and Header Row Number	<p>The Header Row check box and the Header Row Number field appear only if the file type is <i>Delimited</i>.</p> <p>If the file that contains the IDs to process includes header rows, for example column titles or to display a title for the document, select the Header Row check box and enter the number of rows in the uploaded file used as the header. The Population Selection process evaluates values after the end of the number of header rows specified.</p> <p>If you are unsure if the uploaded file has header rows or unsure of which row to use as the header, click Cancel to return to the run control page. Then, click View File to view the delimited file and validate and count the header rows if they exist. Return to the mapping and continue.</p>
Map From Header	<p>Appears only when Header Row is selected.</p> <p>Click to map the column names in the uploaded spreadsheet to the fields required to run the process. The system reads the name of each column in the spreadsheet, compares it to the fields listed in the Field Mapping group box, and if it finds a match, enters the column number in the Field Number field for that field. For example, assume that <i>CAREER</i> is the title of the second column in the spreadsheet that you uploaded. If the <i>ACADEMIC_CAREER</i> field appears in the list of fields in the File Mapping group box, then the system sets the Field Number field to 2.</p> <p>The Mapping From Header feature does not map columns in the spreadsheet that do not match any fields in the File Mapping group box. To map these, you must manually enter the column number in the Field Number column.</p> <hr/> <p>Note: The system uses the short name of the fields to map to the columns in the spreadsheet because PS Query uses the short name as the default value to name the column names when the query results are downloaded into Microsoft Excel.</p> <hr/> <p>See <i>PeopleTools: Query</i>, “Downloading Queries.”</p>

<i>Field or Control</i>	<i>Description</i>
Upload File, Delete Attachment, and View Attachment	<p>These buttons appear only if you navigate to the Population Selection File Map page from the menu, you select the Header Row check box, and if the file option for the External File selection tool on the Selection Tool setup page is set to <i>Attachment</i>.</p> <p>The buttons do not appear if you access the page from a run control page because the buttons are available from the standard Population Selection group box on the run control page.</p> <p>Click to upload, delete, or view the external file to use.</p> <hr/> <p>Note: The process uses the uploaded file for automatic field mapping only. No other process uses this file.</p> <hr/>

Field or Control	Description
File Path and Name	<p>This field appears only if you navigate to the Population Selection File Map page from the menu, and if the file option for the External File selection tool on the Selection Tool setup page is set to <i>Physical Path</i>.</p> <p>The field does not appear if you access the page from a run control page because the field is available from the standard Population Selection group box on the run control page.</p> <p>Enter the path to the external file to use. The file path must follow the appropriate syntax for the application server that you are using:</p> <ul style="list-style-type: none"> • For an NT application server, an appropriate syntax might be: \\tl-abc\test_data\My_File_Name.csv. • For a UNIX application server, an appropriate syntax might be: //test_data/ My_File_Name.csv. (File names are case sensitive for UNIX.) • For a mixed environment (for example, an NT application server with a Unix Process Scheduler) consider setting the External File selection tool to <i>Attachments</i> rather than to <i>Physical Path</i>. <hr/> <p>Warning! Consider these conditions when uploading an external file to parse for use with the Population Selection process:</p> <hr/> <ol style="list-style-type: none"> 1. The uploaded file must include at least the fields marked as required for the process that you want to run. 2. When mapping a flat file, you must include blank spaces when a value is shorter than the longest character length for the column. <p>Looking at the columns below, the starting position for the ID column is 1 and the length is 10. Ten is the longest value for the ID column. All other values need to have blank spaces (represented by x in the example) to make them a length of 10. The same applies to the Name column. Mary-Anne Fletcher has the longest name, which is 18 characters long. Therefore the other name values need to end with blank spaces to make them a character length of 18. In this case the mapping Start position is 11 and the field length is 18.</p> <pre> ID NAME AD1000xxxx John Smithxxxxxx=> x AD100xxxxxx Mary-Ann Fletcher AD10=> xxxxxx Joe Pittxxxxxxxxxxxx ADxxxxxx=> </pre>

Field or Control	Description
	<p>x Mark Smithxxxxxxxx</p> <p>3. Not adding the blank spaces will result in a preview error that says: <i>File row [#] contains fewer fields than file layout. (14015,577) The file row could not be parsed.</i></p> <p>In the case of a delimited file, this error appears when the parser process looks for a field defined on the file mapping that is not in the file.</p> <p>4. Always make changes in the original spreadsheet, not in the converted .csv file.</p> <p>The Population Selection process considers all leading zeros. If you click the Preview Selection Results link on the run control component, the leading zeros are there. However, when you save a Microsoft Excel spreadsheet into a .csv file and reopen the file either by using Microsoft Excel or by clicking the View File button in the standard Population Selection group box, values with leading zeros are truncated. If you make changes to the .csv file, save it, and re-upload it, you will save a file without the leading zeros and the values will be invalid.</p> <p>5. Due to a known Microsoft error (SYLK error) as of the date of this publication, you cannot view a file if its text begins with ID. You can process and preview the file, but you cannot view it from the run control page when its text begins with ID.</p> <p>For information about “SYLK: File format is not valid” error, see Microsoft web site.</p>

Field Mapping - Mapping Tab

Field or Control	Description
Field Name and Required	<p>Displays the name of each field in the required fields record that is specified in the Population Selection Context, and indicates <i>Yes</i> if the uploaded file must have the same field for the process to run. Required fields also require a Field Number to map the field to the corresponding column in the uploaded spreadsheet.</p> <p>Fields marked <i>No</i> are optional. They do not need to be in the spreadsheet and do not required a Field Number value unless you choose to use them, in which case you can manually enter the corresponding column number in the Field Number field.</p>

<i>Field or Control</i>	<i>Description</i>
File Column Header	<p>Appears only when File Type is <i>Delimited</i>. and Header Rows selected.</p> <p>When the Header Row check box is selected, the system enters the short name of the field in the File Column Header column.</p>
Field Number	<p>Appears only when File Type is <i>Delimited</i>.</p> <p>Displays the number of the column in the uploaded file that corresponds to this field.</p>
Starting Position and Field Length	<p>Appear only when File Type is <i>Flat</i>.</p> <p>Enter the starting position and the field length for each required field.</p>

Field Mapping - Format Tab

<i>Field or Control</i>	<i>Description</i>
Field Format	<p>Appears if formatting options exist.</p> <p>Enter the format to use for the field value. Each field has options relevant to the data type. For example, possible date type formats are <i>DDMMYY</i>, <i>DDMMYYYY</i>, <i>DDMMYY</i>, and so on. Possible character type formats include the case controls <i>Lower</i>, <i>Proper</i>, and <i>Upper</i>.</p>
Date Separator	<p>Appears only for date field types.</p> <p>Enter the symbol to use to separate the date parts.</p>
Decimal Position	<p>Appears only for number field types.</p> <p>Enter the position to use for placing the decimal.</p>
Trim	<p>Appears only for fields that are not date or time field types.</p> <p>Select to trim leading or trailing spaces in fields.</p>

Warning! After entering mapping information, preview the results before running the File Parser process to confirm that the column titles match the information inside the columns and that the mapping and results are otherwise correct. To preview the results, access the standard Population Selection group box in the run control component of the application process. If the Population Selection check box is available, select it. Then set the **Selection Tool** to *External File*, upload the file, select the mapping name you just created, and click the **Preview Selection Results** link. The **Preview Selection Results** link appears only if your institution set the external file selection tool to allow preview results at installation.

Cross-references to Application-specific File Parser Content

This section discusses the cross-references to application-specific documents that contain content related to File Parser.

Financial Aid

Topics:

Understanding the File Parser Process

PeopleSoft Financial Aid incorporates the File Parser utility automatically in its External Awards process to convert data from an external award data file into external award staging tables. The process uses a predefined context definition delivered by the PeopleSoft system. You do not have to define the field conversion or set up the context definition. However, you will need to create file mapping definition using the External Award context definition to populate the target external award staging tables.

See:

- “Setting Up External Award Processing” (Financial Aid)
- “Understanding External Award Processing” (Financial Aid)

Setting Up a Context Definition

The PeopleSoft system currently delivers a predefined External Award Load context definition for the Financial Aid External Awarding process. The context definition identifies the fields in the External Award staging table that can accept converted external file data. You can modify the context definition to prevent fields from being visible (Visible for Mapping check box), but you should not make any other modifications to the predefined context definition. Changing the record or field names or their values or making any other modifications can cause the External Award process to fail.

See “Setting Up External Award Processing” (Financial Aid).

Running the File Parser Process

The External Awards process in PeopleSoft Financial Aid automatically incorporates the File Parser utility to convert data from an external award data file into the External Award staging tables. Do not run the File Parser process separately, as described in this document, for the External Awards process. Instead, after you have created your specific file mapping definition for your external award file, use the External Award Staging process to load external award data into the staging tables.

See “Understanding External Award Processing” (Financial Aid).

Recruiting and Admissions

See “Setup for Loading Applications Using File Parser” (Recruiting and Admissions).

Student Records

The Higher Education Statistics Agency (HESA) functionality uses File Parser to import HESA Validation Kit errors.

See “Understanding HESA Returns” (Student Records).

Campus Community

Constituent Transaction Management (CTM) uses File Parser for offline transactions.

See [Understanding CTM](#).

Creating Calculated Mapping Application Class Objects

This section discusses how to:

- Create an application package.
- Create an application class.
- Access staged field values.
- Access file field values.

It is assumed that the person who will be responsible for creating and managing the application classes is a seasoned engineer who is comfortable with working with PeopleTools Application Designer, is well versed in writing PeopleCode, and has detailed knowledge of the referential integrity associated with the tables referenced by File Parser.

Warning! The examples presented in this section have not been exposed to any rigorous testing scenarios. If you decide to use these examples in any form, it is strongly recommended that a complete and thorough set of test cycles be run before moving to production.

Creating an Application Package

To create an application package:

1. Open PeopleTools Application Designer.
2. File/New/Application Package.
3. Save the empty application package with a meaningful name.

- At the root level of the application package, insert a new application package. Repeat as necessary to produce a meaningful application package structure.

Creating an Application Class

To create an application class:

- At the appropriate level within your application package, insert an application class.
- Save it with a meaningful name, reflective of what the application class is doing and is intuitive for the end user to select when defining the File Parser Mapping Definitions.

The following shows an example:

This example illustrates the fields and controls on the Application package example. You can find definitions for the fields and controls later on this page.

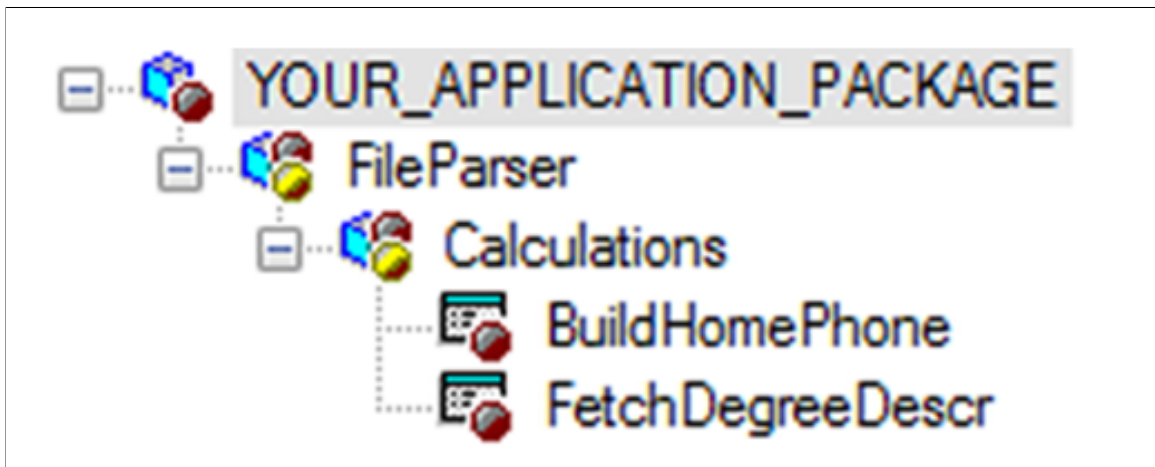

Accessing Staged Field Values

The following application class code illustrates how to reference data elements that reside at the *Staging* level.

Note: In the following code, only the code formatted in bold can be changed by the developer. Rest of the code is required to successfully run or reference staging field values.

```
import SCC_FILE_PARSER:UTIL:FieldCalculationAbstract;
import SCC_FILE_PARSER:MODEL:Results:ResultsField;
import SCC_FILE_PARSER:MODEL:Results:ResultsRecord;
import SCC_FILE_PARSER:MODEL:Results:ResultsCollection;
import SCC_FILE_PARSER:UTIL:Exception:FileParserException;
/**
 * class FetchDegreeDescr
 *
 * @version 1.0
 * @author Your Institution
 *
 * Module: Your Application
 * Description: Your Description
 */
/**
 * This Application Class is designed to read the incoming Degree value
 * residing on the mapped/staged Record Definition: SCC_STG_EXTDEGR, Field: DEGREE,
```

```

* and then obtain the description from the table PS_DEGREE_TBL.
*
* If found, pass back the description, else pass back the string 'NOT FOUND'.
*/
class FetchDegreeDescr extends SCC_FILE_PARSER:UTIL:FieldCalculationAbstract
/* public methods */
method FetchDegreeDescr();
method calculateValue(&ResultsFieldIn As SCC_FILE_PARSER:MODEL:Results:ResultsField=>
,
&ResultsCollectionIn As SCC_FILE_PARSER:MODEL:Results:ResultsCollection) Returns an=>
Y;
private
method GetFileData();
method GetFieldReferences();
instance string &Degree;
instance string &DegreeDescrOut;
instance SCC_FILE_PARSER:MODEL:Results:ResultsField &ResultsField;
instance SCC_FILE_PARSER:MODEL:Results:ResultsCollection &ResultsCollection;
instance SCC_FILE_PARSER:MODEL:Results:ResultsField &DegreeField;
end-class;
/**
* Instantiate the App. Class.
*/
method FetchDegreeDescr
%Super = create SCC_FILE_PARSER:UTIL:FieldCalculationAbstract();
end-method;
/**
* This method is the main driver that passes back the derived value.
*/
method calculateValue
/+ &ResultsFieldIn as SCC_FILE_PARSER:MODEL:Results:ResultsField, +/
/+ &ResultsCollectionIn as SCC_FILE_PARSER:MODEL:Results:ResultsCollection +/
/+ Returns Any +/
/+ Extends/implements SCC_FILE_PARSER:UTIL:FieldCalculationAbstract.CalculateValue =>
+
&ResultsCollection = &ResultsCollectionIn;
&ResultsField = &ResultsFieldIn;
%This.GetFileData();
/**
* Pass back the derived value to the field calling this Calculated Application Clas=>
S.
*/
Return &DegreeDescrOut;
end-method;
/**
* This method uses the obtained degree value as the key in the criteria to obtain t=>
he
* description from the table PS_DEGREE_TBL.
*/
method GetFileData
Local string &DegreeDescr;
/**
* Call the method GetFieldReferences to obtain the incoming degree value.
*/
If &DegreeField = Null Then
%This.GetFieldReferences();
End-If;
&Degree = "";
/**
* Test to see if we found a degree value. If so, execute the SQL statement to
* obtain the description.
*/
If &DegreeField <> Null Then
&Degree = &DegreeField.FieldValue;
SQLExec("SELECT A.DESCR FROM PS_DEGREE_TBL A WHERE A.DEGREE =:1 AND A.EFF_STATUS =

```

```

'A' AND A.EFFDT = (SELECT MAX(A1.EFFDT) FROM PS_DEGREE_TBL A1 WHERE A1.DEGREE =
A.DEGREE AND A1.EFFDT <= %DateIn(:2))", &Degree, %Date, &DegreeDescr);
/**
 * Test to see if we found a degree description. If so, assign the value to be
 * passed back.
 * Otherwise, assign the text string 'NOT FOUND'.
 */
If &DegreeDescr = "" Then
&DegreeDescrOut = "NOT FOUND";
Else
&DegreeDescrOut = &DegreeDescr;
End-If;
End-If;
end-method;
method GetFieldReferences
Local integer &SegmentNbr;
Local integer &RecordRow;
Local SCC_FILE_PARSER:MODEL:Results:ResultsRecord &obj_SCC_STG_EXTDEGR;
&SegmentNbr = &ResultsField.ResultsRecord.SegmentNbr;
&RecordRow = &ResultsField.ResultsRecord.RecordRow;
/**
 * Establish a reference to the staging record definition
 * containing the incoming mapped field.
 */
&obj_SCC_STG_EXTDEGR = &ResultsCollection.GetResultsRecord(&SegmentNbr,
"SCC_STG_EXTDEGR", &RecordRow);
/**
 * If the reference exists, establish a reference to the staging mapped field.
 */
If &obj_SCC_STG_EXTDEGR <> Null Then
&DegreeField = &obj_SCC_STG_EXTDEGR.GetResultsField("DEGREE");
End-If;
end-method;

```

Accessing File Field Values

To reference an incoming File Field value, you need to obtain two key values associated with that specific field. These key values are *Segment Number* and the *Sort Order Number*.

To obtain the required keys, follow these steps:

Step 1: Identify the File Fields you wish to access.

In this example, we want to access the incoming Home Phone Area Code and the Home Phone.

Step 2: Identify the Segment Number. This value is derived based upon the File Definition. If the File Definition does not contain Multiple Row Types (that is, you have not selected the Multiple Row Type check box), then the Segment Number will always be a value of 1 (one).

This example illustrates the fields and controls on the File Definition page - Multiple Row Types is not selected. You can find definitions for the fields and controls later on this page.

The screenshot shows the 'File Definition' tab selected. The 'Map Name' section includes the following fields and controls:

- *Map Name: [Text Input]
- *Status: Active (Dropdown)
- *Context Definition: [Dropdown]
- *File Type: Delimited (Dropdown)
- *Delimiter: Pipe (Dropdown)
- *Qualifier: " (Text Input)
- Conversion Definition: Common Application (Dropdown)
- Multiple Row Types

In this example, a Segment Number of 2 (two) would be used if fields contained within DTL_NAME are to be referenced:

This example illustrates the fields and controls on the File Definition page - Multiple Row Types is selected. You can find definitions for the fields and controls later on this page.

The screenshot shows the 'File Definition' tab selected. The 'Map Name' section includes the following fields and controls:

- *Map Name: [Text Input]
- *Status: Active (Dropdown)
- *Context Definition: [Dropdown]
- *File Type: Delimited (Dropdown)
- *Delimiter: Pipe (Dropdown)
- *Qualifier: " (Text Input)
- Conversion Definition: [Dropdown]
- Multiple Row Types

Below the 'Map Name' section is a 'Row Types' table with the following data:

	Name	Section ID Value	Field Number		
1	Bio Detail	STDNT_HDR	1	+	-
2	Name	DTL_NAME	1	+	-
3	Application Data	DTL_APL_DAT	1	+	-

Step 3: Obtain the Sort Order Number(s). The Sort Order Number can be found on the File Layout page:

This example illustrates the fields and controls on the File Layout - Location tab. You can find definitions for the fields and controls later on this page.

	Sort Order	File Field Name	Field Number	Field Type		
11	91	PREF_FIRST_NAME_SRCH	7	Character	+	-
12	100	Date of Birth	8	Date	+	-
13	110	SSN Combined	9	Character	+	-
14	120	Preferred Phone	10	Character	+	-
15	130	Home Phone Area Code	11	Character	+	-
16	140	Home Phone	12	Character	+	-
17	150	Cell Area Code	13	Character	+	-
18	160	Cell Phone	14	Character	+	-
19	170	Email	15	Character	+	-
20	180	Perm Address1	16	Character	+	-

In the graphic we see that Home Phone Area Code has a Sort Order Number of 130, and the Home Phone Sort Order Number is 140.

Step 4: Write these values down to be referenced within your application class.

The following application class code illustrates how to reference data elements that reside at the incoming File Field level.

Note: In the following code, only the code formatted in bold can be changed by the developer. Rest of the code is required to successfully run or reference staging field values.

```
import SCC_FILE_PARSER:MODEL:Results:ResultsField;
import SCC_FILE_PARSER:UTIL:FieldCalculationAbstract;
import SCC_FILE_PARSER:MODEL:Results:ResultsFileFields;
import SCC_FILE_PARSER:MODEL:Results:ResultsCollection;
/**
 * class BuildHomePhone
 *
 * @version 1.0
 * @author Your Institution
 *
 * Module: Your Application
 * Description: Your Description
 */
/**
 * This Application Class is designed to read two values, Home Phone Area Code
 * and Home Phone from the incoming File Fields. They will then be concatenated
 * into one single field and passed back to the mapped field containing the
 * Calculated mapping action/reference to this Application Class.
 */
class BuildHomePhone extends SCC_FILE_PARSER:UTIL:FieldCalculationAbstract
/* public methods */
method BuildHomePhone ();
```

```

method calculateValue(&ResultsFieldIn As SCC_FILE_PARSER:MODEL:Results:ResultsField=>
,
&ResultsCollectionIn As SCC_FILE_PARSER:MODEL:Results:ResultsCollection) Returns an=>
y;
private
instance string &FileFldValueOut;
instance string &FieldValueString01, &FieldValueString02;
instance SCC_FILE_PARSER:MODEL:Results:ResultsField &ResultsField;
instance SCC_FILE_PARSER:MODEL:Results:ResultsCollection &ResultsCollection;
instance SCC_FILE_PARSER:MODEL:Results:ResultsFileFields &FileFldValueField;
end-class;
/**
* Instantiate the App. Class.
*/
method BuildHomePhone
%Super = create SCC_FILE_PARSER:UTIL:FieldCalculationAbstract();
end-method;
/**
* This method is the main driver that passes back the derived value.
*/
method calculateValue
/+ &ResultsFieldIn as SCC_FILE_PARSER:MODEL:Results:ResultsField, +/
/+ &ResultsCollectionIn as SCC_FILE_PARSER:MODEL:Results:ResultsCollection +/
/+ Returns Any +/
/+ Extends/implements SCC_FILE_PARSER:UTIL:FieldCalculationAbstract.CalculateValue =>

+/
Local integer &filesegout, &fldnumout;
&FileFldValueField = &ResultsCollectionIn.RFF;
/**
* Assign the appropriate value for the Segment Number to be passed to
* the Method FetchFileFieldValue.
*/
&filesegout = 1; /* File Segment Number will always be 1 for non-multiple row types=>

. */
/**
* Assign the appropriate value for the File Field value to be passed to
* the Method FetchFileFieldValue.
*/
/* Home Phone Area Code */
&fldnumout = 130;
&FieldValueString01 = &FileFldValueField.FetchFileFieldValue(&filesegout, &fldnumou=>

t);
/* Home Phone */
&fldnumout = 140;
&FieldValueString02 = &FileFldValueField.FetchFileFieldValue(&filesegout, &fldnumou=>

t);
/**
* Test that we have values to build and pass back.
*/
If (&FieldValueString01 <> " " And
&FieldValueString02 <> " ") Then
/* Build the home phone number */
&FileFldValueOut = &FieldValueString01 | " " | &FieldValueString02;
Else
&FileFldValueOut = " ";
End-If;
Return &FileFldValueOut;
end-method;

```

Commonly Used Calculated Mapping Application Class Objects

This section provides examples for how to derive:

- External Organization ID.
- Activity Description.
- Degree Description.
- Subject Description.
- Write Transaction Map.
- Remove special characters for Last Name Search.
- Remove special characters for First Name Search.

It is assumed that the person who will be responsible for creating and managing the application classes is a seasoned engineer who is comfortable with working with PeopleTools Application Designer, is well versed in writing PeopleCode, and has detailed knowledge of the referential integrity associated with the tables referenced by the File Parser context definition.

Warning! These are examples only, and have not been exposed to any rigorous testing scenarios. Should you decide to use these examples in any form, it is strongly recommended that a complete and thorough set of test cycles be exercised before moving to production.

External Organization ID

Code example:

```
import SCC_FILE_PARSER:UTIL:FieldCalculationAbstract;
import SCC_FILE_PARSER:MODEL:Results:ResultsField;
import SCC_FILE_PARSER:MODEL:Results:ResultsRecord;
import SCC_FILE_PARSER:MODEL:Results:ResultsCollection;
import SCC_FILE_PARSER:UTIL:Exception:FileParserException;

/**
 * class ExtOrgId
 *
 * @version 1.0
 * @author Campus Solutions
 *
 * Module: Recruiting and Admissions / Common App.
 * Description:
 */

class ExtOrgId extends SCC_FILE_PARSER:UTIL:FieldCalculationAbstract
  /* public methods */

  method ExtOrgId();
  method calculateValue(&ResultsFieldIn As
  SCC_FILE_PARSER:MODEL:Results:ResultsField,
  &ResultsCollectionIn As SCC_FILE_PARSER:MODEL:Results:ResultsCollection) Returns an⇒
  y;

private
```

```

method GetFileData();
method GetFieldReferences();

instance string &SchoolCeeb;
instance string &ExtOrgIdOut;

instance SCC_FILE_PARSER:MODEL:Results:ResultsField &ResultsField;
instance SCC_FILE_PARSER:MODEL:Results:ResultsCollection &ResultsCollection;
instance SCC_FILE_PARSER:MODEL:Results:ResultsField &SchoolCeebField;

end-class;

method ExtOrgId

    %Super = create SCC_FILE_PARSER:UTIL:FieldCalculationAbstract();

end-method;

method calculateValue
    /+ &ResultsFieldIn as SCC_FILE_PARSER:MODEL:Results:ResultsField, +/
    /+ &ResultsCollectionIn as SCC_FILE_PARSER:MODEL:Results:ResultsCollection +/
    /+ Returns Any +/
    /+ Extends/implements
    SCC_FILE_PARSER:UTIL:FieldCalculationAbstract.CalculateValue +/

    &ResultsCollection = &ResultsCollectionIn;
    &ResultsField = &ResultsFieldIn;

    %This.GetFileData();

    Return &ExtOrgIdOut;

end-method;

method GetFileData

    Local string &ExtOrg;

    If &SchoolCeebField = Null Then
        %This.GetFieldReferences();
    End-If;

    &SchoolCeeb = "";

    If &SchoolCeebField <> Null Then
        &SchoolCeeb = &SchoolCeebField.FieldValue;

        SQLExec("SELECT EXT_ORG_ID FROM PS_ORG_ADM_CUR_VW WHERE ATP_CD = :1",
&SchoolCeeb, &ExtOrg);

        &ExtOrgIdOut = &ExtOrg;
    End-If;

end-method;

method GetFieldReferences

    Local integer &SegmentNbr;
    Local integer &RecordRow;

    Local SCC_FILE_PARSER:MODEL:Results:ResultsRecord &obj_SCC_STG_ACADHST;

    &SegmentNbr = &ResultsField.ResultsRecord.SegmentNbr;
    &RecordRow = &ResultsField.ResultsRecord.RecordRow;

    &obj_SCC_STG_ACADHST = &ResultsCollection.GetResultsRecord(&SegmentNbr,

```

```

"SCC_STG_ACADHST", &RecordRow);

    If &obj_SCC_STG_ACADHST <> Null Then
        &SchoolCeebField = &obj_SCC_STG_ACADHST.GetResultsField("SAD_SCHOOL_CEEB");
    End-If;

end-method;

```

Activity Description

Code example:

```

import SCC_FILE_PARSER:UTIL:FieldCalculationAbstract;
import SCC_FILE_PARSER:MODEL:Results:ResultsField;
import SCC_FILE_PARSER:MODEL:Results:ResultsRecord;
import SCC_FILE_PARSER:MODEL:Results:ResultsCollection;
import SCC_FILE_PARSER:UTIL:Exception:FileParserException;

/**
 * class FetchActivityDescr
 *
 * @version 1.0
 * @author Campus Solutions
 *
 * Module: Recruiting and Admissions / Common App.
 * Description:
 */

class FetchActivityDescr extends SCC_FILE_PARSER:UTIL:FieldCalculationAbstract
    /* public methods */

    method FetchActivityDescr();
    method calculateValue(&ResultsFieldIn As
SCC_FILE_PARSER:MODEL:Results:ResultsField, &ResultsCollectionIn
As SCC_FILE_PARSER:MODEL:Results:ResultsCollection) Returns any;

private
    method GetFileData();
    method GetFieldReferences();

    instance string &Setid;
    instance string &Activity;
    instance string &ActivityDescrOut;

    instance SCC_FILE_PARSER:MODEL:Results:ResultsField &ResultsField;
    instance SCC_FILE_PARSER:MODEL:Results:ResultsCollection &ResultsCollection;
    instance SCC_FILE_PARSER:MODEL:Results:ResultsField &ActivityField;

end-class;

method FetchActivityDescr

    %Super = create SCC_FILE_PARSER:UTIL:FieldCalculationAbstract();

end-method;

method calculateValue
    /* &ResultsFieldIn as SCC_FILE_PARSER:MODEL:Results:ResultsField, */
    /* &ResultsCollectionIn as SCC_FILE_PARSER:MODEL:Results:ResultsCollection */
    /* Returns Any */
    /* Extends/implements
SCC_FILE_PARSER:UTIL:FieldCalculationAbstract.CalculateValue */

    &ResultsCollection = &ResultsCollectionIn;
    &ResultsField = &ResultsFieldIn;

```

```

    %This.GetFileData();

    Return &ActivityDescrOut;

end-method;

method GetFileData

    Local string &ActivityDescr;

    If &ActivityField = Null Then
        %This.GetFieldReferences();
    End-If;

    &Setid = "PSUNV"; /* For now, the SetID is
hard coded - need to add code to fetch from system. */
    &Activity = "";

    If &ActivityField <> Null Then
        &Activity = &ActivityField.FieldValue;

        SQLExec("select a.descr from ps_extr_actvty_tbl a
where a.extra_activity =:1 and a.setid =:2 and
a.eff_status = 'A' and a.effdt = (select max(a1.effdt)
from ps_extr_actvty_tbl a1 where a1.setid = a.setid and
a1.extra_activity = a.extra_activity and
a1.effdt <= %DateIn(:3))", &Activity,
&Setid, %Date, &ActivityDescr);

        If &ActivityDescr = "" Then
            &ActivityDescrOut = "NOT FOUND";
        Else
            &ActivityDescrOut = &ActivityDescr;
        End-If;
    End-If;

end-method;

method GetFieldReferences

    Local integer &SegmentNbr;
    Local integer &RecordRow;

    Local SCC_FILE_PARSER:MODEL:Results:ResultsRecord &obj_SCC_STG_EXTRACU;

    &SegmentNbr = &ResultsField.ResultsRecord.SegmentNbr;
    &RecordRow = &ResultsField.ResultsRecord.RecordRow;

    &obj_SCC_STG_EXTRACU = &ResultsCollection.GetResultsRecord(&SegmentNbr,
"SCC_STG_EXTRACU", &RecordRow);

    If &obj_SCC_STG_EXTRACU <> Null Then
        &ActivityField = &obj_SCC_STG_EXTRACU.GetResultsField("EXTRA_ACTIVITY");
    End-If;

end-method;

```

Degree Description

Code example:

```

import SCC_FILE_PARSER:UTIL:FieldCalculationAbstract;
import SCC_FILE_PARSER:MODEL:Results:ResultsField;
import SCC_FILE_PARSER:MODEL:Results:ResultsRecord;
import SCC_FILE_PARSER:MODEL:Results:ResultsCollection;
import SCC_FILE_PARSER:UTIL:Exception:FileParserException;

```

```

/**
 * class FetchDegreeDescr
 *
 * @version 1.0
 * @author Campus Solutions
 *
 * Module: Recruiting and Admissions / Common App.
 * Description:
 */

class FetchDegreeDescr extends SCC_FILE_PARSER:UTIL:FieldCalculationAbstract
  /* public methods */

  method FetchDegreeDescr();
  method calculateValue(&ResultsFieldIn As
  SCC_FILE_PARSER:MODEL:Results:ResultsField, &ResultsCollectionIn
  As SCC_FILE_PARSER:MODEL:Results:ResultsCollection) Returns any;

private
  method GetFileData();
  method GetFieldReferences();

  instance string &Degree;
  instance string &DegreeDescrOut;

  instance SCC_FILE_PARSER:MODEL:Results:ResultsField &ResultsField;
  instance SCC_FILE_PARSER:MODEL:Results:ResultsCollection &ResultsCollection;
  instance SCC_FILE_PARSER:MODEL:Results:ResultsField &DegreeField;

end-class;

method FetchDegreeDescr

  %Super = create SCC_FILE_PARSER:UTIL:FieldCalculationAbstract();

end-method;

method calculateValue
  /* &ResultsFieldIn as SCC_FILE_PARSER:MODEL:Results:ResultsField, */
  /* &ResultsCollectionIn as SCC_FILE_PARSER:MODEL:Results:ResultsCollection */
  /* Returns Any */
  /* Extends/implements
  SCC_FILE_PARSER:UTIL:FieldCalculationAbstract.CalculateValue */

  &ResultsCollection = &ResultsCollectionIn;
  &ResultsField = &ResultsFieldIn;

  %This.GetFileData();

  Return &DegreeDescrOut;

end-method;

method GetFileData

  Local string &DegreeDescr;

  If &DegreeField = Null Then
    %This.GetFieldReferences();
  End-If;

  &Degree = "";

  If &DegreeField <> Null Then
    &Degree = &DegreeField.FieldValue;
  End-If;

```

```

        SQLExec("SELECT A.DESCR FROM PS_DEGREE_TBL A
WHERE A.DEGREE =:1 AND A.EFF_STATUS = 'A' AND
A.EFFDT = (SELECT MAX(A1.EFFDT) FROM PS_DEGREE_TBL A1
WHERE A1.DEGREE = A.DEGREE AND
A1.EFFDT <= %DateIn(:2))", &Degree, %Date, &DegreeDescr);

        If &DegreeDescr = "" Then
            &DegreeDescrOut = "NOT FOUND";
        Else
            &DegreeDescrOut = &DegreeDescr;
        End-If;
    End-If;
end-method;

method GetFieldReferences

    Local integer &SegmentNbr;
    Local integer &RecordRow;

    Local SCC_FILE_PARSER:MODEL:Results:ResultsRecord &obj_SCC_STG_EXTDEGR;

    &SegmentNbr = &ResultsField.ResultsRecord.SegmentNbr;
    &RecordRow = &ResultsField.ResultsRecord.RecordRow;

    &obj_SCC_STG_EXTDEGR = &ResultsCollection.GetResultsRecord(&SegmentNbr,
"SCC_STG_EXTDEGR", &RecordRow);

    If &obj_SCC_STG_EXTDEGR <> Null Then
        &DegreeField = &obj_SCC_STG_EXTDEGR.GetResultsField("DEGREE");
    End-If;

end-method;

```

Subject Description

Code example:

```

import SCC_FILE_PARSER:UTIL:FieldCalculationAbstract;
import SCC_FILE_PARSER:MODEL:Results:ResultsField;
import SCC_FILE_PARSER:MODEL:Results:ResultsRecord;
import SCC_FILE_PARSER:MODEL:Results:ResultsCollection;
import SCC_FILE_PARSER:UTIL:Exception:FileParserException;

/**
 * class FetchSubjectDescr
 *
 * @version 1.0
 * @author Campus Solutions
 *
 * Module: Recruiting and Admissions / Common App.
 * Description:
 */

class FetchSubjectDescr extends SCC_FILE_PARSER:UTIL:FieldCalculationAbstract
/* public methods */

    method FetchSubjectDescr();
    method calculateValue(&ResultsFieldIn As
SCC_FILE_PARSER:MODEL:Results:ResultsField, &ResultsCollectionIn
As SCC_FILE_PARSER:MODEL:Results:ResultsCollection) Returns any;

private
    method GetFileData();
    method GetFieldReferences();

```

```

instance string &SubjectArea;
instance string &SubjectAreaDescrOut;

instance SCC_FILE_PARSER:MODEL:Results:ResultsField &ResultsField;
instance SCC_FILE_PARSER:MODEL:Results:ResultsCollection &ResultsCollection;
instance SCC_FILE_PARSER:MODEL:Results:ResultsField &SubjectAreaField;

end-class;

method FetchSubjectDescr

    %Super = create SCC_FILE_PARSER:UTIL:FieldCalculationAbstract();

end-method;

method calculateValue
    /+ &ResultsFieldIn as SCC_FILE_PARSER:MODEL:Results:ResultsField, +/
    /+ &ResultsCollectionIn as SCC_FILE_PARSER:MODEL:Results:ResultsCollection +/
    /+ Returns Any +/
    /+ Extends/implements
    SCC_FILE_PARSER:UTIL:FieldCalculationAbstract.CalculateValue +/

    &ResultsCollection = &ResultsCollectionIn;
    &ResultsField = &ResultsFieldIn;

    %This.GetFileData();

    Return &SubjectAreaDescrOut;

end-method;

method GetFileData

    Local string &SubjectAreaDescr;

    If &SubjectAreaField = Null Then
        %This.GetFieldReferences();
    End-If;

    &SubjectArea = "";

    If &SubjectAreaField <> Null Then
        &SubjectArea = &SubjectAreaField.FieldValue;

        SQLExec("SELECT A.DESCR FROM PS_EXT_SUBJECT_TBL A
WHERE A.EXT_SUBJECT_AREA =:1 AND A.EFF_STATUS = 'A'
AND A.EFFDT = (SELECT MAX(A1.EFFDT) FROM PS_EXT_SUBJECT_TBL A1
WHERE A1.EXT_SUBJECT_AREA = A.EXT_SUBJECT_AREA AND
A1.EFFDT <= %DateIn(:2))", &SubjectArea, %Date, &SubjectAreaDescr);

        If &SubjectAreaDescr = "" Then
            &SubjectAreaDescrOut = "NOT FOUND";
        Else
            &SubjectAreaDescrOut = &SubjectAreaDescr;
        End-If;
    End-If;

end-method;

method GetFieldReferences

    Local integer &SegmentNbr;
    Local integer &RecordRow;

    Local SCC_FILE_PARSER:MODEL:Results:ResultsRecord &obj_SCC_STG_ADMIN;

```

```

    &SegmentNbr = &ResultsField.ResultsRecord.SegmentNbr;
    &RecordRow = &ResultsField.ResultsRecord.RecordRow;

    &obj_SCC_STG_ADMININT = &ResultsCollection.GetResultsRecord(&SegmentNbr,
"SCC_STG_ADMININT", &RecordRow);

    If &obj_SCC_STG_ADMININT <> Null Then
        &SubjectAreaField = &obj_SCC_STG_ADMININT.GetResultsField("EXT_SUBJECT_AREA");
    End-If;

end-method;

```

Write Transaction Map

Code example:

```

import SCC_FILE_PARSER:UTIL:FieldCalculationAbstract;
import SCC_FILE_PARSER:MODEL:Results:ResultsField;
import SCC_FILE_PARSER:MODEL:Results:ResultsRecord;
import SCC_FILE_PARSER:MODEL:Results:ResultsCollection;
import SCC_FILE_PARSER:UTIL:Exception:FileParserException;

/**
 * class WriteTranMap
 *
 * @version 1.0
 * @author Campus Solutions
 *
 * Module: Recruiting and Admissions / Common App.
 * Description:
 */

class WriteTranMap extends SCC_FILE_PARSER:UTIL:FieldCalculationAbstract
/* public methods */

    method WriteTranMap();
    method calculateValue(&ResultsFieldIn As
SCC_FILE_PARSER:MODEL:Results:ResultsField, &ResultsCollectionIn
As SCC_FILE_PARSER:MODEL:Results:ResultsCollection) Returns any;

private
    method GetFileData();

    instance string &WriteTranMapOut;

    instance SCC_FILE_PARSER:MODEL:Results:ResultsField &ResultsField;
    instance SCC_FILE_PARSER:MODEL:Results:ResultsCollection &ResultsCollection;
    instance SCC_FILE_PARSER:MODEL:Results:ResultsField &ScTempIdField;

end-class;

method WriteTranMap

    %Super = create SCC_FILE_PARSER:UTIL:FieldCalculationAbstract();

end-method;

method calculateValue
    /* &ResultsFieldIn as SCC_FILE_PARSER:MODEL:Results:ResultsField, */
    /* &ResultsCollectionIn as SCC_FILE_PARSER:MODEL:Results:ResultsCollection */
    /* Returns Any */
    /* Extends/implements
SCC_FILE_PARSER:UTIL:FieldCalculationAbstract.CalculateValue */

    &ResultsCollection = &ResultsCollectionIn;

```



```

    &ResultsField = &ResultsFieldIn;

    %This.GetFileData();

    Return &WriteTranMapOut;

end-method;

method GetFileData

    Local string &TransAcCd;
    Local integer &ScctempIdIn;

    &TransAcCd = "AAWS_FP_ADMAPPLS";

    SQLExec("SELECT SCC_TEMP_ID FROM PS_SCC_STG_CTRS", &ScctempIdIn);

    SQLExec("INSERT INTO PS_SCC_SL_TRNMAP (SCC_TEMP_ID,SCC_TRANSAC_CD)
VALUES (:1,:2)", &ScctempIdIn, &TransAcCd);

    &WriteTranMapOut = " ";

end-method;

```

Remove Special Characters for Last Name Search

Code example:

```

import SCC_FILE_PARSER:MODEL:Results:ResultsField;
import SCC_FILE_PARSER:UTIL:FieldCalculationAbstract;
import SCC_FILE_PARSER:MODEL:Results:ResultsFileFields;
import SCC_FILE_PARSER:MODEL:Results:ResultsCollection;

/**
 * class LastNameSrch
 *
 * @version 1.0
 * @author Campus Solutions
 *
 * Module: Recruiting and Admissions / Common App.
 * Description:
 */

class LastNameSrch extends SCC_FILE_PARSER:UTIL:FieldCalculationAbstract
/* public methods */

    method LastNameSrch();
    method calculateValue(&ResultsFieldIn As
SCC_FILE_PARSER:MODEL:Results:ResultsField, &ResultsCollectionIn As
SCC_FILE_PARSER:MODEL:Results:ResultsCollection) Returns any;

private

    instance string &LastNameIn;

    instance SCC_FILE_PARSER:MODEL:Results:ResultsField &ResultsField;
    instance SCC_FILE_PARSER:MODEL:Results:ResultsCollection &ResultsCollection;
    instance SCC_FILE_PARSER:MODEL:Results:ResultsFileFields &FileFldValueField;

end-class;

Declare Function RemoveAccent PeopleCode FUNCLIB_CS.PREFERRED_NAME FieldFormula;

method LastNameSrch

    %Super = create SCC_FILE_PARSER:UTIL:FieldCalculationAbstract();

```

```

end-method;

method calculateValue
  /+ &ResultsFieldIn as SCC_FILE_PARSER:MODEL:Results:ResultsField, +/
  /+ &ResultsCollectionIn as SCC_FILE_PARSER:MODEL:Results:ResultsCollection +/
  /+ Returns Any +/
  /+ Extends/implements
  SCC_FILE_PARSER:UTIL:FieldCalculationAbstract.CalculateValue +/

  Local integer &filesegout, &fldnumout;
  Local string &LastNameTemp, &LastNameSrch;

  &FileFldValueField = &ResultsCollectionIn.RFF;

  &filesegout = 1; /* File Segment Number will always be 1 for
non-multiple row types. */

  /* Last Name */
  &fldnumout = 60;
  &LastNameIn = &FileFldValueField.FetchFileFieldValue(&filesegout, &fldnumout);

  RemoveAccent(&LastNameIn, &LastNameTemp);
  &LastNameSrch = &LastNameTemp;

  Return &LastNameSrch;
end-method;

```

Remove Special Characters for First Name Search

Code example:

```

import SCC_FILE_PARSER:MODEL:Results:ResultsField;
import SCC_FILE_PARSER:UTIL:FieldCalculationAbstract;
import SCC_FILE_PARSER:MODEL:Results:ResultsFileFields;
import SCC_FILE_PARSER:MODEL:Results:ResultsCollection;

/**
 * class FirstNameSrch
 *
 * @version 1.0
 * @author Campus Solutions
 *
 * Module: Recruiting and Admissions / Common App.
 * Description:
 */

class FirstNameSrch extends SCC_FILE_PARSER:UTIL:FieldCalculationAbstract
  /* public methods */

  method FirstNameSrch();
  method calculateValue(&ResultsFieldIn As
  SCC_FILE_PARSER:MODEL:Results:ResultsField, &ResultsCollectionIn As
  SCC_FILE_PARSER:MODEL:Results:ResultsCollection) Returns any;

private

  instance string &FirstNameIn;

  instance SCC_FILE_PARSER:MODEL:Results:ResultsField &ResultsField;
  instance SCC_FILE_PARSER:MODEL:Results:ResultsCollection &ResultsCollection;
  instance SCC_FILE_PARSER:MODEL:Results:ResultsFileFields &FileFldValueField;

end-class;

Declare Function RemoveAccent PeopleCode FUNCLIB_CS.PREFERRED_NAME FieldFormula;

```

```

method FirstNameSrch
    %Super = create SCC_FILE_PARSER:UTIL:FieldCalculationAbstract();
end-method;

method calculateValue
    /+ &ResultsFieldIn as SCC_FILE_PARSER:MODEL:Results:ResultsField, +/
    /+ &ResultsCollectionIn as SCC_FILE_PARSER:MODEL:Results:ResultsCollection +/
    /+ Returns Any +/
    /+ Extends/implements
    SCC_FILE_PARSER:UTIL:FieldCalculationAbstract.CalculateValue +/

    Local integer &filesegout, &fldnumout;
    Local string &FirstNameTemp, &FirstNameSrch;

    &FileFldValueField = &ResultsCollectionIn.RFF;

    &filesegout = 1; /* File Segment Number will always be 1 for
non-multiple row types. */

    /* First Name */
    &fldnumout = 40;
    &FirstNameIn = &FileFldValueField.FetchFileFieldValue(&filesegout, &fldnumout);

    RemoveAccent(&FirstNameIn, &FirstNameTemp);
    &FirstNameSrch = &FirstNameTemp;

    Return &FirstNameSrch;
end-method;

```

Troubleshooting Tips

If setting up a large file, map out everything on paper first to determine which records to populate before embarking on setting up the Context Definition and File Mapping Definition.

Context Definitions

Tips:

- Do not deselect the Visible for Mapping check box on important fields when initially setting up and testing because it can be very confusing when trying to debug issues. It is easier to see important data being imported on File Mapping when troubleshooting. Once you have the mapping definition tested, you can go back and deselect Visible for Mapping on the field you do not want the users to change.
- Use the default sort order which increments by 10. This will allow you to insert additional staging records in the future.
- Ensure the staging tables hierarchy via the sort order. Parent table(s) will have a lower sort order than their children.

File Mapping Definition

Tips:

- If you start setting up in *Pending* status, make sure that you change the status to *Active* and save along the way to resolve setup issues as you proceed. Errors are not fired when the status is set to *Pending*.
- Use an incremental approach. Set up the required records, test, add some more records, and test. This is an easier way to troubleshoot setup issues.
- File Layout: When inserting File Fields, use the default sort order which increments by 10. This will allow you to insert additional fields later.
- Mapping page:
 - The system inserts the records according to the order listed on the Context Definition.
 - A value must be provided for each required field. The system displays an error message if a required field has a Mapping Action set to *None*.
 - If you are having issues using the Sequence Mapping Action, try setting the Mapping Action to *Default* and entering 1, 2, 3, and so on for each row of the record you are inserting to.

Porting definitions from one environment to another

Tips:

- When creating new File Parser definitions, it is important to understand that File Parser has a unique key structure for each of its definitions (that is, Conversion, Context, Pop Select, and Mapping).
- After creating these definitions in your development environment, query your current Production File Parser definitions to make sure that you will not overwrite them when porting your new definitions into your production environment.
- If you find any collision(s), rename the keys via native SQL to a unique value(s) prior to exporting the definitions.

The following are some examples of useful SQL and DataMover scripts to help you manage the export or import of File Parser definitions:

Note: Do not use any ID value between 1 and 999. This range is reserved for Campus Solutions.

List Current File Parser Definitions:

```

/*
Instructions:

1) Identify scope. If you are porting either Conversion definitions and/or
   Pop Select Mapping Definitions, you will need to uncomment the respective SQL
   statements - See below.

2) Supply a WHERE clause to narrow down the results.
*/

/* -- - - - - - - - Conversion Definitions (Optional) - - - - - - - - */
/*
SELECT * FROM PS_SCCFP_CNVR;
SELECT * FROM PS_SCCFP_CNVR_FLD;
SELECT * FROM PS_SCCFP_CNVR_VAL;
*/

/* - - - - - - - Pop Select Mapping Definitions (Optional) - - - - - - - */
/*

```

```

SELECT * FROM PS_SCCFP_PS_MAP;
SELECT * FROM PS_SCCFP_PS_MAPFLD;
*/

/* - - - - - Context Definitions - - - - - */

SELECT * FROM PS_SCCFP_CNTXT_DFN;
SELECT * FROM PS_SCCFP_CNTXT_REC;
SELECT * FROM PS_SCCFP_CNTXT_RF;

/* - - - - - Mapping Definitions - - - - - */

SELECT * FROM PS_SCCFP_MAP_DFN;
SELECT * FROM PS_SCCFP_MAP_REC;
SELECT * FROM PS_SCCFP_MAP_FLD;
SELECT * FROM PS_SCCFP_FILE_SGT;
SELECT * FROM PS_SCCFP_FILE_FLD;

```

Update File Parser IDs (Keys):

```

/*
Instructions:

1) Identify scope. If you are porting either Conversion definitions and/or
   Pop Select Mapping Definitions, you will need to uncomment the respective SQL
   statements.

2) Identify the next available ID value(s).

3) Edit the SQL as follows:

   a) Conversion Definitions - (If applicable) Find/Replace the
      string 'New_CNVR_ID' with the next available value assigned
      to your application.

      Find/Replace the string 'Current_CNVR_ID' with
      the current value of SCCFP_CNVR_ID.

   b) Pop Select Mapping Definitions - (If applicable) Find/Replace the
      string 'New_MAP_ID' with the next available value
      assigned to your application.

      Find/Replace the string 'Current_MAP_ID' with the current
      value of SCCFP_MAP_ID.

   c) Context Definitions - Find/Replace the string 'New_CNTXT_ID' with
      the next available value assigned to your application.

      Find/Replace the string 'Current_CNTXT_ID' with the current
      value of SCCFP_CNTXT_ID.

   d) Mapping Definitions - Find/Replace the string 'New_MAP_ID' with
      the next available value assigned to your application.

      Find/Replace the string 'Current_MAP_ID' with the current
      value of SCCFP_MAP_ID.

4) Save your changes and execute the SQL statements in the native
   SQL tool of your choice.

5) Repeat steps 1-4 for any additional File Parser definitions.

6) Verify/Unit test the changes within the File Parser component.
*/

/* - - - - - Conversion Definitions (Optional) - - - - - */
/*
UPDATE PS_SCCFP_CNVR
SET SCCFP_CNVR_ID = New_CNVR_ID
WHERE SCCFP_CNVR_ID = Current_CNVR_ID;

```

```

UPDATE PS_SCCFP_CNVR_FLD
SET SCCFP_CNVR_ID = New_CNVR_ID
WHERE SCCFP_CNVR_ID = Current_CNVR_ID;

UPDATE PS_SCCFP_CNVR_VAL
SET SCCFP_CNVR_ID = New_CNVR_ID
WHERE SCCFP_CNVR_ID = Current_CNVR_ID;
*/

/* - - - - - Pop Select Mapping Definitions (Optional) - - - - - */
/*
UPDATE PS_SCCFP_PS_MAP
SET SCCFP_MAP_ID = New_MAP_ID
WHERE SCCFP_MAP_ID = Current_MAP_ID;

UPDATE PS_SCCFP_PS_MAPFLD
SET SCCFP_MAP_ID = New_MAP_ID
WHERE SCCFP_MAP_ID = Current_MAP_ID;
*/

/* - - - - - Context Definitions - - - - - */

UPDATE PS_SCCFP_CNTXT_DFN
SET SCCFP_CNTXT_ID = New_CNTXT_ID
/*      ,SCCFP_CNVR_ID = New_CNVR_ID */
WHERE SCCFP_CNTXT_ID = Current_CNTXT_ID;

UPDATE PS_SCCFP_CNTXT_REC
SET SCCFP_CNTXT_ID = New_CNTXT_ID
WHERE SCCFP_CNTXT_ID = Current_CNTXT_ID;

UPDATE PS_SCCFP_CNTXT_RF
SET SCCFP_CNTXT_ID = New_CNTXT_ID
WHERE SCCFP_CNTXT_ID = Current_CNTXT_ID;

/* - - - - - Mapping Definitions - - - - - */

UPDATE PS_SCCFP_MAP_DFN
SET SCCFP_MAP_ID = New_MAP_ID,
   SCCFP_CNTXT_ID = New_CNTXT_ID
/*      ,SCCFP_CNVR_ID = New_CNVR_ID */
WHERE SCCFP_MAP_ID = Current_MAP_ID;

UPDATE PS_SCCFP_MAP_REC
SET SCCFP_MAP_ID = New_MAP_ID
WHERE SCCFP_MAP_ID = Current_MAP_ID;

UPDATE PS_SCCFP_MAP_FLD
SET SCCFP_MAP_ID = New_MAP_ID
WHERE SCCFP_MAP_ID = Current_MAP_ID;

UPDATE PS_SCCFP_FILE_SGT
SET SCCFP_MAP_ID = New_MAP_ID
WHERE SCCFP_MAP_ID = Current_MAP_ID;

UPDATE PS_SCCFP_FILE_FLD
SET SCCFP_MAP_ID = New_MAP_ID
WHERE SCCFP_MAP_ID = Current_MAP_ID;

```

Export File Parser Definitions Using DataMover:

```

-- Use this script to extract the File Parser definitions into a data (.dat) format⇒

-- to be used to import into another database.
--

```

```

-- Step 1) Save this script with a meaningful name; something reflective
-- of the File Parser definitions being extracted.
--
-- Step 2) Change the string 'xxxx' to a meaningful name for the export
-- log. Add/prefix a path if you do not wish to use the default path
-- defined in Configuration Manager.
--
-- Step 3) Change the string 'yyyy' to a meaningful name for the data
-- file. Add/prefix a path if you do not wish to use the default path
-- defined in Configuration Manager.
--
-- Step 4) If you are extracting any conversion definitions, change the
-- string 'aaaa' to the value of the conversion ID.
--           Else, delete the EXPORT statements containing the string 'aaaa'.   =>
--
--
-- Step 5) Change the string 'bbbb' to the context ID.
--
-- Step 6) If you are extracting any Pop Select definitions, change the
-- string 'cccc' to the value of the map ID.
--           Else, delete the EXPORT statements containing the string 'cccc'.   =>
--
--
-- Step 7) Change the string 'dddd' to the value of the map ID.
--
-- Step 8) Save your changes and run the DataMover script against the
-- database containing the File Parser definitions you wish to extract.

SET LOG xxxx_Export.LOG;
SET OUTPUT yyyy_EXPORT.DAT;

EXPORT SCCFP_CNVR WHERE SCCFP_CNVR_ID = aaaa;
EXPORT SCCFP_CNVR_FLD WHERE SCCFP_CNVR_ID = aaaa;
EXPORT SCCFP_CNVR_VAL WHERE SCCFP_CNVR_ID = aaaa;

EXPORT SCCFP_CNTXT_DFN WHERE SCCFP_CNTXT_ID = bbbb;
EXPORT SCCFP_CNTXT_REC WHERE SCCFP_CNTXT_ID = bbbb;
EXPORT SCCFP_CNTXT_RF WHERE SCCFP_CNTXT_ID = bbbb;

EXPORT SCCFP_PS_MAP WHERE SCCFP_MAP_ID = cccc;
EXPORT SCCFP_PS_MAPFLD WHERE SCCFP_MAP_ID = cccc;

EXPORT SCCFP_MAP_DFN WHERE SCCFP_MAP_ID = dddd;
EXPORT SCCFP_MAP_REC WHERE SCCFP_MAP_ID = dddd;
EXPORT SCCFP_MAP_FLD WHERE SCCFP_MAP_ID = dddd;
EXPORT SCCFP_FILE_SGT WHERE SCCFP_MAP_ID = dddd;
EXPORT SCCFP_FILE_FLD WHERE SCCFP_MAP_ID = dddd;

```

Import File Parser Definitions Using DataMover:

```

-- Use this script to import the File Parser definition data (.dat) file
-- into another database.
--
-- Step 1) Save this script with a meaningful name; something reflective of
-- the File Parser definitions being imported.
--
-- Step 2) Change the string 'xxxx' to a meaningful name for the import
-- log. Add/prefix a path if you do not wish to use the default path defined
-- in Configuration Manager.
--
-- Step 3) Change the string 'yyyy' to the name of the .dat file being
-- imported. This is the name of the file exported
-- by FILE_PARSER_DEFN_EXPORT.dms. Add/prefix a path if you do not
-- wish to use the default path defined in Configuration Manager.
--
-- Step 4) If you are importing any conversion definitions, change the
-- string 'aaaa' to the value of the conversion ID.

```

```

--          Else, delete the DELETE statements containing the string 'aaaa'.
--          Delete the IMPORT statements containing the Record Definition
--          beginning with 'SCCFP_CNVR'.
--
-- Step 5) Change the string 'bbbb' to the context ID.
--
-- Step 6) If you are importing any Pop Select definitions, change the
-- string 'cccc' to the value of the map ID.
--          Else, delete the DELETE statements containing the string 'cccc'.
--          Delete the IMPORT statements containing the Record Definition
--          beginning with 'SCCFP_PS_MAP'.
--
-- Step 7) Change the string 'dddd' to the value of the map ID.
--
-- Step 8) Save your changes and run the DataMover script against the database
-- containing the File Parser definitions you wish to import.
--

SET LOG xxxx_Import.LOG;
SET INPUT yyyy_EXPORT.DAT;

DELETE FROM PS_SCCFP_CNVR WHERE SCCFP_CNVR_ID = aaaa;
DELETE FROM PS_SCCFP_CNVR_FLD WHERE SCCFP_CNVR_ID = aaaa;
DELETE FROM PS_SCCFP_CNVR_VAL WHERE SCCFP_CNVR_ID = aaaa;

DELETE FROM PS_SCCFP_CNTXT_DFN WHERE SCCFP_CNTXT_ID = bbbb;
DELETE FROM PS_SCCFP_CNTXT_REC WHERE SCCFP_CNTXT_ID = bbbb;
DELETE FROM PS_SCCFP_CNTXT_RF WHERE SCCFP_CNTXT_ID = bbbb;

DELETE FROM PS_SCCFP_PS_MAP WHERE SCCFP_MAP_ID = cccc;
DELETE FROM PS_SCCFP_PS_MAPFLD WHERE SCCFP_MAP_ID = cccc;

DELETE FROM PS_SCCFP_MAP_DFN WHERE SCCFP_MAP_ID = dddd;
DELETE FROM PS_SCCFP_MAP_REC WHERE SCCFP_MAP_ID = dddd;
DELETE FROM PS_SCCFP_MAP_FLD WHERE SCCFP_MAP_ID = dddd;
DELETE FROM PS_SCCFP_FILE_SGT WHERE SCCFP_MAP_ID = dddd;
DELETE FROM PS_SCCFP_FILE_FLD WHERE SCCFP_MAP_ID = dddd;

COMMIT;

IMPORT SCCFP_CNVR;
IMPORT SCCFP_CNVR_FLD;
IMPORT SCCFP_CNVR_VAL;

IMPORT SCCFP_CNTXT_DFN;
IMPORT SCCFP_CNTXT_REC;
IMPORT SCCFP_CNTXT_RF;

IMPORT SCCFP_PS_MAP;
IMPORT SCCFP_PS_MAPFLD;

IMPORT SCCFP_MAP_DFN;
IMPORT SCCFP_MAP_REC;
IMPORT SCCFP_MAP_FLD;
IMPORT SCCFP_FILE_SGT;
IMPORT SCCFP_FILE_FLD;

```

Using Constituent Web Services

Understanding Constituent Web Services

Note: Campus Solutions offers two different types of web services to support Constituent functions. This section covers asynchronous web services. For information on synchronous Constituent web services based on the system's Entity Registry functionality, see [Using Entity Registry Based Constituent Web Service Operations](#).

For information about setup, functional, and technical implementation considerations when you use Search/Match directly between two systems, see “Understanding CS-to-HCM Integration” (Campus Solutions Application Fundamentals).

In general, a web service is a collection of operations that enable software to utilize a resource. The official web service definition can describe almost any standard for exchanging data over the internet, but in common usage the term refers to the exchange of XML messages that follow the SOAP standard using the same HTTP protocol as a web browser. A simple definition of a web service is an internet application programming interface (API) that's self-describing and can work between various programming languages. The constituent web service was developed to be used in a manner consistent with common web services.

The constituent web service manages information about a constituent. A constituent can be a prospect, applicant, student, faculty member, or any other person of interest to your institution. The web service allows the Campus Solutions database to communicate with virtually any other external system, regardless of the technology supporting that system. Prior to web service standards it was difficult to connect systems on disparate technologies, such as operating systems, database platforms, and application architectures. Web service standards make it possible for computer systems on virtually any technology platform to integrate with minimal effort.

Institutions can use constituent web services to integrate constituent data between Campus Solutions and other external systems. The constituent web service:

- Notifies integrated systems when new constituents in Campus Solutions are created or when their information is changed.

External systems can use this notification to synchronize their version of the constituent or to perform processing based on the changed data.

- Allows integrated systems to update a constituent's information in Campus Solutions, such as adding a new address or changing the constituent's name.
- Allows integrated systems to retrieve a constituent's detailed information.
- Enables Campus Solutions users to run Search/Match against an external constituent repository, such as a data hub.

Constituent web service information flow diagram

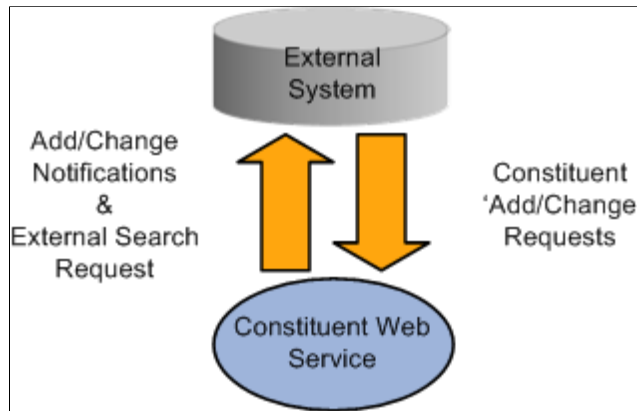

Institutions can use the web service to integrate to a variety of administrative and academic systems that comprise the higher education ecosystem. For example, the service can be used to integrate to a data hub (MDM), housing system, human resources, parking system, learning management system, and general purpose registry. Large institutions often deploy hundreds of such systems.

Messaging between the systems is done via synchronous or asynchronous interactions. In a synchronous interaction, the source system issues a request to the target system and then waits until a response is received. Asynchronous interactions involve the source system issuing a request to the target system and not waiting for any response, but instead immediately continuing with processing. The request is assumed to have been received by the target system and to have been processed successfully. Asynchronous requests don't receive a response from the target system. This model assumes that the underlying messaging middleware guarantees the delivery of the request to the target system.

The *PeopleSoft Campus Solutions Constituent Web Services Developer's Guide* provides the technical details of web services as well as configuration and messaging.

The data that comprises the constituent message includes the core person data contained in the PERSON_BASIC_SYNC message, the Campus Solutions extension data contained in the PERSON_SA message, and affiliations data.

Messaging

Constituent web services uses three types of messaging. The system generates outbound messages when a constituent's data is changed in Campus Solutions. A change in any data element in the constituent message definition raises this condition. The system publishes the constituent message so that any interested external system can be informed. The system generates inbound messages when a constituent's data is updated in an external system that is integrated with Campus Solutions. When a third-party or external system needs to query the Campus Solutions database to view data, the system generates a query message. This is a synchronous inbound request/response *get* service, in which a third party raises a query or data request and the Campus Solutions system delivers a response that contains the requested data details.

Constituent web services delivers the following messages, which are defined using PeopleTools Integration Broker:

- SCC_CONSTITUENT_SYNC (Outbound)
- SCC_PERSON_SYNC (Outbound)

- SCC_CONSTITUENT_IN_SYNC_DS (Inbound)
- SCC_GET_CONSTITUENT_REQ_DS (Inbound)
- SCC_GET_CONSTITUENT_RES_DS (Query)

Note: If you implement Campus Solutions *and* a separate instance of PeopleSoft Human Capital Management, read the relevant documentation about CS-HCM Integration to understand the setup, functional, and technical implementation considerations. See:

“Integrating Person Data” (Campus Solutions Application Fundamentals)

“Integrating Setup Data” (Campus Solutions Application Fundamentals)

“Monitoring Integrations Using the Integrity Utility” (Campus Solutions Application Fundamentals)

See *Information Center: CS-HCM Integration for PeopleSoft Enterprise Campus Solutions* in My Oracle Support (ID 2091799.2).

See:

- *PeopleTools: Integration Broker*
- [Understanding Using External Search Match](#)
- [Defining Affiliations](#)
- [Adding and Updating Affiliations](#)

Prerequisites for Using Constituent Web Services

Before using constituent web services, your application server must be configured such that the publish/subscribe servers are running, and domains and gateways are configured.

In addition, in order to use the PERSON_DATA queue for web services, configure the Queue Definitions page so that the PERSON_DATA **Queue Status** is set to *Run*.

You must also configure the integration gateway using Integration Broker.

See *PeopleTools: Integration Broker*.

Outbound and Inbound Services

Note: If you implement Campus Solutions *and* a separate instance of PeopleSoft Human Capital Management, read the relevant documentation about CS-HCM Integration to understand the setup, functional, and technical implementation considerations. See:

“Integrating Person Data” (Campus Solutions Application Fundamentals)

“Integrating Setup Data” (Campus Solutions Application Fundamentals)

“Monitoring Integrations Using the Integrity Utility” (Campus Solutions Application Fundamentals)

See *Information Center: CS-HCM Integration for PeopleSoft Enterprise Campus Solutions* in My Oracle Support (ID 2091799.2).

The PeopleSoft system delivers three outbound and two inbound web service operations. For information about web services as well as samples of the XML messages that the services generate, see *PeopleSoft Campus Solutions Constituent Web Services Developer's Guide* in My Oracle Support (ID 1982192.1).

Outbound Services

Note: The PeopleSoft system delivers three outbound service operations to notify external systems of changes to Campus Solutions constituent data, search/match for constituents in external repositories, and read ("get") constituent details for a single constituent in an external source.

Constituent Message

Use this operation to notify third parties of the creation, update, or deletion of one or more constituents in the Campus Solutions system. An outbound constituent request is sent whenever a constituent's data is updated. This includes information change by self-service users, administrators, and batch programs (for example, ISIR load).

The notification is sent whenever an administrator accesses any of these person create/update entry points:

- Campus Community – Personal Information
- Campus Community – Personal Information (Student)
- Contributor Relations – Add/Update a Person
- Student Recruiting – Add a Prospect
- Records and Enrollment – Quick Admit
- Student Admission – Application Entry

In general an outbound message is published from any place within Campus Community where a person or the attributes of the person can be created or updated: everywhere that PERSON_BASIC_SYNC and PERSON_SA data is used, as well as the Affiliations components and wherever the FERPA flag appears.

Supported Interaction Patterns

<i>Request/Response</i>	<i>Service</i>	<i>Operation</i>
Asynchronous Request	N/A	SCC_CONSTITUENT_SYNC
Synchronous Request/Response	Not supported	Not supported

Request Message

The request message contains the entire constituent object, including affiliations and the FERPA flag contained in the PERSON_SA record.

Behavior

Whenever constituent information is created or changed an XML message is published.

External Search/Match

The Campus Solutions system uses this operation to search/match (query) against constituents stored within an external system.

Supported Interaction Patterns

Request/Response	Service	Operation
Asynchronous Request	Not supported	Not supported
Synchronous Request/Response	SCC_SM_SERVICE	SCC_SM_SERVICE_SYNC
Synchronous Request/Response	SCC_SM_FETCH	SCC_SM_FETCH_SYNC

Request Message

The request message is the external system Search/Match request object. This is a list of fields that may be partially populated to perform a search against the external system for potential constituents that match the criteria.

Behavior

The response includes all constituents matching the criteria according to the configured matching rules. Alternatively, the system returns a constituent fault message that includes detailed error messages and explanations.

External Read ("Get") Constituent

The Campus Solutions system uses this operation to read a constituent record stored within an external source.

Supported Interaction Patterns

Request/Response	Service	Operation
Asynchronous Request	Not supported	Not supported
Synchronous Request/Response	SCC_CONSTITUENT	SCC_GET_CONSTITUENT

Request Message

The request message contains the EmplID of the constituent stored in the external system.

Response Message

The response includes all constituent details stored in the external system for the given EmplID. If there is no valid response, the system returns a constituent fault message that includes the detailed error messages and explanations.

Behavior

The external system validates the EmplID transmitted in the request message and if the ID is present, the system looks up the given constituent and returns all attributes for the constituent.

Inbound Services

The PeopleSoft system delivers two inbound service operations to manage changes to constituent data. In order to respond to constituent data updates generated in external systems, the constituent web service must listen to and process the inbound response.

Read ("Get") Constituent

Use this operation to request the details of a single constituent in the Campus Solutions system.

Supported Interaction Patterns

Request/Response	Service	Operation
Asynchronous Request	N/A	N/A
Synchronous Request/Response	SCC_CONSTITUENT	SCC_GET_CONSTITUENT

Request Message

The request message is the EmplID, the unique identifier for a constituent.

Response Message

If a constituent is found with the supplied EmplID then the service returns the populated constituent object. Otherwise, it returns a null constituent object.

Behavior

The constituent service validates the EmplID, if present, and populates the response message with all details of the constituent accessible to the caller.

Update Constituent

Use this operation to update the information of a single constituent in the Campus Solutions system.

Supported Interaction Patterns

Request/Response	Service	Operation
Asynchronous Request	SCC_CONSTITUENT_IN_SYNC	SCC_CONSTITUENT_IN_SYNC
Synchronous Request/Response	N/A	N/A

Request Message

The request message contains the EmplID to uniquely identify the constituent to be updated, along with any attributes of the constituent that need to be updated.

Response Message (synchronous only)

The response indicates whether the constituent was updated successfully. If not, the system returns a constituent fault message that includes the detailed error messages and explanations.

Behavior

The constituent service validates the data passed in the request message. If the request is valid and the constituent can be found then the constituent is updated. If any aspect of the data is invalid then the entire request is rejected. If an attempt is made to update non-updatable constituent attributes then the caller may be warned of this in the response.

Query Constituent

Use this operation to query against the constituents contained within the Campus Solutions system.

Supported Interaction Patterns

Request/Response	Service	Operation
Asynchronous Request	N/A	N/A
Synchronous Request/Response	SCC_CONSTITUENT	SCC_GET_CONSTITUENT

Request Message

The request message is the Campus Solutions Search/Match request object. This message contains a list of fields that can be partially populated in order to perform a search against the database for potential constituents that match the criteria. The request also includes the Search/Match setup ID.

Response Message

The response includes a collection of zero to many Search/Match results objects. The Search/Match result object contains partial constituent details along with weighting information that can be used to determine which returned constituent best matches the criteria.

Behavior

The operation validates the Search/Match request. If the request is valid, the system performs a Search/Match against the database and returns the results.

See [Understanding Using External Search Match](#)

Configuring Constituent Event Triggers

To register events, access the Constituent Event Registration page (Set Up SACR, System Administration, Utilities, Constituent Management, Constituent Event Registration).

This example illustrates the fields and controls on the Constituent Event Registration page. You can find definitions for the fields and controls later on this page.

Constituent Event Registration

'Event Name: 

Description:

Details:

The PersonBasicSync AbstractConstituent Implementation class will be used for the PERSON_BASIC_SYNC event. 

Implementation Class

'Root Package ID: 

'Qualified Package/Class Path 

'Application Class ID 

Campus Solutions provides three events: *SCC_CONSTITUENT_IN_SYNC*, *PERSON_BASIC_SYNC*, and *SCC_PERSON_SYNC*. Constituent web services utilizes these registered events in their processing.

Warning! Do not modify the delivered events. If your institution creates new events to trigger messaging, you must add the new events here and register them with constituent web services.

For information about the Constituent event delivered for Research Tracking, see “Setting Up Research Tracking” (Student Records).

Implementation Class

<i>Field or Control</i>	<i>Description</i>
Root Package ID	This is the application package name.

Field or Control	Description
Qualified Package/Class Path	This is the subpackage name. This field defines the path from application package to application class.
Application Class ID	This field lists the application class, which holds the implementation logic.

Configuring Notification Handlers

To register all delivered message handlers, access the Notification Handlers page (Set Up SACR, System Administration, Integrations, Notification Handlers).

This example illustrates the fields and controls on the Notification Handlers page. You can find definitions for the fields and controls later on this page.

Notification Handlers

Notification Handlers

Service Operation:

Description:

Long Description:

Application Class

Package Name:

Path:

Application Class ID:

Campus Solutions provides three handlers: *SCC_CONSTITUENT_IN_SYNC*, *PERSON_BASIC_SYNC*, and *SCC_PERSON_SYNC*. The service-oriented architecture (SOA) framework uses handlers for its messaging.

Warning! Don't modify the delivered message handlers. If your institution creates new events to trigger messaging, you must add the new handlers here and register them with constituent web services.

Application Class

<i>Field or Control</i>	<i>Description</i>
Package Name	This is the application package name.
Path	This field defines the path from application package to application class.
Application Class ID	This field lists the application class, which holds the messaging logic.

Configuring Integration with External Systems

Use the External Core Data Integration page to indicate that the Campus Solutions system is integrated with a constituent data hub or other external system managing person data. This page is also used to enable External Search/Match functionality.

Related Links

[Understanding Using External Search Match](#)

Configuring REST POST Constituent Staging Service

To use the REST POST method to update only staging tables, you first have to set up the service operation `SCC_STG_CONSTIT_R`.

For information on creating permission lists, roles, and user profiles, see the product documentation for *PeopleTools: Security Administration*.

1. Create a permission list, and assign the web service `SCC_STG_CONSTIT_R` to the permission list.
2. Create a role, and then assign the permission list to the role.
3. Create a user profile, and then assign the role for the permission list.

Note: On the ID page, set **ID Type** to **None**.

4. Assign the role you created to your admin or test user.
5. Assign the user profile you created to node ANONYMOUS.
 - a. Navigate to **PeopleTools > Integration Broker > Integration Setup > Node Definitions**.
 - b. In Default User ID, change the value to the user profile value you created earlier.

6. Create the routings for SCC_STG_CONSTIT_R.

For more information on configuring service definitions, see the product documentation for *PeopleTools: Integration Broker*

- a. Go to **PeopleTools > Integration Broker > Integration Setup > Service Definitions**.
- b. Select **REST Service**, then search for the service **SCC_STG_CONSTIT_R**.
- c. Select **SCC_STG_CONSTIT_R** from the search results.
- d. From the Existing Operations grid, select **SCC_STG_CONSTIT_R_POST.v1**.
- e. Click **Routings**.
- f. If there aren't any routings, click **General**.
- g. In Routing Actions Upon Save, select **Generate Any-to-Local**, then click **Save**.
- h. Click **Routings**.

In Routing Definitions, you should see a routing generated for any to local.

7. Set the logging as appropriate for your institution. For example, in Routing Actions Upon Save, select the option that's best for your institution.

- a. From the Routings page, you can select **User Exception**.
- b. Save your changes.
- c. In Routing Definitions, click the routing definition entry. This can look like "**~GENERATED~16947973**".
- d. From the page that appears, in Log Detail, select the option that works best for your institution.
- e. Click **Save**, then click **Return**.

The inbound routing should show the sender node **~ANY~** is active.

8. Save your changes.

9. Optionally, you can create these search/match rules:

- A search/match person rule LNAMEFNAME that only has full last name search and full first name search.
- A search/match person rule NIDONLY that only has national ID (NID) search.
- A search/match person rule LNFNNIDSEXDOB that search last name, first name, national ID, gender, and date of birth.
- A search match person parameter LNFNNIDSEXDOB that has 10 LNFNNIDSEXDOB, 20 NIDONLY, and 30 LNAMEFNAME.

Set its search permission to full access.

For information on search/match, see [Using Search/Match](#).

10. Modify the CTM transaction SCC_STG_CONSTITUENT.

- a. In the Search/Match Setup page, use your preferred search parameter, for example, LNFNNIDSEXDOB.
- b. Use your preferred search result code, for example, PSCS_TRAD_RESUL.
- c. Set up Matches Found as appropriate for your institution. Here's an example:

Search Order Nbr	Description	One Match	Multiple Matches
10	Last Name, First Name, NID, Sex, DOB	Update	Suspend
20	NID	Suspend	Suspend
30	Last Name, First Name	Suspend	Suspend

- d. Set up No Match Found as appropriate for your institution.
- e. Save your changes.

Testing the REST POST Constituent Staging Service

This section discusses how to test whether you configured the service operation SCC_STG_CONSTIT_R correctly.

The REST (Representational State Transfer) POST Constituent Staging Service is a type of synchronous web service that adheres to REST interface standards. The name of the only service operation implemented in this case so far is POST, which is used to add new data into a table structure. In this case, the table structure is the Constituent Staging table hierarchy. The URL of the operation points to the resource to which data will be added. The payload in the following example is an XML representation of the data to be added. This XML is to be added to a flat file to which you will later reference with a curl command.

1. Create the XML file SCC_STG_CONSTIT_REQ_R-POST-2023-09-01-10.03.xml using the following content as an example. You can create or edit this example using a text editor on your computer. You can also use any file name.

```
<?xml version="1.0"?>
<CONSTITUENT>
  <BIRTHDATE>04/01/20005</BIRTHDATE>
  <PER_NAMES>
    <PER_NAME>
      <NAME_TYPE>PRF</NAME_TYPE>
      <COUNTRY_NM_FORMAT>001</COUNTRY_NM_FORMAT>
      <NAME>Smith, John</NAME>
      <LAST_NAME_SRCH>SMITH</LAST_NAME_SRCH>
      <FIRST_NAME_SRCH>JOHN</FIRST_NAME_SRCH>
      <LAST_NAME>Smith</LAST_NAME>
      <FIRST_NAME>John</FIRST_NAME>
    </PER_NAME>
  </PER_NAMES>
</CONSTITUENT>
```

```

    <PER_NAME>
      <NAME_TYPE>PRI</NAME_TYPE>
      <COUNTRY_NM_FORMAT>001</COUNTRY_NM_FORMAT>
      <NAME>Smith, John</NAME>
      <LAST_NAME_SRCH>SMITH</LAST_NAME_SRCH>
      <FIRST_NAME_SRCH>JOHN</FIRST_NAME_SRCH>
      <LAST_NAME>Smith</LAST_NAME>
      <FIRST_NAME>John</FIRST_NAME>
    </PER_NAME>
  </PER_NAMES>
  <EMAIL_ADDRESSES>
    <EMAIL_ADDRESS>
      <E_ADDR_TYPE>HOME</E_ADDR_TYPE>
      <EMAIL_ADDR>john.x2.smith@psunv.edu</EMAIL_ADDR>
      <PREF_EMAIL_FLAG>Y</PREF_EMAIL_FLAG>
    </EMAIL_ADDRESS>
  </EMAIL_ADDRESSES>
  <ADDRESSES>
    <ADDRESS>
      <ADDRESS_TYPE>HOME</ADDRESS_TYPE>
      <COUNTRY>USA</COUNTRY>
      <ADDRESS1>1234 Fifth Street</ADDRESS1>
      <CITY>Newton</CITY>
      <STATE>PA</STATE>
      <POSTAL>12346</POSTAL>
    </ADDRESS>
  </ADDRESSES>
  <PERSON_DATA_EFFDTS>
    <PERS_DATA_EFFDT>
      <SEX>M</SEX>
    </PERS_DATA_EFFDT>
  </PERSON_DATA_EFFDTS>
  <PERS_NIDS>
    <PERS_NID>
      <COUNTRY>USA</COUNTRY>
      <NATIONAL_ID_TYPE>PR</NATIONAL_ID_TYPE>
      <NATIONAL_ID>556-16-5443</NATIONAL_ID>
    </PERS_NID>
  </PERS_NIDS>
  <PERSON_SAS>
    <PERSON_SA>
      <FERPA>N</FERPA>
    </PERSON_SA>
  </PERSON_SAS>
</CONSTITUENT>

```

2. Determine valid fields and values.

An XML file consists of a top-level tag `<?xml version="1.0"?>`, followed by one top-level tag `<CONSTITUENT>`. The `</CONSTITUENT>` tag ends the `<CONSTITUENT>` tag. Note that it has a leading slash after the opening bracket. The `<CONSTITUENT>` tag represents the Constituent entity. See the navigation to entities: **Setup SACR > System Administration > Entity > Entity Registry**. There are child tags with the `<CONSTITUENT>` tag that represent the child entities of the Constituent entity.

3. Issue a curl command to submit the POST request.

```

# input...
> curl -X POST --data @C:\Temp\SCC_STG_CONSTIT_REQ_R-POST-1.xml -v --user
PS:PS http://<hostname>:<port>/PSIGW/RESTListeningConnector/<dbname>/SCC_STG_C=>
ONSTIT_R.v1/CONSTITUENT/

```

```
# output...
```

Note: Unnecessary use of `-X` or `--request`, `POST` is already inferred.

```

...
* Server auth using Basic with user 'PS'

```

```

> POST /PSIGW/RESTListeningConnector/<dbname>/SCC_STG_CONSTIT_R.v1/
CONSTITUENT/ HTTP/1.1
...
> User-Agent: curl/8.0.1
> Accept: */*
> Content-Length: 1629
> Content-Type: application/x-www-form-urlencoded
>
< HTTP/1.1 201 Created
< Date: Fri, 01 Sep 2023 21:42:02 GMT
< Content-Length: 180
< Content-Type: application/xml; encoding=UTF-8
...
<
<?xml version='1.0'?><CONSTITUENT xmlns="http://xmlns.oracle.com/
Enterprise/Tools/schemas/SCC_STG_CONSTIT_R.SCC_STG_CONSTIT_RESP_R.v1">
<SCC_TEMP_ID>102</SCC_TEMP_ID></CONSTITUENT>
...

```

4. Run the Transaction Management process.

- From the Selection Parameters page, make sure to select **Process Saved Transaction**.
- From the Search/Match Parameters page, use these parameters:
 - Search Parameter: LNFNNIDSEXDOB
 - Search Result Code: Use the result code of your preference. For example, PSCS_TRAD_RESUL.
 - Duplicate Rule: NIDONLY

5. Check the process log. Make sure the process was successfully completed.

6. Check suspended transactions.

The Search/Match/Post processes zero or more transactions, where a transaction is a one-person constituent structure within the staging table structure. It has one temp ID associated with it. Some of the transactions may be set to "Suspended" status if the search/match/post rule so indicates. A suspended transaction isn't applied to the production tables because there are errors associated with suspended transactions. You would then research and correct the causes of these errors. For example, if it's the same national ID but has a different name.

- a. Select the suspended transaction, then click **Search/Match Results** link to find out why this happened.
- b. Look at the duplicates. Check for duplicate national IDs (NID).
- c. If there are no duplicate NIDs, check for duplicate names.
- d. If there are many duplicate names, verify the suspend rule on first name and last name duplicates.
- e. Edit the transaction: in Constituent Status, select **Add New ID**.
- f. Rerun the Transaction Management Process using the same search/match parameters. The process should run successfully, and the transaction log shows that the transaction was posted.
- g. Take note of the new ID that was created.

- h. Look up the new person (**Campus Community > Personal Information > Add/Update a Person.**) and verify that this person has correct data.

Chapter 22

Setting Up Student Groups

Understanding Student Groups

Student groups enable you to define groups of similar students at a high level, such as athletes, student body officers, or honor students. Creating groups of students enables you to track and use the students within a group for campus-wide processing, such as billing, academic advising, or financial aid awarding.

Note: You can assign only students from the same institution to a student group.

Student group security enables you to assign student groups to a user ID. At least one user ID should have update access to a student group for assignment and processing purposes.

Mass assignment allows a user to create, or update multiple students using a single run control process. Mass assignment is now available for student groups. The process incorporates population selection along with the ability to assign individual ID's for student group assignment.

Users can also view the student groups to which they have access, either by student or by group.

Setting Up a Student Group

To set up a student group, use the Student Group Table component (STDNT_GROUP_TBL).

The system does not deliver any predefined student groups, so you need to define your own to meet your institution's needs. You can add one or multiple groups. Each group will need a enter a unique four-character letter identifier such as ATHL for Athletics, EXTL for external student, or ACDX for Academic Excellence.

Page Used to Set Up a Student Group

<i>Page Name</i>	<i>Definition Name</i>	<i>Navigation</i>	<i>Usage</i>
Student Group Table	STDNT_GROUP_TABLE	Set Up SACR > Common Definitions > Student Group Table	Set up a new student group or view an existing student group definition.

Setting Up a Student Group

Access the Student Group Table page (**Set Up SACR > Common Definitions > Student Group Table**).

<i>Field or Control</i>	<i>Description</i>
Effective Date	Enter the date the student group is created.

Setting Up Student Group Security

To set up security for a student group user ID, use the Student Group Security component (SCRTY_TBL_STGP).

This section discusses how to set up user ID security access for student groups.

Page Used to Set Up Student Group Security

<i>Page Name</i>	<i>Definition Name</i>	<i>Navigation</i>	<i>Usage</i>
Student Group Security	SCRTY_TBL_STGP	Set Up SACR > Security > Secure > Student Administration > User ID > Student Group Security	Set up the user ID security access for student groups. Modify a user ID's student group security access.

Setting Up a User ID's Student Group Security

Access the Student Group Security page (**Set Up SACR > Security > Secure Student Administration > User ID > Student Group Security**).

Security Settings

<i>Field or Control</i>	<i>Description</i>
Student Group	Enter the student group to which the ID should have access.
Inquiry Indicator	Select to allow the user to view this student group.
Update Indicator	Select to allow the user to view and modify this student group. The system automatically selects the Inquiry Indicator when you select the Update Indicator check box.

You can add an additional five user ID security access for student groups.

See “Replacing User Security” (Campus Solutions Application Fundamentals).

Viewing a Student Group by Group

To view a student group by group, use the View Student Groups by Group component (STDNT_GROUPS_INQG).

This section discusses how to view a student group by group.

Page Used to View a Student Group by Group

<i>Page Name</i>	<i>Definition Name</i>	<i>Navigation</i>	<i>Usage</i>
View Student Groups by Group	STDNT_GROUPS_INQG	Set Up SACR > Common Definitions > View Student Groups by Group	Display student groups to which you have access, by group.

Viewing Student Groups by Group

Access the View Student Groups by Group page (**Set Up SACR > Common Definition > View Student Groups by Group**).

<i>Field or Control</i>	<i>Description</i>
Select Effective Dates	<p>Enter the type of effective dates to view. Values are:</p> <p><i>All</i>: Returns all student groups and displays all effective-dated rows for each group.</p> <p><i>Most Current (Any Status)</i>: Returns all student groups and displays only the most current effective-dated row, regardless of status.</p> <p><i>Most Current Active</i>: Displays the most current active student group row.</p> <p><i>Most Current Inactive</i>: Displays the most current inactive status student group row.</p>
Get Results	Click to view the list of student groups that match the selected effective date search criteria.

Manually Assigning a Student to Student Groups

To manually assign a student to a student group, use the Student Groups component (STDNT_GROUPS_PERS).

This section discusses how to manually assign a student to student groups.

You can access the Student Groups page through multiple navigation paths. The primary path appears first.

Page Used to Manually Assign a Student to Student Groups

<i>Page Name</i>	<i>Definition Name</i>	<i>Navigation</i>	<i>Usage</i>
Student Groups	STDNT_GROUPS_PERS	<ul style="list-style-type: none"> • Records and Enrollment > Career and Program Information > Student Groups • Student Recruiting > Maintain Prospects > Academic Information > Student Groups • Student Admission > Application Entry > Academic Information > Student Groups 	Activate, inactivate, or delete a student from a student group.

Assigning a Student to a Student Group

Access the Student Groups page (**Records and Enrollment > Career and Program Information > Student Groups**).

<i>Field or Control</i>	<i>Description</i>
Student Group	Enter the student group to which you want to assign the student.
Effective Date	Enter the date the assignment to the group takes effect.
Status	Enter <i>Active</i> or <i>Inactive</i> .
Comments	Enter comments for your reference about the student group.
Last Update Date/Time	Displays the date and time the record was updated.
Updated By	Displays the user ID responsible for updating the student group.
Type	Indicates whether the record was processed manually or by mass update. When updated through the mass process, the program name appears.

Assigning a Group of Students to a Student Group

To run the process to assign a group of students to a student group, use the Process Student Group component (SCC_RUN_STD_GRP).

The process for assigning a group of students to a student group can be run with or without Population Selection selected. If you use the **Population Selection PS Query** option, you must include the STDNT_GRP_BIND record in the query to place it in the list of eligible queries on the Process Student Group page.

This section discusses how to run the student group process.

Page Used to Assign a Group of Students to a Student Group

<i>Page Name</i>	<i>Definition Name</i>	<i>Navigation</i>	<i>Usage</i>
Process Student Groups	SCC_RUN_STD_GRP	Records and Enrollment > Career and Program Information > Process Student Groups	Run the Student Group process to assign a group of students to a student group.

Running the Student Group Process

Access the Process Student Groups page (**Records and Enrollment > Career and Program Information > Process Student Groups**).

This example illustrates the fields and controls on the Process Student Groups page. You can find definitions for the fields and controls later on this page.

Process Student Groups

Run Control ID: PS [Report Manager](#) [Process Monitor](#) Run

Population Selection

Population Selection

Selection Tool: [Edit Prompts](#)

Equation Name: [Edit Equation](#) [Preview Selection Results](#)

Student Group Data

*Academic Institution: PeopleSoft University Update Tuition Calc Required

*Student Group: Athlete

*Effective Date:

*Effective Status:

Comment:

Student Override

Student Override Clear Data

Empl ID	Name	Effective Date	Effective Status		
1	<input type="text"/>	08/12/2013	Active	<input type="button" value="+"/>	<input type="button" value="-"/>

Population Selection

This group box appears when the *Population Selection* process is selected.

Population selection is a method for selecting the IDs to process for a specific transaction. The Population Selection group box is a standard group box that appears on run control pages when the Population Selection process is available or required for the transaction. Selection tools are available based on the selection tool that your institution selected in the setup of the Population Selection process for the application process and on your user security. Fields in the group box appear based on the selection tool that you select. The fields behave the same way from within the group box on all run control pages and application processes.

If your institution uses a specific delivered selection tool (PS Query, Equation Engine equation, or external file) to identify IDs for a student group transactions, you must use it.

See [Using the Population Selection Process](#).

Student Group Data

Field or Control	Description
Academic Institution	Displays the user's default institution. You can change this value. The process selects IDs only from the institution specified in the Academic Institution field.
Student Group	Enter the student group for mass ID assignment.
Effective Date	Enter an effective date to use for all of the IDs assigned to the student group during this run of the process. The default value is the current system date.
Effective Status	Select <i>Active</i> or <i>Inactive</i> .
Update Tuition Calc Required	Select the check box if you want this process to update STDNT_CAR_TERM.TUIT_CALC_REQ to <i>Y</i> for terms that are equal to or greater than the effective date on the Student Group. See "Calculating Tuition for a Single Student" (Student Financials).
Comment	Enter a comment that you want to assign to each student for the process.

Student Override

You can use the student override function to enter student IDs individually for assignment to a student group. You can use this function in conjunction with the Population Selection option. If you use both features, the student override function processes first. If duplicate IDs exist in the student override function and the population selection function and the effective dates are the same, only one row will be inserted using the student override status, regardless of status. If the effective dates differ, then a row will be inserted for each process instance.

Field or Control	Description
Student Override	Select to enable overrides and to display fields where you can specify the IDs to override.
Empl ID	Enter the student's ID.

<i>Field or Control</i>	<i>Description</i>
Effective Date	<p>Enter an effective date for each ID for the process instance. The effective dates can be different for each ID.</p> <p>The default value is the effective date that appears in the Student Group Data group box. If you enter a new date in this field, then this date will be provided by default to each record entered.</p>
Effective Status	<p>Enter the status for each ID for the process instance. The status can be different for each ID.</p>

Viewing Student Groups by Student

To view a student group by student, use the View Student Groups by Student component (STDNT_GROUPS_INQS).

This section discusses how to view a student group by student.

Page Used to View a Student Group by Student

<i>Page Name</i>	<i>Definition Name</i>	<i>Navigation</i>	<i>Usage</i>
View Student Groups by Student	STDNT_GROUPS_INQS	Records and Enrollment > Career and Program Information > View Student Groups by Student	Display student groups to which you have access, by student.

Viewing a Student Group by Student

Access the View Student Groups by Student page (**Records and Enrollment > Career and Program Information > View Student Groups by Student**).

Field or Control	Description
Select Effective Dates	<p>Enter the type of effective dates to view. Values are:</p> <p><i>All:</i> Returns all student groups and displays all effective-dated rows for each group.</p> <p><i>Most Current (Any Status):</i> Returns all student groups and displays only the most current effective-dated row, regardless of status.</p> <p><i>Most Current Active:</i> Displays the most current active student group row.</p> <p><i>Most Current Inactive:</i> Displays the most current inactive status student group row.</p>
Range Selection	<p>Enter a range of student groups to view. Values are:</p> <p><i>No Range Selection:</i> Displays the ID From and ID To fields. Unhide the Last Name From and Last Name To fields. Entering a Last Name From 'A' and Last Name To 'D' will return records with last names beginning with A to C and exclude D.</p> <p><i>Select Emplid Range:</i> Displays the ID From and ID To fields. Enter 0001 in the ID From field and 0010 in the ID To field to view records with IDs from 0001 through 0010.</p> <p><i>Select Last Name Range:</i> Displays the Last Name From and Last Name To fields. If you enter <i>A</i> in the Last Name From field and <i>D</i> in the Last Name To field, the system will return records with last names beginning with A through C but excluding D.</p>
Get Results	<p>Click to display the list of students in the specified student group that matches the search criteria you entered.</p>
Details	<p>Click to view additional details about the ID. You will be transferred to a student group page view in correction mode. You can make changes in this view. If you make changes and click the Apply button so the View Student Groups by Student page appears. You must refresh the View Student Groups by Student page to view your changes. You can also click the OK or Cancel button to display the View Student Groups by Student page.</p>

Setting Up Communications

Understanding Communications Setup

Important! Letter Generation (Letter Gen) is a deprecated product. It is strongly recommended that you use Communication Generation (Comm Gen) instead. For more information on Comm Gen, see [Understanding the Communication Generation Process](#)

To set up communications, use the following components: Standard Letter Table (SA_STNDR_LTR_TABLE), Communication Context Table (COMM_CTXT_TBL), Communication Category Table (COMM_CATG_TBL), Communication 3C Groups (COMM_GRP_3C_TBL), and Communication Speed Key Table (COMM_SPEED_KY_INST).

Use the Communication Contexts (SCC_COMM_CTXT_TBL) and Communication Categories (SCC_COMM_CATG_TBL) component interfaces to load the data into the tables for these components.

Use the Communication Data Source (SCC_CG_DTASRC) and Report Definition (PSXPRPTDEFN) components to set up the Communication Generation process.

Before you can assign communications to individuals, organizations, or groups of individuals, you must identify the letter codes and methods to use and set up the contexts and categories. You will also want to create 3C groups to control security access to communications, and define Communication Keys (Comm Keys) to streamline communication data entry.

A letter code must exist for each template that you plan to use. A letter code links extracted data to a template created to be used with the Letter Generation (Letter Gen) process or with the Communication Generation (Comm Gen) process. You can also use letter codes to group letters to send as enclosures. The PeopleSoft system delivers sample letter templates in Microsoft Word. You can use the sample templates as they are, modify them, or create your own.

Warning! Some processes are dependent on the predefined letter codes and their templates. Read the documentation carefully and check with your administrator before modifying a predefined letter code or template.

You must create communication contexts and group them into communication categories to set up communication management. Communication contexts are broad groupings that indicate the type of communication and how it was sent or received. Methods include letter, phone call, fax, email, and in person. You can specify more than one method of communication for each context. For example, if students can contact your institution by letter, email, or phone to confirm admission acceptance, you might create an Admissions Acceptance communication context that includes all three methods.

A communication category is a broad grouping of communication contexts that generally indicates why a communication was sent or received. For example, you might create an Admissions communication category that includes the following communication contexts: application received, admission acceptance, admission decline, admission deferral, frosh admit, frosh deny, and so on, or you might decide to create

more detailed communication categories such as Frosh Recruit, Frosh Admission, Graduate Recruit, and Graduate Admission.

Use communications 3C groups to grant groups of users inquiry or update security access to the categories of communications in your database.

Use Comm Keys (communication speed keys) to create a shorthand method of specifying common communication data. With the controls in place—standard letter codes, communication methods, communication directions, communication contexts, and communication categories—you can set up Comm Keys to combine these controls with a number of defaults into one shortcut page control.

Note: Comm Keys are required if you plan to use the 3C engine process to assign communications to individuals or organizations.

The following table lists the features of Letter Generation and Communication Generation processes. Letter Generation is deprecated. You are encouraged to use the richer functionality included with Communication Generation.

<i>Feature or Capability</i>	<i>Letter Generation</i>	<i>Communication Generation</i>
Process Type	SQR	Application Engine
Person ID, Org ID, Both	Y	Y
Communications Recipients	Y	Y
Joint Communications	Y	Y
Enclosures	Y	Y
Include Checklist Items	Y	Y
Update Checklist	Y	Y
Print Comment	Y	Y
Communication Methods	Letter-only	Letter, Email
Preferred Communication Method	N	Y
Communication Language	Base language	Multiple languages or specified language
Preferred Communication Language	N	Y
Extract Data	Generic list (delivered)	User-determined from data source and query

Feature or Capability	Letter Generation	Communication Generation
Missing Critical Data	Predefined	Configurable
View of Data Extracted	Communication Letter Data component	View Generated Communication link
Communication Management Component	Y	Y
Supported Output Formats	RTF, TXT	RTF, PDF (send-to-printer only) HTML (email format)
Template Creation	Microsoft Word	BI Publisher Template Builder
Organization Communications	Y	Y
Org Recipient Usage Table	N	Y
Include Checklists	One	Multiple
Checklist Code	One	Multiple
Checklist Type	One	Multiple
Tracking Group	One	Multiple
Item Status	Hard Coded	Selectable
Preview Option	N	Y
Send to Printer	Y	Y
Sort Outputs	Y	Y
Generate Labels and Envelopes	Y (using Microsoft Word)	Y
Oracle BI Publisher	N	Y

Related Links

[Understanding the 3C Engine](#)

[Using the Letter Generation Process](#)

[Understanding the Communication Generation Process Setup](#)

“Setting Up 3C Group Security” (Campus Solutions Application Fundamentals)

Prerequisites for Setting Up Communications

Before designing your communication structure, do the following to analyze your functional areas and institutional needs for tracking and scheduling communications for individuals and for external organizations:

- Understand the use of administrative functions and 3C groups and make sure they are set up properly.
- Identify all incoming, outgoing, and in-person contacts to track.
- Identify the various types of contact (for example, phone, letter, email, and fax) that your institution wants to track.
- Set up usages for names, addresses, and salutations.

Related Links

[Reviewing Administrative Functions](#)

[Understanding Communication Management](#)

[Designing Campus Community](#)

Defining Letter Codes

Important! Letter Generation (Letter Gen) and Financial Aid Notification (FAN) letter are deprecated products. It is strongly recommended that you use Communication Generation (Comm Gen) instead. For more information on Comm Gen, see [Understanding the Communication Generation Process](#)

To define letter codes, use the Standard Letter Table CS (SA_STNDR_LTR_TABLE) component.

This section discusses how to define letter codes.

Page Used to Define Letter Codes

<i>Page Name</i>	<i>Definition Name</i>	<i>Navigation</i>	<i>Usage</i>
Standard Letters	SCC_STN_LTR_TBL	<ul style="list-style-type: none"> • Set Up SACR > Common Definitions > Communications > Standard Letter Table CS • Campus Community > Communications > Set up Communications > Standard Letter Table CS • Contributor Relations > Communications > Set Up Communications > Standard Letter Table 	Review or define the types of letters that your institution wants to generate by assigning a letter code and administrative function to each. You can also group letters to create enclosures.

Setting Up a Letter Code

Access the Standard Letters page (**Set Up SACR > Common Definitions > Communications > Standard Letter Table CS**).

This example illustrates the fields and controls on the Standard Letters page (1 of 2). You can find definitions for the fields and controls later on this page.

Standard Letters

Letter Code: CG

***Description:** **Short Description:**

Set Letter Code:

Processing Letter Details

***Function:**

Applicable to: **Person** **Organization**

***Letter Type:**

***Letter Printed Data:** **SQC Name:**

Joint Communications Allowed

Include Enclosures

Define Comm Gen Parameters

Enclosures

Find First 1 of 1 Last

*Seq. No:	*Enclosure Code:	Enclosure Type:	Enclosure Type:
<input type="text" value="1"/>	<input type="text" value="T02"/> <input type="text" value="Transfer Missng Appl Requirmnt"/>	Hardcopy	<input checked="" type="checkbox"/> Required

Comment:

This example illustrates the fields and controls on the Standard Letters page (2 of 2). You can find definitions for the fields and controls later on this page.

Template Selection

Find | View All First 1 of 2 Last

Report Name: QA_CSCGREPO CG Report [View Report Definition](#)

Data Source ID: QA_CS.CG_DATASOURCE

Template List

Find First 1-4 of 4 Last

Template ID	Description	Language	Method	Default
QA_CSCG_TEMPLATE_ENG	CG Template English	English	Letter	<input checked="" type="checkbox"/>
QA_CSCG_TEMPLATE_ENG_EMAIL	CG Template English Email	English	E-Mail	<input type="checkbox"/>
QA_CSCG_TEMPLATE_FRA	CG Template French	French	Letter	<input type="checkbox"/>
QA_CSCG_TEMPLATE_FRA_EMAIL	CG Template French Email	French	E-Mail	<input type="checkbox"/>

Warning! Be sure to use the Standard Letters page (SCC_STN_LTR_TBL) in the Standard Letter Table CS component (SA_STNDR_LTR_TABLE) for Campus Solutions letter codes and read the specific product documentation before modifying any letter code delivered within Campus Solutions. If you implement PeopleSoft HCM, you must use the HCM Standard Letter Table page (STANDARD_LTR_TBL) to set up letter codes for HCM form letters. Within Campus Solutions, you must be familiar with the scope of the PeopleSoft Financial Aid *FAN* code or template before modifying it. See:

“Creating the FAN Extract File and Producing the FAN Letter” (Financial Aid)

Field or Control	Description
Set Letter Code	<p>Select the category (such as Admit Letters, Inquiry Response Letters, Recruitment Letters, and so on) that best describes the group of letters that includes this letter code. This field is optional and for information only.</p> <p>Values for this field are delivered with your system as translate values. You can modify these translate values.</p>

Processing Letter Details

Field or Control	Description
Function	<p>Select the function, from the Administrative Function Table page, that identifies the variable data to extract for communications associated with this letter code.</p> <p>For example, if you are sending a letter to a freshman applicant under the function of <i>Student Term</i>, the variable data of Academic Career and Term are extracted for the communication. The variable data are set up in the Administrative Function table and cannot be modified.</p> <p>See Reviewing Administrative Functions.</p>
Applicable To	<p>When you select the function, the system indicates the types of IDs that can receive communications associated with that function by selecting the Person check box, the Organization check box, or both check boxes.</p> <p>If the function permits communications with both persons and organizations, both check boxes are available for editing. You can select or clear the check boxes to limit the communications to either persons only or organizations only.</p>

Field or Control	Description
Letter Type	<p>Select the check box for the desired output form for this letter. Values are:</p> <p><i>Hardcopy</i>: Does not allow the system to extract data or merge into a softcopy template. Indicates preprinted items, such as brochures or pamphlets.</p> <p><i>Softcopy</i>: Allows the system to extract data and merge into a softcopy template, which you can then print.</p> <p>Values for this field are delivered with your system as translate values. Do not modify these values in any way. Any modifications to these values could require substantial programming effort.</p>
Letter Printed Data	<p>Enter the type of extracted data for the process to save for historical purposes.</p> <p>The Letter Generation process saves the data that you specify and displays it on the Communication Letter Data page. You can select <i>All</i> to save all of the communication headers and their data, <i>Name/Address Data</i> to save only the name and address headers and their data, or <i>None</i> to save no data.</p> <hr/> <p>Warning! The Letter Generation process extracts a huge amount of data. Saving all of the communication headers and their data can cause the table to be huge and the Communication Letter Data page to take significant time to load.</p> <hr/> <p>The Communication Generation process either saves the generated output with all data or does not save the generated output. Select either <i>All</i> or <i>Name/Address Data</i> to store the sample output and make it available from the View Generated Communication link on the Person Communication Management or the Organization Communication Management components. Select <i>None</i> not to store a sample output or any data, in which case, the View Generated Communication link does not appear.</p> <p>See Understanding Communication Management.</p> <p>The values for this field are delivered with your system as translate values. Do not modify these values in any way. Any modifications to these values could require substantial programming effort.</p>

Field or Control	Description
SQC Name (structured query compiler name)	<p>Enter the name of the unique Structured Query Compiler (SQC), if any, required to generate additional variable data for communications associated with this letter code.</p> <p>The Letter Generation process uses the unique SQC to extract data into a letter template. You must modify the letter generation SQR (CCLTRGEN.sqr) to look for any SQCs that you specify here.</p> <hr/> <p>Warning! Do not modify the CCLTRWOL.SQC. The User Profiles Management process requires this SQC. Any modifications to this could require substantial programming effort.</p> <hr/> <p>The Communication Generation process does not use SQCs. It uses Application Classes or PS Query to extract specific fields.</p> <p>See Using the Communication Generation Process.</p>
Joint Communications Allowed	<p>Select to permit this letter to be addressed jointly to two people at the same address, provided that they have a relationship defined in your database that permits joint communications.</p> <p>The sample Microsoft Word template CCLTRJNT.doc is provided for use with joint communications generated by the Letter Generation process. For the Communication Generation process, examples are provided in the QA_CS_CC_LETTERCD_<letter code><language><method>.rtf template definitions.</p>
Include Enclosures	<p>Select to indicate that other letters must be grouped and sent with this letter. When selected, the Enclosures group box appears.</p>
Define Comm Gen Parameters (define communication generation parameters)	<p>Select to allow the Communication Generation process to generate communications with this letter code.</p> <p>Enable the Communication Generation process for letter codes that might be used as enclosures, too. If you do not enable the process for a letter code that is an enclosure, the process cannot produce it and will return an error.</p> <p>When selected, the Template Selection group box appears.</p>

Enclosures

This group box is available only when the **Include Enclosures** check box is selected. You can group a maximum of 10 letter codes as enclosures here. Letter codes from which to select must already exist on the Standard Letters page.

Field or Control	Description
Seq Number (sequence number)	<p>Displays the number of this enclosure in the list of enclosures for this letter. The system automatically enters the next sequential number for each enclosure that you add. You can override the numbers manually to reorder the list of enclosures.</p> <p>When you run the Letter Generation data extract process or the Communication Generation process, the process lists, in the order identified here, up to 10 enclosures on the main letter in the order identified here.</p>
Enclosure Code	<p>Enter the code for the letter to include as an enclosure.</p> <p>The letter codes available are those associated with the same function that you select for the main letter code. For example, if you select the function <i>ADMA</i> for the main letter code, the Enclosure Code prompt list displays the letter codes that exist and that are associated with the function <i>ADMA</i> on the Standard Letters page.</p>
Enclosure Type	<p>The system displays the type of output associated with the selected enclosure letter code, either <i>Softcopy</i> or <i>Hardcopy</i>.</p> <p>Both the Letter Generation and Communication Generation processes will extract data for an enclosure set to <i>Softcopy</i>. Both processes will extract the enclosure code descriptions whether they are set to <i>Hardcopy</i> or <i>Softcopy</i> and you can list them all as attachments in the main letter template. A hardcopy enclosure is a printed brochure or other item produced outside of your PeopleSoft system that you must insert to include as an enclosure.</p>
Required	<p>Select this check box to indicate that the specific enclosure must accompany the main letter at all times. Administrative users can remove optional enclosures when they assign the communication to an individual on the Communication Management page or to an organization on the Org Communication Management page.</p>

Field or Control	Description
Comment	Enter comments to further identify or describe this enclosure. Enclosure comments are for information purposes only. They will not be printed in the communication.

Template Selection

This group box is available only when the **Define Comm Gen Parameters** check box is selected. The fields are related to the Communication Generation process only.

Field or Control	Description
Report Name	<p>The system displays the name of the report definition associated with the specified letter code and administrative function. To replace a report, click the Report Name link next to it and select the desired report on the Look Up Report Name page. To add a report, add a new row and click Report Name, and select the desired report.</p> <p>The report names listed on the Standard Letters page when you save it are the report definitions that will be available on the Communication Generation process run control page for this letter code. Of those reports, only the reports to which the user has security access will be available to that user.</p> <p>Making multiple reports available can be useful if multiple users send different templates or personalized templates for the letter code. For example, for a letter code dedicated to sending admissions letters, Mary can use her own templates, which might be set in a Report Definition named <i>MaryAD</i>, and John can use personalized templates that might be set in a Report Definition named <i>John_Personal</i>. Based on the security in the Report Definitions, only John has access to the templates under <i>John_Personal</i>, and only Mary has access to templates under <i>MaryAD</i>. When generating the communication, John will be able to use only the Report Definitions to which he has access, and Mary will be able to use only the Report Definitions to which she has access.</p> <p>See Creating a Data Source File.</p>
Data Source ID and Template List	Displays the data source ID that is associated with the report name that you enter and lists the Template IDs available for merging with that data source.

Field or Control	Description
Description, Language, Method, and Default	<p>The system displays information about the templates available for this communication.</p> <hr/> <p>Note: The system will not allow you to save the Standard Letters page if a selected report name includes more than one template with the same language and method combination. The Communication Generation process evaluates the language and method combination to determine which template to use when multiple templates exist in a report definition.</p> <hr/>
View Report Definition	<p>Click to open a new browser window displaying the Report Definition search page. In the new browser window, enter the report name or other information about the definition that you want to view and click Search to access the Report Definition component for the report. View the definition to confirm that it is the definition that you want to make available and to preview the templates.</p> <p>You can make changes to the report definition.</p>

Defining Communication Contexts and Categories

Important! Letter Generation (Letter Gen) is a deprecated product. It is strongly recommended that you use Communication Generation (Comm Gen) instead. For more information on Comm Gen, see [Understanding the Communication Generation Process](#)

This section discusses how to:

- Define a communication context.
- Define a communication category.

Pages Used to Define Communication Contexts and Categories

<i>Page Name</i>	<i>Definition Name</i>	<i>Navigation</i>	<i>Usage</i>
Communication Context	COMM_CTXT_TABLE	<ul style="list-style-type: none"> • Set Up SACR > Common Definitions > Communications > Communication Context Table • Contributor Relations > Communications > Set Up Communications > Communication Context Table • Campus Community > Communications > Set Up Communications > Communication Context Table 	Create and define communication contexts.
Communication Categories	COMM_CATG_TABLE	<ul style="list-style-type: none"> • Set Up SACR > Common Definitions > Communications > Communication Category Table • Contributor Relations > Communications > Set Up Communications > Communication Category Table • Campus Community > Communications > Set Up Communications > Communication Category Table 	Define categories of communication contexts to indicate why a communication was sent or received.

Defining a Communication Context

Access the Communication Context page (**Set Up SACR > Common Definitions > Communications > Communication Category Table**).

This example illustrates the fields and controls on the Communication Context page . You can find definitions for the fields and controls later on this page.

Communication Context

Academic Institution: PSUNV PeopleSoft University

Communication Context: CG

Communication Context Description Find | View All First 1 of 1 Last

***Effective Date:** 01/01/1900 BY ***Status:** Active + -

***Description:** Communication Generation Test

Short Desc: CommGenTst

*Method	*Direction	Letter Code	Description	
E-Mail	Outgoing Communication	CG	Communication Generation Test	-
Letter	Outgoing Communication	CG	Communication Generation Test	-

Add

<i>Field or Control</i>	<i>Description</i>
Allow Any Term	<p>This appears <i>only</i> for the STRM administrative function.</p> <p>Select to allow any term to be selected in Variable Data rather than just the activated terms for the student.</p>

Communication Context Method

<i>Field or Control</i>	<i>Description</i>
Method	<p>Select the form of this communication (for example, letter, email, or phone call).</p> <p>A communication context can have multiple methods. For example, for the context of Award, you might send a letter and also make a phone call.</p> <p>Values for this field are delivered with your system as translate values. The <i>Letter</i> value is required for generating letters with the Letter Generation process; do not modify it. You can, however, modify any of the other method translate values.</p>
Direction	<p>Specify the direction of this communication, such as in person, incoming communication, or outgoing communication.</p> <p>Values for this field are delivered with your system as translate values. Except for the value of <i>Outgoing Communication</i>, you can modify these translate values.</p>

Field or Control	Description
Letter Code	Enter the code for this communication. The code specifies the variable data associated with this communication. The Letter Code field is available only when you specify <i>Outgoing Communication</i> in the Direction field. Available letter codes are from the Standard Letters page.

Defining a Communication Category

Access the Communication Categories page (**Set Up SACR > Common Definitions > Communications > Communication Category Table**).

This example illustrates the fields and controls on the Communication Categories page. You can find definitions for the fields and controls later on this page.

Communication Categories

Academic Institution: PSUNV PeopleSoft University

Communication Category: CG

Communication Category Description Find | View All First 1 of 1 Last

***Effective Date:** 01/01/1900 [31] ***Status:** Active + -

***Description:** Communication Generation Test

Short Description: CommGenTst

***Function:** ADMA [Q] Admissions Application

Communication Context	
*Context	Description
CG [Q]	Communication Generation Test -

Add

Note: Communication categories are assigned to communication 3C groups on the Communications 3C Groups page for the purpose of limiting access to the communications associated with those categories. Therefore, make your communication categories specific so that you have more flexibility to determine which users have access to which communications.

Communication Category Description

<i>Field or Control</i>	<i>Description</i>
Function	<p>Enter the functional area to include in this category. The function determines the variable data that will be associated with communications in this category.</p> <p>Available function codes are from the Administrative Functions page.</p>

Communication Context

<i>Field or Control</i>	<i>Description</i>
Context	<p>Enter each context to include in this category.</p> <p>Available context codes are from the Communication Contexts page.</p>
Description	<p>The system displays the long description of the context that you select. This value is from the Communication Contexts page.</p>

Warning! All contexts from the Communication Context page are available, regardless of whether they include a letter code associated with the same function as the communication category. For example, if you select a context that has a letter code associated with the ADMA function and a category associated with the PROP function, the letter code will not be available as a valid choice when you assign the communication on the Communication Management page.

Defining 3C Groups

This section discusses how to:

- Define a 3C update/inquiry group.
- Define a communication 3C group.

Pages Used to Define 3C Groups

<i>Page Name</i>	<i>Definition Name</i>	<i>Navigation</i>	<i>Usage</i>
3C Update/Inquiry Group Table	GRP_3C_TABLE	Set Up SACR > Common Definitions > 3C Update/Inquiry Group Table	Define a group of users who have similar needs and interests.

<i>Page Name</i>	<i>Definition Name</i>	<i>Navigation</i>	<i>Usage</i>
Communication 3C Groups	COMM_GRP_3C_TABLE	<ul style="list-style-type: none"> • Set Up SACR > Common Definitions > Communications > Communication 3C Groups • Contributor Relations > Communications > Set Up Communications > Communication 3C Groups • Campus Community > Communications > Set Up Communications > Communication 3C Groups 	Associate one or more 3C update/inquiry groups with a communication category.

Defining a 3C Update/Inquiry Group

Access the 3C Update/Inquiry Group Table page ((**Set Up SACR > Common Definitions > 3C Update/Inquiry Group Table**)).

This example illustrates the fields and controls on the 3C Update/Inquiry Group Table page. You can find definitions for the fields and controls later on this page.

3C Update/Inquiry Group Table

Academic Institution: PSUNV PeopleSoft University

3C Update/Inquiry Group: UGAD

***Description:**

Short Description:

Define a group of users who have similar needs and interests. You can then associate one or more 3C Update/Inquiry Groups with a communication category to create a Communication 3C Group.

Security Administrators give users security access based on 3C update/inquiry groups.

Related Links

“Setting Up 3C Group Security” (Campus Solutions Application Fundamentals)

Defining a Communication 3C Group

Access the Communication 3C Groups page (**Set Up SACR > Common Definitions > Communications > Communication 3C Groups**).

This example illustrates the fields and controls on the Communication 3C Groups page. You can find definitions for the fields and controls later on this page.

Communication 3C Groups

Institution: PSUNV PeopleSoft University

Category: CG Communication Generation Test

Function: Admissions Application

Update/Inquiry Group		
*Group	Description	
UADC <input type="text" value="UADC"/>	Undergrad Adm Counselors	<input type="button" value="-"/>
UADO <input type="text" value="UADO"/>	Undergrad Adm Operations	<input type="button" value="-"/>
UADS <input type="text" value="UADS"/>	Undergrad Adm Student Staff	<input type="button" value="-"/>
UGAD <input type="text" value="UGAD"/>	Undergraduate Admissions	<input type="button" value="-"/>

Update/Inquiry Group

<i>Field or Control</i>	<i>Description</i>
Group	Enter each group that should have access to this communication category. Available group codes are from the 3C Groups page.
Description	The system displays the long description, from the 3C Groups page, of the group that you select.

Related Links

“Selecting the Type of 3C Group Access” (Campus Solutions Application Fundamentals)

Defining Communication Speed Keys

This section discusses how to define communication speed keys as shortcuts for defining communications.

Page Used to Define Communication Speed Keys

<i>Page Name</i>	<i>Definition Name</i>	<i>Navigation</i>	<i>Usage</i>
Communication Speed Keys	COMM_SPDKEY_TABLE	<ul style="list-style-type: none"> • Set Up SACR > Common Definitions > Communications > Communication Speed Key Table • Contributor Relations > Communications > Set Up Communications > Communication Comm Key Table • Campus Community > Communications > Set Up Communications > Communication Speed Key Table 	Create Comm Keys for specifying common communication data.

Defining a Communication Speed Key

Access the Communication Speed Keys page (**Set Up SACR > Common Definitions > Communications > Communication Speed Key Table**).

This example illustrates the fields and controls on the Communication Speed Keys page. You can find definitions for the fields and controls later on this page.

Communication Speed Keys

Institution: PSUNV PeopleSoft University
Function: ADMA Admissions Application

Comm Key Detail Find | View All First 1 of 3 Last

*Comm Key:	GAPPACK	<input type="checkbox"/> Print Comment	+ -
*Description:	Graduate App Acknowledgement	<input type="checkbox"/> Activity Completed	
Short Desc:	GradAppAck	<input type="checkbox"/> Unsuccessful Outcome	
*Category:	GAPP 🔍 Grad Application Processing		
*Context:	GAPACK 🔍 Grad Appl Acknowledgment		
Duration:	<input type="text"/>		
*Method:	L 🔍 Letter	Direction: OUT 🔍	Letter Code: G01 🔍
Comments:	<div style="border: 1px solid gray; height: 20px; width: 100%;"></div>		

Field or Control	Description
Comm Key (communication key)	Enter the name of the communication speed key to represent this set of communication elements.
Category	Enter the communication category to associate with this communication speed key.
Context	Enter the communication context to associate with this communication speed key.
Duration	<p>Enter the average duration, expressed in minutes, for the type of communication that you are associating with this communication speed key. (Optional)</p> <p>Duration is usually used to specify the length of time for in-person communications (for example, the duration of a phone call).</p>
Method	<p>Specify the typical method of the communication that you are associating with this communication speed key. The <i>Letter</i> method is required when generating letters.</p> <p>Values for this field are delivered with your system as translate values. Except for the value of <i>Letter</i>, you can modify these translate values.</p>
Direction	<p>Specify the direction of the communication you are associating with this communication speed key. The <i>Outgoing Communication</i> direction is required when generating letters.</p> <p>Values for this field are delivered with your system as translate values. Except for the value of <i>Outgoing Communication</i>, you can modify these translate values.</p>
Letter Code	Enter the code, from the Standard Letters page, for the communication that you are associating with this communication speed key.
Comments	Enter comments to further describe or identify the communication to associate with this communication speed key.
Print Comment	Select this check box to include or print the comments on the Comments pages in the communication associated with this communication speed key.

Field or Control	Description
Activity Completed	<p>Select this check box to make the status of <i>Complete</i> available with this communication speed key.</p> <p>This option is useful when data for a communication is typically entered after the activity is completed. For example, if the communication is an incoming phone call or an incoming letter, then the communication is already complete when you report it in the system.</p>
Unsuccessful Outcome	<p>Select this check box to make the status of <i>Unsuccessful</i> available with this communication speed key.</p> <p>For example, if you were to hold a telephone fund-raising event, you might want to record each call to track your success rate. You could create two communication speed keys—one for successful phone calls and one for unsuccessful phone calls.</p>

Note: Before users can use the communication speed keys defined here, the communication speed key codes must be assigned in the users' defaults.

Related Links

“Setting Defaults for Communication Keys” (Campus Solutions Application Fundamentals)

Setting Up the Communication Generation Process

Important! Letter Generation (Letter Gen) is a deprecated product. It is strongly recommended that you use Communication Generation (Comm Gen) instead. For more information on Comm Gen, see [Understanding the Communication Generation Process](#)

To set up the Communication Generation process, use these components: Communication Data Source (SCC_CG_DTASRC), Report Definition (PSXPRPTDEFN), Organization Recipient Usage (ORG_RCP_USAGE), Name Usage Table (NAME_USAGE_TABLE), and Address Usage Table (ADDR_USAGE_TABLE).

This section provides an overview of setting up the Communication Generation process and discusses how to:

- Create a template.
- Create valid PeopleSoft queries and application classes.
- Create a data source file.
- Create a report definition.
- Define organization communication recipient usages.

Understanding the Communication Generation Process Setup

You can set up your PeopleSoft system to generate letters and emails using the Communication Generation process. The process uses Oracle BI Publisher included in PeopleSoft PeopleTools. To use Oracle BI Publisher with PeopleSoft Campus Solutions Communication Generation process, you must set up the elements as described in this section.

The concept of setting up the Communication Generation process includes the following steps:

1. Create a draft template and identify which variables to include.
2. For each variable, identify the corresponding record fields from which to get the data.
3. Create one or more queries or application classes to use to select the record fields.
4. Create a communication data source from within Campus Community and specify the queries or application classes to use for that data source.
5. Finalize the template using either the delivered Oracle BI Publisher template builder for Microsoft Word to create RTF templates or other software to create other template formats such as PDF by adding the variable tags from the data source.
6. Create a report definition to upload the template and associate it with the communication data source.
7. Associate a letter code with the report definitions that include the templates and communication data sources that you want to make available for generating the communication.

Pages Used to Set Up the Communication Generation Process

<i>Page Name</i>	<i>Definition Name</i>	<i>Navigation</i>	<i>Usage</i>
Communication Data Source	SCC_CG_DTASRC	<ul style="list-style-type: none"> • Campus Community > Communications > Set Up Communications > Communication Data Source • Set Up SACR > Common Definitions > Communications > Communication Data Source 	<p>Identify the source to use and specify the fields to extract data from that source. The extracted fields can be specific to one template or can be reused in multiple templates. Also use the Communication Data Source to identify what record fields the Communication Generation process should consider critical data for producing the outputs.</p> <hr/> <p>Note: For the Communication Generation process to succeed, you must create the data source from the Communication Data Source page in PeopleSoft Campus Community. Do not create the data source from within PeopleTools.</p>

Page Name	Definition Name	Navigation	Usage
Definition	PSXPRPTDEFN	Reporting Tools > XML Publisher > Report Definition	Define a report to associate the data source and the Oracle BI Publisher template. <i>See PeopleTools: BI Publisher for PeopleSoft</i>
Template	PSXPRPTMPL	Reporting Tools > XML Publisher > Report Definition > Template	Identify the Oracle BI Publisher templates into which to merge data from the source file. <i>See PeopleTools: BI Publisher for PeopleSoft</i>
Output	PSXPRPTOUT	Reporting Tools > XML Publisher > Report Definition > Output	Select the PDF option on the Output page to include report definitions that must be printed. PeopleTools Oracle BI Publisher supports only PDF files for printing. <i>See PeopleTools: BI Publisher for PeopleSoft</i>

Page Name	Definition Name	Navigation	Usage
Bursting	PSXPRPTBURST	Reporting Tools > XML Publisher > Report Definition > Bursting	<p>Enter the Burst By value to separate the outputs that the Communication Generation process generate.</p> <p>The value of <i>fld_CG_SORT_ORDER</i> is the only available or valid value for a Report Definition that is associated with a data source that was created through Campus Community's Communication Data Source component. If you enter a different value or if you leave the field blank, the Communication Generation process will force the bursting value to <i>fld_CG_SORT_ORDER</i> at run time.</p> <p>The process uses the bursting value for several reasons including to separate the outputs that it generates and send them to the printer according to the order specified on the Communication Generation run control page. Bursting and ordering are required for producing letter and email outputs from the Communication Generation process.</p> <p>See <i>PeopleTools: BI Publisher for PeopleSoft</i></p>
Org Communication Recipient Usage Table	ORG_RCP_USAGE	Set Up SACR > Product Related > Campus Community > Establish People Processing > Setup > Organization Recipient Usage > Org Communication Recipient Usage Table	Define usages for recipients of communications assigned to organizations when no recipient is specified.
Name Usage	NAME_USAGE_TABLE	Set Up SACR > Product Related > Campus Community > Establish People Processing > Setup > Name Usage Table	<p>Define name usages to specify the hierarchies of name types that you want to use in a specific usage.</p> <p>See Establishing Name Usages.</p>

Page Name	Definition Name	Navigation	Usage
Address Usage	ADDR_USAGE_TABLE	Set Up SACR > Product Related > Campus Community > Establish People Processing > Setup > Address Usage Table	Define or review address usages by specifying hierarchies of address types or email type to search for and use in a specific usage. See Establishing Address Usages .

Creating a Template

You cannot automatically convert a Microsoft Word letter template designed for the Letter Generation process to a template for the Communication Generation process. However, you can use the Letter Generation template to determine which record fields need to be extracted and include them in a communication data source for an Oracle BI Publisher template for Communication Generation process.

See *PeopleTools: BI Publisher for PeopleSoft*, "Creating Report Templates, Creating RTF Templates."

Creating Valid PeopleSoft Queries and Application Classes

Create queries or application classes to identify the record fields to use to extract data to place in a template. You assign queries and application classes to the communication data source that you associate with the letter code to use. You can reuse queries and application classes for different letter codes.

Queries

Use PeopleSoft Query Manager to create queries based on the administrative function used in the associated communication data source. The system evaluates each query when you register the communication data source and registers only the queries that it validates can be successfully executed by the Communication Generation process.

See *PeopleTools: Query*

If you require criteria to be supplied at run time, create query prompts and add them as criteria to your query definition. The process can accept only query prompts for retrieving person and organization IDs and their variable data associated with the administrative function that is specified in the communication data source. You can also include the Communication record in your query and use the SEQ_3C field as a prompt to access values from the Communication record.

Warning! You must include at least query prompts that retrieve person ID or organization ID or a combination of the two.

While creating the query, after identifying the fields to use as prompts, you must click the **Edit** button on the corresponding Prompts page of the Query Manager component, and change the value in the **Unique Prompt Name** field to a value that will prompt for the desired data. This is the only way the process will know what data to pass to the prompt list.

To prompt for person ID, enter the **Unique Prompt Name** of *PERSON_ID*. The typical key field for persons in transaction tables is EmplID. However, entering *PERSON_ID* enables the process to select

person data from tables with a different person ID key field. The process searches for *PERSON_ID* and assigns the *COMMON_ID* for person communications to the query prompt.

To prompt for organization ID, enter the **Unique Prompt Name** of *ORG_ID*. The typical key field for organizations in transaction tables is *EXT_ORG_ID*. However, entering *ORG_ID* enables the process to select organization data from tables with a different organization ID key field. The process searches for *ORG_ID* and assigns the *COMMON_ID* for organization communications to the query prompt.

To prompt for both person and organization ID, enter the **Unique Prompt Name** of *COMMON_ID*. The typical key field used in shared transaction tables is *COMMON_ID*. Entering *COMMON_ID* enables the process to select person and organization data from shared tables with a different common ID key field. The process searches for *COMMON_ID* and assigns the *COMMON_ID* for person and organization communications to the query prompt. The process uses the *SA_ID_TYPE* field at run time to place the *COMMON_ID* for the communication into the correct person or organization query prompt field.

To use values from the Communication table to join with other data tables in your query, you can create a prompt for the communication sequence field (*SEQ_3C*). For this field, enter the **Unique Query Prompt** of *SEQ_3C*. The process searches for *SEQ_3C* and assigns the *SEQ_3C* for the communication to the query prompt.

For example, to join to the Communication table in your query criteria, write:

```
select A.FIELD1, A.FIELD2
from PS_SCC_TABLE A, PS_COMMUNICATION B
where A.INSTITUTION = B.INSTITUTION
and A.EMPLID = B.COMMON_ID
and B.COMMON_ID = Query_Prompt1
and B.SEQ_3C = Query_Prompt2
```

This joins a transaction table *PS_SCC_TABLE*, which is keyed by *INSTITUTION* and *EMPLID*, to the *PS_COMMUNICATION* table to resolve the institution value for the communication being generated.

To use variable data from the communication to prompt for administrative function data, create a query prompt for the variable data fields associated with the administrative function specified in the communication data source. Enter the variable data field name in the **Unique Prompt Name** field. The process searches for the field name and assigns the variable data for the communication to the query prompt.

For example, assume that the communication data source uses the ADMA (Admissions Application) administrative function. ADMA has a dedicated table called *VAR_DATA_ADMA*. The variable data fields on the table that are assigned for this type of communication are *ACAD_CAREER*, *STDNT_CAR_NBR*, and *ADM_APPL_NBR*. To prompt for the *ACAD_CAREER* field, enter a **Unique Prompt Name** of *ACAD_CAREER*.

Warning! You must list each prompt that you create as criteria in the Criteria page of the Query Manager component.

After you create the query definitions, you can include them in a communication data source. When you click the **Register Data Source** button on the Communication Data Source component, the system evaluates each query and registers only the queries that are executable by the Communication Generation process. The system compares the setup of the query prompts with the information in the Data Source Context of the Communication Data Source as follows:

1. Validate Person/Organization check boxes:
 - Person only: Valid Unique Prompt Names include *PERSON_ID*, *COMMON_ID*, and *SEQ_3C*.

- Organization only: Valid Unique Prompt Names include *ORG_ID*, *COMMON_ID*, and *SEQ_3C*.
 - Person and Organization combined: Valid Unique Prompt Names include *PERSON_ID*, *ORG_ID*, *COMMON_ID*, and *SEQ_3C*.
2. Validate Administrative Function value: Valid Unique Prompt Names include the record.field *VAR_DATA_%.FIELDNAME* where % is the value of the administrative function used in the Data Source Context. The valid values are the field names used in the dedicated Variable Data table for the specified administrative function.

After registering the data in the Communication Data Source, the output from the query is appended at the end of the generated sample data file and is ready for use in an Oracle BI Publisher template.

Note: If you need to manipulate your custom extract data in ways that cannot be accomplished using PS Query, you can use PeopleTools Application Designer to create application classes (App Classes), which are also compatible with the Communication Generation process.

See *PeopleTools: PeopleCode API Reference*, "Application Classes."

Application Classes

Use PeopleTools Application Designer to create custom application classes to extract and manipulate data using standard PeopleTools logic. Each application class can be created with your own validation logic to assure that it can be successfully executed by the Communication Generation process.

See *PeopleTools: PeopleCode API Reference*, "Application Classes."

When you create a custom PeopleTools application class to use in a Communication Data Source, you must include methods required by the Communication Generation process. You can insert your own PeopleCode logic into the required methods to extract and manipulate the data to include in your Communication Data Source. You can also create and call your own methods in addition to the required methods.

The PeopleSoft system delivers a base application class called *CommGenDSAbstract* to use in the creation of all custom application classes for the Communication Generation process. This application class is never called directly, but provides the structure for creating all custom application classes for use with the process. The system also delivers a sample application class named *AppClassAdapter*, which was created from the base.

Follow these steps to access the base and sample application classes:

1. Open the *SCC_COMMGEN* application package in Application Designer.
2. Access the *Model* sub package.
3. Within the *Model* sub package, access the *CommGenDSAbstract* application class, which is the base application class.
4. Within the *Model* sub package, access the *DSAdapters* package.
5. Within the *DSAdapters* package, access the *AppClassAdapter* application class, which is the sample application class.

Follow these steps to create a custom application class that is valid for the Communication Generation process:

1. The application class must inherit the structure of the base *CommGenDSAbstract* application class.

For example, the sample application class *AppClassAdapter* implements `SCC_COMMGEN:Model:CommGenDSAbstract`.

2. At a minimum, you must use the following two methods:

- The `Validate` method `Method Validate(&strContext As string, &arrValidBindFields As array of any)` which will be called when the user clicks the **Register Data Source** button on the Communication Data Source page. No further validation code is required. The method will always be passed the Data Source Context (person, organization, or both) and an array of the variable data field names associated with the administrative function selected in the context.

For example, assume that you want to validate that the custom application class is used only in Communication Data Sources where only the **Person** check box is selected in the Data Source Context. The variable `&strContext` which is passed into the method contains each of the following values:

P for Person Communications

O for Organization Communications

PO for Person and Organization Communications combined.

You can issue an error message to the user if the context of the Communication Data Source is for organizations (*O*) or both (*PO*).

- The `BuildAdapterRowset` method `BuildAdapterRowset(&rowResult As Row, &booVarData As boolean) Returns Rowset` which will be called when the Communication Generation process runs. The method will always be passed a `PeopleCode` row object containing communication and variable data information for the communication in context. It will also be passed a Boolean value of *True* or *False* indicating whether the Communication Data Source uses an administrative function that contains variable data. While most administrative functions have associated variable data, some do not. For example, the GEN (general) administrative function does not.

This method will always return a rowset `PeopleCode` object to be appended to the extract data. The rowset object that you construct can be of any `PeopleTools` supported structure.

The *AppClassAdapter* example application class uses the keys from the communication (`COMMON_ID`, `SEQ_3C`) to join to the Communication table and extract the descriptions for the institution. This is the institution by which the communication was assigned.

Warning! You can create new application packages that contain any number of custom application classes for use in building custom extract data for the Communication Generation process, but you should not modify the delivered *SCC_COMMGEN* application package when creating your own custom application classes.

After you create the custom application classes, you can include them in a communication data source by selecting the **Type** of *App Class* on the Communication Data Source page. When you click the **Register**

Data Source button, the systems evaluates each application class and registers only the application classes that are executable by the Communication Generation process.

The system evaluates and validates each application class as follows:

1. Instantiate the custom App Class object.

If the path is incorrect or the application class does not exist, a standard PeopleTools error message appears stating that the object could not be opened.

2. Call the Validate method for the custom application class, and perform the code check, if any.

After registering the data in the Communication Data Source, output from the application classes is appended at the end of the generated sample data file and is ready for use in an Oracle BI Publisher template.

See:

- See *PeopleTools: PeopleCode API Reference*, "Application Classes."
- [Creating a Data Source File](#)

Creating a Data Source File

Access the Communication Data Source page (**Campus Community > Communications > Set Up Communications > Communication Data Source**).

This example illustrates the fields and controls on the Communication Data Source page (1 of 2). You can find definitions for the fields and controls later on this page.

Communication Data Source

*Data Source Map ID

Description

Object Owner ID

Data Source Type XMLDoc Object Active

Data Source Context

*Administrative Function Admissions Application Person Organization

Generic Process Data			
Sequence	Description	Sample Data Folder Name	Critical Data
1	List of Checklist Items	CHECKLIST_ITEMS	
2	List of Enclosures	ENCLOSURES	
3	Address for a person	PER_ADDRESS	<input checked="" type="checkbox"/>
4	List of Person Communication Recipients	PER_COMM_RECIP	
5	Email Address for Person	PER_EMAIL	<input type="checkbox"/>
6	Name for individual address	PER_NAME_ADDR	<input type="checkbox"/>
7	Name for extra use	PER_NAME_EXTRA	<input type="checkbox"/>
8	Name for individual salutation	PER_NAME_SAL	<input checked="" type="checkbox"/>
9	Name for joint salutation	PER_NAME_SALJNT	<input type="checkbox"/>

This example illustrates the fields and controls on the Communication Data Source page (2 of 2). You can find definitions for the fields and controls later on this page.

Custom Extract Data					Find	First	1-2 of 2	Last
Sequence	Type	Query Name	Max Nbr	Application Class				
1	Query	QA_CS_CC_COMMGEN_CG_F						
2	App Class			SCC_COMMGEN:Model:DSAdapters:AppClass				

Registered Date/Time 07/27/06 1:34:45PM **Registered By** PS
Last Update Date/Time 11/01/06 7:25:43PM **Last Update User ID** PS

[View/Download Sample Data File](#)

Field or Control	Description
Data Source Map ID	<p>Displays the unique mapping ID that links the Oracle BI Publisher data source to the Communication Generation process metadata.</p> <p>If you are creating a new data source, the system temporarily displays what you entered when you chose Add a New Value.</p> <p>When you click the Register Data Source button to save and register the data source, the system creates or updates the Data Source Map ID and displays it here.</p> <hr/> <p>Warning! For the Communication Generation process to run successfully, you <i>must</i> create and update the data source from within Campus Community as described in this section. Do <i>not</i> create the data source from within PeopleTools Oracle BI Publisher. The Register Data Source button on the Communication Data Source page in Campus Community automatically stores the data source inside the PeopleTools tables. This button also keeps the data source created within Campus Community synchronized with the information in the PeopleTools tables for you.</p>
Object Owner ID	(Optional) Enter the PeopleSoft product responsible for this data source and the map ID.
Data Source Type	<p>Displays <i>XMLDoc Object</i>, which is the only type of object that the Communication Generation process processes. You cannot change this value.</p> <p>The system requires this information to access the data source from the Tools Data Source component Oracle BI Publisher.</p>
Active	Select to make the data source active and available to users. Clear to preserve the definition but prevent the data source from being available to users.

Data Source Context

Information in this group box shows in which context the data source can be used.

Field or Control	Description
Administrative Function	<p>Enter the administrative function to use for this data source.</p> <p>The administrative function is used to filter which data source will be available for which Letter Code. The value selected identifies whether the communication can be sent to a person, an organization, or both.</p>
Person and Organization	<p>The system indicates the types of IDs that can receive communications based on the administrative function.</p> <p>If the function permits communications with both persons and organizations, both check boxes are available for editing. You can select or clear the check boxes to limit the communications to either persons only or organizations only.</p>

Generic Process Data

The system lists the generic data that the Communication Generation process must always extract to accommodate all of the Campus Solutions communication features. The data varies depending on whether the context is for a person, an organization, or both. Each of the features is associated with the names of the records into which the extracted data will be placed for the Oracle BI Publisher templates. You can prioritize the order of the records using sequencing, but you cannot add or delete any of them.

Click the **Critical Data** check box to identify the generic data to include as critical to the creation of the output for individual or organization recipients. On the run control page, administrative users can specify what to do if critical data is missing: either to process the communication without the data or not to process the communication for IDs that are missing the data. Checklists, enclosures, and person communication recipients cannot be specified as critical data.

Custom Extract Data

You can use queries or application classes to identify additional data to extract. You can use multiple queries, application classes, or combinations of both.

Field or Control	Description
Type	<p>Enter the type of tool to use to identify the data to extract, either <i>Query</i> or <i>App Class</i>.</p> <p>Do not add values or modify the delivered values.</p>

Field or Control	Description
<p>Query Name or App Class Name</p>	<p>The field name changes based on the Type selected, either <i>Query</i> or <i>App Class</i>.</p> <p>For the Query Name field, available values are limited to queries to which the user has security access. The Register Data Source feature evaluates each query and registers only the queries that it validates to as executable by the Communication Generation process.</p> <p>For the App Class Name field, enter the application class in the same format as the sample application class, which is <i>SCC_COMMGEN:Model:DSAdapters:AppClassAdapter</i>.</p> <p>See Creating Valid PeopleSoft Queries and Application Classes.</p>
<p>Max Nbr (maximum number)</p>	<p>(For queries only.) Enter the maximum rows of data for the query to extract.</p> <hr/> <p>Note: To extract all the possible values for an ID, leave the Max Nbr field blank. For example, if your query includes the ACAD_CAREER field and an ID has an application for 5 different academic careers, when the field is blank the query will extract 5 of the values. If you want to extract only 2 values, set the maximum number to 2.</p> <hr/> <p>The MaxNbr field on the Communication Data Source page does not apply when you are using an application class for custom extract data. PeopleTools does not support the ability to restrict the number of rows selected into a Standalone Rowset by simply passing a maximum number into the Rowset Fill method. You can control the number of rows of data to append to the extract either within the selection criteria or by manipulating the Standalone Rowset after it has been filled.</p>

Field or Control	Description
View/Download Sample Data File	<p>Available only after the data source is registered.</p> <p>Click to view the Oracle BI Publisher file to determine where the sample data placeholders are for the data to extract.</p> <p>You must download the Oracle BI Publisher file and load it into the XML templates using the delivered design helper tool. The file contains all the fields that the Communication Generation process will extract. You can include these fields as variables in your templates. The collapsible sections in the XML file correspond to the folder names listed in the Generic Process Data group box in the Communication Data Source page. If the Communication Data Source includes a query or application class, the query or application name appears in the list at the end of the XML file.</p> <p>See <i>PeopleTools: BI Publisher for PeopleSoft</i>, "Creating Report Templates."</p>
Register Data Source	<p>Click to create or update the data source ID in the PeopleTools record. When you do, the Register Data Source button becomes unavailable, the View/Download Sample Data File link appears, and the system populates the audit information fields with the date and the user ID who registered the data.</p> <p>To ensure that the data source created in the Campus Community component remains synchronized with the data source stored in the PeopleTools record, each time you make a change to the Campus Community data source, the system hides the View/Download Sample Data File link, reactivates the Register Data Source button and displays a message telling you to click the Register Data Source button to update the Oracle BI Publisher data source. When you click the Register Data Source button again, the system recreates the sample data file and updates the PeopleTools record for you.</p> <p>You can make as many changes as you want, but you must register the data source again for the system to accept and use the changes and for the system to update the Data Source Map ID in the PeopleTools record.</p>

Creating a Report Definition

You must define a report and associate with it, the communication data source from which to extract data and the Oracle BI Publisher templates into which you want to merge the extracted data. Report definitions are a function of PeopleTools Oracle BI Publisher **Reporting Tools > XML Publisher > Setup > Report Definition**.

You must associate the report definition with the letter code to use so that the Communications Generation process knows which template and data source to use to create the communication.

See:

- [Creating a Report Definition](#)
- [Defining Letter Codes](#)
- [Using the Communication Generation Process](#)

Defining Organization Communication Recipient Usages

Access the Org Communication Recipient Usage Table page (**Set Up SACR > Product Related > Campus Community > Establish People Processing > Setup > Organization Recipient Usage > Org Communication Recipient Usage Table**).

This example illustrates the fields and controls on the Org Communication Recipient Usage Table page. You can find definitions for the fields and controls later on this page.

Org Communication Recipient Usage Table					
Org Recipient:	ALLCHOICES				
*Description:	All Choices_Test				
Usage Definition					
*Usage Order	*Usage Type	*Recipient Option	Contact Type		
10	Contact	Primary		+	-
20	Contact	Preferred	Academic Advisor	+	-
30	Contact	Preferred		+	-
40	Contact	All	Director of Catering	+	-
50	Contact	All		+	-
60	Department	Primary		+	-
70	Department	All		+	-
80	Location	Primary		+	-
90	Location	All		+	-

Set up prioritized usages for the Communication Generation process to use to identify recipients if no recipients are specified on the Org Communication Management page.

Enter a **Usage Type** to send the communication to a *Contact*, *Department*, or *Location* for an organization.

After you select the **Usage Type**, use the **Recipient Option** field to specify whether to send the communication to *All*, to the *Preferred*, or to the *Primary* contact, department, or location.

If you select a **Recipient Option** of *Contact*, use the **Contact Type** field to specify the type of contact. For example, to define a usage order to send the communication to all contacts who are academic advisors, enter a **Usage Type** of *Contact*, a **Recipient Option** of *All*, and a **Contact Type** of *Academic Advisor*.

Usage Type, Recipient Option and **Contact Type** values are translate values. They should not be modified.

Related Links

[Designing Campus Community](#)

Setting Up Comments

Understanding Comment Setup

To attach comments to records, you must first create comment categories and associate them with 3C groups to define who, at your institution, has the security access to write, review, or change comments.

You can assign comments to individuals and organizations manually, or you can use the 3C engine to automatically assign comments to individuals or organizations based on rules and conditions that you define.

See [Defining 3C Engine Triggers](#).

Prerequisites for Setting Up Comments

Before defining comment categories and associating them with 3C groups, you must understand and set up administrative codes, 3C group security, and assign individuals to specific 3C groups.

Related Links

[Reviewing Administrative Functions](#)

“Setting Up 3C Group Security” (Campus Solutions Application Fundamentals)

[Understanding the 3C Engine](#)

Common Elements Used to Set Up Comments

<i>Field or Control</i>	<i>Description</i>
Administrative Function	The code for the administrative area with which the comment category is associated.
3C Group	The comment group to which a user has security access.

Setting Up Comment Categories

To set up comment categories, use the Comment Category Table component (CMNT_CATG_TBL).

This section discusses how to define comment category codes.

Page Used to Set Up Comments

<i>Page Name</i>	<i>Definition Name</i>	<i>Navigation</i>	<i>Usage</i>
Comment Categories	CMNT_CATG_TABLE	<ul style="list-style-type: none"> • Set Up SACR > Common Definitions > Comments > Comment Category Table • Campus Community > Comment > Set Up Comments > Comment Category Table 	Define categories that enable you to group comments for similar purposes.

Defining Comment Category Codes

Access the Comment Categories page (**Campus Community > Comment > Set Up Comments > Comment Category Table**).

This example illustrates the fields and controls on the Comment Categories page. You can find definitions for the fields and controls later on this page.

Comment Categories

Academic Institution: PSUNV PeopleSoft University

Comment Category: GEVL

Category Details

*Effective Date: 01/01/1900 *Status: Active + -

*Description: Graduate Evaluations

Short Description: Grad Eval

*Administrative Function: ADMA Admissions Application

Comments:

*Changes Allowed: Yes

Category Details

<i>Field or Control</i>	<i>Description</i>
Allow Any Term	This appears <i>only</i> for the STRM administrative function. Select to allow any term to be selected in Variable Data rather than just the activated terms for the student.
Administrative Function	Enter the code for the administrative area with which this comment category is associated. Available function codes are from the Administrative Functions page.
Comments	Enter the default comment to use when this comment category is assigned to an individual.
Changes Allowed	Indicate whether users should be permitted to change the default comment associated with this comment category. The default value is <i>Yes</i> . You can override this value. <i>Append:</i> Users can add to the default comment, but cannot change or edit it. <i>No:</i> Users cannot change, edit, or add to the default comment.

Defining 3C Update/Inquiry Groups

To define 3C Update/Inquiry Groups, use the 3C Update/Inquiry Groups component (GROUP_3C_TBL).

Page Used to Define 3C Update/Inquiry Groups

<i>Page Name</i>	<i>Definition Name</i>	<i>Navigation</i>	<i>Usage</i>
3C Update/Inquiry Group	GRP_3C_TABLE	Set Up SACR > Common Definitions > 3C Update/Inquiry Group Table	Define a group of IDs who have similar interests and needs.

Defining a 3C Update/Inquiry Group

Access the 3C Update/Inquiry Groups page (**Set Up SACR > Common Definitions > 3C Update/Inquiry Group Table**).

Define a group of users who have similar needs and interests. You can then associate one or more 3C Update/Inquiry Groups with a comment category to create a Comment 3C Group.

Security Administrators give users security access based on 3C update/inquiry groups.

Related Links

“Setting Up 3C Group Security” (Campus Solutions Application Fundamentals)

Setting Up Comment 3C Groups

To set up comment 3C groups, use the Comment 3C Groups component (CMNT_GRP_3C_TBL).

This section discusses how to create a comment 3C group.

Page Used to Set Up Comment 3C Groups

<i>Page Name</i>	<i>Definition Name</i>	<i>Navigation</i>	<i>Usage</i>
Comment 3C Groups	CMNT_GRP_3C_TABLE	<ul style="list-style-type: none"> • Set Up SACR > Common Definitions > Comments > Comment 3C Groups • Campus Community > Comments > Set Up Comments > Comment 3C Groups 	Associate one or more 3C update/inquiry groups with a comment category.

Setting Up Checklists

Understanding Checklist Setup

Important! Letter Generation (Letter Gen) is a deprecated product. It is strongly recommended that you use Communication Generation (Comm Gen) instead. For more information on Comm Gen, see [Understanding the Communication Generation Process](#)

To create checklists, you must set up checklist items. You can assign a responsible person, a status, and a due date to each checklist item. You can then relate multiple checklist items to a specific checklist and assign a due date for the overall checklist. You can also associate checklist items with an administrative function and use that function to enter some or all of the items as a subset of items on a larger, more comprehensive checklist with its own overall due date. In addition, you can combine several checklists into one monitoring unit called a tracking group.

You can make the checklist items as general or as specific as you want. For example, checklist items might include an admission application that a student needs to submit, a letter that a member of your staff needs to write, or a phone call that a staff member needs to make.

You can associate a checklist item with multiple administrative functions. However, when you use an administrative function to create a checklist, you can enter only the checklist items associated with that administrative function.

You can combine several checklists within the same administrative function into one unit for fast, organized monitoring. For example, if you were to create a checklist of items typically required for an admissions application, you might begin by creating a checklist item for receiving the individual's ACT or SAT 1 test scores. You might also set checklist item codes for the application fee, references checked, a meeting arranged with a mentor, and career and placement discussion held.

To set up the checklist item code for receiving ACT or SAT 1 test scores:

1. Select **Set Up SACR > Common Definitions > Checklists > Checklist Item Table**.
2. Enter a checklist item code, such as *ACTSAT*.
3. Enter a description to identify the checklist item.

In this case, you might enter *ACT or SAT 1 Test Scores*.

4. Enter a short description.

If you do not enter a short description, the system enters one based on the description.

5. Enter a long description to provide more information about the checklist item or to enter a comment.

If you use this checklist item as part of generating a letter, the data in the long description is included in the letter generation output data. You can specify whether to print it in the letter.

See [Understanding Communication Management](#).

After you create the checklist item code for the offer letter, you can continue creating checklist item codes for each item that you want on your checklist. When you are finished setting up checklist items, you can set up checklist function items.

You can associate a set of checklist items with a particular administrative function. You can then use that administrative function to indicate a subset of checklist items that you want to include in a larger checklist.

For example, you could associate a set of checklist items with the function of Admissions Application. These checklist items might include the ACT or SAT 1 test scores, application fee, references checked, a meeting arranged with a mentor, and career and placement discussion held.

To associate the ACT or SAT 1 test scores checklist item with the administrative function of Admissions Application:

1. Select **Set Up SACR > Common Definitions > Checklists > Checklist Function Item Table**.
2. Enter the administrative function, such as *ADMA*.
3. Enter the item code of the first checklist item that you want to associate with this function, in this case, ACT/SAT.

Continue to associate relevant checklist items with this function. You can associate many checklist items with a function. You can also choose other functions, and associate checklist items with each of them.

After all checklist items are associated with an administrative function, you must group the checklist items into checklists, which you can then assign to individuals or organizations. When you assign a checklist code to an individual or organization, the system assigns each of the checklists items in that code to that individual or organization.

In our example, you want to create a checklist code of UGALL for all undergraduate requirements, and include the checklist items ACT and SAT 1.

1. Select **Set Up SACR > Common Definitions > Checklists > Checklist Table**.
2. Enter the checklist code that you want to create and the function from which you want to select checklist items.

For this example, the checklist code is *UGALL* and the function is *ADMA*.

3. Define what type of checklist this will be, such as Requirement List.

Additionally you can set up tracking groups. A tracking group provides a logical connection between the checklists that are associated with an individual. For example, you may have several checklists for the same student in the undergraduate applications function, but only some of those checklists are related to the student's loan requirements. You might want to monitor the status of the student's loan documents to determine when the loan document requirements are complete. When you create the checklist and assign a checklist code, you could also assign the checklist to a loan documents tracking group.

Users can access checklists only in the checklist categories to which you grant them 3C group security access.

Related Links

[Understanding the 3C Engine](#)

[Understanding Checklists](#)

Prerequisites for Setting Up Checklists

Before defining checklist items and associating them with functions, become familiar with administrative functions. Before using communication speed keys to create a checklist template, set up communication speed keys in your system.

Related Links

[Reviewing Administrative Functions](#)

[Defining Communication Speed Keys](#)

Setting Up Checklist Items

This section discusses how to define checklist items for both the PeopleSoft Classic and Fluid User Interfaces. To set up checklist items in either the Classic or Fluid User Interfaces, use the Checklist Item Table component (CS_CHK_ITEM_TBL).

Page Used to Set Up Checklist Items

<i>Page Name</i>	<i>Definition Name</i>	<i>Navigation</i>	<i>Usage</i>
Checklist Item Table	SCC_CHECKLST_ITEM SCC_CKLSITM_TBL for the Fluid interface.	<ul style="list-style-type: none"> • Set Up SACR > Common Definitions > Checklists > Checklist Item Table • Campus Community > Checklists > Checklist Item Table 	Define items to make available for checklists. > Checklist Configure the checklist items that appear in Fluid Self Service using the Checklist Item Table.

Defining Checklist Items

Access the Checklist Item Table page (**Set Up SACR > Common Definitions > Checklists > Checklist Item Table**).

This example illustrates the fields and controls on the Checklist Item Table page. You can find definitions for the fields and controls later on this page.

Checklist Item Table

Checklist Item Code 001004

Item Code Detail Find | View All First 1 of 1 Last

*Effective Date 01/01/1980 *Status Active

*Checklist Code Descr Emergency Contact

Short Description Emerg Cntc

Item Association Organization

Comments

Provide primary and secondary emergency contact names, telephone numbers and addresses

This example illustrates the variable fields set up for display in the Fluid User Interface.

Fluid Field Display

- Organization
- Variable Data
- Status
- Status Date
- Contact Name
- Contact Email
- Due Date

Action Button Label Add Emergency Contact

Menu Name SCC_PROFILE_FL Profile Details

Component Name SCC_EMERG_CNTCT_FL Emergency Contacts

Page Name SCC_EMERG_CNTCT_FL Emergency Contacts

Field or Control	Description
Item Association	<p>If the item is associated with a particular person or organization in any way, you can select either <i>Name</i> or <i>Organization</i> to indicate that.</p> <p>The item association that you select here is used on checklist management pages when you assign checklists to IDs. Although you assign the checklist to the ID, you might want to know that an item must come from, or is in some other way associated with, another individual or organization. For example, you might assign a checklist item called <i>Transcript</i> to an individual, and that item might be created with an item association of <i>Organization</i>. On the checklist management page where you assign the checklist to the ID, you can identify the organization (for example, <i>PeopleSoft University</i>) from which that transcript is needed for the applicant to be admitted. This is especially helpful if you need to receive multiple transcripts for an applicant.</p> <p>The Item Update - Automated process, which links checklist items with transcripts with general materials, such as recommendation letters, and with tests scores in PeopleSoft Recruiting and Admissions, also uses this.</p> <p>Values for this field are delivered with your system as translate values. You should not modify these translate values.</p>
Comments	<p>Enter comments to further describe or define this Item Code. This is a rich text field, so you can format text and include external URLs or email links that are displayed on a Fluid User Interface.</p>

Field or Control	Description
<p>Fluid Field Display</p>	<p>Set up these optional fields for the PeopleSoft Fluid User Interface.</p> <p>Use the check boxes to set up optional fields to be displayed on the Task Details page from Person Checklist Item. By default, the check boxes are not selected for new records. The Checklist Code Descr and Comments are always displayed. If there is more than one active institution, the institution is displayed.</p> <ul style="list-style-type: none"> • Organization—the check box is enabled only if the Item Association value is <i>Organization</i>. Select either an Ext Org ID (ASSOC_ID) or enter a value on the Checklist Management page. • Variable Data—the check box is enabled for checklist items associated with admin functions used for person checklists that have variable data fields. Variable data fields are displayed from the relevant record (VAR_DATA_XXXX) based on the admin function associated with the checklist assigned to the student. If a variable data field does not contain a value or is zero, the field is not displayed on the Task Details page. In some instances, a description is displayed rather than the field value. • Status—status of the checklist item. • Status Date—date associated with the status. • Contact Name—if the check box is selected, the name of the person defined as the Responsible ID in the Person Checklist Item is displayed. If defined, the preferred name is displayed, otherwise the primary name is displayed. If a Responsible ID is not defined, the field is not displayed. • Contact Email— if the check box is selected, the preferred email of the defined Responsible ID in the Person Checklist Item is displayed. If a Responsible ID is not defined or if the Responsible ID does not have a preferred email defined, the field is not displayed. • Due Date <hr/> <p>Note: Since Admissions checklist items appear in the context of an application, the Variable Data fields are not displayed in them.</p> <hr/>
<p>Action Button Label</p>	<p>Set up an optional button in the Hold Details modal page to navigate to another Fluid self-service page. If configured, also define the target Fluid page in the Menu, Component and Page fields.</p> <p>For the Action Button to be displayed on mobile devices without the need for horizontal scrolling, ensure that the label value has a maximum of 30 characters.</p>

Variable Data Fields by Function

Code	Description	Fields
ADMA	Admissions Application	<ul style="list-style-type: none"> • Academic Career (ACAD_CAREER): Description (max 30 chars). Not displayed if field is blank. • Career Number (STDNT_CAR_NBR): Field value (max 3 digits). Zero values are displayed. • Application Number (ADM_APPL_NBR): Field value (max 8 chars). Not displayed if the field is blank.
ADMP	Admissions Program	<ul style="list-style-type: none"> • Academic Career (ACAD_CAREER): Description (max 30 chars). Not displayed if field is blank. • Career Number (STDNT_CAR_NBR): Field value (max 3 digits). Zero values are displayed. • Application Number (ADM_APPL_NBR): Field value (max 8 chars). Not displayed if the field is blank. • Program Number (APP_PROG_NBR): Field value (max 3 digits). Not displayed if the field is zero, or if Application Number is blank.
AWRD	Awarding	<ul style="list-style-type: none"> • Aid Year (AID_YEAR): Description (max 30 chars). Not displayed if field is blank. • Academic Career (ACAD_CAREER): Description (max 30 chars). Not displayed if field is blank. • Item Type (ITEM_TYPE): Description (max 30 chars) or field value (max 12 chars). Hidden if the field is blank, or if Aid Year is blank.
BDGT	Budget Maintenance	<ul style="list-style-type: none"> • Academic Career (ACAD_CAREER): Description (max 30 chars). Not displayed if field is blank. • Aid Year (AID_YEAR): Description (max 30 chars). Not displayed if field is blank. • Effective Date (EFFDT_VAR): Date, format as per user preference. Not displayed if the field is blank. • Term (STRM): Description (max 30 chars). Not displayed if the field is blank.

Code	Description	Fields
CASN	CAS Notification	<ul style="list-style-type: none"> • Academic Career (ACAD_CAREER): Description (max 30 chars). Not displayed if field is blank. • Career Number (STDNT_CAR_NBR): Field value (max 3 digits). Zero values are displayed. • CAS Number (SAD_PB_CAS_NUMBER): Field value (max 14 chars). Not displayed if the field is blank.
EVNT	Event	<ul style="list-style-type: none"> • Event ID (CAMPUS_EVENT_NBR): Description (max 30 chars). Not displayed if the field is blank. • Meeting (EVENT_MTG_NBR): Description (max 30 chars). Not displayed if field is blank, or if Event ID is blank.
FINA	Financial Aid	Aid Year (AID_YEAR): Description (max 30 chars). Not displayed if field is blank.
FINT	Financial Aid Term	<ul style="list-style-type: none"> • Aid Year (AID_YEAR): Description (max 30 chars). Not displayed if field is blank. • Term (STRM): Description (max 30 chars). Not displayed if the field is blank.
IHC	International Health Coverage	Coverage Number (SSF_IHC_COVER_NBR): Field value (max 3 digits).
ISIR	ISIR Corrections	<ul style="list-style-type: none"> • Aid Year (AID_YEAR): Description (max 30 chars). Not displayed if field is blank. • Effective Date (EFFDT_VAR): Date, format as per user preference. Not displayed if the field is blank. • Sequence Number (EFFSEQ_VAR): Field value (max 2 digits). Not displayed if the field is blank.

Code	Description	Fields
LOAN	Loan	<ul style="list-style-type: none"> • Aid Year (AID_YEAR): Description (max 30 chars). Not displayed if field is blank. • Academic Career (ACAD_CAREER): Description (max 30 chars). Not displayed if field is blank. • Loan Type (LOAN_TYPE): Description (max 30 chars). Not displayed if the field is blank, or if Aid Year is blank • Application Sequence (LN_APPL_SEQ): Field value (max 2 digits). Not displayed if the field is zero. • Loan Application ID (LN_APPL_ID): Field value (max 21 chars). Not displayed if the field is blank.
NLBP	Internships NLD	Internal Contract (SAD_INT_CONTR_NLD): Field value (max 16 chars).
NLOW	Educational contracts NLD	Contract Number (SAD_CONTRACTNR_NLD): Field value (max 12 digits).
PROP	Prospect Program	<ul style="list-style-type: none"> • Academic Career (ACAD_CAREER): Description (max 30 chars). Not displayed if field is blank. • Academic Program (ACAD_PROG): Description (max 30 chars). Not displayed if field is blank.
PROS	Prospect	Academic Career (ACAD_CAREER): Description (max 30 chars). Not displayed if field is blank.
PSSV	Prospect Self Service	Academic Career (ACAD_CAREER): Description (max 30 chars). Not displayed if field is blank.
RECR	Recruiters	Academic Career (ACAD_CAREER): Description (max 30 chars). Not displayed if field is blank.
RREQ	Research Requirement	<ul style="list-style-type: none"> • Candidate Number (SSR_RS_CANDIT_NBR): Field value (max 12 chars). Not displayed if the field is blank. Field label is <i>Candidate</i> rather than <i>Candidature</i> to be consistent with Research SS. • Assignment Type(SSR_RS_REQUIRE_TYPE): Description (max 100 chars). Not displayed if the field is blank.

Code	Description	Fields
RSCH	Research Administration	Candidate Number (SSR_RS_CANDIT_NBR): Field value (max 12 chars).
RSTR	Restricted Aid	<ul style="list-style-type: none"> • Aid Year (AID_YEAR): Description (max 30 chars). Not displayed if field is blank. • Restricted Aid ID (RESTRICTED_AID_ID): Field value (max 10 chars). Not displayed if the field is blank.
SENR	Student Enrollment	<ul style="list-style-type: none"> • Academic Career (ACAD_CAREER): Description (max 30 chars). Not displayed if field is blank. • Term (STRM): Description (max 30 chars). Not displayed if the field is blank. • Class Number (CLASS_NBR): Field value (max 5 digits). Not displayed if the field is zero.
SFAC	Student Financials Account	<ul style="list-style-type: none"> • Business Unit (BUSINESS_UNIT): Description (max 30 chars). Not displayed if the field is blank. • Account Number (ACCOUNT_NBR): Field value (max 10 chars). Not displayed if the field is blank. • Account Term (STRM): Description (max 30 chars). Not displayed if the field is blank.
SFBI	Student Financials Billing	<ul style="list-style-type: none"> • Business Unit (BUSINESS_UNIT): Description (max 30 chars). Not displayed if the field is blank. • Invoice Number (INVOICE_ID): Field value (max 22 chars). Not displayed if the field is blank.
SFCO	Student Financials Collections	<ul style="list-style-type: none"> • Business Unit (BUSINESS_UNIT): Description (max 30 chars). Not displayed if the field is blank. • Collection ID (COLLECTION_ID): Field value (max 12 digits). Not displayed if the field is zero.

Code	Description	Fields
SFIT	Student Financials Item Lines	<ul style="list-style-type: none"> • Business Unit (BUSINESS_UNIT): Description (max 30 chars). Not displayed if the field is blank. • Item Number (ITEM_NBR): Field value (max 15 chars). Not displayed if the field is blank. • Line Sequence Number (LINE_SEQ_NBR): Field value (max 3 digits). Not displayed if the field is zero.
SFPA	Student Financials Payments	<ul style="list-style-type: none"> • Business Unit (BUSINESS_UNIT): Description (max 30 chars). Not displayed if the field is blank. • Payment ID Number (PAYMENT_ID_NBR): Field value (max 3 digits). Not displayed if the field is zero.
SFPR	Student Financials Promise	Checklist Date Time (CHECKLIST_DTTM_VAR): DD/MM/YYYY HH:MM:SS, or MM/DD/YYYY HH:MM:SS.
SFRC	Student Financials Receipt	<ul style="list-style-type: none"> • Business Unit (BUSINESS_UNIT): Description (max 30 chars). Not displayed if the field is blank. • Cashier's Office (CASHIER_OFFICE): Description (max 30 chars). Not displayed if the field is blank, or if Business Unit is blank. • Receipt Number (RECEIPT_NBR) Field value (max 12 digits). Not displayed if the field is zero.
SFRF	Student Financials Refund	<ul style="list-style-type: none"> • Business Unit (BUSINESS_UNIT): Description (max 30 chars). Not displayed if the field is blank. • Refund Number (REFUND_NBR): Field value (max 12 digits). Not displayed if the value is zero.
SFTP	Student Financials Contracts	<ul style="list-style-type: none"> • Business Unit (BUSINESS_UNIT): Description (max 30 chars). Not displayed if the field is blank. • Contract Number (CONTRACT_NUM): Field value (max 25 chars). Not displayed if the field is blank.

Code	Description	Fields
SPRG	Student Program	<ul style="list-style-type: none"> • Academic Career (ACAD_CAREER): Description (max 30 chars). Not displayed if field is blank. (This is only possible if Career Number is not zero). • Career Number (STDNT_CAR_NBR): Field value (max 3 digits). Zero values are displayed. Not displayed if Academic Career is blank.
STRM	Student Term	<ul style="list-style-type: none"> • Academic Career (ACAD_CAREER): Description (max 30 chars). Not displayed if field is blank. (This is only possible if Career Number is not zero). • Term (STRM): Description (max 30 chars). Not displayed if the field is blank.
SUPR	Research Supervisors	<ul style="list-style-type: none"> • Candidate Number (SSR_RS_CANDIT_NBR): Field value (max 12 chars). Not displayed if the field is blank • Supervisor Sequence (SSR_RS_SUPER_NBR): Field value (max 3 digits). Not displayed if the field is zero.
THES	Thesis Administration	<ul style="list-style-type: none"> • Candidate Number (SSR_RS_CANDIT_NBR): Field value (max 12 chars). Not displayed if the field is blank • Thesis Submission Number (SSR_RS_SUBMSSN_NBR): Field value (max 3 digits). Not displayed if the field is zero.
TOPC	Research Topic	<ul style="list-style-type: none"> • Candidate Number (SSR_RS_CANDIT_NBR): Field value (max 12 chars). Not displayed if the field is blank • Topic (SSR_RS_TOPIC_SEQ): Field value (max 3 digits). Not displayed if the field is zero.

Enabling File Uploads for Applications in Fluid User Interface

Access the Checklist Item Table page (**Set Up SACR > Common Definitions > Checklists > Checklist Item Table**).

In the Fluid Field Display region, use the following information to set up the file upload functionality. This defines the Upload File button as a checklist item.

Field or Control	Description
Action Button Label	Upload File

<i>Field or Control</i>	<i>Description</i>
Menu Name	SAD_APPLICANT_FL
Component Name	SAD_ATTACH_FL
Page Name	SAD_ATTACH_FL

Associating Checklist Items with Administrative Functions

To associate checklist items with administrative functions, use the Checklist Function Item Table component (CHK_FUNCTION_TABLE).

This section discusses how to associate items with a function.









































Page Used to Associate Checklist Items with Administrative Functions

<i>Page Name</i>	<i>Definition Name</i>	<i>Navigation</i>	<i>Usage</i>
Checklist Item Functions Table	CHK_FUNCTION_TABLE	<ul style="list-style-type: none"> • Set Up SACR > Common Definitions > Checklists > Checklist Function Item Table • Campus Community > Checklists > Set Up Checklists > Checklist Function Item Table 	Associate checklist items with an administrative function.

Associating Items with a Function

Access the Checklist Item Functions Table page (**Set Up SACR > Common Definitions > Checklists > Checklist Function Item Table**).

This example illustrates the fields and controls on the Checklist Item Functions Table page. You can find definitions for the fields and controls later on this page.

Checklist Item Functions Table		
Administrative Function: ADMA Admissions Application		
Item List		
*Item Code	Description	
ACTSAT 	ACT or SAT I Test Scores	
APFEE 	Application Fee	
DEAN 	Dean's Report	
ENGPRO 	English Proficiency	
ESSAY 	Essay	
FINSTA 	Financial Statement	
GMAT 	GMAT Scores	
GRE 	GRE Scores	
INTWW 	Interview	
LSAT 	LSAT Scores	
MCAT 	MCAT Scores	
MEDIC 	Medical Approval	
PERSTA 	Personal Statement	
PORTF 	Portfolio	
RECLTR 	Recommendation Letter	
SECRPT 	Secondary School Report	
TOEFL 	Test of Engl as a Foreign Lang	
TRANS 	Academic Transcripts	
TRFSTM 	Transfer Statement	
TRNGED 	Academic Transcripts/GED	

Field or Control	Description
Item Code	Enter the code for the checklist item associated with this administrative function. Available item codes are from the Checklist Items page.

Setting Up Checklist Tracking Groups

To set up tracking groups, use the Tracking Group Table component (TRACK_GRP_TBL).

This section discusses how to create a tracking group.

Page Used to Set Up Tracking Groups

Page Name	Definition Name	Navigation	Usage
Tracking Groups	TRACK_GRP_TABLE	<ul style="list-style-type: none"> • Set Up SACR > Common Definitions > Checklists > Tracking Group Table • Campus Community > Checklist > Set Up Checklists > Tracking Group Table 	Optionally create tracking groups by combining two or more checklists with the same administrative function into one monitoring unit.

Creating a Tracking Group

Access the Tracking Groups page (**Set Up SACR > Common Definitions > Checklists > Tracking Group Table**).

This example illustrates the fields and controls on the Tracking Groups page. You can find definitions for the fields and controls later on this page.

Tracking Groups

Academic Institution: PSUNV PeopleSoft University

Tracking Group: UGAPPL

Track Group Detail Find | View All First 1 of 1 Last

*Effective Date: 01/01/1900 31 *Status: Active + -

*Description: UG Application Requirements

Short Description: UG Appl

*Administrative Function: ADMA 🔍 Admissions Application

Tracking groups are optional, but helpful for monitoring a group of checklists at the same time.

Note: You can assign only one tracking group per checklist, so you might not want to make your tracking groups too broad.

<i>Field or Control</i>	<i>Description</i>
Administrative Function	<p>Enter the code for the administrative area with which this tracking group is associated.</p> <p>Checklists associated with the administrative functions that you select here are the only checklists that will be available in this tracking group.</p>

Setting Up Checklist Templates

Important! Letter Generation (Letter Gen) is a deprecated product. It is strongly recommended that you use Communication Generation (Comm Gen) instead. For more information on Comm Gen, see [Understanding the Communication Generation Process](#)

To set up checklist templates, use the Checklist Table component (CS_CHKLIST_TBL).

This section discusses how to create a checklist template.

Page Used to Set Up Checklist Templates

<i>Page Name</i>	<i>Definition Name</i>	<i>Navigation</i>	<i>Usage</i>
Checklist Table	CS_CHKLIST_TABLE	<ul style="list-style-type: none"> • Set Up SACR > Common Definitions > Checklists > Checklist Table • Campus Community > Checklists > Set Up Checklists > Checklist Table 	Create checklist templates and assign codes to them.

Creating a Checklist Template

Access the Checklist Table page (**Set Up SACR > Common Definitions > Checklists > Checklist Table**).

This example illustrates the fields and controls on the Checklist Table page. You can find definitions for the fields and controls later on this page.

Checklist Table

Academic Institution PSUNV PeopleSoft University

Checklist Code GEN1

Detail Find | View All First 1 of 1 Last

*Effective Date 01/01/1900 *Status Active

*Description GEN1 Checklist Code Display in Self Service

Short Description GEN1 Check Due Days

*Function GEN General Due Date 08/03/2016

Checklist Type Medical Tracking Group GENTRK

Item List Personalize | Find | First 1-4 of 4 Last

*Sequence	*Item Code	Description	Default Due Date	Due Days	Hide	Comm Key
100	ESSAY	Essay	08/03/2016		<input type="checkbox"/>	
200	GEN1	GEN1 Item	08/03/2016		<input type="checkbox"/>	
300	JFAPP	Applicatn	08/03/2016		<input type="checkbox"/>	
400	GEN2	GEN2 Item	08/03/2016		<input checked="" type="checkbox"/>	

Display Checklist Items Personalize | Find | First 1-2 of 2 Last

*Item Status

Initiated	<input type="checkbox"/>	<input type="checkbox"/>
Received	<input type="checkbox"/>	<input type="checkbox"/>

Detail

Field or Control	Description
Function	Enter the code for the administrative area with which the items for this checklist are associated. The function code controls the item codes that you will be able to select.

Field or Control	Description
Checklist Type	<p>Select the type that best describes this checklist.</p> <p>The following checklist types are delivered with your system as translate values:</p> <p><i>(ADC) Condition List</i></p> <p><i>(CML) Communication List</i></p> <p><i>(HIR) Hiring</i></p> <p><i>(MED) Medical</i></p> <p><i>(PRM) Promise</i></p> <p><i>(RQL) Requirements List</i></p> <p><i>(SAL) Staff Assignment List</i></p> <p><i>(TER) Termination</i></p> <p><i>(TRN) Training</i></p> <p><i>(XFR) Transfer</i></p> <p><i>(OTH) Other</i></p> <p>You can modify these translate values.</p> <p>Of the delivered checklists types, the ones most relevant to the management of student administration and contributor relations are:</p> <p><i>(CML) Communication List:</i> A list of the communications (for example, letters, brochures, and phone calls) that have occurred with a person over a period of time.</p> <p><i>(PRM) Promise:</i> Records the amount and due dates of a person's promise-to-pay.</p> <p><i>(RQL) Requirements List:</i> A list of items that a student must accomplish or submit to move to the next step of a process. For example, the list might specify the materials required to complete an application to your institution. You can also use items from a requirements list in the letter generation process to notify students of missing application items.</p> <p><i>(SAL) Staff Assignment List:</i> A list of items that a staff member needs to accomplish relative to a particular student.</p>

<i>Field or Control</i>	<i>Description</i>
Allow Any Term	This appears <i>only</i> for the STRM administrative function. Select to allow any term to be selected in Variable Data rather than just the activated terms for the student.
Display in Self Service	Select to display the checklist as a To Do item on PeopleSoft Campus Self Service pages. Clear to prevent the checklist from appearing as a self-service To Do item.
Due Days	Enter the number of days, calculated from the assign date, by which all items on this checklist must be completed.
Due Date	The date by which all items on this checklist must be completed.
Tracking Group	(Optional) Enter the group to which this checklist should be assigned for monitoring. Available group codes are from the Tracking Groups page.

Item List

<i>Field or Control</i>	<i>Description</i>
Sequence	The number of this item in the list of items for this checklist. The system automatically enters the next sequential number for each checklist item that you add. You can override the number to reorder the list of checklist items.
Item Code	Enter the item code for this checklist item. The item codes available are those associated with the selected administrative function on the Checklist Item Functions page.

Field or Control	Description
Default Due Date	<p>If you know the exact date when the checklist item is due, enter it here.</p> <p>You can leave the field blank. If the field is blank when you save the record, the system displays the due date from the Detail area of the page as the default due date for each checklist item. You can override this date, but it must be with an <i>earlier</i> date so that the item due date does not exceed the overall due date of the checklist.</p>
Due Days	<p>If an item is due within a specific number of days rather than on a specific date, enter the number of days here.</p> <p>You can leave the field blank. If the field is blank when you save the record, the system displays the number of due days from the Detail area of the page as the default due days value for each checklist item. You can override this number, but it must be with a <i>smaller</i> number so that the item does not become due after the overall due date of the checklist.</p>
Hide	<p>Used for the PeopleSoft Fluid User Interface only.</p> <p>Select this check box to hide a particular item in the Fluid Self-Service. It is unselected by default. An item appears in the To Do List only if Display in Self Service is selected for the checklist code and Hide is not selected for the item.</p>
Comm Key	<p>When you create a checklist of the default type that is set on the Installation Default - CC page, the Comm Key field becomes available.</p> <p>Select a Comm Key to assign the specified communications to the individual or organization to which you are also assigning the checklist. When you run the process to generate the letter whose letter code is associated with the Comm Key selected, the process extracts the checklist items listed on the checklist tied to the Comm Key. This enables you to print a list of the items not yet completed. For example, you could list in a letter the remaining items that an applicant needs to submit to complete the application.</p> <p>See Understanding Communication Management.</p>

<i>Field or Control</i>	<i>Description</i>
Display Checklist Items	<p>Used for the PeopleSoft Fluid User Interface only.</p> <p>Define multiple Status values for the Checklist. This is similar to the institution-level setup provided in the To Do List configuration. The grid only appears if the Display in Self Service check box is selected.</p> <p>This setup determines if these checklist items appear in the To Do List if Status values are defined at the Checklist level. If Status values are not defined for the checklist then the setup at institution-level determines which items to display. This option is applicable to items not set to Hide.</p>

Defining 3C Update/Inquiry Groups for Checklists

See [Defining 3C Update/Inquiry Groups](#)

Setting Up Checklist 3C Groups

To set up checklist 3C groups, use the Checklist 3C Groups component (CS_CHKLIST_3CGRP).

This section discusses how to create a checklist 3C group.

Page Used to Set Up Checklist 3C Groups

<i>Page Name</i>	<i>Definition Name</i>	<i>Navigation</i>	<i>Usage</i>
Checklist 3C Groups	CS_CHKLIST_3CGRP	<ul style="list-style-type: none"> • Set Up SACR > Common Definitions > Checklists > Checklist 3C Groups • Campus Community > Checklists > Set Up Checklists > Checklist 3C Groups 	Create checklist 3C groups to grant security access to checklists in your database.

Creating a Checklist 3C Group

Access the Checklist 3C Groups page (**Set Up SACR > Common Definitions > Checklists > Checklist 3C Groups**).

This example illustrates the fields and controls on the Checklist 3C Groups page. You can find definitions for the fields and controls later on this page.

Checklist 3C Groups

Academic Institution: PSUNV PeopleSoft University

Checklist Code: UGRALL UG Appl Requirements - All

Admin Function: Admissions Program

Checklist Type: Requirements List

Update/Inquiry Group		
*Group	Description	
UADC <input type="text"/>	Undergrad Adm Counselors	<input type="button" value="-"/>
UADO <input type="text"/>	Undergrad Adm Operations	<input type="button" value="-"/>
UADS <input type="text"/>	Undergrad Adm Student Staff	<input type="button" value="-"/>
UGAD <input type="text"/>	Undergraduate Admissions	<input type="button" value="-"/>

Related Links

“Setting Up 3C Group Security” (Campus Solutions Application Fundamentals)

Setting Up To Do Lists

Setting Up To Do Lists Using PeopleSoft Fluid User Interface

This section discusses how to set up the To Do List page.

Page Used to Set Up To Do Lists

<i>Page Name</i>	<i>Definition Name</i>	<i>Navigation</i>	<i>Usage</i>
To Do List Configuration	CS_SCC_TODO_SETUP_FL_GBL	Set Up SACR > Common Definitions > Self Service > Campus Community	Configure by Institution, which checklist items based on their status, are displayed on the Fluid To Do List page.

Configuring the To Do List Page

Access the To Do List Configuration page (**Set Up SACR > Common Definitions > Self Service > Campus Community**).

The Display Checklist Items table allows you to set up which statuses are displayed in the To Do List. By default, an undefined Status is not displayed.

Select the checklist items to be displayed according to **Institution** and **Item Status**. Institutions can configure multiple statuses for items at the institution and checklist level to allow for different uses across an institution.

Related Links

[Setting Up Checklist Items](#)

Setting Up Committee Templates

Understanding Committee Templates

Within most organizations, committees are frequently created that share the same structure and the same member roles; only the set of people who should serve on those committees and their individual names change. Campus Community enables you to define the types of committees that your institution creates, identify the roles that should be on each committee, and then use the types and roles to create templates to help you create and manage committees across your institution.

For example, you can create a template for an undergraduate interviews committee type and associate the roles of chairperson and three interviewers with it. You might want members of this committee type to be recruiters and advisors, in which case you would associate all recruiter and all advisor records with the committee type to provide prompt lists from which to assign individuals to this committee. You then use the template to create a current or ongoing committee and assign individuals to the chair and member roles. You can also specify the dates during which each individual should participate in the committee.

Related Links

[Creating Committees](#)

Setting Up Committee Types and Roles

To set up committee types and roles, use the Committee Type/Role component (COMMITTEE_SETUP).

This section discusses how to define a committee type and assign member roles.

Page Used to Set Up Types and Roles

<i>Page Name</i>	<i>Definition Name</i>	<i>Navigation</i>	<i>Usage</i>
Committee Type/Role	COMMITTEE_TABLE	<ul style="list-style-type: none">• Set Up SACR > Common Definitions > Committees > Committee Table Types/ Roles• Campus Community > Committees > Committee Type/Role	Define a committee type and assign member roles.

Defining a Committee Type and Assigning Member Roles

Access the Committee Type/Role page (Set Up SACR > Common Definitions > Committees > Committee Table Types/Roles).

This example illustrates the fields and controls on the Committee Type/Role page. You can find definitions for the fields and controls later on this page.

Committee Type/Role

Academic Institution: PSUNV PeopleSoft University

Committee Type: UGADMISS

Committee Description Find | View All First 1 of 1 Last

***Effective Date:** 01/01/1900 ***Status:** Active + -

***Description:** UG Admissions Committee

Short Description: UG Admiss

Record (Table) Name: RECRUITERS_VW

Committee Role Find | View All First 1 of 1 Last

***Committee Role:** Staff member of Committee + -

***Description:** Admissions Staff

Short Description: Adm Staff

Committee Description

<i>Field or Control</i>	<i>Description</i>
Record (Table) Name	<p>Enter the name of the record that contains the types of individuals to make available for assignment to this committee. The selected record provides the prompt list of possible members on the Committee page.</p> <p>For example, if you create an Undergraduate Interviews committee, and you select the RECRUITERS_VW, each time that you create a committee of the Undergraduate Interviews type, you are prompted to select members from the list of recruiters in your system.</p>

Committee Role

<i>Field or Control</i>	<i>Description</i>
Committee Role	<p>Select the role (for example, chair, co-chair, member, student member, and so on) that should always be part of this committee type. You can add as many roles as necessary.</p> <p>Values for this field are delivered with your system as translate values. You can modify these translate values.</p>

Setting Up Evaluation Management

Understanding Evaluation Management

The Evaluation Management System feature is not tied to a singular module within Campus Solutions (for example, Application Evaluations); it is intended to create a *generic* evaluation solution which can be leveraged across Campus Solutions, including people, organizations, and departments or faculties.

The feature is flexible enough that it can support many different models of an evaluation review. It provides institutions with the ability to determine what will be evaluated (for example, Admissions Application), who will evaluate it (such as evaluators and committees), and the ability to determine and configure the business process for the evaluation itself. The feature builds on the existing Campus Community committee structures and provides an administrative evaluation structure where the evaluation process can be managed. Evaluation Management also provides the ability for institutions to have a multiple-stage or -level review process, by supporting a hierarchical committee structure that can determine the order in which the evaluation (for example, thesis and application) should be considered and reviewed. In addition to supporting committee structures, the feature also supports evaluations where the process is undertaken by an individual.

As noted, the Evaluation Management System is not tied to a singular module within Campus Solutions, yet there is the need to relate the evaluation functionally as part of business processes. In order to make evaluations as 'generic' as possible, we have introduced the concept of cross reference records that are associated with an Evaluation Category. These cross reference records contain the data keys relevant to functional data in the system and enable the system to connect an evaluation to that data. We are delivering three cross-reference records initially: SCC_GE_XRF_APPL, SCC_GE_XRF_THES and SCC_GE_XRF_DEMO. SCC_GE_XRF_APPL and SCC_GE_XRF_THES support Admissions and Research Management Thesis functionality. SCC_GE_XRF_DEMO is a placeholder/example and can be cloned to create new cross-reference records. Similarly, in order to display appropriate data key fields used in the evaluation category in the evaluation administrative component, we have delivered two subpages that handle this display. SCC_GE_XRF_KEYSSBP contains subpages for Campus Solutions delivered cross reference records. SCC_GE_XRF_EXT_SBP is a placeholder/example. If you want to extend the Evaluation Management System beyond the functionality delivered initially for Admissions and Thesis, you must create a cross reference record and subpage. The new subpage should be added to the SCC_GE_XRF_EXT_SBP subpage. When adding a subpage for the first time, delete the Scroll Area and Evaluation Instance field in SCC_GE_XRF_EXT_SBP (they were delivered as placeholders). By using the SCC_GE_XRF_EXT_SBP subpage, you should be able to avoid any impacts if Campus Solutions redelivers the component.

Related Links

[Managing Evaluations](#)

[Processing Evaluations in Batch](#)

[Sending Timeout and Reminder Notifications to Evaluators](#)

[Understanding Evaluation WorkCenter](#)

[Prerequisites for using Evaluation WorkCenter](#)

Using Self-Service Worklist
Entering Evaluations

Understanding Evaluation Management Setup

Before you can start to use Evaluation Management System, you need to complete setup of various components. It is beneficial to map out your plan for the evaluation and make some decisions on the evaluation purpose, who is being evaluated, what is being evaluated, and who will be performing the evaluation.

The following diagram shows the building blocks of Evaluation Management System setup and how each step builds into the next:

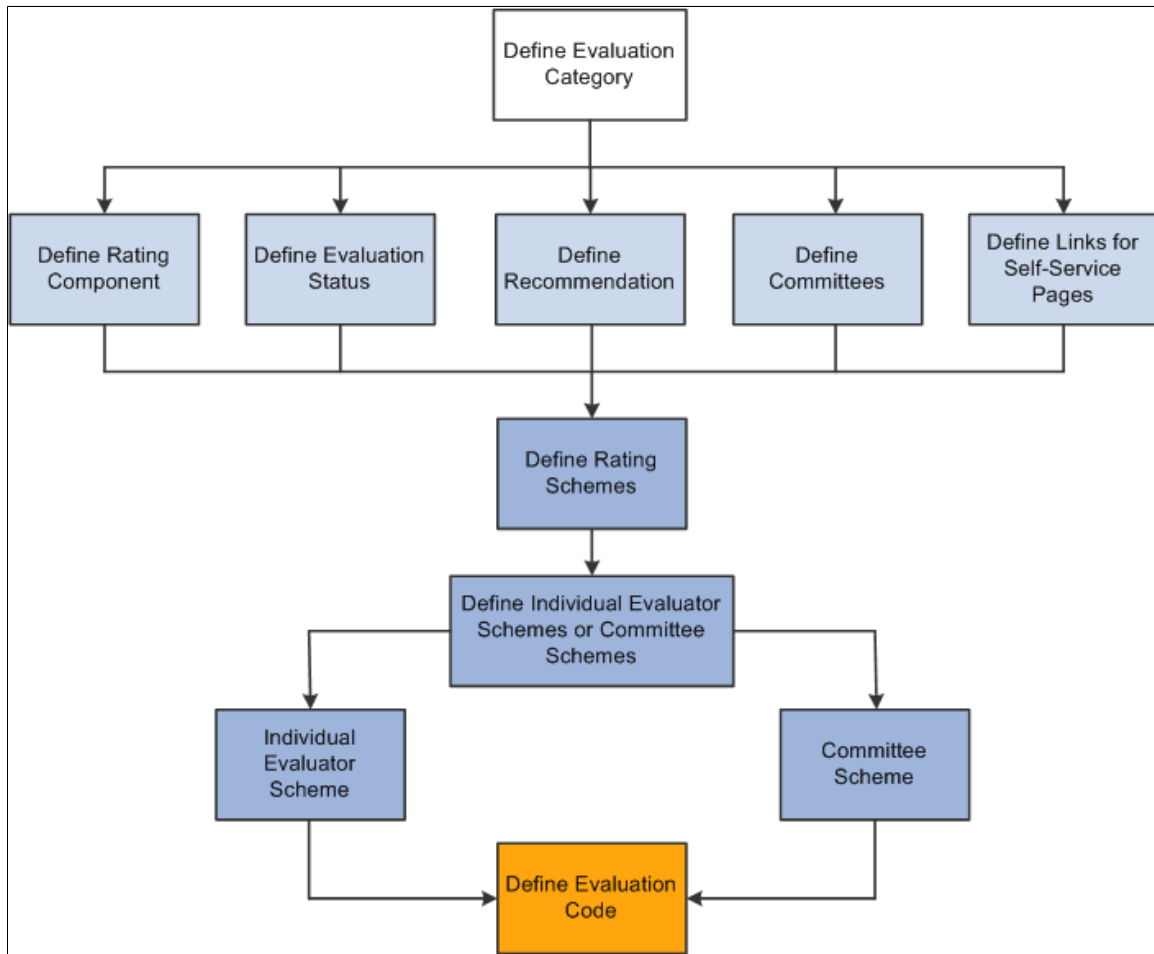

Defining Evaluation Categories

This section discusses how to set up evaluation categories.

Page Used to Define Evaluation Categories

<i>Page Name</i>	<i>Definition Name</i>	<i>Navigation</i>	<i>Usage</i>
Define Evaluation Category	SCC_GE_CATEGORY	Set Up SACR > Common Definitions > Evaluation Management System > Define Evaluation Category	Specify what the category data record will be, which means defining which keys the system will use to track and link the evaluation to other Campus Solutions functionality.

Setting Up Evaluation Categories

Access the Define Evaluation Category page (**Set Up SACR > Common Definitions > Evaluation Management System > Define Evaluation Category**).

This example illustrates the fields and controls on the Define Evaluation Category page.

An evaluation category is the high-level parent record to all other definition tables in the setup of an evaluation.

Evaluation category usage is very flexible; your institution can use a category at either a very high or very granular level. For example, an institution can define one Admissions category at a very high level, to serve all admission offices on the campus. Alternately, the institution can create very granular definitions such as Liberal Arts Undergraduate Application, School of Arts Undergraduate Application, and Chemistry Department Graduate Application.

Campus Solutions provides two evaluation categories for admissions and thesis management.

<i>Field or Control</i>	<i>Description</i>
Copy Evaluation Setup	Click this link to access the Copy Evaluation Setup page using this evaluation category as the 'copy from' category.

<i>Field or Control</i>	<i>Description</i>
Type	This value is always <i>1</i> , and is tied to the Entity ID .
Entity ID	Values for this field reside on the Entity Registry Table. The value you select here determines which entity structure the system uses for all evaluations under this category. The entity structure contains the Cross Reference Record listed below.
Record (Table) Name	The value you enter here determines which record in the system contains the data keys and is most relevant to the functional evaluation process.
Cross Reference Record	<p>The value you enter here connects the data keys on the data record selected in the Record (Table) Name field to an Evaluation Instance Number. This allows a discrete set of data to be tied to a specific evaluation instance. Over time an individual may have several of the same evaluation codes assigned to them, but associated with different data from one record; the Cross Reference Record maintains the link.</p> <p>Cross references for applications are tied to application numbers; cross references for theses are tied to candidate numbers and thesis submission numbers.</p>

Copying Evaluation Setup

This section discusses how to copy setup scenarios.

Page Used to Copy Evaluation Setup

<i>Page Name</i>	<i>Definition Name</i>	<i>Navigation</i>	<i>Usage</i>
Copy Evaluation Setup	SCC_GE_CATGRY_COPY	Set Up SACR > Common Definitions > Evaluation Management System > Copy Evaluation Setup	Create redundant setup scenarios for some evaluation constructs.

Copy Setup Scenarios

Access the Copy Evaluation Setup page (**Set Up SACR > Common Definitions > Evaluation Management System > Copy Evaluation Setup**).

This example illustrates the fields and controls on the Copy Evaluation Setup page (1 of 4). You can find definitions for the fields and controls later on this page.

Copy Evaluation Setup

Evaluation Category: **ADMISSIONS** Admissions Application

New Category Name: Select All

Description: Clear All

Short Description:

Setup EFFDT: Copy Category

Select the Committee Schemes to be copied Personalize | Find | First 1-3 of 3 Last

Select	Committee Scheme	Effective Date	Status	Description	Rating Scheme
<input type="checkbox"/>	TESTCS001	01/01/1900	Active	Committee Scheme 001	TESTCRS1
<input type="checkbox"/>	TESTCS02	01/01/1900	Active	Committee Scheme 02	TESTCRS2
<input type="checkbox"/>	UGDNMTE	01/01/1900	Active	Undergraduate Deans Committee	UGDEANREV

Select All Clear All

Select the Committee Codes to be copied Personalize | Find | First 1-6 of 6 Last

Select	Committee Code	Institution	Committee	Description
<input type="checkbox"/>	ALUM	PSUNV	ALUMNI	Alumni Committee
<input type="checkbox"/>	SCHLR	PSUNV	SCHLR	Scholarship Review Committee
<input type="checkbox"/>	TCS	PSUNV	TCS	Sociology Thesis Committee
<input type="checkbox"/>	TEST	PSUNV	TEST	Test Review Committee
<input type="checkbox"/>	UGDEAN	PSUNV	UGDEAN	Undergraduate Deans Committee
<input type="checkbox"/>	UGEV01	PSUNV	UGEV01	UG Admissions Committee

Select All Clear All

This example illustrates the fields and controls on the Copy Evaluation Setup page (2 of 4). You can find definitions for the fields and controls later on this page.

Personalize | Find | | First 1-2 of 2 Last

Select	Individual Evaluator Scheme	Effective Date	Status	Description	Rating Scheme
<input type="checkbox"/>	TESTIERS01	01/01/1900	Active	Test Individual Evaluator Scheme 01	TESTIRS1
<input type="checkbox"/>	UGFIRSTREV	01/01/1900	Active	Undergraduate First Review	UGFIRSTREV

Select All
Clear All

Personalize | Find | | First 1-12 of 12 Last

Select	Rating Scheme	Effective Date	Status	Description
<input type="checkbox"/>	ARTSADMDEC	01/01/1900	Active	Arts Admission Decision Committee
<input type="checkbox"/>	ARTSCOMMTE	01/01/1900	Active	Arts Admission Committee
<input type="checkbox"/>	ARTSREV	01/01/1900	Active	Arts Review
<input type="checkbox"/>	AUDTNCOMTE	01/01/1900	Active	Audition Committee
<input type="checkbox"/>	PRFARTSQUA	01/01/1900	Active	Performing arts first review
<input type="checkbox"/>	TESTCRS1	01/01/1900	Active	Committee Rating Scheme 1
<input type="checkbox"/>	TESTCRS2	01/01/1900	Active	Test Committee Rating Scheme 2
<input type="checkbox"/>	TESTIRS1	01/01/1900	Active	Ind Evaluator Rating Scheme 1
<input type="checkbox"/>	TESTRS1	01/01/1900	Active	Test Rating Scheme 1
<input type="checkbox"/>	UGADMCALC	01/01/1900	Active	Calculated Scheme for UG Admissions
<input type="checkbox"/>	UGDEANREV	01/01/1900	Active	Undergraduate Deans Review
<input type="checkbox"/>	UGFIRSTREV	01/01/1900	Active	Undergraduate First Review

Select All
Clear All

This example illustrates the fields and controls on the Copy Evaluation Setup page (3 of 4). You can find definitions for the fields and controls later on this page.

Personalize | Find | | First 1-15 of 15 Last

Select	Component	Description
<input type="checkbox"/>	ACADEMIC	Academic Qualification
<input type="checkbox"/>	ARTSQUAL	Qualified for Arts Audition
<input type="checkbox"/>	AUDITION	Audition appt
<input type="checkbox"/>	CINTERVIEW	Committee Interview
<input type="checkbox"/>	CMTERSLTS	Comittee Results
<input type="checkbox"/>	ESSAY	Written Essay
<input type="checkbox"/>	EXAM	Official Exam
<input type="checkbox"/>	EXTRA-CURR	Extra Curricular Activities
<input type="checkbox"/>	PORTFOLIO	Portfolio Folder
<input type="checkbox"/>	PRESENTATN	Presentation
<input type="checkbox"/>	RECMDTIONS	Recommendation
<input type="checkbox"/>	RESEARCH	Quality and depth of research
<input type="checkbox"/>	TESTS	General Test Scores
<input type="checkbox"/>	WORKEXP	Work Experience
<input type="checkbox"/>	WRITING	Writing Component

Select All
Clear All

This example illustrates the fields and controls on the Copy Evaluation Setup page (4 of 4). You can find definitions for the fields and controls later on this page

Select the Statuses to be copied					
Select	Evaluation Status	Effective Date	Status	Description	In Progress
<input type="checkbox"/>	ADMIT	01/01/1900	Active	ADMIT	<input type="checkbox"/>
<input type="checkbox"/>	ASSIGN	01/01/1900	Active	Assigned to Student	<input checked="" type="checkbox"/>
<input type="checkbox"/>	CMLTD	01/01/1900	Active	Evaluation Completed	<input type="checkbox"/>
<input type="checkbox"/>	FINAL	01/01/1900	Active	Final Status	<input type="checkbox"/>
<input type="checkbox"/>	INPROG	01/01/1900	Active	In Progress	<input checked="" type="checkbox"/>
<input type="checkbox"/>	NDINFO	01/01/1900	Active	Waiting for more information	<input checked="" type="checkbox"/>
<input type="checkbox"/>	WTCMTE	01/01/1900	Active	Waiting for Committee	<input checked="" type="checkbox"/>

Select All Clear All

Select the Recommendation Values to be copied					
Select	Recommendation	Effective Date	Status	Description	
<input type="checkbox"/>	ADMIT	01/01/1900	Active	ADMIT	
<input type="checkbox"/>	APPROV	01/01/1900	Active	Approve - Final	
<input type="checkbox"/>	DCLINE	01/01/1900	Active	Decline - no invitation for audition	
<input type="checkbox"/>	DENY	01/01/1900	Active	Denied - Final	
<input type="checkbox"/>	FAIL	01/01/1900	Active	Failed	
<input type="checkbox"/>	HOLD2R	01/01/1900	Active	Hold for 2nd review	
<input type="checkbox"/>	INVITE	01/01/1900	Active	Invite candidate for audition	
<input type="checkbox"/>	NONE	01/01/1900	Active	No Recommendation	
<input type="checkbox"/>	PASS	01/01/1900	Active	Passed	
<input type="checkbox"/>	PASSWR	01/01/1900	Active	Pass with restrictions	
<input type="checkbox"/>	WAITLIST	01/01/1900	Active	Wait List	

Select All Clear All

Copy Category

Since evaluation setup is keyed by Evaluation Category, for very granular evaluation constructs, your institution may need to create somewhat redundant setup scenarios under each category in the Evaluation Status, Recommendation, and Rating Components tables. For example, while a granular setup may exist for Thesis Review so that there are discreet categories by Academic Department that sponsor research candidates and will administer the thesis review process, there is commonality in the terms, nomenclature used in a thesis review, and among those setup tables which in fact could be shared. The copy functions on this page aid in reducing redundant data entry.

The system displays all setup associated with the category selected on the search page. In addition, the system displays all setup under the “copy from” Evaluation Category: committee schemes, committee codes, individual evaluator schemes, rating scheme, and values for evaluation status, recommendation, and rating components.

The fields on this page give you flexibility in the approach taken in copying over setup. If you want the identical setup under a new evaluation category, click the **Select All** and **Copy** buttons. However, if you want only some of the setup elements, you can choose which to copy over.

If you select one or more schemes, the system automatically selects the elements that are part of the selected scheme(s). If you deselect one of the elements, the system confirms that those elements will not be copied over.

There are Select All and Clear All buttons associated with each group box to assist with data selection. As you make each selection, the system automatically selects other associated setup elements that are used in a scheme.

Select the Committee Schemes to be Copied

This group box displays all committee schemes associated with the evaluation category. You can select all schemes or any combination of them. Click the **Committee Scheme** name link to review its properties on the Committee Scheme setup page. Selecting a committee scheme programmatically selects its downstream setup elements.

Select the Committee Codes to be Copied

This group box displays all committee codes associated with the evaluation category. You can select all codes or any combination of them. Some codes may already be selected because of the selected **Committee Scheme** in the previous group box.

Select the Individual Evaluator Schemes to be Copied

This group box displays all individual evaluator schemes associated with the evaluation category. You can select all codes or any combination of them. Click the **Individual Evaluator Scheme** name link to review its properties on the Individual Evaluator Scheme setup page. Selecting an individual evaluator scheme causes the system to automatically select other associated setup elements that are used in a scheme.

Select the Rating Schemes to be Copied

This group box displays all rating schemes associated with the evaluation category. You can select all codes or any combination of them. Click the **Rating Scheme** name link to review its properties on the Rating Scheme setup page. Selecting a rating scheme causes the system to automatically select the rating components that are used in the selected scheme.

Select the Rating Components to be Copied

Select values in this group box to copy them to the new evaluation category setup. If you previously selected a scheme, some values in this grid may already be selected. You can deselect those values; however, when you click **Copy**, the system generates messages advising that some values will not be copied.

Select the Statuses to be Copied

Select values in this group box to copy them to the new evaluation category setup.

Select the Recommendation Values to be Copied

Select values in this group box to copy them to the new evaluation category setup. If you previously selected a scheme, some values in this grid may already be selected. You can deselect those values; however, when you click **Copy**, the system generates messages advising that some values will not be copied.

Defining Evaluation Statuses

This section discusses how to set up evaluation status.

Page Used to Define Evaluation Statuses

<i>Page Name</i>	<i>Definition Name</i>	<i>Navigation</i>	<i>Usage</i>
Define Evaluation Status	SCC_GE_STAT_CD	Set Up SACR > Common Definitions > Evaluation Management System > Define Evaluation Status	Set up evaluation statuses.

Setting Up Evaluation Status

Access the Define Evaluation Status page (**Set Up SACR > Common Definitions > Evaluation Management System > Define Evaluation Status**).

This example illustrates the fields and controls on the Define Evaluation Status page. You can find definitions for the fields and controls later on this page

Evaluation status setup is keyed by evaluation category.

<i>Field or Control</i>	<i>Description</i>
Evaluation in Progress	Select this check box to indicate the evaluation is in progress; the system then directs whether changes to an evaluation can occur once it is underway.

Defining Recommendations

This section discusses how to set up evaluation recommendations.

Page Used to Define Recommendations

<i>Page Name</i>	<i>Definition Name</i>	<i>Navigation</i>	<i>Usage</i>
Define Recommendation	SCC_GE_RECMD_CD	Set Up SACR > Common Definitions > Evaluation Management System > Define Recommendation	Define evaluation recommendations.

Setting Up Evaluation Recommendations

Access the Define Recommendation page (**Set Up SACR > Common Definitions > Evaluation Management System > Define Recommendation**).

This example illustrates the fields and controls on the Define Recommendation page.

Define Recommendation

Evaluation Category: **ADMISSIONS** Admissions Application

Recommendation Value: **INVITE**

Find View All		First	1 of 1	Last
*Effective Date:	11/28/2011	*Effective Status:	Active	
*Description:	Invite candidate for audition			
Short Description:	Invite			

Recommendation setup is keyed by evaluation category.

Defining Rating Components

This section discusses how to set up rating components.

Page Used to Define Rating Components

<i>Page Name</i>	<i>Definition Name</i>	<i>Navigation</i>	<i>Usage</i>
Define Rating Component	SCC_GE_COMP_DEF	Set Up SACR > Common Definitions > Evaluation Management System > Define Rating Component	Define a criterion used during evaluation management.

Setting Up Rating Components

Access the Define Rating Component page (**Set Up SACR > Common Definitions > Evaluation Management System > Define Rating Component**).

This example illustrates the fields and controls on the Define Rating Component page. You can find definitions for the fields and controls later on this page.

Define Rating Component

Evaluation Category: **ADMISSIONS** Admissions Application

Rating Component: AUDITION

***Description:**

Short Description:

A **Rating Component** identifies a criterion that an evaluator should assess as part of the evaluation.

Defining Committees for Evaluation Management

The following table lists the tasks that you must perform to define committees.

<i>Task</i>	<i>Page</i>	<i>Navigation</i>	<i>Notes</i>
Setting Up Committee Types and Roles	Committee Type/Role	Campus Community > Committees > Committee Type/Role	The committee roles that you define on this Campus Community page are displayed on the Define Committee Scheme page of evaluation management.
Creating a Committee	Committee	Campus Community > Committees > Committees > Committee	The committees that you define on this Campus Community page are available for selection in the Define Committees page of evaluation management.
Assigning Committee Members	Committee Members	Campus Community > Committees > Committees > Committee Members	This page provides details for adding a member of a committee.

Refer to the following references for more information on these three pages:

See:

- [Understanding Committee Templates](#)
- [Creating Committees](#)

Defining Rating Schemes

This section discusses how to set up evaluation rating schemes.

Page Used to Define Rating Schemes

<i>Page Name</i>	<i>Definition Name</i>	<i>Navigation</i>	<i>Usage</i>
Define Rating Scheme	SCC_GE_RTNG_SCHEME	Set Up SACR > Common Definitions > Evaluation Management System > Define Rating Scheme	Define options for how a rating scheme is used during calculated evaluations, and individual and committee evaluations.

Setting Up Evaluation Rating Schemes

Access the Define Rating Scheme page (**Set Up SACR > Common Definitions > Evaluation Management System > Define Rating Scheme**).

This example illustrates the fields and controls on the Define Rating Scheme page. You can find definitions for the fields and controls later on this page.

Define Rating Scheme

Evaluation Category: ADMISSIONS Admissions Application
Rating Scheme: CALCEVAL

Rating Scheme Details Find | View All First 1 of 1 Last

*Effective Date: 01/01/1901 *Status: Active

*Description: Calculated scheme

Short Description: Calculated scheme

Comments:

Available for use with

Auto-Calculations

Committees

Individual Evaluators

Add/Delete Options

Allow Component Additions

Allow Component Deletions

Rule ID: SCC_RULE_ID_20140306170755 Rating Scheme Calculation Example

Rating Components Find | View All First 6 of 8 Last

*Rating Component: TESTS General Test Scores

*Calculation Method: Automatic Processing Order: 1 Rating Required

Rule ID: SCC_RULE_ID_20140303114951 Test Score Rule Example

Rating Values			Personalize Find	First 1-6 of 6 Last
*Rating Value	Description	Short Description		
10	ACT 14 <, SAT <1000	<15, <1000		
15	ACT 19 -15, SAT 1099 - 1000	19 -15, 1099 - 1000		
20	ACT 25 - 20 , SAT 1199 - 1100	25 - 20 , 1199 -1100		
25	ACT 29 - 26, SAT 1299 - 1200	29 - 26 , 1299 - 1200		
30	ACT 34 - 30, SAT 1399 - 1300	34 - 30, 1399 - 1300		
35	ACT 36 - 35, SAT 1600 - 1400	36 - 35, 1600 - 1400		

Available for use with

The options in this group box determine how a rating scheme can be used, whether by a *Committees* scheme, *Individual Evaluators* scheme, or by a scheme that uses *Auto-Calculations*. These settings control the values available for the **Rating Scheme** fields of the Committee Scheme and Individual Evaluator setup and the **Rating Scheme** field on the Evaluation Code setup. Committee Scheme and Individual Evaluator may be used concurrently. If you select *Auto-Calculations*, the other two options are unavailable. When you select *Auto-Calculations*, two Rule ID fields become available on the page: one at the scheme level and one for each rating component.

Note: A rating scheme marked as *Auto-Calculations* cannot also be used as an Individual Evaluator scheme or Committee scheme.

See [Setting Up and Using Rules for the Evaluation Management System](#)

Add/Delete Options

Field or Control	Description
Allow Component Deletion	<p>This option controls behavior on the Manage Evaluation component.</p> <p>Select this option to allow the system or a user to delete components under this scheme from an ID's evaluation record if the status for that scheme is not <i>Final</i>.</p>
Allow Component Addition	<p>This option controls behavior on the Manage Evaluation component.</p> <p>Select this option to allow the system or a user to add components under this scheme to a specific ID's evaluation record if the status for that scheme is not <i>Final</i>.</p> <p>The system prompts against valid designated rating scheme values.</p>

Rule ID

This field becomes available in the Rating Scheme Details group box when the rating scheme is marked for Auto-Calculations. This field is optional. When populated, the system will use this rule to calculate the Overall Rating value for the scheme. If no rule is designated for a rating component, then the system will calculate the Overall Rating using an average of the rating component values.

This field prompts from the values in the Rules Engine tables.

Rating Components

The fields in this group box define what evaluators can change or modify during the evaluation process.

Field or Control	Description
Rating Component	<p>Rating components roll up under the rating scheme. Rating components are defined on the Define Rating Component page.</p>
Calculation Method	<p>This field has no impact in the system.</p>
Processing Order	<p>This value is used by the system when the <i>Auto-Calculations</i> option is selected. Components that use Rules will be evaluated according to the Processing Order.</p>

Field or Control	Description
Rating Required	Select this check box to determine whether, on the Manage Evaluation component, this component rating must be completed by the evaluator or by an auto-calculation. If selected, the evaluation cannot be marked final unless this rating is populated.
Rule ID	<p>This field becomes available when the rating scheme is marked for Auto-Calculations. This field is optional. When populated, the system will use this rule to calculate the rating value for the component. If no rule is designated for a rating component, it is assumed that the rating value will be populated manually.</p> <p>This field prompts from the values in the Rules Engine tables.</p>
Rating Value	<p>This is a numerical field used to define a rating or scoring standard for the component being assessed. How rating values are used in an evaluation will differ when the rating scheme is marked as used for Auto-Calculations versus for Individual Evaluator or Committee schemes. When used for Auto-Calculations, if a Rule ID is present, then values populated here are used for descriptive purposes on the transaction pages in the Manage Evaluation component and in the Evaluation Center self-service pages. However, the actual rating standard or scale will be taken from the associated rule identified for the rating component. If no Rule ID is identified, at the transaction level, the rating field value will prompt against this setup for valid values for the corresponding rating component. Leave this field blank if no actual numerical rating range is required.</p> <p>For each rating value, the Description and Short Description fields enable you to provide text explanation.</p>

Defining Evaluation Committees

This section discusses how to link existing committees to evaluation committees.

Page Used to Define Committees

<i>Page Name</i>	<i>Definition Name</i>	<i>Navigation</i>	<i>Usage</i>
Define Committees	SCC_GE_COMM_DEF	Set Up SACR > Common Definitions > Evaluation Management System > Define Committees	Link Campus Community committee setup to Evaluation Management.

Linking Existing Committees to Evaluation Committees

Access the Define Committees page (**Set Up SACR > Common Definitions > Evaluation Management System > Define Committees**).

This example illustrates the fields and controls on the Define Committees page. You can find definitions for the fields and controls later on this page.

Define Committees						
Evaluation Category: ADMISSIONS Admissions Application						
*Eval Committee	*Institution	*Committee	Description	Committee Type	Description	
GRARTS	PSUNV	GRARTH	Graduate Art History	GRADMISS	Graduate Admissions Committee	+ -
TCS	PSUNV	TCS	Sociology Thesis Committee	TEST REV	Test Review Committee	+ -
TEST	PSUNV	TEST	Test Review Committee	TEST REV	Test Review Committee	+ -
UGEV01	PSUNV	UGEV01	UG Admissions Committee	UGADMISS	UG Admissions Committee	+ -

As noted in the section “Defining Committees for Evaluation Management”, Evaluation Management System (EMS) uses the existing Campus Community Committee setup. However, because those structures are keyed by institution, use this page to link the Campus Community Committee setup to an EMS Evaluation Committee. The **Eval Committee** values you set up here are used on the Define Committee Scheme page.

Related Links

[Defining Committees for Evaluation Management](#)

Defining Links for Self-Service Pages

This section discusses how to define links for self-service pages.

Page Used to Define Links

<i>Page Name</i>	<i>Definition Name</i>	<i>Navigation</i>	<i>Usage</i>
Define Link	SCC_GE_LINK_DEF	Set Up SACR > Common Definitions > Evaluation Management System > Define Link	Define valid links for individual evaluator and committee schemes, and evaluation codes under a specific evaluation category.

Setting Up Links

Access the Define Link page (**Set Up SACR > Common Definitions > Evaluation Management System > Define Link**).

This example illustrates the fields and controls on the Define Link page (for link type of BI Publisher Report). You can find definitions for the fields and controls later on this page.

Define Link

Evaluation Category: ADMISSIONS Admissions Application

Link Name APPLICANT PROFILE FOR COMMITTEES

***Link Type** BI Publisher Report Connected Query

Report Name QA_CSEMSRPT2 Additional Sample report

***Link Description** Committee Applicant Profile

This example illustrates the fields and controls on the Define Link page (for link type of URL). You can find definitions for the fields and controls later on this page.

Define Link

Evaluation Category: ADMISSIONS Admissions Application

Link Name IPEDES WEB SITE

***Link Type** URL IPEDES Site

URL Identifier EMS_IPEDS

***Link Description** Link to IPEDS site

Link setup is keyed by Evaluation Category

Field or Control	Description
Link Type	Two link types are delivered: <i>BI Publisher Report</i> and <i>URL</i> . Behavior of the remaining fields on the page will change based upon the link type that you select.
Report Name	This field is available when you select <i>BI Publisher Report</i> as the link type. This field prompts against the BI Publisher Report Definition table (Reporting Tools, BI Publisher, Report Definition, Definition).
URL Identifier	This field is available when you select <i>URL</i> as the link type. This field prompts from the URLs defined in the URL Maintenance page (PeopleTools, Utilities, Administration, URLs).
Link Description	The description defaults in from either the BI Publisher Report definition or the URL definition. You can change this default description.

For information on BI Publisher for PeopleSoft:

See product documentation for *PeopleTools: BI Publisher for PeopleSoft*

For information on URL Maintenance page:

See product documentation for *PeopleTools: System and Server Administration*, “Using Administration Utilities”

Defining Committee Schemes

This section discusses how to align committees with schemes.

Pages Used to Define Committee Schemes

Page Name	Definition Name	Navigation	Usage
Scheme Details	SCC_GE_COMM_SCHEME	Set Up SACR > Common Definitions > Evaluation Management System > Define Committee Scheme > Scheme Details	Define which committees are part of the committee scheme, what will be evaluated by the committees as indicated by the rating scheme value, a routing order if there are multiple committees, and valid recommendation values.

<i>Page Name</i>	<i>Definition Name</i>	<i>Navigation</i>	<i>Usage</i>
Self-Service Options	SCC_GE_CMSC_SS_OPT	Set Up SACR > Common Definitions > Evaluation Management System > Define Committee Scheme > Self-Service Options	<p>Configure options for deployment of the Additional Links section, Evaluation Overview page and Committee Collaboration page to the self-service pages in the Evaluation Center for committee members in the scheme. Options include: Additional Links for BI Publisher Reports which will contain data relevant to the evaluation and links to instructional content for conducting the evaluation, access to an Evaluation Overview page which gives more visibility to the activity in the evaluation and access to a Committee Collaboration page which gives visibility of activity in that committee.</p> <p>The settings here may work in conjunction with the Self-Service Options setting at the Evaluation Code level.</p>

Aligning Committees With Schemes

Access the Scheme Details page (**Set Up SACR > Common Definitions > Evaluation Management System > Define Committee Scheme > Scheme Details page**).

This example illustrates the fields and controls on the Scheme Details page. You can find definitions for the fields and controls later on this page.

You can set up multiple committees under a single committee scheme, all of which will evaluate using the same criteria.

Scheme Information

<i>Field or Control</i>	<i>Description</i>
Administrator	<p>Select an administrator for the scheme level. This administrator is responsible for entering recommendation and status for the scheme in the Manage Evaluation component or the Evaluation Decision Entry self-service page.</p> <p>If you leave this field blank, you can select an administrator in the Evaluation Schemes setup page where you assign the scheme to an evaluation code.</p> <p>See Setting Up Evaluation Codes.</p>

<i>Field or Control</i>	<i>Description</i>
Rating Scheme	Enter a value to designate what the committees under this scheme will be evaluating. Rating Schemes are defined on the Define Rating Scheme page, where the Evaluation Category is the same for this committee scheme.

Committees

<i>Field or Control</i>	<i>Description</i>
Committee Code	Enter one or more committees that you want to assign to this scheme. Committees are defined on the Define Evaluation Committee page.
Committee Order	<p>Enter a value here to establish the order in which the workflow should process the various committees.</p> <p>Workflow is the internal logic of EMS that determines the order in which evaluations should be added to the self-service worklist component of the evaluators and administrators. Workflow may also send an email notification at that time depending on the evaluation code setup.</p> <p>You can also define the workflow order among evaluators of an individual evaluator scheme in the Define Individual Evaluator Scheme page. Additionally, when you assign the committee schemes and/or individual evaluator schemes to an evaluation code during evaluation code setup, the workflow order among schemes can be defined. At this time, you can have the workflow not send the email notification but worklist addition is always done by the workflow according to the order.</p> <p>See:</p> <ul style="list-style-type: none"> • Defining Individual Evaluator Schemes • Setting Up Evaluation Codes <p>For information on the worklist, refer to Using Self-Service Worklist.</p> <p>For an example of how the EMS workflow processes the evaluators and administrators for an evaluation, refer to Entering Evaluations.</p>

Field or Control	Description
Administrator	Select an administrator for the committee level. This administrator is responsible for entering recommendation and status for the committee in the Manage Evaluation component or the Evaluation Decision Entry self-service page.
Members	Members listed here are populated from the Manage Committees component within Campus Community. If there are no committee members defined at that level, you cannot add them here. However, you can add members manually on the Manage Evaluation component or in bulk through the batch process.

Recommendation Values

Field or Control	Description
Recommendation Value	Enter all recommendation values that are applicable to this evaluation. The values apply to all committees that are part of the scheme. Recommendation values are defined on the Define Recommendation page.

Setting Up Self-Service Options

Access the Self-Service Options page (**Set Up SACR > Common Definitions > Evaluation Management System > Define Committee Scheme > Self-Service Options**).

This example illustrates the fields and controls on the Self-Service Options page. You can find definitions for the fields and controls later on this page.

Field or Control	Description
Evaluation Overview	<p>The value for this field determines the access a committee member may have to the Evaluation Overview page. The setting that you select here applies to all committee members in the scheme. Three values are delivered: <i>Show All</i>, <i>Do Not Show</i>, and <i>Show Completed</i>.</p> <ul style="list-style-type: none"> • Select <i>Show All</i> to display to the committee members all levels and activity in the evaluation, uncompleted or completed. • Select <i>Do Not Show</i> if committee members should not have view access to other levels and activity in the evaluation. • Select <i>Show Completed</i> to display to the committee members all levels and activity in the evaluation which are completed and have the default value of <i>Final</i>.

Additional Information Links

Use this group box to enter all the links that should be made available to the participants in this scheme. Links values are defined in the Define Links component. Adding a Link Name here defaults in the Link Description but you can change this description here, if for this scheme, another descriptive named is desired.

Link display may also be controlled by setup at the Evaluation Code level. If links populated there are *not* set as Administrator Only, then they will appear to the scheme participants. If a link is indicated at the Code level and repeated at the scheme level, then the repeated link will be filtered out so it will not appear twice. In that instance, the description from the Evaluation Code level will display. You may give an order to how you would like the links to display on the self-service page. If the same links are provided at the Evaluation Code level, then that level takes priority in terms of the display on the self-service page. In other words, Evaluation Code links will display as numbered, then the scheme links will display in the order indicated here, after the Code links

See Campus Community - Evaluation WorkCenter documentation for examples of how the Additional Information section appears on the self-service pages.

Committees

Field or Control	Description
Committee Code	Display-only field; the value defaults from the committee scheme setup.
Committee Collaboration Link	Select to display the committee collaboration link on the Committee Member self-service entry page.

Defining Individual Evaluator Schemes

This section discusses how to assign individuals to evaluator schemes.

Pages Used to Define Individual Evaluator Schemes

<i>Page Name</i>	<i>Definition Name</i>	<i>Navigation</i>	<i>Usage</i>
Scheme Details	SCC_GE_IE_SCHEME	Set Up SACR > Common Definitions > Evaluation Management System > Define Individual Evaluator Scheme > Scheme Details	Define which individuals are part of this scheme, what will be evaluated by the evaluator as indicated by the rating scheme value, a routing order if there are multiple evaluators, and valid recommendation values.
Self-Service Options	SCC_GE_IESC_SS_OPT	Set Up SACR > Common Definitions > Evaluation Management System > Define Individual Evaluator Scheme > Self-Service Options	<p>Configure options for deployment of the Additional Links section and Evaluation Overview page to the self-service pages in the Evaluation Center for evaluators in the scheme.</p> <p>Options include: Additional Links for BI Publisher Reports which will contain data relevant to the evaluation and links to instructional content for conducting the evaluation, and access to an Evaluation Overview page which gives more visibility to the activity in the evaluation.</p> <p>The settings on this page may be used in conjunction with the Self-Service Options setting at the Evaluation Code level.</p>

Assigning Individuals to Evaluator Schemes

Access the Scheme Details page ((**Set Up SACR > Common Definitions > Evaluation Management System > Define Individual Evaluator Scheme > Scheme Details**)).

This example illustrates the fields and controls on the Scheme Details page. You can find definitions for the fields and controls later on this page.

The individual evaluator scheme allows for an individual to act as an evaluator without having to be part of a committee. Evaluators can be indicated here, but can also be added on the administrative component.

Field or Control	Description
Administrator	<p>Select an administrator who is responsible for entering recommendation and status for the scheme in the Manage Evaluation component or the Evaluation Decision Entry self-service page.</p> <p>If you leave this field blank, you can select an administrator in the Evaluation Schemes setup page where you assign the scheme to an evaluation code.</p> <p>See Setting Up Evaluation Codes.</p>
Rating Scheme	<p>Enter a value to designate what the evaluators under this scheme will be evaluating. Rating Schemes are defined on the Define Rating Scheme page, where the Evaluation Category is the same for this scheme.</p>

Field or Control	Description
Evaluator Prompt Table	<p>Select the prompt table or view from which you want to assign evaluators to this scheme (evaluators are assigned to the scheme using the Evaluator ID field on this page).</p> <p>This prompt table defines a group of specific IDs from which evaluators can be assigned. For example, if you are using the Research Tracking feature, you may want to assign evaluators from a group of thesis evaluators. Use PeopleSoft Application Designer to create a prompt table.</p> <p>If you want to assign evaluators from any ID in the system regardless of their status (such as students, staff, recruiters, prospects, alumni and so on), select <i>PEOPLE_SRCH</i> as the evaluator prompt table.</p>
Evaluator ID	<p>Enter the ID of each person you want to assign to this scheme.</p> <p>The prompt values depend on the prompt table that you selected in the Evaluator Prompt Table field.</p>
Order	<p>Enter a value here to establish the order in which the workflow processes various individual evaluators. If you do not impose any order, all evaluators work in parallel.</p> <p>For information about workflow, refer to the Committee Order field description in the preceding Defining Committee Schemes section.</p> <p>See Defining Committee Schemes.</p>
Recommendation Value	<p>Enter all recommendation values that are applicable to this evaluation. The values apply to all individuals that are part of the scheme. Recommendation values are defined on the Define Recommendation page.</p>

Setting Up Self-Service Options

Access the Self-Service Options page (**Set Up SACR > Common Definitions > Evaluation Management System > Define Individual Evaluator Scheme > Self-Service Options**).

This example illustrates the fields and controls on the Self-Service Options page. You can find definitions for the fields and controls later on this page.

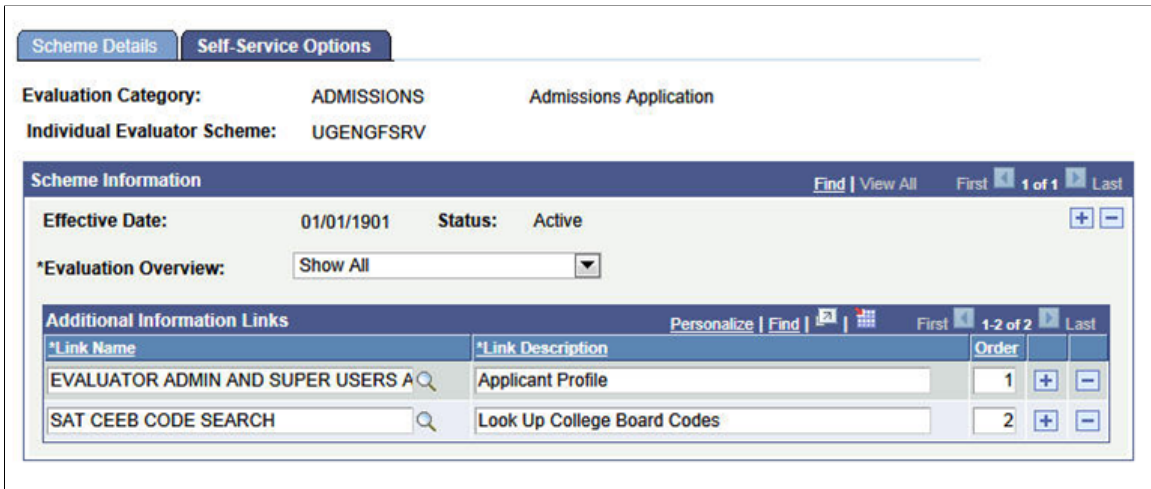

Field or Control	Description
Evaluation Overview	<p>The value for this field determines the access an evaluator may have to the Evaluation Overview page. The setting that you select here applies to all evaluators in the scheme. Three values are delivered: <i>Show All</i>, <i>Do Not Show</i>, and <i>Show Completed</i>.</p> <ul style="list-style-type: none"> • Select <i>Show All</i> to display to the evaluators all levels and activity in the evaluation, uncompleted or completed. • Select <i>Do Not Show</i> if evaluators should not have view access to other levels and activity in the evaluation. • Select <i>Show Completed</i> to display to the evaluators all levels and activity in the evaluation which are completed and have the default value of <i>Final</i>.

Additional Information Links

Use this group box to enter all links that should be made available to the participants in this scheme. Links values are defined in the Define Links component. Adding a Link Name here defaults in the Link Description but you can change this description here, if for this scheme, another descriptive named is desired.

Link display may also be controlled by setup at the Evaluation Code level. If links populated there are *not* set as Administrator Only, then they will appear to the scheme participants. If a link is indicated at the Code level and repeated at the scheme level, then the repeated link will be filtered out so it will not appear twice. In that instance, the description from the Evaluation Code level will display. You may give an order to how you would like the links to display on the self-service page. If the same links are provided at the Evaluation Code level, that level takes priority in terms of the display on the self-service page. In other words, Evaluation Code links will display as numbered, then the scheme links will display in the order indicated here, after the Code links.

See [Understanding Evaluation WorkCenter](#) for more information and examples of how the Additional Information section appears on the self-service pages.

Setting Up Evaluation Codes

This section discusses how to:

- Define evaluation code details.
- Set up evaluation schemes.
- Set up evaluation statuses.
- Set up self-service options.

Pages Used to Set Up Evaluation Codes

<i>Page Name</i>	<i>Definition Name</i>	<i>Navigation</i>	<i>Usage</i>
Evaluation Info	SCC_GE_EC_DEFN	Set Up SACR > Common Definitions > Evaluation Management System > Define Evaluation Code > Evaluation Info	Enter details for evaluation codes.
Evaluation Schemes	SCC_GE_EC_SCHEME	Set Up SACR > Common Definitions > Evaluation Management System > Define Evaluation Code > Evaluation Schemes	Specify administrator and notification options for each evaluation scheme.
Evaluation Statuses	SCC_GE_EC_STATUS	Set Up SACR > Common Definitions > Evaluation Management System > Define Evaluation Code > Evaluation Statuses	Specify which evaluation status and recommendation field values are to be used for an evaluation code.
Self-Service Options	SCC_GE_EC_SS_OPT	Set Up SACR > Common Definitions > Evaluation Management System > Define Evaluation Code > Self-Service Options	Configure options for deployment of the Additional Links section in the Evaluation Center for all evaluators associated in the evaluation. Additional Links may be for BI Publisher Reports which will contain data relevant to the evaluation and links to instructional content for conducting the evaluation. These links may be used in conjunction with setup on the Individual Evaluator Scheme and Committee Scheme levels.

Defining Evaluation Code Details

Access the Evaluation Info page (**Set Up SACR > Common Definitions > Evaluation Management System > Define Evaluation Code > Evaluation Info**).

This example illustrates the fields and controls on the Evaluation Info page (1 of 2). You can find definitions for the fields and controls later on this page.

Evaluation Info	Evaluation Schemes	Evaluation Statuses	Self-Service Options
Evaluation Category:	ADMISSIONS	Admissions Application	
Evaluation Code:	UGENG		
Evaluation Code Setup Find View All First 1 of 2 Last			
*Effective Date:	01/01/1901	*Effective Status:	Active
*Description:	Undergraduate Engineering		<input checked="" type="checkbox"/> Use Workflow Processing
Short Description:	Undergraduate Engineering		<input checked="" type="checkbox"/> Start Workflow Processing
Administrator:	CCEM0002	Rosaria Dunphy	
Calculated Scheme:	CALCEVAL	Calculated scheme	
*Calculated Scheme Option:	Do Not Hold Workflow		
Early Result Rule:	SCC_RULE_ID_20140604075859	Early Result Calc Evaluation Workflow Rule Example	
Comments:	<div style="border: 1px solid gray; height: 20px;"></div>		
Workflow Options			
Due Days:	3		
*Notification Option:	Always		
First Notification Template:	SCC_NTF_TMP_20130215180020	SCC_GE_NOTIFICATION	
Reminder Settings			
*Reminders Option:	Send Reminders		
Reminder frequency (days):	3		
Reminder Notification Template:	SCC_NTF_TMP_20130815120848	SCC_GE_REMINDER_NOTIFICATION	
Timeout Settings			
*Timeout Notification Option:	Send Notification		
Evaluation Admin Template:	SCC_NTF_TMP_20130815120925	SCC_GE_TIMEOUT_NOTIFICATION	
Other ID Template:	SCC_NTF_TMP_20130815120925	SCC_GE_TIMEOUT_NOTIFICATION	
Other ID to Notify:	CCEM0004	Anthony Sallington	

This example illustrates the fields and controls on the Evaluation Info page (2 of 2). You can find definitions for the fields and controls later on this page.

Recommended Prize Prompt

Record (Table) Name: 🔍

Field Name: 🔍

LOV Context: 🔍

Associated Schemes

*Scheme Type	*Scheme Name	Description	Rating Scheme	*Calculate Option	Order	
Individual Evaluato	UGENGFSRV	Undergraduate Engineering First Review	UGENGNR	On-going	1	+ -
Committee	UGENGCM1	Undergraduate Engineering Committee 1	UGENGNR	On-going	2	+ -
Individual Evaluato	ENGINDEAN	Undergraduate Engineering Dean	UGENGNR	On-going	3	+ -

The **Evaluation Code** that you define here incorporates many pieces of the evaluation process: evaluative schemes, evaluation flow and processing order, and values valid for the evaluation. In addition to defining the evaluation code, you also associate the code with rating schemes. For example, you can designate a single, calculated rating scheme while multiple individual evaluator and committee evaluation schemes can be pulled together under the evaluation code.

Field or Control	Description
Administrator	Designate a person to administer the evaluation and have oversight of the evaluation process. This Evaluation Administrator enters the final recommendation and evaluation in the Manage Evaluation component's Evaluation Overview page or the Evaluation Decision Entry self-service page.
Calculated Scheme	<p>Enter a scheme here to indicate that you want the system to automatically process the rating components that make up this scheme. The system uses that scheme name, its evaluative elements, and produces an overall rating value.</p> <p>The calculated scheme may be used in conjunction with Individual Evaluator and Committee schemes. You can direct how the calculated scheme interacts with those schemes and workflow by using the Calculated Scheme Option field.</p> <p>Rating schemes are set up on the Define Rating Scheme page.</p>

Field or Control	Description
Calculated Scheme Option	<p>This field becomes available when the Calculated Scheme field is populated and the Use Workflow Processing check box is selected. Two values are delivered: <i>Hold Workflow</i> and <i>Do Not Hold Workflow</i>. The options here represent how the calculated scheme should work in conjunction with Individual Evaluator or Committee Schemes present in the evaluation.</p> <p>Select <i>Hold Workflow</i> if all required components in the calculated scheme should be calculated and an Overall Rating calculated before starting workflow to initiate worklist items and notifications for evaluators.</p> <p>Select <i>Do Not Hold Workflow</i> if the workflow may proceed even though all required components in the calculated scheme may not be calculated and an Overall Rating calculated.</p>
Early Result Rule	<p>This field prompts against the Rules Engine tables and returns rules that are part of the EMS Early Result Rule Group. The rule identified here interacts with the Evaluation workflow code to determine whether an evaluation should stop or proceed at each order (if logic is present in the rule to check for each scheme order). When this field is populated, when an evaluator submits a final result then the rule will run to see if there is instruction on the workflow based on the evaluator results.</p> <p>See Setting Up and Using Rules for the Evaluation Management System for more detail on using an Early Result Rule.</p>

Field or Control	Description
Use Workflow Processing	<p>Workflow processing means:</p> <ul style="list-style-type: none"> • Adding an evaluation to the worklist of the evaluator or administrator when an evaluation is created manually on the Manage Evaluation component or through the Create and Maintain Evaluations batch process. • Sending an email notification to the evaluator or administrator when the evaluation is added to his or her worklist. <p>The worklist is list of evaluations that are open and ready for an evaluator's or administrator's review. Worklist appears on the Evaluation WorkCenter. Alternatively, evaluators and administrators can access the worklist from the navigation path: <i>Campus Community, Evaluation Management System, Evaluation WorkList.</i></p> <p>Select the Use Workflow Processing check box if you want to use workflow processing for the evaluation code. That is, if you select the Use Workflow Processing check box and subsequently create an evaluation for evaluation code, the workflow will add the evaluation to the worklists of the evaluators and administrators who are associated with this evaluation code.</p> <p>If you select the Use Workflow Processing check box, the Workflow Options group boxes becomes available on this page and the Evaluation Schemes page. Use the Notification Option field in these group boxes to specify whether or not you want the workflow to send an email notification to the evaluator or administrator when an evaluation is added to his or her worklist.</p> <hr/> <p>Important! Worklist generation and email notification uses the Notifications Framework. You should set up Notifications Framework before selecting the Use Workflow Processing check box.</p> <hr/> <p>See Understanding the Notifications Framework</p> <p>You will not want to select this check box if you do not want to use the Evaluation WorkCenter and want to manage the evaluations through the Manage Evaluation administrative component. The key difference between the worklist and Manage Evaluation component is that when an evaluator signs into the system, he or she can view and submit evaluations associated with all evaluators (including himself or herself) in the Manage Evaluation component but the Evaluation WorkCenter and the worklist display and allow submission of only those evaluations that are assigned to the signed in evaluator.</p>

Field or Control	Description
Start Workflow Processing	<p>This check box is available only if you select the Use Workflow Processing check box.</p> <p>Select this check box if you want the system to automatically start workflow processing at the evaluation creation stage, whether created manually through the Manage Evaluation component or created through batch processing.</p> <p>If you select this check box and the Calculated Scheme Option field is set to <i>Hold Workflow</i> and the batch calculation process (SCC_GE_CALC) calculates a value for all required rating components, then the batch process will attempt to start workflow for the evaluation.</p> <p>For more information on the batch calculation process, see Setting Up and Using Rules for the Evaluation Management System.</p> <p>If you do not select this check box, then you must manually trigger the workflow processing by clicking the Start Workflow button on the Manage Evaluation component's Evaluation Overview page. The button is available only when you save the Manage Evaluation component. If the evaluation was created by the Create and Maintain Evaluations batch process, you will see the button by navigating to Manage Evaluation component's Evaluation Overview page. You can also start workflow for a group of evaluations by using the Start Workflow process option in the Create and Maintain Evaluations batch process.</p> <hr/> <p>Important! An institution will have to consider carefully whether or not to select the Start Workflow Processing check box. If this check box is selected, the system will automatically trigger the workflow processing and that might cause problems if all the elements of the evaluation processing are not present in the system (for instance, missing evaluators or administrators). For those evaluations, where evaluators might be assigned on an ad-hoc basis after evaluation creation, it is most likely that the institution will want the Start Workflow Processing deselected and will want to manually trigger the workflow processing or use the start workflow process option via the batch process once they have updated an evaluation with all evaluators.</p> <hr/> <p>Important! Because of workflow processing, it is important that the proper use of an effective dated component be adhered to. If changes are needed to an evaluation code setup, then a new effective dated row should be added in order to ensure that the integrity of the data in the Manage Evaluation component and workflow processing are not affected.</p>

Notifications Framework and Evaluation Management System

EMS uses the Notifications Framework for generating the worklist and to send email notifications to evaluators and administrators. There are three types of email notifications that may be used as part of the evaluation flow:

- The initial notification to alert an evaluator that an evaluation is ready for his or her review.
- Reminder notifications to the evaluator about the pending evaluation.
- A timeout notification to advise the evaluator (and others) that an evaluation is past due.

EMS delivers a Notification Consumer Setup record that you can access from the Notification Consumer Setup page. Do not change the consumer name in this delivered Notification Consumer Setup record. Also, do not add a new Notification Consumer Setup record for EMS.

This delivered record has four templates:

- SCC_GE_WORKLIST (for worklist)
- SCC_GE_NOTIFICATION (for initial email notifications)
- SCC_GE_REMINDER_NOTIFICATION (for reminder notifications)
- SCC_GE_TIMEOUT_NOTIFICATION (for timeout notifications)

You can modify SCC_GE_NOTIFICATION, SCC_GE_REMINDER_NOTIFICATION, and SCC_GE_TIMEOUT_NOTIFICATION templates. You can also build new templates for email notifications and use the Notification Consumer Setup page to add these templates in the delivered Notification Consumer Setup record for EMS. For example, you might want a different subject line in the email notification sent to evaluators in graduate schemes as compared to evaluators in undergraduate schemes. In such a case, you might want to define two email notification templates.

Important! Do not modify the delivered SCC_GE_WORKLIST template or replace it with a new worklist template in the delivered Notification Consumer Setup record for EMS.

See Campus Community's Notifications Framework documentation.

Workflow Options

This group box is available only if you select the Use Workflow Processing check box.

This group box is for the evaluation administrator you specified in the Administrator field of this page. Therefore, once all the levels (that you set up in the Associated Schemes group box of this page) are complete and it is the evaluation administrator's turn to complete the evaluation, then these values in the Workflow Options group box will apply to this administrator stage of the evaluation.

Field or Control	Description
Due Days	<p>Enter the number of days the administrator has to complete their review. For example, if you enter 5 and the system assigns the evaluation to the administrator on March 3, 2013 and triggers the Notifications Framework on the same date, then the administrator has to complete the evaluation by March 8, 2013.</p> <p>The system calculates a due date from the number of days you enter in this field and populates the Notifications Framework PS_SCC_NTFREQ_ITM.SCC_NTF_DATE_TO field with that date.</p> <p>This field defaults to 0, which means the due date is the date when the Notifications Framework is triggered.</p> <p>The Evaluation Decision Entry self-service page displays the due date.</p>
Notification Option	<p>Select <i>Always</i> if you want the workflow to always send an email notification to the administrator when an evaluation is created for the evaluation code manually or through the batch process. Note that the workflow can send a notification only if you have selected the Start Workflow Processing option on this page or if you start the workflow for evaluations through the Manage Evaluation component or batch process.</p> <p>Select <i>Never</i> if you do not want the workflow to send a notification.</p> <p>This field is applicable only for the first notification that an administrator receives. You can choose not to send the first notification (by selecting <i>Never</i> in this field) but choose to send the reminder and timeout notifications using the Reminder Settings and Timeout Settings sections.</p>
First Notification Template	<p>Select the Notification Template ID of <i>email</i> notification type defined for the Evaluation Management System consumer.</p> <p>The system will use this template to send an <i>email</i> notification to the administrator after all other levels (schemes) of the evaluation are complete.</p>

Reminder Settings

Use this section to configure the reminder emails that the system sends to the evaluation administrator. Then, use the Notifications Framework's Worklist Batch process (SCC_NTFWKLTO) to generate the reminder notifications. The system will send reminders every number of days (specified in the Reminder Frequency field of this section) as long as the evaluation has not been completed and has not timed out.

For more information on the Worklist Batch process:

See Campus Community's Notifications Framework documentation.

Field or Control	Description
Reminders Option	<p>This field controls whether an email reminder notification will be sent and in what manner. Values for this field are:</p> <p><i>No reminders:</i> Select if you do not want the reminder notification to be sent. If you select this value, the Reminder frequency (days) and Reminder Notification Template fields become unavailable.</p> <p><i>One per Evaluation Code:</i> Select if you want to send one reminder to the administrator for the evaluation code. For example, suppose an evaluation administrator CCEM0012 is associated with multiple evaluations of an evaluation code Graduate Science (GRADSCI). GRADSCI is set to <i>One per Evaluation Code</i>. CCEM0012 is not associated with evaluations of any other evaluation code. When one or more of these evaluations need a reminder, the batch process will send only one reminder notification to CCEM0012. When using this setting, you may want to associate the code with a template where the content has a generic approach. For example: <i>You have Graduate Science evaluations waiting for review. Please login to the Evaluation Center to complete these evaluations.</i></p> <p><i>One per Evaluator:</i> Select if you want to send only one reminder to an evaluation administrator. For example, suppose evaluation administrator CCEM0012 is associated with multiple evaluations of evaluation code GRADSCI and multiple evaluations of evaluation code Research Thesis Nanotechnology (NANOTHESIS). Both evaluation codes are set to <i>One per Evaluator</i>. When one or more of these evaluations needs a reminder, the batch process will only send one reminder notification to CCEM0012. When using this setting, you may want to associate the code with a template where the content has a more generic approach as compared with a template for One per Evaluation Code. For example, the following notification for One per Evaluator does not specify the evaluation code: <i>You have evaluations waiting for review. Please login to the Evaluation Center to complete these evaluations.</i></p> <p><i>Send Reminders:</i> Select if you want to send a reminder for each evaluation that the evaluation administrator needs to complete. An evaluation administrator may be associated with multiple evaluations for multiple evaluation codes, and if you select this value, the batch process will send a notification to that evaluation administrator for each evaluation that needs a reminder. For example, assume that the evaluation administrator CCEM0012 has two evaluations for GRADSCI and three evaluations for NANOTHESIS. Based on the Reminders Frequency setting, all five evaluations need a</p>

Field or Control	Description
	<p>reminder. Because the setting is <i>Send Reminders</i> for both the evaluation codes, the evaluation administrator will receive five reminder notifications (one for each evaluation) when the batch process is run. When using the Send Reminders setting, the content of the template could be very specific indicating who the evaluation is for and the evaluation code.</p>
Reminder Frequency (days)	<p>Indicate how often the system should trigger a reminder. To determine when to trigger a reminder, the system uses the date the evaluation was assigned to the administrator (PS_SCC_NTFREQ_ITM.SCC_NTF_DATE_FROM) or the date the last reminder notification was sent (PS_SCC_NTFREQ_RMDR.SCC_NTFREQ_RMD_DTM). For example, suppose evaluation administrator CCEM0012 is assigned a GRADSCI evaluation on August 10, 2013. The Reminder Option is set to <i>Send Reminders</i> and the Reminder Frequency is set to 2. Assuming the administrator does not complete the evaluation (and the evaluation has not timed out), the following will happen:</p> <p>On August 12, 2013 a reminder notification will be generated. The last reminder date for the evaluation is set to August 12, 2013.</p> <p>On August 14, 2013 a reminder notification will be generated. The last reminder date for the evaluation is set to August 14, 2013.</p> <p>Reminders will continue to be generated in this fashion every 2 days until the evaluation is completed or times out.</p>
Reminder Notification Template	<p>Select a Notification Template ID of <i>email</i> notification type defined for the Evaluation Management System consumer. The template that you specify in this field will be used by Notifications Framework when sending a reminder to the evaluation administrator.</p>

Example of how the batch process sends a reminder notification if the evaluation administrator is associated with evaluation codes that have different reminder options:

Graduate Science (GRADSCI) is set up for reminders to be processed as *One per Evaluation Code*. Research Thesis Nanotechnology (NANOTHESIS) is set up as *One per Evaluator*. The evaluation administrator (CCEM0012) has two GRADSCI evaluations and two NANOTHESIS evaluation. These four evaluations have met the requirements for a reminder notification to be sent. How the process behaves is determined by which evaluation it processes first. If the process encounters a GRADSCI evaluation first, the system sends a reminder. Subsequently, when the process encounters a NANOTHESIS evaluation, it will not send a notification because NANOTHESIS is set up as *One per Evaluator*. Therefore, in this case, only one notification reminder is sent.

Conversely, if the process encounters the NANOTHESIS evaluation first, a reminder will be sent for NANOTHESIS. Subsequently, a reminder will also be sent for GRADSCI because it is set up as One per Evaluation Code. Therefore, in this case, two notification reminders are sent to CCEM0012.

Timeout Settings

This section enables email notifications to be sent when an evaluation is past due. Timeout notifications can be sent to the evaluation administrator and to another ID that you designate in this section.

The system will commence the timeouts when the worklist item is marked as ready and the PS_SCC_NTFREQ_ITM.SCC_NTF_DATE_TO date has passed. The Notifications Framework's Worklist Batch Process (PS_SCC_NTFWKLTO) generates the time out notifications. For information on setting up the process to run automatically every day:

See Campus Community's Notifications Framework documentation.

When the batch process runs, it sets the PS_SCC_NTFREQ_ITM.SCC_NTFREQ_SUB_STS = T. In terms of worklist, when an evaluation times out, it remains in the worklist until the evaluator completes the evaluation.

Note that self service indicates the due date and also indicates if the evaluation is overdue. For example, if an evaluation is overdue, the Evaluation Decision Entry self-service page displays a message indicating that the evaluation is past due.

<i>Field or Control</i>	<i>Description</i>
Timeout Notification Option	<p>This field controls whether timeout notifications will be sent to the evaluation administrator and the other designated ID.</p> <p>Values for this field are:</p> <p><i>Send Notification:</i> Select if you want timeout notifications to be sent.</p> <p><i>Do not send Notification:</i> Select if you do not want the timeout notifications to be sent. If you select this value, the other fields in this section become unavailable.</p>
Evaluation Admin Template	<p>Select a Notification Template ID of <i>email</i> notification type defined for the Evaluation Management System consumer.</p> <p>The template that you specify in this field will be used by Notifications Framework when sending a timeout notification to the evaluation administrator.</p>
Other ID Template	<p>Select a Notification Template ID of <i>email</i> notification type defined for the Evaluation Management System consumer.</p> <p>The template that you specify in this field will be used by Notifications Framework when sending a timeout notification to the person specified in the Other ID field.</p>
Other ID	<p>Select a ID to whom you want to send a timeout notification.</p>

Recommended Prize Prompt

The fields in this group box enable you to specify the table that the system should prompt against to return values for the **Recommend Prize** field in the Manage Evaluations administrative component. If you do not specify values in these fields, the system will use the Honors and Awards table as the default.

<i>Field or Control</i>	<i>Description</i>
Record (Table) Name	Enter the table name that the system should reference during prompting.
Field Name	Enter the field from the record that the system should reference during prompting.
LOV Context	If using with List of Values (LOV) functionality, enter the LOV context to be referenced. See Setting Up List of Values .

Associated Schemes

The fields in this group box list which individual or committee schemes are part of this evaluation.

<i>Field or Control</i>	<i>Description</i>
Scheme Type	Select either <i>Committee</i> or <i>Individual Evaluator</i> .
Scheme Name	Enter either an Individual Evaluator Scheme or Committee Scheme name, based on the value you selected in the Scheme Type field.
Calculate Option	Select <i>On-going</i> or <i>At End</i> to indicate whether the system should update overall ratings as ratings are entered for the evaluation, or wait until the end to calculate it.
Order	Enter a numeric value to establish the order in which the system should process the various levels.

Note: Specify each scheme's administrator and workflow settings on the Evaluation Schemes page.

Setting Up Evaluation Schemes

Access the Evaluation Schemes page (**Set Up SACR > Common Definitions > Evaluation Management System > Define Evaluation Code > Evaluation Schemes**).

This example illustrates the fields and controls on the Evaluation Schemes page (1 of 4). You can find definitions for the fields and controls later on this page.

Evaluation Info		Evaluation Schemes		Evaluation Statuses	
Evaluation Category	ADMISSIONS	Admissions Application			
Evaluation Code	GRADBUSN				
Evaluation Code Setup Find View All First 1 of 1 Last					
Effective Date:	01/01/1900	Effective Status:	Active + -		
Scheme Details Find View 1 First 1-4 of 4 Last					
*Scheme Type:	Individual Evaluator	Processing Order:	1 + -		
*Scheme Name:	GRADBUSN	Graduate Business First Review			
Administrator:	CCEM0012	Liam Hackensack			
*Calculate Option:	On-going	<input type="checkbox"/> Propagate results to scheme			
Workflow Options					
Due Days:	5				
*Notification Option:	Always				
First Notification Template:	SCC_NTF_TMP_20130215180020	SCC_GE_NOTIFICATION			
Reminder Settings					
*Reminder Option:	Send Reminders				
Reminder frequency (days):	3				
Reminder Notification Template:	SCC_NTF_TMP_20130815120848	SCC_GE_REMINDER_NOTIFICATION			
Timeout Settings					
*Timeout Option:	Send Notification				
Timed Out User Template:	SCC_NTF_TMP_20130815120925	SCC_GE_TIMEOUT_NOTIFICATION			
Parent Admin Template:	SCC_NTF_TMP_20130815120925	SCC_GE_TIMEOUT_NOTIFICATION			
Evaluation Admin Template:	SCC_NTF_TMP_20130815120925	SCC_GE_TIMEOUT_NOTIFICATION			
Other ID Template:	SCC_NTF_TMP_20130815120925	SCC_GE_TIMEOUT_NOTIFICATION			
Other ID to Notify:	CCEM0014	Lyle Poindexter			

This example illustrates the fields and controls on the Evaluation Schemes page (2 of 4). You can find definitions for the fields and controls later on this page.

*Scheme Type:	Individual Evaluator	Processing Order:	2
*Scheme Name:	GRADBUN2		Graduate Business Rev 2
Administrator:	CCEM0006		Celine Beaulieu
*Calculate Option:	On-going	<input type="checkbox"/>	Propagate results to scheme

Workflow Options
Due Days: 5
***Notification Option:** Never
First Notification Template:

Reminder Settings
***Reminder Option:** No Reminders
Reminder frequency (days):
Reminder Notification Template:

Timeout Settings
***Timeout Option:** Do not send Notification
Timed Out User Template:
Parent Admin Template:
Evaluation Admin Template:
Other ID Template:
Other ID to Notify:

This example illustrates the fields and controls on the Evaluation Schemes page (3 of 4). You can find definitions for the fields and controls later on this page.

*Scheme Type:	Committee	Processing Order:	3		
*Scheme Name:	GRADBUN		Graduate Business		
Administrator:	CCEM0015		Seneca Smith		
*Calculate Option:	On-going	<input checked="" type="checkbox"/>	Propagate results to scheme		
Workflow Options					
Due Days:	7				
*Notification Option:	Always				
First Notification Template:	SCC_NTF_TMP_20130215180020		SCC_GE_NOTIFICATION		
Reminder Settings					
*Reminder Option:	One per Evaluation Code				
Reminder frequency (days):	4				
Reminder Notification Template:	SCC_NTF_TMP_20130815120848		SCC_GE_REMINDER_NOTIFICATION		
Timeout Settings					
*Timeout Option:	Send Notification				
Timed Out User Template:	SCC_NTF_TMP_20130815120925		SCC_GE_TIMEOUT_NOTIFICATION		
Parent Admin Template:	SCC_NTF_TMP_20130815120925		SCC_GE_TIMEOUT_NOTIFICATION		
Evaluation Admin Template:	SCC_NTF_TMP_20130815120925		SCC_GE_TIMEOUT_NOTIFICATION		
Other ID Template:					
Other ID to Notify:					

This example illustrates the fields and controls on the Evaluation Schemes page (4 of 4). You can find definitions for the fields and controls later on this page.

The screenshot displays the 'Evaluation Schemes' configuration page. At the top, there are fields for:

- *Scheme Type:** A dropdown menu set to 'Committee'.
- Processing Order:** A text input field containing the number '4'.
- *Scheme Name:** A text input field containing 'GRBUSDEAN', with a magnifying glass icon and the text 'Graduate Business Dean's Committee' to its right.
- Administrator:** A text input field containing 'CCEM0012', with a magnifying glass icon and the text 'Liam Hackensack' to its right.
- *Calculate Option:** A dropdown menu set to 'On-going'.
- Propagate results to scheme**

 Below these are three sections:

- Workflow Options:**
 - Due Days:** A text input field containing '7'.
 - *Notification Option:** A dropdown menu set to 'Always'.
 - First Notification Template:** A text input field containing 'SCC_NTF_TMP_20130215180020', with a magnifying glass icon and the text 'SCC_GE_NOTIFICATION' to its right.
- Reminder Settings:**
 - *Reminder Option:** A dropdown menu set to 'One per Evaluator'.
 - Reminder frequency (days):** A text input field containing '4'.
 - Reminder Notification Template:** A text input field containing 'SCC_NTF_TMP_20130815120848', with a magnifying glass icon and the text 'SCC_GE_REMINDER_NOTIFICATION' to its right.
- Timeout Settings:**
 - *Timeout Option:** A dropdown menu set to 'Send Notification'.
 - Timed Out User Template:** A text input field containing 'SCC_NTF_TMP_20130815120925', with a magnifying glass icon and the text 'SCC_GE_TIMEOUT_NOTIFICATION' to its right.
 - Parent Admin Template:** An empty text input field with a magnifying glass icon.
 - Evaluation Admin Template:** An empty text input field with a magnifying glass icon.
 - Other ID Template:** A text input field containing 'SCC_NTF_TMP_20130815120925', with a magnifying glass icon and the text 'SCC_GE_TIMEOUT_NOTIFICATION' to its right.
 - Other ID to Notify:** A text input field containing 'CCEM0004', with a magnifying glass icon and the text 'Anthony Sallington' to its right.

Each scheme that you enter on the Evaluation Info page automatically appears on the Evaluation Schemes page. You can add more schemes on the Evaluation Schemes page and the system will add those schemes automatically to the Evaluation Info page.

Use the Evaluation Schemes page to specify the administrator and workflow options for each scheme. For example, if you entered four schemes in the Associated Schemes group box of the Evaluation Info page, use this page to specify the administrator and workflow options for each of the schemes.

Workflow options defined for each scheme apply to the administrator of the scheme and all members of the scheme.

Field or Control	Description
Administrator	Indicates the person responsible for the scheme who will enter the final results at the scheme level in the Manage Evaluation component's Individual Evaluator Scheme page or Committee Scheme page or the Evaluation Decision Entry self-service page. The system populates this field by default from the scheme setup level (Define Individual Evaluator Scheme and Define Committee Scheme pages). If an administrator value does not exist at the scheme setup level, the system populates this field by default from the Evaluation Info page. You can override the default value for this field.

Field or Control	Description
Calculate Option	<p>This field refers to the Overall Rating field associated with the scheme in the Manage Evaluation component's Individual Evaluator Scheme page or Committee Scheme page or the Evaluation Decision Entry self-service page and provides some control over how you will want the system to calculate the Overall Rating value.</p> <p><i>On-going:</i> Select if you want that the Overall Rating field should display the accumulative value as the evaluation progresses with evaluators entering rating values for each component in the Individual Evaluator Scheme page or Committee Scheme page or the Evaluation Decision Entry self-service page.</p> <p><i>At End:</i> Select if you want that the Overall Rating field should <i>not</i> display a value until all evaluators have provided rating values for each required component in the scheme and marked their evaluation <i>Final</i>.</p>
Processing Order	<p>This field establishes the order in which the workflow should process the various schemes.</p> <p>You can also define the workflow order among evaluators of an individual evaluator scheme in the Define Individual Evaluator Scheme page. Additionally, you can also define the workflow order among committees of a committee scheme in the Define Committee Scheme page.</p> <p>See Defining Individual Evaluator Schemes.</p> <p>See Defining Committee Schemes.</p> <p>For information on the self-service worklist, refer to “Using Self-Service Worklist” topic in Campus Community - Evaluation WorkCenter documentation.</p> <p>For an example of how the EMS workflow processes the evaluators and administrators for an evaluation, refer to “Entering Evaluations” topic in Campus Community - Evaluation WorkCenter documentation.</p>

Field or Control	Description
<p>Propagate results to scheme</p>	<p>If you select this check box, the system automatically completes the higher level(s) of the scheme when one of the following conditions is true:</p> <ul style="list-style-type: none"> • Only one evaluator exists in an individual evaluator scheme. • Only one committee exists in a committee scheme. • Only one evaluator exists in a committee. <p>Individual Evaluator Scheme: If only one evaluator exists in the scheme, the system will automatically complete the scheme level when the evaluator completes his or her evaluation. The system copies the values for recommendation, status, and overall rating to the scheme level.</p> <p>Committee Scheme: If only one committee exists in the scheme, the system will automatically complete the scheme level when the committee completes their evaluation. The system copies the values for recommendation, status, and overall rating to the scheme level.</p> <p>Committee: If only one evaluator exists in the committee, the system will automatically complete the committee level when the evaluator completes his or her evaluation. The system copies the values for recommendation, status, and overall rating to the scheme level. If there is only one committee in the scheme, the values will also be copied to the scheme level.</p> <hr/> <p>Note: When this check box is selected, the system does not send an email notification to the committee or scheme administrators whose evaluations were automatically marked as completed.</p> <hr/>

Workflow Options

Most of the fields in this group box are similar to those on the Evaluation Info page.

Use this group box to specify the due date, notification option for the first notification, email notification template, reminder settings and timeout settings for each scheme.

Schemes may have different due dates (for example, an individual evaluator scheme may take less days to complete the evaluation as compared to a committee scheme). For a scheme you may decide that the workflow should send the first email notification (by setting the scheme's notification option to *Always*), while for another scheme you may decide that the workflow should not send the first email notification (by setting the scheme's notification option to *Never*). In addition, schemes may have different first email notification templates (for example, members in an individual evaluator scheme may need less instructions in their email notifications as compared to members of a committee scheme).

The difference between the Timeout Settings sections on the Evaluation Schemes page and the Evaluation Info page is that the section on the Evaluation Schemes page contains two additional fields: Timed Out User Template and Parent Admin Template.

Field or Control	Description
Timed Out User Template	<p>Select a Notification Template ID of <i>email</i> notification type defined for the Evaluation Management System consumer.</p> <p>The template that you specify in this field will be used by Notifications Framework when sending a timeout notification to the evaluator or committee or scheme administrator who has the past due evaluation.</p>
Parent Admin Template	<p>Select a Notification Template ID of <i>email</i> notification type defined for the Evaluation Management System consumer.</p> <p>The template that you specify in this field will be used by Notifications Framework when sending a timeout notification to the person who is the immediate administrator of the evaluator who has the past due evaluation. Who that person is depends on where in the flow the evaluator is. For example, if it is an individual evaluator scheme, then for the evaluator, the immediate administrator will be the scheme administrator. If it is a Committee Scheme, then for a committee member, it would be the committee administrator. For a committee administrator, it would be the committee scheme administrator.</p>

Setting Up Evaluation Statuses

Access the Evaluation Statuses page (**Set Up SACR > Common Definitions > Evaluation Management System > Define Evaluation Code > Evaluation Statuses**).

This example illustrates the fields and controls on the Evaluation Statuses page. You can find definitions for the fields and controls later on this page

Designate Defaults

The fields in this group box list enable you to define default statuses for three key evaluation actions. The system will use these statuses for processing such as auto-calculation and the evaluation batch creation. The field values you enter here affect the values available in the Valid Status Codes group box.

<i>Field or Control</i>	<i>Description</i>
Default Status	Enter the default status value for the system to use during the batch evaluation code assignment process. The system will also use this value when you manually assign an evaluation code, but it can be overwritten. Statuses are defined on the Define Evaluation Status page.
Final Status Code	Enter the status value for the system to use to signify that the evaluation or a level of the evaluation is complete.
Hold Status Code	When an evaluation is placed on hold, this value will signify to the system to suspend processing for the evaluation.

Valid Status Codes

The fields in this group box enable you to indicate any statuses applicable to this evaluation. If you entered a default value in the Designate Defaults group box above, those values automatically display here. However, you can add to the list.

Note: The system forces all **Evaluation Status** codes you enter here at all levels throughout the evaluation (such as at the individual evaluator level, committee level, or committee member level).

Valid Recommendation Values

The fields in this group box enable you to indicate which recommendation values are applicable to this evaluation. The values you enter here apply to the highest level of the evaluation; you can designate other recommendation values at the individual evaluator and committee scheme levels.

Setting Up Self-Service Options

Access the Self-Service Options page (**Set Up SACR > Common Definitions > Evaluation Management System > Define Evaluation Code > Self-Service Options**).

This example illustrates the fields and controls on the Self-Service Options page. You can find definitions for the fields and controls later on this page

*Link Name	Administrator Only	*Link Description	Order
EVALUATOR ADMIN AND SUPER USERS A...	<input type="checkbox"/>	Applicant Profile	1
MANUAL	<input type="checkbox"/>	Evaluation Manual	2
SAT CEEB CODE SEARCH	<input type="checkbox"/>	Look Up College Board Codes	3
IPEDS WEB SITE	<input checked="" type="checkbox"/>	Link to IPEDS site	4

Additional Information Links

Use this group box to enter all links that should be made available to all the participants in this evaluation. Links values are defined in Define Links component. Adding a Link Name here defaults in the Link Description but you can change this description here, if for this code, another descriptive named is desired. Links may be designated as only for Administrator access and will only appear on the Evaluation Administrator self-service page.

Links may also be defined at the Individual Evaluator Scheme and Committee Scheme levels. If links populated at the scheme level are repeats of the Evaluation Code level setup (and not set as Administrator Only), then the repeated scheme link will be filtered out so it will not appear twice. In that instance, the description from the Evaluation Code level will display. You may give an order to how you would like the links to display on the self-service page. If the same links are provided at the scheme levels,

the Evaluation Code setup takes priority in terms of the display in the self-service page. In other words, Evaluation Code links will display as numbered, then the scheme links will display in the order indicated, after the Code links

See the Campus Community - Evaluation WorkCenter documentation for examples of how the Additional Information section appears on the self-service pages.

Setting Up Evaluation Management Security

This section discusses how to define security settings for evaluations.

Page Used to Set Up Evaluation Management Security

Page Name	Definition Name	Navigation	Usage
Evaluation Management Security	SCC_GE_SCRTY	Set Up SACR > Security > Secure Student Administration > Evaluation Management Security	Enter security settings for individual user IDs.

Defining Security Settings for Evaluations

Access the Evaluation Management Security page (**Set Up SACR > Security > Secure Student Administration > Evaluation Management Security**).

This example illustrates the fields and controls on the Evaluation Management Security page.

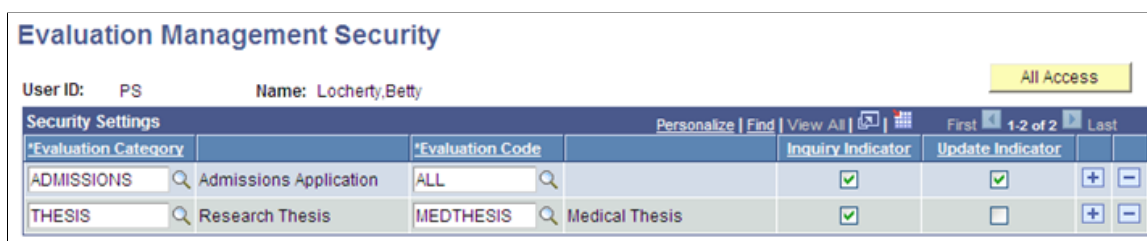

Setting Up and Using Rules for the Evaluation Management System

This topic discusses information about the system data that Campus Solutions provides with Evaluation Management System (EMS), and the way that EMS interacts with the Rules Engine. In addition to this required system data, Campus Solutions also provides sample rules as an introduction to how the Rules Engine can be used with the EMS feature. Because EMS is flexible and the data that may be evaluated will differ among evaluative processes, much of what is delivered is intended as examples to support our sample rules. For the Calculated Rating Scheme scenario, an admissions example was used where academic data and test score data is evaluated to produce an overall rating for a calculated rating scheme

in an evaluation. For the Early Result rule scenario, sample rules illustrate how a rule may be used to interact with the workflow. It is expected that you will want to create your own Entity Profiles, Rule Categories, and Rules to support your specific evaluation business needs.

This topic provides an overview of the Rules Engine and Entity Registry and discusses:

- Setting up and using rule categories for the Evaluation Management System.
- Using data sets.
- Setting up and using rule groups.
- Using sample rules.
- Evaluation Management System/Rules Engine integration.
- Modifying and using system data rules.

Note: The assigning of different colors to different Rules Engine Manager elements for purposes of displaying the Elements in different colors in user interfaces is *optional* and does not affect how a Rule is used in System processing. If no color setup is done, all Element text is displayed in black.

Understanding the Rules Engine and the Entity Registry

The Rules Engine accesses (that is, reads, creates, updates) data in the Campus Solutions database via a system object known as an Entity. An Entity can combine a set of system tables in a particular functional area, where a *base* entity can serve as the root of an entity *tree* representing the relationships between each element of a particular data structure. Each field in the actual table is represented as a property of the entity.

The structure and properties of an entity, as well as its relationships to other entities, are stored in the Entity Registry. Entities have been provided specifically for data encompassed by the EMS feature. In addition, a number of other entities exist in the Registry which may be leveraged for use in the Rules Engine. The following diagram illustrates the EMS hierarchical structure:

This example illustrates the EMS hierarchical structure.

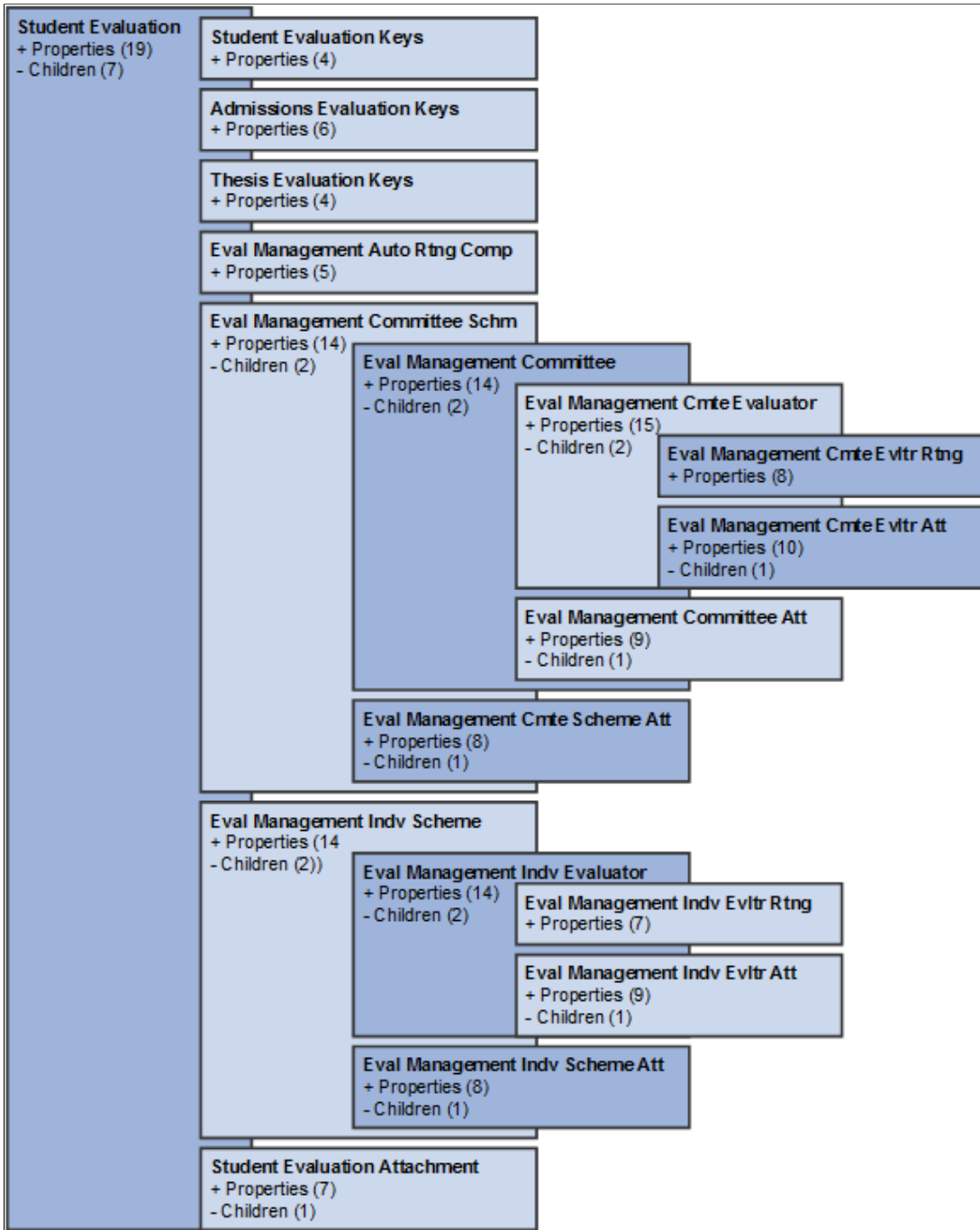

Note: We highly recommend that you do NOT update the EMS entities in your rules. The system is designed to handle evaluations in a specific manner and any outside updates could corrupt your evaluation data.

Entity Profiles

Because the Rules Engine always accesses data via the Entity Registry, the Entity Registry Entity Profile construct is used to restrict access to one or more entities, as well as the properties within a specific entity.

An Entity Profile is an important attribute of a Rule Category, which is the Rules Engine feature that governs security.

Related Links

[Setting Up the Rules Engine](#)

[Understanding Entity Registry](#)

[Setting Up Entity Profiles](#)

Setting Up and Using Rule Categories for the Evaluation Management System

A Rule Category controls the following:

- What data can be accessed by rules of this category: each category has an Entity Profile.
- Which rule groups (a user defined way of organizing and managing rules) are governed by this category.
- What system roles/users have access to create/update rules of this category.

Defining Rule Categories

Access the Rule Category - Definition page (**Set Up SACR > System Administration > Rules Engine Setup > Define Categories > Definition**).

This example illustrates the fields and controls on the Rule Category - Definition page for the Evaluation Management System Rule Category.

The screenshot shows the 'Definition' tab of the Rule Category configuration page. The 'Rule Category' is 'SCC_RULE_CAT_20140226144850' and the 'Rule Category Name' is 'Evaluation Management System'. The 'Long Description' is 'Evaluation Management System'. The 'Entity Profile Name' is 'System Profile EMS'. There are checkboxes for 'Available To All Categories', 'Allow Rules', 'Allow Functions', and 'Allow Triggers'. At the bottom, a table titled 'Valid Rule Categories' lists: DateTime, Math, Number, String, and Text Messages.

Valid Rule Categories
DateTime
Math
Number
String
Text Messages

Field or Control	Description
Entity Profile Name	<p><i>System Profile EMS:</i> This entity profile enables rules with this rule category to use the included system (delivered) entities as its ‘base’ entity. As noted earlier in this topic, this Entity Profile is intended as an example and likely will not meet the wide array of your evaluation business use cases.</p> <p>The image of the Entity Profile page (Set Up SACR, System Administration, Entity, Entity Profile) later in this section is just one illustration of the way that entities may be grouped into an Entity Profile to support the rules used under one Rule Category.</p>
Allow Rules, Allow Functions, Allow Triggers	<p>These check boxes indicate the Rules Engine privileges available to roles (or an individual user) authorized for this rule category. As delivered, this Evaluation Management System Category definition enables users to create Rules and Functions. As noted above, it is likely that you will create your own rule categories and set these check boxes according to your business needs.</p>
Valid Rule Categories	<p>Valid rule categories allow a user with explicit security access to a rule category (as defined on the Rule Category security page – see later in this documentation), in this case Evaluation Management System, to call rules from these categories without having specific access to those categories.</p> <p>For example user CSUSER-01 has access to Evaluation Management System. When creating a rule of this category, CSUSER-01 can call rules with any of the specified categories here, but cannot create a rule with one of those categories.</p>

As mentioned in the discussion of the Entity Profile Name field (on the Definition page), this image illustrates just one way that entities may be grouped into an Entity Profile to support the rules used under a rule category.

Entity Profile ID: SCC_EPRFL_20140226141343

Entity Profile Name: System Profile EMS

Profile Description: System Profile for Evaluation Management System

*Profile Type: Rules Engine

Parent Profile:

Entity Name	*Entity View	Base Entity	View	Hierarchy		
Academic History	Complete	<input checked="" type="checkbox"/>	View	Hierarchy	+	-
Academic Program	Complete	<input checked="" type="checkbox"/>	View	Hierarchy	+	-
Admissions Evaluation Keys	Complete	<input type="checkbox"/>	View	Hierarchy	+	-
Eval Management Auto Rtng Comp	Complete	<input type="checkbox"/>	View	Hierarchy	+	-
Eval Management Cmt Evltr Rtng	Complete	<input type="checkbox"/>	View	Hierarchy	+	-
Eval Management Cmte Evaluator	Complete	<input type="checkbox"/>	View	Hierarchy	+	-
Eval Management Committee	Complete	<input type="checkbox"/>	View	Hierarchy	+	-
Eval Management Committee Schm	Complete	<input type="checkbox"/>	View	Hierarchy	+	-
Eval Management Ind Evltr Rtng	Complete	<input type="checkbox"/>	View	Hierarchy	+	-
Eval Management Indv Evaluator	Complete	<input type="checkbox"/>	View	Hierarchy	+	-
Eval Management Indv Scheme	Complete	<input type="checkbox"/>	View	Hierarchy	+	-
External Academic Data	Complete	<input checked="" type="checkbox"/>	View	Hierarchy	+	-
External Academic Summary	Complete	<input checked="" type="checkbox"/>	View	Hierarchy	+	-
Student Evaluation	Complete	<input checked="" type="checkbox"/>	View	Hierarchy	+	-
Student Evaluation Keys	Complete	<input type="checkbox"/>	View	Hierarchy	+	-
Test CAF	Complete	<input type="checkbox"/>	View	Hierarchy	+	-
Test Date	Complete	<input type="checkbox"/>	View	Hierarchy	+	-
Test Score	Complete	<input checked="" type="checkbox"/>	View	Hierarchy	+	-
Test Score Component	Complete	<input type="checkbox"/>	View	Hierarchy	+	-
Thesis Evaluation Keys	Complete	<input type="checkbox"/>	View	Hierarchy	+	-

Defining Rule Category Rule Groups

Access the Rule Category - Rule Groups page (Set Up SACR > System Administration > Rules Engine Setup > Define Categories > Rule Groups).

This example illustrates the fields and controls on the Rule Category - Rule Groups page for Evaluation Management System.

Field or Control	Description
Rule Group Required	If this check box is selected, users with this rule category must always create a rule from a rule group listed in the Valid Rule Groups grid.

Defining Rule Category Security

Access the Rule Category - Security page (**Set Up SACR > System Administration > Rules Engine Setup > Define Categories > Security**).

This example illustrates the fields and controls on the Rule Category - Security page for Evaluation Management System.

Security can be granted via role or by specific User ID.

Note: The Evaluation Management System Rule Category has been delivered with a Valid Role value of *CS - Rules Administrator*. However while this Role Definition is delivered, you must associate it to User Profiles where appropriate.

Viewing Rule Category Information

Access the Rule Category - Cross Reference page (**Set Up SACR > System Administration > Rules Engine Setup > Define Categories > Cross Reference**).

This example illustrates the fields and controls on the Rule Category - Cross Reference page for Evaluation Management System.

Definition
Rule Groups
Security
Cross Reference

Rule Category SCC_RULE_CAT_20140226144850

Rule Category Name Evaluation Management System

Rule Cross Reference
Personalize | Find | View 10 | |
First 1-17 of 17 Last

Rule Name	Version	Rule Status
Academic Qualification Example	1	Active
Courses Completed Requirement Example	1	Active
Early Result Calc Evaluation Workflow Rule Example	1	Active
Early Result Evaluation Workflow Rule Example	1	Active
Get ACT Rating Value Example	1	Active
Get Course Count Rating Example	1	Active
Get Course Requirement Rating Example	1	Active
Get Courses Completed Count Example	1	Active
Get GPA Rating Example	1	Active
Get High School Rating Driver Example	1	Active
Get High School Rating Example	1	Active
Get Highest Test Component Score Example	1	Active
Get Percentile Rating Example	1	Active
Get SAT I Rating Value Example	1	Active
Get Test Component Scores Example	1	Active
Rating Scheme Calculation Example	1	Active
Test Score Rule Example	1	Active

Rule Group Cross Reference
Personalize | Find | View All | |
First 1-3 of 3 Last

Rule Group Name	Rule Group Status
EMS Early Result	Active
EMS Rating Component Calculation	Active
EMS Rating Scheme Calculation	Active

This category is not used by any system variables

This category is not used by any triggers

Use the Cross Reference page to view rules, rule groups, system variables and triggers that use this rule category.

Related Links

[Defining Rule Category Security](#)

Using Data Sets

The following Data Set definitions are used in the delivered Rule Groups. The delivered data sets can be accessed in the Rules Engine Define Data Sets component: **Set Up SACR > System Administration > Rules Engine Setup > Define Data Set**.

Data Set ID	Name	Long Description	Purpose
SCC_ENTITY_ 20140226150042	EMS Evaluation Information	EMS Evaluation Information	This data set aggregates relevant information about the evaluation. Used to pass Evaluation data to rules.
SCC_ENTITY_ 20140226150400	EMS Evaluation Keys	EMS Evaluation Keys	<p>This data set contains evaluation key data (for example: Evaluation Instance, EMPLID, INSTITUTION). Used to pass key data to rules in a generic fashion (for example, KEY_1, KEY_2, and so on).</p> <hr/> <p>Note: EMPLID and INSTITUTION properties have been added to the EMS Evaluation Information Data Set to simplify access to those fields.</p> <hr/>
SCC_ENTITY_ 20140226150717	EMS Evaluation XRef Keys	EMS Evaluation Cross-Reference Keys	This data set contains the Cross-Reference Keys of the Evaluation. Used to pass key data to rules in a generic fashion (for example, KEY_1, KEY_2, and so on).
SCC_ENTITY_ 20140226152106	EMS Rating Component	EMS Rating Component	This data set contains Rating Component fields. Used to pass Rating Component Information to rules.
SCC_ENTITY_ 20140514150139	EMS Evaluator Decision Info	EMS Evaluator Decision Information	This data set contains fields pertaining to the Evaluator, Scheme, Overall Rating, recommendation for a Scheme.

Related Links

[Setting Up Rules Engine Variables](#)

Setting Up and Using Rule Groups

A rule group provides a way of grouping rules that share a common functional purpose. The rule group can serve as a template for creating a rule and determines how the rules that are based on it will operate. The Rule Group definition controls what the rule requires as inputs, that is, what types of data – what data elements – need to be passed into the rule in order for a determination to be made. Rule output is also determined by the rule group definition.

See [Defining Rule Groups](#)

The following Rule Group definitions can be accessed in the Rules Engine Rule Group component (**Set Up SACR > System Administration > Rules Engine > Define Rule Groups**).

EMS Rating Component Calculation Rule Group

This example shows the Define Rule Group - Definition page for the EMS Rating Component Calculation Rule Group.

Definition	Categories	Cross Reference																																																																																
System Data																																																																																		
Rule Group ID	SCC_RULEGR_ID_20140226153734	Action <input type="text"/>																																																																																
Rule Group Status	Active	Used by 3 rules.																																																																																
Rule Group Name	EMS Rating Component Calculation																																																																																	
Long Description	EMS Rating Component Calculation																																																																																	
Rule Usage	Function																																																																																	
	<input type="checkbox"/> Available To Be Used																																																																																	
<table border="1"> <thead> <tr> <th colspan="2">Variables</th> <th>Personalize</th> <th>Find</th> <th>View All</th> <th>First</th> <th>1-8 of 8</th> <th>Last</th> </tr> <tr> <th>Variable Name</th> <th>Type</th> <th>List</th> <th>System</th> <th>Input</th> <th>Output</th> <th>Required</th> <th>Details</th> </tr> </thead> <tbody> <tr> <td>Dynamic Rule Variable</td> <td>Text</td> <td><input type="checkbox"/></td> <td><input type="checkbox"/></td> <td><input checked="" type="checkbox"/></td> <td><input type="checkbox"/></td> <td><input checked="" type="checkbox"/></td> <td></td> </tr> <tr> <td>Evaluation Information</td> <td>Data Set</td> <td><input type="checkbox"/></td> <td><input type="checkbox"/></td> <td><input checked="" type="checkbox"/></td> <td><input type="checkbox"/></td> <td><input checked="" type="checkbox"/></td> <td></td> </tr> <tr> <td>Evaluation Keys</td> <td>Data Set</td> <td><input type="checkbox"/></td> <td><input type="checkbox"/></td> <td><input checked="" type="checkbox"/></td> <td><input type="checkbox"/></td> <td><input checked="" type="checkbox"/></td> <td></td> </tr> <tr> <td>Evaluation XRef Keys</td> <td>Data Set</td> <td><input type="checkbox"/></td> <td><input type="checkbox"/></td> <td><input checked="" type="checkbox"/></td> <td><input type="checkbox"/></td> <td><input type="checkbox"/></td> <td></td> </tr> <tr> <td>Rating Scheme</td> <td>Text</td> <td><input type="checkbox"/></td> <td><input type="checkbox"/></td> <td><input checked="" type="checkbox"/></td> <td><input type="checkbox"/></td> <td><input checked="" type="checkbox"/></td> <td></td> </tr> <tr> <td>Rating Component Information</td> <td>Data Set</td> <td><input type="checkbox"/></td> <td><input type="checkbox"/></td> <td><input checked="" type="checkbox"/></td> <td><input type="checkbox"/></td> <td><input checked="" type="checkbox"/></td> <td></td> </tr> <tr> <td>Result Rating Value</td> <td>Number</td> <td><input type="checkbox"/></td> <td><input type="checkbox"/></td> <td><input type="checkbox"/></td> <td><input checked="" type="checkbox"/></td> <td></td> <td></td> </tr> <tr> <td>Result Calculated</td> <td>True/False</td> <td><input type="checkbox"/></td> <td><input type="checkbox"/></td> <td><input type="checkbox"/></td> <td><input checked="" type="checkbox"/></td> <td></td> <td></td> </tr> </tbody> </table>			Variables		Personalize	Find	View All	First	1-8 of 8	Last	Variable Name	Type	List	System	Input	Output	Required	Details	Dynamic Rule Variable	Text	<input type="checkbox"/>	<input type="checkbox"/>	<input checked="" type="checkbox"/>	<input type="checkbox"/>	<input checked="" type="checkbox"/>		Evaluation Information	Data Set	<input type="checkbox"/>	<input type="checkbox"/>	<input checked="" type="checkbox"/>	<input type="checkbox"/>	<input checked="" type="checkbox"/>		Evaluation Keys	Data Set	<input type="checkbox"/>	<input type="checkbox"/>	<input checked="" type="checkbox"/>	<input type="checkbox"/>	<input checked="" type="checkbox"/>		Evaluation XRef Keys	Data Set	<input type="checkbox"/>	<input type="checkbox"/>	<input checked="" type="checkbox"/>	<input type="checkbox"/>	<input type="checkbox"/>		Rating Scheme	Text	<input type="checkbox"/>	<input type="checkbox"/>	<input checked="" type="checkbox"/>	<input type="checkbox"/>	<input checked="" type="checkbox"/>		Rating Component Information	Data Set	<input type="checkbox"/>	<input type="checkbox"/>	<input checked="" type="checkbox"/>	<input type="checkbox"/>	<input checked="" type="checkbox"/>		Result Rating Value	Number	<input type="checkbox"/>	<input type="checkbox"/>	<input type="checkbox"/>	<input checked="" type="checkbox"/>			Result Calculated	True/False	<input type="checkbox"/>	<input type="checkbox"/>	<input type="checkbox"/>	<input checked="" type="checkbox"/>		
Variables		Personalize	Find	View All	First	1-8 of 8	Last																																																																											
Variable Name	Type	List	System	Input	Output	Required	Details																																																																											
Dynamic Rule Variable	Text	<input type="checkbox"/>	<input type="checkbox"/>	<input checked="" type="checkbox"/>	<input type="checkbox"/>	<input checked="" type="checkbox"/>																																																																												
Evaluation Information	Data Set	<input type="checkbox"/>	<input type="checkbox"/>	<input checked="" type="checkbox"/>	<input type="checkbox"/>	<input checked="" type="checkbox"/>																																																																												
Evaluation Keys	Data Set	<input type="checkbox"/>	<input type="checkbox"/>	<input checked="" type="checkbox"/>	<input type="checkbox"/>	<input checked="" type="checkbox"/>																																																																												
Evaluation XRef Keys	Data Set	<input type="checkbox"/>	<input type="checkbox"/>	<input checked="" type="checkbox"/>	<input type="checkbox"/>	<input type="checkbox"/>																																																																												
Rating Scheme	Text	<input type="checkbox"/>	<input type="checkbox"/>	<input checked="" type="checkbox"/>	<input type="checkbox"/>	<input checked="" type="checkbox"/>																																																																												
Rating Component Information	Data Set	<input type="checkbox"/>	<input type="checkbox"/>	<input checked="" type="checkbox"/>	<input type="checkbox"/>	<input checked="" type="checkbox"/>																																																																												
Result Rating Value	Number	<input type="checkbox"/>	<input type="checkbox"/>	<input type="checkbox"/>	<input checked="" type="checkbox"/>																																																																													
Result Calculated	True/False	<input type="checkbox"/>	<input type="checkbox"/>	<input type="checkbox"/>	<input checked="" type="checkbox"/>																																																																													

This Rule Group definition has been designed specifically for use in the creation of rules that will calculate a rating value for a Rating Component. When a rule using this Rule Group is invoked, the system populates the input variables with data from the evaluation that is being processed. The rule is responsible for setting values for the output variables *Result Rating Value* and *Result Calculated*. The *Result Rating Value* represents the Rating Value that has been calculated for the Rating Component. The *Result Calculated* variable indicates if the Rating Component should be updated with the *Result Rating Value* calculated by the rule. *Result Calculated* must be set to *True* in order for the Rating Component to be updated with the Rating Value calculated by the rule. The following variables are included in the Rule Group definition:

Variable/Argument	Description
Dynamic Rule Variable	System created for all rule groups to facilitate usage of the <i>Dynamic Rule Group</i> statement by passing in the Rule ID that needs to be called. Value is blank and is not used for this rule group. See Defining Rule Category Security

Variable/Argument	Description
Evaluation Information	Data Set containing general information about the evaluation being processed (Instance, Category, Code, Setup EFFDT, ID, and Institution). Populated automatically by the system.
Evaluation Keys	Data Set containing the main keys for an evaluation (for example, Key 1 = Instance, Key 2 = ID, Key 3 = Institution). Populated automatically by the system.
Evaluation XRef Keys	Data Set containing the Cross Reference Keys for an evaluation. For example, an Admissions Evaluation using the SCC_GE_XRF_APPL Cross reference record will have fields mapped as follows: <ul style="list-style-type: none"> • Key 1 = Instance • Key 2 = Academic Career • Key 3 = Student Career Number • Key 4 = Application Number • Key 5 = Application Program Number Populated automatically by the system.
Rating Scheme	The Rating Scheme in which the Rating Component resides. Populated automatically by the system.
Rating Component Information	Data Set containing the current values for the Rating Component being evaluated.
Result Rating Value	The rating value calculated by the rule for the Rating Component. Defaults to zero. The rule is responsible for populating this variable.

Variable/Argument	Description
Result Calculated	<p>True/False indicator which the rule is responsible for setting. Defaults to False.</p> <p>If the rule returns a value of False, the Rating Component will not be updated (for example, the existing Rating Value for the Rating Component will not change).</p> <p>If the rule returns a value of True, and the value in Result Rating Value is valid, the Rating Component will be updated (for example, the Rating Value for the Rating Component will be updated with the value returned in the Result Rating Value variable.)</p>

A Rule Group also determines the data that can be accessed by a rule, according to the rule categories that are associated with it. A Rule Group must be associated with at least one Rule Category. The EMS Rating Component Calculation Rule Group has been associated with the delivered Rule Category *Evaluation Management System* and is therefore subject to the Entity Profile System Profile EMS.

This example shows the Define Rule Groups - Categories page for the EMS Rating Component Calculation rule group.

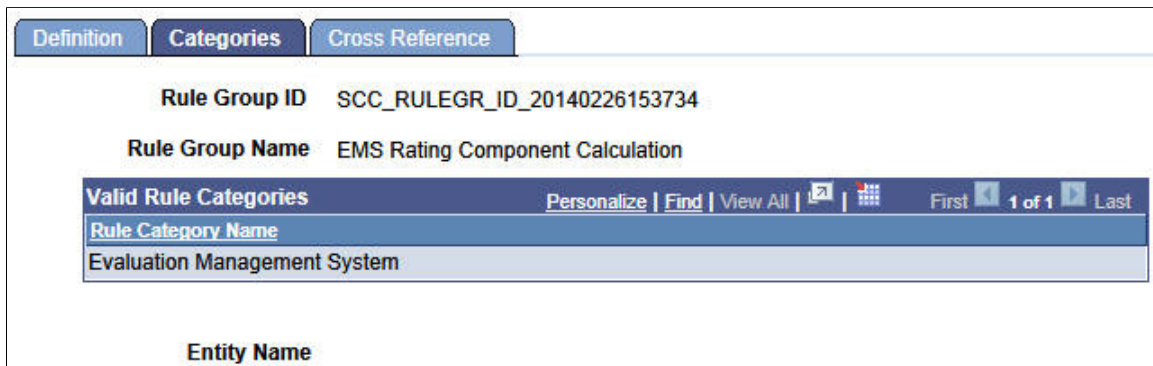

It is intended that this delivered Rule Group is used by users to create rules that calculate rating value results for rating components that are part of an EMS calculated rating scheme.

EMS Rating Scheme Calculation Rule Group

This example shows the Define Rule Group - Definition page for the EMS Rating Scheme Calculation Rule Group.

Definition
Categories
Cross Reference

System Data

Rule Group ID: SCC_RULEGR_ID_20140226154255 Action:

Rule Group Status: Active Used by 1 rules.

Rule Group Name: EMS Rating Scheme Calculation

Long Description: EMS Rating Scheme Calculation

Rule Usage: Function

Available To Be Used

Variables		Personalize	Find	View All	First	1-5 of 5	Last
Variable Name	Type	List	System	Input	Output	Required	Details
Dynamic Rule Variable	Text	<input type="checkbox"/>	<input type="checkbox"/>	<input checked="" type="checkbox"/>	<input type="checkbox"/>	<input checked="" type="checkbox"/>	
Rating Scheme	Text	<input type="checkbox"/>	<input type="checkbox"/>	<input checked="" type="checkbox"/>	<input type="checkbox"/>	<input checked="" type="checkbox"/>	
Rating Component List	Data Set	<input checked="" type="checkbox"/>	<input type="checkbox"/>	<input checked="" type="checkbox"/>	<input type="checkbox"/>	<input type="checkbox"/>	
Result Overall Rating	Number	<input type="checkbox"/>	<input type="checkbox"/>	<input type="checkbox"/>	<input checked="" type="checkbox"/>	<input type="checkbox"/>	
Result Calculated	True/False	<input type="checkbox"/>	<input type="checkbox"/>	<input type="checkbox"/>	<input checked="" type="checkbox"/>	<input type="checkbox"/>	

This Rule Group definition has been designed specifically for use in the creation of rules that will calculate the overall rating value for a Rating Scheme based on the rating component rating values. When a rule using this rule group is invoked, the system populates the input variables with data from the evaluation that is being processed. The rule is responsible for setting values for the output variables *Result Overall Rating* and *Result Calculated*. The *Result Overall Rating* represents the Overall Rating that has been calculated for the Rating Scheme. The *Result Calculated* variable indicates if the rating scheme should be updated with the *Result Overall Rating* calculated by the rule. *Result Calculated* must be set to *True* in order for the Rating Scheme to be updated with the Overall Rating calculated by the rule. The following variables are included in the Rule Group definition:

Variable/Argument	Description
Dynamic Rule Variable	System created for all rule groups to facilitate usage of the <i>Dynamic Rule Group</i> statement by passing in the Rule ID that needs to be called. Value is blank and is not used for this rule group. See Defining Rule Category Security
Rating Scheme	The Rating Scheme being evaluated. Populated automatically by the system.
Rating Component List	A list of Rating Component Information Data Sets. Each entry in the list represents a Rating Component that is in the Rating Scheme. Populated automatically by the system.

Variable/Argument	Description
Result Overall Rating	The Overall Rating calculated by the rule for the Rating Scheme. Defaults to zero. The rule is responsible for populating this variable.
Result Calculated	<p>True/False indicator which the rule is responsible for setting. Defaults to False.</p> <p>If the rule returns a value of False, the Overall Rating for the Rating Scheme will not be updated (for example, the existing Overall Rating will not change).</p> <p>If the rule returns a value of True, the Overall Rating for the Rating Scheme will be updated (for example, the Overall Rating will be changed to the value returned in the <i>Result Overall Rating</i> variable).</p>

It is intended that this delivered Rule Group is used by users to create rules that calculate the overall rating value for an EMS calculated rating scheme.

EMS Early Result Rule Group

This example shows the Define Rule Group - Definition page for the EMS Early Result Rule Group.

System Data

Rule Group ID: SCC_RULEGR_ID_20140514151404 Action:

Rule Group Status: Active Used by 2 rules.

Rule Group Name: EMS Early Result

Long Description: EMS Early Result

Rule Usage: Function

Available To Be Used

Variable Name	Type	List	System	Input	Output	Required	Details
Dynamic Rule Variable	Text	<input type="checkbox"/>	<input type="checkbox"/>	<input checked="" type="checkbox"/>	<input type="checkbox"/>	<input checked="" type="checkbox"/>	
Evaluation Information	Data Set	<input type="checkbox"/>	<input type="checkbox"/>	<input checked="" type="checkbox"/>	<input type="checkbox"/>	<input checked="" type="checkbox"/>	
Evaluation Keys	Data Set	<input type="checkbox"/>	<input type="checkbox"/>	<input checked="" type="checkbox"/>	<input type="checkbox"/>	<input checked="" type="checkbox"/>	
Evaluation XRef Keys	Data Set	<input type="checkbox"/>	<input type="checkbox"/>	<input checked="" type="checkbox"/>	<input type="checkbox"/>	<input type="checkbox"/>	
Overall Rating	Number	<input type="checkbox"/>	<input type="checkbox"/>	<input checked="" type="checkbox"/>	<input type="checkbox"/>	<input type="checkbox"/>	
Evaluator List	Data Set	<input checked="" type="checkbox"/>	<input type="checkbox"/>	<input checked="" type="checkbox"/>	<input type="checkbox"/>	<input type="checkbox"/>	
Early Result	True/False	<input type="checkbox"/>	<input type="checkbox"/>	<input type="checkbox"/>	<input checked="" type="checkbox"/>	<input type="checkbox"/>	
Route To Administrator	True/False	<input type="checkbox"/>	<input type="checkbox"/>	<input type="checkbox"/>	<input checked="" type="checkbox"/>	<input type="checkbox"/>	
Recommendation	Text	<input type="checkbox"/>	<input type="checkbox"/>	<input type="checkbox"/>	<input checked="" type="checkbox"/>	<input type="checkbox"/>	
Recommended Prize	Text	<input type="checkbox"/>	<input type="checkbox"/>	<input type="checkbox"/>	<input checked="" type="checkbox"/>	<input type="checkbox"/>	

This Rule Group definition has been designed specifically for use in evaluating the result at a specific order in the evaluation to determine whether the workflow should stop or continue. When a rule using this

rule group is invoked, the system will populate the input variables with data from the evaluation that is being processed. The rule is responsible for setting values for the output variables *Early Result*, *Route to Administrator*, *Recommendation*, and *Recommend Prize*. The following variables are included in the Rule Group definition:

Variable/Argument	Description
Dynamic Rule Variable	<p>System created for all rule groups to facilitate usage of the <i>Dynamic Rule Group</i> statement by passing in the Rule ID that needs to be called. Value is blank and is not used for this rule group.</p> <p>See Defining Rule Category Security</p>
Evaluation Information	<p>Data Set containing general information about the evaluation being processed (Instance, Category, Code, Setup EFFDT, ID, and Institution). Populated automatically by the system.</p>
Evaluation Keys	<p>Data Set containing the main keys for an evaluation (such as Key 1 = Instance, Key 2 = ID, Key 3 = Institution). Populated automatically by the system.</p>
Evaluation XRef Keys	<p>Data Set containing the Cross Reference Keys for an evaluation. For example, an Admissions Evaluation using the SCC_GE_XRF_APPL cross reference record will have fields mapped as follows:</p> <p>Key 1 = Instance</p> <p>Key 2 = Academic Career</p> <p>Key 3 = Student Career Number</p> <p>Key 4 = Application Number</p> <p>Key 5 = Application Program Number</p> <p>Populated automatically by the system.</p>
Overall Rating	<p>The Overall Rating value from an evaluator (or committee member) result or from a scheme level result.</p>
Evaluator List	<p>A variable defined from the EMS Evaluator Decision Info Data Set. Aggregates all evaluators in the evaluation along with certain fields that can help determine the evaluation outcome.</p>

Variable/Argument	Description
Early Result	<p>True/False indicator; the rule is responsible for setting. Defaults to <i>False</i>.</p> <p>If the rule returns a value of <i>False</i>, the workflow for the evaluations continues, creating worklist items and notifications (if set up) for the next evaluators in the order.</p> <p>If the rule returns a value of <i>True</i>, the workflow ceases; it creates no further worklist items or notifications. All remaining levels in the evaluation are greyed. The values indicated in the rule for Recommendation and Recommend Prize are populated at the high level of the evaluation (Evaluation Overview page in the Manage Evaluation component and the Evaluation Status is set to <i>Final</i>).</p>
Route to Administrator	<p>True/False indicator; the rule is responsible for setting. Defaults to <i>False</i>. Use this variable if the Early Result variable = <i>True</i>. While remaining levels of the evaluation are closed down, you do want the Evaluation Administrator to review. If the rule returns a value of <i>False</i>, no further action occurs and the evaluation is finalized. If the rule returns a value of <i>True</i>, a worklist item is created for the administrator and a notification can be sent. Recommendation and Recommend Prize fields will be populated if specified in the rule but not greyed down. The Evaluation Status field remains as set as determined for the Assigned default value in the Evaluation Code setup (in other words not changed to the Default for 'final' status).</p>
Recommendation	<p>The rule is responsible for setting this output variable. The value specified in the rule populates the Recommendation field on the Evaluation Overview page in the Manage Evaluation component.</p>
Recommend Prize	<p>The rule is responsible for setting this output variable. The value specified in the rule populates the Recommend Prize field on the Evaluation Overview page in the Manage Evaluation component.</p>

Using Sample Rules

Oracle has delivered seventeen sample rules based on the Rule Category described above. Three of those rules are based on the Rule Group EMS Rating Component Calculation; one is based on the Rule Group EMS Rating Scheme Calculation and two are based on the Early Result Rule Group. The rules are intended as examples that you can take and clone or rebuild under your own Rules Engine Category as you begin to assess how you can implement and leverage Rules Engine functionality in Evaluation Management System. The sample rules delivered as system data represent a simple use case for an

admissions evaluation to demonstrate how a calculated rating scheme might be used to automate an evaluation.

Note: These rules use Campus Solutions sample data: you will need to modify values to use the rules. See the Modifying and Using System Data Rules section later in this topic.

The sample rules can be accessed using the Rules Engine Manager Component (**Set Up SACR > System Administration > Rules Engine Manager**).

In our examples for the Rating Component Calculation and Rating Scheme Calculation rule groups, there are four main rules which call other rules:

- Academic Qualification Example
- Courses Completed Requirement Example
- Test Score Rule Example
- Rating Scheme Calculation Example

For the Early Result Rule group, we have provided two sample rules:

- Early Result Calc Evaluation Workflow Rule Example
- Early Result Evaluation Workflow Rule Example

Below we take a closer look at a rule from the Rating Component Calculation rule group and the Early Result rule group to see how the rules may be compromised.

SCC_RULE_ID_20140303114951 Test Score Rule Example - Rating Component Calculation Rule Group

This rule returns a rating value for the rating component based on the highest score value in a comparison of ACT scores and SAT 1 scores. Calls a number of rules to get the scores from the test score records, evaluate those results against a rating scale to obtain the rating value to populate the rating component. Rules called from the Test Score Rule Example are:

- ↳ SCC_RULE_ID_20140226160705 Get Highest Test Component Score
 - ↳ SCC_RULE_ID_20140226155857 Get Test Component Scores
- ↳ SCC_RULE_ID_20140304120320 Get ACT Rating Value
- ↳ SCC_RULE_ID_20140304121526 Get SAT 1 Rating Value

Rule Evaluation Calculation Statement	Process Description/Definition
CALL Function Get Highest Test Component Score passing in Evaluation Information.ID as in_EMPLID, ACT as in_TEST_ID, COMP as in_TEST_COMPONENT returning out_Highest_Score as highest_ACT_Score	Calls the function 'Get Highest Test Component Score' passing in values for EMPLID, TEST_ID and TEST_COMPONENT. In this case the function returns the Highest ACT Composite score for the EMPLID.

Rule Evaluation Calculation Statement	Process Description/Definition
CALL Function Get Highest Test Component Score passing in Evaluation Information.ID as in_EMPLID, SAT 1 as in_TEST_ID, MATH as in_TEST_COMPONENT returning out_Highest_Score as highest_SAT_1_MATH_Score	Calls the function 'Get Highest Test Component Score' passing in values for EMPLID, TEST_ID and TEST_COMPONENT. In this case the function returns the Highest SAT 1 Math score for the EMPLID.
CALL Function Get Highest Test Component Score passing in Evaluation Information.ID as in_EMPLID, SAT 1 as in_TEST_ID, VERB as in_TEST_COMPONENT returning out_Highest_Score as highest_SAT_1_VERB_Score	Calls the function 'Get Highest Test Component Score' passing in values for EMPLID, TEST_ID and TEST_COMPONENT. In this case the function returns the Highest SAT 1 Verbal score for the EMPLID.
CALL Function Add passing in highest_SAT_1_MATH_Score as Value 1, highest_SAT_1_VERB_Score as Value 2 returning Result as SAT_1_Total	Calls the function 'Add' passing in the Highest SAT 1 Math score and the Highest SAT 1 Verbal score to calculate a SAT 1 Total score.
CALL Function Get ACT Rating Value passing in highest_ACT_Score as in_ACT_Score returning out_Rating as ACT_Rating	Calls the function 'Get ACT Rating Value' passing in the Highest ACT Composite score. The function returns an ACT Rating based on the score passed in.
CALL Function Get SAT 1 Rating Value passing in SAT_1_Total as in_SAT_1_Total returning out_Rating as SAT_1_Rating	Calls the function 'Get SAT 1 Rating Value' passing in the SAT 1 Total score. The rule returns a SAT 1 Rating based on the score passed in.
IF ACT_Rating > SAT_1_RATING - ASSIGN Result Rating Value = ACT_Rating ELSE IF ACT_Rating > SAT_1_Rating - ASSIGN Result Rating Value = SAT_1_Rating	If the ACT Rating is greater than the SAT 1 Rating, the ACT Rating is assigned to the Result Rating Value output variable. Otherwise, the SAT 1 Rating is assigned to the Result Rating Value output variable.
ASSIGN Result Calculated = True	The Result Calculated output variable is set to True to indicate the rule has successfully calculated a value for the Result Rating Value output variable.

SCC_RULE_ID_20140226160705 - Get Highest Test Component Score Example

Rule Evaluation Calculation Statement	Process Description/Definition
CALL Rule Get Test Component Scores passing in in_EMPLID as in_EMPLID, in_TEST_ID as in_TEST_ID, in_TEST_COMPONENT as in_TEST_COMPONENT returning out_Test_Score_list as test_score_list	Calls the rule 'Get Test Component Scores' passing in the EMPLID, TEST_ID and TEST_COMPONENT. A list of Test Scores is returned. If no test scores of this type are found for the EMPLID an empty list will be returned.

<i>Rule Evaluation Calculation Statement</i>	<i>Process Description/Definition</i>
CALL Function Max passing in test_score_list as List of Values returning Maximum as out_Highest_Score	Calls the function Max passing in a list of Test Scores. The function returns the maximum test score in the list. The function returns zero if the test score list is empty.

SCC_RULE_ID_20140226155857 - Get Test Component Scores Example

<i>Rule Evaluation Calculation Statement</i>	<i>Process Description/Definition</i>
CLEAR LIST Using List out_Test_Score_list	Initializes the Test Score List output variable to empty.
FOR EACH Test Score Component - Process Immediate Children Only	Loop through each Test Score Component that is returned based on the statements in the Criteria section of this rule.
- IF Test Score Component.Test Component = in_TEST_COMPONENT - ADD TO LIST Using List out_Test_Score_list Value Test Score Component.Test Score	If the Test Component is equal to the value in the Test Component input variable, add the Test Score to the Test Score List output variable.

SCC_RULE_ID_20140304120320 - Get ACT Rating Value Example

Rule Evaluation Calculation Statement	Process Description/Definition
<pre> IF in_ACT_Score > 0 - IF in_ACT_Score >= 35 - ASSIGN out_Rating = 35 - ELSE IF in_ACT_Score >= 30 - IF in_ACT_Score >= 30 - ASSIGN out_Rating = 30 - ELSE IF in_ACT_Score >= 25 - IF in_ACT_Score >= 25 - ASSIGN out_Rating = 25 - ELSE IF in_ACT_Score >= 20 - IF in_ACT_Score >= 20 - ASSIGN out_Rating = 20 - ELSE IF in_ACT_Score >= 15 - IF in_ACT_Score >= 15 - ASSIGN out_Rating = 15 - ELSE IF in_ACT_Score >= 10 - ASSIGN out_Rating = 10 </pre>	<p>Calculates a Rating Value based on the ACT Score input variable by using a series of IF/ELSE statements.</p> <p>The function returns a rating when the ACT Score is greater than zero. Otherwise, the function returns zero.</p>

SCC_RULE_ID_20140304121526 - Get SAT 1 Rating Value Example

Rule Evaluation Calculation Statement	Process Description/Definition
IF in_SAT_1_Total > 0 And in_SAT_1_Total <= 1600 - IF in_SAT_1_Total >= 1400 - ASSIGN out_Rating = 35 - ELSE IF in_SAT_1_Total >= 1400 - IF in_SAT_1_Total >= 1300 - ASSIGN out_Rating = 30 - ELSE IF in_SAT_1_Total >= 1300 - IF in_SAT_1_Total >= 1200 - ASSIGN out_Rating = 25 - ELSE IF in_SAT_1_Total >= 1200 - IF in_SAT_1_Total >= 1100 - ASSIGN out_Rating = 20 - ELSE IF in_SAT_1_Total >= 1100 - IF in_SAT_1_Total >= 1000 - ASSIGN out_Rating = 15 - ELSE IF in_SAT_1_Total >= 1000 - ASSIGN out_Rating = 10	Calculates a Rating Value based on the SAT 1 Total input variable by using a series of IF/ELSE statements. The function returns a rating when the total is greater than zero and less than or equal to 1600. Otherwise, the function returns zero.

SCC RULE ID 20140519124427 Early Result Evaluation Workflow Rule Example - Rating Component Calculation Rule Group

This rule can return an Early Result variable value of *True* based on the outcomes of the segment of the evaluation using Overall Rating and Recommendation values as the determinant.

Rule Evaluation Calculation Statement	Process Description/Definition
LENGTH OF LIST Using List Evaluator List Returning Length in evaluatorCount	Returns a count of evaluators in the evaluation.
IF evaluatorCount > 0	From the EvaluatorList results, if evaluator count is greater than 0, then proceed in evaluating the evaluator types and accompanying conditions.

Rule Evaluation Calculation Statement	Process Description/Definition
<pre> - FOR EACH Evaluator List - ASSIGN Evaluator = Evaluator List - IF Evaluator.Evaluator Type = 5 And Evaluator.Scheme = LAFIRSTREV And Evaluator.Overall Rating >= 30 - ASSIGN Early Result = True, Route To Administrator = False, Recommendation = ADMIT, Recommended Prize = MCL - IF Evaluator.Evaluator Type = 5 And Evaluator.Scheme = LAFIRSTREV And Evaluator.Overall Rating <= 10 - ASSIGN Early Result = True, Route To Administrator = False, Recommendation = DENY - EXIT FOR EACH - IF Evaluator.Evaluator Type = 4 And Evaluator.Scheme = UGLAFACREV And Evaluator.Recommendation = ADMIT - ASSIGN Early Result = True, Route To Administrator = False, Recommendation = ADMIT - IF Evaluator.Evaluator Type = 4 And Evaluator.Scheme = UGLAFACREV And Evaluator.Recommendation = DENY - ASSIGN Early Result = True, Route To Administrator = True, Recommendation = DENY - EXIT FOR EACH - IF Evaluator.Evaluator Type = 3 And Evaluator.Scheme = LADEANREV And Evaluator.Overall Rating >= 35 And Evaluator.Recommendation = ADMIT - ASSIGN Early Result = True, Route To Administrator = True, Recommendation = ADMIT, Recommended Prize = DEANLS - IF Evaluator.Evaluator Type = 3 And Evaluator.Scheme = LADEANREV And Evaluator.Overall Rating <= 15 And (Evaluator.Recommendation = DENY Or Evaluator.Recommendation = WAITLIST) - ASSIGN Early Result = True, Route To Administrator = True, Recommendation = DENY - EXIT FOR EACH </pre>	<p>Using a series of IF statements evaluates the statement conditions to return the Early Result value, Recommendation and Recommend Prize values when met.</p>

Rules Belonging to the Evaluation Management System Category

Rule ID	Name	Long Description
SCC_RULE_ID_20140306170755	Rating Scheme Calculation Example	This rule can be used at the Evaluation Rating Scheme level as an alternate calculation of the Overall Rating value for the scheme. This example returns the sum of the component rating values.
SCC_RULE_ID_20140303114951	Test Score Rule Example	This rule returns a rating value for the rating component based on the highest score value in a comparison of ACT scores and SAT 1 scores. Calls a number of rules to get the scores from the test score records, evaluate those results against a rating scale to obtain the rating value to populate the rating component.
SCC_RULE_ID_20140306173039	Academic Qualification Example	This rule returns a rating value to the rating component based on education data fields of percentile rank and converted GPA contained in External Academic Summary. Calls a number of other rules which get the GPA and percentile values, evaluate those results against a rating scale to obtain the rating value to populate the rating component.
SCC_RULE_ID_20140306172622	Courses Completed Requirement Example	This rule returns a rating value to the rating component based on a count of completed subjects in External Academic Subjects.
SCC_RULE_ID_20140304120320	Get ACT Rating Value Example	Returns the rating value for an ACT score.
SCC_RULE_ID_20140306141320	Get Course Count Rating Example	Gets the rating value for Course Count.
SCC_RULE_ID_20140306143945	Get Course Requirement Rating Example	Returns a rating value based on the number of Courses Completed for all Academic History entries that have External Academic Data rows where External Career = HS and Transcript Type = OFF.

Rule ID	Name	Long Description
SCC_RULE_ID_20140306161125	Get Courses Completed Count Example	Returns a count of completed courses in External Academic Subjects.
SCC_RULE_ID_20140304123947	Get GPA Rating Example	Returns the rating value for a GPA.
SCC_RULE_ID_20140304162158	Get High School Rating Example	Gets the highest rating value of the Converted GPA and Percentile values and passes to Get High School Rating Driver rule.
SCC_RULE_ID_20140304170413	Get High School Rating Driver Example	Loops through External Academic Data where External Career = HS for an EMPLID and calls Get High School Rating. Returns the highest High School Rating.
SCC_RULE_ID_20140226160705	Get Highest Test Component Score Example	Returns the highest score for the specified EMPLID, TEST_ID, and TEST_COMPONENT.
SCC_RULE_ID_20140304155504	Get Percentile Rating Example	Returns the rating value for a Percentile Rank.
SCC_RULE_ID_20140304121526	Get SAT 1 Rating Value Example	Returns a rating value for a SAT 1 Test Score Total.
SCC_RULE_ID_20140226155857	Get Test Component Scores Example	Returns a list of test component scores for the specified EMPLID, TEST_ID and TEST_COMPONENT.
SCC_RULE_ID_20140604075859	Early Result Calc Evaluation Workflow Rule Example	Early Result Calc Evaluation Workflow Rule Example – multiple schemes including a calculated scheme.
SCC_RULE_ID_20140519124427	Early Result Evaluation Workflow Rule Example	Early Result Evaluation Workflow Rule Example

Evaluation Management Rules Engine Rule Hierarchy for rules in the Rating Component Calculation Rule Group

SCC_RULE_ID_20140306173039 Academic Qualification Example

- └ SCC_RULE_ID_20140304170413 Get High School Rating Driver
 - └ SCC_RULE_ID_20140304162158 Get High School Rating

- └ SCC_RULE_ID_20140304123947 Get GPA Rating
- └ SCC_RULE_ID_20140304155504 Get Percentile Rating

SCC_RULE_ID_20140306172622 Courses Completed Requirement Example

- └ SCC_RULE_ID_20140306143945 Get Course Requirement Rating
 - └ SCC_RULE_ID_20140306161125 Get Courses Completed Count
 - └ SCC_RULE_ID_20140306141320 Get Course Count Rating

SCC_RULE_ID_20140303114951 Test Score Rule Example

- └ SCC_RULE_ID_20140226160705 Get Highest Test Component Score
 - └ SCC_RULE_ID_20140226155857 Get Test Component Scores
- └ SCC_RULE_ID_20140304120320 Get ACT Rating Value
- └ SCC_RULE_ID_20140304121526 Get SAT 1 Rating Value

Evaluation Management System/Rules Engine Integration: Rating Component Calculation and Rating Scheme Calculation Rule Groups

In the Rating Scheme setup (**Set Up SACR > Common Definitions > Evaluation Management System > Define Rating Scheme**), when a rating scheme is indicated as used for auto-calculations, you can associate the rating scheme with a rule which can calculate the Overall Rating for the scheme. You can also associate a rule to each rating component in the scheme to calculate a rating result for the component.

See [Defining Rating Schemes](#)

When a user creates an evaluation in the Manage Evaluation component, at the save, the rules designated in the rating scheme setup are invoked. If data needed for each rule exists in the system, a rating value can be returned and populated for each rating component. Additionally, if each required rating component has a rating result populated, the rating scheme rule can be invoked, populating the Overall Rating value. Each time the Manage Evaluation component is saved the rules are invoked, re-evaluating the Calculated Scheme. If, initially, data was not present in the system for a rule to act on, when that data is populated and the Manage Evaluation component is saved, the rule will be invoked, now populating that rating component rating value. If data has changed, the rules will rerun updating the rating results. The SCC_GE_CALC process can also be run to populate and recalculate rating values rather than relying on manually performing saves in the Manage Evaluation component. This process is separate from the Rules Engine batch process and is specific to Evaluation Management. You can find the SCC_GE_CALC process by navigating to **PeopleTools > Process Scheduler > System Process Requests**. You can also schedule this process to run on frequency to meet your needs.

For more information on how to run the process:

See the product documentation for *PeopleTools: Process Scheduler*, "Submitting and Scheduling a Process Request."

Functional Scenario

A Rating Scheme is defined for use with Auto-Calculations. It includes three Rating Components, each of which is associated to a Rule. In this setup configuration, there is no rule identified for the Rating Scheme itself, so for the evaluations using this scheme, the Overall Rating value on the transaction pages will be calculated by the record PeopleCode.

This image shows the Define Rating Scheme page (1 of 2): Rules Engine integration example.

Define Rating Scheme

Evaluation Category: ADMISSIONS Admissions Application
Rating Scheme: CALCEVAL

Rating Scheme Details Find | View All First 1 of 2 Last

*Effective Date: 01/01/1902 *Status: Active

*Description: Calculated scheme

Short Description: Calculated scheme

Comments:

Available for use with

Auto-Calculations
 Committees
 Individual Evaluators

Add/Delete Options

Allow Component Additions
 Allow Component Deletions

Rule ID:

Rating Components Find | View All First 1 of 3 Last

*Rating Component: TESTS General Test Scores

*Calculation Method: Automatic Processing Order: 1 Rating Required

Rule ID: SCC_RULE_ID_20140303114951 Test Score Rule Example

Rating Values			Personalize Find <input type="text"/>	First 1-6 of 6 Last
*Rating Value	Description	Short Description		
10	ACT 14 <, SAT <1000	<15, <1000	<input type="text"/>	<input type="text"/>
15	ACT 19 -15, SAT 1099 - 1000	19 -15,1099 - 1000	<input type="text"/>	<input type="text"/>
20	ACT 25 - 20 , SAT 1199 - 1100	25 - 20 , 1199 -1100	<input type="text"/>	<input type="text"/>
25	ACT 29 - 26,SAT 1299 - 1200	29 - 26 ,1299 - 1200	<input type="text"/>	<input type="text"/>
30	ACT 34 - 30, SAT 1399 - 1300	34 - 30, 1399 - 1300	<input type="text"/>	<input type="text"/>
35	ACT 36 - 35, SAT 1600 - 1400	36 - 35, 1600 - 1400	<input type="text"/>	<input type="text"/>

This image shows the Define Rating Scheme page (2 of 2): Rules Engine integration example.

Rating Components
Find | View All First 2 of 3 Last

*Rating Component: Academic Qualification + -

*Calculation Method: Processing Order: Rating Required

Rule ID: Academic Qualification Example

*Rating Value	Description	Short Description		
10	1.9 or less	1.9 or less	+	-
15	2.49 – 2.0	2.49 – 2.0	+	-
20	2.9 – 2.5	2.9 – 2.5	+	-
25	3.49 – 3.0	3.49 – 3.0	+	-
30	3.79 – 3.5	3.79 – 3.5	+	-
35	4.0 – 3.8 gpa	4.0 – 3.8 gpa	+	-

Rating Components
Find | View All First 3 of 3 Last

*Rating Component: Secondary Course Requirements + -

*Calculation Method: Processing Order: Rating Required

Rule ID: Courses Completed Requirement Example

*Rating Value	Description	Short Description		
10	Less than 14	Less than 14	+	-
15	14-15 courses	14-15 courses	+	-
20	16 courses	16 courses	+	-
25	17 – 18 courses	17 – 18 courses	+	-
30	19 - 20 courses	19 - 20 courses	+	-
35	21 or more course	21 or more course	+	-

Note: The rating values specified are used for validation purposes and to derive the description values. Rating values must also be present in the rule itself for calculation purpose.

That Rating Scheme is associated with an Evaluation Code. This code is set up to only use a Calculated Scheme; there are no other schemes included in this setup.

This image shows the Evaluation Info page: Rules Engine integration example.

The screenshot shows the 'Evaluation Info' page with the following details:

- Evaluation Category:** ADMISSIONS (Admissions Application)
- Evaluation Code:** CALCEVAL
- Evaluation Code Setup:**
 - *Effective Date: 01/01/1902
 - *Effective Status: Active
 - Use Workflow Processing:
 - *Description: Calculated Evaluation
 - Short Description: Calculated Evaluation
 - Administrator: [Searchable Field]
 - Calculated Scheme: CALCEVAL (Calculated scheme)
 - Comments: [Text Area]
- Recommended Prize Prompt:**
 - Record (Table) Name: [Searchable Field]
 - Field Name: [Searchable Field]
 - LOV Context: [Searchable Field]
- Associated Schemes:**

*Scheme Type	*Scheme Name	Description	Rating Scheme	*Calculate Option	Order
[Dropdown]	[Searchable]			On-going	[Dropdown]

An Evaluation is manually created for EMPLID CCEM0019. At the time of the Evaluation creation, only the Test Score data exists in the system for this ID. At the save of the Manage Evaluation component, the rule linked to the TESTS component is invoked and a value is returned to that rating component:

This images shows the Calculated Scheme page: Rules Engine integration example.

The screenshot shows the 'Calculated Scheme' page with the following details:

- ID:** CCEM0019 (Alexandre Smithsonian)
- Academic Institution:** PSUNV (PeopleSoft University)
- Evaluation Category:** ADMISSIONS (Admissions Application)
- Evaluation Code:** CALCEVAL (Calculated Evaluation)
- Calculated Scheme:** CALCEVAL (Calculated scheme)
- Evaluation Instance:** 8
- Process Instance:**
- Eval Code Seq:** 3
- Overall Rating:**

Rating Component Information Table:

*Rating Component	Order	Description	Rating Value	Rating Required	Successfully Evaluated	Order
TESTS	1	General Test Scores	25	<input checked="" type="checkbox"/>	<input checked="" type="checkbox"/>	[+/-]
ACADEMIC	2	Academic Qualification		<input checked="" type="checkbox"/>	<input type="checkbox"/>	[+/-]
SCNDRYREQ	3	Secondary Course Requirements		<input checked="" type="checkbox"/>	<input type="checkbox"/>	[+/-]

In this example, ID CCEM0019 has the following Test Score data: ACT COMP score of 15, SAT 1 VERB of 600, MATH of 600. The Test Score example rule evaluates the scores, derives a rating of value of 15 for the ACT COMP score and a rating value of 25 for the total of the SAT 1 VERB and MATH scores. Since the SAT 1 total results in a higher rating value, that value is returned to the rating component.

Note: This same action/activity occurs when using the Create/Maintain Evaluations batch process to create evaluations.

Sometime later the data needed to calculate the other rating components is entered in the system. In this example that is Education data which includes GPA, Percentile Rank and External Subject details.

The SCC_GE_CALC process runs (you can schedule this to run as frequently as needed according to your business needs). The rules for the ACADEMIC and SCNDRYREQ components are invoked and rating values are returned by the batch process for those components. Because all required rating component values are present, the Overall Rating is also calculated:

This image shows the Calculated Scheme page: Rules Engine integration example 2.

Evaluation Overview		Calculated Scheme	Individual Evaluator Scheme	Committee Scheme
ID:	CCEM0019	Alexandre Smithsonian		
Academic Institution:	PSUNV	PeopleSoft University		Evaluation Instance: 8
Evaluation Category:	ADMISSIONS	Admissions Application		Process Instance:
Evaluation Code:	CALCEVAL	Calculated Evaluation		Eval Code Seq: 3
Calculated Scheme:	CALCEVAL	Calculated scheme		Overall Rating: 18.333

Rating Component Information						Personalize	Find	First	1-3 of 3	Last
*Rating Component	Order	Description	Rating Value	Rating Required	Successfully Evaluated					
TESTS	1	General Test Scores	25	<input checked="" type="checkbox"/>	<input checked="" type="checkbox"/>					+ -
ACADEMIC	2	Academic Qualification	15	<input checked="" type="checkbox"/>	<input checked="" type="checkbox"/>					+ -
SCNDRYREQ	3	Secondary Course Requirements	15	<input checked="" type="checkbox"/>	<input checked="" type="checkbox"/>					+ -

The Academic rating value results from a calculation of the Education Data converted GPA and/or Percentile Rank. In our scenario, ID CCEM0019 has the following data:

- Converted GPA = 2.0
- Percentile Rank = 30%

The Academic Qualification rule determines that the Percentile Rank has a higher rating value and returns that value to the rating component.

The SCNDRYREQ rating value results from a count of External Subject completed courses. In our scenario, ID CCEM0019 has a total of 18 external subject completed courses. The SCNDRYREQ rule counts the number of courses completed and applies the rating scale to that number and returns a rating value to the rating component.

In this example above, because no rule was associated for the rating scheme, the Overall Rating is derived by PeopleCode and produces an average of the rating values.

Because this evaluation has not been determined to be final, if there are changes to the underlying data, the rules can be executed again to pick up those changes and do a recalculation. Let us say in this scenario higher ACT scores are received. The COMP score value is 36. The SCC_GE_CALC process is run and the newer score picked up and the TESTS rating component value is recalculated based on that score. The Overall Rating value is also recalculated:

This image shows the Calculated Scheme page: Rules Engine integration example 3

Evaluation Overview		Calculated Scheme		Individual Evaluator Scheme		Committee Scheme	
ID:	CCEM0019	Alexandre Smithsonian					
Academic Institution:	PSUNV	PeopleSoft University				Evaluation Instance: 8	
Evaluation Category:	ADMISSIONS	Admissions Application				Process Instance:	
Evaluation Code:	CALCEVAL	Calculated Evaluation				Eval Code Seq: 3	
Calculated Scheme:	CALCEVAL	Calculated scheme				Overall Rating: 21.667	
Rating Component Information							
*Rating Component	Order	Description	Rating Value	Rating Required	Successfully Evaluated		
TESTS	1	General Test Scores	35	<input checked="" type="checkbox"/>	<input checked="" type="checkbox"/>	<input type="button" value="+"/>	<input type="button" value="-"/>
ACADEMIC	2	Academic Qualification	15	<input checked="" type="checkbox"/>	<input checked="" type="checkbox"/>	<input type="button" value="+"/>	<input type="button" value="-"/>
SCNDRYREQ	3	Secondary Course Requirements	15	<input checked="" type="checkbox"/>	<input checked="" type="checkbox"/>	<input type="button" value="+"/>	<input type="button" value="-"/>

After the Evaluation Status is set to *Final*, no additional re-calculations will occur.

Functional Scenario Variation

The Rating Scheme setup is modified to use a rule to calculate the Overall rating. Additionally, we have included a Math rating component that is not associated with a rule and is determined then to be populated manually.

This images shows the Define Rating Scheme page: Rules Engine integration example (scenario variation).

Define Rating Scheme

Evaluation Category: ADMISSIONS Admissions Application

Rating Scheme: CALCEVAL

Rating Scheme Details Find | View All First 1 of 2 Last

*Effective Date: 01/01/1902 *Status: Active

*Description: Calculated scheme

Short Description: Calculated scheme

Comments:

Available for use with

Auto-Calculations

Committees

Individual Evaluators

Add/Delete Options

Allow Component Additions

Allow Component Deletions

Rule ID: SCC_RULE_ID_20140306170755 Rating Scheme Calculation Example

Rating Components Find | View All First 1 of 4 Last

*Rating Component: MATH Math courses

*Calculation Method: Manual Processing Order: Rating Required

Rule ID:

Rating Values			Personalize Find First 1-3 of 3 Last	
*Rating Value	Description	Short Description		
10	3 years of Math	3 years of Math	+	-
20	4 years of Math, including Precalculus	4 years of Math, includin	+	-
30	5 years of Math including Calculus	5 years of Math including	+	-

When an evaluation is assigned to an ID, there is now a component which needs to be manually entered.

Note: The Overall Rating is now calculated by the associated rule – in this example the rule does a simple sum of the rating component values:

This image shows the Calculated Scheme page: Rules Engine integration example (scenario variation).

Evaluation Overview		Calculated Scheme		Individual Evaluator Scheme		Committee Scheme	
ID:	CCEM0019	Alexandre Smithsonian					
Academic Institution:	PSUNV	PeopleSoft University				Evaluation Instance: 9	
Evaluation Category:	ADMISSIONS	Admissions Application				Process Instance:	
Evaluation Code:	CALCEVAL	Calculated Evaluation				Eval Code Seq: 4	
Calculated Scheme:	CALCEVAL	Calculated scheme				Overall Rating: 85.000	

Rating Component Information						Personalize	Find	First	1-4 of 4	Last
*Rating Component	Order	Description	Rating Value	Rating Required	Successfully Evaluated					
MATH		Math courses	20	<input type="checkbox"/>	<input type="checkbox"/>					+ -
TESTS	1	General Test Scores	35	<input checked="" type="checkbox"/>	<input checked="" type="checkbox"/>					+ -
ACADEMIC	2	Academic Qualification	15	<input checked="" type="checkbox"/>	<input checked="" type="checkbox"/>					+ -
SCNDRYREQ	3	Secondary Course Requirements	15	<input checked="" type="checkbox"/>	<input checked="" type="checkbox"/>					+ -

Evaluation Management System/Rules Engine Integration: Early Result Rule Group

If workflow is used in a particular evaluation, a rule can be associated in the Evaluation Code setup that determines whether the evaluation result or final outcome can be made at various points in a multischeme evaluation. The rules defined under the Early Result Rule Group are invoked when an evaluator submits their evaluation. A submit is defined as all required rating components are populated, an overall rating or recommendation (or both) are present and the Evaluation Status = *Final*. This can occur from the Self Service pages in the WorkCenter or in the Manage Evaluation component. Each time an evaluation is submitted the Early Result rule fires and evaluates the data returned in the Evaluator List data set. If the rule directs that Early Result = *True*, then at that point in the evaluation flow, the evaluation concludes and the evaluation can be finalized.

Functional Scenario

An evaluation is setup with an Early Result Rule defined in the Define Evaluation Code component:

This image shows the Evaluation Info page, Early Result Rule Group example.

The screenshot displays the 'Evaluation Info' page for the 'ADMISSIONS' category and 'Admissions Application' evaluation code 'UGRDLIBART'. The 'Evaluation Code Setup' section includes fields for Effective Date (01/01/1901), Effective Status (Active), and checkboxes for 'Use Workflow Processing' and 'Start Workflow Processing'. The description is 'Undergraduate Liberal Arts Evaluation' and the administrator is 'Rosaria Dunphy'. An 'Early Result Rule' is associated with the code, identified as 'Early Result Evaluation Workflow Rule Example'. Below this, the 'Associated Schemes' table lists three evaluation schemes:

*Scheme Type	*Scheme Name	Description	Rating Scheme	*Calculate Option	Order
Individual Evaluator	LAFIRSTREV	Undergraduate Lib Arts First Review	UGLAREVIEW	On-going	1
Committee	UGLAFACREV	Undergraduate Faculty Review	UGLAREVIEW	On-going	2
Individual Evaluator	LADEANREV	Undergraduate Dean's review	UGLAREVIEW	On-going	3

Workflow is used in this evaluation, no calculated scheme is associated with the evaluation code. There are 3 schemes defined as part of the evaluation, as shown above.

Based on the Evaluator results at Order 1, an Early Result rule can determine whether those results require whether the evaluation needs to progress or whether the evaluation can be completed based on the results at Order 1. If those results indicate the workflow should be stopped and the evaluation completed, then the rule's logic is used to grey down all other levels in the evaluation and populate the Evaluation Status and Recommendation fields on the Evaluation Overview tab for the evaluation. Workflow ceases and no worklist items or notifications (if enabled) will be created for any of the next levels. If the evaluation is to proceed, workflow continues and worklist items and notifications are created for the next level evaluator(s) at Order 2. Again, logic in the rule determines what should happen at this level of the evaluation just as it did for Order 1.

Here are the Evaluations and Calculations in the Rule:

This image shows the Evaluations and Calculations in the Early Result Rule.

Evaluations and Calculations		Personalize Find  	First 1-19 of 19 Last
Active	Statement Description	Details	
<input checked="" type="checkbox"/>	1 LENGTH OF LIST Using List Evaluator List Returning Length in evaluatorCount		
<input checked="" type="checkbox"/>	2 IF evaluatorCount > 0		
<input checked="" type="checkbox"/>	3 - FOR EACH Evaluator List		
<input checked="" type="checkbox"/>	4 - ASSIGN Evaluator = Evaluator List		
<input checked="" type="checkbox"/>	5 - IF Evaluator.Evaluator Type = 5 And Evaluator.Scheme = LAFIRSTREV And Evaluator.Overall Rating >= 30		
<input checked="" type="checkbox"/>	6 - ASSIGN Early Result = True, Route To Administrator = False, Recommendation = ADMIT, Recommended Prize = MCL		
<input checked="" type="checkbox"/>	7 - IF Evaluator.Evaluator Type = 5 And Evaluator.Scheme = LAFIRSTREV And Evaluator.Overall Rating <= 10		
<input checked="" type="checkbox"/>	8 - ASSIGN Early Result = True, Route To Administrator = False, Recommendation = DENY		
<input checked="" type="checkbox"/>	9 - EXIT FOR EACH		
<input checked="" type="checkbox"/>	10 - IF Evaluator.Evaluator Type = 4 And Evaluator.Scheme = UGLAFACREV And Evaluator.Recommendation = ADMIT		
<input checked="" type="checkbox"/>	11 - ASSIGN Early Result = True, Route To Administrator = False, Recommendation = ADMIT		
<input checked="" type="checkbox"/>	12 - IF Evaluator.Evaluator Type = 4 And Evaluator.Scheme = UGLAFACREV And Evaluator.Recommendation = DENY		
<input checked="" type="checkbox"/>	13 - ASSIGN Early Result = True, Route To Administrator = True, Recommendation = DENY		
<input checked="" type="checkbox"/>	14 - EXIT FOR EACH		
<input checked="" type="checkbox"/>	15 - IF Evaluator.Evaluator Type = 3 And Evaluator.Scheme = LADEANREV And Evaluator.Overall Rating >= 35 And Evaluator.Recommendation = ADMIT		
<input checked="" type="checkbox"/>	16 - ASSIGN Early Result = True, Route To Administrator = True, Recommendation = ADMIT, Recommended Prize = DEANLS		
<input checked="" type="checkbox"/>	17 - IF Evaluator.Evaluator Type = 3 And Evaluator.Scheme = LADEANREV And Evaluator.Overall Rating <= 15 And (Evaluator.Recommendation = DENY Or Evaluator.Recommendation = WAITLIST)		
<input checked="" type="checkbox"/>	18 - ASSIGN Early Result = True, Route To Administrator = True, Recommendation = DENY		
<input checked="" type="checkbox"/>	19 - EXIT FOR EACH		

Here is how the rule works with this scenario:

Our evaluator in the Individual Evaluator Scheme LAFIRSTREV is the first to go in the workflow processing order. In our sample rule, we've set the logic so we only want the evaluation to progress if that evaluator's results are within certain parameters:

```
| - IF Evaluator.Evaluator Type = 5 And Evaluator.Scheme = LAFIRSTREV And Evaluator.Overall Rating >= 30
| | | - ASSIGN Early Result = True, Route To Administrator = False, Recommendation = ADMIT, Recommended Prize = MCL
| | - IF Evaluator.Evaluator Type = 5 And Evaluator.Scheme = LAFIRSTREV And Evaluator.Overall Rating <= 10
| | | - ASSIGN Early Result = True, Route To Administrator = False, Recommendation = DENY
| | | - EXIT FOR EACH
```

In this example the evaluator type of 5 equates to an individual evaluator ; see more at the end of this section about evaluator types. If the evaluator's overall rating value is equal to or greater than 30 or equal to or less than 10, the evaluation flow will stop and the evaluation completed using the values specified in the rule for Recommendation to populate the Recommendation value on the Evaluation Overview page.

For both conditions, Route to Administrator is *false* so no intervention by the Evaluation Administrator is expected. The Evaluation Status for the evaluation is set to *final*, all levels of the evaluation are grayed, no further workflow processing takes place. To continue with our scenario, let's say the evaluator's overall rating results were 25, so the workflow processing has continued and the evaluation advances to the Order 2 which is a committee scheme.

Let's look at the next part of the rule:

```
| - IF Evaluator.Evaluator Type = 4 And Evaluator.Scheme = UGLAFACREV And Evaluator⇒
.Recommendation = ADMIT
| | - ASSIGN Early Result = True, Route To Administrator = False, Recommendation ⇒
= ADMIT
| | - IF Evaluator.Evaluator Type = 4 And Evaluator.Scheme = UGLAFACREV And Evaluat⇒
or.Recommendation = DENY
| | - ASSIGN Early Result = True, Route To Administrator = True, Recommendation ⇒
DENY
| | - EXIT FOR EACH
```

In this section of the rule we are referencing the scheme at Order 2. Evaluator type equates to the Committee Administrator. The committee members have all submitted results and the committee administrator will finalize the results for the committee. As with the first example, we have set conditions that are going to direct the workflow, but this time using the Recommendation value that is given for the committee rather than the Overall Rating as in the first example. The logic is much the same, but note that if the Evaluator Recommendation = Deny and we return the Early Result of *True*, here we are setting the Route to Administrator to True. In that event that all levels of the evaluation are grayed, no further workflow processing takes place except for the Evaluation Administrator: a worklist item would be created and notifications sent. On the Evaluation Overview page, the Recommendation field would be populated with *Deny* but the field would not be grayed. The Evaluation Status field would not be updated with a final value. Again for purposes of our scenario, let's say that the committee recommendation is HOLDNXREV (Hold for next review) so the workflow processing has continued and the evaluation advances to the Order 3 which is an individual evaluator scheme.

Here is the final part of the rule:

```
| | - IF Evaluator.Evaluator Type = 3 And Evaluator.Scheme = LADEANREV And Evaluato⇒
r.Overall Rating >= 35 And Evaluator.Recommendation = ADMIT
| | - ASSIGN Early Result = True, Route To Administrator = True, Recommendation ⇒
ADMIT, Recommended Prize = DEANLS
| | - IF Evaluator.Evaluator Type = 3 And Evaluator.Scheme = LADEANREV And Evaluato⇒
r.Overall Rating <= 15 And ( Evaluator.Recommendation = DENY Or Evaluator.Recommend⇒
ation = WAITLIST )
| | - ASSIGN Early Result = True, Route To Administrator = True, Recommendation ⇒
DENY
| | - EXIT FOR EACH
```

In this section of the rule we are referencing the scheme at Order 3, LADEANREV. Evaluator type equates to the Individual Evaluator Scheme Administrator. In this scheme there are multiple evaluators and it is the scheme result (think of this as a consensus of the various evaluators) as set by the administrator which will be considered by the rule. As with the previous examples, we have set conditions that are going to direct the workflow, but this time using the both the Overall Rating and

Recommendation values that are given for the scheme. The logic is much the same, but with more complexity. In both conditions, we set the Route to Administrator to *True*.

Functional Scenario Variation

In the previous scenario, the evaluation code was set up for use with only Individual Evaluator and Committee Schemes. You can incorporate a calculated scheme into the evaluation code setup and have an Early Result Rule recognize the results of the calculated scheme to direct the workflow. Here is the evaluation code setup:

This image shows the Evaluation Info page, Early Result Rule Group example that uses Calculated Scheme.

The screenshot displays the 'Evaluation Info' page for the 'ADMISSIONS' category, 'Admissions Application' sub-category, and 'UGRDLIBART' evaluation code. The 'Evaluation Code Setup' section includes fields for Effective Date (01/01/1901), Effective Status (Active), Description (Undergraduate Liberal Arts Evaluation), Short Description (UGRD Liberal Arts), Administrator (CCEM0002, Rosaria Dunphy), Calculated Scheme (CALCEVAL, Calculated scheme), Calculated Scheme Option (Hold Workflow), and Early Result Rule (SCC_RULE_ID_20140604075859, Early Result Calc Evaluation Workflow Rule Example). There are also checkboxes for 'Use Workflow Processing' and 'Start Workflow Processing', both of which are checked. A 'Comments' field is present but empty.

The 'Associated Schemes' table below shows three schemes:

*Scheme Type	*Scheme Name	Description	Rating Scheme	*Calculate Option	Order
Individual Evaluator	LAFIRSTREV	Undergraduate Lib Arts First Review	UGLAREVIEW	On-going	1
Committee	UGLAFACREV	Undergraduate Faculty Review	UGLAREVIEW	On-going	2
Individual Evaluator	LADEANREV	Undergraduate Dean's review	UGLAREVIEW	On-going	3

Workflow is used in the evaluation. Note that the Calculated Scheme Option is set to 'Hold Workflow'. There are also Individual Evaluator and Committee Schemes in the evaluation code setup, as shown above.

Here are the Evaluations and Calculations in the Rule:

This image shows the Evaluations and Calculations in the Early Result Rule, using Calculated Scheme.

Evaluations and Calculations		Personalize Find  	First 1-23 of 23 Last
Active	Statement Description	Details	
<input checked="" type="checkbox"/>	1 LENGTH OF LIST Using List Evaluator List Returning Length in evaluatorCount		
<input checked="" type="checkbox"/>	2 IF evaluatorCount = 0 And Overall Rating >= 25		
<input checked="" type="checkbox"/>	3 - ASSIGN Early Result = True, Recommendation = ADMIT		
<input checked="" type="checkbox"/>	4 IF evaluatorCount = 0 And Overall Rating <= 15		
<input checked="" type="checkbox"/>	5 - ASSIGN Early Result = True, Recommendation = DENY		
<input checked="" type="checkbox"/>	6 IF evaluatorCount > 0		
<input checked="" type="checkbox"/>	7 - FOR EACH Evaluator List		
<input checked="" type="checkbox"/>	8 - ASSIGN Evaluator = Evaluator List		
<input checked="" type="checkbox"/>	9 - IF Evaluator.Evaluator Type = 5 And Evaluator.Scheme = LAFIRSTREV And Evaluator.Overall Rating >= 30		
<input checked="" type="checkbox"/>	10 - ASSIGN Early Result = True, Route To Administrator = False, Recommendation = ADMIT, Recommended Prize = MCL		
<input checked="" type="checkbox"/>	11 - IF Evaluator.Evaluator Type = 5 And Evaluator.Scheme = LAFIRSTREV And Evaluator.Overall Rating <= 10		
<input checked="" type="checkbox"/>	12 - ASSIGN Early Result = True, Route To Administrator = False, Recommendation = DENY		
<input checked="" type="checkbox"/>	13 - EXIT FOR EACH		
<input checked="" type="checkbox"/>	14 - IF Evaluator.Evaluator Type = 4 And Evaluator.Scheme = UGLAFACREV And Evaluator.Recommendation = ADMIT		
<input checked="" type="checkbox"/>	15 - ASSIGN Early Result = True, Route To Administrator = False, Recommendation = ADMIT		
<input checked="" type="checkbox"/>	16 - IF Evaluator.Evaluator Type = 4 And Evaluator.Scheme = UGLAFACREV And Evaluator.Recommendation = DENY		
<input checked="" type="checkbox"/>	17 - ASSIGN Early Result = True, Route To Administrator = True, Recommendation = DENY		
<input checked="" type="checkbox"/>	18 - EXIT FOR EACH		
<input checked="" type="checkbox"/>	19 - IF Evaluator.Evaluator Type = 3 And Evaluator.Scheme = LADEANREV And Evaluator.Overall Rating >= 35 And Evaluator.Recommendation = ADMIT		
<input checked="" type="checkbox"/>	20 - ASSIGN Early Result = True, Route To Administrator = True, Recommendation = ADMIT, Recommended Prize = DEANLS		
<input checked="" type="checkbox"/>	21 - IF Evaluator.Evaluator Type = 3 And Evaluator.Scheme = LADEANREV And Evaluator.Overall Rating <= 15 And (Evaluator.Recommendation = DENY Or Evaluator.Recommendation = WAITLIST)		
<input checked="" type="checkbox"/>	22 - ASSIGN Early Result = True, Route To Administrator = True, Recommendation = DENY		
<input checked="" type="checkbox"/>	23 - EXIT FOR EACH		

This is the same rule seen previously but cloned to account for the use of the calculated scheme in the scenario. The calculated scheme evaluates data in the system and returns an overall rating value. For more information, see [Evaluation Management System/Rules Engine Integration: Rating Component Calculation and Rating Scheme Calculation Rule Groups](#).

In this scenario, we want the calculated scheme overall rating to determine what happens next in the evaluation flow, so we have set the Calculated Scheme Option to *Hold Workflow*. This means that the workflow will not trigger until all required rating components have rating values and an Overall Rating is calculated. When used with this Early Result Rule, the logic in the rule will direct whether the workflow should start or not. Here is the relevant part of the rule that evaluates for the calculated scheme:

```
IF evaluatorCount = 0 And Overall Rating >= 25
| - ASSIGN Early Result = True, Recommendation = ADMIT
IF evaluatorCount = 0 And Overall Rating <= 15
| - ASSIGN Early Result = True, Recommendation = DENY
```

In terms of activity in the evaluation, since we are holding workflow, the calculated scheme essentially is the first portion of the evaluation to take action. Once the Overall Rating is calculated this signifies a *submit* action. The early result rule is invoked. Since no evaluators are returned in the count, we know this is a calculated scheme and the logic as shown above is applied. In this scenario, the evaluation could be completed based on the calculated scheme results (if Overall Rating is ≥ 25 or ≤ 15). If the Overall Rating falls between those values, the evaluation will proceed and workflow will then start and advance the evaluation to the scheme at Order 1. From there the same scenario ensues as discussed in the previous section.

Note: Regarding the Calculated Scheme Option — if you were to use Do Not Hold Workflow and the Start Workflow flag is set to *Y* then the workflow would start immediately without consideration of the calculated scheme. In our scenario here, the difference would be that, even though not all required rating components have ratings and no Overall Rating has been calculated, the workflow would process and worklist items and notifications would be sent to evaluators in the first processing order.

A Note on Evaluator Types

Evaluator Types is a construct used behind the scenes in Evaluation Management in the management of Self Service pages display to the user and in workflow processing . We have leveraged the EMS Evaluator Decision Info Data set as well. When building rules there is a prompt available to aid in selecting the correct value. For reference here is the list of Evaluator Types:

1. Evaluation Administrator.
2. Committee Scheme Administrator.
3. Individual Scheme Administrator.
4. Committee Administrator.
5. Individual Evaluator.
6. Committee Evaluator.

Modifying and Using System Data Rules

If you want to use the delivered sample rules with your test data, you must perform the following steps:

- Clone the rule using the Rules Engine Manager. The rule (s) can be accessed in this component and copied using the ‘Create New Rule from Rule’ feature.
- Modify Rule Name and Descriptions.
- You can change the Rule Category designation.
- Modify the Rule Statements where Campus Solutions sample data is used (see the Rule Evaluation/ Calculation table entries for each rule, above) using your data, your criteria and logic on so on.
- Test the rule using the Rules Engine Manager Test feature.
- Activate the rule.

See [Understanding the Rules Engine](#)

See [Setting Up the Rules Engine](#)

Setting Up Campus Event Planning

Understanding Campus Events

You must define the items that you want to make available for events.

Note: Do not confuse the events described in this section with 3C engine events. One attends the events described here. 3C engine events are occurrences associated with data in your system.

To define events, you:

- Define event types.
- Define event resource codes.
- Define event staff codes.

An event consists of one or more meetings, each of which has its own resources and staff. You can create templates for recurring or similar events by defining the meetings typically required for that type of event. You can then use or modify the template for recurring or similar events that require similar meetings, resources, and staff. Event templates are optional; however, they can be useful guidelines that save time.

Note: You can create only one template per event type.

To create an event template, do the following:

1. Define the meetings for the event type.
2. Assign the resources for each meeting.
3. Assign the type of staff for each meeting.

Related Links

“Setting Up Catalog and Schedule Options” (Student Records)

Defining Campus Events

To define campus events, use the following components: Event Type Table component (EVENT_TYPE_TABLE), Resource Code Table component (RESOURCE_CD_TABLE), and Staff Code Table component (STAFF_CODE_TABLE).

This section discusses how to:

- Define event types.

- Define event resource codes.
- Define event staff codes.

Pages Used to Define Campus Events

<i>Page Name</i>	<i>Definition Name</i>	<i>Navigation</i>	<i>Usage</i>
Event Types	EVENT_TYPE_TABLE	Campus Community > Campus Event Planning > Set Up Events > Event Type Table	Define the general types of events.
Resource Codes	RESOURCE_CD_TABLE	Campus Community > Campus Event Planning > Set Up Events > Resource Code Table	Review or create codes for the resources to make available for events, such as tables, chairs, brochures, and banners.
Staff Codes	STAFF_CODE_TABLE	Campus Community > Campus Event Planning > Set Up Events > Staff Code Table	Identify and set up the types of staff for events, such as speakers, admissions counselors, tour guides, cooks, and servers.

Defining Event Types

Access the Event Types page (**Campus Community > Campus Event Planning > Set Up Events > Event Type Table**).

<i>Field or Control</i>	<i>Description</i>
Comment	Enter comments to further identify or describe this event type.

Defining Event Resource Codes

Access the Resource Codes page (**Campus Community > Campus Event Planning > Set Up Events > Resource Code Table**).

Enter information to describe the resource code to create.

Defining Event Staff Codes

Access the Staff Codes page (**Campus Community > Campus Event Planning > Set Up Events > Staff Code Table**).

Enter information to describe the staff code.

Creating an Event Template

To create an event template, use the Event Template component (CAMPUS_EVENT_TMPL).

This section discusses how to:

- Create an event meeting template.
- Assign the meeting resources.
- Assign the type of meeting staff.

Pages Used to Create an Event Template

<i>Page Name</i>	<i>Definition Name</i>	<i>Navigation</i>	<i>Usage</i>
Meeting Template	MTG_TMPL	Campus Community > Campus Event Planning > Set Up Events > Event Template > Meeting Template	Identify meetings that comprise that event type.
Meeting Resource Template	MTG_RSRCE_TMPL	Campus Community > Campus Event Planning > Set Up Events > Event Template > Meeting Resource Template	Assign resources that are required for each meeting in the event.
Meeting Staff Template	MTG_STAFF_TMPL	Campus Community > Campus Event Planning > Set Up Events > Event Template > Meeting Staff Template	Designate the type of staff for each meeting in the event.

Creating an Event Meeting Template

Access the Meeting Template page (**Campus Community > Campus Event Planning > Set Up Events > Event Template > Meeting Template**).

This example illustrates the fields and controls on the Meeting Template page. You can find definitions for the fields and controls later on this page.

Event Meetings

<i>Field or Control</i>	<i>Description</i>
Event Meeting	The system enters the next sequential number for each meeting that you add. You can override the number to reorder the list of meetings. When you return to the page, the meetings will be in the specified order.
Campus Meeting Type	Select the meeting type that best describes this meeting. Values for this field are delivered with your system as translate values. You can modify these translate values.

Assigning the Meeting Resources

Access the Meeting Resource Template page (**Campus Community > Campus Event Planning > Set Up Events > Event Template > Meeting Resource Template**).

Meeting Resource Template

<i>Field or Control</i>	<i>Description</i>
Resource Code	Enter the type of resource that is required for this meeting. Available resource codes are from the Resource Codes page.

<i>Field or Control</i>	<i>Description</i>
Number of Resources	Enter the number or quantity of the resource required for this meeting.
Comments	Enter comments to further identify or describe this resource.

Assigning the Type of Meeting Staff

Access the Meeting Staff Template page (**Campus Community > Campus Event Planning > Set Up Events > Event Template > Meeting Staff Template**).

Meeting Staff Template

<i>Field or Control</i>	<i>Description</i>
Staff Code	Enter the type of staff required for the meeting. Available staff codes are from the Staff Codes page.
Number of Staff Required	Enter the total number of this type of staff required for the meeting
Comment	Enter comments to further describe or identify the staff required for the meeting.

Managing System IDs

Understanding ID Management

Unique IDs are vital to PeopleSoft Campus Solutions. When you add an individual or organization, the system creates a record and assigns the next available unique ID. The unique ID remains associated with that individual or organization unless or until you change or delete it.

When you want to add, update, or delete data about that individual or organization, use the unique ID to narrow your search and save time accessing the record.

See [Using Search/Match](#).

To prevent arbitrary or accidental deletion of IDs, assign priority control data. Priority control data prevents users from deleting any ID that contains that data without first evaluating the data. Priority control data also prevents users from having to ask the system administrator or other individuals with the appropriate level of system security to delete the data.

Use the PeopleSoft Process Scheduler to delete or change individual IDs. You can select one ID or several IDs at the same time. When you run the process, the system creates an ID Change/Delete Process Log for each ID, showing how many rows were deleted for that individual and listing the records and fields that it updated. The log also indicates the administrative User ID that either deleted or changed an individual ID.

Warning! When you delete an ID, the system deletes not only the ID number, but all key data that is associated with that ID throughout the system. This loss of data could affect other departments. If the ID contains priority data, coordinate the need to delete it with other departments before deleting the priority data and the ID.

See [Controlling the Deletion of Individual IDs](#).

You can change system-generated IDs, but you must change and manage them manually. For example, you might want to change the system-generated IDs of 0000012, 0000035, and 0000062 to the IDs of PRES01, PRES02, and PRES03 to group those specific individuals within a list that only the president of the institution should manage. When you change them, the original system-generated IDs drop from the list of numbered IDs and appear instead as in a group of initial alpha character IDs. That is, the numbered ID list shows 0000033, 0000034, 0000036, 0000037, but the ID of 0000035 that you changed is not listed. That individual is now PRES02 in the list of IDs that are PRES01, PRES02, and PRES03.

Warning! Changes that you make to an ID affect the ID throughout the system, including other departments. Coordinate the need to change the ID with other departments before making the change.

You can also determine the last ID assigned, and determine or adjust the maximum length of system-generated IDs using the installation pages.

Creating System IDs

When you add an individual or organization to your database, the system creates a record and assigns the next available unique ID.

See:

- [Adding an Individual to Your Database](#)
- [Creating Organization Records](#)

Deleting Individual IDs

This section discusses how to delete individual IDs.

Prerequisites

Identify priority control data to prevent the unwanted deletion of individual and organization IDs.

Related Links

[Controlling the Deletion of Individual IDs](#)

Pages Used to Delete Individual IDs

<i>Page Name</i>	<i>Definition Name</i>	<i>Navigation</i>	<i>Usage</i>
ID Delete	RUNCTL_ID_CHANGE	<ul style="list-style-type: none"> • Set Up SACR > System Administration > Database Processing ID Delete • Campus Community > Personal Information > ID Management > ID Delete 	Select individual IDs to delete.
Display Address	ADDRSS_DISPLAY_SEC	Click the Display Address link on the ID Delete page.	Review an individual's address to confirm that the ID is the correct one to delete.
Display National ID	NID_DISPLAY_SEC	Click the Display National ID link on the ID Delete page.	Review an individual's national ID to confirm that the ID is the correct one to delete.

Selecting Individual IDs to Delete

Access the ID Delete page (**Set Up SACR > System Administration > Database Processing ID Delete**).

Enter information and then run the Change/Delete Person ID process.

Note: This page is also used in PeopleSoft HCM.

If you implement Campus Solutions *and* a separate instance of PeopleSoft Human Capital Management, read the relevant documentation about CS-HCM Integration to understand the setup, functional, and technical implementation considerations. See:

“Integrating Person Data” (Campus Solutions Application Fundamentals)

“Integrating Setup Data” (Campus Solutions Application Fundamentals)

“Monitoring Integrations Using the Integrity Utility” (Campus Solutions Application Fundamentals)

See *Information Center: CS-HCM Integration for PeopleSoft Enterprise Campus Solutions* in My Oracle Support (ID 2091799.2).

Person ID(s) to be processed

Field or Control	Description
Person ID and Name	Enter the ID that you want to delete. The system displays the name of the person with that ID.
Display Address	Click this link to access the page on which you can review address data to further determine if this is the correct ID to delete.
Display National ID	Click this link to access the Display National ID page, on which you can review the individual's national ID numbers to further determine if this is the correct ID to delete.

Note: A maximum of 999 records can be deleted in a single run of the ID Delete process.

After running the Change/Delete Person ID process, you can review the updated records for the specific individual on the ID Change/Delete Process Log. See [Reviewing Changed or Deleted Individual ID Records](#).

Changing Individual IDs

This section discusses how to:

- Change an individual ID.
- Review changed or deleted individual ID records.

Page Used to Change Individual IDs

<i>Page Name</i>	<i>Definition Name</i>	<i>Navigation</i>	<i>Usage</i>
ID Change	RUNCTL_ID_CHANGE	<ul style="list-style-type: none"> • Set Up SACR > System Administration > Database Processing > ID Change • Campus Community > Personal Information > ID Management > ID Change 	Change an individual ID.
ID Change/Delete Process Log	HR_PER502_LOG	<ul style="list-style-type: none"> • Set Up SACR > System Administration > Database Processing > ID Change/Delete Process Log • Campus Community > Personal Information > ID Management > ID Change/Delete Process Log 	Review an individual's national ID to confirm that the ID is the correct one to delete.

Changing an Individual ID

Access the ID Change page (**Set Up SACR > System Administration > Database Processing > ID Change**).

Enter information to change one or more individual IDs, and then use the PeopleSoft Process Scheduler to run the Change/Delete Person ID process. When you run the process, the system changes the IDs that you list here. You can review the records updated for the individuals on the ID Change/Delete Process Log.

Note: This page is also used in PeopleSoft HCM.

If you implement Campus Solutions *and* a separate instance of PeopleSoft Human Capital Management, read the relevant documentation about CS-HCM Integration to understand the setup, functional, and technical implementation considerations. See:

“Integrating Person Data” (Campus Solutions Application Fundamentals)

“Integrating Setup Data” (Campus Solutions Application Fundamentals)

“Monitoring Integrations Using the Integrity Utility” (Campus Solutions Application Fundamentals)

Information Center: CS-HCM Integration for PeopleSoft Enterprise Campus Solutions in My Oracle Support (ID 2091799.2).

Field or Control	Description
New Person ID	Enter the new ID to assign to this individual; the new ID replaces the individual's existing ID.
Display Address	Click this link to access the Display Address page, on which you can review the individual's address data to further determine if this is the correct ID to change.
Display National ID	Click this link to access the Display National ID page, on which you can review the individual's national ID numbers to further determine if this is the correct ID to change.

Reviewing Changed or Deleted Individual ID Records

Access the ID Change/Delete Process Log page (**Set Up SACR > System Administration > Database Processing > ID Change/Delete Process Log**).

This example illustrates the fields and controls on the ID Change/Delete Process Log page. You can find definitions for the fields and controls later on this page.

ID Change/Delete Process Log

User ID	SAMPLE	Date/Time Stamp	07/23/04 9:33:16AM
Action	Delete ID		
Person ID	IU320006		
		Rows Deleted	26

Updated Records	Customize Find View All	First <input type="button" value="◀"/> 1-10 of 26 <input type="button" value="▶"/> Last
Record Name	Field Name	
ADDRESSES	EMPLID	
BEN_PROG_PARTIC	EMPLID	
COMPENSATION	EMPLID	
DIVERSITY	EMPLID	
ENCUMB_TRIGGER	EMPLID	
FED_TAX_DATA	EMPLID	
JOB	EMPLID	
JOB_JR	EMPLID	
LOCAL_TAX_DATA	EMPLID	
NAMES	EMPLID	

Information on this page is display-only. You cannot enter or edit data here. The information displayed lists changes made as the result of the Change/Delete Person ID process, which is run from the ID Delete or ID Change pages.

Deleting Organization IDs

This section provides an overview of organization ID deletion and discusses how to select the organization ID to delete.

Understanding Organization ID Deletion

Within PeopleSoft Campus Solutions, when you try to delete an organization ID that contains data in any of the priority records that are specified on the ID Delete Control page, the system does not allow the deletion. Instead, it displays a message that lists the specific records and key fields that contain priority data for the ID. To delete the ID, you or your system administrator must first remove the associated priority data.

Page Used to Delete Organization IDs

<i>Page Name</i>	<i>Definition Name</i>	<i>Navigation</i>	<i>Usage</i>
Delete Organization ID	ORG_ID_DELETE	Campus Community > Organization > Delete Organization ID	Select an organization ID to delete.

Selecting the Organization ID to Delete

Access the Delete Organization ID page (**Campus Community > Organization > Delete Organization ID**).

<i>Field or Control</i>	<i>Description</i>
Description, Org Type (organization type), Ownership , and Location	Review information here to verify that this is the correct ID to delete. When you save the page, the organization ID will be deleted. Note: Only one organization ID can be deleted at a time.

Changing an External Organization ID

This section discusses changing an organization ID.

Page Used to Change Organization IDs

<i>Page Name</i>	<i>Definition Name</i>	<i>Navigation</i>	<i>Usage</i>
Change Organization ID	ORG_ID_CHANGE	Campus Community > Organization > Change Organization ID	Select an organization ID to change.

Selecting the Organization ID to Change

Access the Change Organization ID page (**Campus Community > Organization > Change Organization ID**).

This example illustrates the fields and controls on the Change Organization ID page. You can find definitions for the fields and controls later on this page.

Change Organization ID

External Org ID: 0042046 **New External Org ID:**

Change Organization ID Find | View All First ◀ 1 of 1 ▶ Last

Effective Date:	09/29/2004	Status:	Active
Description:	Smithsburg High		
Long Description:	Smithsburg High		
Short Description:	Smithsburg	<input checked="" type="checkbox"/> Offers Courses	
Org Type:	School		
Ownership:	Public		
Location:			

<i>Field or Control</i>	<i>Description</i>
New External Org ID (new external organization ID)	Enter the external organization ID to assign. You can enter a nonexisting ID or choose from the list of existing IDs.

Updating ID Types

This section provides an overview of ID type updates and discusses how to run the Update ID Type process.

Understanding ID Type Updates

By storing each ID type, whether it be for a person or an organization, in a single table (ID_TYPE_TBL record) and associating an indicator flag value to each, you can use individual or organization IDs as a single ID field in applications that are common to both individuals and organizations.

For example, when using the 3C features, you can add a communication to a person by adding a communication to a person ID or you can add a communication to an organization by adding a communication to an organization ID. The Communication feature is the same for both types of IDs because they can be combined inside a common ID (COMMON_ID). Running the Update ID Type process inserts the person ID and the organization ID into the ID_TYPE_TBL and assigns to each a type (either person or organization) by which to differentiate them.

Page Used to Update ID Types

<i>Page Name</i>	<i>Definition Name</i>	<i>Navigation</i>	<i>Usage</i>
Update ID Type	RUNCTL_CCIDTYPE	<ul style="list-style-type: none"> • Set Up SACR > System Administration > Database Processing > Update ID Type • Campus Community > Personal Information > ID Management > Update ID Type 	Run the Update ID Type process to associate the correct ID type—either person or organization—with each ID in your system.

Running the Update ID Type Process

Access the Update ID Type run control page (**Set Up SACR > System Administration > Database Processing > Update ID Type**) to run the Update ID Type process (CCIDTYPE SQR). Use PeopleSoft Process Scheduler to run the Update ID Type process.

Setting Up List of Values

Understanding Get List of Values Web Service Operation

You can develop an external user interface (UI) outside of your PeopleSoft Campus Solutions system. For example, a PeopleTools-developed UI that is directly connected to the PeopleSoft database for entering personal data is *internal*. A web page used by the student, which is not directly connected to the PeopleSoft database, is *external*.

This external UI may present list or prompt fields to the users. These fields only accept input from a list of values. The list of values could be prompt values that you set up in Campus Solutions or translate values that the system delivers. For example, you define Communication Category field values using the Communication Categories page (**Set Up SACR > Common Definitions > Communications > Communication Category Table**). On the other hand, a Campus Solutions page has a Direction field. This field has delivered translate values, such as *Outgoing Communication* and *Incoming Communication*.

The following is an example of a field with a list of values.

This example illustrates the fields and controls on the A List field. You can find definitions for the fields and controls later on this page.

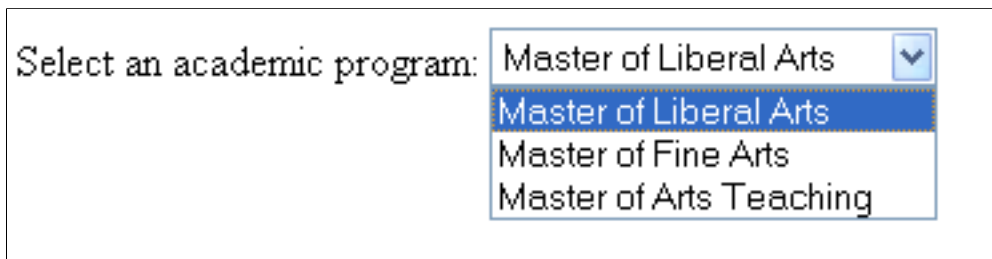

The image shows a web form with a label "Select an academic program:" followed by a dropdown menu. The dropdown menu is open, displaying three options: "Master of Liberal Arts" (which is highlighted in blue), "Master of Fine Arts", and "Master of Arts Teaching". The dropdown menu has a small downward-pointing arrow in the top right corner.

The Get List of Values service operation (SCC_GET_LOV) allows an external UI to request a list of prompt or translate values for a field name configured inside the PeopleSoft Campus Solutions database.

The LOV request message (SCC_LOV_REQ message) accepts the following input parameters:

- Record Name (required).
- Field Name (required).
- LOV Context (optional – defined on the List of Values Setup component).

The list of values retrieved by the service is used to populate drop-down list boxes or prompt fields in an external UI. Also, the external UI logic can use this retrieved list of values to validate a value that a user enters in a field of the external UI.

When the Get List of Values service operation is called, the external UI nominates the field name and its record for which the service should return the list of values. The external UI can request one or more lists of values in a single Get List of Values call. For example, the external UI could request lists of

values for multiple field names in one request when it initializes, as long as the field names do not have dependencies on other fields known as key fields. Doing so is a recommended procedure and will save processing time. Subsequently, the external UI can call the service operation whenever necessary.

The external UI does not have to authenticate a user to use this service. That is, a User ID is not required when an external UI calls this service. Therefore, you can use the Get List of Values service operation to populate a list of values on a *pre-Login* page. For example, a pre-login page may ask applicants to select an academic career before they can sign into the external UI.

When the request message contains a LOV Context, the service returns the list of values based on the settings in the List of Values Setup page for the record name, field name, and LOV Context combination.

When the external UI does not include the LOV Context inside the request message, the service returns the list of values based on the settings in the List of Values Setup page for the record name and field name where LOV Context is set to *Default*.

If you have not set up a *Default* LOV Context for the record name and field name, the service returns the list of values based on the prompt table defined for the field name of the record or the translate values if the field passed is a translate field. The service will have no output if the prompt table does not exist or is empty for the record-field name combination.

Warning! Configuring the List of Values Setup page or using the Get List of Values service operation is a technical task and should only be performed by developers with strong Integration Broker skills and good understanding of the record structure contained inside the PeopleSoft Campus Solutions application.

Note: If a SOAP service request XSD contains the 'languageCd' parameter, then the service is enabled for National Language Support (NLS). An ISO Locale value must be passed as the languageCd variable. Valid values can be found in **PeopleTools, Utilities, International, Languages**.

How the Get List of Values service operation returns list of values

There are two ways to return list of values to the external UI:

1. *Default* way: The service uses the record definition or the field properties (for translate fields) defined in Application Designer.
2. *Optional* way: The service uses the List of Values Setup component
 1. Default way: The system can use the default way for both *prompt* and *translate* fields.

The following describes the default way for a prompt field:

- For a prompt field, the list of values that the service returns is determined by the prompt table associated with the field name from the record definition in Application Designer.

For example, in the following graphic, notice that the ADMIT_TERM field name from the ADM_APPL_PROG record is associated with a prompt table TERM_TBL. Therefore, when the ADMIT_TERM field and ADM_APPL_PROG record are passed inside the LOV request message (and no LOV Context is passed) the service retrieves the admit terms list of values from TERM_TBL.

This example illustrates the fields and controls on the Application Designer showing the prompt table associated with a field. You can find definitions for the fields and controls later on this page.

Num	Field Name	Type	Req	Edit	Prompt Table	Set Control Field	Rs Dt	Event
1	EMPLID	Char	Yes	Prompt	PEOPLE_SRCH		No	Yes
2	ACAD_CAREER	Char	Yes	Prompt	STDNT_CAREER		No	Yes
3	STDNT_CAR_NBR	Nbr	No				No	No
4	ADM_APPL_NBR	Char	Yes	Prompt	ADM_APPL_DATA		No	No
5	APPL_PROG_NBR	Nbr	No	Prompt	ADM_APP_CAR_SEQ		No	Yes
6	EFFDT	Date	Yes				No	Yes
7	EFFSEQ	Nbr	No				No	Yes
8	INSTITUTION	Char	Yes	Prompt	INST_CAR_SCTY		No	Yes
9	ACAD_PROG	Char	Yes	Prompt	SAD_APP_PRG_VW		No	Yes
10	PROG_STATUS	Char	Yes	Xlat			No	No
11	PROG_ACTION	Char	Yes	Prompt	ADM_ACTION_SCTY		No	Yes
12	ACTION_DT	Date	No				No	No
13	PROG_REASON	Char	No	Prompt	PROG_RSN_TBL		No	Yes
14	ADMIT_TERM	Char	Yes	Prompt	TERM_TBL		No	Yes
15	EXP_GRAD_TERM	Char	No	Prompt	TERM_TBL		No	Yes
16	RFD_TFRM	Char	No	Prompt	TFRM_TRI		No	No

- To determine which description field to use to return the list of values, the default logic evaluates the identified prompt table (TERM_TBL in our example) and checks if it includes the following fields (respecting the order given): DESCR, DESCRSHORT, DESCR30, DESCR100.

The first of these fields that the service encounters is the one used to return the list of values. If none of these four fields exist, the logic uses the first non-key field marked as a list box item. To continue with our example, for the prompt table TERM_TBL, the DESCR field is the first field encountered from the list mentioned above, and it is therefore the field used to return the list of values.

This example illustrates the fields and controls on the Application Designer showing the description fields for a record. You can find definitions for the fields and controls later on this page.

Num	Field Name	Type	Len	Format	Short Name	Long Name
1	INSTITUTION	Char	5	Upper	Institution	Academic Institution
2	ACAD_CAREER	Char	4	Upper	Career	Academic Career
3	STRM	Char	4	Num	Term	Term
4	DESCR	Char	30	Mixed	Descr	Description
5	DESCRSHORT	Char	10	Mixed	Short Desc	Short Description
6	TERM_BEGIN_DT	Date	10		Begin Date	Term Begin Date
7	TERM_END_DT	Date	10		End Date	Term Ending Date
8	SESSION_CODE	Char	2	Upper	Session	Session

The following describes the default way for a translate field:

For a translate field, the service retrieves the list of values from the field properties defined for the field name and the record. The external UI lets the service know for which field name and record the service should retrieve the values. For instance, if the external UI displays the Phone Type list field, the UI can include inside the request message the record PERSONAL_PHONE and the field name PHONE_TYPE

(and LOV Context is left blank). On receiving this request message, the service includes the translate values defined for the PHONE_TYPE field name inside the response message. The service uses the Long Name fields as the values in the response message.

This example illustrates the fields and controls on the Application Designer showing the field properties for a translate field. You can find definitions for the fields and controls later on this page.

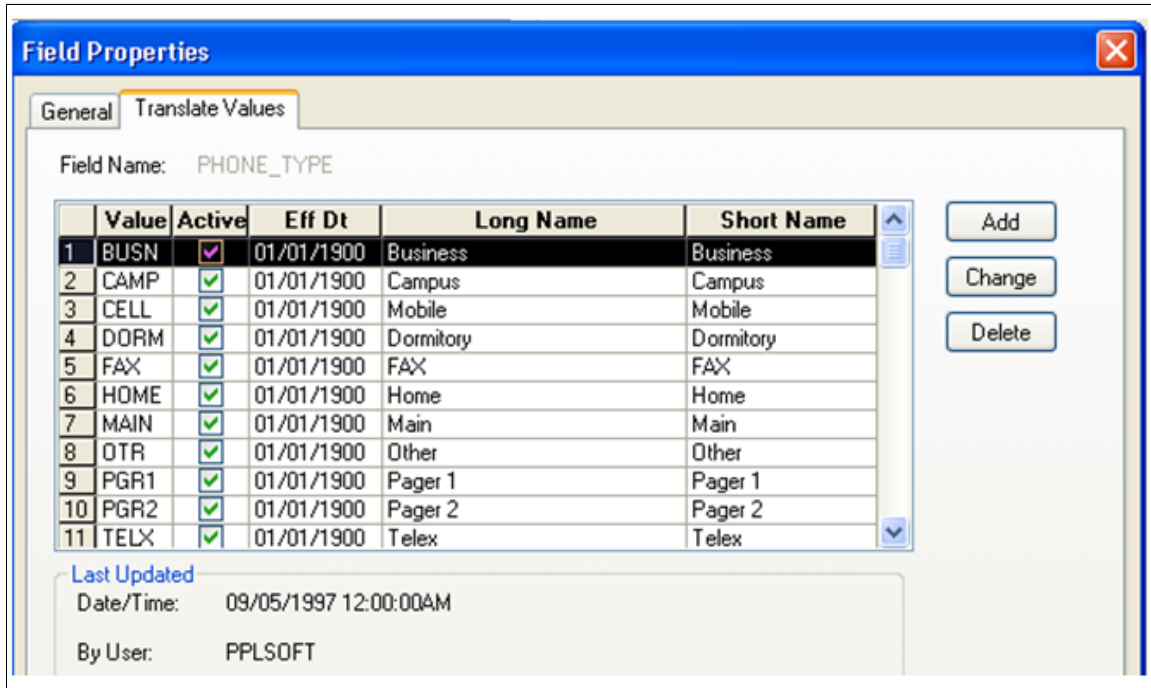

2. Optional way: The system can use the optional way for both *prompt* and *translate* fields. Use the optional way if you do not want to use the default way for a specific list of values to retrieve.

For a prompt field: if you want the service to retrieve list of values from a different table (or a view that contains logic to restrict the returned values), you can use the List of Values Setup component to select a different table (or view), select a different field description or to exclude values you do not want to display inside the external UI.

For a translate field: you can use the List of Value Setup component to make the service retrieve the list of values using the Short Name field or to exclude some values that you do not want to display on the external UI.

Logic to determine which way the Get List of Values service operation should use to return the list of values

To determine whether the *default* way or the *optional* way should be used, the Get List of Values web service operation first evaluates whether the optional way has been set up for the record and the field names included inside the LOV request message, else it uses the default way. The following describes this logic:

1. The logic determines whether the list of values configuration exists in the List of Values Setup component for the record name, field name, and optionally the LOV Context combination that exists inside the LOV request message.

2. If a LOV Context exists inside the LOV request message, the logic retrieves the list of values and the proper description according to the configuration for the record name, field name, and LOV Context combination in the List of Values Setup component.
3. If a LOV Context does not exist inside the LOV request message, the logic still looks at the List of Values Setup component for the record name and field name configuration, but this time where the LOV Context is set as DEFAULT.

If a default exists for the record name and the field name in the List of Values Setup component, the logic returns the LOV response message (SCC_LOV_RESP) according to the record name, field name, and DEFAULT LOV Context.

4. If the DEFAULT LOV Context does not exist, or if the List of Values Setup component is not defined for the record name and field name included inside the LOV request message, the logic uses the record definition or the field properties (in the case of a translate fields) defined in Application Designer for the record name and field name mentioned in the LOV request message.

Get List of Values service operation logic

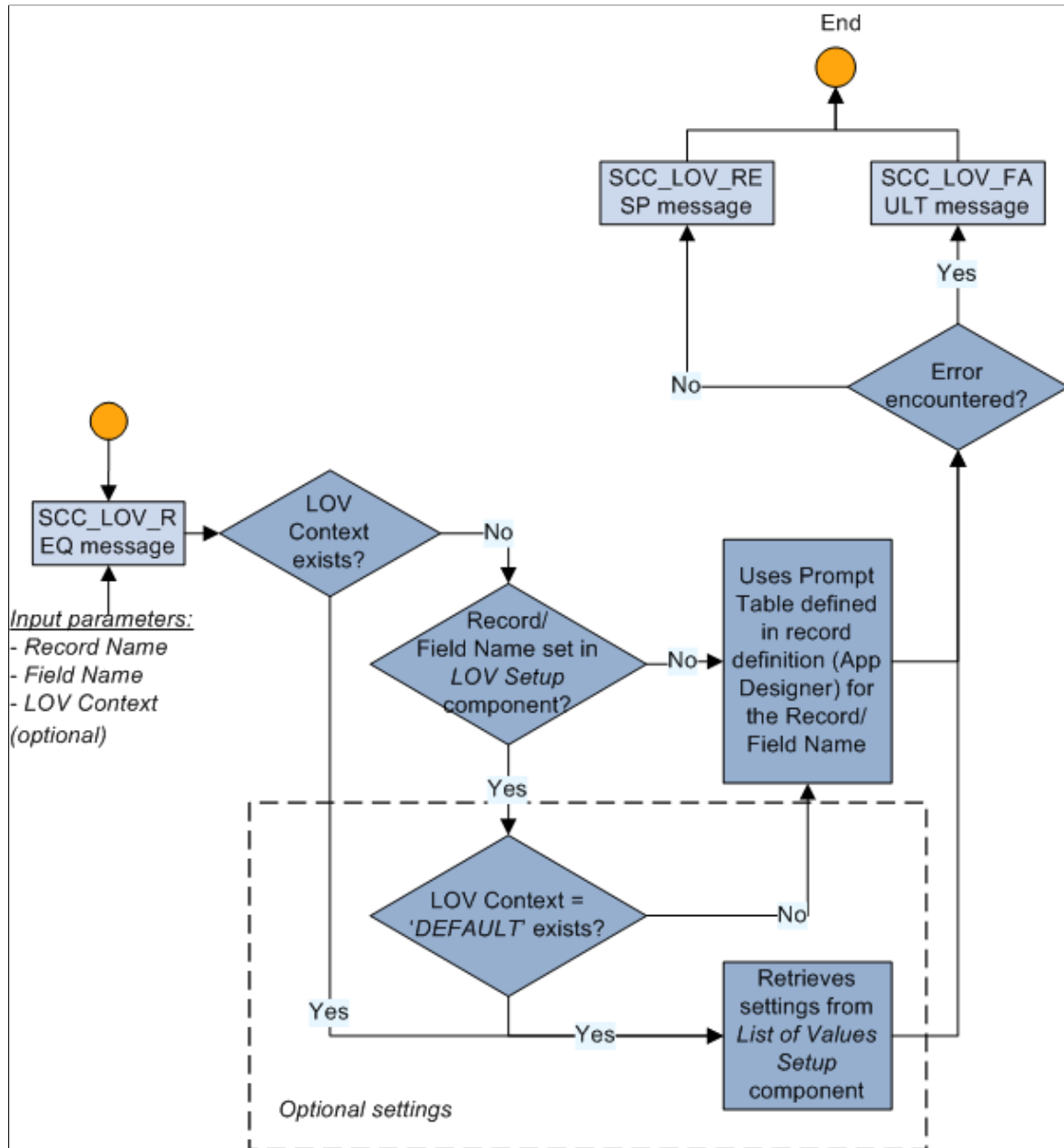

Note that the Get List of Values service operation returns an error message (SCC_LOV_FAULT) to the user interface in the following situations:

- The UI has not supplied the required record name and field name input parameters.
- The UI has not supplied the required key field name input parameters.
- The UI has supplied an invalid record name or field name.
- The UI has supplied a record name or field name which has its prompt table defined as %Editable (dynamic prompt table).

Note: The external UI, which you develop, decides how to handle this error message.

Note: Using the List of Values Setup component is optional. Setting up list of values is useful only if the external UI wants to display lists of values that are defined inside your PeopleSoft Campus Solutions system and you want to alter the default way in which the operation picks up the list of values for a field. If you want the external UI to display lists of values that are defined inside the PeopleSoft Campus Solutions system, and you want to use the default way in which the operation picks up the list of values, you need not use the List of Values Setup page. If you are creating a UI that resides inside your PeopleSoft Campus Solutions system, you need not use this setup component. Instead, use the regular PeopleTools logic to display the translate values and the prompt values. Also, note that only the Get List of Values service operation can use this setup

Setting Up List of Values

This section discusses how to set up list of values.

Page Used to Set Up List of Values

<i>Page Name</i>	<i>Definition Name</i>	<i>Navigation</i>	<i>Usage</i>
List of Values Setup	SCC_SL_LOV	<p>Set Up SACR > System Administration > Utilities > List of Values > List of Values</p> <p>Set Up SACR > System Administration > Utilities > Constituent Transaction Mgmt > List of Values</p> <p>Set Up SACR > Product Related > Recruiting and Admissions > Application Configuration > List of Values</p>	Define how the Get LOV service operation should return the list of values for a field. The system uses this setup when the external user interface calls the Get List of Values service operation.

Setting Up List of Values

Access the List of Values Setup page (**Set Up SACR > System Administration > Utilities > List of Values > List of Values**).

This example illustrates the fields and controls on the List of Values Setup page (1 of 2). You can find definitions for the fields and controls later on this page.

This example illustrates the fields and controls on the List of Values Setup page (2 of 2). You can find definitions for the fields and controls later on this page.

You configure list of values for a specific record name and field name. Because multiple external UIs can use the same record-field name combination and a single UI can use the same record-field name combination differently, you need to identify in which context the setup should be used. You do that by defining a LOV Context. Here is an example of when you will use two different contexts for a record-field name combination. Suppose you want to create an external UI that prospect students will use to review information about the academic programs your institution offers. The Academic Program list or prompt field in the UI should display the list of programs offered for all academic careers. On the other hand, you want to create another external UI that allows an applicant to apply to a specific program for a specific career. In such a case, you want the Academic Program list or prompt field to display the list of programs for which you are ready to accept online applications for a particular career,

such as undergraduate. In both UIs, you want to use the Academic Program field (that is, record name `ADM_APPL_DATA` and field name `ACAD_PROG`), but the UIs should display different list of values. To support this functionality, you may have two contexts for `ADM_APPL_DATA` record name and `ACAD_PROG` field name with different settings to exclude some values. The combination of LOV Context, record name and field name determines which setup to use, to return to the users the proper list of values for a Campus Solutions translate field or a prompt field.

You can also configure, using the same LOV Context, record name, and field name combination, different list of values settings depending on whether the external user interface is used by a self-service user (Self-Service Mode) or an administrative user (Administrator Mode). This is dictated by the external UI logic and the information is passed inside the LOV service operation (`SCC_ADMIN_MODE` element is included inside the LOV request message). Whether or not the external UI passes `SCC_ADMIN_MODE` parameter determines which LOV mode settings are used by the service. Setting the list of values differently for self-service users and administrators can be useful, for example, if you want to restrict the number of values returned to the self-service users or to show them the long descriptions. For your administrative users, it may be more appropriate to show them the short descriptions to enable them to select from a larger list of values.

See [Using Self-Service and Administrator Modes for Online CTM Transactions](#).

Field or Control	Description
Record (Table) Name	Indicates the record reference that you want to configure to determine how the list of values should be returned. You specify the record name when you access the List of Values Setup page in Add mode.

List of Value Context

You define a list of values set up for a combination of a record name and a field name.

Multiple external UIs can use the combination and you can have multiple lists of values setup records for a single record-field combination based on the UI logic. Due to this reason you can define in what context the list of values settings are applicable for the record-field combination.

Use the List of Value Context group box to define a context.

Field or Control	Description
LOV Context	<p>Required. Define the context in which the list of values settings for the record-field name combination will be used.</p> <p>This field is display-only and you can populate a value in this field only by selecting one of the options in the Define LOV Context group box.</p> <p>You define a LOV Context when you create a list of values setup record on the List of Values Setup page. When you save the record, the LOV Context field becomes uneditable.</p> <hr/> <p>Note: While the LOV Context is required inside the List of Values Setup component, it is optional inside the LOV request message. When the request message does not contain a LOV Context, the LOV response message returns the list of values for the DEFAULT LOV Context setup, for the record-field combination. If DEFAULT is not set up for the record-field combination, the service returns the list of values based on the prompt table or the field properties (in the case of a translate field) defined for the record and field in the Application Designer.</p>

Define LOV Context

Select an option to indicate which LOV Context the list of values service should use:

Field or Control	Description
CTM Transaction Code	<p>Select if this list of values setup is specific to a single Constituent Transaction Management (CTM) transaction.</p> <p>By selecting this option, you name the LOV context the same as the transaction code.</p> <p>When you select this option, the Transactions Code field becomes available.</p> <hr/> <p>Note: This option is editable only when you create a new list of values setup.</p>
Transactions Code	<p>Enter a transaction code that the system should name as the LOV context.</p> <p>Note that the lookup for this field displays only the Active Transaction Code values (SCC_TRNSAC_DTLS.SCC_TRANSAC_CD).</p>

Field or Control	Description
User Defined Context	<p>Select if this list of values setup is specific to a user-defined context. For instance, suppose multiple CTM Transaction Codes use the same UI. In such a case, the UI should select a single LOV context that applies to the multiple transaction codes.</p> <p>In addition, you can select this option when the UI is used outside of CTM.</p> <p>When you select this option, the User Defined Context text box field becomes available.</p> <hr/> <p>Note: This option is editable only when you create a new list of values setup.</p> <hr/>
User Defined Context (text box field)	Enter a name for the LOV Context.
Default	<p>Select to set this list of values setup as the default.</p> <p>Select this option when the list of values setup for the selected record name and field name is applicable to all of your external UIs in all circumstances.</p> <p>A <i>default</i> LOV Context is also useful when no LOV Context is included inside the LOV request message (only a record-field combination is included). In such a case, the response message, if it exists, will return the list of values for the Default LOV Context, for the record-field combination.</p> <hr/> <p>Note: This option is editable only when you create a new list of values setup.</p> <hr/>

LOV Setup

Use this scroll area to define the list of value settings for a specific field (Field Name) in the record (Record (Table) Name). You can define list of values settings for multiple fields in a record.

Field or Control	Description
Field Name	<p>Enter the field whose list of values you want to modify.</p> <p>A record may have multiple fields and therefore multiple rows may exist on the LOV Setup scroll area because:</p> <ul style="list-style-type: none"> • The transaction could be inserting data into multiple fields of this record, or • One field is dependent on another field for its list of values. <p>For example, the ADM_APPL_PROG record contains ACAD_PROG and ADMIT_TERM fields because the list of valid academic programs is dependent on an admit term. On an online application transaction, the user must first specify an admit term and then the academic program</p> <p>If you enter a field name that has a user-defined list of values (that is, a prompt field), the system displays the Self-Service Mode and Administrator Mode collapsible sections. Examples of fields that have user-defined list of values include ACAD_CAREER and ADMIT_TYPE for the ADM_APPL_DATA record.</p> <p>If you enter a field name that is set up with translate values in its properties, the system hides the Self-Service Mode and Administrator Mode collapsible sections and displays the Translate Usage group box. Example of a field that has translate values is HOUSING_INTEREST for the ADM_APPL_DATA record.</p>

Self-Service Mode and Administrator Mode

These two collapsible sections appear only for a field name that has a user-defined list of values.

Use the Self-Service Mode collapsible section to control the list of values returned to the external UI accessed by self-service users.

Use the Administrator Mode collapsible section if you want to configure the list of returned values differently when an administrator uses the same record name and field name in the same context. Using the self-service or the administrator mode is dictated by the SCC_ADMIN_MODE logic you put in the external UI. If the external UI includes SCC_ADMIN_MODE in the request message, the service determines that it has to use the Administrator mode. Conversely, if the external UI does not include SCC_ADMIN_MODE in the request message, the service determines that it has to use the Self-Service mode.

In the collapsible sections, you can identify the criteria that the service should use to return the list of values. To define the criteria, you can:

1. Use the *Prompt Table Edit* group box to select the table (or the view) you want to prompt to retrieve the list of values.

By default, the system populates the Prompt Table and the Prompt Field fields with the prompt table information defined in Application Designer for the record and the field name you selected. Using a view here can be useful if you want to add logic to restrict the list of values based on criteria of your choice.

2. Use the *Prompt Table Filters* grid to filter the values in the selected prompt table.

To filter, you can set up a constant or force the values to come from the xml request. In the latter case, the value needs to come from the external UI (whether it is entered by a user or programmatically forced by the UI logic). For example, in the previous List of Values Setup page graphic example, the setup is asking the external UI to specify an academic career (ACAD_CAREER) to filter the admit types to return (ADMIT_TYPE field). The academic career value is either entered by the external UI user or programmatically defined by the UI logic.

3. Use the *Exclude Prompt Field Values* group box to indicate the values you want to exclude from the list of values returned to the self-service users or administrative users.

Note: When you use Administrator Mode, the academic structure security settings restrict the list of values that the service returns. Examples of academic structure security settings include: institution, career, program, and plan security. Therefore, in such cases, administrators can view only those values for which they are authorized to access, as defined in the List of Values Setup component and the academic structure security settings.

See “Securing Academic Structure” (Campus Solutions Application Fundamentals).

Prompt Table Edit

Field or Control	Description
<p>Prompt Table</p>	<p>Select the table from which you want the Get List of Values service operation to retrieve the values.</p> <p>The system populates the Prompt Table field, by default, with the prompt table defined in Application Designer for the record name and field name. You can change this value to select a different prompt table to display the proper values. For example, you could create a view that uses an SQL to further restrict the values to return to the external UI.</p> <hr/> <p>Note: If selected prompt table is a secured table, the external UI users will need to have the proper security to access certain values. In Campus Solutions, granting security access to secured tables is often controlled by User ID under Set Up SACR > Security > Secure Student Administration > User ID. While administrators should always have a User ID, self-service users may not have a User ID. Because self-service users may not have a User ID, on the Self-Service Mode collapsible section, you may need to select a prompt table for which the system does not apply User ID security.</p> <hr/> <p>Warning! You cannot use a dynamic view or a derived record as a prompt table because they are not a reliable list of values source for the service operation.</p> <hr/>
<p>Prompt Field</p>	<p>Select the column from which you want the service operation to retrieve the values.</p> <p>The system populates this field, by default, with the field name defined in Application Designer for the record and field name. You can change this value to select a different field name to display the desired values.</p>

Field or Control	Description
Field Description	<p>Indicate which description field you want the service to use to return the list of values. The choices are the fields contained inside the Prompt Table record you selected.</p> <p>If you know that the external UI users are familiar with seeing the values' short description you could indicate to display the short descriptions, if it is present inside the prompt table. Displaying a list of short descriptions could be appropriate for administrators. But if you want the external UI to display the full descriptions for the values, you may want to indicate to display the long descriptions if it is present inside the prompt table. For example, administrators may be familiar with seeing the short descriptions for the Academic Career values, but a self-service user might find it more useful to see the long descriptions. In such a case, you would set up the value descriptions so that the administrator would see the short description, UGRD and the self service user would see the long description, <i>Undergraduate</i>.</p> <p>Depending on the description field that you select, the LOV response message will return the list of values with the desired descriptions.</p> <hr/> <p>Warning! If you do not enter a description field, the Get LOV response message will return codes without descriptions.</p> <hr/> <p>Warning! While the Field Description prompt shows all the fields contained inside the selected prompt table, make sure you select a field that really stores a description. For instance the long description field is often called DESCR and the short description DESCRSHORT. Selecting a field not related to description will result in wrong behavior.</p> <hr/>

Prompt Table Filters

Use this grid to filter the list of values, based on data populated for certain fields.

On this grid, list the fields that the system will use to filter the list of values. The filtering will be performed based on how these fields are populated. The filtering data can be populated by the UI (when *Request XML* is selected) or by setting a constant (when *Constant* is selected). This is useful especially when key fields need to be populated prior to retrieving the list of values. To do so, you select the key fields that are contained inside the selected prompt table. The service will then need values for these key fields to return the appropriate list of values for the selected prompt field. For instance, if you set up list of values for the ADM_APPL_PROG record name and the ADMIT_TERM field name, the prompt table, by default, to return the ADMIT_TERM values is TERM_TBL. In Campus Solutions, you link defined terms to every academic career at an academic institution (*Set Up SACR, Foundation Tables, Term Setup, Term/Session Table, Term Table*). Therefore, if you enter in the Prompt Table Filters grid, the key field names -

ACAD_CAREER and INSTITUTION - which are part of TERM_TBL, you will ensure that the service returns the proper admit term values in accordance to the user selections.

Additionally, use the Prompt Table Filters grid to list any non-key fields that can help filter even more the list of valid values returned to the users.

The grid functions like the conditions you would have in an SQL query. For instance, return values where *ACAD_CAREER = <value from the UI> AND INSTITUTION = 'PSUNV' (a constant)*.

There are two ways to select a source for the key field name value:

- Select *XML Request* if you want the external UI user to populate the field name.

Continuing with the previous example, you can select *XML Request* for ACAD_CAREER to make the external UI specify an academic career value when it requests for a list of admits term values. The Get List of Values service operation will use the field names marked with *XML Request* as input parameters.

- Specify a *Constant* if you want to force the UI to use a fixed value.

Continuing with the previous example, you can specify a constant *PSUNV* for INSTITUTION in the Prompt Table Filters grid. This will ensure that the service knows that it has to return a list of admit term values for PSUNV. By forcing a constant value, you do not need to include the field inside the external UI (that is, the user does not need to see a field which is set up with a constant value).

Field or Control	Description
Field Name	Enter the key and non-key fields to filter the list of valid values to return to the external UI. The system prompts you from the fields in the prompt table that you selected on the Prompt Table Edit group box.
Source	<p>Define the source from where the value for the field name should come. Valid choices are:</p> <ul style="list-style-type: none"> • <i>Request XML</i>: Select to indicate that the external UI will provide the field value and include it as input parameters inside the list of values Request xml message. <p>The value can either come from the user's selection, or be forced by custom UI logic. When you select <i>Request XML</i>, the Allow Blanks field appears.</p> <ul style="list-style-type: none"> • <i>Constant</i>: Select if you want to force a value for the specific field. <p>When you select <i>Constant</i>, the Constant Value field appears.</p>

Field or Control	Description
Constant Value	<p>Enter the constant value that the system should populate for the field name. The system will use the constant value to filter the list of valid values to return.</p> <p>As an example, in the previous List of Values Setup page screen shot above, the setup indicates that the Get List of Values service operation should return a list of admit type values valid for the institution <i>PSUNV</i>.</p> <p>This field appears when you select <i>Constant</i> in the Source field.</p>
Allow Blanks	<p>Select to indicate that the field value can be blank.</p> <p>As an example, in the previous List of Values Setup page screen shot, the ADMIT_TYPE field name depends on the ACAD_CAREER key field name for its list of values and the Allow Blank check box has been selected for ACAD_CAREER. This is because the ADMIT_TYPE_TBL prompt table can not only store admit types for a specific career, but it can also store admit types for all careers. Therefore, the external UI may choose not to send an ACAD_CAREER value while requesting for admit types.</p> <p>This check box appears when you select <i>XML Request</i> in the Source field.</p>

Exclude Prompt Field Values

Use this group box to exclude all or some of the values returned by the Prompt Table you selected and by the Prompt Table Filter if you had set up field names with a constant value. For example, in the previous List of Values Setup page screen shot, the setup indicates that the INSTITUTION field name is marked with a constant value *PSUNV*. Using the Exclude Prompt Field Values grid, you can exclude any ADMIT_TYPE values from the prompt table selected (ADMIT_TYPE_TBL record) where INSTITUTION = *PSUNV*.

This group box is available for both types of fields: field names that have user-defined lists of values (prompt fields) and field names that have translate list of values.

Note: Limitation: The exclusions cannot be conditional. The service excludes the values that you select here regardless of the data that the external UI passes for the Prompt Table Filters fields. For instance, suppose you selected Prompt Table = 'ADM_APPL_DATA', Prompt Field = 'ACAD_CAREER', in the Prompt Table Filters grid you added field name INSTITUTION with Request XML and you excluded the value 'UGRD' (Undergraduate). Now Undergraduate may be a valid academic career for several of your institutions. In such a case, the UGRD value will be excluded regardless of the institution the users may select.

Field or Control	Description
Populate Valid Values	<p>Click to populate the Excluded Values grid with the field's values.</p> <p>You can use this button as a utility to preview the values that the service will return to the users and then decide which values, if any, you want to specifically exclude.</p> <hr/> <p>Note: The Populate Valid Values button queries the prompt table that you selected and includes, as criteria, the constant values you may have entered inside the Prompt Table Filters grid. For instance, if you had entered in the Prompt Table Filters grid, the key field name INSTITUTION with a constant value of PSUNV, the button will query the prompt table where INSTITUTION = PSUNV. The result that the Excluded Values grid displays is a distinct list of the valid values for the selected field name. The Excluded Values grid also considers Effective Date and Effective Status when it displays the list of values.</p> <hr/> <p>Warning! Depending on the number of values to return, the processing time when you click the button can vary.</p> <hr/>
Remove All Values	Click to remove all the values from the Excluded Values grid.
Value	<p>Specify the values that you want to exclude from the external UI users.</p> <p>The system prompts you the values from the prompt field that you selected on the Prompt Table Edit group box. The prompt performs the same query as previously described for the Populate Valid Values button.</p>
Description	<p>Displays the value descriptions in accordance with the Field Description value you selected in the Prompt Table Edit group box.</p> <p>If you have left the Field Description blank, the system does not populate this field.</p>

Setting up list of values for translate list of values

When you set up list of values for a field name that contains translate values, the system hides the Self-Service Mode and the Administrator Mode sections and displays the Translate Usage group box.

Use the Translate Usage group box to indicate whether you want the service to return either the long descriptions or the short descriptions as the list of values.

The Self-Service Mode and the Administrator Mode sections are not applicable for field names that have translate values.

The system also displays the Exclude Prompt Field Values grid, when you select a translate field name. The Exclude Prompt Field Values grid is described in the previous topic.

This example illustrates the fields and controls on the Example of a field with translate list of values. You can find definitions for the fields and controls later on this page.

List of Values Setup

Record (Table) Name: PERSONAL_PHONE

List of Value Context

LOV Context: Special Phone Types

Define LOV Context

CTM Transaction Code
 User Defined Context
 Default

User Defined Context:

LOV Setup Find | View All First 1 of 1 Last

*Field Name: + -

Translate Usage

Use Long Description
 Use Short Description

Exclude Prompt Field Values

Populate Valid Values
 Remove All Values

Excluded Values		Customize Find View All	First 1-3 of 3 Last
	*Value	Description	
1	<input type="text" value="PGR1"/> 🔍	Pager 1	+ -
2	<input type="text" value="PGR2"/> 🔍	Pager 2	+ -
3	<input type="text" value="TELX"/> 🔍	Telex	+ -

Copyright © 1988, 2024, Oracle and/or its affiliates.

607

Setting Up Entity Registry

Understanding Entity Registry

An entity is an object that provides access (view, create, or update) to data in a record. You implement an entity through an application class.

The system delivers entities related to constituent (personal), admissions, and enrollment data. The list of delivered entities may grow with new web services or new functionality that we may deliver in the future. You can create new entities and extend delivered entities (or modify them to a lesser degree). New entities can be built based on new or existing records. How the entity relates to the record is dependant on the entity type.

Note: You define entity relationships in the Entity Registry component. However, outside of the Entity Registry component, entities are unaware of each other. This means all the code related to a particular entity is entirely encapsulated in that entity. This keeps the entities clean and avoids including child entities code inside the parent entity. For instance, even if *Emergency Contact* entity is a child of *Constituent* entity, the latter does not know anything about *Emergency Contact* other than having a relationship defined in the Entity Registry component.

Use the Entity Registry component to configure how the system should use specific entities (or properties). Entity logic is designed to be-reusable for different purposes such as:

- **Web services:** Based on the specified application class, the Entity Registry component enables you to automatically generate code and XML schemas. You can then directly paste the generated code and schemas inside the application classes and Integration Broker messages. The system uses these classes and messages when a transaction is processed through web services. Web services can use the entities for moving the data to and from functionalities such as XML messages, error handling, save/delete, and any other functionality coded in the entity.
- **Component data validation:** Components and web services can use the same logic to do data validation. Currently, the easiest way to reuse the logic is in Savepostchange code. For example, the Application Transactions and the Constituent Staging components use this way.
- **Beans:** Beans are objects containing multiple types of data. Entities are a natural fit to support beans. This is because you can design entities to support multiple types of data, and make any transition to web services easy.
- **APIs:** The system can use entities to modify record data programmatically, with full access to all the common logic used by components or web services.
- **Import/Export:** The system can export data to XML files easily using the entities' ability to get data and encode it into XML. Import can be done using the ability to translate data from a XML file and save the translated data.

- **Batch Processing:** You can use entities to handle data in batch. This can be done by loading the data using XML matching the entity style, or by any other means such as populating the data into an entity directly.

The Admissions Application Web Services (AAWS) feature illustrates an example of how to use the Entity Registry component. In AAWS, an applicant uses a user interface to enter constituent (personal) and admissions application information. In such a case, the system first needs to stage the entered information, then validate it, and finally move the information to the corresponding production tables. We have delivered entities for the constituent data (for example, Names, Addresses, Emergency Contacts, and so on) and we have delivered entities for the admissions data (for example, Academic Interests, Academic Plan, Academic Program, and so on). For each of these entities, we have configured the name of the stage record and the name of the equivalent production record in the Entity Registry component. Based on this delivered Entity Registry component configuration, the system knows how to pass the information that exists inside the incoming and outgoing web services.

Warning! Configuring or extending an entity is a technical task and should only be performed by developers with strong Integration Broker, Application Package, PeopleTools skills and record structure.

Entity Component Adapter

The entity component adapter allows entities to bind to the component row sets. By binding to the component, entity validation and presave logic can be run on live component data. This allows us to better consolidate common logic and make sure that components, services, APIS, etc. all follow the same rules for the data. The Entity Component Adapter also serves to allow rules to be run based on component data.

Configuring Entity Types

This section discusses how to:

- Set up entity types.
- View entities for an entity type.

Pages Used to Configure Entity Types

<i>Page Name</i>	<i>Definition Name</i>	<i>Navigation</i>	<i>Usage</i>
Entity Type	SCC_ENT_TYPE	Set Up SACR > System Administration > Entity > Entity Type	Define categories of entities. This allows for more control over how the entity functions.
Implementation	SCC_ENT_TYPE_IMPL	Set Up SACR > System Administration > Entity > Entity Type > Implementation	View the list of entity names set up for an entity type.

Setting Up Entity Types

Access the Entity Type page (Set Up SACR > System Administration > Entity > Entity Type).

This example illustrates the fields and controls on the Entity Type page. You can find definitions for the fields and controls later on this page.

Entity Type

Implementation

Entity Type Configuration

Entity Type ID SCC_ETYPE_20110413195013

***Entity Type Name**

Description

A type of entity where two records are used, staged record and production record. It is assumed direct access is allowed to stage record and production record.

Base Class

Default Class

Code Generation

Controlled Via API Only

Use Production Record

Use Stage Record

Allow Properties

Sync AppClass

Entity Type Children Personalize | Find | | First 1-3 of 3 Last

	Entity Type Name			
1	<input style="width: 95%;" type="text" value="Staged Entity"/>	+	-	
2	<input style="width: 95%;" type="text" value="Staged HR Entity"/>	+	-	
3	<input style="width: 95%;" type="text" value="Custom Staged"/>	+	-	

Field or Control	Description
Entity Type ID	<p>Displays the auto-generated unique ID.</p> <p>When you add a new entity type, this field displays the value <i>NOID</i> until you save the record. When you save the new entity type, the field displays the ID that the system assigned to the entity type.</p>
Entity Type Name	<p>Enter the name of the entity type.</p> <p>The value that you enter here will become a prompt value for the Entity Type field on the Entity Registry page.</p>
Description	<p>Enter the description of the entity registry, primarily for documentation purposes.</p>
Base Class	<p>Enter the base application class that entities, who want to implement this type, should extend for code generation.</p> <p>If you implement properties, the system uses the Base AppClass to find the baseProps for property generation. baseProps are properties that already exist on the parent and therefore do not need to exist on the child.</p> <p>For an example of how a Base AppClass is coded, use Application Designer to review the application class SCC_COMMON:ENTITY:BasicEntity.</p> <hr/> <p>Note: Most of the code that you can use for entity functionality is located inside the SCC_COMMON:ENTITY:AbstractEntity. At a technical level all the delivered entity types, except <i>Custom</i>, extend AbstractEntity. AbstractEntity provides a lot of the functionality common across entities in the Entity Registry feature. For example, auto handling parent-child relationships, audit fields, save, delete, and so on are all handled by AbstractEntity, because they all function the same regardless of different types of data that entities handle. You will have to override the Entity Type base class if anything has to be customized for a particular type.</p> <hr/> <p>See Entity Application Class Reference.</p>

Field or Control	Description
Default Class	<p>Specify the application class that can be used as a default for entities of this type. Entities using the default class cannot have any custom code, but will handle any property setup done through the Entity Registry. Providing a default class makes specifying an application class when creating an entity optional, otherwise it is mandatory.</p> <p>All entities of this type must extend <code>SCC_COMMON:ENTITY:IEntity</code>. However, their constructor must take two arguments in the signature. The first is the parent entity. The second is the entityID for this entity as a string.</p> <p>For examples of default classes see the package <code>SCC_COMMON:ENTITY:GENERIC</code>.</p>
Code Generation	<p>Enter the application class that the system uses to generate entity code when you select an Action of <i>Generate Code</i> on the Entity Registry page.</p> <p>For an example of how an application class used for code generation is coded, use Application Designer to review the application class <code>SCC_COMMON:ENTITY:CODEGEN:EntityGeneratorBase</code>.</p> <p>If you do not specify the code generation class, the system hides the <i>Generate Code</i> action when you select this entity type on the Entity Registry page.</p> <p>See Setting Up Entity Registry.</p>
Controlled Via API Only	<p>Select if you want that no entities of the type can be added through the Entity Registry page. When set up via the API certain parts of the entity may be locked for editing through the Entity Registry component.</p>
Use Production Record	<p>Select if the entities tied to this entity type need a production record. If this check box is not selected, the Production Record field is not shown on the Entity Registry page. By default, every entity uses a production record.</p>
Use Stage Record	<p>Select if the entities tied to this entity type need a stage record. A stage record is useful if you want to temporarily store data for validation or processing before moving the data into a production record.</p> <p>If you do not select this check box, the system does not display the Stage Record field on the Entity Registry page. The Apply Data Update Rule is also disabled because it is only used when stage records are involved.</p> <p>See Understanding Entity Registry.</p>

Field or Control	Description
Allow Properties	<p>Select if you want to configure the entity properties for all the entities tied to this entity type.</p> <p>To configure the entity properties, select <i>Edit Properties</i> in the Action field on the Entity Registry page.</p> <p>If you deselect the Allow Properties check box, the <i>Edit Properties</i> action is not available on the Entity Registry page.</p>
Sync AppClass (Sync Application Class)	<p>Specify an application class to synchronize the properties to the underlying records. While this is mostly needed if the entity type allows properties, you can also sync properties programmatically even if configuring the properties is not allowed. For the latter case, do not select the Allow Properties check box and enter the appropriate sync application class.</p> <p>For an example of a Sync AppClass, use Application Designer to review the application class SCC_COMMON:ENTITY:PROPERTY:PropertySyncBase.</p> <p>See Synchronizing Entity Properties.</p>

Entity Type Children

Use this grid to list the Entity Types for which you can add child entities on the Entity Registry page.

On the Entity Registry page, you can add child entities to a parent entity. You can add a child entity only if its entity type is entered in the Entity Type Children grid.

For example, if you create an entity type that uses production and stage records, you could list in this grid other entity types that use this setup. This will allow, in the Entity Registry page, to select child entities that are set up with an entity type different from the parent, but follows the same logic.

For details on how children entities are defined, see [Setting Up Entity Registry](#), “Configuring Entity Registry.”

Rules Engine Data Set and Read Only Entity Types

The Rules Engine Data Set entity type supports entities that are not record based. These entities are purely meant to act as data structures. This version of data sets is used by the rules engine, and controlled via a custom, simplified interface.

See [Understanding the Rules Engine](#).

Read Only entities are essentially basic entities for which save and delete are disabled. They make it easy to create entities on top of records for rules engine access. This makes it easy to add new entities accessible from the rules engine without introducing back door data updates. If at some point proper validation and/or presave logic is added, the entity can be switched to Basic Entity and save and delete would be enabled.

Viewing Entities for an Entity Type

Access the Implementation page (**Set Up SACR > System Administration > Entity > Entity Type > Implementation**).

This example illustrates the fields and controls on the Implementation page. You can find definitions for the fields and controls later on this page.

Entity Type
Implementation

Entity Type Name Staged HR Entity

Entity Type Implementations
<div style="display: flex; justify-content: space-between; align-items: center; font-size: 0.9em;"> Customize Find First 1-24 of 24 Last </div>
Entity
Address
Citizenship
Citizenship Passport
Constituent
Disability
Diversity
Drivers License
Drivers License Type
Email Address
Emergency Contact
Emergency Phone
Ethnic Diversity
Language
Licenses and Certificates
Memberships
Names
National ID
Person Data (CAN)
Person Data (USA)
Person Data Effdt
Phone
Publications
QA TEST ENTITY PROPERTIES
Visa Permit Data

Click an Entity link to access the Entity Registry page for the entity.

Setting Up Entity Registry

This section discusses how to:

- Configure entity registry.
- Set up entity properties.
- Set up entity property details.
- Create entity views.
- Generate entity schema.
- Generate entity code.
- View the entity hierarchy.

Pages Used to Set Up Entity Registry

<i>Page Name</i>	<i>Definition Name</i>	<i>Navigation</i>	<i>Usage</i>
Entity Registry	SCC_ENTITY_REG	Set Up SACR > System Administration > Entity > Entity Registry	<p>Maintain the delivered entities and extend the data structure to process your transactions. Generate code or schema based on the setup data that you enter on this page.</p> <p>You can paste the generated code inside the application class. The application class can be used by a mechanism to process data, for example a web service. Generate schema that can be pasted inside the Integration Broker schema.</p> <p>Synchronize an entity.</p>
Entity Properties	SCC_ENTITY_FIELDS	Select <i>Edit Properties</i> in the Action field on the Entity Registry page.	<p>Review the list of property names and field names contained inside the stage record (if it exists) and the production record for the entity.</p> <p>Modify the default configuration if you want a specific property name to behave differently when passed inside request or response XML messages.</p>

Page Name	Definition Name	Navigation	Usage
Entity Property Details	SCC_ENT_PROP_DTLS	Click the Details link on the Entity Properties page.	Maintain the label, element name and default value for a specific property. Set up list of values if needed.
Entity Registry Views	SCC_ENT_REG_VWS	Select <i>Edit Entity View</i> in the Action field on the Entity Registry page.	Create subsets of entity meta-data.
Entity Schema	SCC_ENTITY_XSD	Select <i>Generate XSD</i> in the Action field on the Entity Registry page.	View the auto-generated entity schema code. You can copy and paste this code inside the schema of an Integration Broker message.
Entity Code Generation	SCC_ER_CGEN	Select <i>Generate Code</i> in the Action field on the Entity Registry page.	Set up how you want to generate the application class code. After generating the application class code, you can paste this code inside an application class in Application Designer.
Entity Hierarchy Display	SCC_ENTITY_HRCHY	Select <i>View Hierarchy</i> in the Action field on the Entity Registry page.	Review the children hierarchy for the selected entity. Note: The page does not display the entity's parent relationships. Only child relationships are displayed.

Configuring the Entity Registry

Access the Entity Registry page (**Set Up SACR > System Administration > Entity > Entity Registry**).

This example illustrates the fields and controls on the Entity Registry page. You can find definitions for the fields and controls later on this page.

Entity Registry

Entity Configuration

Entity ID SCC_ENTITY_20090723101507

Name

Status

Entity Type

Description

***AppClass**

Prod Record

Stage Record

Element (XML)

Log PeopleTools Audit

This example illustrates the fields and controls on the Entry Registry page (2 of 2). You can find definitions for the fields and controls later on this page.

Apply Data Update Rule

Action

Children Personalize | Find | | First 1 of 1 Last

Order	Entity Name	Status	Embed	*Min	*Max	Element Wrapper (XML)	Hide	View
	<input type="text" value="Emergency Phone"/>	Active	<input type="checkbox"/>	0	0	<input style="width: 100%;" type="text"/>	<input type="checkbox"/>	View + -

Parent

Emergency Contact

You can use the Entity Registry page to not only create new entities but also to maintain existing entities.

For example, you can use the page to:

- Specify that you do not want to apply a data update rule to an entity.
- Change the application class that handles the entity data.
- Change the staging or production table record.
- Require a property to be included inside the incoming or the outgoing xml message.
- Generate the schema based on specific entity settings that you can later use to configure the messages in Integration Broker.
- Generate the base code for the entity based on the configuration provided.
- Add entities as children, extending the entity tree.
- Edit entity views.
- Sync entities.

Entity Configuration

Field or Control	Description
Entity ID	Displays the auto-generated unique ID. When you add a new entity type, this field displays the value <i>NOID</i> until you save the record. When you save the new entity, the field displays the ID that the system assigned to the entity.
Name	Required. Enter the entity name.
Status	Required. Enter the entity status. If you select <i>Inactive</i> , the system ignores the entity and its children.
Entity Type	Select the entity type. The system prompts you with the entity types defined on the Entity Type page. See Configuring Entity Types .
Description	Enter the description of what the entity is used for.

Field or Control	Description
AppClass (Application Class)	<p>Specify the application class that implements the entity's logic.</p> <p>Generally, this application class provides the properties, and adds any custom validation, pre-save, or fill logic. However, because it is an application class, this class can override any functionality from the base class.</p> <p>The delivered base classes are stored inside the application package called: SCC_COMMON:ENTITY (for instance StagedEntity, StagedHREntity, BasicEntity, ChildEntity, and WorkEntity application classes). The application class that you enter here extends these existing application classes depending on the entity type.</p> <hr/> <p>Note: When creating a new entity, you can create an empty application class in Application Designer and enter its name here. Once the entity setup data is entered, you can select <i>Generate Code</i> in the Action field to generate the code that can be pasted inside the application class peoplecode.</p> <hr/> <p>If the entity is of a type that supports a default class the application class will not be marked required, and if no application class is specified the default will automatically be used. The default can be overridden at any time by specifying an appclass here.</p>
Prod Record (Production Record)	<p>Enter the name of the production record where the entity data is permanently stored.</p> <hr/> <p>Note: This field appears only if you have indicated that the selected entity type will use production record. You indicate this on the Entity Type page.</p> <hr/>
Stage Record	<p>Enter the name of the stage record where the entity data is temporarily stored.</p> <hr/> <p>Note: This field appears only if you have indicated that the selected entity type will use stage record. You indicate this on the Entity Type page.</p> <hr/>

Field or Control	Description
Element (XML)	<p>Enter the element name that the system will use for this entity inside the XML messages.</p> <p>The name that you enter here should not match any other entity's element name and cannot contain spaces. For example, for the delivered Emergency Contact entity name, we gave the element name EMERGENCY_CONTACT.</p>
Log PeopleTools Audit	<p>Select the check box to allow saving to PeopleTools audit records created to track changes to data. By default, tools auditing in entity registry is turned off.</p> <p>Entity application classes with their own <i>populateAudit</i> and/or <i>Save</i> methods must add calls to these methods for auditing to work:</p> <ul style="list-style-type: none"> • Method <i>populateAudit</i>—add call to Abstract Entity's <i>populateToolsAudit()</i>; • Method <i>Save</i>—add call to Abstract Entity's <i>saveToolsAudit()</i>; <p>If a record's entity application class has overridden the <i>populateAudit</i> and/or <i>Save</i> methods, it must be modified to add methods that log audit data.</p> <p>When a record is marked for auditing, the tools auditing feature caches the record and its field details, preventing recurring requests to the database for the record's audit setup. For that reason, you need to update or reset the entity registry cache whenever you update the audit setup of a record in the application designer. You can update the cache from the Entity Registry and Entity Property Sync pages.</p>

Field or Control	Description
Apply Data Update Rule	<p>Select if you want to apply a data update rule to an entity. You use the Data Update Rule Entry page to define data update rules for an entity. Defining data update rules for an entity may require additional coding.</p> <hr/> <p>Note: SCC_COMMON.ENTITY.AbstractEntity application class handles the basic logic for data update rules. For special cases, where rules could be subdivided by type, the logic resides in the particular entity's application class.</p> <hr/> <p>Note: To populate an entity on the Data Update Rule Entry page, you must first select the Apply Data Update Rule check box for the entity on the Entity Registry page. Then, click the Refresh button on the Data Update Rule Entry page. Conversely, to remove an entity from the Data Update Rule Entry page, first deselect the Apply Data Update Rule check box for the entity. Then, click the Refresh button on the Data Update Rule Entry page.</p> <hr/> <p>See Setting Up CTM.</p>
Action	<p>You can select from the following actions:</p> <ul style="list-style-type: none"> • <i>Edit Entity View</i> • <i>Edit Properties</i> • <i>Generate Code</i> • <i>Generate XSD</i> • <i>Sync Entity</i> • <i>Unit Test</i> • <i>View Hierarchy</i> <p>See the “Selecting Actions on the Entity Registry Page” section for information about these actions.</p>

Selecting Actions on the Entity Registry Page

Field or Control	Description
Edit Entity View	Select to access the Entity Registry Views page. Entity views allow the creation of subsets of entity meta-data.

Field or Control	Description
Edit Properties	<p>Select to access the Entity Properties page.</p> <p>The Entity Properties page enables a finer control of entity properties through a UI controlled meta-data.</p> <hr/> <p>Note: This action is available only if you have indicated that the selected entity type will use properties. You indicate this on the Entity Type page.</p> <hr/>
Generate Code	<p>Select to access the Entity Code Generation page after you complete the entity registry setup. The Entity Code Generation page enables you to configure and generate the application class code.</p> <p>See Setting Up Entity Registry, “Generating the Entity Code.”.</p>
Generate XSD	<p>Select to access the Entity Schema page. The Entity Schema page displays the generated schema that you can paste inside an Integration Broker message schema.</p> <hr/> <p>Note: While you can generate schemas from any entities, it is useful only for entities that a service directly calls. In other words, it depends on what the base entity needs from a service that uses the entity. For example, the <i>Names</i> entity (which is a child of the <i>Constituent</i> entity) is not directly used. Therefore, if you extended the Names entity or make modifications to it, do not generate the XSD for <i>Names</i>, but instead generate the XSD for its root entity (that is, <i>Constituent</i>).</p> <hr/> <p>Note: It is useful to select this action when the root entity is modified. For instance, select this action for a parent entity, if you add or remove its children entities inside the Children grid.</p> <hr/> <p>See <i>PeopleSoft Integration Broker</i> for more details on schemas.</p>

Field or Control	Description
Sync Entity	<p>Select this action to run the sync process. A pop-up appears to indicate that the sync process has completed.</p> <p>The sync process:</p> <ul style="list-style-type: none"> • Updates properties to match underlying records. <p>The sync process syncs the entity properties with the fields of the underlying records (stage record if it exists and production record). The sync process ties a property to each field of the underlying records. This is very important because the system uses the properties as the source of truth to drive the functionality of the underlying entity, as well as to generate the entity code and schema (not the field names or the record objects).</p> <ul style="list-style-type: none"> • Keeps entity views up to date with changes to entity properties and children. • Keeps entity properties/children synced with the Common Attribute Framework. <p>You should run the sync process after creating or modifying an entity or after you have set up or changed the underlying records for the entity.</p> <p>You must run the sync process before you generate any entity code or schemas. Therefore, the sync process is automatically triggered when you save the Entity Registry component or select an Action of <i>Generate Code</i> or <i>Generate XSD</i> (selecting these actions would also trigger a save) when one of the following conditions is met:</p> <ul style="list-style-type: none"> • A new entity is created. • The stage or production record has been changed. • The last updated datetime of either record is more recent than the last updated datetime of the entity. <p>The sync process is supported based on entity type. Currently, all delivered entities, except <i>Custom</i>, support syncing.</p> <hr/> <p>Note: The Sync Entities action is available only if you have specified a Sync AppClass for the entity type. If you have selected the Allow Properties option but did not specify a Sync AppClass on the Entity Type page, even then the system does not display the action.</p>

Field or Control	Description
	<p>Note: The sync process does not reset the settings you have entered on the Entity Properties and the Entity Property Details pages. The process only synchronizes the entities and field names with the underlying records.</p> <hr/> <p>Warning! If you add, remove, or rename a field of an underlying record, then all the entities using the record must be re-synchronized. The Sync process will handle property associations. After the sync, you should update the code to incorporate the changes the sync process had made. The easiest way to do this is to simply regenerate the code and re-add any customizations.</p> <hr/> <p>Note: Properties that are specified on the entity definition that do not exist at all in the code will be automatically handled. If the property maps to a field on the record that will be taken care of. If the property is completely new it will be stored in a hash table. Either way the safest way to access that data is by using the new methods <code>getProperty</code> and <code>setProperty</code>. Defaults all use these methods to access properties.</p> <hr/> <p>You can also manually update the code. To do this, remove database references from fields that are no longer part of the record. Add properties for new fields that should now be in the property list.</p> <p>See Synchronizing Entity Properties.</p>
Unit Test	<p>Select to access the Entity Unit Tests page. The page lists the unit tests that you have created for the entity and enables you to run the unit tests.</p> <p>See Executing Unit Tests for Entities.</p>
View Hierarchy	<p>Select to view the children hierarchy for the entity.</p>

Children

Use the Children grid to list the entity names that are children of the main entity name. For example, in the preceding Entity Registry page screen shot, the Emergency Contact is the main entity and the Emergency Phone is a child. A parent-child relationship does not imply dependency. Each entity can exist independently and is sometimes used as such, that is, you can directly create an instance of Emergency Phone entity and use it to modify an Emergency Phone Number, without needing the parent. Entity logic is encapsulated inside the entity and is unknown from the related entities.

Warning! To create parent-child relationships, a good understanding of the data structure is required.

Field or Control	Description
Order	Specify the sequence of the child entities in the XML schema.
Entity Name	<p>Enter the name of the child entity.</p> <p>The system prompts you with only the entities that are configured with an entity type defined as Entity Type Children for the parent entity type. For example, suppose on the Entity Type page, for <i>Staged Entity</i> type you have added two entity type children, <i>Staged Entity</i> and <i>Custom</i>. Now, suppose Academic Program and Academic Plan entities have an entity type of <i>Staged Entity</i> on the Entity Registry page. Two other entities - Academic Interests entity has an entity type of <i>Custom</i> and Prospect Program entity has entity type of <i>Basic Entity</i> on the Entity Registry page. Therefore, on the Entity Registry page you can add Academic Plan and Academic Interests as child entities for the Academic Program entity.</p> <p>However, you cannot add Prospect Program entity as a child for the Academic Program entity.</p> <p>See Configuring Entity Types.</p>
Status	Displays the status of the child entity.
Embed	<p>Specify how you want the XML messages to display the child entity data with the parent entity data.</p> <p>Select the Embed check box if you want the child entity data to be embedded in the parent entity data. This is useful for certain sibling record purposes where you do not want the XML to show the child at a separate level from the parent.</p> <ul style="list-style-type: none"> Example when non-embedded (that is, you do not select the Embed check box): <pre data-bbox="911 1451 1154 1625"><Entity> <Data1/> <Data2/> <Entity2> <Data3/> </Entity2> </Entity></pre> Example when embedded (that is, you select the Embed check box): <pre data-bbox="911 1751 1127 1875"><Entity> <Data1/> <Data2/> <Data3/> </Entity></pre>

Field or Control	Description
Min	Enter the minimum number of occurrences of this entity under the parent, which can be the number 0 or any number greater than 0.
Max	<p>Enter the maximum number of occurrences of this entity under the parent.</p> <hr/> <p>Note: The number 0 means the maximum is unbounded, or any number greater than the min value can be used.</p> <hr/>
Element Wrapper (XML)	<p>Optional. Enter a value that the system can use as a tag to wrap all the child occurrences of this entity under the parent.</p> <ul style="list-style-type: none"> Example when Element Wrapper (XML) is left blank (no wrapper): <pre data-bbox="909 840 1136 1165"> <Entity> <Data1/> <Data2/> <Entity2> <Data3/> </Entity2> <Entity2> <Data3/> </Entity2> <Entity3> <Data4/> </Entity3> </Entity> </pre> Example when Element Wrapper (XML) is defined (with wrapper): <pre data-bbox="909 1291 1201 1669"> <Entity> <Data1/> <Data2/> <Wrapper> <Entity2> <Data3/> </Entity2> <Entity2> <Data3/> </Entity2> </Wrapper> <Entity3> <Data4/> </Entity3> </Entity> </pre>
View	Click to access the Entity Registry page for the child entity.

Parents

This region displays the parent entities. More than one parent can exist. Click the link to access the Entity Registry page for the parent.

Setting Up Entity Properties

Access the Entity Properties page (select *Edit Properties* in the Action field on the Entity Registry page).

This example illustrates the fields and controls on the Entity Properties page (1 of 2). You can find definitions for the fields and controls later on this page.

Entity Properties

Entity Name Emergency Contact

Property Details													Personalize	Find	1-34 of 34	Last
Order	Property Name	Property Type	Field Name	In Stage	In Production	Attribute	Viewable	Editable	Required	LOV	Details					
1	SCC_TEMP_ID	Number	SCC_TEMP_ID	<input checked="" type="checkbox"/>	<input type="checkbox"/>	<input type="checkbox"/>	<input checked="" type="checkbox"/>	<input checked="" type="checkbox"/>	<input type="checkbox"/>	<input type="checkbox"/>	Details	+ -				
2	EMPLID	String	EMPLID	<input type="checkbox"/>	<input checked="" type="checkbox"/>	<input type="checkbox"/>	<input checked="" type="checkbox"/>	<input checked="" type="checkbox"/>	<input type="checkbox"/>	<input type="checkbox"/>	Details	+ -				
3	CONTACT_NAME	String	CONTACT_NAME	<input checked="" type="checkbox"/>	<input checked="" type="checkbox"/>	<input type="checkbox"/>	<input checked="" type="checkbox"/>	<input checked="" type="checkbox"/>	<input checked="" type="checkbox"/>	<input type="checkbox"/>	Details	+ -				
4	SAME_ADDRESS_EMI	String	SAME_ADDRESS_EMPL	<input checked="" type="checkbox"/>	<input checked="" type="checkbox"/>	<input type="checkbox"/>	<input checked="" type="checkbox"/>	<input checked="" type="checkbox"/>	<input checked="" type="checkbox"/>	<input type="checkbox"/>	Details	+ -				
5	PRIMARY_CONTACT	String	PRIMARY_CONTACT	<input checked="" type="checkbox"/>	<input checked="" type="checkbox"/>	<input type="checkbox"/>	<input checked="" type="checkbox"/>	<input checked="" type="checkbox"/>	<input checked="" type="checkbox"/>	<input type="checkbox"/>	Details	+ -				
6	COUNTRY	String	COUNTRY	<input checked="" type="checkbox"/>	<input checked="" type="checkbox"/>	<input type="checkbox"/>	<input checked="" type="checkbox"/>	<input checked="" type="checkbox"/>	<input type="checkbox"/>	<input type="checkbox"/>	Details	+ -				
7	ADDRESS1	String	ADDRESS1	<input checked="" type="checkbox"/>	<input checked="" type="checkbox"/>	<input type="checkbox"/>	<input checked="" type="checkbox"/>	<input checked="" type="checkbox"/>	<input type="checkbox"/>	<input type="checkbox"/>	Details	+ -				
8	ADDRESS2	String	ADDRESS2	<input checked="" type="checkbox"/>	<input checked="" type="checkbox"/>	<input type="checkbox"/>	<input checked="" type="checkbox"/>	<input checked="" type="checkbox"/>	<input type="checkbox"/>	<input type="checkbox"/>	Details	+ -				
9	ADDRESS3	String	ADDRESS3	<input checked="" type="checkbox"/>	<input checked="" type="checkbox"/>	<input type="checkbox"/>	<input checked="" type="checkbox"/>	<input checked="" type="checkbox"/>	<input type="checkbox"/>	<input type="checkbox"/>	Details	+ -				
10	ADDRESS4	String	ADDRESS4	<input checked="" type="checkbox"/>	<input checked="" type="checkbox"/>	<input type="checkbox"/>	<input checked="" type="checkbox"/>	<input checked="" type="checkbox"/>	<input type="checkbox"/>	<input type="checkbox"/>	Details	+ -				
11	CITY	String	CITY	<input checked="" type="checkbox"/>	<input checked="" type="checkbox"/>	<input type="checkbox"/>	<input checked="" type="checkbox"/>	<input checked="" type="checkbox"/>	<input type="checkbox"/>	<input type="checkbox"/>	Details	+ -				
12	NUM1	String	NUM1	<input checked="" type="checkbox"/>	<input checked="" type="checkbox"/>	<input type="checkbox"/>	<input checked="" type="checkbox"/>	<input checked="" type="checkbox"/>	<input type="checkbox"/>	<input type="checkbox"/>	Details	+ -				
13	NUM2	String	NUM2	<input checked="" type="checkbox"/>	<input checked="" type="checkbox"/>	<input type="checkbox"/>	<input checked="" type="checkbox"/>	<input checked="" type="checkbox"/>	<input type="checkbox"/>	<input type="checkbox"/>	Details	+ -				
14	HOUSE_TYPE	String	HOUSE_TYPE	<input checked="" type="checkbox"/>	<input checked="" type="checkbox"/>	<input type="checkbox"/>	<input checked="" type="checkbox"/>	<input checked="" type="checkbox"/>	<input type="checkbox"/>	<input type="checkbox"/>	Details	+ -				
15	ADDR_FIELD1	String	ADDR_FIELD1	<input checked="" type="checkbox"/>	<input checked="" type="checkbox"/>	<input type="checkbox"/>	<input checked="" type="checkbox"/>	<input checked="" type="checkbox"/>	<input type="checkbox"/>	<input type="checkbox"/>	Details	+ -				

This example illustrates the fields and controls on the Entity Properties page (2 of 2). You can find definitions for the fields and controls later on this page.

16	ADDR_FIELD2	String	ADDR_FIELD2	<input checked="" type="checkbox"/>	<input checked="" type="checkbox"/>	<input type="checkbox"/>	<input checked="" type="checkbox"/>	<input checked="" type="checkbox"/>	<input type="checkbox"/>	<input type="checkbox"/>	Details	+	-
17	ADDR_FIELD3	String	ADDR_FIELD3	<input checked="" type="checkbox"/>	<input checked="" type="checkbox"/>	<input type="checkbox"/>	<input checked="" type="checkbox"/>	<input checked="" type="checkbox"/>	<input type="checkbox"/>	<input type="checkbox"/>	Details	+	-
18	COUNTY	String	COUNTY	<input checked="" type="checkbox"/>	<input checked="" type="checkbox"/>	<input type="checkbox"/>	<input checked="" type="checkbox"/>	<input checked="" type="checkbox"/>	<input type="checkbox"/>	<input type="checkbox"/>	Details	+	-
19	STATE	String	STATE	<input checked="" type="checkbox"/>	<input checked="" type="checkbox"/>	<input type="checkbox"/>	<input checked="" type="checkbox"/>	<input checked="" type="checkbox"/>	<input type="checkbox"/>	<input type="checkbox"/>	Details	+	-
20	POSTAL	String	POSTAL	<input checked="" type="checkbox"/>	<input checked="" type="checkbox"/>	<input type="checkbox"/>	<input checked="" type="checkbox"/>	<input checked="" type="checkbox"/>	<input type="checkbox"/>	<input type="checkbox"/>	Details	+	-
21	GEO_CODE	String	GEO_CODE	<input checked="" type="checkbox"/>	<input checked="" type="checkbox"/>	<input type="checkbox"/>	<input checked="" type="checkbox"/>	<input checked="" type="checkbox"/>	<input type="checkbox"/>	<input type="checkbox"/>	Details	+	-
22	IN_CITY_LIMIT	String	IN_CITY_LIMIT	<input checked="" type="checkbox"/>	<input checked="" type="checkbox"/>	<input type="checkbox"/>	<input checked="" type="checkbox"/>	<input checked="" type="checkbox"/>	<input type="checkbox"/>	<input type="checkbox"/>	Details	+	-
23	COUNTRY_CODE	String	COUNTRY_CODE	<input checked="" type="checkbox"/>	<input checked="" type="checkbox"/>	<input type="checkbox"/>	<input checked="" type="checkbox"/>	<input checked="" type="checkbox"/>	<input type="checkbox"/>	<input type="checkbox"/>	Details	+	-
24	PHONE	String	PHONE	<input checked="" type="checkbox"/>	<input checked="" type="checkbox"/>	<input type="checkbox"/>	<input checked="" type="checkbox"/>	<input checked="" type="checkbox"/>	<input type="checkbox"/>	<input type="checkbox"/>	Details	+	-
25	RELATIONSHIP	String	RELATIONSHIP	<input checked="" type="checkbox"/>	<input checked="" type="checkbox"/>	<input type="checkbox"/>	<input checked="" type="checkbox"/>	<input checked="" type="checkbox"/>	<input checked="" type="checkbox"/>	<input type="checkbox"/>	Details	+	-
26	SAME_PHONE_EMPL	String	SAME_PHONE_EMPL	<input checked="" type="checkbox"/>	<input checked="" type="checkbox"/>	<input type="checkbox"/>	<input checked="" type="checkbox"/>	<input checked="" type="checkbox"/>	<input checked="" type="checkbox"/>	<input type="checkbox"/>	Details	+	-
27	ADDRESS_TYPE	String	ADDRESS_TYPE	<input checked="" type="checkbox"/>	<input checked="" type="checkbox"/>	<input type="checkbox"/>	<input checked="" type="checkbox"/>	<input checked="" type="checkbox"/>	<input type="checkbox"/>	<input type="checkbox"/>	Details	+	-
28	PHONE_TYPE	String	PHONE_TYPE	<input checked="" type="checkbox"/>	<input checked="" type="checkbox"/>	<input type="checkbox"/>	<input checked="" type="checkbox"/>	<input checked="" type="checkbox"/>	<input type="checkbox"/>	<input type="checkbox"/>	Details	+	-
29	EXTENSION	String	EXTENSION	<input checked="" type="checkbox"/>	<input checked="" type="checkbox"/>	<input type="checkbox"/>	<input checked="" type="checkbox"/>	<input checked="" type="checkbox"/>	<input type="checkbox"/>	<input type="checkbox"/>	Details	+	-
30	SCC_ROW_ADD_OPRID	String	SCC_ROW_ADD_OPRID	<input checked="" type="checkbox"/>	<input type="checkbox"/>	<input type="checkbox"/>	<input type="checkbox"/>	<input type="checkbox"/>	<input type="checkbox"/>	<input type="checkbox"/>	Details	+	-
31	SCC_ROW_ADD_DTTM	Datetime	SCC_ROW_ADD_DTTM	<input checked="" type="checkbox"/>	<input type="checkbox"/>	<input type="checkbox"/>	<input type="checkbox"/>	<input type="checkbox"/>	<input type="checkbox"/>	<input type="checkbox"/>	Details	+	-
32	SCC_ROW_UPD_OPRID	String	SCC_ROW_UPD_OPRID	<input checked="" type="checkbox"/>	<input type="checkbox"/>	<input type="checkbox"/>	<input type="checkbox"/>	<input type="checkbox"/>	<input type="checkbox"/>	<input type="checkbox"/>	Details	+	-
33	SCC_ROW_UPD_DTTM	Datetime	SCC_ROW_UPD_DTTM	<input checked="" type="checkbox"/>	<input type="checkbox"/>	<input type="checkbox"/>	<input type="checkbox"/>	<input type="checkbox"/>	<input type="checkbox"/>	<input type="checkbox"/>	Details	+	-
34	SCC_ENTITY_INST_ID	String		<input type="checkbox"/>	<input type="checkbox"/>	<input type="checkbox"/>	<input type="checkbox"/>	<input checked="" type="checkbox"/>	<input type="checkbox"/>	<input type="checkbox"/>	Details	+	-

The Entity Properties page enables you to define how a property should behave when its data is encoded as XML (for instance, when the system uses the property inside web services). A property is defined as an individual value on the entity that is controlled by the Entity Registry component. Properties are generally based on the fields of the underlying records (that is, staging record if it exists and production record). However, properties can exist that are independent of the underlying records. We refer to these independent properties as transient properties. You must write custom code to save or populate the transient properties. Entities can have an unlimited number of properties.

The system uses the properties, and not the fields of the underlying records, as the source of truth to drive the functionality of the underlying entity, and to generate the entity code and the schema.

Field or Control	Description
Order	Order the properties as you want then to be displayed inside an XML message.

Field or Control	Description
<p>Property Name</p>	<p>Indicates the property name on the entity object.</p> <p>By default, the property name matches the field name. You can change a property name, unless the property is already handled by the base application class, which causes the property to be read-only.</p> <hr/> <p>Note: You cannot delete property names that match the fields in the staging record (if it exists) or in the production record.</p> <hr/> <p>Note: Inside the delivered entities, the property name SCC_ENTITY_INST_ID is listed even though it is not included inside the underlying records (we refer to these extra properties as transient properties). The primary use for this transient property is to provide a unique identifier for a particular instance of an entity. When an error occurs, this ID enables the system to link an error to a specific entity instance.</p> <hr/> <p>Warning! If you make any changes to the property name after the code has been generated, then you must either regenerate the code or manually update the property names to match the new name.</p> <hr/> <p>For information on how to use property name SCC_ENTITY_INST_ID, see “User Interface Considerations” (Recruiting and Admissions), “Error Handling.”</p> <p>See Configuring Entity Types.</p>
<p>Property Type</p>	<p>Indicates whether the property is a <i>String</i>, <i>Number</i>, <i>Date</i>, <i>Datetime</i>, or <i>Time</i>.</p> <p>If the property is based on a field, the system automatically determines the property type based on the field type. You cannot edit such a property type.</p> <hr/> <p>Note: The Property Type field is enabled only when the entity is set up with the entity type <i>Custom</i> or when you add a new property name (transient property).</p> <hr/> <p>Note: When the system triggers the Sync process, the process makes sure that the Property Type displayed for each property on this page matches the field type changes that may have occurred in the underlying records.</p> <hr/> <p>Warning! If you make any changes to the property type after the code has been generated, then you must either regenerate the code or manually update the property data types to match the new type.</p>

Field or Control	Description
Field Name	<p>Displays the name of the matching field inside the underlying records. Only the sync process can enter and maintain this value.</p> <hr/> <p>Note: A Field Name value appears only when the property is field based.</p> <hr/> <p>Note: The sync process ensures that the correct Field Name value appears.</p>
In Stage	<p>Indicates whether the Field Name is included in the stage record. Only the sync process can select or deselect this check box.</p> <hr/> <p>Note: This field appears only if you have specified a stage record on the Entity Registry page.</p> <hr/> <p>Note: The sync process verifies whether the field is still included inside the stage record. If this property changes, you will need to change the code in the get and set methods to match the changes.</p> <hr/> <p>Example code for a property that is only in stage record:</p> <pre> get PropertyName /+ Returns String +/ If %This.STAGE_MODE Then Return %This.data. PropertyName.Value; End-If; Return ""; end-get; set PropertyName /+ &NewValue as String +/ If %This.STAGE_MODE Then %This.data. PropertyName.Value = &NewValue; End-If; end-set; </pre> <hr/> <p>Warning! If you remove a field from both production and stage records, the Entity Properties page will still display the property. Properties are never removed and have to be manually deleted, to avoid changes to schema. Notice that after you manually remove the property in the code, the system enables the minus sign in the grid to allow you to delete the property.</p>

Field or Control	Description
<p>In Production</p>	<p>Indicates whether the Field Name is included in the production record. Only the sync process can select or deselect this check box.</p> <hr/> <p>Note: The sync process verifies whether the field is still included inside the production record. If this property changes, you will need to change the code in the get and set methods to match the changes.</p> <hr/> <p>Note: This field appears only if you have specified a production record on the Entity Registry page.</p> <hr/> <p>Warning! If you remove a field from both production and stage records, the Entity Properties page will still display the property the Entity Properties page. Properties are never removed and have to be manually deleted, to avoid changes to schema. Notice that after you manually remove the property in the code, the system enables the minus sign in the grid to allow you to delete the property.</p> <hr/> <p>Example code for a property that is only in production record:</p> <pre> get PropertyName /+ Returns String +/ If not %This.STAGE_MODE Then Return %This.data. PropertyName.Value; End-If; Return ""; end-get; set PropertyName /+ &NewValue as String +/ If not %This.STAGE_MODE Then %This.data. PropertyName.Value = &NewValue; End-If; end-set </pre>
<p>Attribute</p>	<p>Attributes from the Common Attribute Framework can be accessed as properties on an entity. This allows attributes to be treated more like fields on a record.</p> <p>See the “Common Attribute Framework Integration” documentation later in this section.</p>

Field or Control	Description
Viewable and Editable	<p>When you select the Viewable check box, the system adds the property to any generated outgoing XML, JSON or Rules Engine message that includes the entity (the system does this using the toXMLNode method). This outgoing message from a system can either be a request message or a response message.</p> <p>When you select the Editable check box, the system parses the property from any incoming XML, JSON or Rules Engine message that it receives (the system does this using the fromXMLNode method). If the Editable check box is not selected, the system will ignore any incoming data.</p> <hr/> <p>Note: While entities are used for services, it is not their only use. Options such as Viewable and Editable have implications outside of services (for instance, importing and exporting XML, JSON or Rules Engine data). Therefore, while request and response messages do make use of the Viewable and Editable options, these messages are not the only usage scenarios for the options.</p> <hr/> <p>Note: If you do not select either the Viewable check box or the Editable check box, the property will not appear in the schema.</p> <hr/> <p>Note: The values for transient properties are not stored, but the system can include these values inside the messages. Because at configuration time the sync process cannot tell if it should have an incoming or outgoing value or not, the Viewable and Editable options are always valid for transient properties.</p> <hr/> <p>Note: The sync process, by default, selects the Viewable and Editable check boxes for every field except for fields that the system has programmatically marked to be ignored based on the entity type (for instance SCC_ROW_ADD_OPRID, SCC_ROW_ADD_DTTM, SCC_ROW_UPD_OPRID, and SCC_ROW_UPD_DTTM). You can manually select the Viewable and Editable check boxes for these ignored fields.</p> <hr/>

Field or Control	Description
Required	<p data-bbox="865 254 1466 365">Indicates if the field is required. If the check box is selected, the system must populate the data into the field. The system will check whether the data exists for the field inside the XML or JSON messages during validation.</p> <p data-bbox="865 394 1466 537">When a property is marked as required, the system automatically selects and disables the Viewable check box. Selecting a field as required means it will be marked minOccurs 1 in the schema, that is, the field must be included in any occurrence of the XML.</p> <hr data-bbox="865 562 1466 567"/> <p data-bbox="865 575 1466 772">Note: For entities configured with an entity type that uses a stage record, the sync process, by default, selects the Required check box if the field is included in both production and stage records. If the field is only included in one of the underlying records, even if it is required in the record definition, the sync process does not mark the field as required. This is because the field may not be required in all circumstances.</p> <p data-bbox="865 779 1466 890">For entities configured with an entity type that does not use a stage record, the sync process, by default, selects the Required check box if the field is marked as required inside the production record.</p> <hr data-bbox="865 898 1466 903"/>

Field or Control	Description
LOV (List of Values)	<p>Select if you want to send the value description, with the value in the outgoing XML (the Viewable check box must be selected).</p> <p>The system enables this check box for only the fields that have list of values, that is field names defined with a prompt table or field names defined as translate fields inside the record definition in Application Designer. The system includes the description inside the outgoing XML message under a new tag labeled <code><name of the property Element (XML)_LOVDescr></code>.</p> <p>By default, this option uses the following logic to return the description:</p> <ul style="list-style-type: none"> • For <i>translate fields</i>: the value's long description is returned. • For <i>prompt fields</i>: the logic looks for the existence of the following fields in the record (respecting the order given): DESCR, DESCRSHORT, DESCR30, DESCR100. If none of these works, it uses the first non-key field marked as a list box item. <p>For example, in the Emergency Contact entity, the production record is SCC_EMERG_CNT_2. If you want to include a description in the outgoing XML message for the COUNTRY property (which is a field with a prompt table), selecting the LOV check box will result in including the following tag inside the outgoing XML message: <code><COUNTRY_LOVDescr></code>, where COUNTRY is the Element (XML) name defined for the COUNTRY property. Suppose the COUNTRY value gets populated with <i>USA</i>. The LOVDescr tag will then contain: <code><COUNTRY_LOVDescr>United States</COUNTRY_LOVDescr></code>. The value <i>United States</i> corresponds to the DESCR field found inside the prompt table (COUNTRY_TBL) defined inside the SCC_EMERG_CNT_2 record for the COUNTRY field name.</p> <p>If you do not want to use the default logic, click the Details link and set the LOV Unique ID field on the Entity Property Details page.</p> <hr/> <p>Note: The sync process enables the LOV check box only if the field is defined with a prompt table or defined as a translate field inside the record definition. The sync never selects or deselects the check box. Only you can manually select or deselect this check box.</p> <hr/> <p>Note: The default logic returns the field description from the record that is being used. Therefore, if the service operation is using the stage record, it will evaluate the record definition for the stage record. If instead the operation uses the production record, it will use the field description stored inside the record definition for the production record.</p> <hr/>
Details	Click to access the Entity Property Details page.

Field or Control	Description
Last Synced	Shows the last time this entity was synced. If the entity has not been synced since the last synced tracking was introduced, this date will not appear. Clicking the date time link will show the detail log for the sync. This log is identical to the one seen when viewing the details from the Entity Property Sync component.

Common Attribute Framework Integration

Attributes from the Common Attribute Framework are treated as entity properties. By adding the properties and syncing the entity the new attributes appear as properties.

Attribute types map to equivalent entity property types:

Attribute Type	Property Type
Short Text, Text, Long Text, Yes/No, LOV	String
Number	Number
Date	Date
Time	Time

Repeatable maps to the list entity property list attribute.

If the Attribute Type is a *list of values* the Property LOV Unique ID is set.

For each attribute record a child entity is created. It is automatically added as a child. It is maintained and should never be accessed directly. This entity will never show up in XML/JSON and will not be accessible in the rules engine.

See [Understanding Common Attribute Framework](#).

Setting Up Entity Property Details

Access the Entity Property Details page (click the **Details** link on the Entity Properties page).

This example illustrates the fields and controls on the Entity Property Details page. You can find definitions for the fields and controls later on this page.

Entity Property Details

Property Name COUNTRY

Property Type String

In Stage
 In Production
 Attribute
 List

Viewable
 Editable
 Required

Show LOV Description

Element (XML)

Default Value

Label

Description

Country

LOV Unique ID

<i>Field or Control</i>	<i>Description</i>
List	If this check box is selected, the property is treated as a list. This supports repeatable attributes. Non-field based properties can also be marked as lists, in which case they are treated as arrays in the entity application class.
Show LOV Description	This check box is the same as the LOV check box that appears on the Property Details grid of the Entity Properties page. When one is selected, the other one is also selected. They both have the same purpose.
Element (XML)	<p>Indicates the label for the XML tag name used for this property. This is the tag that the system uses in the XML schema of the incoming and outgoing XML messages.</p> <hr/> <p>Warning! If you change this value, you must select an Action of <i>Generate XSD</i> on the Entity Registry page to regenerate the schema and paste it inside the Integration Broker message schema.</p> <hr/> <p>Note: The sync process, by default, sets this value to match the Field Name.</p> <hr/>

Field or Control	Description
Default	<p>Define the default value. There are three types of defaults:</p> <ul style="list-style-type: none"> • <i>Record</i>: Uses the default value defined in the record definition in Application Designer for the underlying production record. This is the selected choice by default. • <i>Custom</i>: If you select <i>Custom</i>, the Value field appears. Use the Value field prompt to select a default value that will be included inside the outgoing XML. • <i>Skip</i>: Skips the property at the time of populating default values. <hr/> <p>Note: The sync process always sets this value to <i>Record</i>.</p>
Label	<p>Indicates the label for the property as shown in the comments for the XML schema. This is primarily a descriptive attribute.</p> <hr/> <p>Note: If you want to see the new label in the schema, regenerate the schema.</p> <hr/> <p>Note: The sync process sets this value with the default label defined in the field properties of the production record.</p>
Description	<p>Indicates the description for the property as shown in the comments for the XML schema. This is primarily a descriptive attribute.</p> <hr/> <p>Note: If you want to see the new description in the schema, regenerate the schema.</p> <hr/> <p>Note: The sync process sets this value with the description defined for the field definition in Application Designer.</p>
LOV Unique ID	<p>This field allows you to select a specific LOV prompt definition for the entity property to use.</p>

Creating Entity Views

Entity views allow the creation of subsets of entity meta-data. Entity views can only reduce access from what is specified at the base entity. So if a property is set to Viewable but not Editable, you cannot set it to Editable from a view, but Viewable can be turned on or off.

Access the Entity Registry Views page (select *Edit Entity View* in the **Action** field on the Entity Registry page).

This example illustrates the fields and controls on the Entity Registry Views page. You can find definitions for the fields and controls later on this page.

Entity Registry Views

Entity Name **Emergency Contact**
 Changes to properties and children will not be reflected in Entity Views until a save is performed.

Personalize Find [?] [grid icon]				
Entity View Name		Default	Edit	
Complete		<input checked="" type="checkbox"/>	Edit	+ -

Navigation: First 1 of 1 Last

Every entity has a “Complete” view. The complete view always matches what has been set on the entity property and children. This view cannot be edited and is maintained during the sync process. A single view, per entity, is always marked default. The default view is used if no profile is selected, or if that entity does not belong to the current profile. Default also specifies the view assigned when a new entity is added to a profile. The default is used by all entity based services built prior to profiles existing, such as EWS and AAWS.

See [Setting Up Entity Profiles](#).

The sync process maintains the entity view matching the entity properties and children. No data is currently logged for entity view syncs.

To create a new entity view, add a row on the Entity Registry Views page. You are taken to the Entity Registry View Details (SCC_ENT_VW2) page:

This example illustrates the fields and controls on the Entity Registry View Details page (1 of 2). You can find definitions for the fields and controls later on this page.

Entity View ID SCC_EVIEW_20130603212441

Entity Name Emergency Contact

*Entity View Name

Entity Description 

Default new items to disabled

Entity Properties			
Property Name	Viewable	Editable	LOV
SCC_TEMP_ID	<input checked="" type="checkbox"/>	<input checked="" type="checkbox"/>	<input type="checkbox"/>
EMPLID	<input checked="" type="checkbox"/>	<input checked="" type="checkbox"/>	<input type="checkbox"/>
CONTACT_NAME	<input checked="" type="checkbox"/>	<input checked="" type="checkbox"/>	<input type="checkbox"/>
SAME_ADDRESS_EMPL	<input checked="" type="checkbox"/>	<input checked="" type="checkbox"/>	<input type="checkbox"/>
PRIMARY_CONTACT	<input checked="" type="checkbox"/>	<input checked="" type="checkbox"/>	<input type="checkbox"/>
COUNTRY	<input checked="" type="checkbox"/>	<input checked="" type="checkbox"/>	<input type="checkbox"/>
ADDRESS1	<input checked="" type="checkbox"/>	<input checked="" type="checkbox"/>	<input type="checkbox"/>
ADDRESS2	<input checked="" type="checkbox"/>	<input checked="" type="checkbox"/>	<input type="checkbox"/>
ADDRESS3	<input checked="" type="checkbox"/>	<input checked="" type="checkbox"/>	<input type="checkbox"/>
ADDRESS4	<input checked="" type="checkbox"/>	<input checked="" type="checkbox"/>	<input type="checkbox"/>
CITY	<input checked="" type="checkbox"/>	<input checked="" type="checkbox"/>	<input type="checkbox"/>
NUM1	<input checked="" type="checkbox"/>	<input checked="" type="checkbox"/>	<input type="checkbox"/>
NUM2	<input checked="" type="checkbox"/>	<input checked="" type="checkbox"/>	<input type="checkbox"/>
HOUSE_TYPE	<input checked="" type="checkbox"/>	<input checked="" type="checkbox"/>	<input type="checkbox"/>
ADDR_FIELD1	<input checked="" type="checkbox"/>	<input checked="" type="checkbox"/>	<input type="checkbox"/>
ADDR_FIELD2	<input checked="" type="checkbox"/>	<input checked="" type="checkbox"/>	<input type="checkbox"/>
ADDR_FIELD3	<input checked="" type="checkbox"/>	<input checked="" type="checkbox"/>	<input type="checkbox"/>
COUNTY	<input checked="" type="checkbox"/>	<input checked="" type="checkbox"/>	<input type="checkbox"/>
STATE	<input checked="" type="checkbox"/>	<input checked="" type="checkbox"/>	<input type="checkbox"/>
POSTAL	<input checked="" type="checkbox"/>	<input checked="" type="checkbox"/>	<input type="checkbox"/>

This example illustrates the fields and controls on the Entity Registry View Details page (2 of 2). You can find definitions for the fields and controls later on this page.

GEO_CODE	<input checked="" type="checkbox"/>	<input checked="" type="checkbox"/>	<input type="checkbox"/>
IN_CITY_LIMIT	<input checked="" type="checkbox"/>	<input checked="" type="checkbox"/>	<input type="checkbox"/>
COUNTRY_CODE	<input checked="" type="checkbox"/>	<input checked="" type="checkbox"/>	<input type="checkbox"/>
PHONE	<input checked="" type="checkbox"/>	<input checked="" type="checkbox"/>	<input type="checkbox"/>
RELATIONSHIP	<input checked="" type="checkbox"/>	<input checked="" type="checkbox"/>	<input type="checkbox"/>
SAME_PHONE_EMPL	<input checked="" type="checkbox"/>	<input checked="" type="checkbox"/>	<input type="checkbox"/>
ADDRESS_TYPE	<input checked="" type="checkbox"/>	<input checked="" type="checkbox"/>	<input type="checkbox"/>
PHONE_TYPE	<input checked="" type="checkbox"/>	<input checked="" type="checkbox"/>	<input type="checkbox"/>
EXTENSION	<input checked="" type="checkbox"/>	<input checked="" type="checkbox"/>	<input type="checkbox"/>
SCC_ENTITY_INST_ID	<input type="checkbox"/>	<input checked="" type="checkbox"/>	<input type="checkbox"/>

Entity Children		
Entity Name		Hide
1 Emergency Phone		<input type="checkbox"/>

Entity Properties

<i>Field or Control</i>	<i>Description</i>
Viewable and Editable	You can select or deselect these check boxes on a per property/view basis.
LOV	You can select or deselect this check box on a per property/view basis, but only if the LOV check box is available and selected for the property.

Entity Children

<i>Field or Control</i>	<i>Description</i>
Hide	<p>Select this check box to hide entity children. The entities that are a direct child of the current entity (and any children of those entities) will not be shown.</p> <hr/> <p>Note: Selecting this check box just hides the entity child; it does not prevent that child from being filled as part of the initial fill process. This avoids certain complications in the rules engine.</p> <hr/>

Generating the Entity Schema

Access the Entity Schema page (select *Generate XSD* in the **Action** field on the Entity Registry page).

This example illustrates the fields and controls on the Entity Schema page. You can find definitions for the fields and controls later on this page.

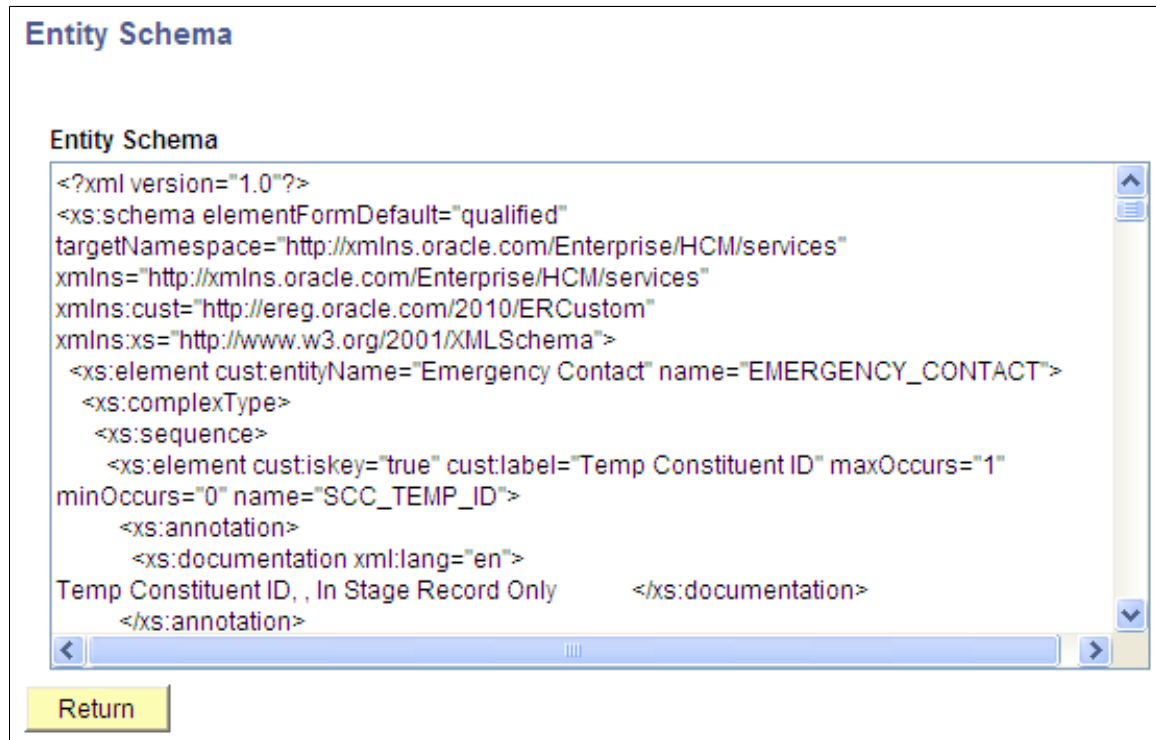

The system generates the schema based on the property settings. If the following settings are changed on the Entity Properties and Entity Property Details pages, you must regenerate the schema:

- Element (XML)
- Show LOV Description and LOV check box
- In Stage
- In Production
- Required
- List

Any changes made to the following property settings do not require regenerating the schema as their function is primarily descriptive:

- Label
- Description

You can paste the generated schema to the appropriate message name inside the Schema page (**PeopleTools > Integration Broker > Integration Setup > Messages > Schema**).

For information on schemas, see *PeopleTools: Integration Broker*.

Generating the Entity Code

Access the Entity Code Generation page (select *Generate Code* in the **Action** field on the Entity Registry page).

Note: This should only be done for entities where the application class is specified. Entities using the default application class approach have no need to do this.

This example illustrates the fields and controls on the Entity Code Generation page. You can find definitions for the fields and controls later on this page.

Entity Code Generation

<input checked="" type="checkbox"/>	Custom Presave Code
<input type="checkbox"/>	Custom Validation Code
<input type="checkbox"/>	Custom Set Default Code
<input type="checkbox"/>	Extend Fill

Appclass Code

```
import SCC_COMMON:ENTITY:StagedHREntity;
import SCC_COMMON:ENTITY:IEntity;
import SCC_COMMON:ENTITY:LOG:MessageLogBase;

class EmergencyContact extends SCC_COMMON:ENTITY:StagedHREntity
method EmergencyContact(&p_parent As IEntity);
method Presave();
method PresaveFirst();
method generateRowset() Returns Rowset;

**
```

The system generates the code based on the property settings. If the following settings are changed on the Entity Properties and Entity Property Details pages, you must regenerate the code:

- Property Name
- Property Type
- In Stage
- In Production
- Attribute
- List

The four options that the grid displays are dynamic, based on the entity type and are coded in the Code Generation Appclass. Therefore, while these options are available in most of the delivered entity types, they are not static.

Field or Control	Description
Custom Presave Code	<p>Select to add the methods <i>preSave</i> and <i>preSaveFirst</i> to the generated code. These methods are called as part of the preSave process.</p> <ul style="list-style-type: none"> • <i>preSave</i>: This is called prior to the save process to do any final data processing. • <i>preSaveFirst</i>: This is called once per childEntity before preSave. This is useful if you have code that needs to be run across all child entities of a particular type, or you need to remove entities prior to saving.
Custom Validation Code	<p>Select to add the methods <i>Validate</i> and <i>validateFirst</i> to the generated code.</p> <ul style="list-style-type: none"> • <i>Validate</i>: Runs as part of the validation process for this entity. Generally, this method should call <i>commonValidate</i>, which is responsible for field level validations. Any custom validation can also be added. • <i>validateFirst</i>: This is called once per childEntity, before any other validation. This method is good for running validations that may need to compare entities against each other that you do not need to run during the validation for every entity.
Custom Set Default Code	<p>Select to add an override for <i>setDefault</i>. Normally, <i>setDefault</i> is based on the field defaults specified on the record. It is recommended to first call <i>%Super.setDefault()</i> to set the default field values and then set any special overrides.</p>
Extend Fill	<p>Select to override the method called <i>Fill</i>. The system runs this method when it takes data from a record and populates this data into an entity. You may need to override this method to modify data after retrieval from the database or to populate transient values.</p>

Field or Control	Description
Generate Code	<p>Click to generate the code template that can later be pasted directly inside the Application Class that you have specified on the Entity Registry page. Use Application Designer to paste the generated code.</p> <p>To generate the code, the system uses the staging record (if it exists) and the production record, the entity type, the entity property settings, and the selected code generation options.</p> <p>When you click the button, the sample code template is displayed inside the Appclass Code box.</p> <hr/> <p>Note: Clicking this button is useful at the time of creating a new entity or if a change is made to an existing entity. For example, you could generate code when production or stage records are modified, or when properties are changed.</p>

Viewing the Entity Hierarchy

To view the children hierarchy for an entity, select the View Hierarchy action on the Entity Registry page. Here is an example of an entity hierarchy:

This example illustrates the fields and controls on the Entity Hierarchy example. You can find definitions for the fields and controls later on this page.

Display Options

Functional View
 Developer View
 Hide Tooltips

Property Icons

Read
 Write
 List
 LOV

Constituent

+ Properties (8)

- Children (52)

Names

- Properties (31)

Temp Constituent ID (Number) ▶◀

Empl ID (String) ▶◀

Type of Name (String) ▶◀

Format Using (String) ▶◀

Effective Date (Date) ▶◀

Name (String) ▶◀

Status as of Effective Date (String) ▶◀

The hierarchy is dynamically drawn using HTML5 SVG. You can download the SVG, but only in Chrome and Firefox (not in Internet Explorer). IE8 does not support HTML5, so it shows an alternative list view. All other browsers can also view this using the View List link:

This example illustrates the fields and controls on the Entity Hierarchy example list view. You can find definitions for the fields and controls later on this page.

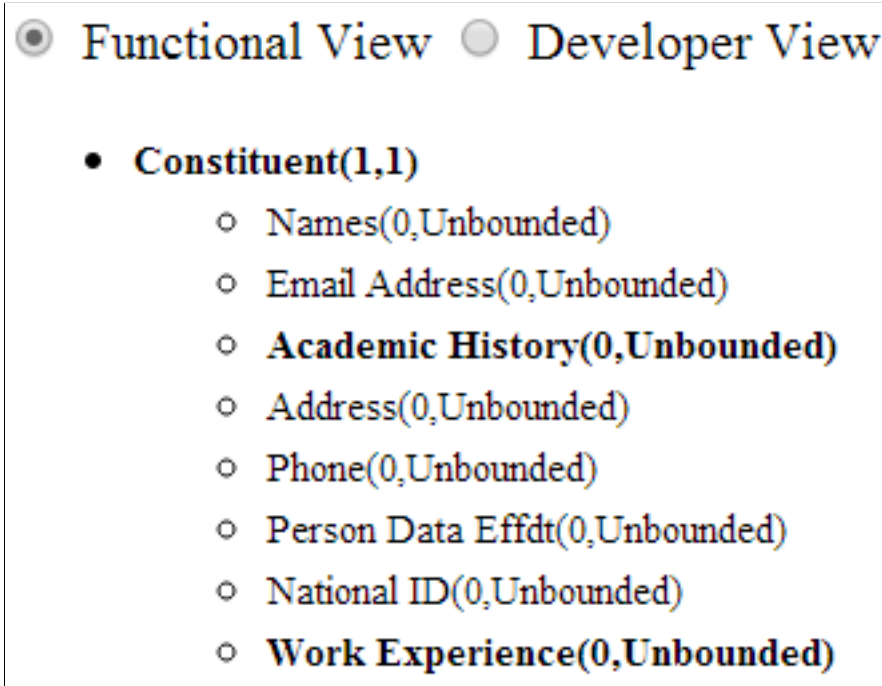

Display Options

<i>Field or Control</i>	<i>Description</i>
Functional View	A view targeted at functional users. Shows entity names and property labels.
Technical View	Targeted at developers. Adds Entity ID. Shows hidden properties and children (hidden children are transparent).
Hide Tooltips	Allow or disallow tooltips. Tooltips appear over every entity name, property name, child link and property link to give extra details. Only available in SVG mode.

SVG View

Click on properties(x) or children(x) to expand details.

List View

You can click on entities that appear in bold and these entities have children.

Whether child entities appear as expanded or collapsed is retained when switching back and forth between SVG and List View.

Setting Up Entity Profiles

Entity Profiles allow entities and views to be combined to create groupings of entities and views.

This section discusses how to configure entity profiles.

Page Used to Set Up Entity Profiles

<i>Page Name</i>	<i>Definition Name</i>	<i>Navigation</i>	<i>Usage</i>
Entity Profile	SCC_ENTITY_PREFL	Set Up SACR > System Administration > Entity > Entity Profile	Combine entities and views to create groupings of entities and views.

Configuring Entity Profiles

Access the Entity Profile page (**Set Up SACR > System Administration > Entity > Entity Profile**).

This example illustrates the fields and controls on the Entity Profile page (1 of 2). You can find definitions for the fields and controls later on this page.

Entity Profile ID: SCC_EPRFL_20121206025640

Entity Profile Name:

Profile Description

***Profile Type**

Parent Profile

Personalize Find First 1-44 of 44 Last					
Entity Name	*Entity View	View	Hierarchy		
Address	Mobile	View	Hierarchy	+	-
ClassComponent	Mobile	View	Hierarchy	+	-
ClassSearchResult	Mobile	View	Hierarchy	+	-
ClassSearchSubject	Mobile	View	Hierarchy	+	-
ClassSearchSummary	Mobile	View	Hierarchy	+	-
ClassSection	Mobile	View	Hierarchy	+	-
ClassSectionCombined	Mobile	View	Hierarchy	+	-
ClassSectionComponent	Mobile	View	Hierarchy	+	-
ClassSectionEnrllInfo	Mobile	View	Hierarchy	+	-
ClassSectionInstructor	Mobile	View	Hierarchy	+	-
ClassSectionMeetingPattern	Mobile	View	Hierarchy	+	-
ClassSectionOptions	Mobile	View	Hierarchy	+	-
ClassSectionResult	Mobile	View	Hierarchy	+	-
ClassSectionTextbook	Mobile	View	Hierarchy	+	-
ClassSectionTextbookDetails	Mobile	View	Hierarchy	+	-
CourseAttributesDetail	Mobile	View	Hierarchy	+	-
CourseOfferingDerived	Mobile	View	Hierarchy	+	-
CourseOfferingDetail	Mobile	View	Hierarchy	+	-
CourseOfferingDetailResult	Mobile	View	Hierarchy	+	-
CourseOfferingTerm	Mobile	View	Hierarchy	+	-
CourseShoppingCart	Mobile	View	Hierarchy	+	-
Email Address	Mobile	View	Hierarchy	+	-

This example illustrates the fields and controls on the Entity Profile page (2 of 2). You can find definitions for the fields and controls later on this page.

EnrollmentClassSection	Mobile	View	Hierarchy	+	-
EnrollmentDetail	Mobile	View	Hierarchy	+	-
EnrollmentRequestDefault	Mobile	View	Hierarchy	+	-
EnrollmentTerm	Mobile	View	Hierarchy	+	-
PersonCheckListItemSS	Mobile	View	Hierarchy	+	-
PersonDirectoryEntry	Mobile	View	Hierarchy	+	-
Phone	Mobile	View	Hierarchy	+	-
SCC_LOOKUP_DIR_RESP	Mobile	View	Hierarchy	+	-
SFA_GET_STUDENT_AWARDS_RESP	Mobile	View	Hierarchy	+	-
SSF_GET_STUDENT_ACCT_RESP	Mobile	View	Hierarchy	+	-
ServiceIndicatorSS	Mobile	View	Hierarchy	+	-
StudentAccountItemDetail	Mobile	View	Hierarchy	+	-
StudentAccountItemSummary	Mobile	View	Hierarchy	+	-
StudentAccountSummary	Mobile	View	Hierarchy	+	-
StudentAccountView	Mobile	View	Hierarchy	+	-
StudentAwardDetail	Mobile	View	Hierarchy	+	-
StudentAwardDisbursement	Mobile	View	Hierarchy	+	-
StudentAwardLOV	Mobile	View	Hierarchy	+	-
StudentAwardLOVValue	Mobile	View	Hierarchy	+	-
StudentAwardSummary	Mobile	View	Hierarchy	+	-
StudentAwardTerm	Mobile	View	Hierarchy	+	-
StudyList	Mobile	View	Hierarchy	+	-

Entity Profile

Field or Control	Description
Entity Profile ID	Auto-generated unique ID for the profile.
Entity Profile Name and Entity Profile Description	Enter a name and description for the profile.

Field or Control	Description
Profile Type	<ul style="list-style-type: none"> • <i>Category</i>: This type will be used to make it easier to search for entities. For category there is no entity view, since it is not used to specify display. • <i>Data Set Category</i>: This profile type is similar to <i>Category</i>, but is restricted to entities of the type “Rules Engine Data Set”. Data set categories are created here but entities can be added in the Define Data Sets component of the Rules Engine setup. See Understanding the Rules Engine. • <i>Rules Engine</i>: This profile type allows you to restrict what properties and entity children are available based on the entity view. The available base entities for a rule category are also set here. Any entity that is not specified as a base entity is not selectable as such when generating a rule in a rule category tied to this entity profile. Any entity that is not specified here is still accessible from the Rules Engine, using the default profile, if it is accessible from the entity tree. • <i>Web Service</i> entity profiles are designed for use with Web Services. They allow simple restriction of each entity to a particular view. Any entity not specified here can still be accessed using its default profile. To remove an entity, remove it from the list of children on the parent view.
Parent Profile	<p>Each profile may have a parent. A child inherits entities, and their settings, from the parent profile.</p> <p>Only one level of inheritance is allowed, so a profile can be a parent or a child, but not both. This avoids the potential for confusion and maintenance difficulty.</p> <p>Additional entities may be added on children, and entity settings may be overridden.</p>
Entity Name	Select the name of the entity to be associated with this profile, from the list of entities defined in the registry.
Entity View	Select the entity view to be used for this entity in the context of this profile.
View	Click this link to see details of access based on the entity view.
Hierarchy	Click this link to see the complete hierarchy, starting from the specified entity, based on the current profile.

At the end of the page, if you select *Entity Profile*, this allows the addition of all entities from another profile. Because this is a one time copy it can be done as often as you want.

If you select *Entity Tree*, you can add entities based on a parent entity being specified, tracing down the entire tree and adding data. This is a one time add, so it does not do maintenance.

Synchronizing Entity Properties

This section discusses how to run the Entity Property Sync process.

Page Used to Synchronize Entity Properties

<i>Page Name</i>	<i>Definition Name</i>	<i>Navigation</i>	<i>Usage</i>
Entity Property Sync	SCC_ENTITY_SYNC	Set Up SACR > System Administration > Entity > Entity Property Sync	Simultaneously synchronize all the entities configured on the Entity Registry page.

Running the Entity Property Sync Process

Access the Entity Property Sync page (**Set Up SACR > System Administration > Entity > Entity Property Sync**).

This example illustrates the fields and controls on the Entity Property Sync page (1 of 2). You can find definitions for the fields and controls later on this page.

Entity Property Sync

Press the "Sync All Entity Properties" to make sure all the properties on every entity get updated to properly reflect the record objects. The updates you manually have made to the properties will not be reset by this process.

Sync Log		
Entity Name	Last Synced	Log
Test Score	10/05/13 11:02:52AM	Log
Constituent	20/05/13 11:57:50PM	Log
Prospect Recruiting Category	09/05/13 4:32:37PM	Log
Prospect Career	10/05/13 10:54:00AM	Log
Disability	09/05/13 4:12:11PM	Log
Academic Program (NLD)	21/05/13 11:22:11PM	Log
Student Prior Education (NLD)	09/05/13 4:11:45PM	Log
Student Nationalities (NLD)	09/05/13 4:12:02PM	Log
Higher Ed Student Data (NLD)	09/05/13 4:12:04PM	Log
ClassSearchRequest	29/05/13 2:49:39PM	Log
ClassSectionMeetingPattern	14/05/13 11:45:47PM	Log
CourseOfferingDetail	21/05/13 11:33:54PM	Log
StudyListDeadLines	09/05/13 4:11:10PM	Log
Research Supervisor	09/05/13 4:11:58PM	Log
SCC_ST_ClassSearchRequest	09/05/13 4:11:16PM	Log
EnrollmentDetail	21/05/13 9:27:28AM	Log
APT Attempt	09/05/13 4:11:20PM	Log
Rule Statement	09/05/13 4:11:36PM	Log
ACR Main	22/05/13 4:16:21PM	Log

This example illustrates the fields and controls on the Entity Property Sync page (2 of 2). You can find definitions for the fields and controls later on this page.

ACR Attendance Inclusion	09/05/13 4:11:29PM	Log
DA Proxy	09/05/13 4:11:26PM	Log
DA Proxy Transactions	09/05/13 4:11:26PM	Log
ACM Attendance Inclusion	09/05/13 4:11:32PM	Log
ACM Main	09/05/13 4:11:33PM	Log
Course Group Header	09/05/13 4:11:21PM	Log
IAM Main	22/05/13 4:14:53PM	Log
IAM Result	22/05/13 4:11:44PM	Log
APT Header Attribute	09/05/13 4:12:21PM	Log
Entity View Property	09/05/13 4:11:37PM	Log
AIR Rule	09/05/13 4:11:40PM	Log
ACM Dates	21/05/13 11:21:47PM	Log
IAM Dates	22/05/13 4:06:32PM	Log
Test Date	09/05/13 12:31:56PM	Log
Test CAF	09/05/13 12:32:56PM	Log
Prospect CAF	09/05/13 12:31:03PM	Log
Test ID Graduate Record Exam1	10/05/13 1:55:00PM	Log
Test ID International English	10/05/13 1:56:50PM	Log
Test ID Pearson Test of Englis	10/05/13 2:01:59PM	Log
Test ID ACT Assessment	21/05/13 11:21:51PM	Log
Prospect/Admissions Data Load	23/05/13 11:14:38AM	Log

Entity Sync Status	Complete	Sync All Entity Properties
Entity Sync Datetime	22/05/13 4:47:31AM	Wipe Entity Cache

Field or Control	Description
<p>Sync All Entity Properties and Wipe Entity Cache</p>	<p>Click the Sync All Entity Properties button to start a Process Scheduler that performs the sync. The Sync All Entity Properties button is then replaced with a Refresh button so that you can check the status until the process is complete.</p> <p>Running this process ensures that all the properties on every entity get updated to properly reflect the underlying record objects (stage record when it exists and production record). It does not reset the properties for which you may have manually changed the default setup.</p> <p>The sync process keeps all the entity data up to date. The sync process:</p> <ul style="list-style-type: none"> • Updates properties to match underlying records. • Keeps entity views up to date with changes to entity properties and children. • Keeps entity properties/children synced with the Common Attribute Framework. <p>After the sync process is complete, click the Wipe Entity Cache button. The cache wipe process wipes the entity registry cache on the appserver. You should perform a cache wipe each time that you run the sync process – after the process has completed successfully. This cache uses rowset caches to store entity registry meta-data. This avoids unnecessary trips to the databases, bringing significant increases to performance for all entity registry operations.</p> <p>You should run a sync and wipe in these events:</p> <ul style="list-style-type: none"> • Setting up a new database. This will make sure all your properties match the fields, and all your views match their underlying entity. • Importing data via dat/dms. Since dat/dms bypasses all processing logic, this fills in any holes. • If changes are made to records that have entities built on top of them via appdesigner. The sync process is the only way to update the entities to match the records. This can also be done on the entity registry component in a one-off manner. <hr/> <p>Note: At the time of delivering this documentation, a similar overall process does not exist to “reset” all properties at once.</p>
<p>Entity Sync Status</p>	<p>Indicates whether the sync process is Requested, In progress or Complete. For further details on the status of the sync process look at the PeopleTools Process Monitor.</p>

Sync Log

The full sync log grid is always shown on this page, showing all the entities that have been synced. If the sync was performed from the entity, as opposed to the Entity Property Sync page, the changes are also reflected here.

The grid also displays a Log link that enables you to view details of what was changed. Click the Log link to access the Sync Log page that provides a description of the fields that were added, removed, or changed:

This example illustrates the fields and controls on the Sync Log page. You can find definitions for the fields and controls later on this page.

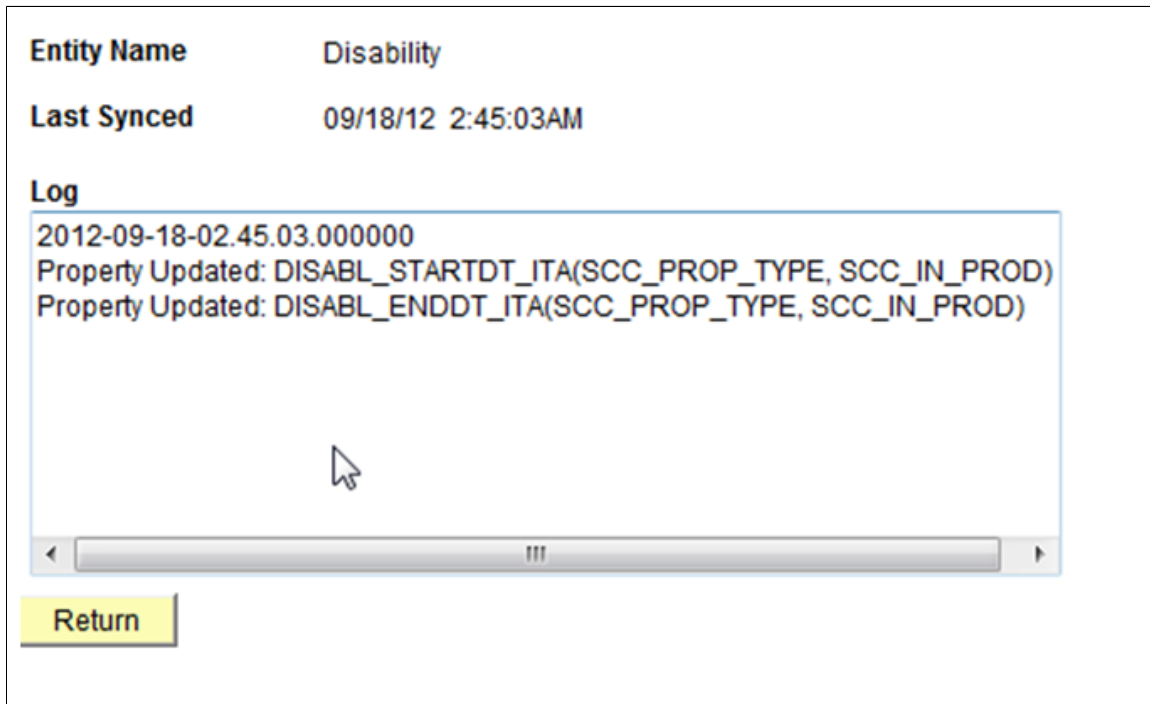

The log grows over time, showing timestamped sections specifying the changes made.

Executing Unit Tests for Entities

This section discusses how to:

- Create an entity unit test.
- Run entity unit test cases.

Pages Used to Execute Unit Tests for Entities

Page Name	Definition Name	Navigation	Usage
Entity Unit Tests (Setup)	SCC_ENTITY_UT	Select <i>Unit Test</i> in the Action field on the Entity Registry page.	Attach the unit test application classes to an entity and run the unit tests.
Entity Unit Tester	SCC_ENT_MASS_UT	Set Up SACR > System Administration > Entity > Entity Unit Tester	Run all the unit tests associated with a specified entity. Unit tests are defined on the Entity Unit Tests (Setup) page.
Entity Unit Tests	SCC_ENTITY_UT	Click the View Unit Tests link on the Entity Unit Tester page.	View the unit tests tied to an entity name, the application class used and the latest run status for a specific unit test.

Creating an Entity Unit Test

Unit tests are small focused tests that academic institutions can use to ensure that each unit of code in an entity works properly. This is done to find errors in the smallest segments of code during development and allow them to be fixed early, resulting in higher quality code.

Because the Entity Registry component is highly extensible, the system integrates unit testing with the Entity Registry, by delivering a unit test framework.

Coding a Unit Test

Each unit test must extend the class `TestBase`.

There are three methods that the unit test can override in `TestBase`:

1. `Setup()`: Is the first method that your unit test must call. This method should be used to set up the environment for the test. If environment setup is not required, the unit test does not have to implement this method.
2. `Run()`: Is the main testing method. A unit test must run all the code relevant to executing the test in this method. If the test fails, the property status should equal the property `FAILED`. If the test runs successfully, the property status should be set to `PASSED`. This method must be overridden.
3. `Teardown()`: Is the method that does the cleanup. In theory, this method should reset all the data, as if the test had never been run, therefore, if required the test can be run again successfully. This method is optional, depending on your testing requirements.

The full class reference for `TestBase` is presented in the `SCC_COMMON:Testing:TestBase` application class. This application class is described later in this section.

The following code shows an example where a unit test retrieves a constituent that is based on `TestBase`:

```
import SCC_COMMON:Testing:*;
import SCC_COMMON:ENTITY:IEntity;
```



```

import SCC_SL_TRANSACTION:INTFC:Constituent;
class GetConstituent extends SCC_COMMON:Testing:TestBase
method GetConstituent();
method setup();
method teardown();
method run();
end-class;

method GetConstituent
%Super = create SCC_COMMON:Testing:TestBase("GetConstituent");
end-method;
method run
/+ Extends/implements SCC_COMMON:Testing:TestBase.Run +/
Local SCC_SL_TRANSACTION:INTFC:Constituent &constituent = create
SCC_SL_TRANSACTION:INTFC:Constituent( Null);
/*Retrieves the constituent*/
&constituent.setStageMode( True);
&constituent.EMPLID = "KU0004";
&constituent.fromProduction();

/*Prints in the message area the complete constituent xml
for the constituent received*/
Local XmlDoc &responseDoc = CreateXmlDoc("");
Local XmlNode &rootNode =
&responseDoc.CreateDocumentElement("CONSTITUENT");
&constituent.toXmlNode(&rootNode);
%This.Msg(&responseDoc.GenFormattedXmlString());
end-method;

method setup
/+ Extends/implements SCC_COMMON:Testing:TestBase.Setup +/
end-method;

method teardown
/+ Extends/implements SCC_COMMON:Testing:TestBase.TearDown +/
end-method;

```

Attaching a Unit Test

You attach a unit test to a specific entity. To attach a unit test to an entity:

1. Navigate to the Entity Registry page for the entity to which you want to attach a unit test (Set Up SACR, System Administration, Entity, Entity Registry). Continuing with the previous code example, the following shows that the Constituent entity is selected.

This example illustrates the fields and controls on the Example of the Entity Registry page for the Constituent entity. You can find definitions for the fields and controls later on this page.

Entity Registry

Entity Configuration

Entity ID: SCC_ENTITY_20090521054417

Name:

Status: ▼

Entity Type: ▼

Description:

*AppClass: 🔍

Prod Record: 🔍

Stage Record: 🔍

Element (XML):

Apply Data Update Rule

Action:

Children

Personalize | Find |
First 1-51 of 51 Last

Order	*Entity Name	Status	Embed	*Min	*Max	Element Wrapper (XML)	View		
1	<input type="text" value="Names"/> 🔍	Active	<input type="checkbox"/>	0	0	PER_NAMES	View	+	-
2	<input type="text" value="Email Address"/> 🔍	Active	<input type="checkbox"/>	0	0	EMAIL_ADDRESSES	View	+	-
3	<input type="text" value="Academic History"/> 🔍	Active	<input type="checkbox"/>	0	0	ACADEMIC_HISTORIES	View	+	-
4	<input type="text" value="Address"/> 🔍	Active	<input type="checkbox"/>	0	0	ADDRESSES	View	+	-
5	<input type="text" value="Phone"/> 🔍	Active	<input type="checkbox"/>	0	0	PHONES	View	+	-

2. Select *Unit Test* in the Action field to access the Entity Unit Tests (setup) page.

This example illustrates the fields and controls on the Entity Unit Tests (setup) page (for the Constituent entity). You can find definitions for the fields and controls later on this page.

Field or Control	Description
Active	Select to allow the system to run the unit test. If you clear this check box, the system ignores the unit test.
Type	Select a categorical classification of the unit test, this is mostly for description.
Application Class	Select the class that you have created for the unit test. In the previous exhibit example — Entity Unit Tests (setup) page for the Constituent entity — the MessageGenerator class is selected for the Constituent entity.
Run Unit Tests	Click to run the unit test. You can add any number of unit tests on this page and click this button once to run all the tests simultaneously.
OK	Click to save this unit test setup.

The other fields on this page are similar to the Entity Unit Tests (view-only) page that is described in the next section “Running Entity Unit Test Cases”.

class SCC_COMMON:Testing:TestBase

This is the base class which developers must extend in order to code their tests. The methods to be overridden are Setup(), Run(), and Teardown(). The system always calls these methods in that order for each test class. In the final phase of code execution, the system attempts to call Teardown(), even when there are errors.

In addition, the system delivers helper methods for asserting various invariant conditions. The syntax is: *Assert (&condition_which_must_be_true, "The expected condition was not met!");* In other words, the

first argument to `Assert()` is a condition which you expect to be true. The second argument is an error message to display if the condition is not met. The other `Assert*()` methods are more of syntactic sugar.

Summary:

- *Property Summary:*
 - public string FAILED
 - public string NOT_RUN
 - public string PASSED
 - public string status
 - public string UnitTestName

- *Constructor Summary:*

Method Modifier and Return Type	Method Name and Parameters	Method Description
public void	TestBase(string UnitTestName_in)	This is the constructor. Developers should pass in a test name as the sole argument. For now, the system does not use this value.

- *Method Summary:*

Method Modifier and Return Type	Method Name and Parameters	Method Description
public void	Assert (boolean isTrue, string onFail)	The first argument must be a Boolean expression, which should evaluate to true. If false, the system throws an exception to indicate that the test failed. The system catches the exception, marks the test as having failed, and continues on to the next test.
public void	AssertNumbersDiffer(number num1, number num2, string onFail)	NA
public void	AssertNumbersEqual(number num1, number num2, string onFail)	NA
public void	AssertStringsDiffer(string str1, string str2, string onFail)	NA

Method Modifier and Return Type	Method Name and Parameters	Method Description
public void	AssertStringsEqual(string str1, string str2, string onFail)	NA
public void	Msg(string msg)	NA
public void	Run()	<p>This method must be overridden to implement the actual test that developers want to write.</p> <hr/> <p>Warning! If you do not override this method, the system throws an error.</p> <hr/>
public void	Setup()	The first method of the test class to be called during a run.
public void	Teardown()	<p>The last method of the test class to be called during a run. The framework tries to call this method even after an error. Due to inconsistent exception handling by the PeopleCode runtime, a PeopleCode "catch" statement does not catch all exceptions, and so the system cannot guarantee this method will be run after an error.</p> <p>Examples of untrappable errors include calls to the Error() builtin, SQL errors, and PeopleCode compile errors.</p>

Running Entity Unit Test Cases

Access the Entity Unit Tester page (**Set Up SACR > System Administration > Entity > Entity Unit Tester**).

This example illustrates the fields and controls on the Entity Unit Tester page. You can find definitions for the fields and controls later on this page.

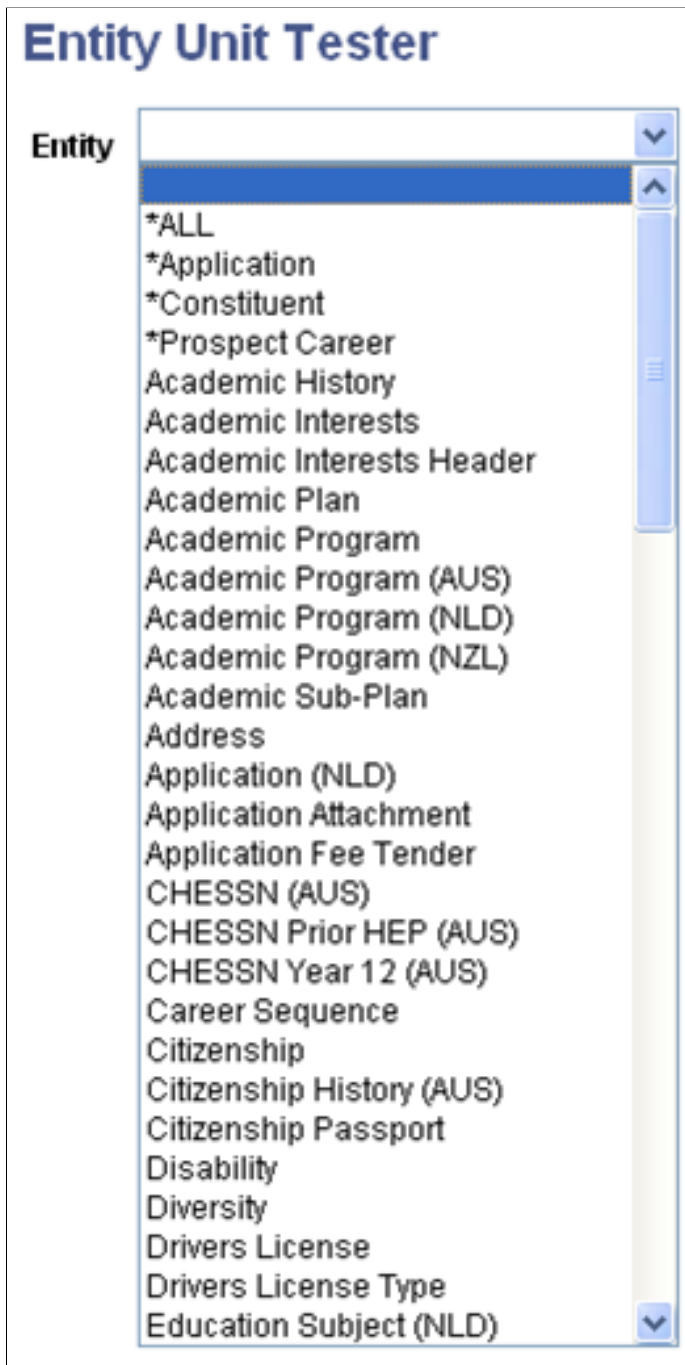

This component is purely for running unit tests that you associate with entities on the Entity Unit Tests (setup) page. The unit tests themselves are based on the Campus Solutions delivered unit test framework.

First, select an entity. This loads the unit tests specified in the Entity Registry for that entity and all child entities in the grid below it. Except for the entity called 'All', the prompt dynamically marks with an * the entities that have no parent entity. Those can be considered top level entities. ALL is a special case as it runs unit tests for all entities in the registry.

This example illustrates the fields and controls on the Example of the Entity Unit Tester page for a selected entity. You can find definitions for the fields and controls later on this page.

Entity Unit Tester

Entity: Application Attachment

Unit Test Statuses			
Entity Name	Unit Test Count	Status	View Unit Tests
FileAttachment	1	Passed	View Unit Tests

[Run Unit Tests](#)

Once an entity is selected, any unit test for that entity or any children show up. If an entity has no unit tests, it does not appear in the grid.

Clicking the Run Unit Tests button starts running unit tests entity by entity. Each time all the unit tests for an entity are completed the status is returned and the next entity is set for running. This is all done automatically.

The statuses are set to either *Passed* or *Failed* - *Passed* telling you all the unit tests passed and *Failed* meaning at least one unit test failed.

Warning! Once the unit tests start, wait until statuses are set for all unit tests. Changing pages and other such actions interrupt the unit test process.

Note: When unit tests are run from the Entity Registry page directly, they perform a similar process. However, instead of running tests on a per entity basis, tests are run on a per unit test basis.

Click the View Unit Tests link on the Entity Unit Tester page to access the Entity Unit Tests page. The Entity Unit Tests page displays the individual unit tests for an entity.

This example illustrates the fields and controls on the Entity Unit Tests page. You can find definitions for the fields and controls later on this page.

Entity Unit Tests

Entity Name: FileAttachment

Unit Tests					
Active	Type	Application Class	Last Run Status	Last Run Datetime	Details
<input checked="" type="checkbox"/>	Other	UT_SCC_BEN::FAttach	Passed	07/13/10 2:32:24AM	Details

Note: The fields on the Entity Unit Tests page are display only. Their setup is defined by selecting *Unit Test* in the Action field on the Entity Registry page for the entity.

Field or Control	Description
Active	Specifies if the unit test is set to active and should be run. Any unit test set to not active is not run.
Type	A categorical classification of the unit test, this is mostly for description.
Application Class	The application class of the unit test you created for this entity.
Last Run Status	The status the last time this unit test was run (<i>Passed</i> or <i>Failed</i>).
Last Run Datetime	The last time this unit test was run.
Details	Click to access the Entity Unit Test Details page. The page displays the details of the unit test, including all messages output. If a unit test fails, the information provided could help you identify the reasons of the failure.

The following is an example of the Entity Unit Test Details page:

This example illustrates the fields and controls on the Entity Unit Test Details page. You can find definitions for the fields and controls later on this page.

Entity Unit Test Details

Entity Unit Test Details

Entity Name	FileAttachment	Type	Other
AppClass	UT_SCC_BEN::FAttach		
Status	Passed	Last Run	07/13/10 2:32:24AM

Details

```
<?xml version="1.0"?>
<APPLICATION>
  <SCC_TEMP_ID>1849</SCC_TEMP_ID>
  <ACAD_CAREER>UGRD</ACAD_CAREER>
  <STDNT_CAR_NBR>0</STDNT_CAR_NBR>
  <ADM_APPL_NBR>00025859</ADM_APPL_NBR>
  <INSTITUTION>PSAUS</INSTITUTION>
  <ADM_APPL_CTR>UGRD</ADM_APPL_CTR>
  <ADMIT_TYPE>FYR</ADMIT_TYPE>
  <FIN_AID_INTEREST>N</FIN_AID_INTEREST>
  <HOUSING_INTEREST></HOUSING_INTEREST>
  <APPL_FEE_STATUS>BEN</APPL_FEE_STATUS>
```

Return

Creating a New Entity

The way that you create a new entity varies based on the nature of the transaction that uses the entity. For example, if the entity is used as part of a Constituent Transaction Management transaction, the entity you create needs to be set with an entity type that uses stage records and production records. Those records need to be created prior to creating the entity. While these specificities are described in the features' related documentation, this section describes the generic steps that need to be taken independently from the transactions that use the entity.

This section discusses how to:

- Create or extend stage records.
- Create an entity application class.
- Create an entity.
- Generate XSD schemas.

- Set up or verify the Campus Solutions SOA framework.
- Set up logging.

Creating or Extending Stage Records

If the entity you are creating requires staging the information into a temporary record (stage record) prior to posting to a true production record, you first need to create the stage records prior to creating the corresponding entities. You can also extend any of the delivered stage records to meet your requirements. The *Staging* table holds the staged data before it gets promoted to its matching production table.

The newly created staging record along with its matching production record are later linked together through an entity defined in the Entity Registry component (see the *Creating an Entity* subsection in this section). In the Entity Registry component, you see that the entities have a parent/child relationship. This relationship is mostly based on the record structure of the production and the stage records.

Note: When creating the entity for the stage and production records, if you select one of the following two delivered entity types: *Staged Entity* or *Staged HR Entity*, the system expects the staging record to be keyed by the SCC_TEMP_ID field, and the production record keyed by EMPLID. If instead you create your own Entity Type that also uses staging records, then you can key the stage and the production records however you like.

The high level key used for your staging records (in most cases you use SCC_TEMP_ID) is a unique identifier that replaces the ID used in the equivalent production table. The rest of the keys for a staging record are similar to the equivalent production record.

A staging record is not effective-dated (it does not include the EFFDT and the EFF_STATUS fields). This is true even if the matching production record is effective-dated. This is because the data entered in staging can be modified many times prior to being promoted to production. Only at that time, the data is current, and therefore the production record is set with the date the data is posted.

Below is an example of a delivered staging record with its matching production record that uses effective-dating:

This example illustrates the fields and controls on the Production record definition that stores Addresses (HCR_PER_ADDR_I). You can find definitions for the fields and controls later on this page.

HCR_PER_ADDR_I (Record)													
Record Fields												Record Type	
Num	Field Name	Type	Key	Ordr	Dir	CurC	Srch	List	Sys	Audt	InAu	EnAuto	Default
1	EMPLID	Char	Key	1	Asc		Yes	Yes	No		No	No	
2	ADDRESS_TYPE	Char	Key	2	Asc		Yes	Yes	No		No	No	
3	EFFDT	Date	Key	3	Desc		No	No	No		No	No	%date
4	EFF_STATUS	Char					No	No	No		No	No	'A'
5	ADDRESS_NPC_SBR	SRec					No	No	No		No	No	
6	ADDRESS1_AC	Char					No	No	No		No	No	
7	ADDRESS2_AC	Char					No	No	No		No	No	
8	ADDRESS3_AC	Char					No	No	No		No	No	
9	CITY_AC	Char					No	No	No		No	No	
10	REG_REGION	Char					No	No	No		No	No	

The equivalent staging record definition is defined as follows:

This example illustrates the fields and controls on the Matching Staging record definition that stores Addresses (SCC_STG_ADDR). You can find definitions for the fields and controls later on this page.

SCC_STG_ADDR (Record)													
Record Fields Record Type													
Num	Field Name	Type	Key	Ordr	Dir	Cur	Srch	List	Sys	Audt	InAu	EnAuto	Default
1	SCC_TEMP_ID	Nbr	Key	1	Asc		No	No	No		No	No	
2	ADDRESS_TYPE	Char	Key	2	Asc		Yes	Yes	No		No	No	
3	SCC_ADDRESSAREA	Char					No	No	No		No	No	
4	ADDR_TYPE_DESCR	Char	Alt		Asc		No	Yes	No		No	No	
5	ADDRESS_SBR	SRec					No	No	No		No	No	
6	ADDRESS1_AC	Char					No	No	No		No	No	
7	ADDRESS2_AC	Char					No	No	No		No	No	
8	ADDRESS3_AC	Char					No	No	No		No	No	
9	CITY_AC	Char					No	No	No		No	No	
10	REG_REGION	Char					No	No	No		No	No	
11	SCC_AUDIT_SBR	SRec					No	No	No		No	No	

The delivered staging tables can be extended or modified to meet your needs. For instance, if you customized the production record that stores addresses (HCR_PER_ADDR_I record) by adding new fields, you may want to make sure those extra fields are also added to the its corresponding staging record (SCC_STG_ADDR record).

Note: If you create or extend a stage record that is later used as part of the Constituent Transaction Management framework, review the information in [Developer Reference to Deploy New User Registration](#), “Step 1: Creating or Extending Staging Tables.”

Creating an Entity Application Class

When creating a new entity, you must select an entity type. The entity type selected is set up with a base application class. The new entity uses this base application class by default. However, you can create a new application class that is specific to the entity name. This *entity* application class extends the base application class.

To create a new entity application class, follow the below steps:

1. In the Application Designer, create a new application class under a new application package or reuse an existing one. For example, the application classes setup with delivered entities were created under the following application packages:

<i>Delivered Transactions</i>	<i>Application Package</i>
AAWS Admission Transactions	SAD_ADM_APPL
Academic Item Registry (AIR)	SSR_AIR
Academic Progress Tracker (APT)	SSR_APT
Activity Management	SSR_ACTIVITY
Constituent Transaction Management (CTM)	SCC_SL_TRANSACTION

<i>Delivered Transactions</i>	<i>Application Package</i>
Class Search	SSR_CLASS
Course Shopping Cart	SSR_COURSE
Delegated Access	SCC_DA
Entity API	SCC_COMMON:ENTITY:API
Evaluation Management	SCC_GENERIC_EVALUATIONS
Notification Framework	SCC_COMMON:NOTIFICATION
Research	SSR_RS_RESEARCH
Rules Engine	SCC_RULES_ENGINE
StudyList	SSR_STUDYLIST

The above table shows the application packages used by the delivered transactions that use entity registry.

Below is an example of the SCC_SL_TRANSACTION:INTFC application package that comprises application classes used by Constituent Transaction Management:

This example illustrates the fields and controls on the Example of application classes used by CTM. You can find definitions for the fields and controls later on this page.

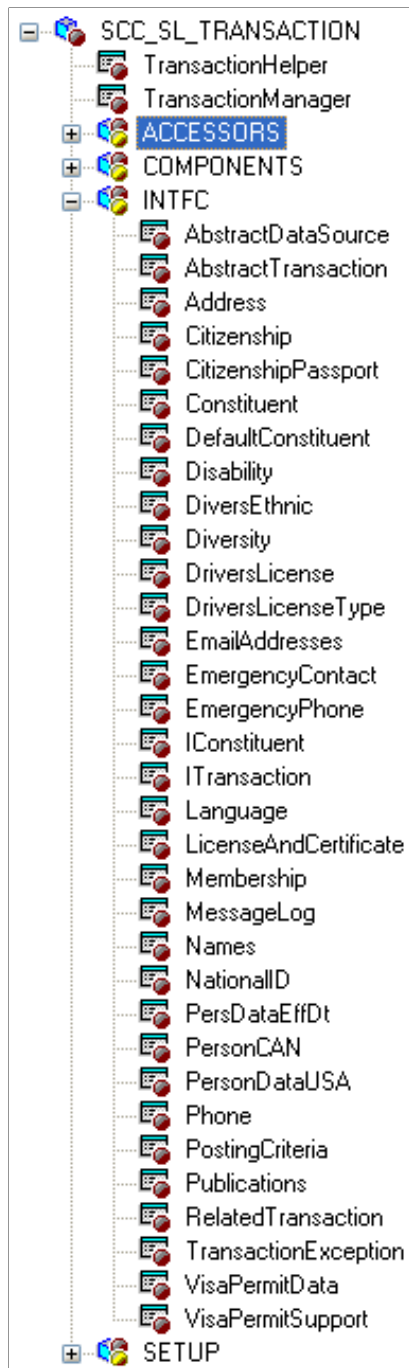

Warning! It is recommended that you do not update delivered application packages to insert the entity application class. Instead, create a separate application package. This is because any modifications made to the delivered application package is considered a customization, and might be overridden when a software updates are delivered.

2. Save the new application class without inserting any Peoplecode logic. Use the entity registry to generate the Peoplecode. This task is defined in the next steps.

Creating an Entity

This section discusses how to create an entity for the application class you created in the previous section.

The new entity can be a parent entity or a child of an existing parent. For instance, delivered with your system, the *Constituent* and the *Application* entities are parent entities of many children.

Creation considerations:

1. Name the new entity in relation with the underlying record(s) (that is, the stage and/or the production records you are creating the entity for). For example, the entity name for the address underlying records is *Address*.
2. Select a delivered entity type that corresponds to the need of the transactions that use the entity. For example, if you create an entity for a transaction that requires temporarily staging the information to a stage record, make sure you select an entity type that use stage records. If the delivered entity types do not match your needs, create a new one.
3. Enter the application class name you created in the previous step. The application class you insert here extends the Base Application Class defined in the Entity Type selected. For example, if you create an entity using entity type Staged Entity, the application class you insert extends the base application class *SCC_COMMON:ENTITY:StagedEntity*. If you used entity type Basic Entity, the application class given inside the entity setup extends the base application class *SCC_COMMON:ENTITY:BasicEntity*.
4. Enter the other required information and save. After the first save, the Properties button is displayed. Use the Entity Properties page to add any extra needed properties. Save.
5. If the entity you created was to be a child of an existing entity (like *Address* is a child to *Constituent* entity), you can now access the parent entity and list the newly created entity in the Children grid of the Entity Registry page. If the entity you created was to be a parent, you can then attach children to it.

Warning! At this stage, if you added a child entity, the message schema does not reflect this new entity. However, if the entity is added to an incoming message and no schema validation is occurring, the incoming message containing this data is processed and this entity is handled. As an example, the Address entity is registered as a child entity to the Constituent entity.

This example illustrates the fields and controls on the Example of the entity created for Address. You can find definitions for the fields and controls later on this page.

Entity Registry

Entity Configuration

Entity ID: SCC_ENTITY_20090520155755

Name:

Status: ▼

Entity Type: ▼

Description:

*AppClass: 🔍

Prod Record: 🔍

Stage Record: 🔍

Element (XML):

Apply Data Update Rule

Children							
Order	Entity Name	Status	Embed	*Min	*Max	Element Wrapper (XML)	View
1	<input type="text" value=""/> 🔍		<input type="checkbox"/>	0	0	<input type="text" value=""/>	View <input type="button" value="+"/> <input type="button" value="-"/>

Parents

[Constituent](#)

Generate the Application Class Peoplecode

When creating the entity application class, you do not enter peoplecode logic inside the application class. After creating the new entity and entering the newly created application class, use the Entity Registry to write the application class peoplecode for you.

From the Entity Registry component for the entity you created above, select *Generate Code* in the Action field. In the Entity Code Generation page, select the desired options to include in the peoplecode. The inclusions later facilitate the work of customizing the peoplecode (Custom Presave Code, Custom Validation Code, Custom SetDefault Code and Extend Fill). Click the Generate Code button. The AppClass Code box is shown. Select all the code and paste it in the peoplecode of the application class you created above in Application Designer.

In Application Designer, modify the peoplecode as needed:

- Any new class that you create must declare all its own immutable keys and mutable properties:

This example illustrates the fields and controls on the Examples of properties listed inside the SCC_SL_TRANSACTION:INTFC.Address application class. You can find definitions for the fields and controls later on this page.

```
property string ADDRESS_TYPE get set;
property date EFFDT get set;

property string ADDRESS1 get set;
property string ADDRESS2 get set;
property string ADDRESS3 get set;
property string ADDRESS4 get set;
property string POSTAL get set;
property string CITY get set;
property string STATE get set;
property string COUNTRY get set;
property boolean PRIMARY;

property string ADDRESS1_AC get set;
property string ADDRESS2_AC get set;
property string ADDRESS3_AC get set;
property string CITY_AC get set;
property string REG_REGION get set;

/*other fields from ADDRESS_SBR*/
property string NUM1 get set;
property string NUM2 get set;
property string HOUSE_TYPE get set;
property string ADDR_FIELD1 get set;
property string ADDR_FIELD2 get set;
property string ADDR_FIELD3 get set;
property string COUNTY get set;
property string GEO_CODE get set;
property string IN_CITY_LIMIT get set;
```

- Any new class that you create may choose to override the validate() method in order to validate data prior to saving.

This example illustrates the fields and controls on the Examples of validation done inside the SCC_SL_TRANSACTION:INTFC.Address application class. You can find definitions for the fields and controls later on this page.

```

method validate
  /* @p_messageLog as SCC_COMMON:ENTITY:LOG:MessageLogBase out */
  /* Extends/implements SCC_COMMON:ENTITY:AbstractEntity.validate */

  Local string &add1, &add2, &add3, &add4;
  Local SCC_COMMON:ENTITY:LOG:MessageEntry &msgEntry;

  %Super.validate(&p_messageLog);

  If Not %This.entityDelete Then

    /* An Address record must contain one of the ADDRESS1,2,3 or 4 fields. */
    &add1 = %This.ADDRESS1;
    &add2 = %This.ADDRESS2;
    &add3 = %This.ADDRESS3;
    &add4 = %This.ADDRESS4;

    If None(&add1, &add2, &add3, &add4) Then
      /*2030817000 */
      rem      &p_messageLog.write(1000, 542, 2, "", "", "", "", "");
      &msgEntry = create SCC_COMMON:ENTITY:LOG:MessageEntry();
      &msgEntry.DataPopulateV1(1000, 542, &msgEntry.Severity_Error, Null, "", %
      &p_messageLog.writeEntry(&msgEntry);

      /*2030817000 */
    End-If;
  End-If;
end-method;

```

- Any new class that you create may choose to override the preSave() method in order to default fields before the user saves the application.

This example illustrates the fields and controls on the Examples of presave logic done inside the SCC_SL_TRANSACTION:INTFC.Names application class. You can find definitions for the fields and controls later on this page.

```

method preSave
  /* Extends/implements SCC_COMMON:ENTITY:AbstractEntity.preSave */

  /*2003758000*/
  Local string &srch;
  /*2003758000*/
  If None(%This.data.FIRST_NAME_SRCH.Value) Then
    /*2003758000*/
    REM %This.data.FIRST_NAME_SRCH.Value = Upper(%This.data.FIRST_NAME.Value);
    RemoveAccent(%This.data.FIRST_NAME.Value, &srch);
    %This.data.FIRST_NAME_SRCH.Value = &srch;
    /*2003758000*/
  End-If;

  If None(%This.data.LAST_NAME_SRCH.Value) Then
    /*2003758000*/
    REM %This.data.LAST_NAME_SRCH.Value = Upper(%This.data.LAST_NAME.Value);
    &srch = "";
    RemoveAccent(%This.data.LAST_NAME.Value, &srch);
    %This.data.LAST_NAME_SRCH.Value = &srch;
    /*2003758000*/
  End-If;

end-method;

```

- Any new class that you create may choose to override the setDefault() in order default values.
- Any new class may declare get/set methods for its properties.

This example illustrates the fields and controls on the Examples of get and set inside the SCC_SL_TRANSACTION:INTFC.Address application class. You can find definitions for the fields and controls later on this page.

```
get ADDRESS1
    /+ Returns String +/
    Return %This.data.ADDRESS1.Value;
end-get;

set ADDRESS1
    /+ &NewValue as String +/
    %This.data.ADDRESS1.Value = &NewValue;
end-set;

get ADDRESS2
    /+ Returns String +/
    Return %This.data.ADDRESS2.Value;
end-get;

set ADDRESS2
    /+ &NewValue as String +/
    %This.data.ADDRESS2.Value = &NewValue;
end-set;
```

Generating XSD Schemas

The features using Entity Registry can use web services. Depending on what entities are referenced by the messages on the service operation, select an action of Generate XSD for the entity name that is considered the top level used. Selecting the Generate XSD action creates the message schemas of the API for that entity.

To do so, perform the following steps:

1. Access the top level entity name referred by the messages in the service operation and select the Generate XSD action (this may not necessarily be the parent entity name. It depends on what entities are referenced by the messages on the service operation).
2. After selecting the Generate XSD action, the entity schema is displayed:

This example illustrates the fields and controls on the Entity schema generated for the Constituent entity (parent entity). You can find definitions for the fields and controls later on this page.

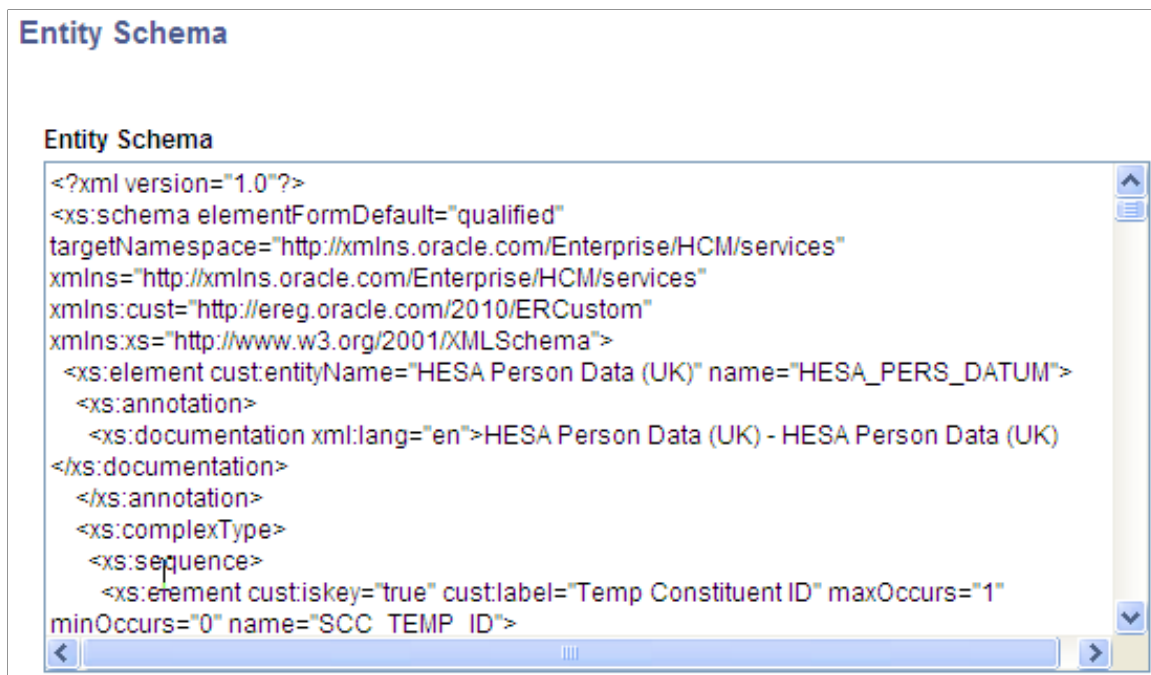

The screenshot shows a window titled "Entity Schema" containing an XML schema definition. The schema is for an element named "HESA_PERSON_DATA_UK" with the namespace "http://ereg.oracle.com/2010/ERCustom". It includes documentation in English and a complex type with a sequence of elements. One element is "SCC_TEMP_ID", which is a key (cust:iskey="true"), has a label "Temp Constituent ID", and occurs at most once (maxOccurs="1") and at least zero times (minOccurs="0").

```
<?xml version="1.0"?>
<xs:schema elementFormDefault="qualified"
targetNamespace="http://xmlns.oracle.com/Enterprise/HCM/services"
xmlns="http://xmlns.oracle.com/Enterprise/HCM/services"
xmlns:cust="http://ereg.oracle.com/2010/ERCustom"
xmlns:xs="http://www.w3.org/2001/XMLSchema">
  <xs:element cust:entityName="HESA Person Data (UK)" name="HESA_PERSON_DATA_UK">
    <xs:annotation>
      <xs:documentation xml:lang="en">HESA Person Data (UK) - HESA Person Data (UK)</xs:documentation>
    </xs:annotation>
    <xs:complexType>
      <xs:sequence>
        <xs:element cust:iskey="true" cust:label="Temp Constituent ID" maxOccurs="1"
minOccurs="0" name="SCC_TEMP_ID">

```

3. Select the entire generated schema and paste it into the appropriate messages to modify the overall schema.
4. Navigate to **PeopleTools > Integration Broker > Integration Setup > Messages**. Search for the relevant message. In the Schema tab, click the Edit Schema button and paste in the generated schema. Save the component.

For example, suppose you generated the schema for the *Constituent* entity. Navigate to the message Schema page. Search for the message called SCC_ENTITY_CONSTITUENT. Click the Edit Schema button and paste the generated schema as shown in screen shot below.

This example illustrates the fields and controls on the Constituent message partial schema. You can find definitions for the fields and controls later on this page.

Message Definition
Schema

Message: SCC_ENTITY_CONSTITUENT

Version: V1

Updated: 09/20/2011 2:45:48AM

Edit Schema

Delete Schema

Schema:

```

<?xml version="1.0"?>
<xs:schema elementFormDefault="qualified"
targetNamespace="http://xmlns.oracle.com/Enterprise/HCM/services"
xmlns="http://xmlns.oracle.com/Enterprise/HCM/services"
xmlns:cust="http://ereg.oracle.com/2010/ERCustom"
xmlns:xs="http://www.w3.org/2001/XMLSchema">
  <xs:element cust:entityName="HESA Person Data (UK)" name="HESA_PERS_DATUM">
    <xs:annotation>
      <xs:documentation xml:lang="en">HESA Person Data (UK) - HESA Person Data (UK)
    </xs:documentation>
    </xs:annotation>
    <xs:complexType>
      <xs:sequence>
        <xs:element cust:iskey="true" cust:label="Temp Constituent ID" maxOccurs="1"
minOccurs="0" name="SCC_TEMP_ID">
          <xs:annotation>

```

Note: The messages where you paste the schema are *entity* messages. These messages must be created with a message type of *Part NonRowset* based. This means they can be used by any Nonrowset based message. The web services created for your transaction can also refer to delivered entity messages. For example, a message with AAWS admission transaction, SAD_SUBMITAPPL_REQ message, calls both SCC_ENTITY_CONSTITUENT and SCC_ENTITY_APPLICANT message schema in its schema.

It is easy to maintain the entity messages as their schema can be generated from the Entity Registry page. Entity messages can be reused in any request or response message as per your requirement.

This example illustrates the fields and controls on the Example of a web service message calling the schema of a Part NonRowset message. You can find definitions for the fields and controls later on this page.

Message Definition
Schema

Message: SAD_SUBMITAPPL_REQ

Version: V1

Updated: 05/01/2011 10:45:15PM

Edit Schema
Delete Schema

Schema:

```

<?xml version="1.0"?>
<xs:schema elementFormDefault="qualified"
targetNamespace="http://xmlns.oracle.com/Enterprise/HCM/services"
xmlns="http://xmlns.oracle.com/Enterprise/HCM/services"
xmlns:xs="http://www.w3.org/2001/XMLSchema">
  <xs:include schemaLocation="SCC_ENTITY_CONSTITUENT.V1.xsd"/>
  <xs:include schemaLocation="SCC_ENTITY_APPLICATION.V1.xsd"/>
  <xs:element name="SAD_SUBMITAPPL_REQ">
    <xs:complexType>
      <xs:sequence>
        <xs:element minOccurs="0" name="SCC_ADMIN_MODE">
          <xs:complexType>
            <xs:sequence>
              <xs:element maxOccurs="1" minOccurs="1" name="INSTITUTION" type="xs:string"/>
              <xs:element maxOccurs="1" minOccurs="1" name="ADM_APPL_CTR" type="xs:string"/>
              <xs:element maxOccurs="1" minOccurs="1" name="EMPLID" type="xs:string"/>
            </xs:sequence>
          </xs:complexType>
        </xs:element>
        <xs:element maxOccurs="1" minOccurs="1" ref="ADM_APPL_DATA"/>
        <xs:element maxOccurs="1" minOccurs="1" ref="CONSTITUENT"/>
      </xs:sequence>
    </xs:complexType>
  </xs:element>
</xs:schema>

```

5. Once the schemas have been updated, the service WSDL needs to be republished in order to have all the new or updated entities recognized. In order to do that delete the existing WSDL under **PeopleTools > Integration Broker > Service Utilities > Service Administration > WSDL**. Select the appropriate service WSDL and press delete.

Republish the service WSDL under **PeopleTools > Integration Broker > Web Services > Provide Web Service**.

Setting Up or Verifying the Campus Solutions SOA Framework

During installation, the system automatically inserts configuration data into the Campus Solutions SOA Framework setup tables.

Access the Request Handlers component for the service operations that you created or are planning to use under **Set Up SACR > System Administration > Integrations > Request Handlers**. For each of the service operations you plan to use, ensure the Request Handler page contains the proper information. The application class path should be properly entered.

Setting Up Logging

Access the Logging component to enable and configure the logging feature under **Set Up SACR > System Administration > Integrations > Logging**.

This example illustrates the fields and controls on the Example of how the Logging page can be set up. You can find definitions for the fields and controls later on this page.

The screenshot shows a web interface titled "Logging" with a sub-section "Logging Parameters". The parameters are as follows:

*Logging Type:	File
*Log Threshold:	All
Logging Filename:	c:\temp\integration.log
Last Log ID Assigned:	8854

Note: You should not enable logging in a production environment. SOA framework logging is only appropriate for a testing, demo or development environment or when performing critical troubleshooting activities.

See *PeopleTools: Integration Broker*.

Entity Application Class Reference

This section discusses the delivered application classes and interfaces that you can use for creating or modifying entities.

interface SCC_COMMON:ENTITY:IEntity

Implementing Classes: SCC_COMMON:ENTITY:FileAttachment, SCC_COMMON:ENTITY:AbstractEntity

See Also: BasicEntity, StagedEntity, StagedHREntity

Summary

Property Summary:

public Array of string	baseProps: A list of properties that are controlled on the base entities, so the property name cannot be changed.
public Array of ChildEntity	ChildEntityArray: An array of all the ChildEntities of the current entity.
public Record	data: This entities a backing record.
public boolean	entityDelete: Marks this entity for deletion, and prevents save.
public string	entityID: ID of the entity from the registry.
public string	entityName: The name of the entity as defined in the registry.
public Array of DataKey	keyCollection: A collection of key values to be used when population of this entity occurs.
public IEntity	parent: parent Entity, null if it is at the top level of tree.
public ChildEntity	parentCE: The child entity that encompasses all the entities of a particular type under the parent.
public string	SCC_ENTITY_INST_ID: Entity Instance Id.
public boolean	selfServiceMode: Self Service mode flag.
public boolean	STAGE_MODE: Specifies if this entity is currently in Stage Mode (True) and working with the stage record, or in Production Mode (False) and working with the production record.
public string	UPDATE_RULE: Specifies the update rule to use for the purposes of Data Update Rule.
public string	USER_CONTEXT: The user that this is being run on behalf of, since adds and updates may be done from administrative mode on behalf of a given user.
public Array of string	XSDFieldList: A string list of all the fields for the current entity for the XSD. This is used in conjunction with buildXSD to determine if key fields are required, based on if their parent has the same key.

Method Summary:

public void	buildXSD(XmlNode xmlnode): Builds the xml schema section pertaining to this entity.
public void	clearDataPreImage(): Clears the DataPreImage for this entity and all its children.
public void	delete(boolean p_entityDelete): Sets entityDelete property for this entity and all its children.
public void	demote(number p_tempID): Moves data from production records to staging record.
public void	destroy(): Perform cleanup activity on this entity.
public void	fill(Record p_inRec out, boolean p_clearState): Fill (Populate) this entity using the given record, and populates all children based on the key structure.
public void	fillFromKeys(boolean p_clearState): Performs a select by key based on the fields on the underlying record. This should be run on the top level entity to start a fill.
public void	fromXmlNode(XmlNode parentNode): Converts data from XML to the entity model.
public Rowset	generateRowset(): This method generates a rowset of data for the underlying record of this entity based on the keys of the parent. It is used as part of the fill process for building out the entity tree. The method is called as if it were a static method, so it is not associated with any particular entity data. The base implementation dynamically matches keys from the parent to the child and builds the query for the rowset based on that.
public string	generateXSD(): Begins generation of an xml schema, based on the registry using this entity as the root.
public ChildEntity	getChildEntity(string p_entityID): Retrieves the ChildEntity Object based on the entity ID.
public string	getLOVDescr(string propName): Returns the LOV Description based on the associated property name when parsed from XML.

public number	getMaxSeqNbrSQL(): Retrieves the maximum sequence number from the database based on the key structure of the current entity.
public any	getProperty(string propName)
public void	hardDelete(MessageLogBase p_messageLog out): Performs the actual delete of all objects marked with the entityDelete flag.
public boolean	hasEffdt(): Checks if this entity has an effective date.
public boolean	hasEffseq(): Checks if this entity has an effective sequence.
public boolean	hasKey(string p_keyname): Checks if the current entity has a particular field as a key.
public boolean	isEqualKeys(IEntity p_entity): Determine Entity Key Equality.
public boolean	isEqualKeysRecord(Record p_rec): Allows the given record to be compared with this entity for equality. Compares for equality based on the underlying entity record content. RECOMMENDATION: Override this method if you need to do custom equality checking.
public void	prePublish(Rowset p_changesRS out): Uses the workflowPreimage and post images of the entity to build a PSCAMA Rowset in preparation for publish. The parameter Rowset may be Null. Data should be appended to this rowset if it is NON-Null.
public void	preSave(): Perform pre-Save activities on this entity.
public void	preSaveChildren()
public void	PreSaveFirst(): Pre-Save code that only runs on the first entity of a child array.
public void	promote(string emplID, MessageLogBase p_log out): Moves Data from Staging to Production Records (does not validate or save).

public void	publish(Rowset p_changesRS, boolean p_onlineMode): Takes a PSCAMA based rowset of information to be published during workflow Uses that information to construct a Message and according to the onlineMode publishes the Message data in realtime or to the batch delay table.
public void	save(MessageLogBase p_messageLog out): Save this entity and all its children.
public void	setChildren(): Builds out the structure of the ChildEntityArray object based on the registry.
public void	setDefault(): Sets default values for record fields.
public void	setProperty(string propName, any value)
public void	setStageMode(boolean p_stageInd): Changes the Stage_Mode property, as well as any related records. This should not be used once data has been set, to convert data use promote or demote.
public void	setUserContext(string p_userContext): Sets the value of the UserContext property.
public void	toXmlNode(XmlNode parentNode): Converts the data from the entity structure to XML.
public void	updateFromRecord(Record rec): Updates by matching fields in the record to fields in the underlying record on the entity. Values are only set if the value has changed. Values are set using properties, so any additional get-set logic is handled.
public void	updateKeyFields(): Updates the keyfields of all children based on the current entity. This allows key changes to roll down properly.
public void	validate(MessageLogBase p_messageLog out): Validate this entities' contents (and all its children).
public void	validateFirst(MessageLogBase p_messageLog out): Validation code that only runs on the first entity of a child array.

public void	workflow(boolean p_onlineMode): Orchestrates the prepublish and publish methods for this entity and all children.
-------------	---

Details

Property Details:

baseProps	public Array of string
ChildEntityArray	public Array of ChildEntity
data	public Record
entityDelete	public boolean
entityID	public string
entityName	public string
keyCollection	public Array of DataKey
parent	public IEntity
parentCE	public ChildEntity
SCC_ENTITY_INST_ID	public string
selfServiceMode	public boolean
STAGE_MODE	public boolean
UPDATE_RULE	public string
USER_CONTEXT	public string
XSDFieldList	public Array of string

Method Details:

buildXSD	<p>Parameters:</p> <p>XmlNode xmlnode: The Tools XmlNode object of the parent that should be continued by this entity.</p>
clearDataPreImage	N/A
delete	<p>Parameters:</p> <p>boolean p_entityDelete: The value to be set for the entityDelete property.</p>
demote	<p>Parameters:</p> <p>number p_tempID: The tempid to replace the emplid with.</p>
destroy	N/A
fill	<p>Parameters:</p> <p>Record p_inRec(out): This record populates the record underlying this entity.</p> <p>boolean p_clearState: If the clearstate is true the datapreimage is populated as well.</p>
fillFromKeys	<p>Parameters:</p> <p>boolean p_clearState: Whether or not to RESET this entities pre-image.</p>
fromXmlNode	<p>Parameters:</p> <p>XmlNode parentNode: The XML node to pull from.</p>
generateRowset	<p>Return:</p> <p>Rowset - a rowset populated based on the parent keys, or null if no rows are found.</p>
generateXSD	<p>Return:</p> <p>string - the XSD as a string.</p>

getChildEntity	<p>Parameters:</p> <p>string p_entityID: The entity ID, based on the registry, of the ChildEntity object to retrieve.</p> <p>Return:</p> <p>ChildEntity</p>
getLOVDescr	<p>Parameters:</p> <p>string propName: The property name to get a LOV Description based on.</p> <p>Return:</p> <p>string</p>
getMaxSeqNbrSQL	<p>Return:</p> <p>number - the maximum sequence number found.</p>
getProperty	<p>Parameters:</p> <p>string propName</p> <p>Return:</p> <p>any</p>
hardDelete	<p>Parameters:</p> <p>MessageLogBase p_messageLog(out): The MessageLog object to log all errors/warnings to.</p>
hasEffdt	<p>Return:</p> <p>boolean - true if it has an effective date false otherwise.</p>
hasEffseq	<p>Return:</p> <p>boolean - true if it has an effective sequence false otherwise.</p>

hasKey	<p>Parameters:</p> <p>string p_keyname: The name of the field to check.</p> <p>Return:</p> <p>boolean - true if the field is a key, false if the field is not a key or the entity does not include it.</p>
isEqualKeys	<p>Parameters:</p> <p>IEntity p_entity: The entity to compare the current entity to.</p> <p>Return:</p> <p>boolean - true if the entity keys are equal false otherwise.</p>
isEqualKeysRecord	<p>Parameters:</p> <p>Record p_rec</p> <p>Return:</p> <p>boolean</p>
prePublish	<p>Parameters:</p> <p>Rowset p_changesRS(out)</p>
preSave	N/A
preSaveChildren	N/A
PreSaveFirst	N/A
promote	<p>Parameters:</p> <p>string emplID: The emplid for production to replace the tempid from staging.</p> <p>MessageLogBase p_log(out): The MessageLog object to log all errors/warnings to.</p>
publish	<p>Parameters:</p> <p>Rowset p_changesRS</p> <p>boolean p_onlineMode</p>

save	Parameters: MessageLogBase p_messageLog(out): The messagelog object to log errors and warnings to.
setChildren	N/A
setDefault	N/A
setProperty	Parameters: string propname any value
setStageMode	Parameters: boolean p_stageInd: The value to set the stage mode to, if the value passed matches the current stage mode no changes are made.
setUserContext	Parameters: string p_userContext: The value set for the property UserContext.
toXmlNode	Parameters: XmlNode parentNode: The XML parent node to push the xml to.
updateFromRecord	Parameters: Record rec: The record object to copy data from.
updateKeyFields	N/A
validate	Parameters: MessageLogBase p_messageLog(out): The messagelog object to log errors and warnings to.
validateFirst	Parameters: MessageLogBase p_messageLog(out): The MessageLog object to log all errors/warnings to.

workflow	Parameters: boolean p_onlineMode
----------	---

abstract class SCC_COMMON:ENTITY:AbstractEntity

Implemented Interfaces: SCC_COMMON:ENTITY:IEntity

Direct Known Subclasses: SCC_COMMON:ENTITY:StagedEntity,
SCC_COMMON:ENTITY:StagedHREntity, SCC_COMMON:ENTITY:BasicEntity,
SCC_COMMON:ENTITY:WorkEntity

See Also: BasicEntity, StagedEntity, StagedHREntity

Summary

Property Summary

public Array of string	baseProps: A list of properties that are controlled on the base entities, so the property name cannot be changed.
public Array of ChildEntity	ChildEntityArray: An array of all the ChildEntities of the current entity. The childEntities are determined by the entity registry, and populated when the entity is instansiated.
public Record	data: The backing record for this entity.
public Record	dataPreimage: The preimage of the backing record for this entity. The entity is compare against the preimage prior to save.
public boolean	DO_SAVE: Specifies if the entity is allowed to save.
protected AnyHashMap	dynamicProperties
public boolean	entityDelete: Marks this entity for deletion, and prevents save.
public string	entityID: ID of the entity from the registry.
protected Record	EntityMetaData
public string	entityName: The name of the entity as defined in the registry.

protected boolean	hasAuditRowAddDttm
protected boolean	hasAuditRowAddOprid: A value, set by testForAudit, that specifies if this entity has audit fields. It is used during save time to determine if the audit fields need to be updated.
protected boolean	hasAuditRowUpdDttm
protected boolean	hasAuditRowUpdOprid
protected Array of string	ignoreFields: DEPRECATED. ignoreFields is no longer used; if it is found it is used by EntityPropBuilder during the upgrade to the new property system. The array of names of fields to ignore for the purposes of moving data to and from xml, pushing a new field onto this array adds it to the list.
public Array of DataKey	keyCollection
public IEntity	parent: Parent Entity, null if it is at the top level of tree.
public ChildEntity	parentCE: The child entity that encompasses all the entities of a particular type under the parent.
public string	prodRecordName: The name of the production record is populated here based on the registry.
protected Rowset	PropertyMetaData
protected string	RECORD_NAME: The name of the current record underlying this entity.
public string	SCC_ENTITY_INST_ID: A unique identifier for the specific row of data.
public datetime	SCC_ROW_ADD_DTTM: The Datetime the row of data was added, this is part of the who columns. This property corresponds to this field, if it exists on the record, if not it does nothing. RECOMMENDATION: Do not override get & set.

public string	<p>SCC_ROW_ADD_OPRID: The Person who added the row of data, this is part of the who columns. This property corresponds to this field, if it exists on the record, if not it does nothing.</p> <p>RECOMMENDATION: Do not override get & set.</p>
public datetime	<p>SCC_ROW_UPD_DTTM: The Datetime the row of data was update, this is part of the who columns. This property corresponds to this field, if it exists on the record, if not it does nothing.</p> <p>RECOMMENDATION: Do not override get & set.</p>
public string	<p>SCC_ROW_UPD_OPRID The Person who updated the row of data, this is part of the who columns. This property corresponds to this field, if it exists on the record, if not it does nothing.</p> <p>RECOMMENDATION: Do not override get & set.</p>
public boolean	<p>selfServiceMode: If the entity is in selfServiceMode.</p>
public boolean	<p>STAGE_MODE: Specifies if this entity is currently in Stage Mode (True) and working with the stage record, or in Production Mode (False) and working with the production record.</p>
public string	<p>UPDATE_RULE: Specifies the update rule to use for the purposes of Data Update Rule.</p>
public string	<p>USER_CONTEXT: The user that this is being run on behalf of, since adds and updates may be done from administrative mode on behalf of a given user, or %UserId.</p>
public Record	<p>workflowPreimage: The pre-image object to use for workflow.</p>
protected string	<p>XSDCustomNS: The namespace to use for custom attributes in the schema, found and set during generateXSD.</p>
public Array of string	<p>XSDFieldList: A string list of all the fields for the current entity for the XSD. This is used in conjunction with buildXSD to determine if key fields are required, based on if their parent has the same key.</p>

protected string	XSDNS: The namespace to use for the schema, found and set during generateXSD.
------------------	---

Constructor Summary:

public void	AbstractEntity(IEntity p_parent): The Constructor.
-------------	--

Method Summary:

protected string	applyDataKey(string p_queryString)
protected string	buildCSVString(array of any p_arrValues, string p_metaTag)
protected void	buildPropertyMetaDataCache()
public void	buildXSD(XmlNode xmlnode): Builds the xml schema section pertaining to this entity. The implementation builds and populates the schema based on the underlying record, ignoring any fields in the ignore array. Keys that roll down from the parent are not marked required on the child. RECOMMENDATION: Only override if the entity requires a custom schema.
protected void	buildXSDChildren(XmlNode xmlnode): Iterates through the ChildEntityArray and issues a buildXSD against each ChildEntity, which in turn creates a temporary entity and calls buildXSD. Base implementation uses the entity registry. RECOMMENDATION: Do not override.
protected void	changeRecord(string p_recname): Changes the record to the record name specified. RECOMMENDATION: Do not override.
public void	clearDataPreImage(): Clears the Data preimage and workflow preImage. RECOMMENDATION: Do not override.

protected void	<p>clearDataPreImageChildren(): Iterates through the ChildEntityArray and issues a clearDataPreImage against each ChildEntity, which in turn calls clearDataPreImage on all of the entities it contains.</p> <p>RECOMMENDATION: Do not override.</p>												
protected void	<p>commonValidate(MessageLogBase p_messageLog out, number p_validateArgs):</p> <p>Runs the record based validations and outputs results to the log. Also invokes validateChildren. validateChildren is called before record based validations. Validation Arguments</p> <table border="1"> <tr> <td>%Edit_DateRange</td> <td>Reasonable Date Range (Is the date contained within the specified reasonable date range?)</td> </tr> <tr> <td>%Edit_OneZero</td> <td>1/0 (Do all 1/0 fields contain only a 1 or 0?)</td> </tr> <tr> <td>%Edit_PromptTable</td> <td>Prompt Table (Is field data contained in the specified prompt table?)</td> </tr> <tr> <td>%Edit_Required</td> <td>Required Field (Do all required fields contain data? For numeric or signed fields, it checks that they do not contain NULL or 0 values.)</td> </tr> <tr> <td>%Edit_TranslateTable</td> <td>Translate Table (Is field data contained in the specified translate table?)</td> </tr> <tr> <td>%Edit_YesNo</td> <td>Yes/No (Do all yes/no fields only contain only yes or no data?)</td> </tr> </table>	%Edit_DateRange	Reasonable Date Range (Is the date contained within the specified reasonable date range?)	%Edit_OneZero	1/0 (Do all 1/0 fields contain only a 1 or 0?)	%Edit_PromptTable	Prompt Table (Is field data contained in the specified prompt table?)	%Edit_Required	Required Field (Do all required fields contain data? For numeric or signed fields, it checks that they do not contain NULL or 0 values.)	%Edit_TranslateTable	Translate Table (Is field data contained in the specified translate table?)	%Edit_YesNo	Yes/No (Do all yes/no fields only contain only yes or no data?)
%Edit_DateRange	Reasonable Date Range (Is the date contained within the specified reasonable date range?)												
%Edit_OneZero	1/0 (Do all 1/0 fields contain only a 1 or 0?)												
%Edit_PromptTable	Prompt Table (Is field data contained in the specified prompt table?)												
%Edit_Required	Required Field (Do all required fields contain data? For numeric or signed fields, it checks that they do not contain NULL or 0 values.)												
%Edit_TranslateTable	Translate Table (Is field data contained in the specified translate table?)												
%Edit_YesNo	Yes/No (Do all yes/no fields only contain only yes or no data?)												
protected void	<p>defaultChildren(): Iterates through the ChildEntityArray and issues a setDefault against each ChildEntity, which in turn calls setDefault on all of the entities it contains. Base implementation uses the entity registry.</p> <p>RECOMMENDATION: Do not override.</p>												
public void	<p>delete(boolean p_entityDelete): Marks this entity and all its children for deletion at save time - soft delete.</p> <p>RECOMMENDATION: Do not override this method.</p>												
protected void	<p>deleteChildren(boolean p_entityDelete): Iterates through the ChildEntityArray and issues a delete against each ChildEntity, which in turn calls delete on all of the entities it contains. Base implementation uses the entity registry.</p> <p>RECOMMENDATION: Do not override.</p>												

public void	<p>demote(number p_tempID): Moves data from production records to staging record.</p> <p>RECOMMENDATION: This must be implemented, but is only used if the entity is staged. In the implementation make sure to call demoteChildren to cause demote to work with the registry.</p>
protected void	<p>demoteChildren(number p_tempID): Iterates through the ChildEntityArray and issues a demote against each ChildEntity, which in turn calls demote on all of the entities it contains. Base implementation uses the entity registry.</p> <p>RECOMMENDATION: Do not override.</p>
public void	<p>destroy(): Perform cleanup activity on this entity.</p>
public boolean	<p>entityFieldUpdateNeeded(Rowset p_DataUpdateRule, string p_fieldName, any oldValue)</p> <p>RECOMMENDATION: Do not override</p>
public boolean	<p>entityTypeUpdateNeeded(Rowset p_DataUpdateRule, any p_entityType, boolean p_newFlag)</p> <p>RECOMMENDATION: Do not override.</p>
public boolean	<p>entityTypeUpdateRequested(Rowset p_DataUpdateRule, any p_entityType)</p> <p>RECOMMENDATION: Do not override</p>
public boolean	<p>entityUpdateRequested(Rowset p_DataUpdateRule)</p> <p>RECOMMENDATION: Do not override.</p>
public void	<p>fill(Record p_inRec out, boolean p_clearState): Populates (fills) this entity from the given record.</p> <p>RECOMMENDATION: Do not override.</p>
protected void	<p>fillChildren(boolean p_clearState): Iterates through the ChildEntityArray and issues a fill against each ChildEntity, which in turn calls fill on all of the entities it contains. Base implementation uses the entity registry.</p> <p>RECOMMENDATION : Do not override.</p>

public void	fillFromKeys(boolean p_clearState): Performs a select by key based on the fields on the underlying record. This should be run on the top level entity to start a fill.
protected void	fillLOVDescrs(): Re-initializes and Populates the LOV Description Hash Map shmLOVDescr based on the current property values.
public void	fromXmlNode(XmlNode parentNode): Retrieves data to properties based on the fields in the record. Fields marked ignore are not Processed. Entity Element Names, wrapping of the ChildEntities or embedding is based on the entity registry. RECOMMENDATION: Only override if the xml for this entity has to be custom.
protected void	fromXmlNodeChildren(XmlNode parentNode): Iterates through the ChildEntityArray and issues a fromXmlNode against each ChildEntity, which in turn calls fromXmlNode on all of the entities it contains. Base implementation uses the entity registry. RECOMMENDATION: Do not override.
public Rowset	generateRowset(): This method generates a rowset of data for the underlying record of this entity based on the keys of the parent. It is used as part of the fill process for building out the entity tree. The method is called as if it were a static method, so it is not associated with any particular entity data. The base implementation dynamically matches keys from the parent to the child and builds the query for the rowset based on that. RECOMMENDATION: If the key structure between the parent and child does not match up, or the rowset needs to be built using another method (i.e. a service) override this method.
public string	generateXSD(): Generates the xml schema with this node as the root. RECOMMENDATION: Do not override.
public ChildEntity	getChildEntity(string p_entityID): Retrives the ChildEntity Object based on the entity ID. RECOMMENDATION: Do not override.

protected CSUserDefaults	getCSUserDefaults(): Retrieves the CSUserDefaults. RECOMMENDATION: Do not override.
public DataKey	getDataKey(): Retrieves the dataKey for this entity. RECOMMENDATION: Do not override.
public Record	getEntPropsByPropertyName(string propName): Returns the EntityProperty Record (SCC_ENT_PROPS) based on the property name.
protected string	getFullEntityPathName()
public array of string	getIgnoreFields(): A method to get the current ignorefields, used for upgrade.
protected InstallationHCM	getInstallationHCM(): Retrieves the HCM Installation Defaults. RECOMMENDATION: Do not override.
public string	getLOVDescr(string propName): Returns the LOV Description based on the associated property name when parsed from XML.
protected string	getLOVValue(Record p_recProp, string p_code)
public number	getMaxSeqNbrSQL(): Retrieves the maximum sequence number from the database based on the keystore of the current entity. This method is irrelevant if there are no sequence numbers for the entity. RECOMMENDATION: Override if there is a sequence number and it is not related to all the keys.
protected IEntity	getParent(): Retrieves the parent Entity. RECOMMENDATION: Do not override.
public any	getProperty(string propName)
protected any	getPropertyByMetaRec(Record propMetaRec)

protected string	<p>getRecordName(): Retrieves the name of the current record on this entity.</p> <p>RECOMMENDATION: Do not override.</p>
public string	<p>getTagByFieldName(string fieldname): Returns the xml tag based on the field name. If metadata exists that is used, otherwise it returns the field name. This method should no longer be overridden! The xml tag is now based on the property meta data.</p>
public void	<p>hardDelete(MessageLogBase p_messageLog out): Deletes the entity object and all its child entities from the database, based on the entityDelete flag.</p> <p>RECOMMENDATION: Do not override this method.</p>
protected void	<p>hardDeleteChildren(MessageLogBase p_messageLog out): Iterates through the ChildEntityArray and issues a hardDelete against each ChildEntity, which in turn calls hardDelete on all of the entities it contains. Base implementation uses the entity registry.</p> <p>RECOMMENDATION: Do not override.</p>
public boolean	hasEffdt()
public boolean	hasEffseq()
public boolean	<p>hasKey(string p_keyname): Check if the entity has a particular field as a key.</p> <p>RECOMMENDATION: Do not override.</p>
public boolean	<p>isEqualKeys(IEntity p_entity): Allows the given entity to be compared with this entity for equality. The Base implementation compares for equality based on the underlying entity record contents.</p> <p>RECOMMENDATION: Override this method if you need to do custom equality checking.</p>

public boolean	<p>isEqualKeysRecord(Record p_rec): Allows the given record to be compared with this entity for equality. Compares for equality based on the underlying entity record content.</p> <p>RECOMMENDATION: Override this method if you need to do custom equality checking.</p>
public void	<p>populateAudit(): Populates the who column data, this method is invoked prior to save. This allows handling of the who columns to be more or less dynamic. If there are no who columns this method does nothing .</p> <p>RECOMMENDATION: Do not override.</p>
public void	<p>prePublish(Rowset p_changesRS out): Uses the workflowPreimage and post images of the entity to build a PSCAMA Rowset in preparation for publish. The parameter Rowset may be Null. Data should be appended to this rowset if it is NON-Null.</p> <p>RECOMMENDATION: Override if pre-publish logic is required.</p>
public void	<p>preSave(): Allows the opportunity for an entity to perform any pre Save activities. The Base implementation does nothing. Presave is automatically called from save, from the top level entity, and runs the presave logic before invoking preSave children.</p> <p>RECOMMENDATION: Override this method if the entity needs to do last minute preSave processing.</p>
public void	<p>preSaveChildren(): Iterates through the ChildEntityArray and issues a preSave against each ChildEntity, which in turn calls preSave on all of the entities it contains. Base implementation uses the entity registry. Presave is automatically called from save, from the top level entity, and runs the presave logic before invoking preSave children.</p> <p>RECOMMENDATION: Do not override.</p>
public void	<p>preSaveFirst(): Similar to presave, however, this method is called once per childEntity, prior to any other presave activity to allow for presave activity that may act across all entities in the childEntity. The Base implementation does nothing.</p> <p>RECOMMENDATION: Override this method if the entity needs to do last minute preSave processing crossing entity boundaries.</p>

public void	<p>promote(string p_emplID, MessageLogBase p_log out): Moves Data from Staging to Production Records (does not validate or save).</p> <p>RECOMMENDATION: This must be implemented, but is only used if the entity is staged. In the implementation make sure to call promoteChildren to cause promote to work with the registry.</p>
protected void	<p>promoteChildren(string p_emplID, MessageLogBase p_log out): Iterates through the ChildEntityArray and issues a promote against each ChildEntity, which in turn calls promote on all of the entities it contains. Base implementation uses the entity registry.</p> <p>RECOMMENDATION: Do not override.</p>
public void	<p>publish(Rowset p_changesRS, boolean p_onlineMode): Takes a PSCAMA based rowset of information to be published during workflow Uses that information to construct a Message and according to the onlineMode publishes the Message data in realtime or to the batch delay table.</p> <p>RECOMMENDATION: Override if publish logic is required.</p>
public Rowset	<p>retrieveDataRule(): Uses the entityID and Update Rule Name to read Data Update Rule information.</p> <p>RECOMMENDATION: Do not override.</p>
public void	<p>save(MessageLogBase p_messageLog out): Base implementation, calls presave and issues save for all children then a save for this entity.</p> <p>RECOMMENDATION: Do not override.</p>
protected void	<p>saveChildren(MessageLogBase p_messageLog out): Iterates through the ChildEntityArray and issues a Save against each ChildEntity, which in turn calls Save on all of the entities it contains. Base implementation uses the entity registry.</p> <p>RECOMMENDATION: Do not override.</p>
public void	<p>setChildren(): Builds out the ChildEntityArray based on the entity registry.</p> <p>RECOMMENDATION: Do not override.</p>

protected void	<p>setData(Record p_dataRec): Sets the Data record.</p> <p>RECOMMENDATION: Do not override.</p>
protected void	<p>setDataPreImage(Record p_dataPreImageRec): Sets the Data preimage.</p> <p>RECOMMENDATION: Do not override.</p>
public void	<p>setDefault(): Base implementation sets the default value for each field using the Field setDefault method if the field has not already been marked changed.</p> <p>RECOMMENDATION: Override if required</p>
protected void	<p>setEntityID(string p_entityID): Sets the entity ID, and retrieves the related information from the registry.</p> <p>RECOMMENDATION: Do not override.</p>
protected void	<p>setKeyList(): Sets the list of key fields to private instance variable keyList.</p> <p>RECOMMENDATION: Do not override.</p>
public void	<p>setProperty(string propName, any value)</p>
protected void	<p>setPropertyByMetaRec(Record propMetaRec, any value)</p>
public void	<p>setStageMode(boolean p_stageInd): Sets the stage mode and changes the underlying record to stage/production for this entity and all children. This implementation does nothing since stage mode is not required.</p> <p>RECOMMENDATION: Override if the entity is Staged.</p>
public void	<p>setUpdateRule(string p_UpdateRule): Sets a specific update rule.</p> <p>RECOMMENDATION: Do not override.</p>
public void	<p>setUpdateRuleByTransName(string p_transName): Sets the update rule based on the transaction name in the setup table.</p> <p>RECOMMENDATION: Do not override.</p>

public void	<p>setUserContext(string p_userContext): Sets the user context for this entity.</p> <p>RECOMMENDATION: Do not override.</p>
protected void	<p>testForAudit(): Checks if the underlying record has the audit fields and sets the property hasAudit.</p> <p>RECOMMENDATION: Do not override.</p>
public void	<p>toXmlNode(XmlNode parentNode): Pushes data to the XML structure from the entity. Fields marked ignore are not Processed. Entity Element Names, wrapping of the ChildEntities or embedding is based on the entity registry. The value of properties corresponding to the fields are pushed.</p> <p>RECOMMENDATION: Only override if the xml for this entity has to be custom.</p>
protected void	<p>toXmlNodeChildren(XmlNode parentNode): Iterates through the ChildEntityArray and issues a toXmlNode against each ChildEntity, which in turn calls toXmlNode on all of the entities it contains. Base implementation uses the entity registry.</p> <p>RECOMMENDATION: Do not override.</p>
public void	<p>updateChildFields(string propName, array of ChildEntity cea): Sets the value of a specific property on all ChildEntities to match the current entity.</p> <p>RECOMMENDATION: Do not override.</p>
public void	<p>updateFromRecord(Record rec): Updates by matching fields in the record to fields in the underlying record on the entity. Values are only set if the value has changed. Values are set using properties, so any additional get-set logic is handled.</p>
protected void	<p>updateKeyFields(): Updates all the key fields of the child entities that match the key fields on this entity.</p> <p>RECOMMENDATION: Do not override.</p>

public void	<p>validate(MessageLogBase p_messageLog out): Validates the entity object if entity is not marked for deletion. NOTE: commonValidate invokes validateChildren. validateChildren is called before record based validations.</p> <p>RECOMMENDATION: Override this method if the entity requires custom validation. Use commonValidate to call the system edits for control over exactly which edits run, or %Super. Validate if you want them all.-- This method does the following standard system edits:- Required fields are present- Validates all 1/0 fields contain only a 1 or a 0- Validates all translate fields have a valid value- Validates all YesNo fields contain a Y or an N- Validates all prompt edit fields have a valid value.</p>
protected void	<p>validateChildren(MessageLogBase p_messageLog out): Iterates through the ChildEntityArray and issues a validate against each ChildEntity, which in turn calls validate on all of the entities it contains. Base implementation uses the entity registry.</p> <p>RECOMMENDATION: Do not override.</p>
public void	<p>validateFirst(MessageLogBase p_messageLog out): Allows validations to be performed on all entities under a childEntity; this is valuable in doing validation against other entities under the same childEntity.</p> <p>RECOMMENDATION: Override this method if the entity requires custom validation crossing entity boundaries.</p>
public void	<p>workflow(boolean p_onlineMode): Orchestrates the prepublish and publish methods for this entity and all children.</p> <p>RECOMMENDATION: Do not override.</p>

Details

Property Details:

baseProps	public Array of string
ChildEntityArray	public Array of ChildEntity
data	public Record

dataPreimage	public Record
DO_SAVE	public boolean
dynamicProperties	protected AnyHashMap
entityDelete	public boolean
entityID	public string
EntityMetaData	protected Record
entityName	public string
hasAuditRowAddDttm	protected boolean
hasAuditRowAddOprid	protected boolean
hasAuditRowUpdDttm	protected boolean
hasAuditRowUpdOprid	protected boolean
ignoreFields	protected Array of string
keyCollection	public Array of DataKey
parent	public IEntity
parentCE	public ChildEntity
prodRecordName	public string
PropertyMetaData	protected Rowset
RECORD_NAME	protected string
SCC_ENTITY_INST_ID	public string
SCC_ROW_ADD_DTTM	public datetime

SCC_ROW_ADD_OPRID	public string
SCC_ROW_UPD_DTTM	public datetime
SCC_ROW_UPD_OPRID	public string
selfServiceMode	public boolean
STAGE_MODE	public boolean
UPDATE_RULE	public string
USER_CONTEXT	public string
workflowPreimage	public Record
XSDCustomNS	protected string
XSDFieldList	public Array of string
XSDNS	protected string

Constructor Details:

AbstractEntity	<p>Parameters:</p> <p>IEntity p_parent: The parent of this entity, or null if this is the top of the entity tree.</p>
----------------	---

Method Details:

applyDataKey	<p>Parameters:</p> <p>string p_queryString</p> <p>Return:</p> <p>string</p>
--------------	---

buildCSVString	<p>Parameters:</p> <p>array of any p_arrValues</p> <p>string p_metaTag</p> <p>Return:</p> <p>string</p>
buildPropertyMetaDataCache	N/A
buildXSD	<p>Parameters:</p> <p>XmlNode xmlnode: The Tools XmlNode object of the parent that should be continued by this entity.</p>
buildXSDChildren	<p>Parameters:</p> <p>XmlNode xmlnode: The node of the current entity that all children see as the parent.</p>
changeRecord	<p>Parameters:</p> <p>string p_recname: The name of the record to have this entity use.</p>
clearDataPreImage	N/A
clearDataPreImageChildren	N/A
commonValidate	<p>Parameters:</p> <p>MessageLogBase p_messageLog(out): The message log to log any errors to.</p> <p>number p_validateArgs: Specify the validations to be run in a format like (%Edit_DateRange + %Edit_OneZero +Edit_Required).</p>
defaultChildren	N/A
delete	<p>Parameters:</p> <p>boolean p_entityDelete: True to delete this entity and False to "undelete".</p>

deleteChildren	Parameters: boolean p_entityDelete: True to delete this entity and False to "undelete".
demote	Parameters: number p_tempID: The tempid to replace the emplid with.
demoteChildren	Parameters: number p_tempID: The Tempid to associated with all demoted data.
destroy	N/A
entityFieldUpdateNeeded	Parameters: Rowset p_DataUpdateRule string p_fieldName any oldValue Return: boolean
entityTypeUpdateNeeded	Parameters: Rowset p_DataUpdateRule any p_entityType boolean p_newFlag Return: boolean – True if the Data Update Rule specifies the entity type should be updated.

entityTypeUpdateRequested	<p>Parameters:</p> <p>Rowset p_DataUpdateRule: The data update rule.</p> <p>any p_entityType: The entity type value (for example, For the Address entity, type values include: DORM, HOME, MAIL, and so on.)</p> <p>Return:</p> <p>boolean - True if any row of the Data Update Rule Detail (for this entity AND type) has an action not equal to "Do Not Update" (N).</p>
entityUpdateRequested	<p>Parameters:</p> <p>Rowset p_DataUpdateRule: The data update rule.</p> <p>Return:</p> <p>boolean - True if any row of the Data Update Rule Detail (for this entity) has an action not equal to "Do Not Update" (N).</p>
fill	<p>Parameters:</p> <p>Record p_inRec(out): The record structure that is used to populate this entity.</p> <p>boolean p_clearState: Whether or not to RESET this entities pre-image.</p>
fillChildren	<p>Parameters:</p> <p>boolean p_clearState</p>
fillFromKeys	<p>Parameters:</p> <p>boolean p_clearState: Whether or not to RESET this entities pre-image.</p>
fillLOVDescrs	N/A
fromXmlNode	<p>Parameters:</p> <p>XmlNode parentNode: The parent node to add this node to.</p>

fromXmlNodeChildren	<p>Parameters:</p> <p>XmlNode parentNode: The node of the current entity that all children see as the parent.</p>
generateRowset	<p>Return:</p> <p>Rowset - a rowset populated based on the parent keys, or null if no rows are found.</p>
generateXSD	<p>Return:</p> <p>string - the XML Schema as a string.</p>
getChildEntity	<p>Parameters:</p> <p>string p_entityID: The entity ID, based on the registry, of the ChildEntity object to retrieve.</p> <p>Return:</p> <p>ChildEntity</p>
getCSUserDefaults	<p>Return:</p> <p>CSUserDefaults</p>
getDataKey	<p>Return:</p> <p>DataKey</p>
getEntPropsByPropertyName	<p>Parameters:</p> <p>string propName: The property name.</p> <p>Return:</p> <p>Record</p>
getFullEntityPathName	<p>Return:</p> <p>string</p>
getIgnoreFields	<p>Return:</p> <p>array of string</p>

getInstallationHCM	Return: InstallationHCM
getLOVDescr	Parameters: string propName: The property name to get a LOV Description based on. Return: string
getLOVValue	Parameters: Record p_recProp string p_code Return: string
getMaxSeqNbrSQL	Return: number - the maximum sequence number found.
getParent	Return: IEntity
getProperty	Parameters: string propName Return: any
getPropertyByMetaRec	Parameters: Record propMetaRec Return: any
getRecordName	Return: string - The record name

getTagByFieldName	<p>Parameters:</p> <p>string fieldname: The fieldname to search on.</p> <p>Return:</p> <p>string</p>
hardDelete	<p>Parameters:</p> <p>MessageLogBase p_messageLog(out): the message log</p>
hardDeleteChildren	<p>Parameters:</p> <p>MessageLogBase p_messageLog(out): the message log</p>
hasEffdt	<p>Return:</p> <p>boolean</p>
hasEffseq	<p>Return:</p> <p>boolean</p>
hasKey	<p>Parameters:</p> <p>string p_keyname: The name of the field to check.</p> <p>Return:</p> <p>boolean - true, the field exists and is a key, false, the field is not a key, or does not exist.</p>
isEqualKeys	<p>Parameters:</p> <p>IEntity p_entity</p> <p>Return:</p> <p>boolean</p>
isEqualKeysRecord	<p>Parameters:</p> <p>Record p_rec</p> <p>Return:</p> <p>boolean</p>

populateAudit	
prePublish	Parameters: Rowset p_changesRS(out)
preSave	N/A
preSaveChildren	N/A
preSaveFirst	N/A
promote	Parameters: string p_emplID MessageLogBase p_log(out): The MessageLog object to log all errors/warnings to.
promoteChildren	Parameters: string p_emplID: The EMPLID key to associate with the promoted data. MessageLogBase p_log(out)
publish	Parameters: Rowset p_changesRS boolean p_onlineMode
retrieveDataRule	Return: Rowset - the Data Update Rule information for the current entity in a rowset (Level 0 - SCC_DUR_HDR, Level 1 - SCC_DUR_DTL).
save	Parameters: MessageLogBase p_messageLog(out): the message log
saveChildren	MessageLogBase p_messageLog(out): the message log
setChildren	N/A

setData	Parameters: Record p_dataRec: The record to set data to.
setDataPreImage	Parameters: Record p_dataPreImageRec: The preimage record to set.
setDefault	N/A
setEntityID	Parameters: string p_entityID: The ID of the Entity.
setKeyList	N/A
setProperty	Parameters: string propName any value
setPropertyByMetaRec	Parameters: Record propMetaRec any value
setStageMode	Parameters: boolean p_stageInd: Set to stage (true) or production (false).
setUpdateRule	Parameters: string p_UpdateRule: The specific update rule.
setUpdateRuleByTransName	Parameters: string p_transName: The transaction name.
setUserContext	Parameters: string p_userContext: The user context to set. An empty string sets the context to %UserId.
testForAudit	N/A

toXmlNode	Parameters: XmlNode parentNode: The parent node of this node.
toXmlNodeChildren	Parameters: XmlNode parentNode: The node of the current entity that all children see as the parent.
updateChildFields	Parameters: string propName: The name of the property to update. array of ChildEntity cea: The array of child entities (and their children down the tree) to set the property on.
updateFromRecord	Parameters: Record rec: The record object to copy data from.
updateKeyFields	N/A
validate	Parameters: MessageLogBase p_messageLog(out): The container for all the messages that are generated by this method.
validateChildren	Parameters: MessageLogBase p_messageLog(out): The message log.
validateFirst	Parameters: MessageLogBase p_messageLog(out): The container for all the messages that are generated by this method.
workflow	Parameters: boolean p_onlineMode

class SCC_COMMON:Audit

Implementing Classes:

- SCC_COMMON:ENTITY:AbstractEntity
- SCC_COMMON:ENTITY:BasicEntity

- SCC_COMMON:ENTITY:StagedEntity
- SCC_COMMON:ENTITY:ATTRIBUTES:BaseStagedAttribute

class SCC_COMMON_UTIL:BitArray

class SCC_COMMON:ENTITY:BasicEntity

SCC_COMMON:ENTITY:AbstractEntity -- SCC_COMMON:ENTITY:BasicEntity

Direct Known Subclasses: SCC_COMMON:ENTITY:GENERIC:GenericBasicEntity, SCC_COMMON:ENTITY:API:EntityUnitTest, SCC_COMMON:ENTITY:API:EntityRegistry, SCC_COMMON:ENTITY:API:EntityType, SCC_COMMON:ENTITY:API:EntityChild, SCC_COMMON:ENTITY:API:EntityProperty, SCC_COMMON:SHOPCART:ShoppingCartItem, SCC_COMMON:ENTITY:API:EntityTypeChild

Summary

Property Summary:

public boolean	STAGE_MODE
Properties Inherited from SCC_COMMON:ENTITY:AbstractEntity	baseProps, ChildEntityArray, data, dataPreimage, DO_SAVE, dynamicProperties, entityDelete, entityID, EntityMetaData, entityName, hasAuditRowAddDttm, hasAuditRowAddOprid, hasAuditRowUpdDttm, hasAuditRowUpdOprid, ignoreFields, keyCollection, parent, parentCE, prodRecordName, PropertyMetaData, RECORD_NAME, SCC_ENTITY_INST_ID, SCC_ROW_ADD_DTTM, SCC_ROW_ADD_OPRID, SCC_ROW_UPD_DTTM, SCC_ROW_UPD_OPRID, selfServiceMode, UPDATE_RULE, USER_CONTEXT, workflowPreimage, XSDCustomNS, XSDFieldList, XSDNS

Constructor Summary:

public void	BasicEntity(IEntity p_parent): Base Constructor
-------------	---

Method Summary:

public void	demote(number p_tempID): This method does nothing since this entity is not staged, but it has to be implemented.
-------------	--

public void	promote(string p_emplID, MessageLogBase p_log out): This method does nothing since this entity is not staged, but it has to be implemented.
Methods Inherited from SCC_COMMON:ENTITY:AbstractEntity	applyDataKey, buildCSVString, buildPropertyMetaDataCache, buildXSD, buildXSDChildren, changeRecord, clearDataPreImage, clearDataPreImageChildren, commonValidate, defaultChildren, delete, deleteChildren, demoteChildren, destroy, entityTypeUpdateNeeded, entityTypeUpdateRequested, entityTypeUpdateRequested, entityUpdateRequested, fill, fillChildren, fillFromKeys, fillLOVDescrs, fromXmlNode, fromXmlNodeChildren, generateRowset, generateXSD, getChildEntity, getCSUserDefaults, getDataKey, getEntPropsByPropertyName, getFullEntityPathName, getIgnoreFields, getInstallationHCM, getLOVDescr, getLOVValue, getMaxSeqNbrSQL, getParent, getProperty, getPropertyByMetaRec, getRecordName, getTagByFieldName, hardDelete, hardDeleteChildren, hasEffdt, hasEffseq, hasKey, isEqualKeys, isEqualKeysRecord, populateAudit, prePublish, preSave, preSaveChildren, preSaveFirst, promoteChildren, publish, retrieveDataRule, save, saveChildren, setChildren, setData, setDataPreImage, setDefault, setEntityID, setKeyList, setProperty, setPropertyByMetaRec, setStageMode, setUpdateRule, setUpdateRuleByTransName, setUserContext, testForAudit, toXmlNode, toXmlNodeChildren, updateChildFields, updateFromRecord, updateKeyFields, validate, validateChildren, validateFirst, workflow

Details

Property Details:

STAGE_MODE	public boolean
------------	----------------

Constructor Details:

Basic Entity	<p>Parameters:</p> <p>IEntity p_parent: the parent of this entity, or null if this is the top of the entity tree.</p>
--------------	---

Method Details:

demote	Parameters: number p_tempID
promote	Parameters: string p_emplID MessageLogBase p_log(out)

class SCC_COMMON:ENTITY:StagedEntity

SCC_COMMON:ENTITY:AbstractEntity -- SCC_COMMON:ENTITY:StagedEntity

Direct Known Subclasses: SCC_COMMON:ENTITY:GENERIC:GenericStagedEntity

Summary

Property Summary:

public boolean	DO_SAVE_CHILDREN: Specifies if the children should be saved.
public string	EMPLID: Builds the xml schema section pertaining to this entity. The implementation builds and populates the schema based on the underlying record, ignoring any fields in the ignore array. Keys that roll down from the parent are not marked required on the child. RECOMMENDATION: Only override if the entity requires a custom schema. @param xmlnode: The Tools XmlNode object of the parent that should be continued by this entity.
public string	entityID: The entity ID based on the entity registry.
public string	entityName: The entity Name as specified in the registry.
public string	PROD_RECORD_NAME: The Production Record name from the registry.
public number	SCC_TEMP_ID: The property for the tempid field on stage records.
public string	STAGE_RECORD_NAME: The Stage Record name from the registry.

Properties Inherited from SCC_COMMON:ENTITY:AbstractEntity	baseProps, ChildEntityArray, data, dataPreimage, DO_SAVE, dynamicProperties, entityDelete, EntityMetaData, hasAuditRowAddDttm, hasAuditRowAddOprid, hasAuditRowUpdDttm, hasAuditRowUpdOprid, ignoreFields, keyCollection, parent, parentCE, prodRecordName, PropertyMetaData, RECORD_NAME, SCC_ENTITY_INST_ID, SCC_ROW_ADD_DTTM, SCC_ROW_ADD_OPRID, SCC_ROW_UPD_DTTM, SCC_ROW_UPD_OPRID, selfServiceMode, STAGE_MODE, UPDATE_RULE, USER_CONTEXT, workflowPreimage, XSDCustomNS, XSDFieldList, XSDNS
--	---

Constructor Summary:

public void	StagedEntity(IEntity p_parent): The Constructor
-------------	---

Method Summary:

public void	comparePreviousEffdt(): Compares the current record underlying this entity with previous effective dated rows. If no data has changed between this entity and the current effective dated row it prevents a save from occurring. This only matters when we are dealing with effective dated entities. RECOMMENDATION: Do not override.
public void	demote(number p_tempID): Moves data from production records to staging record. RECOMMENDATION: Do not override.
public string	getID(): Retrieves the temp ID.
protected string	getProdRecordName(): Retrieves the production record name.
protected string	getStageRecordName(): Retrieves the stage record name.
public void	promote(string p_emplID, MessageLogBase p_log out): Moves Data from Staging to Production Records (does not validate or save). RECOMMENDATION: Do not override.

public void	<p>save(MessageLogBase p_messageLog out): Calls presave and issues save for all children then a save for this entity.</p> <p>RECOMMENDATION: Do not override.</p>
protected void	<p>setEntityID(string p_entityID): Sets the entity ID, and retrieves the related information from the registry.</p> <p>RECOMMENDATION: Do not override.</p>
public void	<p>setID(string p_ID): Sets the temp id for this entity.</p> <p>RECOMMENDATION: Do not override.</p>
public void	<p>setStageMode(boolean p_stageInd): Sets the stage mode and changes the underlying record to stage/production for this entity and all children.</p> <p>RECOMMENDATION: Do not override.</p>
Methods Inherited from SCC_ COMMON:ENTITY:AbstractEntity	<p>applyDataKey, buildCSVString, buildPropertyMetaDataCache, buildXSD, buildXSDChildren, changeRecord, clearDataPreImage, clearDataPreImageChildren, commonValidate, defaultChildren, delete, deleteChildren, demoteChildren, destroy, entityTypeUpdateNeeded, entityTypeUpdateRequested, entityTypeUpdateRequested, fill, fillChildren, fillFromKeys, fillLOVDescrs, fromXmlNode, fromXmlNodeChildren, generateRowset, generateXSD, getChildEntity, getCSUserDefaults, getDataKey, getEntPropsByPropertyName, getFullEntityPathName, getIgnoreFields, getInstallationHCM, getLOVDescr, getLOVValue, getMaxSeqNbrSQL, getParent, getProperty, getPropertyByMetaRec, getRecordName, getTagByFieldName, hardDelete, hardDeleteChildren, hasEffdt, hasEffseq, hasKey, isEqualKeys, isEqualKeysRecord, populateAudit, prePublish, preSave, preSaveChildren, preSaveFirst, promoteChildren, publish, retrieveDataRule, saveChildren, setChildren, setData, setDataPreImage, setDefault, setKeyList, setProperty, setPropertyByMetaRec, setUpdateRule, setUpdateRuleByTransName, setUserContext, testForAudit, toXmlNode, toXmlNodeChildren, updateChildFields, updateFromRecord, updateKeyFields, validate, validateChildren, validateFirst, workflow</p>

Details

Property Details:

DO_SAVE_CHILDREN	public boolean
EMPLID	public string
entityID	public string
entityName	public string
PROD_RECORD_NAME	public string
SCC_TEMP_ID	public number
STAGE_RECORD_NAME	public string

Constructor Details:

StagedEntity	<p>Parameters:</p> <p>IEntity p_parent: the parent of this entity, or null if this is the top of the entity tree.</p>
--------------	---

Method Details:

comparePreviousEffdt	
demote	<p>Parameters:</p> <p>number p_tempID: The tempid to replace the emplid with.</p>
getID	<p>Return:</p> <p>string - the tempID</p>
getProdRecordName	<p>Return:</p> <p>string</p>
getStageRecordName	<p>Return:</p> <p>string</p>

promote	<p>Parameters:</p> <p>string p_emplID</p> <p>MessageLogBase p_log(out): The MessageLog object to log all errors/warnings to.</p>
save	<p>Parameters:</p> <p>MessageLogBase p_messageLog(out): The message log.</p>
setEntityID	<p>Parameters:</p> <p>string p_entityID: The ID of the Entity.</p>
setID	<p>Parameters:</p> <p>string p_ID: The temporary ID value to set.</p>
setStageMode	<p>Parameters:</p> <p>boolean p_stageInd: Set to stage (true) or production (false).</p>

abstract class SCC_COMMON:ENTITY:StagedHREntity

SCC_COMMON:ENTITY:AbstractEntity -- SCC_COMMON:ENTITY:StagedHREntity

Summary

Property Summary:

public string	<p>EMPLID: Builds the xml schema section pertaining to this entity. The implementation builds and populates the schema based on the underlying record, ignoring any fields in the ignore array. Keys that roll down from the parent are not marked required on the child.</p> <p>RECOMMENDATION: Only override if the entity requires a custom schema. @param xmlnode: The Tools XmlNode object of the parent that should be continued by this entity.</p>
public string	entityID: The entity ID based on the entity registry.
public string	entityName: The entity Name as specified in the registry.

public string	PROD_RECORD_NAME: The Production Record name from the registry.
public number	SCC_TEMP_ID: The property for the tempid field on stage records.
public string	STAGE_RECORD_NAME: The Stage Record name from the registry.
Properties Inherited from SCC_COMMON:ENTITY:AbstractEntity	baseProps, ChildEntityArray, data, dataPreimage, DO_SAVE, dynamicProperties, entityDelete, EntityMetaData, hasAuditRowAddDttm, hasAuditRowAddOprid, hasAuditRowUpdDttm, hasAuditRowUpdOprid, ignoreFields, keyCollection, parent, parentCE, prodRecordName, PropertyMetaData, RECORD_NAME, SCC_ENTITY_INST_ID, SCC_ROW_ADD_DTTM, SCC_ROW_ADD_OPRID, SCC_ROW_UPD_DTTM, SCC_ROW_UPD_OPRID, selfServiceMode, STAGE_MODE, UPDATE_RULE, USER_CONTEXT, workflowPreimage, XSDCustomNS, XSDFieldList, XSDNS

Constructor Summary:

public void	StagedHREntity(IEntity p_parent): The Constructor
-------------	---

Method Summary:

public void	demote(number p_tempID): Moves data from production records to staging record. RECOMMENDATION: Do not override.
public baseType	getHRType(string p_EMPLID): Builds the HCR_PERSON_TYPES object based on the data in the current entity using the emplid provided.
public string	getID(): Retrieves the temp ID.
protected ServiceManager	getServiceManager(): Returns the HCM ServiceManager object.

public void	<p>hardDelete(MessageLogBase p_messageLog out): Deletes the entity object and all its child entities from the database, based on the entityDelete flag.</p> <p>RECOMMENDATION: Do not override this method</p>
public void	<p>promote(string p_emplID, MessageLogBase p_log out): Moves Data from Staging to Production Records (does not validate or save).</p> <p>RECOMMENDATION: Do not override.</p>
public void	<p>save(MessageLogBase p_messageLog out): Calls presave and issues save for all children then a save for this entity. On save for production it invokes updateDeleteHcm to call the HCM Web Service.</p> <p>RECOMMENDATION: Do not override.</p>
protected void	<p>setEntityID(string p_entityID): Sets the entity ID, and retrieves the related information from the registry.</p> <p>RECOMMENDATION: Do not override.</p>
public void	<p>setID(string p_ID): Sets the temp id for this entity.</p> <p>RECOMMENDATION: Do not override.</p>
public void	<p>setStageMode(boolean p_stageInd): Sets the stage mode and changes the underlying record to stage/production for this entity and all children.</p> <p>RECOMMENDATION: Do not override.</p>
protected void	<p>updateDeleteHCM(boolean p_deleteFlag): This method is called from save, it should perform the update for production data by calling the HCM service.</p>

Methods Inherited from SCC_ COMMON:ENTITY:AbstractEntity	applyDataKey, buildCSVString, buildPropertyMetaDataCache, buildXSD, buildXSDChildren, changeRecord, clearDataPreImage, clearDataPreImageChildren, commonValidate, defaultChildren, delete, deleteChildren, demoteChildren, destroy, entityFieldUpdateNeeded, entityTypeUpdateNeeded, entityTypeUpdateRequested, entityUpdateRequested, fill, fillChildren, fillFromKeys, fillLOVDescrs, fromXmlNode, fromXmlNodeChildren, generateRowset, generateXSD, getChildEntity, getCSUserDefaults, getDataKey, getEntPropsByPropertyName, getFullEntityPathName, getIgnoreFields, getInstallationHCM, getLOVDescr, getLOVValue, getMaxSeqNbrSQL, getParent, getProperty, getPropertyByMetaRec, getRecordName, getTagByFieldName, hardDeleteChildren, hasEffdt, hasEffseq, hasKey, isEqualKeys, isEqualKeysRecord, populateAudit, prePublish, preSave, preSaveChildren, preSaveFirst, promoteChildren, publish, retrieveDataRule, saveChildren, setChildren, setData, setDataPreImage, setDefault, setKeyList, setProperty, setPropertyByMetaRec, setUpdateRule, setUpdateRuleByTransName, setUserContext, testForAudit, toXmlNode, toXmlNodeChildren, updateChildFields, updateFromRecord, updateKeyFields, validate, validateChildren, validateFirst, workflow
---	---

Details

Property Details:

EMPLID	public string
entityID	public string
entityName	public string
PROD_RECORD_NAME	public string
SCC_TEMP_ID	public number
STAGE_RECORD_NAME	public string

Constructor Details:

StagedHREntity	Parameters: Entity p_parent: The parent of this entity, or null if this is the top of the entity tree.
----------------	---

Method Details:

demote	Parameters: number p_tempID: The tempid to replace the emplid with.
getHRType	Parameters: string p_EMPLID: The emplid to use for the PERSON_TYPE. Return: baseType
getID	Return: string - the tempID
getServiceManager	Return: ServiceManager
hardDelete	Parameters: MessageLogBase p_messageLog(out):the message log
promote	Parameters: string p_emplID MessageLogBase p_log(out): The MessageLog object to log all errors/warnings to.
save	Parameters: MessageLogBase p_messageLog(out): The message log.
setEntityID	Parameters: string p_entityID: The ID of the Entity.

setID	Parameters: string p_ID: The temporary ID value to set.
setStageMode	Parameters: boolean p_stageInd: Set to stage (true) or production (false).
updateDeleteHCM	Parameters: boolean p_deleteFlag: Specifies if the entity should be deleted.

class SCC_COMMON:ENTITY:WorkEntity

SCC_COMMON:ENTITY:AbstractEntity -- SCC_COMMON:ENTITY:WorkEntity

Direct Known Subclasses: SCC_COMMON:SHOPCART:ShoppingCart,
SCC_COMMON:ENTITY:GENERIC:GenericWorkEntity

Summary

Property Summary:

public boolean	STAGE_MODE
Properties Inherited from SCC_COMMON:ENTITY:AbstractEntity	baseProps, ChildEntityArray, data, dataPreimage, DO_SAVE, dynamicProperties, entityDelete, entityID, EntityMetaData, entityName, hasAuditRowAddDttm, hasAuditRowAddOprid, hasAuditRowUpdDttm, hasAuditRowUpdOprid, ignoreFields, keyCollection, parent, parentCE, prodRecordName, PropertyMetaData, RECORD_NAME, SCC_ENTITY_INST_ID, SCC_ROW_ADD_DTTM, SCC_ROW_ADD_OPRID, SCC_ROW_UPD_DTTM, SCC_ROW_UPD_OPRID, selfServiceMode, UPDATE_RULE, USER_CONTEXT, workflowPreimage, XSDCustomNS, XSDFieldList, XSDNS

Constructor Summary:

public void	WorkEntity(IEntity p_parent): Base Constructor
-------------	--

Method Summary:

public void	demote(number p_tempID): This method does nothing since this entity is not staged, but it has to be implemented.
-------------	--

public rowset	generateRowset()
public void	hardDelete(MessageLogBase p_messageLog out)
public void	promote(string p_emplID, MessageLogBase p_log out): This method does nothing since this entity is not staged, but it has to be implemented.
public void	save(MessageLogBase p_messageLog out)
Methods Inherited from SCC_COMMON:ENTITY:AbstractEntity	applyDataKey, buildCSVString, buildPropertyMetaDataCache, buildXSD, buildXSDChildren, changeRecord, clearDataPreImage, clearDataPreImageChildren, commonValidate, defaultChildren, delete, deleteChildren, demoteChildren, destroy, entityTypeUpdateNeeded, entityTypeUpdateRequested, entityTypeUpdateRequested, fill, fillChildren, fillFromKeys, fillLOVDescrs, fromXmlNode, fromXmlNodeChildren, generateXSD, getChildEntity, getCSUserDefaults, getDataKey, getEntPropsByPropertyName, getFullEntityPathName, getIgnoreFields, getInstallationHCM, getLOVDescr, getLOVValue, getMaxSeqNbrSQL, getParent, getProperty, getPropertyByMetaRec, getRecordName, getTagByFieldName, hardDeleteChildren, hasEffdt, hasEffseq, hasKey, isEqualKeys, isEqualKeysRecord, populateAudit, prePublish, preSave, preSaveChildren, preSaveFirst, promoteChildren, publish, retrieveDataRule, saveChildren, setChildren, setData, setDataPreImage, setDefault, setEntityID, setKeyList, setProperty, setPropertyByMetaRec, setStageMode, setUpdateRule, setUpdateRuleByTransName, setUserContext, testForAudit, toXmlNode, toXmlNodeChildren, updateChildFields, updateFromRecord, updateKeyFields, validate, validateChildren, validateFirst, workflow

Details

Property Details:

STAGE_MODE	public boolean
------------	----------------

Constructor Details:

WorkEntity	Parameters: IEntity p_parent: The parent of this entity, or null if this is the top of the entity tree.
------------	--

Method Details:

demote	Parameters: number p_tempID
generateRowset	Return: Rowset
hardDelete	Parameters: MessageLogBase p_messageLog(out)
promote	Parameters: string p_emplID MessageLogBase p_log(out)
save	Parameters: MessageLogBase p_messageLog(out)

class SCC_COMMON:ENTITY:ChildEntity

Summary and Details:

Summary*Property Summary:*

public Array of IEntity	childEntities: An array of all child entities of a specific type.
public string	className: The name of the appclass the entities under this childEntity implement.
public string	elementName: The element name to use for each entity.

public boolean	Embed: Specifies if the Entities this child contains have been marked for embedding in the parent entity.
public string	Encapsulate: The name of the tag to use to encapsulate all entities in this childEntity object.
public string	EntityID: The Entity ID for the entities under this childEntity.
public string	EntityName: The Entity Name for the entities under this childEntity.
public string	MaxCount: The maximum number of entities of this type allowed based on the registry.
public number	MaxSeqNbr: The current maximum sequence number, if this entity has a key that is a sequence number.
public string	MinCount: The minimum number of entities of this type allowed based on the registry.
public IEntity	parent: The parent of this ChildEntity.
public string	PROD_RECORD: The name of the production record the entities under this childEntity implement.
public boolean	STAGE_MODE: The current stage state of the entities, true=staged, false=production.
public string	STAGE_RECORD: The name of the stage record the entities under this childEntity implement.

Constructor Summary:

public void	ChildEntity()
-------------	---------------

Method Summary:

public void	buildXSD(XmlNode xmlnode): The method to build the schema for this entity, works in conjunction with the method of the same name on the entity.
-------------	---

public void	checkForDupes(MessageLogBase p_messageLog out): Checks for entities with duplicate keys in the childEntities array.
public void	clearDataPreImage(): Invokes clearDataPreImage on all entities in childEntities.
public void	clearEntities(): Resets the childEntities array to empty.
public void	copyFromRowset(Rowset rs): Copies the record data from a rowset into childEntities. If the keys match it, an existing entity is updated. Otherwise, an entity is added. Data is copied field by field into the equivalent properties. This means any logic in get-set is executed. In the case of update-only fields where values have changed, they are updated. Properties are copied based on matching the underlying field names.
public Rowset	copyToRowset(): Copies all the records in childEntities to a rowset.
public IEntity	createEntity(): Create an instance of the entity based on the className.
public void	default(): Invokes setDefault on all entities in childEntities.
public void	delete(boolean p_entityDelete): Invokes delete on all entities in childEntities.
public void	demote(number p_tempID): Invokes demote on all entities in childEntities.
public void	destroy(): Perform cleanup activity on this entity.
public void	fill(boolean p_clearstate): Invokes fill on all entities in childEntities.
public IEntity	findKeyMatchingEntity(Record rec): Finds the entity with keys that match the given record.
public void	fromXMLNode(XmlNode parentnode): Invokes fromXMLNode on all entities in childEntities.

public array of IEntity	getEntitiesByProperties(array of PStruct pstructs): Returns all entities in the childEntities array where the properties provided match.
public array of IEntity	getEntitiesByProperty(PStruct pstruct): Returns all entities in the childEntities array where the property provided matches.
public IEntity	getEntityByProperties(array of PStruct pstructs): Returns a specific entity in the childEntities array where all properties provided match.
public IEntity	getEntityByPropertiesEffdt(array of PStruct pstructs, date asOfDate): Returns a specific entity in the childEntities array where all properties provided match and the entity is the current entity as of a specific effective date.
public IEntity	getEntityByProperty(PStruct pstruct): Returns a specific entity in the childEntities array where a property matches that requested.
public number	getNextSeqNbr(string fieldname, array of IEntity entities): Provides the next sequence number for a specified fieldname out of a specific array of entities. Setting the array allows the entities to be a subset of childEntities.
public Rowset	getRowset(): Builds an empty rowset of stage or production based on the STAGE_MODE.
public void	hardDelete(MessageLogBase p_messageLog out): Invokes hardDelete on all entities in childEntities.
public void	preSave(): Invokes presaveFirst on the first entity in childEntities and presave on all entities in childEntities.
public void	promote(string p_emplID, MessageLogBase p_messageLog out): Invokes promote on all entities in childEntities.
public void	save(MessageLogBase p_messageLog out): Invokes save on all entities in childEntities.
public void	toXMLNode(XmlNode parentnode): Invokes toXMLNode on all entities in childEntities.

public void	validate(MessageLogBase p_messageLog out): Invokes validate on all entities in childEntities.
public void	workflow(boolean p_onlineMode): Invokes all the workflow methods in childEntities.

Details

Property Details:

childEntities	public Array of IEntity
className	public string
elementName	public string
Embed	public boolean
Encapsulate	public string
EntityID	public string
EntityName	public string
MaxCount	public string
MaxSeqNbr	public number
MinCount	public string
parent	public IEntity
PROD_RECORD	public string
STAGE_MODE	public boolean
STAGE_RECORD	public string

Constructor Details:

ChildEntity	N/A
-------------	-----

Method Details:

buildXSD	Parameters: XmlNode xmlnode: The XmlNode object from the parent to add the schema elements to.
checkForDupes	Parameters: MessageLogBase p_messageLog(out)
clearDataPreImage	N/A
clearEntities	N/A
copyFromRowset	Parameters: Rowset rs: The rowset to copy data from.
copyToRowset	Return: Rowset
createEntity	Return: IEntity
default	N/A
delete	Parameters: boolean p_entityDelete: The delete state passed from the parent to the child.
demote	Parameters: number p_tempID: The tempID to set on the records when the data is demoted.
destroy	N/A

fill	Parameters: boolean p_clearstate: Specifies if the preImage should be set.
findKeyMatchingEntity	Parameters: Record rec: The record to use when searching for a match. Return: IEntity
fromXMLNode	Parameters: XmlNode parentnode: The xml node that entities in this childEntity should be parsed from.
getEntitiesByProperties	Parameters: array of PStruct pstructs Return: array of IEntity
getEntitiesByProperty	Parameters: PStruct pstruct: An object that provides the property name and value to search for. Return: array of IEntity
getEntityByProperties	Parameters: array of PStruct pstructs Return: IEntity
getEntityByPropertiesEffdt	Parameters: array of PStruct pstructs date asOfDate: The date to check against the effective date. Return: IEntity

getEntityByProperty	<p>Parameters:</p> <p>PStruct pstruct: An object that provides the property name and value to search for.</p> <p>Return:</p> <p>IEntity</p>
getNextSeqNbr	<p>Parameters:</p> <p>string fieldname: The field name of the sequence number.</p> <p>array of IEntity entities: The array of entities to search through to figure out the max sequence number.</p> <p>Return:</p> <p>number - the next available sequence number.</p>
getRowset	<p>Return:</p> <p>Rowset - the rowset generated.</p>
hardDelete	<p>Parameters:</p> <p>MessageLogBase p_messageLog(out): The messageLog object passed from the parent to the child to log any errors or warnings.</p>
preSave	N/A
promote	<p>Parameters:</p> <p>string p_emplID: The employee ID to set on the records when the data is promoted.</p> <p>MessageLogBase p_messageLog(out): The messageLog object passed from the parent to the child to log any errors or warnings.</p>
save	<p>Parameters:</p> <p>MessageLogBase p_messageLog(out): The messageLog object passed from the parent to the child to log any errors or warnings.</p>

toXMLNode	Parameters: XmlNode parentNode: The xml node that entities in this childEntity should be added to.
validate	Parameters: MessageLogBase p_messageLog(out): The messageLog object passed from the parent to the child to log any errors or warnings.
workflow	Parameters: boolean p_onlineMode: The online mode.

class SCC_COMMON:ENTITY:EntityRegFactory

Summary and Details:

Summary

Method Summary:

public IEntity	createEntity(string entityID, IEntity parent)
----------------	---

Details

Method Details:

createEntity	Parameters: string entityID IEntity parent Return IEntity
--------------	---

interface SCC_COMMON:ENTITY:CODEGEN:EntityGeneratorInterface

Implementing Classes: SCC_COMMON:ENTITY:CODEGEN:EntityGeneratorBase

Summary

Property Summary:

public string	BaseAppClass: The base appclass, this is populated based on the entity type when the code generate button is pressed.
public string	ClassName: The class name, which is populated by the entity registry when the code generate button is pressed.
public string	EntityID: The entity id, which is populated by the entity registry when the code generate button is pressed.
public boolean	hasProduction: Specifies if this entity has a production record.
public boolean	hasStage: Specifies if this entity has a stage record.
public Array of string	ignoreFields: Specifies the names of properties implemented on the parent entities that should not be generate on the current entity.
public Rowset	rsProperties: Passes in the rowset of SCC_ENT_PROPS related to the entity.

Method Summary:

public void	BuildUI(Rowset rs): Builds the UI of check boxes in the given rowset, SCC_ER_CGEN_VW, this rowset has 2 fields, SCC_ER_CGEN_ARG, the check box to be populated by the user and SCC_ER_CGEN_LBL the label displayed relative to the check box. Using that this code can generate as many yes/no questions as needed for code generation.
public string	GenerateCode(): The process called to generate the code based on the provided properties and UI input.
public void	ParseUI(Rowset rs): Retrieves the data from the UI built in BuildUI, SCC_ER_CGEN_VW, this rowset has 2 fields, SCC_ER_CGEN_ARG, the check box to be populated by the user and SCC_ER_CGEN_LBL the label displayed relative to the check box. This code should retrieve the arguments.

Details*Property Details:*

BaseAppClass	public string
ClassName	public string
EntityID	public string
hasProduction	public boolean
hasStage	public boolean
ignoreFields	public Array of string
rsProperties	public Rowset

Method Details:

BuildUI	Parameters: Rowset rs: The rowset for SCC_ER_CGEN_VW to be populated.
GenerateCode	Return: string - returns the generated code as a string for display.
ParseUI	Parameters: Rowset rs: The rowset for SCC_ER_CGEN_VW to be parsed.

interface SCC_COMMON:ENTITY:PROPERTY:PropertySyncInterface

Implementing Classes: SCC_COMMON:ENTITY:PROPERTY:PropertySyncBase

Summary

Property Summary:

public string	appclass: The application class for the specified entity, populated pre-sync.
public string	entityID: The entity ID for the specified entity, populated pre-sync.

public string	EntityType: The entity type ID for the specified entity, populated pre-sync.
public MessageLogBase	Log: All property changes should be written to the log, which is then displayed to the user when the sync is done using All Property Sync.
public string	ProdRecord: The production record as specified on the entity, populated pre-sync.
public rowset	rs: The rowset of current entity properties based on record SCC_ENT_PROPS, populated pre-sync.
public string	StageRecord: The staging record as specified on the entity, populated pre-sync.

Method Summary:

public string	LogAsString(): Returns the Log as a string.
public void	save(): The method called to save the updated properties, this is called from the all property sync process, for the entity registry component this is not used.
public void	updateProperties(): The method called to update the properties in the rowset, based on the records.

Details*Property Details:*

appclass	public string
entityID	public string
EntityType	public string
Log	public MessageLogBase
ProdRecord	public string

rs	public Rowset
StageRecord	public string

Method Details:

LogAsString	Return: string
save	N/A
updateProperties	N/A

abstract class SCC_COMMON:ENTITY:LOG:MessageLogBase*Direct Known Subclasses:* SCC_COMMON:ENTITY:LOG:TempMessageLog**Summary***Property Summary:*

public boolean	isError
public boolean	isInformation
public boolean	isReconcileError
public boolean	isWarning
public string	messageContext
protected Array of MessageEntry	MessageEntries

Constructor Summary:

public void	MessageLogBase()
-------------	------------------

Method Summary:

public void	append(MessageLogBase p_messageLog)
public void	buildMsgSegment(XmlNode msgsnode)
public void	clear()
public Message	generateFaultMsg(string p_operationName)
public void	generateValidationMsg(XmlNode p_node)
public MessageEntry	getMessageEntry(number p_index): Returns the MessageEntry Object at the given index.
public number	length(): length Current length of the message log.
public string	read(number p_index): read - Read an entry from the Message Log. @Return String - The message entry at the given index or blank if index does not exist.
public void	save()
public void	writeEntry(MessageEntry p_entry)

Details

Property Details:

isError	public boolean
isInformation	public boolean
isReconcileError	public boolean
isWarning	public boolean
messageContext	public string
MessageEntries	protected Array of MessageEntry

Constructor Details:

MessageLogBase	N/A
----------------	-----

Method Details:

append	Parameters: MessageLogBase p_messageLog
buildMsgSegment	Parameters: XmlNode msgsnode
clear	N/A
generateFaultMsg	Parameters: string p_operationName Return: Message
generateValidationMsg	Parameters: XmlNode p_node
getMessageEntry	Parameters: number p_index Return: MessageEntry
length	Return: number
read	Parameters: number p_index Return: string - The message entry at the given index or blank if index does not exist.

save	N/A
writeEntry	Parameters: MessageEntry p_entry

class **SCC_COMMON:ENTITY:LOG:MessageEntry**

Summary and Details:

Summary

Property Summary:

public string	Context
public number	MsgID
public number	MsgSet
public Array of string	ParmArray
public Array of MEProp	Properties
public number	Severity
public number	Severity_Error
public number	Severity_Info
public number	Severity_ReconcileError
public number	Severity_Warning

Constructor Summary:

public void	MessageEntry()
-------------	----------------

Method Summary:

public void	AddProperty(string p_UID, string p_Prop)
public void	DataPopulateV1(number p_MsgSet, number p_MsgID, number p_Severity, array of string p_ParmArray, string p_Context, string p_UID, string p_Prop) Quick population of a messageEntry.

Details

Property Details:

Context	public string
MsgID	public number
MsgSet	public number
ParmArray	public Array of string
Properties	public Array of MEProp
Severity	public number
Severity_Error	public number
Severity_Info	public number
Severity_ReconcileError	public number
Severity_Warning	public number

Constructor Details:

MessageEntry	N/A
--------------	-----

Method Details:

<p>AddProperty</p>	<p>Parameters:</p> <p>string p_UID</p> <p>string p_Prop</p>
<p>DataPopulateV1</p>	<p>Parameters:</p> <p>number p_MsgSet: The message set of the error.</p> <p>number p_MsgID: The Message Id, based on the message set for the error.</p> <p>number p_Severity: The severity of the error should be set using Severity_ReconcileError, Severity_Error, Severity_Warning, Severity_Info.</p> <p>array of string p_ParmArray: The array of parameters for the message specified, if no parameters are needed null can be passed.</p> <p>string p_Context: Specify the context of the MessageEntry. If no context is set, the MessageLog defaults it to writeEntry.</p> <p>string p_UID: The EntityInstanceId that this messageEntry should be attached to, if multiple EntityInstances are involved use AddProperty to add the additional properties.</p> <p>string p_Prop: A specific property (use the xml tag) under an instanceid that the messageEntry is related to, if multiple properties are involved use AddProperty after DataEntry to add additional properties.</p>

class SCC_COMMON:ENTITY:LOG:MEProp

Summary and Details:

Summary

Property Summary:

<p>public string</p>	<p>EntityInstanceId</p>
<p>public string</p>	<p>Property</p>

Details

Property Details:

EntityInstanceId	public string
Property	public string

Using Entity Registry Based Constituent Web Services

Using Entity Registry Based Constituent Web Service Operations

Note: Campus Solutions offers two types of web services to support Constituent functions. This section covers synchronous web services based on the system's Entity Registry functionality. For information on asynchronous Constituent web services, see [Understanding Constituent Web Services](#).

Using the following web service names:

- SOAP Service Name: SCC_CONSTITUENT
- REST Service Name: SCC_CONSTITUENT_R

Entity Registry-based Constituent web services offer functionality in the following areas:

- Get Constituent – Requests (gets) personal and demographic information about a person within Campus Solutions.
- Submit Constituent – Updates (submits) personal and demographic information about a person within Campus Solutions.
- Get Photo – Retrieves the person's photo from with Campus Solutions system.
- Get Checklist – Retrieves Self-service Checklist items for a person.
- Get Service Indicators – Retrieves Self-service Service Indicators for a person.
- Get User Preferences – Get user preferences for a person.
- Submit User Preferences – Submits user preferences for a person.

See:

- *PeopleTools: Integration Broker*
- [Setting Up Entity Registry](#)

Using Get Constituent Web Services

The section describes the SOAP and REST Get Constituent web services.

Using the SOAP Get Constituent Web Service Operation

This is a description of the SOAP Get Constituent Web Service Operation:

Service

SCC_CONSTITUENT

Operation

SCC_GETCONST

Summary

The inbound Get Constituent service validates the EmplID of a constituent and populates the response message with the personal information details of the constituent.

Description

This Service Operation retrieves personal information details of the constituent.

- Request Parameters (not mandatory):
 - SCC_TEMPID
 - LanguageCd
 - SCC_PROFILE_ID
- Validation performed for Get Constituent:

Self-service – Constituent requests are built with EMPLID = UserId's EMPLID.

Users

Student

Processing

This service operation performs the following steps:

- Verify required input parameters exist.
- Performs the above mentioned validations on the input parameters.
- Retrieves the available personal information.
- Responds with the personal information/error messages.

Output

Response message contains personal information/error messages for constituent. Response Key Data elements: Names, Addresses, Phones, Email Addresses, Person Data Effdt, Person SA.

Error Conditions

The service operation results in error in the following conditions:

- Invalid input parameters.
- Any of the validations mentioned above fail.

Describing the SOAP Input Message: SCC_GETCONST_REQ

The following diagram shows the input message structure:

This example illustrates the fields and controls on the SCC_GETCONST_REQ Message Structure. You can find definitions for the fields and controls later on this page.

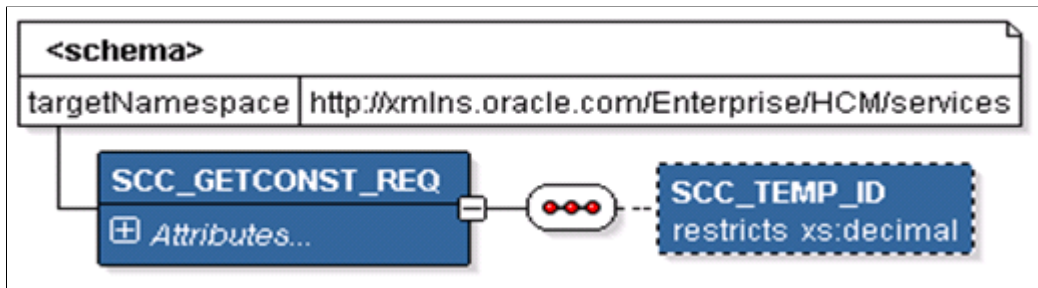

The following is an example of the SCC_GETCONST_REQ message that the SCC_GETCONST service operation receives from an SCE request:

```
<?xml version="1.0"?>
<SCC_GETCONST_REQ xmlns="http://xmlns.oracle.com/Enterprise/services" xmlns:wss=
"http://docs.oasis-open.org/wss/2004/01/oasis-200401-wss-wssecurity-utility-1.0.xsd"
"/>
```

Describing the SOAP Output Message: SCC_GETCONST_RESP

When the Integration Broker receives the SCC_GETCONST_REQ message, it responds with the SCC_GETCONST_RESP message; a small excerpt of the structure is shown below:

This example illustrates the fields and controls on the SCC_GETCONST_RESP Message Parameters (1 of 2). You can find definitions for the fields and controls later on this page.

<schema>	
targetNamespace	http://xmlns.oracle.com/Enterprise/HCM/services
<include>	
schemaLocation	SCC_ENTITY_CONSTITUENT.V1.xsd

CONSTITUENT	
SCC_TEMP_ID	restricts xs:decimal
minInclusive	0
totalDigits	16
EMPLID	restricts xs:string
maxLength	11
BIRTHDATE	restricts xs:date
BIRTHPLACE	restricts xs:string
maxLength	30
BIRTHCOUNTRY	restricts xs:string
maxLength	3
BIRTHSTATE	restricts xs:string
maxLength	6
DT_OF_DEATH	restricts xs:date
SCC_ENTITY_INST_ID	restricts xs:string
PER_NAMES	+
EMAIL_ADDRESSES	+
ACADEMIC_HISTORIES	+
ADDRESSES	+
PHONES	+
PERSON_DATA_EFFDTS	+

This example illustrates the fields and controls on the SCC_GETCONST_RESP Message Parameters (2 of 2). You can find definitions for the fields and controls later on this page.

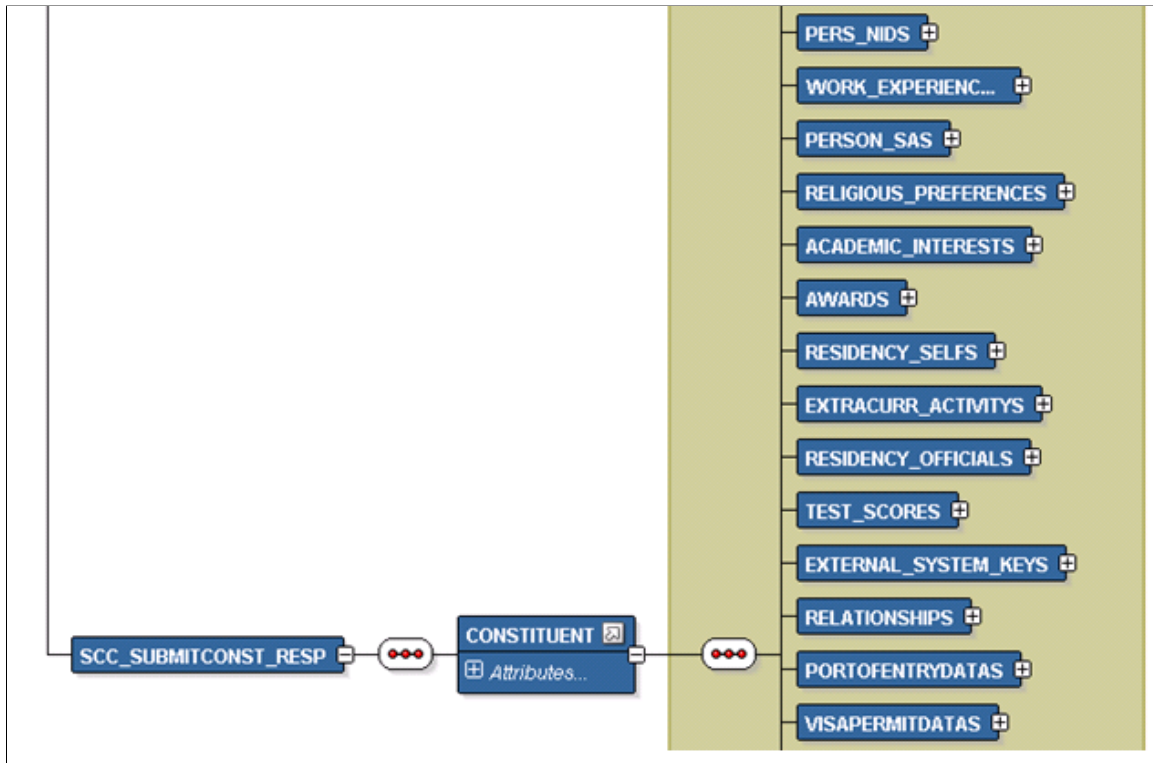

The following is an example of the SCC_GETCONST_RESP message that the SCC_GETCONST service operation transmits to the UI:

```
<?xml version="1.0"?>
<SCC_GETCONST_RESP xmlns="http://xmlns.oracle.com/Enterprise/services">
  <CONSTITUENT>
    <EMPLID>CCSCE0001</EMPLID>
    <BIRTHDATE/>
    <BIRTHPLACE/>
    <BIRTHCOUNTRY/>
    <BIRTHSTATE/>
    <DT_OF_DEATH/>
    <PER_NAMES>
      <PER_NAME>
        <EMPLID>CCSCE0001</EMPLID>
        <NAME_TYPE>PRF</NAME_TYPE>
        <NAME_TYPE_LOVDescr>Preferred</NAME_TYPE_LOVDescr>
        <COUNTRY_NM_FORMAT>001</COUNTRY_NM_FORMAT>
        <EFFDT>2013-08-20</EFFDT>
        <NAME>Anderson Jr.,Kevin</NAME>
        <EFF_STATUS>A</EFF_STATUS>
        <NAME_INITIALS/>
        <NAME_PREFIX>Mr</NAME_PREFIX>
        <NAME_SUFFIX>Jr.</NAME_SUFFIX>
        <NAME_ROYAL_PREFIX/>
        <NAME_ROYAL_SUFFIX/>
        <NAME_TITLE/>
        <LAST_NAME_SRCH>ANDERSON</LAST_NAME_SRCH>
        <FIRST_NAME_SRCH>KEVIN</FIRST_NAME_SRCH>
        <LAST_NAME>Anderson</LAST_NAME>
        <FIRST_NAME>Kevin</FIRST_NAME>
        <MIDDLE_NAME/>
        <SECOND_LAST_NAME/>
        <SECOND_LAST_SRCH/>
        <NAME_AC/>
      </PER_NAME>
    </PER_NAMES>
  </CONSTITUENT>
</SCC_GETCONST_RESP>
```

```

    <PREF_FIRST_NAME/>
    <PARTNER_LAST_NAME/>
    <PARTNER_ROY_PREFIX/>
    <LAST_NAME_PREF_NLD>1</LAST_NAME_PREF_NLD>
    <NAME_DISPLAY>Kevin Anderson</NAME_DISPLAY>
    <NAME_FORMAL>Mr Kevin Anderson</NAME_FORMAL>
    <NAME_DISPLAY_SRCH/>
    <EffectiveDate>2013-10-04</EffectiveDate>
  </PER_NAME>
  <PER_NAME isDeletable="N">
    <EMPLID>CCSCE0001</EMPLID>
    <NAME_TYPE>PRI</NAME_TYPE>
    <NAME_TYPE_LOVDescr>Primary</NAME_TYPE_LOVDescr>
    <COUNTRY_NM_FORMAT>001</COUNTRY_NM_FORMAT>
    <EFFDT>2013-08-20</EFFDT>
    <NAME>Anderson Jr., Kevin</NAME>
    <EFF_STATUS>A</EFF_STATUS>
    <NAME_INITIALS/>
    <NAME_PREFIX>Mr</NAME_PREFIX>
    <NAME_SUFFIX>Jr.</NAME_SUFFIX>
    <NAME_ROYAL_PREFIX/>
    <NAME_ROYAL_SUFFIX/>
    <NAME_TITLE/>
    <LAST_NAME_SRCH>ANDERSON</LAST_NAME_SRCH>
    <FIRST_NAME_SRCH>KEVIN</FIRST_NAME_SRCH>
    <LAST_NAME>Anderson</LAST_NAME>
    <FIRST_NAME>Kevin</FIRST_NAME>
    <MIDDLE_NAME/>
    <SECOND_LAST_NAME/>
    <SECOND_LAST_SRCH/>
    <NAME_AC/>
    <PREF_FIRST_NAME/>
    <PARTNER_LAST_NAME/>
    <PARTNER_ROY_PREFIX/>
    <LAST_NAME_PREF_NLD>1</LAST_NAME_PREF_NLD>
    <NAME_DISPLAY>Kevin Anderson</NAME_DISPLAY>
    <NAME_FORMAL>Mr Kevin Anderson</NAME_FORMAL>
    <NAME_DISPLAY_SRCH/>
    <EffectiveDate>2013-10-04</EffectiveDate>
  </PER_NAME>
</PER_NAMES>
<EMAIL_ADDRESSES>
  <EMAIL_ADDRESS>
    <EMPLID>CCSCE0001</EMPLID>
    <E_ADDR_TYPE>CAMP</E_ADDR_TYPE>
    <E_ADDR_TYPE_LOVDescr>Campus</E_ADDR_TYPE_LOVDescr>
    <EMAIL_ADDR>Kevin.Anderson@Campus.edu</EMAIL_ADDR>
    <PREF_EMAIL_FLAG>Y</PREF_EMAIL_FLAG>
  </EMAIL_ADDRESS>
</EMAIL_ADDRESSES>
<ADDRESSES>
  <ADDRESS>
    <EMPLID>CCSCE0001</EMPLID>
    <ADDRESS_TYPE>CAMP</ADDRESS_TYPE>
    <ADDRESS_TYPE_LOVDescr>Campus</ADDRESS_TYPE_LOVDescr>
    <EFFDT>2013-08-20</EFFDT>
    <EFF_STATUS>A</EFF_STATUS>
    <COUNTRY>USA</COUNTRY>
    <ADDRESS1>1400 University Drive</ADDRESS1>
    <ADDRESS2>Davidson Dorms</ADDRESS2>
    <ADDRESS3>Dorm 204 B</ADDRESS3>
    <ADDRESS4/>
    <CITY>Princeton</CITY>
    <NUM1/>
    <NUM2/>
    <HOUSE_TYPE/>
    <ADDR_FIELD1/>
    <ADDR_FIELD2/>
    <ADDR_FIELD3/>
    <COUNTY/>
    <STATE>NJ</STATE>
  </ADDRESS>
</ADDRESSES>

```



```

    <POSTAL>08540</POSTAL>
    <GEO_CODE/>
    <IN_CITY_LIMIT/>
    <ADDRESS1_AC/>
    <ADDRESS2_AC/>
    <ADDRESS3_AC/>
    <CITY_AC/>
    <REG_REGION/>
    <EffectiveDate>2013-10-04</EffectiveDate>
  </ADDRESS>
  <ADDRESS isDeletable="N">
    <EMPLID>CCSCE0001</EMPLID>
    <ADDRESS_TYPE>HOME</ADDRESS_TYPE>
    <ADDRESS_TYPE_LOVDescr>Home</ADDRESS_TYPE_LOVDescr>
    <EFFDT>2013-08-20</EFFDT>
    <EFF_STATUS>A</EFF_STATUS>
    <COUNTRY>USA</COUNTRY>
    <ADDRESS1>184 Chestnut Ave</ADDRESS1>
    <ADDRESS2/>
    <ADDRESS3/>
    <ADDRESS4/>
    <CITY>Hackensack</CITY>
    <NUM1/>
    <NUM2/>
    <HOUSE_TYPE/>
    <ADDR_FIELD1/>
    <ADDR_FIELD2/>
    <ADDR_FIELD3/>
    <COUNTRY/>
    <STATE>NJ</STATE>
    <POSTAL>07612</POSTAL>
    <GEO_CODE/>
    <IN_CITY_LIMIT/>
    <ADDRESS1_AC/>
    <ADDRESS2_AC/>
    <ADDRESS3_AC/>
    <CITY_AC/>
    <REG_REGION/>
    <EffectiveDate>2013-10-04</EffectiveDate>
  </ADDRESS>
</ADDRESSES>
<PHONES>
  <PERPHONE>
    <EMPLID>CCSCE0001</EMPLID>
    <PHONE_TYPE>CAMP</PHONE_TYPE>
    <PHONE_TYPE_LOVDescr>Campus</PHONE_TYPE_LOVDescr>
    <COUNTRY_CODE>001</COUNTRY_CODE>
    <PHONE>617/982-7832</PHONE>
    <EXTENSION>29</EXTENSION>
    <PREF_PHONE_FLAG>Y</PREF_PHONE_FLAG>
  </PERPHONE>
  <PERPHONE>
    <EMPLID>CCSCE0001</EMPLID>
    <PHONE_TYPE>DORM</PHONE_TYPE>
    <PHONE_TYPE_LOVDescr>Dormitory</PHONE_TYPE_LOVDescr>
    <COUNTRY_CODE>345</COUNTRY_CODE>
    <PHONE>234-2345</PHONE>
    <EXTENSION/>
    <PREF_PHONE_FLAG>N</PREF_PHONE_FLAG>
  </PERPHONE>
</PHONES>
<PERSON_DATA_EFFDTS>
  <PERS_DATA_EFFDT>
    <EMPLID>CCSCE0001</EMPLID>
    <MAR_STATUS>U</MAR_STATUS>
    <EFFDT>2013-08-20</EFFDT>
    <MAR_STATUS_DT>2013-08-20</MAR_STATUS_DT>
    <SEX>M</SEX>
    <SEX_LOVDescr>Male</SEX_LOVDescr>
    <HIGHEST_EDUC_LVL>A</HIGHEST_EDUC_LVL>
    <FT_STUDENT>N</FT_STUDENT>
  </PERS_DATA_EFFDT>
</PERSON_DATA_EFFDTS>

```

```

    <LANG_CD/>
    <ALTER_EMPLID/>
    <LASTUPDDTTM/>
    <LASTUPDOPRID/>
  </PERS_DATA_EFFDT>
</PERSON_DATA_EFFDTS>
</CONSTITUENT>
</SCC_GETCONST_RESP>

```

Describing the SOAP Output Fault Message: SCC_FAULT_RESP

When the Integration Broker receives the SCC_GETCONST_REQ message and a validation fault is detected, it responds with the output fault message SCC_FAULT_RESP that consists of the error message number, set number and the error message text.

Using the REST Get Constituent Web Service Operation

This is a description of the SOAP Get Constituent Web Service Operation:

Service

SCC_CONSTITUENT_R

Operation

SCC_GETCONST_R_GET

EndPoint

http://<hostname>:<port>//PSIGW/RESTListeningConnector/SCC_GETCONST_R.v1/ constituent/get?
SCC_TEMP_ID={SCC_TEMP_ID}&SCC_PROFILE_ID=

Summary

Refer to the Get Constituent SOAP Service Operation.

Description

Refer to the Get Constituent SOAP Service Operation.

Users

Refer to the Get Constituent SOAP Service Operation.

Processing

Refer to the Get Constituent SOAP Service Operation.

Output

Refer to the Get Constituent SOAP Service Operation.

Error Conditions

Refer to the Get Constituent SOAP Service Operation.

Describing the REST Input Message: SCC_GETCONST_RE_R

Refer to the Get Constituent SOAP Service Operation.

Describing the REST Output Message: SCC_GETCONST_RESP

Refer to the Get Constituent SOAP Service Operation.

Describing the REST Output Fault Message: SCC_FAULT_RESP_R

Refer to the Get Constituent SOAP Service Operation.

Using Submit Constituent Web Services

The section describes the SOAP and REST Submit Constituent web services.

Using the SOAP Submit Constituent Web Service Operation

This is a description of the SOAP Submit Constituent Web Service Operation:

Service

SCC_CONSTITUENT

Operation

SCC_SUBMITCONST

Summary

The inbound Submit Constituent service updates (submits) personal and demographic information about a person within Campus Solutions.

Description

This Service Operation submits personal information details of a constituent to the Campus Solutions database.

- Request Parameter:

Constituent entity – The Constituent options that are provided are derived from the SCC_SUBMITCONST service operation. For example Address, Name, Email Address, Phone, Person SA data.

- Validation performed for Submit Constituent:

- Self-service – Submit Constituent requests are always built with EMPLID = UserId's EMPLID.
- Email Validations – Conduct all the standard checks to see if the email provided is valid:

The e-mail address must contain “@” and “.” characters.

The e-mail address shall not contain “@” and “.” as the first character.

Two at signs (@) are not allowed

The e-mail address shall not contain - as the first character in Domain name.

The e-mail address shall contain at least one character between "." and ".".

The e-mail address shall not contain “@” and “.” as the last character.

Validate that domain name consists of at least 2 characters (letters, digits and hyphens separated by dots) after @ sign but not more than 255 character letters, digits and hyphens separated by dots.

Validate that the local part consists of at least 1 character before the @ sign but not more not more than 64 characters.

Make sure that at least two characters are present between “@” and “.”.

- Validates the type Control setting on the Email type being processed and applies the appropriate display mask.
- Checks to determine if an email type is set as preferred; else service errors out.
- Data update rule is evaluated to decide as to overwrite or create a new row.
- Phone Validations:
 - Validates the type Control setting on the Phone type being processed and applies appropriate display mask.
 - Checks to determine if a phone type is set as preferred, else service errors out.
 - Data Update Rule is evaluated to determine which data is overwritten or if a new row needs to be inserted.
- Address Validations:
 - An Address record must contain one of the ADDRESS1,2,3 or 4 fields.
 - Validates the type Control setting on the Address type being processed and applies appropriate display mask.
 - Data Update Rule is evaluated before processing the data. If the Address data is already existing it is updated otherwise it is inserted.
- Name Validations:

All Names validations that are implemented as part of ValidatePersonName Service (NAMEGBL_SBR.NAME.SaveEdit) ValidateNameService function. It validates the Country specific name formatting.

Users

Student

Processing

This service operation performs the following steps:

- Verify required input parameters exist.
- Performs the above mentioned validations on the input parameters.
- Creates an entry or update to data within the constituent entity data model.
- Responds with information/error messages.

Output

Response message contains information/error messages for constituent.

Error Conditions

The service operation results in error in the following conditions:

- Invalid input parameters.
- Any of the validations mentioned above fail.

Describing the SOAP Input Message: SCC_SUBMITCONST_REQ

The following diagram shows the input message structure:

This example illustrates the fields and controls on the SCC_SUBMITCONST_REQ Message Structure (1 of 2). You can find definitions for the fields and controls later on this page.

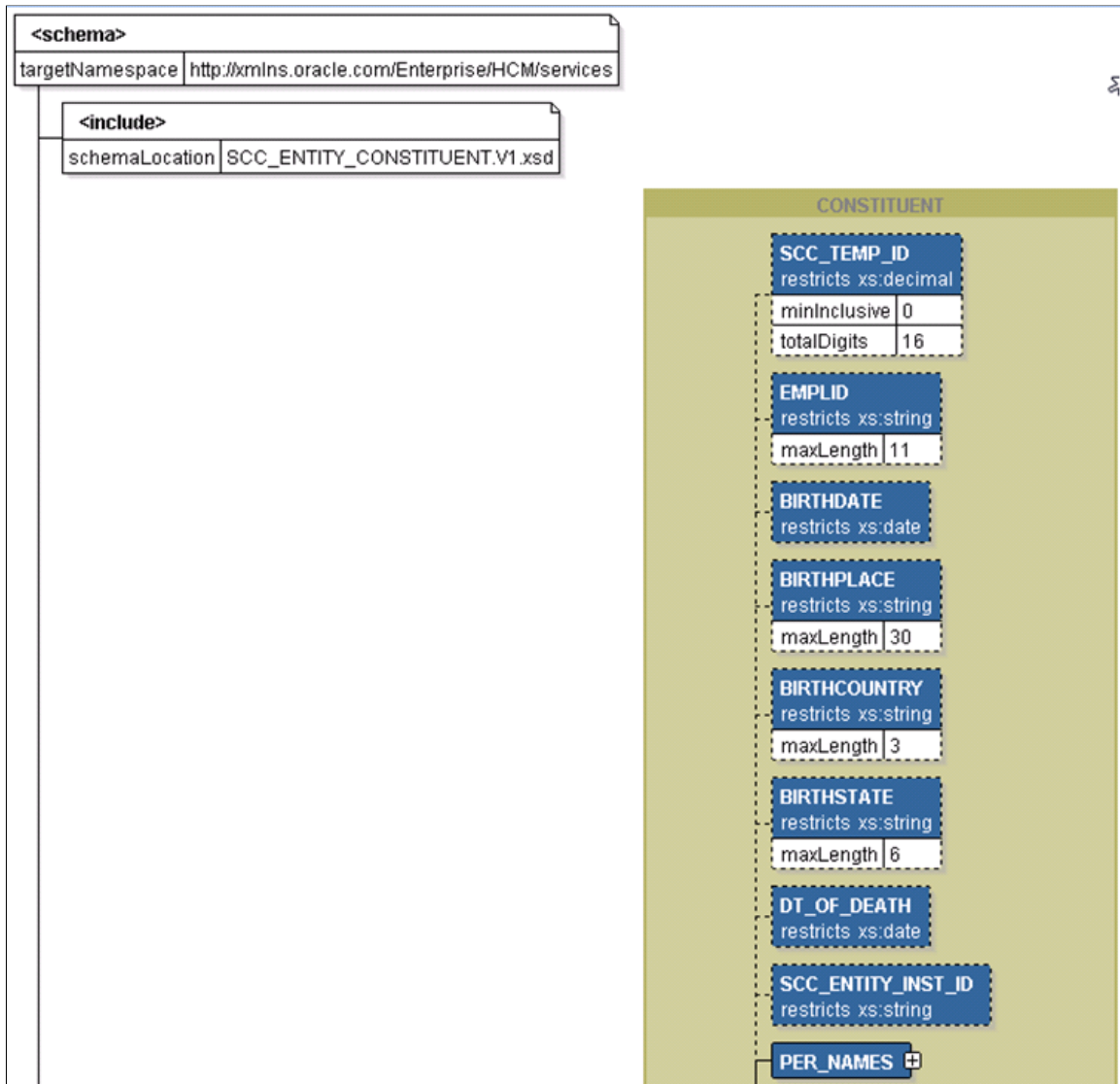

This example illustrates the fields and controls on the SCC_SUBMITCONST_REQ Message Structure (2 of 2). You can find definitions for the fields and controls later on this page.

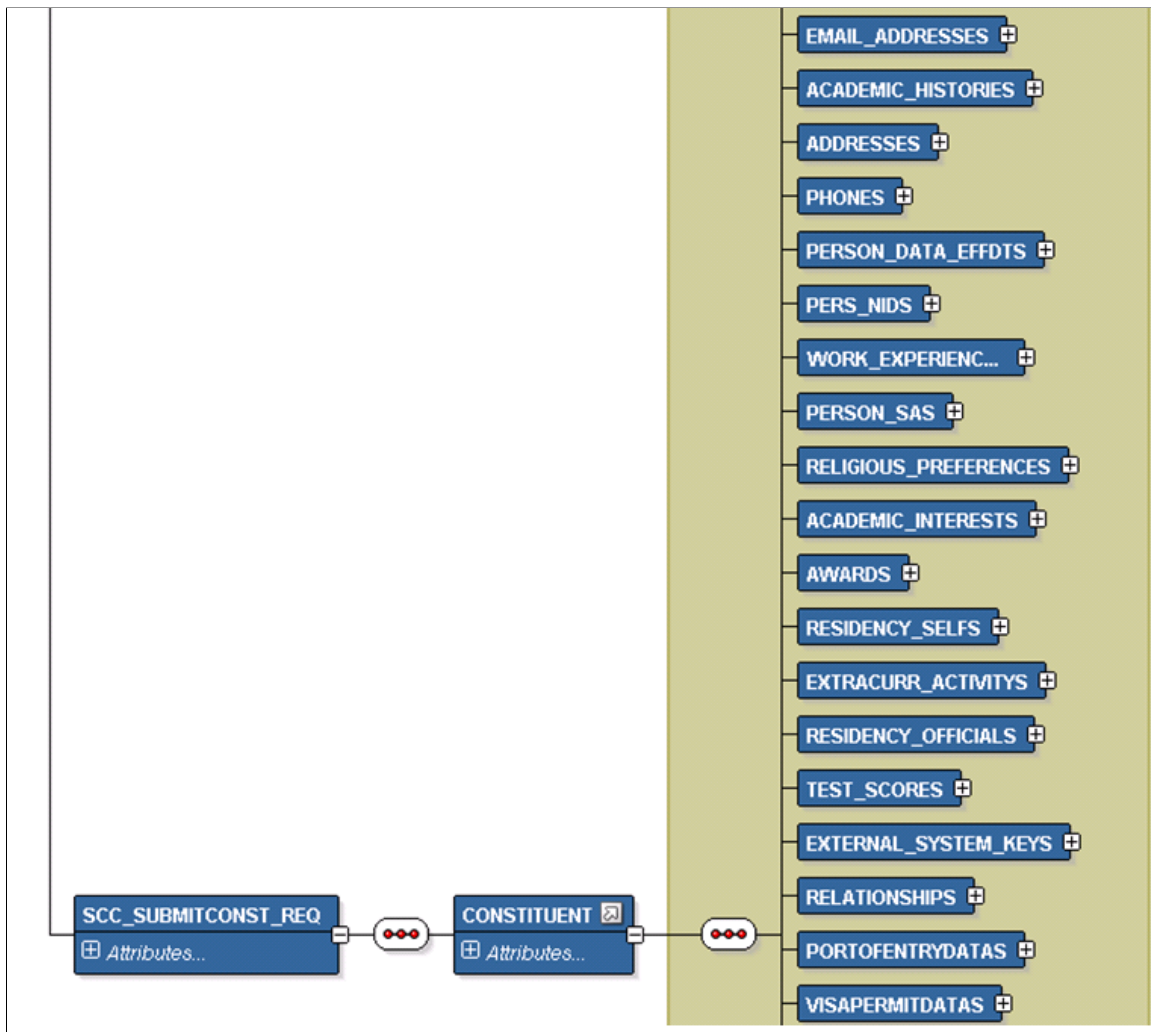

The following is an example of the SCC_SUBMITCONST_REQ message that the SCC_SUBMITCONST service operation receives from an SCE request:

```
<?xml version="1.0"?>
<SCC_SUBMITCONST_REQ xmlns="http://xmlns.oracle.com/Enterprise/services"
xmlns:wssu="http://docs.oasis-open.org/wss/2004/01/oasis-200401-wss-wssecurity-utility-1.0.xsd">
  <CONSTITUENT>
    <EMPLID>CCSCE0001</EMPLID>
    <EMAIL_ADDRESSES>
      <EMAIL_ADDRESS isDeleted="N">
        <EMPLID>CCSCE0001</EMPLID>
        <E_ADDR_TYPE>HOME</E_ADDR_TYPE>
        <EMAIL_ADDR>KAnderson@gmail.com</EMAIL_ADDR>
        <PREF_EMAIL_FLAG>N</PREF_EMAIL_FLAG>
      </EMAIL_ADDRESS>
      <EMAIL_ADDRESS isDeleted="N">
        <EMPLID>CCSCE0001</EMPLID>
        <E_ADDR_TYPE>CAMP</E_ADDR_TYPE>
        <EMAIL_ADDR>Kevin.Anderson@Campus.edu</EMAIL_ADDR>
        <PREF_EMAIL_FLAG>Y</PREF_EMAIL_FLAG>
      </EMAIL_ADDRESS>
    </EMAIL_ADDRESSES>
  </CONSTITUENT>
</SCC_SUBMITCONST_REQ>
```

```

</CONSTITUENT>
</SCC_SUBMITCONST_REQ>

```

Describing the SOAP Output Message: SCC_SUBMITCONST_RESP

When the Integration Broker receives the SCC_SUBMITCONST_REQ message, it responds with the SCC_SUBMITCONST_RESP message the structure of which a portion is shown below:

This example illustrates the fields and controls on the SCC_SUBMITCONST_RESP Message Parameters (1 of 2). You can find definitions for the fields and controls later on this page.

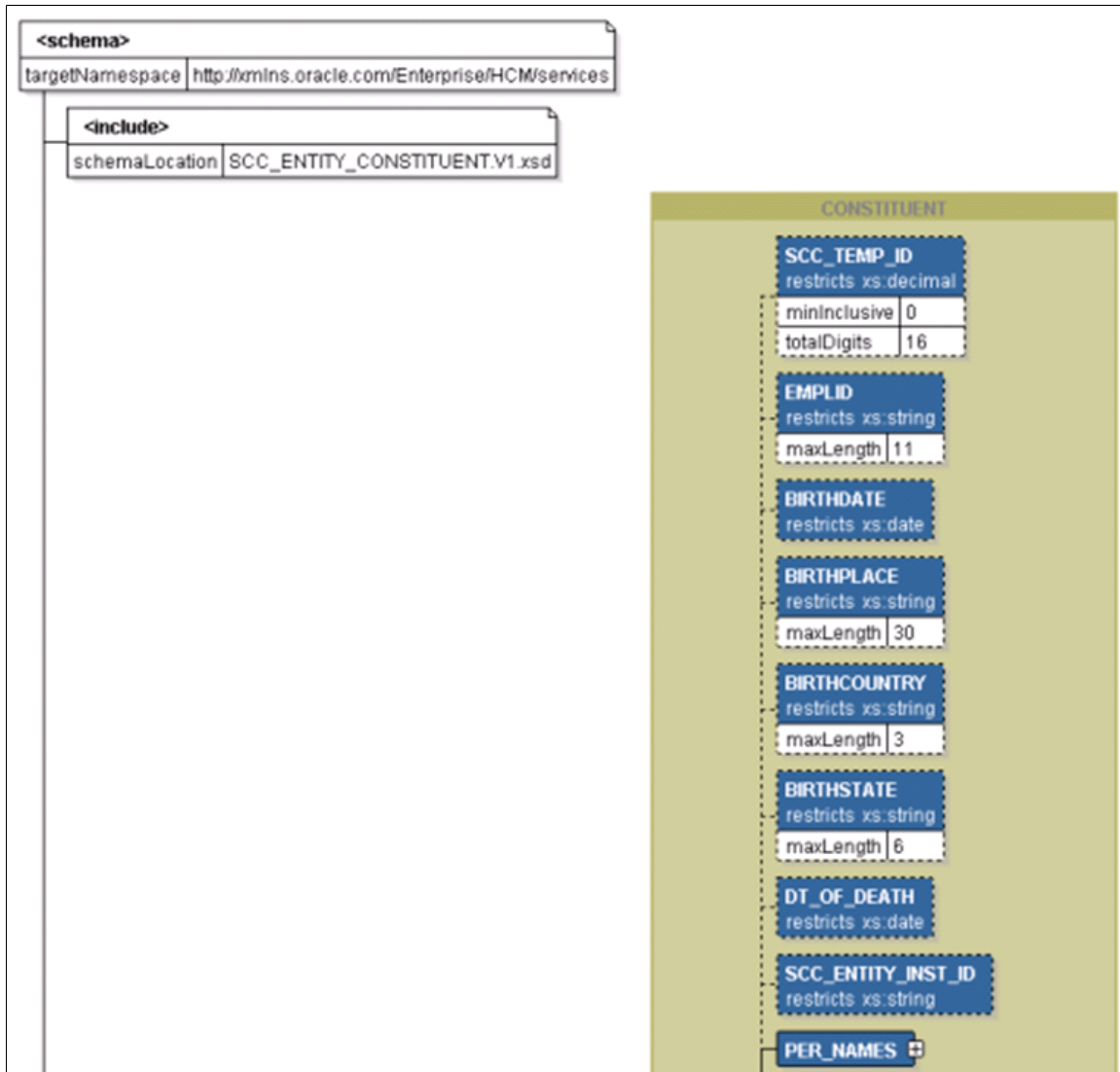

This example illustrates the fields and controls on the SCC_SUBMITCONST_RESP Message Parameters (2 of 2). You can find definitions for the fields and controls later on this page.

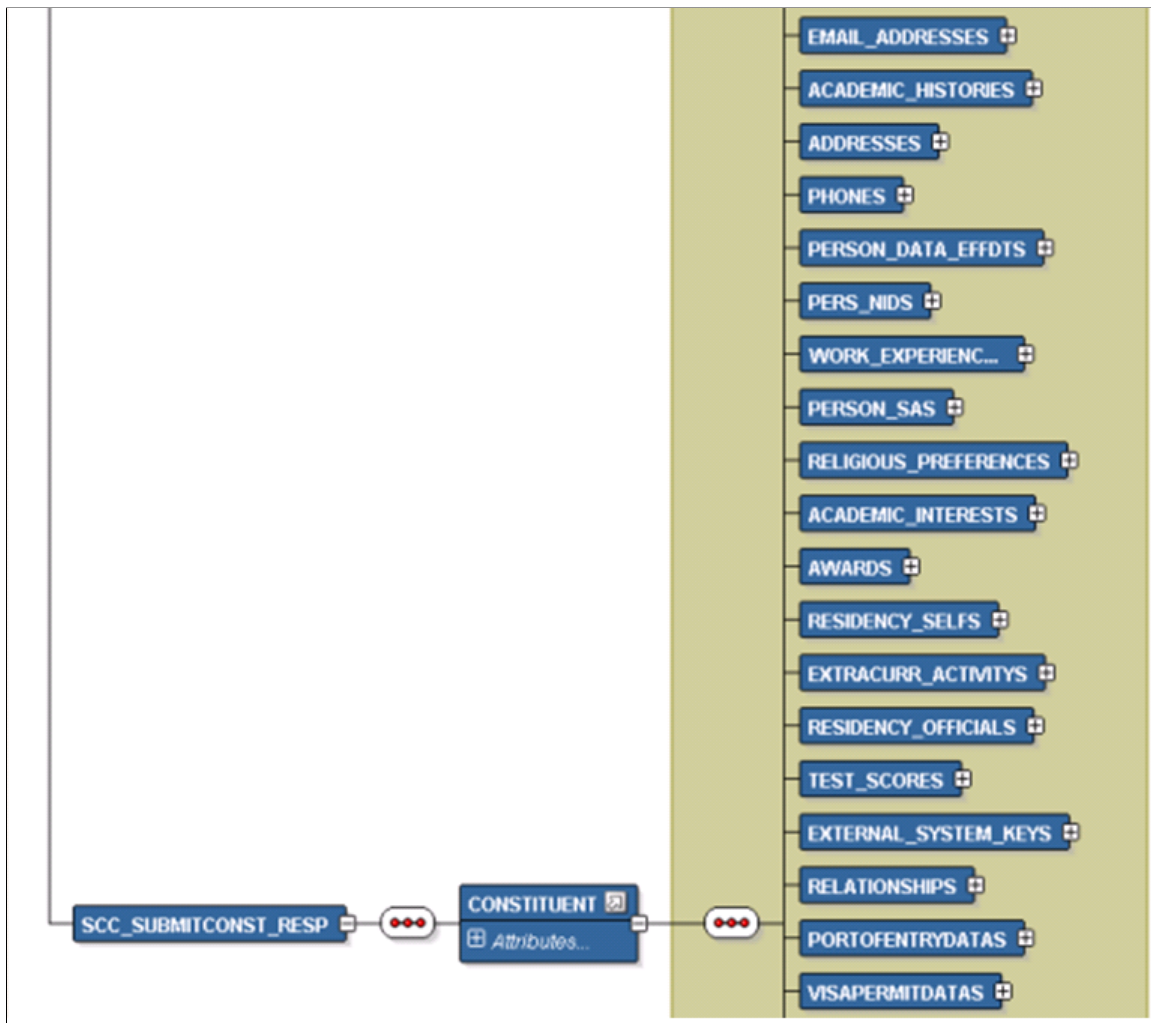

The following is an example of the SCC_GETCONST_RESP message that the SCC_GETCONST service operation transmits to the UI:

```
<?xml version="1.0"?>
<SCC_GETCONST_RESP xmlns="http://xmlns.oracle.com/Enterprise/services">
  <CONSTITUENT>
    <EMPLID>CCSCE0001</EMPLID>
    <BIRTHDATE/>
    <BIRTHPLACE/>
    <BIRTHCOUNTRY/>
    <BIRTHSTATE/>
    <DT_OF_DEATH/>
    <PER_NAMES>
      <PER_NAME>
        <EMPLID>CCSCE0001</EMPLID>
        <NAME_TYPE>PRF</NAME_TYPE>
        <NAME_TYPE_LOVDescr>Preferred</NAME_TYPE_LOVDescr>
        <COUNTRY_NM_FORMAT>001</COUNTRY_NM_FORMAT>
        <EFFDT>2013-08-20</EFFDT>
        <NAME>Anderson Jr.,Kevin</NAME>
        <EFF_STATUS>A</EFF_STATUS>
        <NAME_INITIALS/>
        <NAME_PREFIX>Mr</NAME_PREFIX>
        <NAME_SUFFIX>Jr.</NAME_SUFFIX>
        <NAME_ROYAL_PREFIX/>
      </PER_NAME>
    </PER_NAMES>
  </CONSTITUENT>
</SCC_GETCONST_RESP>
```

```

<NAME_ROYAL_SUFFIX/>
<NAME_TITLE/>
<LAST_NAME_SRCH>ANDERSON</LAST_NAME_SRCH>
<FIRST_NAME_SRCH>KEVIN</FIRST_NAME_SRCH>
<LAST_NAME>Anderson</LAST_NAME>
<FIRST_NAME>Kevin</FIRST_NAME>
<MIDDLE_NAME/>
<SECOND_LAST_NAME/>
<SECOND_LAST_SRCH/>
<NAME_AC/>
<PREF_FIRST_NAME/>
<PARTNER_LAST_NAME/>
<PARTNER_ROY_PREFIX/>
<LAST_NAME_PREF_NLD>1</LAST_NAME_PREF_NLD>
<NAME_DISPLAY>Kevin Anderson</NAME_DISPLAY>
<NAME_FORMAL>Mr Kevin Anderson</NAME_FORMAL>
<NAME_DISPLAY_SRCH/>
<EffectiveDate>2013-10-04</EffectiveDate>
</PER_NAME>
<PER_NAME isDeletable="N">
  <EMPLID>CCSCE0001</EMPLID>
  <NAME_TYPE>PRI</NAME_TYPE>
  <NAME_TYPE_LOVDescr>Primary</NAME_TYPE_LOVDescr>
  <COUNTRY_NM_FORMAT>001</COUNTRY_NM_FORMAT>
  <EFFDT>2013-08-20</EFFDT>
  <NAME>Anderson Jr., Kevin</NAME>
  <EFF_STATUS>A</EFF_STATUS>
  <NAME_INITIALS/>
  <NAME_PREFIX>Mr</NAME_PREFIX>
  <NAME_SUFFIX>Jr.</NAME_SUFFIX>
  <NAME_ROYAL_PREFIX/>
  <NAME_ROYAL_SUFFIX/>
  <NAME_TITLE/>
  <LAST_NAME_SRCH>ANDERSON</LAST_NAME_SRCH>
  <FIRST_NAME_SRCH>KEVIN</FIRST_NAME_SRCH>
  <LAST_NAME>Anderson</LAST_NAME>
  <FIRST_NAME>Kevin</FIRST_NAME>
  <MIDDLE_NAME/>
  <SECOND_LAST_NAME/>
  <SECOND_LAST_SRCH/>
  <NAME_AC/>
  <PREF_FIRST_NAME/>
  <PARTNER_LAST_NAME/>
  <PARTNER_ROY_PREFIX/>
  <LAST_NAME_PREF_NLD>1</LAST_NAME_PREF_NLD>
  <NAME_DISPLAY>Kevin Anderson</NAME_DISPLAY>
  <NAME_FORMAL>Mr Kevin Anderson</NAME_FORMAL>
  <NAME_DISPLAY_SRCH/>
  <EffectiveDate>2013-10-04</EffectiveDate>
</PER_NAME>
</PER_NAMES>
<EMAIL_ADDRESSES>
  <EMAIL_ADDRESS>
    <EMPLID>CCSCE0001</EMPLID>
    <E_ADDR_TYPE>CAMP</E_ADDR_TYPE>
    <E_ADDR_TYPE_LOVDescr>Campus</E_ADDR_TYPE_LOVDescr>
    <EMAIL_ADDR>Kevin.Anderson@Campus.edu</EMAIL_ADDR>
    <PREF_EMAIL_FLAG>Y</PREF_EMAIL_FLAG>
  </EMAIL_ADDRESS>
</EMAIL_ADDRESSES>
<ADDRESSES>
  <ADDRESS>
    <EMPLID>CCSCE0001</EMPLID>
    <ADDRESS_TYPE>CAMP</ADDRESS_TYPE>
    <ADDRESS_TYPE_LOVDescr>Campus</ADDRESS_TYPE_LOVDescr>
    <EFFDT>2013-08-20</EFFDT>
    <EFF_STATUS>A</EFF_STATUS>
    <COUNTRY>USA</COUNTRY>
    <ADDRESS1>14000 University Drive</ADDRESS1>
    <ADDRESS2>Davidson Dorms</ADDRESS2>
    <ADDRESS3>Dorm 204 B</ADDRESS3>
  </ADDRESS>
</ADDRESSES>

```

```

<ADDRESS4/>
<CITY>Princeton</CITY>
<NUM1/>
<NUM2/>
<HOUSE_TYPE/>
<ADDR_FIELD1/>
<ADDR_FIELD2/>
<ADDR_FIELD3/>
<COUNTY/>
<STATE>NJ</STATE>
<POSTAL>08540</POSTAL>
<GEO_CODE/>
<IN_CITY_LIMIT/>
<ADDRESS1_AC/>
<ADDRESS2_AC/>
<ADDRESS3_AC/>
<CITY_AC/>
<REG_REGION/>
<EffectiveDate>2013-10-04</EffectiveDate>
</ADDRESS>
<ADDRESS isDeletable="N">
  <EMPLID>CCSCE0001</EMPLID>
  <ADDRESS_TYPE>HOME</ADDRESS_TYPE>
  <ADDRESS_TYPE_LOVDescr>Home</ADDRESS_TYPE_LOVDescr>
  <EFFDT>2013-08-20</EFFDT>
  <EFF_STATUS>A</EFF_STATUS>
  <COUNTRY>USA</COUNTRY>
  <ADDRESS1>184 Chestnut Ave</ADDRESS1>
  <ADDRESS2/>
  <ADDRESS3/>
  <ADDRESS4/>
  <CITY>Hackensack</CITY>
  <NUM1/>
  <NUM2/>
  <HOUSE_TYPE/>
  <ADDR_FIELD1/>
  <ADDR_FIELD2/>
  <ADDR_FIELD3/>
  <COUNTY/>
  <STATE>NJ</STATE>
  <POSTAL>07612</POSTAL>
  <GEO_CODE/>
  <IN_CITY_LIMIT/>
  <ADDRESS1_AC/>
  <ADDRESS2_AC/>
  <ADDRESS3_AC/>
  <CITY_AC/>
  <REG_REGION/>
  <EffectiveDate>2013-10-04</EffectiveDate>
</ADDRESS>
</ADDRESSES>
<PHONES>
  <PERPHONE>
    <EMPLID>CCSCE0001</EMPLID>
    <PHONE_TYPE>CAMP</PHONE_TYPE>
    <PHONE_TYPE_LOVDescr>Campus</PHONE_TYPE_LOVDescr>
    <COUNTRY_CODE>001</COUNTRY_CODE>
    <PHONE>617/982-7832</PHONE>
    <EXTENSION>29</EXTENSION>
    <PREF_PHONE_FLAG>Y</PREF_PHONE_FLAG>
  </PERPHONE>
  <PERPHONE>
    <EMPLID>CCSCE0001</EMPLID>
    <PHONE_TYPE>DORM</PHONE_TYPE>
    <PHONE_TYPE_LOVDescr>Dormitory</PHONE_TYPE_LOVDescr>
    <COUNTRY_CODE>345</COUNTRY_CODE>
    <PHONE>234-2345</PHONE>
    <EXTENSION/>
    <PREF_PHONE_FLAG>N</PREF_PHONE_FLAG>
  </PERPHONE>
</PHONES>

```

```

<PERSON_DATA_EFFDTS>
  <PERS_DATA_EFFDT>
    <EMPLID>CCSCE0001</EMPLID>
    <MAR_STATUS>U</MAR_STATUS>
    <EFFDT>2013-08-20</EFFDT>
    <MAR_STATUS_DT>2013-08-20</MAR_STATUS_DT>
    <SEX>M</SEX>
    <SEX_LOVDescr>Male</SEX_LOVDescr>
    <HIGHEST_EDUC_LVL>A</HIGHEST_EDUC_LVL>
    <FT_STUDENT>N</FT_STUDENT>
    <LANG_CD/>
    <ALTER_EMPLID/>
    <LASTUPDDTTM/>
    <LASTUPDOPRID/>
  </PERS_DATA_EFFDT>
</PERSON_DATA_EFFDTS>
</CONSTITUENT>
</SCC_GETCONST_RESP>

```

Describing the SOAP Output Fault Message: SCC_FAULT_RESP

When the Integration Broker receives the SCC_SUBMITCONST_REQ message and a validation fault is detected, it responds with the output fault message SCC_FAULT_RESP that consists of error message number, set number and the error message text.

Using the REST Submit Constituent Web Service Operation

This is a description of the SOAP Submit Constituent Web Service Operation:

Service

SCC_CONSTITUENT_R

Operation

SCC_SUBMITCONST_R_POST

EndPoint

http://<hostname>:<port>//PSIGW/RESTListeningConnector/SCC_SUBMITCONST_R.v1/constituent/put?SCC_PROFILE_ID={SCC_PROFILE_ID}&languageCd={languageCd}

Summary

Refer to the Submit Constituent SOAP Service Operation.

Description

Refer to the Submit Constituent SOAP Service Operation.

Users

Refer to the Submit Constituent SOAP Service Operation.

Processing

Refer to the Submit Constituent SOAP Service Operation.

Output

Refer to the Submit Constituent SOAP Service Operation.

Error Conditions

Refer to the Submit Constituent SOAP Service Operation.

Describing the REST Input Message: SCC_SUBMITCONST_REQ

Refer to the Submit Constituent SOAP Service Operation.

Describing the REST Output Message: SCC_SUBMITCONST_RESP

Refer to the Submit Constituent SOAP Service Operation.

Describing the REST Output Fault Message: SCC_FAULT_RESP_R

Refer to the Submit Constituent SOAP Service Operation.

Using Get Photo Web Services

The section describes the SOAP and REST Get Photo web services.

Using the SOAP Get Photo Web Service Operation

This is a description of the SOAP Get Photo Web Service Operation:

Service

SCC_CONSTITUENT

Operation

SCC_GETPHOTO

Summary

The inbound Get Photo service retrieves and encodes the constituent's photo image into a base64data string and populates the response message directly with the HTML image.

Description

This Service Operation retrieves the constituent photo image that is saved within the Employee Photo record.

- Request Parameters:
 - EMPLID
 - LanguageCd
 - SCC_PROFILE_ID
- Validation performed for Get Photo:
Self-service – Photo requests are always built with EMPLID = UserId's EMPLID.

Users

Student

Processing

This service operation performs the following steps:

- Verify required input parameters exist.
- Performs the above mentioned validations on the input parameters.
- Responds with information/error messages.

Output

Response message contains photo information/error messages for specified constituent.

Error Conditions

The service operation results in error in the following conditions:

- Invalid input parameters.
- Any of the validations mentioned above fail.

Describing the SOAP Input Message: SCC_GETPHOTO_REQ

The following diagram shows the input message structure:

This example illustrates the fields and controls on the SCC_GETPHOTO_REQ Message Structure. You can find definitions for the fields and controls later on this page.

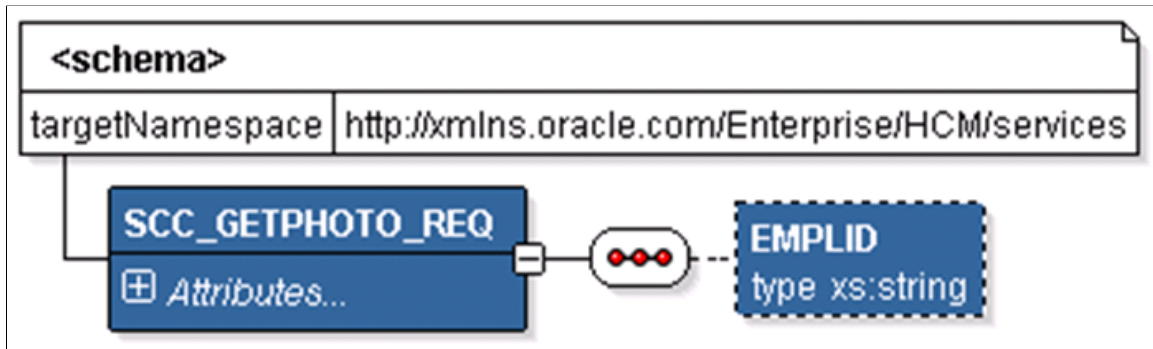

The following is an example of the SCC_GETPHOTO_REQ message that the SCC_GETPHOTO service operation receives from an SCE request:

```
<?xml version="1.0"?>
<SCC_GETPHOTO_REQ xmlns="http://xmlns.oracle.com/Enterprise/services"/>
```

Describing the SOAP Output Message: SCC_GETPHOTO_RESP

When the Integration Broker receives the SCC_GETPHOTO_REQ message, it responds with the SCC_GETPHOTO_RESP message the structure of which is shown below:

This example illustrates the fields and controls on the SCC_GETPHOTO_RESP Message Structure. You can find definitions for the fields and controls later on this page.

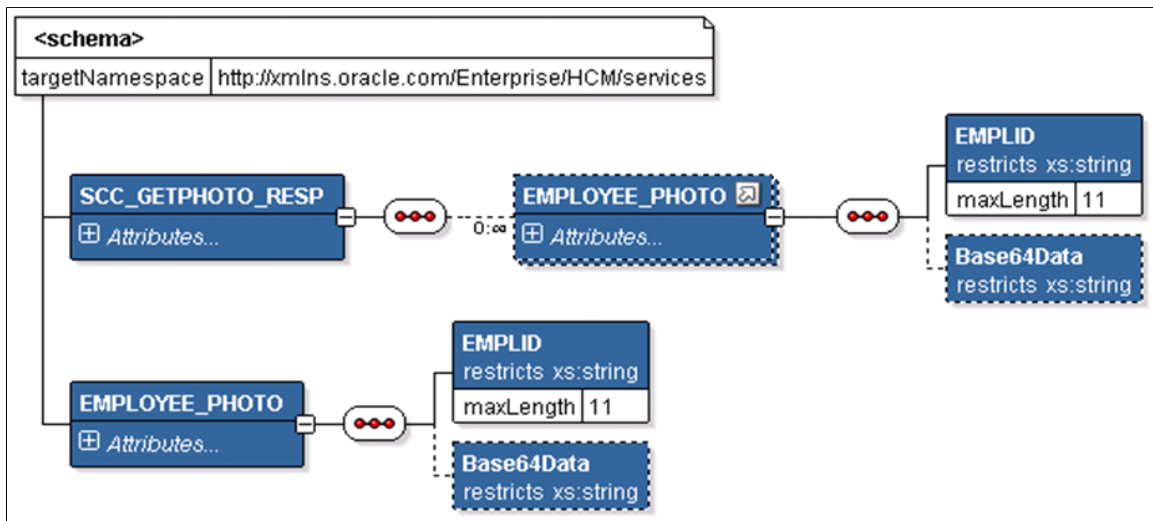

The following is an example of the SCC_GETPHOTO_RESP message that the SCC_GETPHOTO service operation transmits to the UI:

```
<?xml version="1.0"?>
<SCC_GETPHOTO_RESP xmlns="http://xmlns.oracle.com/Enterprise/services">
  <EMPLOYEE_PHOTO>
    <EMPLID>CCSCE0001</EMPLID>
    <Base64Data>/9j/4AAQSkZJRgABAQEASABIAAD//gAgR2VuZXJhdGVkIGJ5ICBJSkcgSlBFRyBMaWJyYXJz
    5/
    +EbVkv4aWYAAElJKgAIAAAADgAOAQIAeAAAAALYAAAAPAQIABgAAAC4BAAAQAQIAFgAAADQBAAASQAQAQA=>
```

```

AAEAAAAa
AQUAAQAAAEoBAAAbaQUAAQAAAFIBAAAoAQMAAQAAAAIAAAAxAQIAHAAAAFoBAAAyAQIA..... .==</Ba⇒

se64Data>
</EMPLOYEE_PHOTO>
</SCC_GETPHOTO_RESP>

```

Describing the SOAP Output Fault Message: SCC_FAULT_RESP

When the Integration Broker receives the SCC_GETPHOTO_REQ message and a validation fault is detected, it responds with the output fault message SCC_FAULT_RESP that consists of error message number, set number and the error message text.

Using the REST Get Photo Web Service Operation

This is a description of the SOAP Get Photo Web Service Operation:

Service

SCC_CONSTITUENT_R

Operation

SCC_GETPHOTO_R_GET

EndPoint

http://<hostname>:<port>//PSIGW/RESTListeningConnector/SCC_GETPHOTO_R.v1/ photo/get?
SCC_PROFILE_ID={SCC_PROFILE_ID}&languageCd={languageCd}

Summary

Refer to the Get Photo SOAP Service Operation.

Description

Refer to the Get Photo SOAP Service Operation.

Users

Refer to the Get Photo SOAP Service Operation.

Processing

Refer to the Get Photo SOAP Service Operation.

Output

Refer to the Get Photo SOAP Service Operation.

Error Conditions

Refer to the Get Photo SOAP Service Operation.

Describing the REST Input Message: SCC_GETPHOTO_REQ_R

Refer to the Get Photo SOAP Service Operation.

Describing the REST Output Message: SCC_GETPHOTO_RESP

Refer to the Get Photo SOAP Service Operation.

Describing the REST Output Fault Message: SCC_FAULT_RESP_R

Refer to the Get Photo SOAP Service Operation.

Using Get Checklist Web Services

The section describes the SOAP and REST Get Checklist web services.

Using the SOAP Get Checklist Web Service Operation

This is a description of the SOAP Get Checklist Web Service Operation:

Service

SCC_CONSTITUENT

Operation

SCC_GET_CHECKLIST

Summary

The inbound Get Checklist service retrieves Self-service Checklist items for a person

Description

This Service Operation retrieves personal checklist details of the constituent.

- Request Parameters (not mandatory):
 - SEQ_3C
 - LanguageCd
 - SCC_PROFILE_ID
- Validation performed for SCC_GET_CHECKLIST:

Self-service – Get Checklist requests are always built with EMPLID = UserId’s EMPLID.

Users

Student

Processing

This service operation performs the following steps:

- Verify required input parameters exist.
- Performs the above mentioned validations on the input parameters.
- Retrieves the available checklist information.
- Responds with the chec list information/error messages.

Output

Response message contains checklist Information/error messages for constituent.

Error Conditions

The service operation results in error in the following conditions:

- Invalid input parameters.
- Any of the validations mentioned above fail.

Describing the SOAP Input Message: SCC_GET_CHKLIST_REQ

The following diagram shows the input message structure:

This example illustrates the fields and controls on the SCC_GET_CHKLIST_REQ Message Structure. You can find definitions for the fields and controls later on this page.

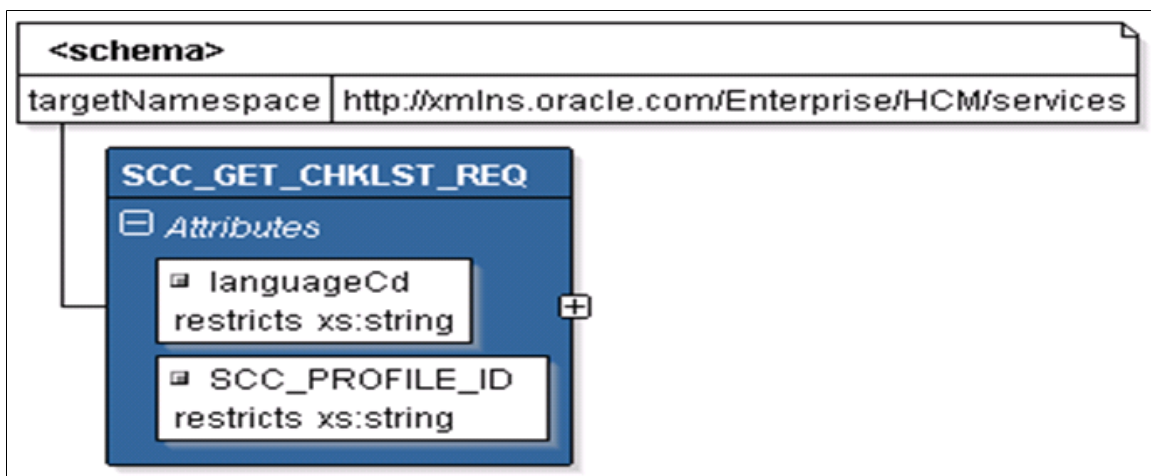

The following is an example of the SCC_GETCHKLST_REQ message that the SCC_GET_CHECKLIST service operation receives from an SCE request:

```
<?xml version="1.0"?>
<SCC_GET_CHKLST_REQ xmlns="http://xmlns.oracle.com/Enterprise/services" xmlns:wsu=
"http://docs.oasis-open.org/wss/2004/01/oasis-200401-wss-wssecurity-utility-1.0.xsd"
"/>
```

Describing the SOAP Output Message: SCC_GET_CHKLST_RESP

When the Integration Broker receives the SCC_GET_CHKLST_REQ message, it responds with the SCC_GET_CHKLST_RESP message the structure of which is shown below:

This example illustrates the fields and controls on the SCC_GET_CHKLST_RESP Message Structure (1 of 3). You can find definitions for the fields and controls later on this page.

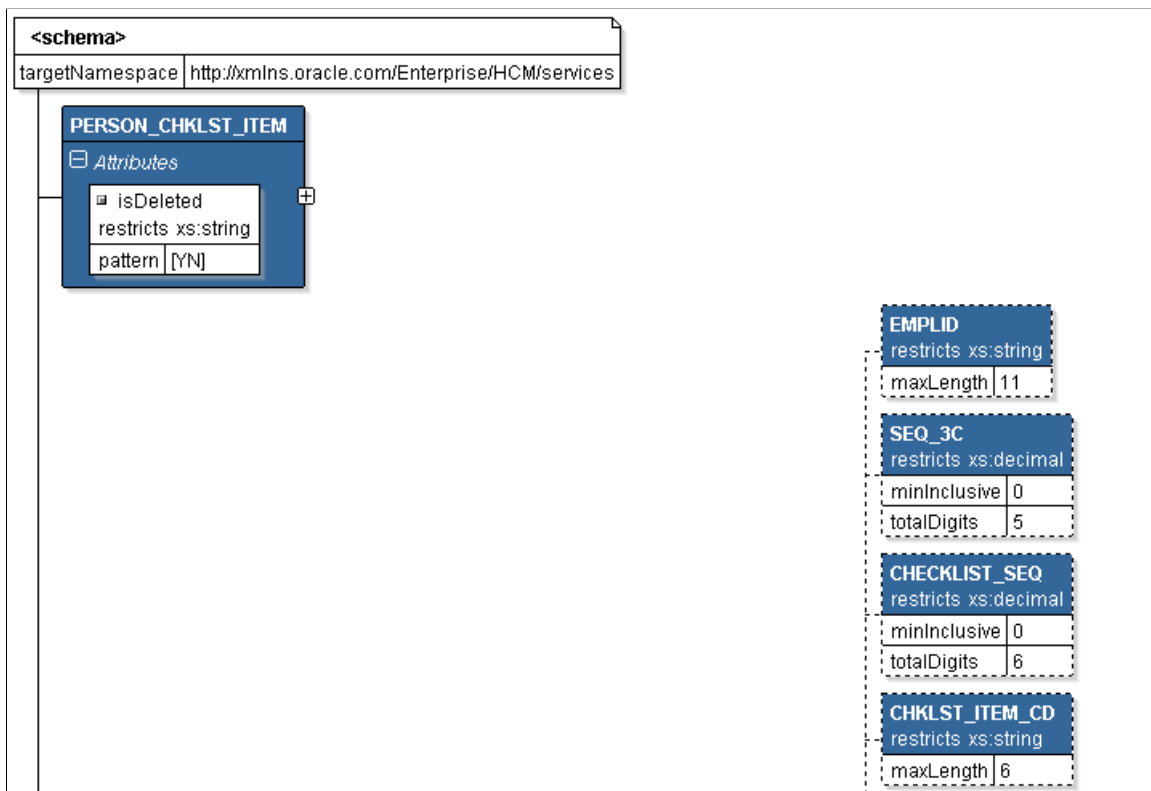

This example illustrates the fields and controls on the SCC_GET_CHKLIST_RESP Message Structure (2 of 3). You can find definitions for the fields and controls later on this page.

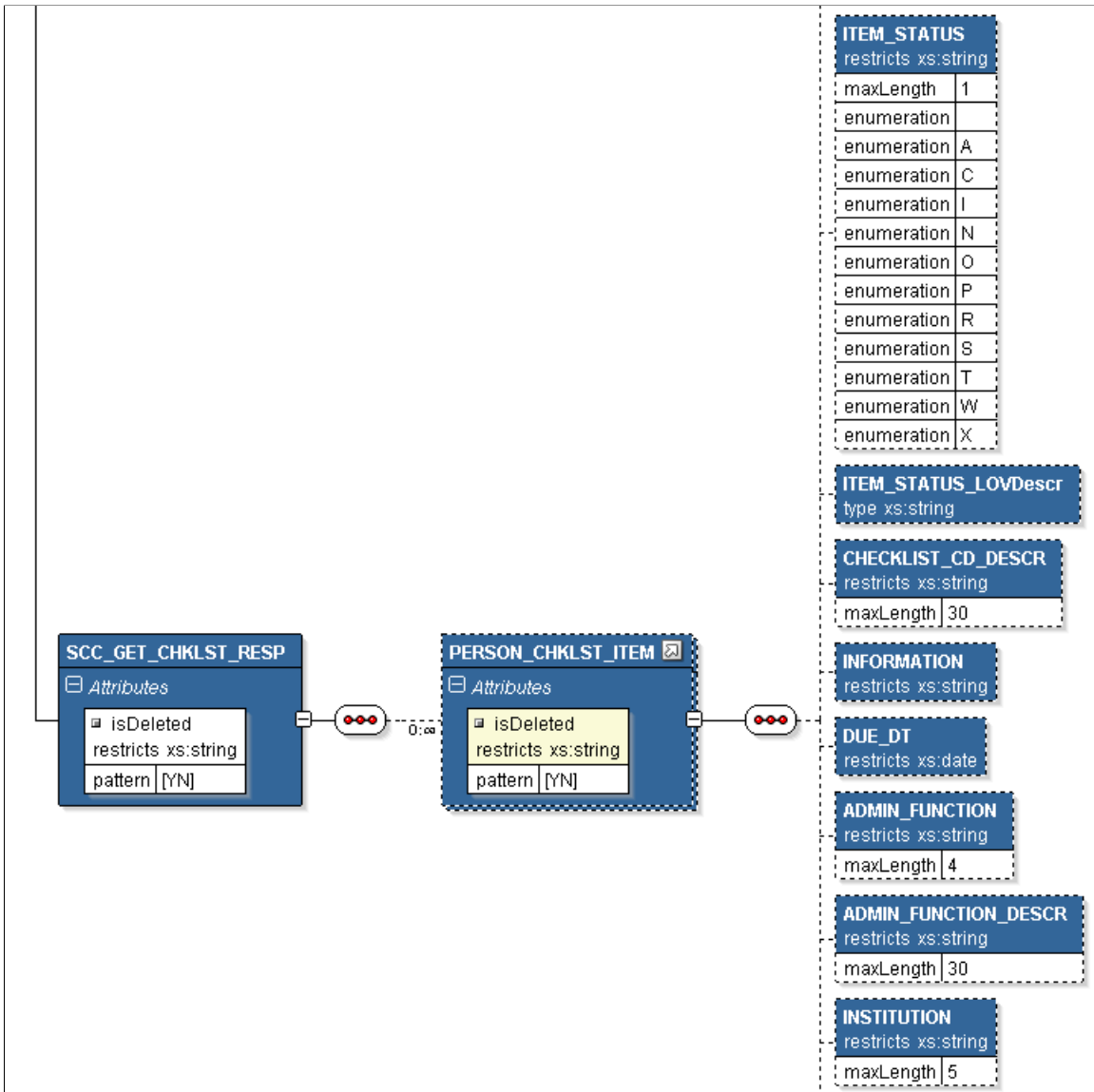

This example illustrates the fields and controls on the SCC_GET_CHKLIST_RESP Message Structure (3 of 3). You can find definitions for the fields and controls later on this page.

INSTITUTION_DESCR	restricts xs:string	maxLength	30
RESPONSIBLE_ID	restricts xs:string	maxLength	11
EMAIL_ADDR	restricts xs:string	maxLength	70
VAR_DATA_SEQ	restricts xs:decimal	minInclusive	0
		totalDigits	4
ASSOC_ID	restricts xs:string	maxLength	11
NAME	restricts xs:string	maxLength	50
SCC_ENTITY_INST_ID	restricts xs:string		
RESPONSIBLE_NAME	restricts xs:string		

The following is an example of the SCC_GET_CHKLIST_RESP message that the SCC_GETCHECKLIST service operation transmits to the UI:

```
<?xml version="1.0"?>
<SCC_GET_CHKLIST_RESP xmlns="http://xmlns.oracle.com/Enterprise/services">
  <PERSON_CHKLIST_ITEM>
    <EMPLID>SCE0001</EMPLID>
    <SEQ_3C>3</SEQ_3C>
    <CHECKLIST_SEQ>200</CHECKLIST_SEQ>
    <CHKLIST_ITEM_CD>ENRL5</CHKLIST_ITEM_CD>
    <ITEM_STATUS>I</ITEM_STATUS>
    <ITEM_STATUS_LOVDescr>Initiated</ITEM_STATUS_LOVDescr>
    <CHECKLIST_CD_DESCR>Complete Enrollment</CHECKLIST_CD_DESCR>
    <INFORMATION>Confirm you study choices in the system by:
      1. Logging onto the Self Service portal of the University system and enrolling
      (if you are unable to do this, contact Student Administration for assistance
      2. Complete the government funding form and submit it on line
      3. Complete the student survey form and submit it
    You are now ready to study!</INFORMATION>
    <DUE_DT>2013-09-15</DUE_DT>
    <ADMIN_FUNCTION>STRM</ADMIN_FUNCTION>
    <ADMIN_FUNCTION_DESCR>Student Term</ADMIN_FUNCTION_DESCR>
    <INSTITUTION>PSUNV</INSTITUTION>
    <INSTITUTION_DESCR>PeopleSoft University</INSTITUTION_DESCR>
    <RESPONSIBLE_ID>KU0007</RESPONSIBLE_ID>
    <EMAIL_ADDR>GENUser1@ap6023fems.us.oracle.com</EMAIL_ADDR>
    <VAR_DATA_SEQ>1</VAR_DATA_SEQ>
    <ASSOC_ID/>
    <NAME/>
  </PERSON_CHKLIST_ITEM>
</SCC_GET_CHKLIST_RESP>
```

```

    <RESPONSIBLE_NAME>Locherty,Betty</RESPONSIBLE_NAME>
</PERSON_CHKLIST_ITEM>
<PERSON_CHKLIST_ITEM>
  <EMPLID>SCE0001</EMPLID>
  <SEQ_3C>3</SEQ_3C>
  <CHECKLIST_SEQ>300</CHECKLIST_SEQ>
  <CHKLIST_ITEM_CD>ENRL2</CHKLIST_ITEM_CD>
  <ITEM_STATUS>I</ITEM_STATUS>
  <ITEM_STATUS_LOVDescr>Initiated</ITEM_STATUS_LOVDescr>
  <CHECKLIST_CD_DESCR>Determine Enrollment Deadlines</CHECKLIST_CD_DESCR>
  <INFORMATION>Ensure you understand the dates by which you must complete
  enrollment-related activities. You can find this information at
  http://www.psunv.edu/handbook/2013_dates.html. Ensure that you can meet
  these deadlines or contact your academic adviser immediately
  if you might be unable to.</INFORMATION>
  <DUE_DT>2013-09-10</DUE_DT>
  <ADMIN_FUNCTION>STRM</ADMIN_FUNCTION>
  <ADMIN_FUNCTION_DESCR>Student Term</ADMIN_FUNCTION_DESCR>
  <INSTITUTION>PSUNV</INSTITUTION>
  <INSTITUTION_DESCR>PeopleSoft University</INSTITUTION_DESCR>
  <RESPONSIBLE_ID>KU0007</RESPONSIBLE_ID>
  <EMAIL_ADDR>GENUser1@ap6023fems.us.oracle.com</EMAIL_ADDR>
  <VAR_DATA_SEQ>1</VAR_DATA_SEQ>
  <ASSOC_ID/>
  <NAME/>
  <RESPONSIBLE_NAME>Locherty,Betty</RESPONSIBLE_NAME>
</PERSON_CHKLIST_ITEM>
<PERSON_CHKLIST_ITEM>
  <EMPLID>SCE0001</EMPLID>
  <SEQ_3C>3</SEQ_3C>
  <CHECKLIST_SEQ>400</CHECKLIST_SEQ>
  <CHKLIST_ITEM_CD>ENRL3</CHKLIST_ITEM_CD>
  <ITEM_STATUS>I</ITEM_STATUS>
  <ITEM_STATUS_LOVDescr>Initiated</ITEM_STATUS_LOVDescr>
  <CHECKLIST_CD_DESCR>Identify Academic Adviser</CHECKLIST_CD_DESCR>
  <INFORMATION>Identify the person who will be your academic adviser and find
  their contact details as soon as possible as you will need to discuss your
  academic plans with them and obtain their approval for your program. You can
  determine who your adviser is by consulting the entry for your program in
  the Handbook at http://www.psunv.edu/handbook/2013_programs.html. If you
  have any trouble, contact Student Administration for assistance.</INFORMATION>
  <DUE_DT>2013-09-05</DUE_DT>
  <ADMIN_FUNCTION>STRM</ADMIN_FUNCTION>
  <ADMIN_FUNCTION_DESCR>Student Term</ADMIN_FUNCTION_DESCR>
  <INSTITUTION>PSUNV</INSTITUTION>
  <INSTITUTION_DESCR>PeopleSoft University</INSTITUTION_DESCR>
  <RESPONSIBLE_ID>KU0007</RESPONSIBLE_ID>
  <EMAIL_ADDR>GENUser1@ap6023fems.us.oracle.com</EMAIL_ADDR>
  <VAR_DATA_SEQ>1</VAR_DATA_SEQ>
  <ASSOC_ID/>
  <NAME/>
  <RESPONSIBLE_NAME>Locherty,Betty</RESPONSIBLE_NAME>
</PERSON_CHKLIST_ITEM>
<PERSON_CHKLIST_ITEM>
  <EMPLID>SCE0001</EMPLID>
  <SEQ_3C>3</SEQ_3C>
  <CHECKLIST_SEQ>500</CHECKLIST_SEQ>
  <CHKLIST_ITEM_CD>ENRL4</CHKLIST_ITEM_CD>
  <ITEM_STATUS>I</ITEM_STATUS>
  <ITEM_STATUS_LOVDescr>Initiated</ITEM_STATUS_LOVDescr>
  <CHECKLIST_CD_DESCR>Work out your timetable</CHECKLIST_CD_DESCR>
  <INFORMATION>Now that you have your academic program resolved, you need
  to work out you weekly lecture and tutorial timetable. This is entirely
  your responsibility but your academic adviser had probably provided you
  with some tips already. Be sure to avoid clashes between commitments
  and to understand where lectures and tutorials will be located so that
  you can allow adequate traveling time to reach them.</INFORMATION>
  <DUE_DT>2013-09-07</DUE_DT>
  <ADMIN_FUNCTION>STRM</ADMIN_FUNCTION>
  <ADMIN_FUNCTION_DESCR>Student Term</ADMIN_FUNCTION_DESCR>
  <INSTITUTION>PSUNV</INSTITUTION>

```

```

<INSTITUTION_DESCR>PeopleSoft University</INSTITUTION_DESCR>
<RESPONSIBLE_ID>KU0007</RESPONSIBLE_ID>
<EMAIL_ADDR>GENUser1@ap6023fems.us.oracle.com</EMAIL_ADDR>
<VAR_DATA_SEQ>1</VAR_DATA_SEQ>
<ASSOC_ID/>
<NAME/>
<RESPONSIBLE_NAME>Locherty,Betty</RESPONSIBLE_NAME>
</PERSON_CHKLIST_ITEM>
<PERSON_CHKLIST_ITEM>
  <EMPLID>SCE0001</EMPLID>
  <SEQ_3C>2</SEQ_3C>
  <CHECKLIST_SEQ>100</CHECKLIST_SEQ>
  <CHKLIST_ITEM_CD>PARK01</CHKLIST_ITEM_CD>
  <ITEM_STATUS>I</ITEM_STATUS>
  <ITEM_STATUS_LOVDescr>Initiated</ITEM_STATUS_LOVDescr>
  <CHECKLIST_CD_DESCR>Parking Application Form</CHECKLIST_CD_DESCR>
  <INFORMATION>Complete a form and the declaration to be able
    to use on-campus parking.</INFORMATION>
  <DUE_DT>2013-09-02</DUE_DT>
  <ADMIN_FUNCTION>GEN</ADMIN_FUNCTION>
  <ADMIN_FUNCTION_DESCR>General</ADMIN_FUNCTION_DESCR>
  <INSTITUTION>PSUNV</INSTITUTION>
  <INSTITUTION_DESCR>PeopleSoft University</INSTITUTION_DESCR>
  <RESPONSIBLE_ID>KU0007</RESPONSIBLE_ID>
  <EMAIL_ADDR>GENUser1@ap6023fems.us.oracle.com</EMAIL_ADDR>
  <VAR_DATA_SEQ>0</VAR_DATA_SEQ>
  <ASSOC_ID/>
  <NAME/>
  <RESPONSIBLE_NAME>Locherty,Betty</RESPONSIBLE_NAME>
</PERSON_CHKLIST_ITEM>
<PERSON_CHKLIST_ITEM>
  <EMPLID>SCE0001</EMPLID>
  <SEQ_3C>2</SEQ_3C>
  <CHECKLIST_SEQ>200</CHECKLIST_SEQ>
  <CHKLIST_ITEM_CD>PARK02</CHKLIST_ITEM_CD>
  <ITEM_STATUS>I</ITEM_STATUS>
  <ITEM_STATUS_LOVDescr>Initiated</ITEM_STATUS_LOVDescr>
  <CHECKLIST_CD_DESCR>Parking Token Fee</CHECKLIST_CD_DESCR>
  <INFORMATION>Fee and deposit for a secure parking token.</INFORMATION>
  <DUE_DT>2013-09-02</DUE_DT>
  <ADMIN_FUNCTION>GEN</ADMIN_FUNCTION>
  <ADMIN_FUNCTION_DESCR>General</ADMIN_FUNCTION_DESCR>
  <INSTITUTION>PSUNV</INSTITUTION>
  <INSTITUTION_DESCR>PeopleSoft University</INSTITUTION_DESCR>
  <RESPONSIBLE_ID>KU0007</RESPONSIBLE_ID>
  <EMAIL_ADDR>GENUser1@ap6023fems.us.oracle.com</EMAIL_ADDR>
  <VAR_DATA_SEQ>0</VAR_DATA_SEQ>
  <ASSOC_ID/>
  <NAME/>
  <RESPONSIBLE_NAME>Locherty,Betty</RESPONSIBLE_NAME>
</PERSON_CHKLIST_ITEM>
<PERSON_CHKLIST_ITEM>
  <EMPLID>SCE0001</EMPLID>
  <SEQ_3C>1</SEQ_3C>
  <CHECKLIST_SEQ>100</CHECKLIST_SEQ>
  <CHKLIST_ITEM_CD>TOEFL</CHKLIST_ITEM_CD>
  <ITEM_STATUS>I</ITEM_STATUS>
  <ITEM_STATUS_LOVDescr>Initiated</ITEM_STATUS_LOVDescr>
  <CHECKLIST_CD_DESCR>Test of Engl as a Foreign Lang</CHECKLIST_CD_DESCR>
  <INFORMATION>All international applicants for whom English is not
    a native language must have their results from the Test of English
    as a Foreign Language (TOEFL) submitted directly to us
    from the testing agency.</INFORMATION>
  <DUE_DT>2013-09-25</DUE_DT>
  <ADMIN_FUNCTION>ADMA</ADMIN_FUNCTION>
  <ADMIN_FUNCTION_DESCR>Admissions Application</ADMIN_FUNCTION_DESCR>
  <INSTITUTION>PSUNV</INSTITUTION>
  <INSTITUTION_DESCR>PeopleSoft University</INSTITUTION_DESCR>
  <RESPONSIBLE_ID>KU0007</RESPONSIBLE_ID>
  <EMAIL_ADDR>GENUser1@ap6023fems.us.oracle.com</EMAIL_ADDR>
  <VAR_DATA_SEQ>1</VAR_DATA_SEQ>

```

```

    <ASSOC_ID/>
    <NAME/>
    <RESPONSIBLE_NAME>Locherty,Betty</RESPONSIBLE_NAME>
  </PERSON_CHKLIST_ITEM>
  <PERSON_CHKLIST_ITEM>
    <EMPLID>SCE0001</EMPLID>
    <SEQ_3C>1</SEQ_3C>
    <CHECKLIST_SEQ>200</CHECKLIST_SEQ>
    <CHKLIST_ITEM_CD>DEAN</CHKLIST_ITEM_CD>
    <ITEM_STATUS>I</ITEM_STATUS>
    <ITEM_STATUS_LOVDescr>Initiated</ITEM_STATUS_LOVDescr>
    <CHECKLIST_CD_DESCR>Dean's Report</CHECKLIST_CD_DESCR>
    <INFORMATION>All applicants are required to submit a dean's report
      from their previous school.</INFORMATION>
    <DUE_DT>2013-09-25</DUE_DT>
    <ADMIN_FUNCTION>ADMA</ADMIN_FUNCTION>
    <ADMIN_FUNCTION_DESCR>Admissions Application</ADMIN_FUNCTION_DESCR>
    <INSTITUTION>PSUNV</INSTITUTION>
    <INSTITUTION_DESCR>PeopleSoft University</INSTITUTION_DESCR>
    <RESPONSIBLE_ID>KU0007</RESPONSIBLE_ID>
    <EMAIL_ADDR>GENUser1@ap6023fems.us.oracle.com</EMAIL_ADDR>
    <VAR_DATA_SEQ>1</VAR_DATA_SEQ>
    <ASSOC_ID/>
    <NAME/>
    <RESPONSIBLE_NAME>Locherty,Betty</RESPONSIBLE_NAME>
  </PERSON_CHKLIST_ITEM>
  <PERSON_CHKLIST_ITEM>
    <EMPLID>SCE0001</EMPLID>
    <SEQ_3C>1</SEQ_3C>
    <CHECKLIST_SEQ>300</CHECKLIST_SEQ>
    <CHKLIST_ITEM_CD>MEDIC</CHKLIST_ITEM_CD>
    <ITEM_STATUS>I</ITEM_STATUS>
    <ITEM_STATUS_LOVDescr>Initiated</ITEM_STATUS_LOVDescr>
    <CHECKLIST_CD_DESCR>Medical Approval</CHECKLIST_CD_DESCR>
    <INFORMATION/>
    <DUE_DT>2013-09-25</DUE_DT>
    <ADMIN_FUNCTION>ADMA</ADMIN_FUNCTION>
    <ADMIN_FUNCTION_DESCR>Admissions Application</ADMIN_FUNCTION_DESCR>
    <INSTITUTION>PSUNV</INSTITUTION>
    <INSTITUTION_DESCR>PeopleSoft University</INSTITUTION_DESCR>
    <RESPONSIBLE_ID>KU0007</RESPONSIBLE_ID>
    <EMAIL_ADDR>GENUser1@ap6023fems.us.oracle.com</EMAIL_ADDR>
    <VAR_DATA_SEQ>1</VAR_DATA_SEQ>
    <ASSOC_ID/>
    <NAME/>
    <RESPONSIBLE_NAME>Locherty,Betty</RESPONSIBLE_NAME>
  </PERSON_CHKLIST_ITEM>
  <PERSON_CHKLIST_ITEM>
    <EMPLID>SCE0001</EMPLID>
    <SEQ_3C>1</SEQ_3C>
    <CHECKLIST_SEQ>400</CHECKLIST_SEQ>
    <CHKLIST_ITEM_CD>TRANS</CHKLIST_ITEM_CD>
    <ITEM_STATUS>I</ITEM_STATUS>
    <ITEM_STATUS_LOVDescr>Initiated</ITEM_STATUS_LOVDescr>
    <CHECKLIST_CD_DESCR>Academic Transcripts</CHECKLIST_CD_DESCR>
    <INFORMATION/>
    <DUE_DT>2013-09-25</DUE_DT>
    <ADMIN_FUNCTION>ADMA</ADMIN_FUNCTION>
    <ADMIN_FUNCTION_DESCR>Admissions Application</ADMIN_FUNCTION_DESCR>
    <INSTITUTION>PSUNV</INSTITUTION>
    <INSTITUTION_DESCR>PeopleSoft University</INSTITUTION_DESCR>
    <RESPONSIBLE_ID>KU0007</RESPONSIBLE_ID>
    <EMAIL_ADDR>GENUser1@ap6023fems.us.oracle.com</EMAIL_ADDR>
    <VAR_DATA_SEQ>1</VAR_DATA_SEQ>
    <ASSOC_ID/>
    <NAME/>
    <RESPONSIBLE_NAME>Locherty,Betty</RESPONSIBLE_NAME>
  </PERSON_CHKLIST_ITEM>
</SCC_GET_CHKLIST_RESP>

```

Describing the SOAP Output Fault Message: SCC_FAULT_RESP

When the Integration Broker receives the SCC_GET_CHKLIST_REQ message and a validation fault is detected, it responds with the output fault message SCC_FAULT_RESP that consists of error message number, set number and the error message text.

Using the REST Get Checklist Web Service Operation

This is a description of the SOAP Get Checklist Web Service Operation:

Service

SCC_CONSTITUENT_R

Operation

SCC_GET_CHECKLIST_R_GET

EndPoint

http://<hostname>:<port>//PSIGW/RESTListeningConnector/SCC_GET_CHECKLIST_R.v1/ checklist/get?SCC_PROFILE_ID={SCC_PROFILE_ID}&languageCd={languageCd}

Summary

Refer to the Get Checklist SOAP Service Operation.

Description

Refer to the Get Checklist SOAP Service Operation.

Users

Refer to the Get Checklist SOAP Service Operation.

Processing

Refer to the Get Checklist SOAP Service Operation.

Output

Refer to the Get Checklist SOAP Service Operation.

Error Conditions

Refer to the Get Checklist SOAP Service Operation.

Describing the REST Input Message: SCC_GET_CHECKLIST_REQ_R

Refer to the Get Checklist SOAP Service Operation.

Describing the REST Output Message: SCC_GET_CHKLIST_RESP

Refer to the Get Checklist SOAP Service Operation.

Describing the REST Output Fault Message: SCC_FAULT_RESP_R.v1

Refer to the Get Checklist SOAP Service Operation.

Using Get Service Indicators Web Services

The section describes the SOAP and REST Get Service Indicators web services.

Using the SOAP Get Service Indicators Web Service Operation

This is a description of the SOAP Get Service Indicators Web Service Operation:

Service

SCC_CONSTITUENT

Operation

SCC_GET_SERVICE_INDICATORS

Summary

The inbound Get Service Indicators service retrieves Self-service Service Indicators items for a person

Description

This Service Operation retrieves Self-service Service Indicators for a person

- Request Parameters (not mandatory):
 - LanguageCd
 - SCC_PROFILE_ID
- Validation performed for SCC_GET_CHECKLIST:

Self-service – Get Service Indicator requests are always built with EMPLID = UserId's EMPLID.

Users

Student

Processing

This service operation performs the following steps:

- Verify required input parameters exist.
- Performs the above mentioned validations on the input parameters.
- Retrieves the available Service Indicators information.
- Responds with the personal service indicator information/error messages.

Output

Response message contains Service Indicators Information/error messages for constituent.

Error Conditions

The service operation results in error in the following conditions:

- Invalid input parameters.
- Any of the validations mentioned above fail.

Describing the SOAP Input Message: SCC_GET_SERVICE_IND_REQ

The following diagram shows the input message structure:

This example illustrates the fields and controls on the SCC_GET_SERVICE_IND_REQ Message Structure. You can find definitions for the fields and controls later on this page.

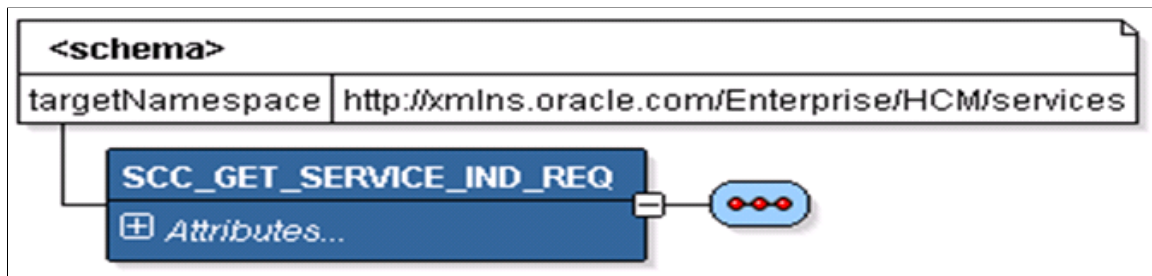

The following is an example of the SCC_GET_SERVICE_IND_REQ message that the SCC_GET_SERVICE_INDICATORS service operation receives from an SCE request:

```
<?xml version="1.0"?>
<SCC_GET_SERVICE_IND_REQ xmlns="http://xmlns.oracle.com/Enterprise/services"
xmlns:wssu="http://docs.oasis-open.org/wss/2004/01/
oasis-200401-wss-wssecurity-utility-1.0.xsd"/>
```

Describing the SOAP Output Message: SCC_GET_SERVICE_IND_RESP

When the Integration Broker receives the SCC_GET_SERVICE_IND_REQ message, it responds with the SCC_GET_SERVICE_IND_RESP message the structure of which is shown below.

This example illustrates the fields and controls on the SCC_GET_SERVICE_IND_RESP Message Structure (1 of 5). You can find definitions for the fields and controls later on this page.

<schema>	
targetNamespace	http://xmlns.oracle.com/Enterprise/HCM/services
<hr/>	
EMPLID	restricts xs:string maxLength 11
SRVC_IND_DTTM	restricts xs:dateTime
SRVC_IND_ACTIVE_DT	restricts xs:date
INSTITUTION	restricts xs:string maxLength 5
INSTITUTION_DESCR	restricts xs:string maxLength 30
SRVC_IND_CD	restricts xs:string maxLength 3
SRVC_IND_CD_DESCR	restricts xs:string maxLength 30
SRVC_IND_REASON	restricts xs:string maxLength 5
SRVC_IND_ACT_TERM	restricts xs:string maxLength 4
SRVC_IND_ACT_TERM_DESCR	restricts xs:string maxLength 30

This example illustrates the fields and controls on the SCC_GET_SERVICE_IND_RESP Message Structure (2 of 5). You can find definitions for the fields and controls later on this page.

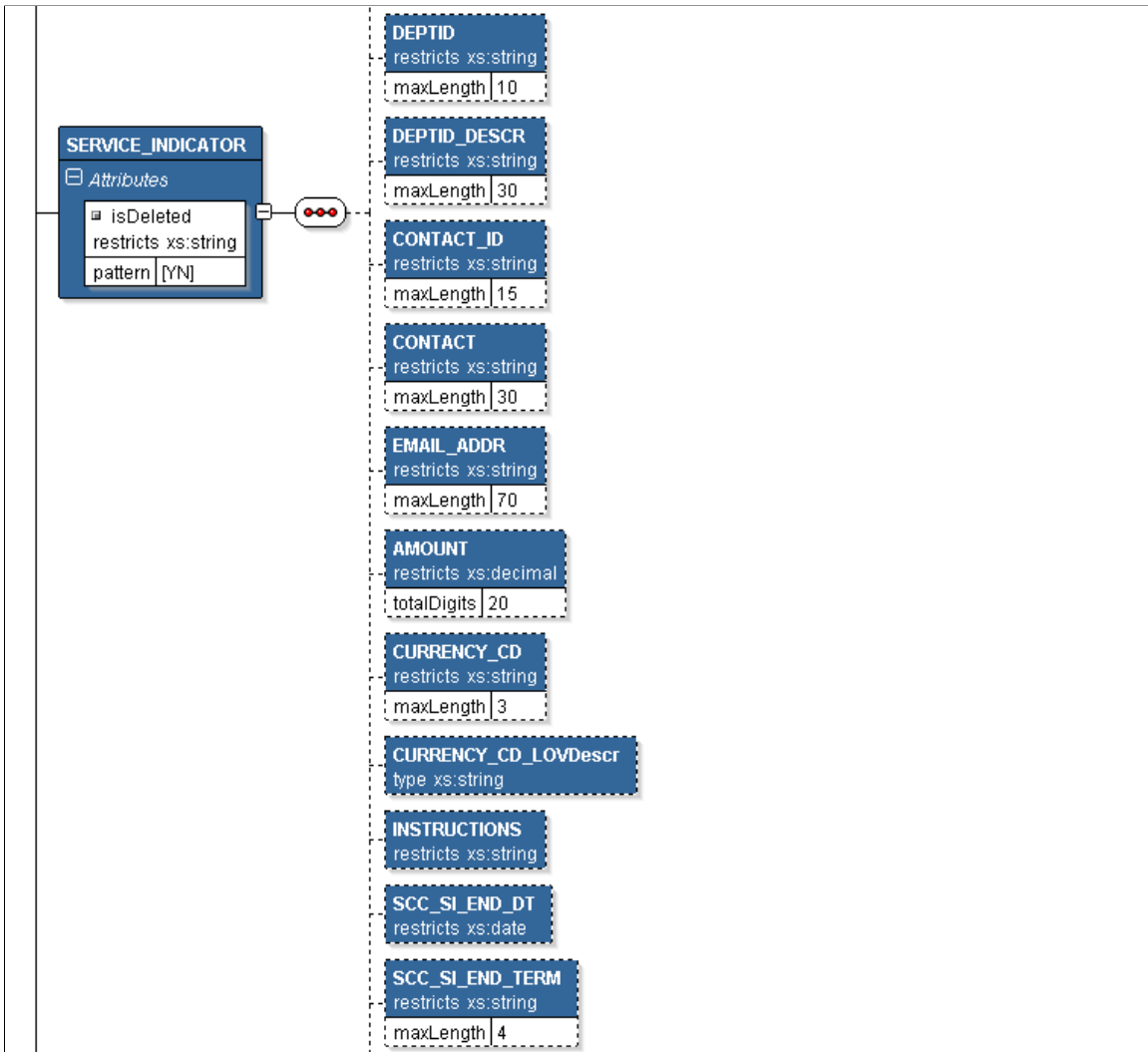

This example illustrates the fields and controls on the SCC_GET_SERVICE_IND_RESP Message Structure (3 of 5). You can find definitions for the fields and controls later on this page.



This example illustrates the fields and controls on the SCC_GET_SERVICE_IND_RESP Message Structure (4 of 5). You can find definitions for the fields and controls later on this page.

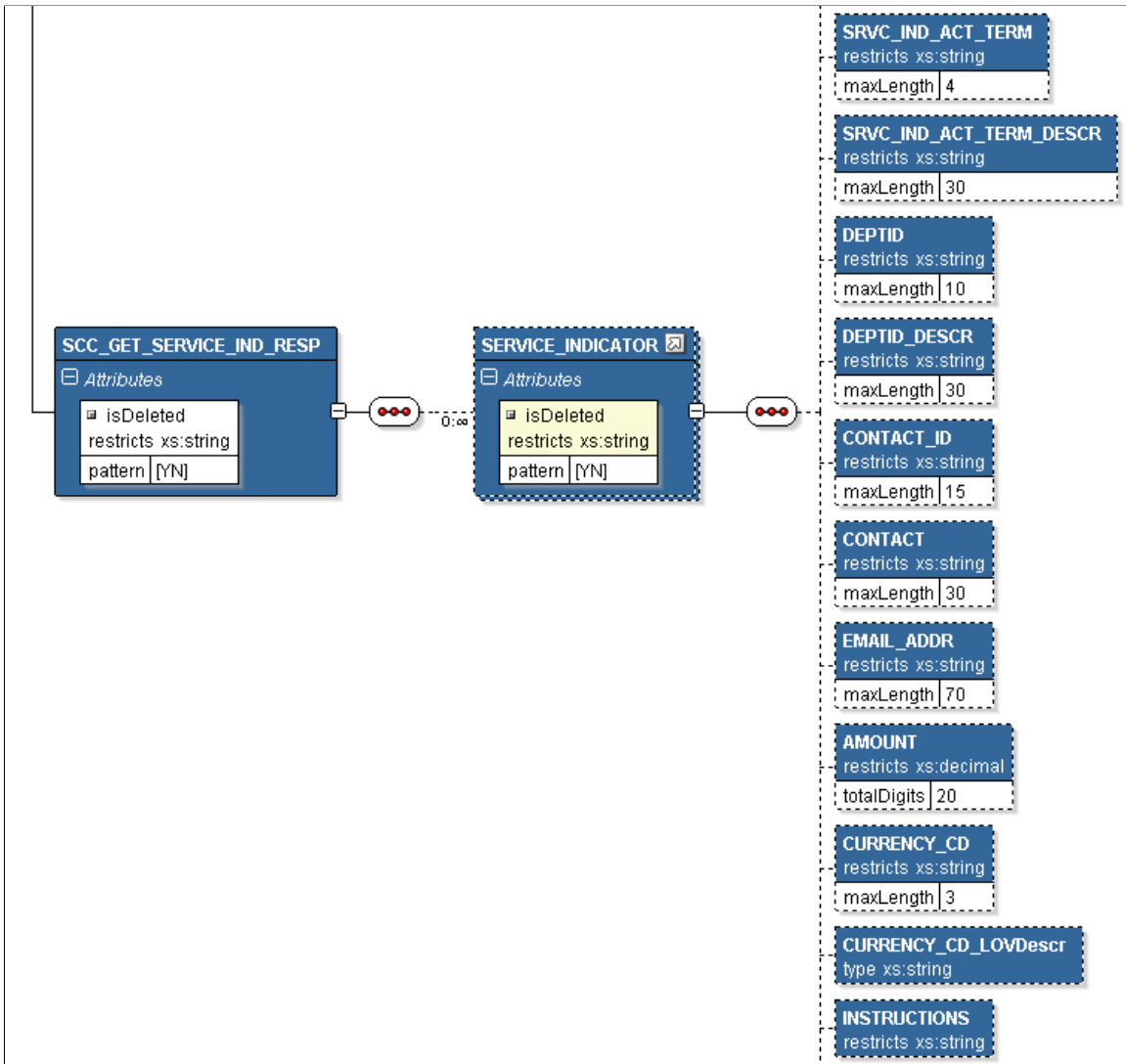

This example illustrates the fields and controls on the SCC_GET_SERVICE_IND_RESP Message Structure (5 of 5). You can find definitions for the fields and controls later on this page.

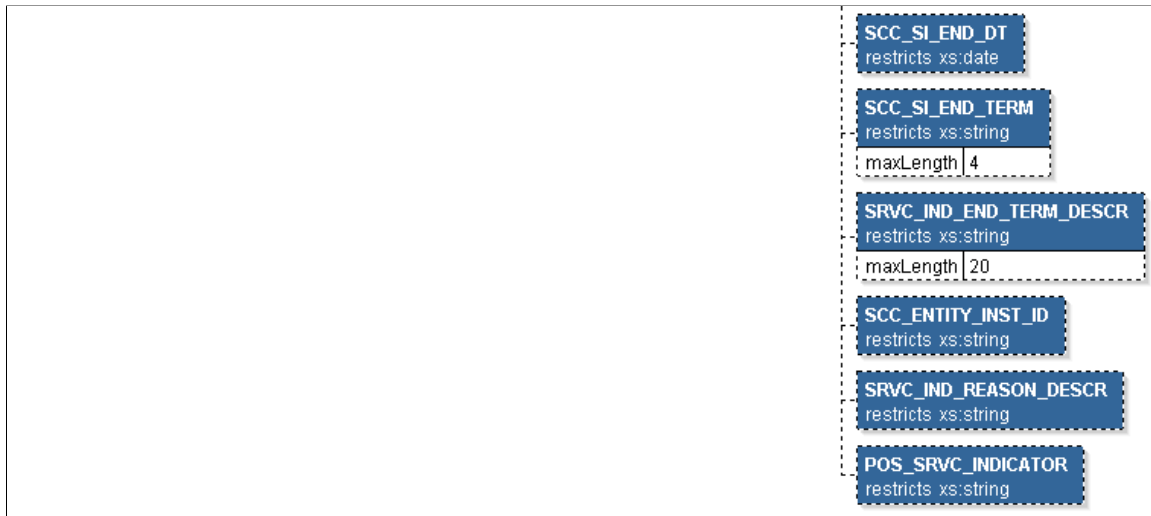

The following is an example of the SCC_GET_SERVICE_IND_RESP message that the SCC_GET_SERVICE_INDICATORS service operation transmits to the UI:

```
<?xml version="1.0"?>
<SCC_GET_SERVICE_IND_RESP xmlns="http://xmlns.oracle.com/Enterprise/services">
  <SERVICE_INDICATOR>
    <EMPLID>SCE0001</EMPLID>
    <SRVC_IND_DTTM>08/26/2013 10:36:44.000000</SRVC_IND_DTTM>
    <SRVC_IND_ACTIVE_DT>2013-03-01</SRVC_IND_ACTIVE_DT>
    <INSTITUTION>PSUNV</INSTITUTION>
    <INSTITUTION_DESCR>PeopleSoft University</INSTITUTION_DESCR>
    <SRVC_IND_CD>RG2</SRVC_IND_CD>
    <SRVC_IND_CD_DESCR>No Enroll - Add/Drop OK</SRVC_IND_CD_DESCR>
    <SRVC_IND_REASON>REG2</SRVC_IND_REASON>
    <SRVC_IND_ACT_TERM>0700</SRVC_IND_ACT_TERM>
    <SRVC_IND_ACT_TERM_DESCR>2013 Spring</SRVC_IND_ACT_TERM_DESCR>
    <DEPTID>10000</DEPTID>
    <DEPTID_DESCR>Human Resources</DEPTID_DESCR>
    <CONTACT_ID>SCE0005</CONTACT_ID>
    <CONTACT>Davis, Paul</CONTACT>
    <EMAIL_ADDR/>
    <AMOUNT>1000</AMOUNT>
    <CURRENCY_CD>USD</CURRENCY_CD>
    <CURRENCY_CD_LOVDescr>US Dollar</CURRENCY_CD_LOVDescr>
    <INSTRUCTIONS/>
    <SCC_SI_END_DT/>
    <SCC_SI_END_TERM/>
    <SRVC_IND_END_TERM_DESCR/>
    <SRVC_IND_REASON_DESCR>Registrar Hold</SRVC_IND_REASON_DESCR>
    <POS_SRVC_INDICATOR>N</POS_SRVC_INDICATOR>
  </SERVICE_INDICATOR>
  <SERVICE_INDICATOR>
    <EMPLID>SCE0001</EMPLID>
    <SRVC_IND_DTTM>08/26/2013 10:35:27.000000</SRVC_IND_DTTM>
    <SRVC_IND_ACTIVE_DT>2013-08-01</SRVC_IND_ACTIVE_DT>
    <INSTITUTION>PSUNV</INSTITUTION>
    <INSTITUTION_DESCR>PeopleSoft University</INSTITUTION_DESCR>
    <SRVC_IND_CD>REF</SRVC_IND_CD>
    <SRVC_IND_CD_DESCR>No Refunds</SRVC_IND_CD_DESCR>
    <SRVC_IND_REASON>NOPAY</SRVC_IND_REASON>
    <SRVC_IND_ACT_TERM/>
    <SRVC_IND_ACT_TERM_DESCR/>
    <DEPTID>10000</DEPTID>
    <DEPTID_DESCR>Human Resources</DEPTID_DESCR>
    <CONTACT_ID>0002</CONTACT_ID>
  </SERVICE_INDICATOR>
</SCC_GET_SERVICE_IND_RESP>
```



```

<CONTACT>Jones,Susan</CONTACT>
<EMAIL_ADDR>nigel.woods@oracle.com</EMAIL_ADDR>
<AMOUNT>2500</AMOUNT>
<CURRENCY_CD>USD</CURRENCY_CD>
<CURRENCY_CD_LOVDescr>US Dollar</CURRENCY_CD_LOVDescr>
<INSTRUCTIONS/>
<SCC_SI_END_DT/>
<SCC_SI_END_TERM/>
<SRVC_IND_END_TERM_DESCR/>
<SRVC_IND_REASON_DESCR>Non Payment of Fees</SRVC_IND_REASON_DESCR>
<POS_SRVC_INDICATOR>N</POS_SRVC_INDICATOR>
</SERVICE_INDICATOR>
</SCC_GET_SERVICE_IND_RESP>

```

Describing the SOAP Output Fault Message: SCC_FAULT_RESP

When the Integration Broker receives the SCC_GET_SERVICE_IND_REQ message and a validation fault is detected, it responds with the output fault message SCC_FAULT_RESP that consists of error message number, set number and the error message text.

Using the REST Get Service Indicators Web Service Operation

This is a description of the SOAP Get Service Indicators Web Service Operation:

Service

SCC_CONSTITUENT_R

Operation

SCC_GET_SERVICE_INDICATORS_R_G

EndPoint

http://<hostname>:<port>//PSIGW/RESTListeningConnector/
 SCC_GET_SERVICE_INDICATORS_R.v1/serviceindicators/get?
 SCC_PROFILE_ID={SCC_PROFILE_ID}&languageCd={languageCd}

Summary

Refer to the Get Service Indicators SOAP Service Operation.

Description

Refer to the Get Service Indicators SOAP Service Operation.

Users

Refer to the Get Service Indicators SOAP Service Operation.

Processing

Refer to the Get Service Indicators SOAP Service Operation.

Output

Refer to the Get Service Indicators SOAP Service Operation.

Error Conditions

Refer to the Get Service Indicators SOAP Service Operation.

Describing the REST Input Message: SCC_GET_SERVICE_IND_REQ_R

Refer to the Get Service Indicators SOAP Service Operation.

Describing the REST Output Message: SCC_GET_SERVICE_IND_RESP

Refer to the Get Service Indicators SOAP Service Operation.

Describing the REST Output Fault Message: SCC_FAULT_RESP_R

Refer to the Get Service Indicators SOAP Service Operation.

Using Get User Preferences Web Services

The section describes the SOAP and REST Get User Preferences web services.

Using the SOAP Get User Preferences Web Service Operation

This is a description of the SOAP Get User Preferences Web Service Operation:

Service

SCC_CONSTITUENT

Operation

SCC_GET_USERPREF

Summary

The inbound Get User Preferences service retrieves user preferences for a person for a person

Description

This Service Operation retrieves personal user preference details of the constituent.

Validation performed for SCC_GET_USERPREF:

Self-service – Get User Preferences requests are always built with EMPLID = UserId's EMPLID.

Users

Student

Processing

This service operation performs the following steps:

- Verify required input parameters exist.
- Performs the above mentioned validations on the input parameters.
- Retrieves the available user preference information.
- Responds with the personal user preference information/error messages.

Output

Response message contains user preferences Information/error messages for constituent.

Error Conditions

The service operation results in error in the following conditions:

- Invalid input parameters.
- Any of the validations mentioned above fail.

Describing the SOAP Input Message: SCC_GET_USERPREF_REQ

The following diagram shows the input message structure:

This example illustrates the fields and controls on the SCC_GET_USERPREF_REQ Message Structure. You can find definitions for the fields and controls later on this page.

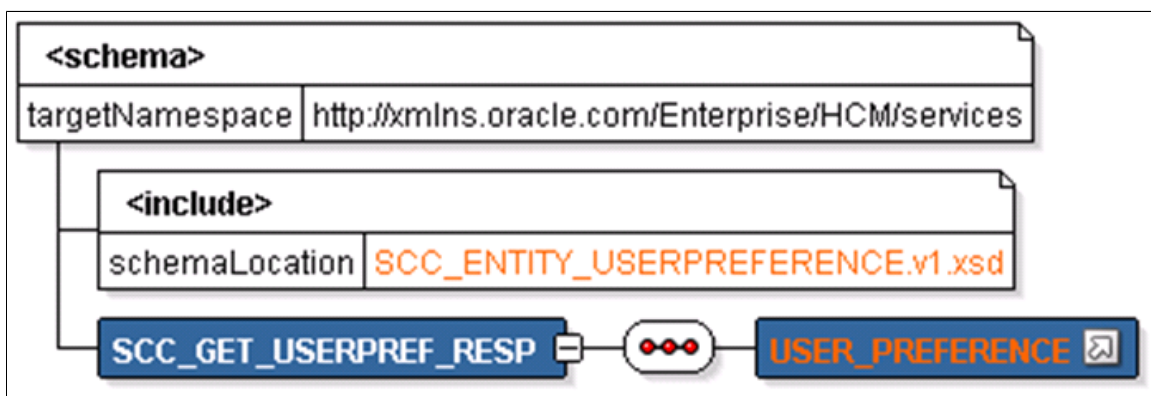

The following is an example of the SCC_GET_USERPREF_REQ message that the SCC_GET_USERPREF service operation receives from an SCE request:

```
<?xml version="1.0"?>
<SCC_GET_USERPREF_REQ xmlns="http://xmlns.oracle.com/Enterprise/services"
xmlns:wss="http://docs.oasis-open.org/wss/2004/01/
oasis-200401-wss-wssecurity-utility-1.0.xsd"/>
```

Describing the SOAP Output Message: SCC_GET_USERPREF_RESP

When the Integration Broker receives the SCC_GET_USERPREF_REQ message, it responds with the SCC_GET_USERPREF_RESP message the structure of which is shown below.:

This example illustrates the fields and controls on the SCC_GETUSERPREF_RESP Message Parameters. You can find definitions for the fields and controls later on this page.

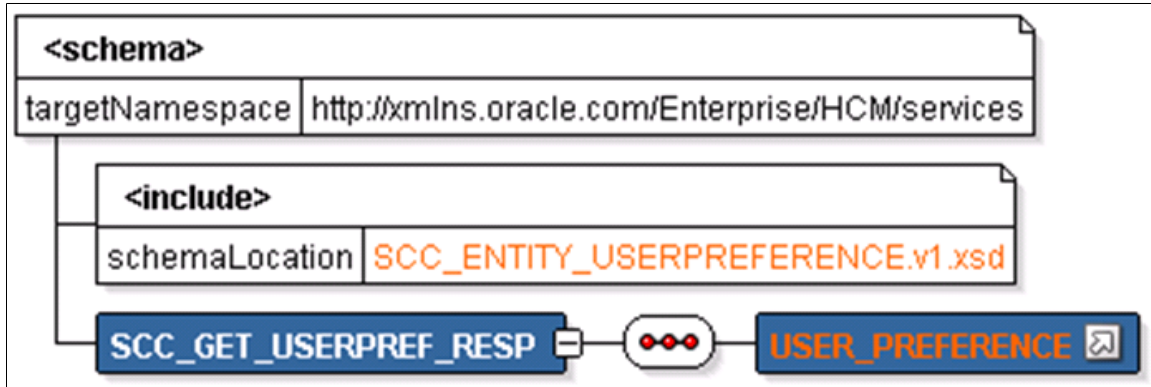

The following is an example of the SCC_GET_USERPREF_RESP message that the SCC_GET_USERPREF service operation transmits to the UI:

```
<?xml version="1.0"?>
<SCC_GET_USERPREF_RESP xmlns="http://xmlns.oracle.com/Enterprise/services">
  <USER_PREFERENCE>
    <EMPLID>SCE0002</EMPLID>
    <NAME_DISPLAY>James Chen</NAME_DISPLAY>
    <USER_PERSONALIZATIONS>
      <USER_PERSONALIZATION>
        <OPRID>SCE0002</OPRID>
        <OPTN_CATEGORY>GENERAL</OPTN_CATEGORY>
        <DESCR>General Options</DESCR>
        <DESCR254>Personalize General Options</DESCR254>
        <USER_PERS_CATEGORIES>
          <USER_PERSONALIZATION_CATEGORY>
            <OPTN_CATEGORY_LVL>PPTL</OPTN_CATEGORY_LVL>
            <OPTN_CATEGORY_LVL_LOVDescr>PeopleTools</OPTN_CATEGORY_LVL_LOVDescr>
            <USEROPTN>ACCESS</USEROPTN>
            <USEROPTN_LOVDescr>Accessibility Features</USEROPTN_LOVDescr>
            <OPTN_CATEGORY>GENERAL</OPTN_CATEGORY>
            <OPTN_CATEGORY_GRP>PIA</OPTN_CATEGORY_GRP>
            <DEFAULT_VALUE>N</DEFAULT_VALUE>
            <DEFAULT_VALUE_DESCR>Accessibility features off</DEFAULT_VALUE_DESCR>
            <OVERRIDE_VALUE>N</OVERRIDE_VALUE>
            <OVERRIDE_VALUE_DESCR>Accessibility features off</OVERRIDE_VALUE_DESCR>
            <EXPLANATION>Provides better support for assistive technologies.

            Use accessible mode layout - This option is for use with screen reader=>
s.
            Page elements (fields, links, buttons, etc.) are presented linearly to=>
            assistive software.

            Use standard mode layout - This option supports assistive technologie=>
s
            without altering the page design.

            Accessibility Features disabled - This option is the default.</EXPLANA=>
```

TION>

```

<OVERRIDE_DROPDOWN_VALUES>
  <OVERRIDE_DROPDOWN_VALUE>
    <FIELDVALUE>A</FIELDVALUE>
    <DESCR>Use accessible layout mode</DESCR>
  </OVERRIDE_DROPDOWN_VALUE>
  <OVERRIDE_DROPDOWN_VALUE>
    <FIELDVALUE>N</FIELDVALUE>
    <DESCR>Accessibility features off</DESCR>
  </OVERRIDE_DROPDOWN_VALUE>
  <OVERRIDE_DROPDOWN_VALUE>
    <FIELDVALUE>S</FIELDVALUE>
    <DESCR>Use standard layout mode</DESCR>
  </OVERRIDE_DROPDOWN_VALUE>
</OVERRIDE_DROPDOWN_VALUES>
</USER_PERSONALIZATION_CATEGORY>
</USER_PERS_CATEGORIES>
</USER_PERSONALIZATION>
<USER_PERSONALIZATION>
  <OPRID>SCE0002</OPRID>
  <OPTN_CATEGORY>LOCALE</OPTN_CATEGORY>
  <DESCR>Regional Settings</DESCR>
  <DESCR254>Personalize Regional Settings</DESCR254>
  <USER_PERS_CATEGORIES>
    <USER_PERSONALIZATION_CATEGORY>
      <OPTN_CATEGORY_LVL>PPTL</OPTN_CATEGORY_LVL>
      <OPTN_CATEGORY_LVL_LOVDescr>PeopleTools</OPTN_CATEGORY_LVL_LOVDescr>
      <USEROPTN>DCSP</USEROPTN>
      <USEROPTN_LOVDescr>Decimal Separator</USEROPTN_LOVDescr>
      <OPTN_CATEGORY>LOCALE</OPTN_CATEGORY>
      <OPTN_CATEGORY_GRP>PIA</OPTN_CATEGORY_GRP>
      <DEFAULT_VALUE>.</DEFAULT_VALUE>
      <DEFAULT_VALUE_DESCR>.</DEFAULT_VALUE_DESCR>
      <OVERRIDE_VALUE/>
      <OVERRIDE_VALUE_DESCR/>
      <EXPLANATION>Any single character, commonly either '.' or ','.
        Determines if 1.00 is displayed as 1.00 or 1,00.</EXPLANATION>
      <OVERRIDE_DROPDOWN_VALUES>
        <OVERRIDE_DROPDOWN_VALUE>
          <FIELDVALUE/>
          <DESCR/>
        </OVERRIDE_DROPDOWN_VALUE>
      </OVERRIDE_DROPDOWN_VALUES>
    </USER_PERSONALIZATION_CATEGORY>
    <USER_PERSONALIZATION_CATEGORY>
      <OPTN_CATEGORY_LVL>PPTL</OPTN_CATEGORY_LVL>
      <OPTN_CATEGORY_LVL_LOVDescr>PeopleTools</OPTN_CATEGORY_LVL_LOVDescr>
      <USEROPTN>DFRMT</USEROPTN>
      <USEROPTN_LOVDescr>Date Format</USEROPTN_LOVDescr>
      <OPTN_CATEGORY>LOCALE</OPTN_CATEGORY>
      <OPTN_CATEGORY_GRP>PIA</OPTN_CATEGORY_GRP>
      <DEFAULT_VALUE>M</DEFAULT_VALUE>
      <DEFAULT_VALUE_DESCR>MMDDYY</DEFAULT_VALUE_DESCR>
      <OVERRIDE_VALUE/>
      <OVERRIDE_VALUE_DESCR/>
      <EXPLANATION>Determines whether date will be displayed with
        the day first, month first, or year first.
        The century (YYYY or YY) is controlled as a page field property,
        not a personalization.</EXPLANATION>
      <OVERRIDE_DROPDOWN_VALUES>
        <OVERRIDE_DROPDOWN_VALUE>
          <FIELDVALUE>D</FIELDVALUE>
          <DESCR>DDMMYY</DESCR>
        </OVERRIDE_DROPDOWN_VALUE>
        <OVERRIDE_DROPDOWN_VALUE>
          <FIELDVALUE>M</FIELDVALUE>
          <DESCR>MMDDYY</DESCR>
        </OVERRIDE_DROPDOWN_VALUE>
        <OVERRIDE_DROPDOWN_VALUE>
          <FIELDVALUE>Y</FIELDVALUE>
          <DESCR>YYMMDD</DESCR>
      </OVERRIDE_DROPDOWN_VALUES>
    </USER_PERSONALIZATION_CATEGORY>
  </USER_PERS_CATEGORIES>
</USER_PERSONALIZATION>

```

```

    </OVERRIDE_DROPDOWN_VALUE>
  </OVERRIDE_DROPDOWN_VALUES>
</USER_PERSONALIZATION_CATEGORY>
<USER_PERSONALIZATION_CATEGORY>
  <OPTN_CATEGORY_LVL>PPTL</OPTN_CATEGORY_LVL>
  <OPTN_CATEGORY_LVL_LOVDescr>PeopleTools</OPTN_CATEGORY_LVL_LOVDescr>
  <USEROPTN>DTSP</USEROPTN>
  <USEROPTN_LOVDescr>Date Separator</USEROPTN_LOVDescr>
  <OPTN_CATEGORY>LOCALE</OPTN_CATEGORY>
  <OPTN_CATEGORY_GRP>PIA</OPTN_CATEGORY_GRP>
  <DEFAULT_VALUE></DEFAULT_VALUE>
  <DEFAULT_VALUE_DESCR></DEFAULT_VALUE_DESCR>
  <OVERRIDE_VALUE/>
  <OVERRIDE_VALUE_DESCR/>
  <EXPLANATION>Any single character, common values are ' /', '-' or '.'. =>

```

This determines whether the date will be shown as DD/MM/YY or DD-MM-YY=>

```

  for example.</EXPLANATION>
<OVERRIDE_DROPDOWN_VALUES>
  <OVERRIDE_DROPDOWN_VALUE>
    <FIELDVALUE/>
    <DESCR/>
  </OVERRIDE_DROPDOWN_VALUE>
</OVERRIDE_DROPDOWN_VALUES>
</USER_PERSONALIZATION_CATEGORY>
<USER_PERSONALIZATION_CATEGORY>
  <OPTN_CATEGORY_LVL>PPTL</OPTN_CATEGORY_LVL>
  <OPTN_CATEGORY_LVL_LOVDescr>PeopleTools</OPTN_CATEGORY_LVL_LOVDescr>
  <USEROPTN>TFRMT</USEROPTN>
  <USEROPTN_LOVDescr>Time Format</USEROPTN_LOVDescr>
  <OPTN_CATEGORY>LOCALE</OPTN_CATEGORY>
  <OPTN_CATEGORY_GRP>PIA</OPTN_CATEGORY_GRP>
  <DEFAULT_VALUE>C</DEFAULT_VALUE>
  <DEFAULT_VALUE_DESCR>12 hour clock</DEFAULT_VALUE_DESCR>
  <OVERRIDE_VALUE/>
  <OVERRIDE_VALUE_DESCR/>
  <EXPLANATION>Determines whether time will be displayed in civilian (8:0=>

```

5:00 PM)

or military (20:05:00) time format. The determination of whether seco=>

nds and

```

  microseconds are displayed is made at the field level, and is not a
  personalization.</EXPLANATION>
<OVERRIDE_DROPDOWN_VALUES>
  <OVERRIDE_DROPDOWN_VALUE>
    <FIELDVALUE>C</FIELDVALUE>
    <DESCR>12 hour clock</DESCR>
  </OVERRIDE_DROPDOWN_VALUE>
  <OVERRIDE_DROPDOWN_VALUE>
    <FIELDVALUE>M</FIELDVALUE>
    <DESCR>24 hour clock</DESCR>
  </OVERRIDE_DROPDOWN_VALUE>
</OVERRIDE_DROPDOWN_VALUES>
</USER_PERSONALIZATION_CATEGORY>
<USER_PERSONALIZATION_CATEGORY>
  <OPTN_CATEGORY_LVL>PPTL</OPTN_CATEGORY_LVL>
  <OPTN_CATEGORY_LVL_LOVDescr>PeopleTools</OPTN_CATEGORY_LVL_LOVDescr>
  <USEROPTN>TSEP</USEROPTN>
  <USEROPTN_LOVDescr>Digit Group Separator</USEROPTN_LOVDescr>
  <OPTN_CATEGORY>LOCALE</OPTN_CATEGORY>
  <OPTN_CATEGORY_GRP>PIA</OPTN_CATEGORY_GRP>
  <DEFAULT_VALUE>,</DEFAULT_VALUE>
  <DEFAULT_VALUE_DESCR>,</DEFAULT_VALUE_DESCR>
  <OVERRIDE_VALUE/>
  <OVERRIDE_VALUE_DESCR/>
  <EXPLANATION>Any single character, commonly either ',' or '.'.
  Determines whether 1000 shows as 1,000 or 1.000.</EXPLANATION>

```

```

    <OVERRIDE_VALUES>
      <OVERRIDE_VALUE>
        <FIELDVALUE/>
        <DESCR/>
      </OVERRIDE_VALUE>
    </OVERRIDE_VALUES>
  </USER_PERSONALIZATION_CATEGORY>
</USER_PERS_CATEGORIES>
</USER_PERSONALIZATION>
</USER_PERSONALIZATIONS>
</USER_PREFERENCE>
</SCC_GET_USERPREF_RESP>

```

Describing the SOAP Output Fault Message: SCC_FAULT_RESP

When the Integration Broker receives the SCC_GET_USERPREF_REQ message and a validation fault is detected, it responds with the output fault message SCC_FAULT_RESP that consists of error message number, set number and the error message text.

Using the REST Get User Preferences Web Service Operation

This is a description of the SOAP Get User Preferences Web Service Operation:

Service

SCC_CONSTITUENT_R

Operation

SCC_GET_USERPREF_R_GET

EndPoint

http://<hostname>:<port>//PSIGW/RESTListeningConnector/SCC_GET_USERPREF_R.v1/ userpref/get

Summary

Refer to the Get User Preferences SOAP Service Operation.

Description

Refer to the Get User Preferences SOAP Service Operation.

Users

Refer to the Get User Preferences SOAP Service Operation.

Processing

Refer to the Get User Preferences SOAP Service Operation.

Output

Refer to the Get User Preferences SOAP Service Operation.

Error Conditions

Refer to the Get User Preferences SOAP Service Operation.

Describing the REST Input Message: SCC_GET_USERPREF_REQ_R

Refer to the Get User Preferences SOAP Service Operation.

Describing the REST Output Message: SCC_GET_USERPREF_RESP

Refer to the Get User Preferences SOAP Service Operation.

Describing the REST Output Fault Message: SCC_GET_USERPREF_FAULT

Refer to the Get User Preferences SOAP Service Operation.

Using Submit User Preferences Web Services

The section describes the SOAP and REST Submit User Preferences web services.

Using the SOAP Submit User Preferences Web Service Operation

This is a description of the SOAP Submit User Preferences Web Service Operation:

Service

SCC_CONSTITUENT

Operation

SCC_SUBMIT_USERPREF

Summary

The inbound Submit User Preferences service submits user preferences for a person.

Description

This Service Operation submits user preference details for the constituent.

Validation performed for SCC_SUBMIT_USERPREF:

Self-service – Submit User Preferences requests are always built with EMPLID = UserId's EMPLID.

Users

Student

Processing

This service operation performs the following steps:

- Verify required input parameters exist.
- Performs the above mentioned validations on the input parameters.
- Retrieves the available personal information.
- Responds with the personal information/error messages.

Output

Response message contains user preferences information/error messages for constituent.

Error Conditions

The service operation results in error in the following conditions:

- Invalid input parameters.
- Any of the validations mentioned above fail.

Describing the SOAP Input Message: SCC_SUBMIT_USERPREF_REQ

The following diagram shows the input message structure:

This example illustrates the fields and controls on the SCC_SUBMIT_USERPREF_REQ Message Structure. You can find definitions for the fields and controls later on this page.

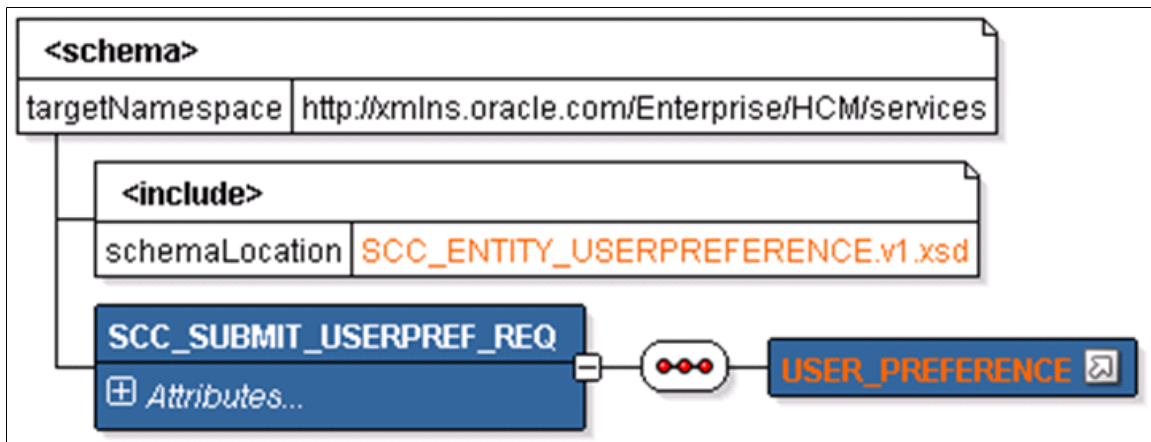

```
<?xml version="1.0"?>
<SCC_SUBMIT_USERPREF_REQ xmlns="http://xmlns.oracle.com/Enterprise/services">
  <USER_PREFERENCE>
    <EMPLID/>
    <NAME_DISPLAY/>
    <OPERATOR_DEFAULT>
      <OPRID>PS</OPRID>
      <INSTITUTION>PSUNV</INSTITUTION>
      <INSTITUTION_LOVDescr>PeopleSoft University</INSTITUTION_LOVDescr>
      <STRM>0505</STRM>
      <STRM_LOVDescr>2003 Fall</STRM_LOVDescr>
      <AID_YEAR>2004</AID_YEAR>
    </USER_PREFERENCE>
  </SCC_SUBMIT_USERPREF_REQ>
</xml>
```

```

    <AID_YEAR_LOVDescr>Financial Aid Year 2003-2004</AID_YEAR_LOVDescr>
    <ACAD_CAREER>UGRD</ACAD_CAREER>
    <ACAD_CAREER_LOVDescr>Undergraduate</ACAD_CAREER_LOVDescr>
  </OPERATOR_DEFAULT>
  <COMM_PREFERENCE>
    <EMPLID>KU0007</EMPLID>
    <LANG_CD>ENG</LANG_CD>
    <LANG_CD_LOVDescr>English</LANG_CD_LOVDescr>
    <COMM_METHOD>E</COMM_METHOD>
    <COMM_METHOD_LOVDescr>E-Mail</COMM_METHOD_LOVDescr>
  </COMM_PREFERENCE>
  <NOTIFICATION_PREFERENCE>
    <EMPLID>KU0007</EMPLID>
    <SCC_EMAIL_NTF_IND>Y</SCC_EMAIL_NTF_IND>
    <SCC_SMS_NTF_IND>Y</SCC_SMS_NTF_IND>
    <E_ADDR_TYPE>HOME</E_ADDR_TYPE>
    <PHONE_TYPE>HOME</PHONE_TYPE>
    <SCC_NTF_LANG/>
    <PHONE>555/123-4567</PHONE>
    <EMAIL_ADDR>GENUser1@ap6023fems.us.oracle.com</EMAIL_ADDR>
  </NOTIFICATION_PREFERENCE>
  <USER_PERSONALIZATIONS>
    <USER_PERSONALIZATION>
      <OPRID>PS</OPRID>
      <OPTN_CATEGORY>GENERAL</OPTN_CATEGORY>
      <DESCR>General Options</DESCR>
      <DESCR254>Personalize General Options</DESCR254>
      <USER_PERS_CATEGORIES>
        <USER_PERSONALIZATION_CATEGORY>
          <OPTN_CATEGORY_LVL>PPTL</OPTN_CATEGORY_LVL>
          <OPTN_CATEGORY_LVL_LOVDescr>PeopleTools</OPTN_CATEGORY_LVL_LOVDescr>
          <USEROPTN>ACCESS</USEROPTN>
          <USEROPTN_LOVDescr>Accessibility Features</USEROPTN_LOVDescr>
          <OPTN_CATEGORY>GENERAL</OPTN_CATEGORY>
          <OPTN_CATEGORY_GRP>PIA</OPTN_CATEGORY_GRP>
          <DEFAULT_VALUE>N</DEFAULT_VALUE>
          <DEFAULT_VALUE_DESCR>Accessibility features off</DEFAULT_VALUE_DESCR>
          <OVERRIDE_VALUE>N</OVERRIDE_VALUE>
          <OVERRIDE_VALUE_DESCR>Accessibility features off</OVERRIDE_VALUE_DESCR>
          <EXPLANATION>Provides better support for assistive technologies.

          Use accessible mode layout - This option is for use with screen reader⇒
s.
          Page elements (fields, links, buttons, etc.) are presented linearly to⇒
          assistive software.

          Use standard mode layout - This option supports assistive technologie⇒
s
          without altering the page design.

          Accessibility Features disabled - This option is the default.</EXPLANA⇒
TION>
        </USER_PERSONALIZATION_CATEGORY>
      </USER_PERS_CATEGORIES>
    </USER_PERSONALIZATION>
  </USER_PERSONALIZATIONS>
  <OVERRIDE_VALUES>
    <OVERRIDE_VALUE>
      <FIELDVALUE>A</FIELDVALUE>
      <DESCR>Use accessible layout mode</DESCR>
    </OVERRIDE_VALUE>
    <OVERRIDE_VALUE>
      <FIELDVALUE>N</FIELDVALUE>
      <DESCR>Accessibility features off</DESCR>
    </OVERRIDE_VALUE>
    <OVERRIDE_VALUE>
      <FIELDVALUE>S</FIELDVALUE>
      <DESCR>Use standard layout mode</DESCR>
    </OVERRIDE_VALUE>
  </OVERRIDE_VALUES>

```

```

    </USER_PERSONALIZATION_CATEGORY>
  </USER_PERS_CATEGORIES>
</USER_PERSONALIZATION>
<USER_PERSONALIZATION>
  <OPRID>PS</OPRID>
  <OPTN_CATEGORY>LOCALE</OPTN_CATEGORY>
  <DESCR>Regional Settings</DESCR>
  <DESCR254>Personalize Regional Settings</DESCR254>
  <USER_PERS_CATEGORIES>
    <USER_PERSONALIZATION_CATEGORY>
      <OPTN_CATEGORY_LVL>PPTL</OPTN_CATEGORY_LVL>
      <OPTN_CATEGORY_LVL_LOVDescr>PeopleTools</OPTN_CATEGORY_LVL_LOVDescr>
      <USEROPTN>DCSP</USEROPTN>
      <USEROPTN_LOVDescr>Decimal Separator</USEROPTN_LOVDescr>
      <OPTN_CATEGORY>LOCALE</OPTN_CATEGORY>
      <OPTN_CATEGORY_GRP>PIA</OPTN_CATEGORY_GRP>
      <DEFAULT_VALUE>.</DEFAULT_VALUE>
      <DEFAULT_VALUE_DESCR>.</DEFAULT_VALUE_DESCR>
      <OVERRIDE_VALUE/>
      <OVERRIDE_VALUE_DESCR/>
      <EXPLANATION>Any single character, commonly either '.' or ','.
        Determines if 1.00 is displayed as 1.00 or 1,00.</EXPLANATION>
      <OVERRIDE_VALUES>
        <OVERRIDE_VALUE>
          <FIELDVALUE/>
          <DESCR/>
        </OVERRIDE_VALUE>
      </OVERRIDE_VALUES>
    </USER_PERSONALIZATION_CATEGORY>
    <USER_PERSONALIZATION_CATEGORY>
      <OPTN_CATEGORY_LVL>PPTL</OPTN_CATEGORY_LVL>
      <OPTN_CATEGORY_LVL_LOVDescr>PeopleTools</OPTN_CATEGORY_LVL_LOVDescr>
      <USEROPTN>DFRMT</USEROPTN>
      <USEROPTN_LOVDescr>Date Format</USEROPTN_LOVDescr>
      <OPTN_CATEGORY>LOCALE</OPTN_CATEGORY>
      <OPTN_CATEGORY_GRP>PIA</OPTN_CATEGORY_GRP>
      <DEFAULT_VALUE>M</DEFAULT_VALUE>
      <DEFAULT_VALUE_DESCR>MMDDYY</DEFAULT_VALUE_DESCR>
      <OVERRIDE_VALUE>M</OVERRIDE_VALUE>
      <OVERRIDE_VALUE_DESCR>MMDDYY</OVERRIDE_VALUE_DESCR>
      <EXPLANATION>Determines whether date will be displayed with the day fir→
st,
        month first, or year first. The century (YYYY or YY) is controlled as→
a
        page field property, not a personalization.</EXPLANATION>
      <OVERRIDE_VALUES>
        <OVERRIDE_VALUE>
          <FIELDVALUE>D</FIELDVALUE>
          <DESCR>DDMMYY</DESCR>
        </OVERRIDE_VALUE>
        <OVERRIDE_VALUE>
          <FIELDVALUE>M</FIELDVALUE>
          <DESCR>MMDDYY</DESCR>
        </OVERRIDE_VALUE>
        <OVERRIDE_VALUE>
          <FIELDVALUE>Y</FIELDVALUE>
          <DESCR>YYMMDD</DESCR>
        </OVERRIDE_VALUE>
      </OVERRIDE_VALUES>
    </USER_PERSONALIZATION_CATEGORY>
  </USER_PERSONALIZATION_CATEGORY>
  <OPTN_CATEGORY_LVL>PPTL</OPTN_CATEGORY_LVL>
  <OPTN_CATEGORY_LVL_LOVDescr>PeopleTools</OPTN_CATEGORY_LVL_LOVDescr>
  <USEROPTN>DTSP</USEROPTN>
  <USEROPTN_LOVDescr>Date Separator</USEROPTN_LOVDescr>
  <OPTN_CATEGORY>LOCALE</OPTN_CATEGORY>
  <OPTN_CATEGORY_GRP>PIA</OPTN_CATEGORY_GRP>
  <DEFAULT_VALUE>/</DEFAULT_VALUE>
  <DEFAULT_VALUE_DESCR>/</DEFAULT_VALUE_DESCR>

```

```

<OVERRIDE_VALUE/>
<OVERRIDE_VALUE_DESCR/>
<EXPLANATION>Any single character, common values are ' /', '-' or '.'. =>

```

This determines whether the date will be shown as DD/MM/YY or DD-MM-YY=>

```

for example.</EXPLANATION>
<OVERRIDE_VALUES>
  <OVERRIDE_VALUE>
    <FIELDVALUE/>
    <DESCR/>
  </OVERRIDE_VALUE>
</OVERRIDE_VALUES>
</USER_PERSONALIZATION_CATEGORY>
<USER_PERSONALIZATION_CATEGORY>
  <OPTN_CATEGORY_LVL>PPTL</OPTN_CATEGORY_LVL>
  <OPTN_CATEGORY_LVL_LOVDescr>PeopleTools</OPTN_CATEGORY_LVL_LOVDescr>
  <USEROPTN>TFRMT</USEROPTN>
  <USEROPTN_LOVDescr>Time Format</USEROPTN_LOVDescr>
  <OPTN_CATEGORY>LOCALE</OPTN_CATEGORY>
  <OPTN_CATEGORY_GRP>PIA</OPTN_CATEGORY_GRP>
  <DEFAULT_VALUE>C</DEFAULT_VALUE>
  <DEFAULT_VALUE_DESCR>12 hour clock</DEFAULT_VALUE_DESCR>
  <OVERRIDE_VALUE/>
  <OVERRIDE_VALUE_DESCR/>
  <EXPLANATION>Determines whether time will be displayed in civilian (8:00

```

5:00 PM)

or military (20:05:00) time format. The determination of whether seco=>

nds and

microseconds are displayed is made at the field level, and is not a personalization.</EXPLANATION>

```

<OVERRIDE_VALUES>
  <OVERRIDE_VALUE>
    <FIELDVALUE>C</FIELDVALUE>
    <DESCR>12 hour clock</DESCR>
  </OVERRIDE_VALUE>
  <OVERRIDE_VALUE>
    <FIELDVALUE>M</FIELDVALUE>
    <DESCR>24 hour clock</DESCR>
  </OVERRIDE_VALUE>
</OVERRIDE_VALUES>
</USER_PERSONALIZATION_CATEGORY>
<USER_PERSONALIZATION_CATEGORY>
  <OPTN_CATEGORY_LVL>PPTL</OPTN_CATEGORY_LVL>
  <OPTN_CATEGORY_LVL_LOVDescr>PeopleTools</OPTN_CATEGORY_LVL_LOVDescr>
  <USEROPTN>TSEP</USEROPTN>
  <USEROPTN_LOVDescr>Digit Group Separator</USEROPTN_LOVDescr>
  <OPTN_CATEGORY>LOCALE</OPTN_CATEGORY>
  <OPTN_CATEGORY_GRP>PIA</OPTN_CATEGORY_GRP>
  <DEFAULT_VALUE>,</DEFAULT_VALUE>
  <DEFAULT_VALUE_DESCR>,</DEFAULT_VALUE_DESCR>
  <OVERRIDE_VALUE/>
  <OVERRIDE_VALUE_DESCR/>
  <EXPLANATION>Any single character, commonly either ',' or '.'.
  Determines whether 1000 shows as 1,000 or 1.000.</EXPLANATION>
<OVERRIDE_VALUES>
  <OVERRIDE_VALUE>
    <FIELDVALUE/>
    <DESCR/>
  </OVERRIDE_VALUE>
</OVERRIDE_VALUES>
</USER_PERSONALIZATION_CATEGORY>
</USER_PERS_CATEGORIES>
</USER_PERSONALIZATION>
</USER_PERSONALIZATIONS>
</USER_PREFERENCE>
</SCC_SUBMIT_USERPREF_REQ>

```

Describing the SOAP Output Message: SCC_SUBMIT_USERPREF_RESP

When the Integration Broker receives the SCC_SUBMIT_USERPREF_REQ message, it responds with the SCC_SUBMIT_USERPREF_RESP message the structure of which is shown below.

This example illustrates the fields and controls on the SCC_SUBMIT_USERPREF_RESP Message Parameters. You can find definitions for the fields and controls later on this page.



The following is an example of the SCC_SUBMIT_USERPREF_RESP message that the SCC_SUBMIT_USERPREF service operation transmits to the UI:

```

<?xml version="1.0"?>
<SCC_SUBMIT_USERPREF_RESP xmlns="http://xmlns.oracle.com/Enterprise/services"/>

```

Describing the SOAP Output Fault Message: SCC_FAULT_RESP

When the Integration Broker receives the SCC_SUBMIT_USERPREF_REQ message and a validation fault is detected, it responds with the output fault message SCC_FAULT_RESP that consists of error message number, set number and the error message text.

Using the REST Submit User Preferences Web Service Operation

This is a description of the SOAP Submit User Preferences Web Service Operation:

Service

SCC_CONSTITUENT_R

Operation

SCC_SUBMIT_USERPREF_R_POST

EndPoint

http://<hostname>:<port>//PSIGW/RESTListeningConnector/SCC_SUBMIT_USERPREF_R.v1/userpref/submit

Summary

Refer to the Submit User Preferences SOAP Service Operation.

Description

Refer to the Submit User Preferences SOAP Service Operation.

Users

Refer to the Submit User Preferences SOAP Service Operation.

Processing

Refer to the Submit User Preferences SOAP Service Operation.

Output

Refer to the Submit User Preferences SOAP Service Operation.

Error Conditions

Refer to the Submit User Preferences SOAP Service Operation.

Describing the REST Input Message: SCC_SUBMIT_USERPREF_REQ

Refer to the Submit User Preferences SOAP Service Operation.

Describing the REST Output Message: SCC_SUBMIT_USERPREF_RESP

Refer to the Submit User Preferences SOAP Service Operation.

**Describing the REST Output Fault Message:
SCC_SUBMIT_USERPREF_FAULT**

Refer to the Submit User Preferences SOAP Service Operation.

Constituent Service Messages and Entities**Constituent Service Messages**

Constituent web services deliver the following synchronous, non-rowset-based messages, which are defined using PeopleTools Integration Broker:

- SCC_GETCONSTFERPA_REQ
- SCC_GETCONST_RESP_MSG
- SCC_SUBMITCONST_REQ
- SCC_SUBMITCONST_RESP

- SCC_GETPHOTO_REQ
- SCC_GETPHOTO_RESP
- SCC_GET_CHKLIST_REQ
- SCC_GET_CHKLIST_RESP
- SCC_GET_SERVICE_IND_REQ
- SCC_GET_SERVICE_IND_RESP
- SCC_GET_USERPREF_REQ
- SCC_GET_USERPREF_RESP
- SCC_SUBMIT_USERPREF_REQ
- SCC_SUBMIT_USERPREF_RESP

Message Property	Value
Message	SCC_GETCONST_REQ
Version	V1
Message Alias	<i>Not Applicable (N/A)</i>
Description	Constituent Request Message
Message Type	Non Rowset based Message

Message Property	Value
Message	SCC_GETCONST_RESP
Version	V1
Message Alias	<i>Not Applicable (N/A)</i>
Description	Constituent Response Message
Message Type	Non Rowset based Message

Message Property	Value
Message	SCC_SUBMITCONST_REQ
Version	V1
Message Alias	<i>Not Applicable (N/A)</i>
Description	Constituent Request Message
Message Type	Non Rowset based Message

Message Property	Value
Message	SCC_SUBMITCONST_RESP
Version	V1
Message Alias	<i>Not Applicable (N/A)</i>
Description	Constituent Response Message
Message Type	Non Rowset based Part Message

Message Property	Value
Message	SCC_GETPHOTO_REQ
Version	V1
Message Alias	<i>Not Applicable (N/A)</i>
Description	Constituent Photo Request Message
Message Type	Non Rowset based Message

Message Property	Value
Message	SCC_GETPHOTO_RESP

Message Property	Value
Version	V1
Message Alias	<i>Not Applicable (N/A)</i>
Description	Constituent Photo Response Message
Message Type	Non Rowset based Message

Message Property	Value
Message	SCC_GET_CHKLIST_REQ
Version	V1
Message Alias	<i>Not Applicable (N/A)</i>
Description	Constituent Checklist Request Message
Message Type	Non Rowset based Message

Message Property	Value
Message	SCC_GET_CHKLIST_RESP
Version	V1
Message Alias	<i>Not Applicable (N/A)</i>
Description	Constituent Checklist Reponse Message
Message Type	Non Rowset based Message

Message Property	Value
Message	SCC_GET_SERVICE_IND_REQ
Version	V1

Message Property	Value
Message Alias	<i>Not Applicable (N/A)</i>
Description	Constituent Service Indicator Request Message
Message Type	Non Rowset based Message

Message Property	Value
Message	SCC_GET_SERVICE_IND_RESP
Version	V1
Message Alias	<i>Not Applicable (N/A)</i>
Description	Constituent Service Indicator Response Message
Message Type	Non Rowset based Message

Message Property	Value
Message	SCC_GET_USERPREF_REQ
Version	V1
Message Alias	<i>Not Applicable (N/A)</i>
Description	Constituent User Preference Request Message
Message Type	Non Rowset based Message

Message Property	Value
Message	SCC_GET_USERPREF_RESP
Version	V1
Message Alias	<i>Not Applicable (N/A)</i>

Message Property	Value
Description	Constituent User Preference Response Message
Message Type	Non Rowset based Message

Message Property	Value
Message	SCC_SUBMIT_USERPREF_REQ
Version	V1
Message Alias	<i>Not Applicable (N/A)</i>
Description	Constituent Submit User Preference Request Message
Message Type	Non Rowset based Message

Message Property	Value
Message	SCC_SUBMIT_USERPREF_RESP
Version	V1
Message Alias	<i>Not Applicable (N/A)</i>
Description	Constituent Submit User Preference Response Message
Message Type	Non Rowset based Message

Constituent Entities

These are the entities used in Constituent web services:

- SCC_GETCONST_REQ
 - Entity ID:
 - Name: SCC_GETCONST_REQ
 - Status: Active
 - Entity Type: SOAPServiceRequest

- Description: Self Service Constituent Request Entity
- AppClass:
- Prod Record:
- Element (XML): SCC_GETCONST_REQ
- Child Entities:

- SCC_GETCONST_RESP
 - Entity ID:
 - Name: SCC_GETCONST_RESP
 - Status: Active
 - Entity Type: Data Set
 - Description: Self Service Constituent Response Entity
 - AppClass:
 - Prod Record:
 - Element (XML): SCC_GETCONST_RESP
 - Child Entities: Constituent

- SCC_SUBMITCONST_REQ
 - Entity ID:
 - Name: SCC_SUBMITCONST_REQ
 - Status: Active
 - Entity Type: SOAPServiceRequest
 - Description: Self Service Submit Constituent Request Entity
 - AppClass:
 - Prod Record:
 - Element (XML): SCC_SUBMITCONST_REQ
 - Child Entities: Constituent

- SCC_SUBMITCONST_RESP
 - Entity ID:
 - Name: SCC_SUBMITCONST_RESP

- Status: Active
- Entity Type: Data Set
- Description: Self Service Submit Constituent Response Entity
- AppClass:
- Prod Record:
- Element (XML): SCC_SUBMITCONST_RESP
- Child Entities: Constituent

- SCC_GETPHOTO_REQ
 - Entity ID:
 - Name: SCC_GETPHOTO_REQ
 - Status: Active
 - Entity Type: SOAPServiceRequest
 - Description: Constituent Photo Request Entity
 - AppClass:
 - Prod Record:
 - Element (XML): SCC_GETPHOTO_REQ
 - Child Entities:

- SCC_GETPHOTO_RESP
 - Entity ID:
 - Name: SCC_GETPHOTO_RESP
 - Status: Active
 - Entity Type: Data Set
 - Description: Self Service Constituent Request Entity
 - AppClass:
 - Prod Record:
 - Element (XML): SCC_GETPHOTO_RESP
 - Child Entities: Employee Photo

- SCC_GET_CHKLIST_REQ

- Entity ID:
 - Name: SCC_GET_CHKLIST_REQ
 - Status: Active
 - Entity Type: SOAPServiceRequest
 - Description: Constituent Check list Request Entity
 - AppClass:
 - Prod Record:
 - Element (XML): SCC_GET_CHKLIST_REQ
 - Child Entities:
- SCC_GET_CHKLIST_RESP
 - Entity ID:
 - Name: SCC_GET_CHKLIST_RESP
 - Status: Active
 - Entity Type: Data SET
 - Description: Constituent Checklist Response Entity
 - AppClass:
 - Prod Record:
 - Element (XML): SCC_GET_CHKLIST_RESP
 - Child Entities: PersonChecklistItemSS
- SCC_GET_SERVICE_IND_REQ
 - Entity ID:
 - Name: SCC_GET_SERVICE_IND_REQ
 - Status: Active
 - Entity Type: SOAPServiceRequest
 - Description: Constituent Get Service Indicator Request Entity
 - AppClass:
 - Prod Record:
 - Element (XML): SCC_GET_SERVICE_IND_REQ

- Child Entities:

- SCC_GET_SERVICE_IND_RESP
 - Entity ID:
 - Name: SCC_GET_SERVICE_IND_RESP
 - Status: Active
 - Entity Type: Data Set
 - Description: Constituent Get Service Indicator Response Entity
 - AppClass:
 - Prod Record:
 - Element (XML): SCC_GET_SERVICE_IND_RESP
 - Child Entities: ServiceIndicatorSS

- UserPreference
 - Entity ID:
 - Name: StagedUserPreference
 - Status: Active
 - Entity Type: Staged Entity
 - Description: Staged Constituent User Preference Entity
 - AppClass: SCC_SL_TRANSACTION:ACCESSORS:StagedUserPreference
 - Prod Record: SCC_PRD_ENT_WRK
 - Element (XML): USER_PREFERENCE
 - Child Entities: StagedOperatorDefault, StagedCommunicationPreference, StagedNotificationPreference, StagedUserPersonalization

Working with the Notifications Framework

Understanding the Notifications Framework

The Notifications Framework provides a consistent, extensible communication mechanism that Campus Solutions product areas (consumers) can use to enable communications from their areas and a generic extensible framework which meets the real-time notifications needs of current features.

Customers can also craft their own solutions to use the framework without reinventing the lower level coding that enables notifications to be sent and tracked.

Notifications encompass a broad area of communications between the Campus Solutions system and users and also between users themselves. A notification may take these forms (referred to as channels):

- Email
- SMS
- Alerts (for example, an informational message that appears on a portal homepage)
- Worklist Items (an actionable hyperlink that appears on a portal homepage)
- Push Notifications (for mobile apps on iOS/Android)
- Announcements

The Notifications Framework:

- Delivers an extensible, light-weight PeopleCode framework that can adapt to future needs.
- Provides options to co-exist with, consume or be utilized by the existing COMMGEN processing.
- Supports both real-time and batch notifications.
- Provides a generic configurable notification solution that is not bound to any particular consuming application or to any particular UI technology.
- Provides a Notification code level API that is flexible enough to be useful to all consuming applications; for example, Application Classes, Components, Application Engine programs, web services and so on.
- Supports Timeout processing for worklist items.
- Provides the ability to generate Reminder notifications for existing notifications.

At the deeper, technical level, the solution architecture uses the Entity Registry to generalize all notifications into a single structure. The architecture is modeled on a pluggable channel-based approach. Each notification type is supported by a dedicated channel that supports the idiosyncrasies of the particular notification type. All notification channels conform to the standard interface of a Notification

Channel. As new notification types are identified, a new channel that conforms to the standard Channel interface will need to be created and registered with the framework.

The architecture has been implemented using vanilla PeopleTools application classes and Object Oriented design principles.

A vital point to understand is that the framework is not directly exposed to system users, but is used by consuming applications, also known as consumers (for example Delegated Access, New User Registration, Campus Mobile), which, in turn, interface with system users. PeopleSoft developers, rather than regular users, would directly interact with the framework, aside from the set up pages described below.

Technical Overview

The Notifications Framework is used to send notifications to interested parties (determined by the consumer setup), via a notification channel (such as email, SMS, alerts or worklists) based on some transaction performed by a consuming application (the consumer). For example, if an employee wants to share some data with a person via email and hence grants access to some of his/her data (as is the case with Delegated Access functionality), then the consumer can use the Notifications Framework to send email notifications to the person.

The content to be sent to the concerned parties must be created as a Generic template, which is then used to create the notification. The templates are grouped together under a common consumer. Based on the consumer setup, valid templates for a transaction are selected, and a notification item is created against each valid template.

Finally, the items are checked for any errors or warnings, and if the items are found to be eligible for sending, then they are sent using the People Tools Notification Classes provided (PT_WF_NOTIFICATION.Notification App Class). The following diagram illustrates the relationships between the components of the framework:

This example illustrates the Notifications Framework High Level Architecture.

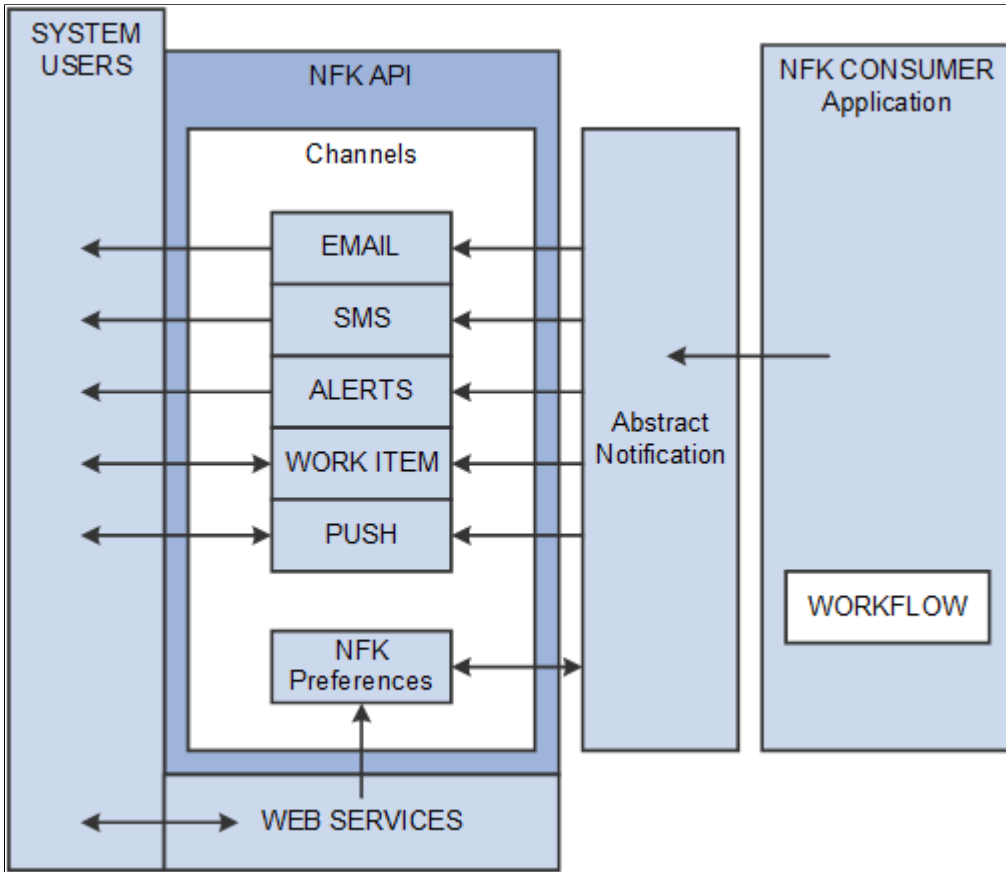

In the diagram above, the AbstractNotification class acts as a layer of encapsulation over the NotificationManager, which is the gateway for all consumers using the Notifications Framework. This is the Abstract Base class that consumers of the Notifications Framework should extend and implement in order to minimize consumer effort in sending notifications. After all processing is completed the NotificationRouter calls the applicable Notification Channel to deliver the notification type item/items created.

This example illustrates Notifications Framework Communications.

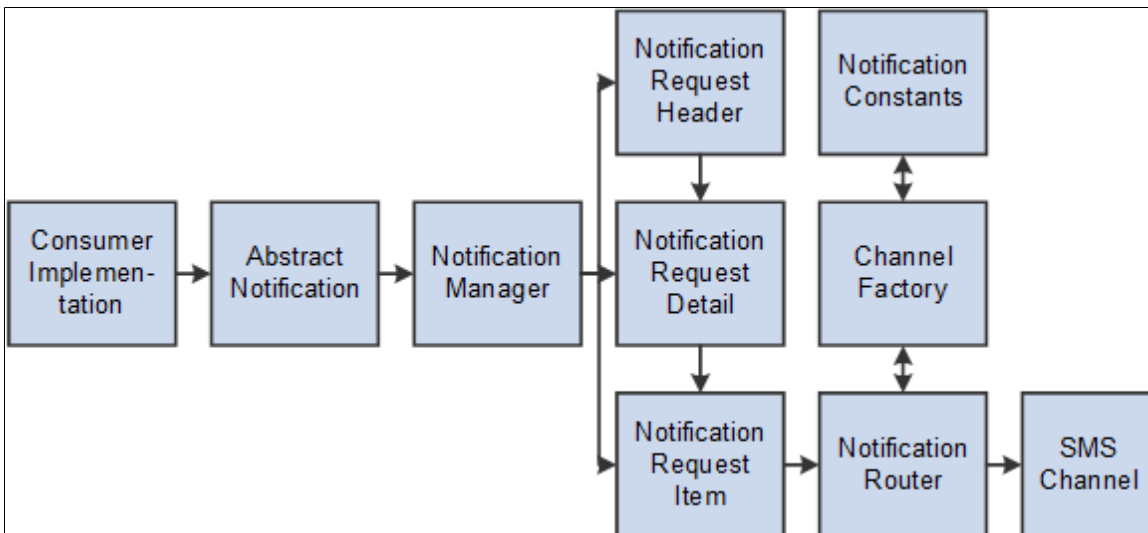

Notifications Framework Entities:

Entity	Record	Notes
Notification Request Header	SCC_NTFREQ_HDR	N/A
Notification Request Detail	SCC_NTFREQ_DTL	N/A
NotificationRequestDetailER	SCC_NTF_DTL_ER	<p>The NotificationRequestDetailER Entity is used to support multiple recipients like TO, CC, BCC for Email. This entity allows the framework to:</p> <ol style="list-style-type: none"> 1. Store the multiple Email TO, CC, BCC recipients. 2. Link to the NotificationRequestDetail entity. <p>When an Email notification is to be sent to multiple recipients (TO, CC, BCC), the consumer needs to set the notification context property SCC_NTF_AUDCE to 'ER', EMPLID to null, and populate all the below properties as appropriate:</p> <pre>/* Multiple Recipients for Email (To,CC,BCC) *⇒ / property array of string arrEMPLID_TO; property array of string arrEMPLID_CC; property array of string arrEMPLID_BCC;</pre>
Notification Request Item	SCC_NTFREQ_ITM	N/A
Notification Recipient	SCC_NTFREQ_RECP	N/A
Notification Data	SCC_NTFREQ_DATA	N/A
Notification Reminder	SCC_NTFREQ_RMDR	<p>The Notification Reminder Entity is only used when a reminder notification is created for a previously generated notification. The Notification Reminder entity allows the framework to:</p> <ol style="list-style-type: none"> 1. Store the date(s) when Reminder(s) were created for a notification. 2. Link the original notification with the reminder notification.

This example illustrates the Entity Hierarchy for Notifications.

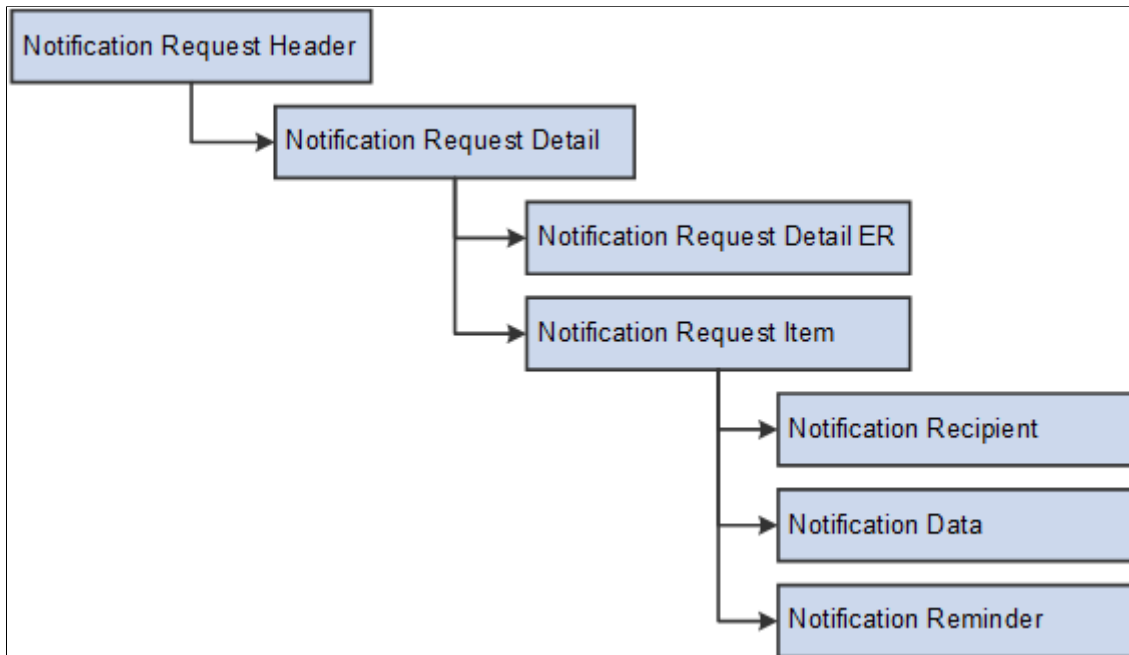

Setting Up and Consuming the Notifications Framework

This section discusses how to set up the Notifications Framework for sending e-mail notifications using the e-mail channel. Where other notification channels differ from the e-mail channel, the differences are highlighted.

The Notifications Framework uses the generic templates of the PeopleTools Workflow Technology, and the reader is urged to review the information in *PeopleTools: Workflow Technology*, “Using Notification Templates,” for a more comprehensive understanding.

For each of the templates, the Notification Setup page is used to determine the e-mail address to use for sending notifications to the recipients. From there you can define which e-mail addresses to use in the ‘To’ section of the e-mail message as well as in the CC (carbon copy) or BCC (blind carbon copy) sections. E-mail addresses of CC recipients are made publicly aware of the notification. E-mail addresses of BCC recipients are made aware of the notification privately.

If you know the recipients have an EMPLID in the system, you can select to use the e-mail address that you have on file which is marked as Preferred (subject to the user’s notification preferences, if any – see below). If instead the e-mail address should be obtained from a specific place, then custom logic can be used. For example, within Delegated Access, an e-mail notification is sent to the proxies at the time they are created. At creation time, an e-mail address must be entered in the Delegated Access self-service page (Share My Information – Details page). To send the e-mail notification to the proxies, custom logic is used to retrieve the proxy’s e-mail address from that specific page. If instead you want to send the notifications to a specific e-mail address, a static address can be entered. This option should mostly be used when you are testing the notification templates.

Complete the following steps to set up and consume the Notifications Framework:

1. Configure the Generic Templates for Notifications Framework.

2. Configure Notification Setup for the Generic Templates.
3. Set Up a Notification Consumer.
4. Trigger the Notifications Framework.
5. Set Up the SMS Notification page.
6. Integration Broker set up for the SMS channel.
7. Set Up Push Notifications page.
8. Configure IB to use Socket Connector for Push channel delivered services.
9. Install SSL Certificates and configure platform specific server keys.
10. Activate all the IB objects delivered for Push channel.
11. Schedule APNS Feedback job.

Pages Used to Set Up the Notifications Framework

Page Name	Definition Name	Navigation	Usage
Generic Template Definition	WL_TEMPLATE_GEN	PeopleTools > Workflow > Templates	<p>Notifications > Generic Define e-mail notifications. Define the Message Text and the variables to include.</p> <hr/> <p>Note: The list of variables contained in each of the messages is delivered with your system and require extended coding effort to be modified.</p>
Notification Setup	SCC_NTF_SETUP	Set Up SACR > System Administration > Utilities > Setup	<p>Notifications > Notification Setup Set up the recipients for the a notification template is created by associating to a generic template. The recipient's configuration is also detailed here.</p>
Notification Consumer Setup	SCC_NTF_CON_CFG	Set Up SACR > System Administration > Utilities > Consumer Setup	<p>Notifications > Notification Specify the generic templates the system uses for sending notifications related to a specific consumer.</p>
SMS Notification Setup	SCC_NTF_SMS	Set Up SACR > System Administration > Utilities > Notification Setup	<p>Notifications > SMS Set up SMS notifications.</p>

Page Name	Definition Name	Navigation	Usage
Push Notifications Setup	SCC_NTF_PUSH_SETUP	Set Up SACR > System Administration > Utilities > Notifications Setup	Set up Push notifications. Notifications > Push

Configuring the Generic Templates for Notifications Framework

Access the Generic Template Definition page (**PeopleTools > Workflow > Notifications > Generic Templates**).

This example illustrates the fields and controls on the Generic Template Definition Page. You can find definitions for the fields and controls later on this page.

Generic Template Definition
Blackberry Email Responses

Template: SCC_TM_ASSIGNED

***Description:**

Instructional Text:

Type names or email addresses in the To, CC, or BCC fields, using a semi-colon as a separator. Click LOOKUP RECIPIENT to search for a name. Click DELIVERY OPTIONS to view or change the method of the send.

Priority:

***Sender:** Email ID:

Subject:

Message Text:

Dear %1,
You have been assigned the following new task

Student ID: %6
Task: %2
Due Date: %9

For further details and to access the task please click on the following link

Below is the list of available variables for this template.
You can use template variables within your subject or message text.
The following variables can also be used:
%Date, %DateTime, %Time, %ServerTimeZone, %EmailAddress, %NotificationPriority,
%NotificationToList, %NotificationCCList

Template Variables	
*Value	*Description
<input type="text" value="%1"/>	Recipient Name + -
<input type="text" value="%2"/>	Task Title + -
<input type="text" value="%3"/>	Template ID + -
<input type="text" value="%4"/>	Instance ID + -
<input type="text" value="%5"/>	Status + -
<input type="text" value="%6"/>	Emplid + -
<input type="text" value="%7"/>	Context Data + -
<input type="text" value="%8"/>	URL + -
<input type="text" value="%9"/>	Due Date + -

This page is used to define the basic message template along with any variables to be inserted into the message. The data for these variables is populated by the Notifications Framework consumer in its code, and the bind variables are replaced with the consumer-populated data at runtime to generate the notification's content.

Note: To avoid possible formatting issues, don't use the <pre> HTML element in the message template.

<i>Field or Control</i>	<i>Description</i>
Template	Displays the name of the generic template to be associated to the Template Name in the Notification Setup page.
Description	Enter a description of the template.
Instructional Text	Notifications Framework does not use this field. Enter informational text about the generic template.
Priority	Notifications Framework does not use this field. For information purposes only.

Field or Control	Description
Sender	<p>Select how you want the system to derive and display the From e-mail address value in the e-mail notification:</p> <ul style="list-style-type: none"> • Other: When selected, the E-mail ID field is required. Enter the e-mail address of your choice to be displayed in the From field of the e-mail message. Use this option to protect the privacy of the sender. <hr/> <p>Note: The e-mail address you enter in the E-mail ID field does not need to be valid. This allows you to enter a meaningful e-mail address such as: YourInstitutionName@edu.com.</p> <hr/> • System: The system uses the e-mail address value defined in the configuration file (.cfg) through the respective system variables (%SMTPSender). For example, you can maintain the privacy of delegator (not showing e-mail address) by specifying Sender as “System” or “Other”. When no e-mail address is found, the system uses a default value. The default value is set up in the SCC_COMMON:NOTIFICATION:NotificationConstants application class. Delivered with your system the default value is set as peoplesoft@oracle.com. Modify this default value accordingly. <hr/> <p>Note: The e-mail address you configure in the configuration file must be a valid e-mail address, otherwise the e-mail notifications are not sent. See <i>PeopleTools: PeopleCode Language Reference</i> “System Variables” for more information on the %SMTPSender system variable.</p> <hr/> • System-Blackberry: The system uses the e-mail address value defined in the configuration file (.cfg) through the respective system variables (%SMTPBlackberryReplyTo). When no e-mail address is found, the system uses a default value. The default value is set up in the SCC_COMMON:NOTIFICATION:NotificationConstants application class. Delivered with your system the default value is set as peoplesoft@oracle.com. Modify this default value accordingly. <hr/> <p>Note: The e-mail address you configure in the configuration file must be a valid e-mail address, otherwise the e-mail notifications are not sent. See <i>PeopleTools: PeopleCode Language Reference</i> “System Variables” for more information on the %SMTPBlackberryReplyTo system variable.</p> <hr/> • User: The system uses the sender’s e-mail address defined in its user profile to populate the From field of the e-mail message. This e-mail address is defined under PeopleTools, Security, User Profiles, User Profiles, General. Click the Edit E-mail Address link. This value is derived from the %EmailAddress people code system variable. When no e-mail address is populated in the sender’s user profile, the system uses

Field or Control	Description
	<p>a default value. The default value is set up in the SCC _COMMON:NOTIFICATION:NotificationConstants application class. Delivered with your system, the default value is set as peoplesoft@oracle.com. Modify this default value accordingly.</p> <hr/> <p>Note: If you want to keep the sender anonymous or if the sender's e-mail address is not to be displayed to the recipients, do not select this value. For example, when a notification is sent as part of the Delegated Access functionality, you may not want to display the delegator's e-mail address (student e-mail address) to the proxy (a third party). Displaying a student's e-mail address might infringe your privacy regulations. See <i>PeopleTools: PeopleCode Language Reference</i> "System Variables" for more information on the %EmailAddress system variable.</p>
E-mail ID	Enter an e-mail address to be used only if you have selected Other in the Sender field.
Subject	Enter the subject for the e-mail message. The subject can contain variables.
Message Text	Enter the message text for the e-mail message. The message text can contain variables.

Template Variables

If bind variables are used in the Subject or Message Text, the same must be defined in the Template Variables grid. The consumer populates the list of all values that can be used in a StringHashMap having a (Key, Value) pair, with bind variable number as the key. These values are called as Notification Context Parameter values. The required values are then used in the generic template.

Template variables can be used in any order and in any quantity. You may use only 3 or 4 variables from the entire list or maybe none. These can be any values from the list - for example, %5, %13 and %17 if we are using three variables. These values are populated at runtime and the sent mail would contain these values replacing the bind variables.

Warning! When any template variables are used, their population logic also must be coded in the consumer code where the notifications are triggered. For example, Delegated Access provides a list of template variables and the logic to populate them is also delivered in the Delegated application class code. Therefore, addition of any new template variables requires substantial programming efforts.

Configuring Notification Setup for the Generic Templates

Access the Notification Setup page (**Set Up SACR > System Administration > Utilities > Notifications > Notification Setup**).

This example illustrates the fields and controls on the Notification Setup, Email Channel Selected, page 1 of 2. You can find definitions for the fields and controls later on this page.

Notification Setup

Notification Template ID: SCC_NTF_TMP_20120625083641

*Template Name:

Status:

Description:

*NotificationType: Override Notification Preferences

Email Content Type:

*Notification Criticality:

*Generic Template: [View Generic Template](#)

Recipients Configuration ?

To
<input checked="" type="radio"/> Preferred Email Address
<input type="radio"/> Custom Logic
<input type="radio"/> Static Address

Cc
<input checked="" type="radio"/> None
<input type="radio"/> Preferred Email Address
<input type="radio"/> Custom Logic
<input type="radio"/> Static Address

Bcc
<input checked="" type="radio"/> None
<input type="radio"/> Preferred Email Address
<input type="radio"/> Custom Logic
<input type="radio"/> Static Address

This example illustrates the fields and controls on the Notification Setup, Email Channel Selected, page 2 of 2. You can find definitions for the fields and controls later on this page.

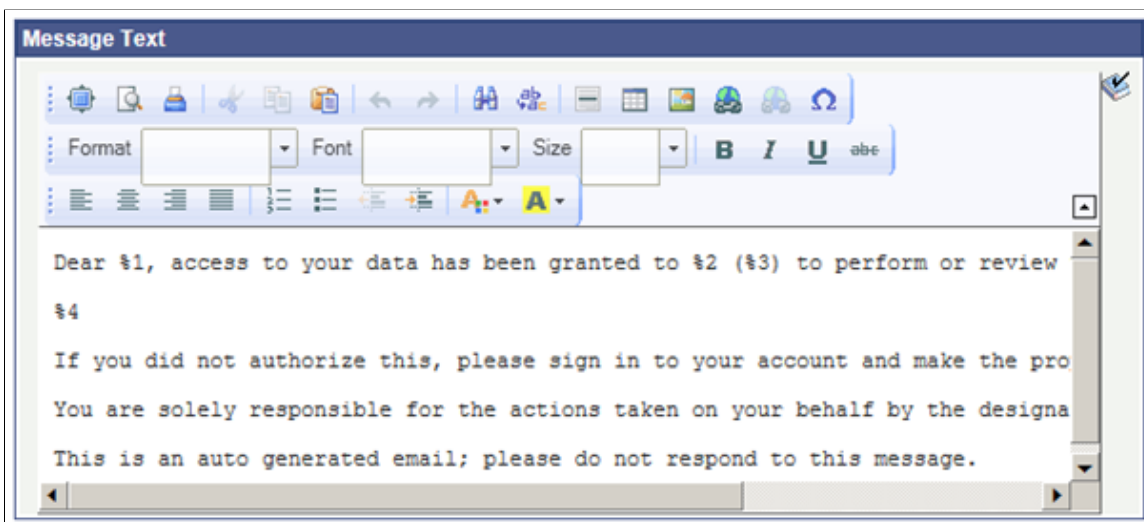

This page links the generic template discussed previously into the Notifications Framework, sets the channel, criticality, and how the recipients are determined.

Field or Control	Description
Notification Template ID	Displays the auto-generated unique ID. When you add a new notification template record, this field displays the value NOID until you save the record. When you save the new record, the field displays the ID that the system assigned to the template.
Template Name	Informative name for the Notification Template ID created above. A template created here must be associated to a generic template name. You can give the template the same name as the generic template name or a more informative name.
Status	Activate or inactivate the notification template. The status must be Active for a notification to be generated from the notification template. If the status of a template is Inactive, an error message is logged for a notification criticality of Process Dependant template and information message logged for an Informative template.
Notification Type	Type of notification to send. Valid values are Alerts, E-mail, SMS, Worklist and Push. This is the channel to be used by the notification.

Field or Control	Description
Override Notification Preferences	<p>Only available if the Notification Type selected is E-mail or SMS. If selected, this causes the recipient's notification preferences (set up in Self Service > Campus Personal Information > Notification Preferences) to be ignored. The system would then use the values set for the Preferred E-mail Address or Preferred Phone Number as set via Campus Community > Personal Information > Biographical > Addresses/Phones > Electronic Addresses (for E-mail Address) / Phones (for Phone Number). For most situations, the check box would be cleared, unchecked, but in circumstances where a recipient must get an e-mail, regardless of the preferences (if any), it should be selected. The primary reason for this field is that some notifications must be sent to a recipient even if they have decided to disable E-mail or SMS Notifications. An example would be e-mails sent from the system to enable a user to retrieve a password, in the case of a forgotten password.</p>
E-mail Content Type	<p>Available when the e-mail notification type is selected – options are text/html or text/plain. If html is selected, any HTML tags in the message are respected.</p>

Field or Control	Description
<p>Notification Criticality</p>	<p>Indicates how critical the template is from the business process perspective, and may be set to either Informative or Process Dependant. If it is critical to the business, we advise that you select Process Dependant, otherwise select Informative. This information is later used to categorize the errors that may have happened when triggering the e-mail template and sending the e-mail notification.</p> <p>If there is an error with a notification template that has been set as Informative, then the system continues with the processing. This error is considered as a Normal Error. If, however, there is an error with a notification template set as Process Dependant, the system stops processing, as the business process would be impacted by this error. This is classified as a Reconcile Error.</p> <p>Normal errors are logged in the Notification Error logging tables. Reconcile errors are logged in the system's App Server Logging (same as Exceptions). These would be logged only when tracing is enabled.</p> <p>For example, within Delegated Access framework, an e-mail notification is sent to the proxy to indicate a transaction has been delegated and to inform them of the steps to take to make use of this privilege. The e-mail notification sent to the proxy is critical for the completion of the delegation process. In this case the e-mail template set for the proxy can be marked as Process Dependant. A second e-mail is also sent to the person who delegated access as a courtesy to inform the person that access to her or his data was delegated to somebody else. The template for this second e-mail is mostly informational (Informative).</p> <p>The log tables holding the error and warning information in case of informational (Informative) templates are:</p> <ul style="list-style-type: none"> • SCC_NTF_LOG • SCC_NTF_LOGPARAM <p>The App Server logs hold the error messages for Process Dependant templates, and can be found as a trace file in the App Server log folder. Consequently, a trace needs to be enabled to log these messages.</p>
<p>Notification Life (in days)</p>	<p>This option becomes available if the channel (Notification type) selected is Worklist or Push.</p> <p>For Worklist, this option is used to time-out the worklist item notification based on the number of days set in this field.</p> <p>For Push, this option is used as expiry for the push message in APNS/GCM. If not set, the default value is 7 days.</p>

Field or Control	Description
Callback Application Class	<p>This option becomes available if the channel (Notification type) selected is Worklist. Allows consumers to carry out consumer specific actions when a worklist event occurs.</p> <p>Consumers create the callback application class by extending the base callback event handler (SCC_COMMON:NOTIFICATION:CALLBACK:BaseNotificationEventHandler).</p> <p>Currently the only events supported are Timeout and Reminder.</p> <p>Used by the Worklist Timeout and Reminder Batch process (SCC_NTFWKLTO).</p>
Application Name	<p>This option becomes available if the channel (Notification type) selected is Push. Select the mobile Application Name (configured in Push Notifications Setup page) for which you want to use the template.</p>
Generic Template	<p>Select the generic template for which you want to define the recipients.</p>

Recipients Configuration

Use this group box to indicate how the system should set the To, CC, and BCC values in the notification messages. Note that the sections (To, CC, and BCC) available in this group box vary depending on the Notification Type (channel) selected:

- E-mails (To, CC, BCC)
- Alerts (To)
- SMS (To)
- Worklists (To)

Field or Control	Description
None	<p>Select if you do not want to include an e-mail address in the CC or BCC section of the e-mail. Available only for CC and BCC.</p>

Field or Control	Description
Custom Logic	Select if you want an application class to determine how the e-mail address of the recipient should be set. You have to create this PeopleCode application class and specify the class's name in the Application Class field. When you select the Custom Logic option, the Application Class field becomes available. For an example of an application class containing custom logic to determine an e-mail address to use, see the Delegated Access application class called SCC_DA:NOTIFICATION:DACustomLogicProvider.
Preferred E-mail Address	Select if you want to use the recipient's e-mail address that is marked as preferred in the e-mail address record (EMAIL_ADDRESSES). Choose this option mostly if you know the recipients have an ID in your system (the e-mail address record is keyed by EMPLID). Note that if the recipient has set their notification preferences (Self Service > Campus Personal Information > Notification Preferences) to another e-mail address, then it is used for the e-mail rather than the preferred e-mail address, unless the Override Notification Preferences check box is selected on the Notification Setup page (Set Up SACR > System Administration > Utilities > Notifications > Notification Setup).
Static Address	Select if you want all the e-mail messages to be sent to a particular e-mail address. Enter this e-mail address in the E-mail Address field. When you select the Static Address option, the E-mail Address field becomes available. Use this option mostly when you are testing the notification templates to verify the content of the e-mail messages generated and the required configuration is properly done.

Message Text

This group box appears only if the Notification Type is Email with an Email Content Type of text/html. The formatted text is saved differently depending on the browser used. Set the **Format** field to *Normal* before creating or updating the message text.

Setting Up a Notification Consumer

Access the Notification Consumer Setup page (**Set Up SACR > System Administration > Utilities > Notifications > Notification Consumer Setup**).

This example illustrates the fields and controls on the Notification Consumer Setup page. You can find definitions for the fields and controls later on this page.

Notification Consumer Setup

Notification Consumer ID: SCC_NTF_CON_20120625084442

***Consumer Name:**

Status:

Description:

Notification Templates						Personalize Find View All First 1-4 of 4 Last
	*Template Name	NotificationType	Template Status	*Application Class		
1	DA_DELG_EMAIL_ON_GRANT	Email	Active	SCC_DA:NOTIFICATION:DADeleg	View Template Name	+ -
2	DA_PROXY_EMAIL_ON_GRANT	Email	Active	SCC_DA:NOTIFICATION:DAProxy	View Template Name	+ -
3	DA_KNOWN_PROXY_EMAIL_ON_GRA	Email	Active	SCC_DA:NOTIFICATION:DAknow	View Template Name	+ -
4	DA_PROXY_EMAIL_ON_REVOKE	Email	Active	SCC_DA:NOTIFICATION:DAProxy	View Template Name	+ -

This is the point where, for a consumer, the template and notification setup are associated with the consumer code (the application class) that populate the template fields and send the notification via the chosen channel to the recipient.

Field or Control	Description
Notification Consumer ID	Displays the auto-generated unique ID. When you add a new notification consumer record, this field displays the value NOID until you save the record. When you save the new record, the field displays the ID that the system assigned to the consumer.
Consumer Name	Enter the name of the consumer that consumes the notification framework.
Status	Activate or inactivate the notification consumer. If the consumer is inactive, the system does not send any notifications.

Notification Templates

Use this grid to specify the templates that you have configured for the notification consumer on the Notification Setup page. To process notifications, the framework needs to know which templates are valid to use for sending out emails with respect to the consumer's business process or scenario. For each of the templates, specify the application class logic which the Notifications Framework uses to identify the valid template for triggering the notification. For example, within Delegated Access, two email notifications are sent at the time that the user delegates new access to somebody. After making the data change and saving the component, one email notification is sent to the user and one to the person to whom access has been delegated. These two notifications use two different templates and are generated under a specific logic. The logic is defined in an application class. For examples of application classes containing logic to trigger a notification, look at any of the delivered Delegated Access application classes:

- SCC_DA:NOTIFICATION:DADelegGrantTemplateProvider
- SCC_DA:NOTIFICATION:DAProxyGrantTemplateProvider
- SCC_DA:NOTIFICATION:DAKnownProxyGrantTmpltProvider
- SCC_DA:NOTIFICATION:DAProxyrevokeTemplateProvider

The Application Class, configured against each consumer Template Name, is invoked (returns true or false) to determine if that particular template is to be used for sending notifications or not.

In the same AppClass created above, include logic to populate the EMPLID property of the Notification Context with the recipient's EMPLID. This value may be left blank if the notification recipient does not have an EMPLID (for example within Delegated Access, email notifications are sent to the proxies which may or may not have an EMPLID identified).

When the Notifications Framework is used to dynamically determine the template(s) to trigger multiple notifications, the recipient(s) may be different for each notification. Therefore, on selecting a template to trigger the notification, BaseNotificationContext.EMPLID must be populated dynamically with the respective recipient EMPLID. This must be taken care of by the NFK Consumers in their respective Template Provider App Class code (an Application Class configured for each Template Name in Notification Consumer Setup page).

During NFK processing, the provided EMPLID Context value is stored in SCC_NTFREQ_DTL.EMPLID record field. Later, this stored recipient's EMPLID information is used as part of the Notifications Center page. The page displays the notifications sent to that specific EMPLID.

Warning! Failing to properly populate the EMPLID Context field with the proper recipient's EMPLID may result in displaying in the Notifications Center page notifications sent to someone else.

Triggering the Notifications Framework

This section describes how functionality initiates a notification and depends on the Consumer functionality involved. An example is the Delegated Access - Share My Information self-service page, from where the Notifications Framework is triggered. When the page is saved, the Notifications Framework is triggered via the Application Class code associated with it.

This example illustrates the fields and controls on the Delegated Access Share My Information example.

Simon Stewart

Share My Information

Share My Information - Details

*Contact Name:

*Relationship:

*Contact Email Address:

Contact Status: Unknown [RESEND EMAIL NOTIFICATION](#)

	Transaction Name	Description	Start Date	Transaction Status
<input type="checkbox"/>	Emergency Contacts	Delegate the ability to view and update your emergency contacts.		
<input type="checkbox"/>	Update Contact Information	Delegate the ability to update your phone numbers, email addresses and addresses.		
<input checked="" type="checkbox"/>	View Contact Information	Delegate the ability to view your phone numbers, email addresses and addresses.	10/10/2012	Submitted
<input type="checkbox"/>	View Holds	Delegate the ability to view the holds placed on your record for specific services.		
<input checked="" type="checkbox"/>	View To Do List	Delegate the ability to view the pending items on your to do list generated by the institution.	10/10/2012	Submitted

[SELECT ALL](#)
[CLEAR ALL](#)
[SAVE](#)

[Return to Share My Information Summary](#)

Users can refer to the Delegated Access Application Class SCC_DA:NOTIFY as a reference for how to trigger the Notifications Framework as a consumer.

See [Developer Reference for Setting Up Delegated Access](#)

Methods in Notifications Framework to be used by Consumer

Before invoking Notifications Framework to process or send notifications, consumers can make sure that the consumer and template set are to active. The following methods are examples of error handling:

- Method is ConsumerActive(&pSccNtfConId As string) returns Boolean;
- Method is TemplateActive(&pSccNtfreqTmpltid As string) returns Boolean;

This helps to avoid unnecessary processing by consumers/framework.

The methods that must be used by the consumer to consume or invoke the Notifications Framework are listed below:

1. Write an AppClass that extends AbstractNotification class. The Consumer ID must be passed to the Super Class constructor here, as shown in the sample code below:

```
%Super = create SCC_COMMON:NOTIFICATION:AbstractNotification(&Consumer_ID);
```

2. Implement the abstract method createNtfContext(). This creates the context for the consumer as already explained in the previous section.

Sample Code:

```
method createNtfContext
```

```

/+ Returns SCC_COMMON:NOTIFICATION:INotificationContext +/
/+ Extends/implements SCC_COMMON:NOTIFICATION:AbstractNotification.createNt=>
fContext +/

Return create SCC_DA:NOTIFICATION:DANotificationContext();

end-method;

```

3. Implement the abstract method `populateNtfContext()`. This method populates the context create above with the necessary values as required during the processing.

Sample Code:

```

/* Downcast */
Local SCC_DA:NOTIFICATION:DANotificationContext &myNtfCntxt = &p_ntfContext=>

As SCC_DA:NOTIFICATION:DANotificationContext;

Rem Populate DANotification Context values;
&myNtfCntxt.EMPLID = &Emplid;
&myNtfCntxt.SCC_DA_PRXY_ID = &proxyId;

```

Note: If a consumer chooses to send a single notification then it can be done by directly populating the `&myNtfCntxt.SCC_NTFRREQ_TMPLTID` with the Template ID value. If the Notification Context property: `SCC_NTFRREQ_TMPLTID` is not populated then the Notifications Framework uses `createConsumerNotificationDetailsItems()` method to dynamically create single or multiple notification items based on consumer templates setup.

4. Invoke the `send()`, `remind()`, or `resend()` method.

- `%This.send();`

During this processing, the framework creates objects such as Notifications Header, Notification Detail & Notification Item records using the Notification Context data populated by the consumer. Finally, the `send()` method for each notification item is invoked using the appropriate channel (like Email, SMS, Alert or Worklist) as per the Notification Template Setup.

- `%This.remind(Notification ID, Detail Sequence Number, Item Sequence Number)`

This method is used to create a “reminder” notification for a previously generated notification. The parameters to this method are the Notification ID, Detail Sequence Number, and Item Sequence Number of an existing notification.

During this processing, the framework invokes the `send()` method to create a new notification. Then the framework stores the date/time and the keys of the new notification in the original notification.

- `%This.resend(Notification ID)`

This method is used to resend a previously generated notification. The only parameter to this method is the Notification Request ID of the notification to be resent. The notification data related to that particular Notification Request ID is retrieved, and the notification is sent again. This is applicable for only previously sent notifications. A ‘isResend’ flag decides whether the current transaction is a send or resend. As with `send`, the `resend` also invokes the `save()` method of message log and logs the info/warning messages generated as part of the resend.

5. Override the `OnSuccess()` and `OnError()` for custom behavior:

Sample Code:

```

method onSuccess

    SQLExec("Update PS_SCC_DA_PROXY set SCC_DA_NTF_REQ_ID=:1 where  EMPLID=:2 a⇒
nd SCC_DA_PRXY_ID=:3", %This.ntfReqID, &Emplid, &proxyId)

end-method;

method onError
SQLExec("Update PS_OUTPUT set RESULT= :1", &p_excep.toString());
end-method;

```

The `onError` method in `AbstractNotification`, if not overridden in the implementing class, logs an error in the App Server logs – "Notification cannot be sent for Notification Consumer XXXXXXXXX with Request ID YYYYYYY due to following error: ACTUAL ERROR". This behavior can be overridden in the implementing class `onError` method.

Setting Up SMS Notifications

Access the SMS Notification Setup page (**Set Up SACR > System Administration > Utilities > Notifications > SMS Notification Setup**).

This example illustrates the fields and controls on the SMS Notification Setup page. You can find definitions for the fields and controls later on this page.



The screenshot shows the 'SMS Notification Setup' page with the following fields and values:

- *Username:** oracle_ca
- *Password:**
- Sender:** Avishek
- *SMS Method:** SOAP (dropdown menu)
- *SMS Gateway URL:** http://api.clickatell.com/soap/webservice.php
- *Application Class Path:** SCC_SMS_GATEWAY:GATEWAY_IMPL:Clickatell (with a search icon)

This setup is only needed for consumers using the SMS channel to send notifications.

This page stores information about the account details of the SMS Gateway that sends the SMS notification beyond the system. As well as the usual security details such as user name, password, and sender name, it also has information about the URL of the SMS Gateway, which is used to create the final URL with parameters for sending the SMS notification. These details are saved to the record `SCC_NTF_SMS`.

Field or Control	Description
Username, Password, and Sender	Enter the Username, Password, and Sender for the SMS Gateway account used for sending SMS.
SMS Method	Select the SMS method. SMS can be sent either by HTTP URL posting or SOAP method using HTTP protocol.
SMS Gateway URL	Enter the URL of the SMS Gateway provider.
Application Class Path	Enter the Customer-implemented Application Class which extends the BaseSMSChannel. This class is used primarily to create the final SOAP Message/URL which is to be sent for triggering the SMS. It needs to be updated after modifications have been made to the page.

Sample of Customized Application Class Path Code

You can either use a URL or SOAP method to trigger an SMS notification. Depending on your setup, the SCC_COMMON:NOTIFICATION:SMSChannel invokes either a *getURLParams()* or *getSOAPMessage()* method. You can code either of the two:

- *getURLParams()* to return the required string URL
- *getSOAPMessage()* to construct an XML node as required

Note: You must hard code the API ID provided by your third party service provider (Clickatell, in this example) in the application class code. The other parameter values are picked up from the SMS Notifications Setup page.

A sample of customized application class code:

```
import SCC_COMMON:NOTIFICATION:BaseSMSChannel;

class Clickatell extends SCC_COMMON:NOTIFICATION:BaseSMSChannel
method Clickatell();
method getURLParams(&sendTo As string, &messageText As string, &userName As string, =>
    &password As string, &sender As string, &gatewayURL As string) Returns string;
method getSOAPMessage(&sendTo As string, &messageText As string, &userName As strin=>
g, &password As string, &sender As string, &XmlNod As XmlNode out);
end-class;

method Clickatell
    %Super = create SCC_COMMON:NOTIFICATION:BaseSMSChannel();
end-method;

method getURLParams
    /+ &sendTo as String, +/
    /+ &messageText as String, +/
    /+ &userName as String, +/
    /+ &password as String, +/
    /+ &sender as String, +/
    /+ &gatewayURL as String +/
    /+ Returns String +/
```

```

/+ Extends/implements SCC_COMMON:NOTIFICATION:BaseSMSChannel.getURLParams +/

Local string &URL = &gatewayURL | "?user=" | &userName | "&password=" | &password⇒
| "&api_id=" | "9999999" | "&to=" | &sendTo | "&text=" | &messageText;
Return &URL;

end-method;

method getSOAPMessage

/+ &sendTo as String, +/
/+ &messageText as String, +/
/+ &userName as String, +/
/+ &password as String, +/
/+ &sender as String, +/
/+ &XmlNode as XmlNode out +/
/+ Extends/implements SCC_COMMON:NOTIFICATION:BaseSMSChannel.getSOAPMessage +/

Local string &api_id = "9999999";
Local XmlNode &tempNode1, &tempNode2;
&tempNode1 = &XmlNode.AddElement("api_id").AddText(&api_id);
&tempNode1 = &XmlNode.AddElement("user").AddText(&userName);
&tempNode1 = &XmlNode.AddElement("password").AddText(&password);
&tempNode1 = &XmlNode.AddElement("text").AddText(&messageText);
&tempNode1 = &XmlNode.AddElement("to");
&tempNode2 = &tempNode1.AddElement("item").AddText(&sendTo);

end-method;

```

Setting Up Integration Broker for the SMS Channel

Note: Currently, Integration Broker setup is needed for the SMS and Push channels.

Nodes

Create a new External Node or use an existing Node. Oracle delivers the SCC-NTF_SMS node. Set up the properties of the Node as shown in the screenshots below.

Access Node Definitions **PeopleTools** > **Integration Broker** > **Integration Setup** > **Nodes**

This example illustrates the fields and controls on the Node Definitions page for SMS Notifications.

The screenshot displays the 'Node Definitions' page for the 'SCC-NTF_SMS' node. The page is organized into several sections:

- Node Name:** SCC-NTF_SMS
- *Description:** SMS node
- *Node Type:** External (dropdown menu)
- *Authentication Option:** None (dropdown menu)
- *Default User ID:** PS (text input with search icon)
- Checkboxes:**
 - Default Local Node
 - Local Node
 - Active Node
 - Non-Repudiation
 - Segment Aware
- Action Buttons:** Copy Node, Rename Node, Delete Node

This example illustrates the fields and controls on the Node Connectors page for SMS Notifications.

Node Definitions | **Connectors** | Portal | WS Security | Routings

Node Name: SCC_NTF_SMS Ping Node

Details

Gateway ID: LOCAL

Connector ID: HTTPTARGET

*Delivery Mode: Guaranteed Delivery

Properties Personalize | Find | First 1-3 of 3 Last

*Property ID	*Property Name	Required	Value
1	sendUncompressed	<input checked="" type="checkbox"/>	Y
2	Method	<input checked="" type="checkbox"/>	POST
3	URL	<input checked="" type="checkbox"/>	

▶ Password Encryption

This example illustrates the fields and controls on the Node Routings page for SMS Notifications.

Node Definitions | Connectors | Portal | WS Security | **Routings**

Node Name: SCC_NTF_SMS

Routing Name: Add

Routing Definitions Personalize | Find | View All | First 1 of 1 Last

Selected	Name	Service Operation	Service Operation Version	Operation Type	Sender Node	Receiver Node	Direction	Status	Results
<input type="checkbox"/>	SCC_NTF_SMS_SRV	SCC_NTF_SMS_SRV	v1	Synch	HC900CS2	SCC_NTF_SMS	Outbound	Active	

Ensure that there is an Active Outbound Routing from the local node to the external node. If not, create/generate an active routing.

Message

Create a new Non-Rowset based message as shown below. Access the Message Definition page (**PeopleTools > Integration Broker > Integration Setup > Messages**).

This example illustrates the fields and controls on the Message Definition page for SMS Notifications.

Message Definition | Schema

 **Status:** Message cannot be changed. Message referenced in runtime tables.

Message: SCC_NTF_SMS **Schema Exists:** No

Version: V1 **Part Message**

Alias:

Description: Message for SMS Service Oper

Owner ID: Campus Community

Comments:

[Service Operation References](#)

Root Element:

Message Type

- Rowset-based
- Nonrowset-based
- Container

Service Operation

Create a new Service Operation, as shown below, using the message created above. Access the Service Operation General page (**PeopleTools** > **Integration Broker** > **Integration Setup** > **Service Operations**).

This example illustrates the fields and controls on the Service Operation General page for SMS Notifications.

General | Handlers | Routings

Service Operation: SCC_NTF_SMS_SRV
 Operation Type: Synchronous
 *Operation Description: SMS Notification
 Operation Comments:
 User/Password Required
 *Req Verification: None
[Service Operation Security](#)
 Owner ID: Campus Community
 Operation Alias: Used with Think Time Methods

Default Service Operation Version

*Version: v1 Default Active
 Version Description: SMS Notification
 Version Comments:
 Non-Repudiation
 Runtime Schema Validation
[Introspection](#)
 Add Fault Type

Routing Status

Any-to-Local: Does not exist
 Local-to-Local: Does not exist

Routing Actions Upon Save

Generate Any-to-Local
 Generate Local-to-Local
 Transactional

Message Information

Type: Request
 Message.Version: SCC_NTF_SMS.V1 [View Message](#)

Type: Response
 Message.Version: SCC_NTF_SMS.V1 [View Message](#)

On the Routings tab, see that there is an active outbound Routing from the Local Node to the External node created above, as shown below:

This example illustrates the fields and controls on the Service Operation Routings page for SMS Notifications.

General | Handlers | **Routings**

Service Operation: SCC_NTF_SMS_SRV
 Default Version: v1
 User Exception
 Note: This user exception status is applicable only if an outbound routing cannot be determined. If a valid outbound routing can be determined then the user exception status on the actual routing will be used.

Routing Name:

Selected	Name	Version	Operation Type	Sender Node	Receiver Node	Direction	Status	Results
<input type="checkbox"/>	SCC_NTF_SMS_SRV	v1	Synch	HC900CS2	SCC_NTF_SMS	Outbound	Active	

Service

Create a new Service and add the Service Operation to the Service, as shown below. Access the Services page (**PeopleTools > Integration Broker > Integration Setup > Services**).

This example illustrates the fields and controls on the Services page for SMS Notifications.

Services

Service **SCC_NOTIFICATIONS** REST Service Type

*Description

Comments

Service Alias

Owner ID v

*Namespace

[Link Existing Operations](#) [View WSDL](#)

Service Operations

Service Operation

Operation Type v Add

Existing Operations

Personalize | Find | View All | First 1 of 1 Last

Operation	Message Links		
Operation.Default Version	Description	Active	Operation Type
SCC_NTF_SMS_SRV.v1	SMS Notification	<input checked="" type="checkbox"/>	Synch -

Please note that the above service needs to be called by PeopleCode in the consumer application.

Setting Up Push Notifications

Access the Push Notifications Setup page (**Set Up SACR > System Administration > Utilities > Notifications > Push Notifications Setup**).

This example illustrates the fields and controls on the Push Notifications Setup page. You can find definitions for the fields and controls later on this page.

Push Notifications Setup

***Application Name:**

Enable APNS Push Notifications

***Application Id:**

Enable GCM Push Notifications

***Application Id:**

***Google API Key:**

Push notifications are notifications sent from an external source, such as a server, to an application on a mobile device. They may appear as messages in the form of an alert, or as a banner, depending on the state of the application and user settings. When users are notified, they can launch the application, or they can ignore the notification, in which case the application is not activated. Notifications can also accompany an alert message with a brief, distinctive sound.

On iOS, the notification service is Apple Push Notification Service (APNS). Google Cloud Messaging (GCM) for Android provides the notification service for applications installed on Android-powered devices. A set of templates is available through the Campus Solutions Notifications Framework that enables Campus Solutions event handling through a push channel.

<i>Field or Control</i>	<i>Description</i>
Application Name	Enter a unique value across Campus Solutions that identifies the application or module configured to send push notifications.
Enable APNS Push Notifications	Select this check box to enable Apple smartphone users to receive push notifications from Campus Mobile and then enter an Application ID.

Field or Control	Description
Application ID	<p>Enter a globally unique fully qualified Application ID, such as edu.myuniversity.CM. The Application ID can be any string; however it must be globally unique for all applications accessing the APNS.</p> <p>For more information on using the Apple Push Notification service, refer to the iOS Developer Library section “Apple Push Notification Service.”</p> <hr/> <p>Note: For GCM push notifications, the Application ID can be the same or different from the one used for the APNS.</p>
Enable GCM Push Notifications	Select this check box to enable Android smartphone users to receive push notifications from Campus Mobile and then enter an Application ID and a Google API Key.
Google API Key	<p>Enter a generated key that gives the application server authorized access to Google services. You must obtain this key, typically using the Google API console, in order to use it for Google-based web service interaction.</p> <p>For information about the Google API process, see: http://developer.android.com/google/gcm/gs.html#create-proj</p>

Configuring Integration Broker to Use Socket Connector for Push Channel Delivered Services

Some Campus Solutions functionality, such as Campus Mobile, uses an SSL Socket connector for Apple Push Notifications. This connector is delivered with Campus Solutions and must be loaded and configured.

To load gateway connectors:

1. Copy the SSLSocketTargetConnector.class and SSLSocketTargetConnector\$1.class files from <PS_HOME>\class (for Windows) or <PS_HOME>/appserv/classes (for UNIX) to the following location: <PIA_HOME>\webserv\<DOMAIN>\applications\peoplesoft\PSIGW.war\WEB-INF\classes\com \peoplesoft\pt\integrationgateway\targetconnector.
2. Restart the web server.
3. Access the Gateways page (**PeopleTools > Integration Broker > Configuration > Gateways**).
4. Enter the URL and click the Load Gateway Connectors button.
5. Verify that Connector ID SSLSOCKETTARGET is loaded and save the page.

To configure gateway properties:

1. Access the Gateways page (PeopleTools, Integration Broker, Configuration, Gateways).
2. Click Gateway Setup Properties.

3. Provide User ID and Password in the Gateway Properties page.
4. Click OK.
5. Click the Advanced Properties Page link on the PeopleSoft Node Configuration page.
6. On the Gateway Properties page, provide values for secureFileKeystorePath and secureFileKeystorePasswd.
7. Click OK.
8. If the web server is behind a firewall, then provide values for ig.proxyHost and ig.proxyPort on the Gateway Properties page.
9. Click OK.

This example illustrates the fields and controls on the Loading Custom Gateway Connector for Push Notifications example.

Gateways

Gateway ID LOCAL [Inbound Gateways](#)
 Local Gateway Load Balancer [JMS Administration](#)
 URL

[Gateway Setup Properties](#)

Connectors		Personalize Find		First	1-12 of 12	Last
*Connector ID	Description	*Connector Class Name	Properties	+	-	
1	AS2TARGET	AS2TargetConnector	Properties	+	-	
2	EXAMPLETARGETCONN	ExampleTargetConnector	Properties	+	-	
3	FILEOUTPUT	SimpleFileTargetConnector	Properties	+	-	
4	FTPTARGET	FTPTargetConnector	Properties	+	-	
5	GETMAILTARGET	GetMailTargetConnector	Properties	+	-	
6	HTTPTARGET	HttpTargetConnector	Properties	+	-	
7	JMSTARGET	JMSTargetConnector	Properties	+	-	
8	PSFT81TARGET	ApplicationMessagingTargetConnector	Properties	+	-	
9	PSFTTARGET	PeopleSoftTargetConnector	Properties	+	-	
10	SFTPTARGET	SFTPTargetConnector	Properties	+	-	
11	SMTPTARGET	SMTPTargetConnector	Properties	+	-	
12	SSLSOCKETTARGET	SSLSocketTargetConnector	Properties	+	-	

Installing SSL Certificates and Configuring Platform Specific Server Keys

This setup is only needed for consumers using the PUSH channel. When making secured connections to and from the Apple and Google push notification servers, SSL certificates and platform specific server keys need to be in place and configured. Follow the steps below in order to configure SSL Certificates and server keys on Apple Push Notification Server (APNS) and Google Cloud Messaging (GCM) for Android.

For APNS

Install the SSL distribution certificate and private cryptographic key obtained on the server computer, on which the provider code runs and from which it connects with the development or production versions of APNs. To do so, complete the following steps:

1. Open Keychain Access utility and click the My Certificates category in the left pane.
2. Find the certificate that should be installed and disclose its contents. Both a certificate and a private key are displayed.
3. Select both the certificate and key, choose File > Export Items, and export them as a Personal Information Exchange (.p12) file.
4. Import this .p12 into pskey keystore on the webserver.

See https://developer.apple.com/library/mac/documentation/NetworkingInternet/Conceptual/RemoteNotificationsPG/Chapters/ProvisioningDevelopment.html#//apple_ref/doc/uid/TP40008194-CH104-SW1.

For GCM

Import root ca certificate accepted by Google into pskey keystore on peoplesoft web server.

Download GCM Certificate (ex: Geo Trust Global CA) from the browser with URL <https://android.googleapis.com/>.

Activating All Integration Broker Objects Delivered for Push Channel

This setup is needed only for consumers using the PUSH channel. Several IB objects delivered with the Notifications Framework need to be activated when enabling applications to use the Push Channel. The following sections list out the specific service operations, routings, queues and notification handlers which need to be enabled.

Service Operations

When configuring applications which use the Push Channel capability, ensure the following service operations and routings are activated:

Service	Service Operation	Type	Routing
SCC_NOTIFICATIONS	SCC_PUSH_NOTIFICATIONS	Asynchronous	-
SCC_NOTIFICATIONS	SCC_APNS_FEEDBACK	Synchronous	SCC_APNS_FEEDBACK
SCC_NOTIFICATIONS	SCC_APNS_SEND	Synchronous	SCC_APNS_SEND
SCC_NOTIFICATIONS_CONSUMER	SCC_GCM_SEND_POST	Synchronous	SCC_GCM_SEND_POST
SCC_NOTIFICATIONS_R	SCC_DEVICE_REGISTER_POST	Synchronous	SCC_DEVICE_REGISTER_POST

The following screenshot is an example of the SCC_NOTIFICATIONS->SCC_APNS_SEND service operation activation. Access the Service Operation General page (**PeopleTools > Integration Broker > Integration Setup > Service Operations**).

This example illustrates the fields and controls on the Service Operation General page for Push Channel.

The screenshot displays the 'Service Operation General' page for the 'SCC_APNS_SEND' service operation. The page is organized into several sections:

- General Information:** Service Operation (SCC_APNS_SEND), Operation Type (Synchronous), Operation Description (APNS Send), Operation Comments, Owner ID (Campus Community), and Operation Alias.
- Security and Verification:** User/Password Required (checkbox), Req Verification (None), and a link to Service Operation Security.
- Default Service Operation Version:** Version (v1), Version Description (APNS Send), Version Comments, and checkboxes for Default, Active, and Used with Think Time Methods.
- Routing Status:** A table showing routing status for Any-to-Local and Local-to-Local, both marked as 'Does not exist'.
- Runtime Schema Validation:** Checkboxes for Request Message, Response Message, and Non-Repudiation.
- Routing Actions Upon Save:** Checkboxes for Generate Any-to-Local, Generate Local-to-Local, and Transactional.
- Message Information:** Type (Request) and Message.Version (SCC_SSLSOCKET_REQ.V1) with a 'View Message' link.

To activate the service operation, ensure the Active check box is selected.

Routings

The following screenshot is an example of the routings activation. Access the Routing Definitions page (**PeopleTools > Integration Broker > Integration Setup > Routings**).

This example illustrates the fields and controls on the Routing Definitions page.

The screenshot shows the 'Routing Definitions' page with the following fields and controls:

- Routing Name:** SCC_APNS_SEND
- *Service Operation:** SCC_APNS_SEND
- Version:** v1
- *Description:** APNS Send
- Comments:** (Text area)
- *Sender Node:** PSFT_HR
- *Receiver Node:** SSL_SOCKET
- Operation Type:** Synchronous
- Owner ID:** Campus Community
- *Log Detail:** Header and Detail
- Active:** Active
- System Generated:** System Generated
- User Exception:** User Exception
- Graphical View:** [Graphical View](#)

To activate the routing, select the Active check box, save, and continue.

Queue: SCC_NTF_QUEUE

Access the Routing Definitions page (**PeopleTools > Integration Broker > Integration Setup > Queues**).

This example illustrates the fields and controls on the Queue Definitions page.

The screenshot shows the 'Queue Definitions' page with the following fields and controls:

- Queue Name:** SCC_NTF_QUEUE
- Description:** Notification Queue
- Comments:** (Text area)
- Archive:** Archive
- Unordered:** Unordered
- Queue Status:** Run
- Owner ID:** Campus Community

Operations Assigned to Queue:

Service	Version
SCC_PUSH_NOTIFICATIONS	v1

Define Partitioning Fields:

Include	Field	Alias Name
<input type="checkbox"/>	OPERATIONNAME	
<input type="checkbox"/>	PUBLISHER	
<input type="checkbox"/>	PUBPROC	

Buttons: Save, Add Field

Ensure the Queue Status is set to Run, save, and continue.

Notification Handlers

Activate the Notification Handler for SCC_PUSH_NOTIFICATIONS in SOA registry **Set Up SACR > System Administration > Integrations > Notification Handlers**.

This example illustrates the fields and controls on the Notification Handlers page.

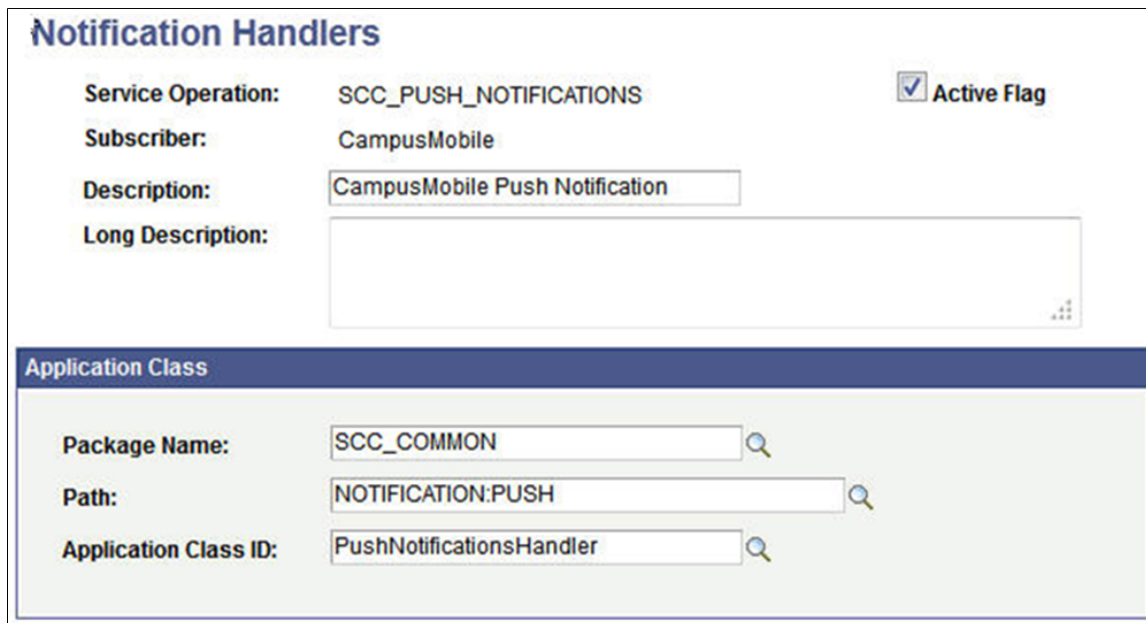

Notification Handlers

Service Operation: SCC_PUSH_NOTIFICATIONS **Active Flag**

Subscriber: CampusMobile

Description: CampusMobile Push Notification

Long Description:

Application Class

Package Name: SCC_COMMON

Path: NOTIFICATION:PUSH

Application Class ID: PushNotificationsHandler

Scheduling the APNS Feedback Job

This setup is only needed for consumers using the PUSH channel for APNS. APNS has a feedback service that maintains a list of devices for which there were failed-delivery attempts (that is, APNS was unable to deliver a push notification to an application on a device). The Campus Solutions Notifications Framework provides a job, APNSAE, which can be scheduled with a recurrence to periodically connect with the feedback service to see which devices have persistent failures so that it can refrain from sending push notifications to them. It is recommended to schedule the APNSAE job with a weekly recurrence.

Setting Up and Using the Events Framework

Use the Events Framework to track events and send notifications if required. The Events Framework provides the flexibility to track events and to connect to the Notifications Framework to send notifications.

The Events Framework can be used with or without the Notifications Framework.

The Batch Events Framework provides the flexibility to track batch events alone or with batch notifications for multiple consumers with multiple templates.

This topic discusses how to:

1. Configure an event for the Events Framework.

2. Trigger the Events Framework.

Page Used to Set Up the Events Framework

Page Name	Definition Name	Navigation	Usage
Event Setup	SCC_NTFEVT_CFG	Set Up SACR > System Administration > Utilities > Notifications > Event Setup	Configure the event and notification consumers related to the event to send notifications when the event is tracked.

Configuring an Event for the Events Framework

Access the Event Setup page (Set Up SACR > System Administration > Utilities > Notifications > Event Setup).

This example illustrates the fields and controls on the Event Setup page. You can find definitions for the fields and controls later on this page.

The screenshot shows the 'Event Setup' page with the following fields and controls:

- Event ID:** SCC_NTF_EVT_20131120095842
- *Event Name:** FINAL_GRADE_POSTED
- Status:** Active
- Description:** Final Grade Posted
- *Application Class:** SCC_USER_NOTIFICATIONS.EVENT.GradeEvent
- *Event Template Name:** FINAL_GRADE_POSTED

Below the fields is a table titled 'Notification Consumers' with the following data:

Consumer Name	Application Class
1 FINAL_GRADE_POSTED	SCC_USER_NOTIFICATIONS.EVENT.NOTIFIER.GradeE

Field or Control	Description
Event ID	Displays a read-only unique ID field which is generated automatically after successful save of component.
Event Name	Enter the event name.
Status	Select the event status. Only active events can be raised.
Description	Enter the event description.

Field or Control	Description
Application Class	Select the application class which is extending AbstractEvent class (SCC_COMMON:NOTIFICATION:EVENT:AbstractEvent) which handles the event notifications. Select the SCC_COMMON:NOTIFICATION:EVENT:BatchEvent app class for batch events.
Event Template Name	Select a Generic template which is configured for event message text and event context data.
View Event Template	Select this link to open the Generic Template Definition page for the selected template.
Consumer Name	Select the Notification consumer for this event to connect the Notifications Framework into the Events Framework. The Notifications Framework is invoked for the selected consumers when the event is raised.
Application Class	Select the application which is extending AbstractEventNotifier (SCC_COMMON:NOTIFICATION:EVENT:AbstractEventNotifier) application class which handles the connection with the Notifications Framework. Select SCC_COMMON:NOTIFICATION:EVENT:BatchEventNotifier app class for batch events.
View Consumer Details	Select this link to open the Notification Consumer Setup page for selected consumer.

Triggering the Events Framework

These methods must be used by the Events Framework to raise the event and to invoke the Notifications Framework:

1. Write an Event context App class that extends BaseEventContext.

Sample Code:

```
class GradeEventContext extends SCC_COMMON:NOTIFICATION:EVENT:BaseEventContext
```

2. Write an AppClass that extends AbstractEvent class. The Event ID must be passed to the Super Class constructor here, as shown below.

Sample Code:

```
%Super = create SCC_COMMON:NOTIFICATION:EVENT:AbstractEvent (&pEvtId);
```

- a. Implement the abstract method `populateEventContext()`. This method populates the event context with necessary information for further processing.

Sample Code:

```
method populateEventContext
    /+ &p_eventContext as SCC_COMMON:NOTIFICATION:EVENT:IEventContext +/
    /+ Extends/implements SCC_COMMON:NOTIFICATION:EVENT:AbstractEvent.popu=>
lateEventContext +/
    Local SCC_USER_NOTIFICATIONS:EVENT:CONTEXT:GradeEventContext &grdConte=>
xt = &p_eventContext As SCC_USER_NOTIFICATIONS:EVENT:CONTEXT:GradeEventCo=>
ntext;
    Local Record &recStdEnrl = &grdContext.recPayload;
    Local SCC_USER_NOTIFICATIONS:UTIL:UserNotificationUtil &ntfUtil = crea=>
te SCC_USER_NOTIFICATIONS:UTIL:UserNotificationUtil();

    &grdContext.getEventParameterMap().Put("%1", &ntfUtil.getClassDescript=>
or(&recStdEnrl));

    &grdContext.getEventDataMap().Put("EVENT_TYPE", "FINAL_GRADE_POSTED");
    &grdContext.getEventDataMap().Put("INST", String(&recStdEnrl.INSTITUTI=>
ON.Value));
    &grdContext.getEventDataMap().Put("CAREER", String(&recStdEnrl.ACAD_CA=>
REER.Value));
    &grdContext.getEventDataMap().Put("TERM", String(&recStdEnrl.STRM.Valu=>
e));
    &grdContext.getEventDataMap().Put("GOTO", "Grades");

end-method;
```

- b. Override the `onSuccess()`, `onError()` for custom behavior.

3. Raise the event by invoking the `EventHandler.raiseEvent()` by passing the event ID and event context or by passing the asynchronous service operation and rowset based on need.

Sample Code:

```
Local SCC_COMMON:NOTIFICATION:EVENT:EventHandler &evtHndlr = create SCC_COMMON=>
:NOTIFICATION:EVENT:EventHandler();

&evtHndlr.raiseEvent("SCC_NTF_EVT_20131120095842", &grdCntxt);

Or

&evtHndlr.publishMessage(OPERATION.SCC_NTF_PUBLISH_STDNT_ENRL, &rs_stdnt_enrl,>
"");
```

4. Write an Event Notifier App class that extends `AbstractEventNotifier` for each notification consumer for an event if notifications should be sent along with event notifications. The Consumer ID must be passed to the Super Class constructor here, as shown below.

Sample Code:

```
%Super = create SCC_COMMON:NOTIFICATION:EVENT:AbstractEventNotifier (&pNtfConsID =>
D);
```

Implement the `raiseEventNotification()` abstract method to send consumer notifications by invoking by existing notification consumer app class which extends `AbstractNotification`.

Sample Code:

```
method raiseEventNotification
  /+ &pEventContext as SCC_COMMON:NOTIFICATION:EVENT:IEventContext +/
  /+ Returns Number +/
  /+ Extends/implements SCC_COMMON:NOTIFICATION:EVENT:AbstractEventNotifier.r=>

raiseEventNotification +/
  Local SCC_USER_NOTIFICATIONS:EVENT:CONTEXT:GradeEventContext &grdContext = =>
&pEventContext As SCC_USER_NOTIFICATIONS:EVENT:CONTEXT:GradeEventContext;
  Local Record &p_EnrlRec = &grdContext.recPayload;
  Local string &ntfMode = &grdContext.ntfMode;

  Local SCC_USER_NOTIFICATIONS:NOTIFICATION:GradeNotifier &grdNtf = create SC=>
C_USER_NOTIFICATIONS:NOTIFICATION:GradeNotifier (%This.ntfConsID);
  &grdNtf.sendGrade (&p_EnrlRec.EMPLID.Value, &p_EnrlRec, &ntfMode);

  Return %This.getNotificationReqID (&grdNtf);
end-method;
```

Sending Batch Notifications and Events

The Batch Notifications run control page can be used to send notifications, events, or both in batch mode. This run control uses the Population Selection feature to select the EMPLIDs of the recipients who receive the notifications. Currently it can be used to send either events with or without batch notifications or batch notifications only with appropriate configuration. When the Enable Event Tracking check box is selected, it can be used to send events or events plus notifications to the consumers configured from the selected event. When Enable Event Tracking is not selected it can be used to send batch notifications for multiple consumers. Currently it can be used to send Email, SMS, Alert and Push notifications. It cannot send Worklist notifications, nor can it send notifications if the template recipient is configured to “Custom Logic”.

This topic discusses how to:

1. Manage batch notifications and events.
2. Use the Worklist Batch Process.

Page Used to Send Batch Notifications and Events

<i>Page Name</i>	<i>Definition Name</i>	<i>Navigation</i>	<i>Usage</i>
Batch Notifications	SCC_BAT_NTF_RC	Set Up SACR > System Administration > Utilities > Notifications	Send notifications, events, or Batch Notifications

Managing Batch Notifications and Events

Access the Batch Notifications page (**Set Up SACR > System Administration > Utilities > Notifications > Batch Notifications**).

This example illustrates the fields and controls on the Batch Notifications page. You can find definitions for the fields and controls later on this page.

Batch Notifications

Run Control ID: CHECKLIST_UPDATED_BATCH [Report Manager](#) [Process Monitor](#) Run

Academic Institution:

Population Selection

Population Selection

Selection Tool: [Edit Prompts](#)

Query Name: [Launch Query Manager](#) [Preview Selection Results](#)

Event Setup

Enable Event Tracking

*Event ID: [View Event](#)

Event Message Text: Your To Do list [%1] has been updated.

	Data Key	Description	Field Name	Value
1	%1	Checklist	CheckList Desor	
2	EVENT_TYPE	Event Type		CHECKLIST_UPDATE;
3	GOTO	Goto Feature		Checklist

Notification Consumers

Find | View All First 1 of 1 Last

Notification Consumer: [View Consumer](#) Enable For Batch

Notification Templates

Find | View All First 1 of 1 Last

Template Name: [View Template](#) Enable For Batch

Notification Item Tag:

Notification Importance:

Message Text: Dear %1, one or more items in your To Do list [%2] has been created or updated.

	Data Key	Description	Field Name	Value
1	%1	User	Name	
2	%2	CheckList Name	CheckList Desor	

Template Details

NotificationType: SMS

Notification Criticality: Informative

To: Preferred Email Address

Priority: 1-High

Subject: Checklist Notification

Population Selection

<i>Field or Control</i>	<i>Description</i>
Population Selection	Select this check box to enable the Selection Tool . This run control does not support manual selection.

<i>Field or Control</i>	<i>Description</i>
Selection Tool	Select the Population Selection tool available for this component.

Event Setup

<i>Field or Control</i>	<i>Description</i>
Enable Event Tracking	Select this check box when event tracking is needed. If it is selected, event configuration setup is available to configure it and send events. If it is not selected, only notification consumer and templates configuration are available to send notifications.
Event ID	Select an Event ID from the list of the Notifications Framework events.
View Event	Select this link to access the Event Setup page for selected event ID.
Event Message Text	Displays a read-only field populated from the selected event template configured in event setup.
Event Bind variables	<p>This grid is populated based on the event selected and the population query selected.</p> <ul style="list-style-type: none"> • Data Key: Displays the bind variable key from the generic template. • Description: Displays the bind variable description from the generic template. • Field Name: This is populated with the list of fields selected in the PS Query. Select the field from the PS Query to the bind variable, so that the value from the query can be used as bind value for the bind variable in the template. • Value: Enter a static value in this field for use as a bind value for the bind variable in the template.

Notification Consumers

<i>Field or Control</i>	<i>Description</i>
Notification Consumer	Select a consumer from the list of all active Notifications Framework consumers/Event framework consumers based on 'Enable Event Tracking' check box selection. If the 'Enable Event Tracking' check box is selected the list is populated with active consumers of selected event; otherwise the list is populated with all active notification framework consumers.
View Consumer	Click this link to access the Notification Consumer Setup page.
Enable for Batch	Select this check box to enable the flexibility to mark the consumer as enable/disable for the current batch process rather than deleting and configuring again.

Notification Templates

<i>Field or Control</i>	<i>Description</i>
Template Name	Select a template from the list of all active templates for the selected consumer. Currently, only templates of types Email, SMS, Alert & Push and those not set to use "Custom Logic" in recipient configuration are available.
View Template	Click this link to access the Notification Template setup page.
Enable for Batch	Select this check box to enable the flexibility to mark the template as enable/disable for current batch process rather than deleting and configuring again.
Notification Item Tag	Enter ad-hoc text to tag the notification. The text entered in this field is used to populate the notification item SCC_NTFREQ_ITM_TAG column.
Notification Importance	Select Notification Importance . By default this importance is populated with the generic template priority field. You can override this value.

<i>Field or Control</i>	<i>Description</i>
Message Text	<p>This is a read-only field populated from the selected notification template.</p> <p>This grid is populated based on the template name selected and the population query selected.</p> <ul style="list-style-type: none"> • Data Key: Displays the bind variable key from the generic template. • Description: Displays the bind variable description from the generic template. • Field Name: This drop-down list box is populated with the list of fields selected in the PS Query. Select the field from the PS Query to the bind variable, so that the value from the query can be used as bind value for the bind variable in the template. • Value: Enter a static value in this field for use as a bind value for the bind variable in the template.

Template Details

These fields are read-only fields populated from the selected notification template.

PS Query Creation Steps for Batch Notifications

PS Query should be created using the following steps to support dynamic queries in terms of selected fields and consumers can create their own queries.

Population Selection Context definition Name: Batch Notifications

Results record: SCC_BAT_NTF_TGT

This example illustrates the SCC_BAT_NTF_TGT Record Structure.

Record Fields		Record Type				
Nu	Field Name	Type	Len	Format	Short Name	Long Name
1	PROCESS_INSTANCE	Nbr	10		Instance	Process Instance
2	SCC_SEQ_ID	Nbr	10		ID	Sequence ID
3	EMPLID	Char	11	Upper	ID	Empl ID
4	NUMBER2	Nbr	2		No	Number
5	NUMBER10	Nbr	10		No	Number
6	NUMBER20	Nbr	20		No	Number
7	DATETIME1	DtM	26	Scnds	DateTime	DateTime
8	DATETIME2	DtM	26		DateTime	DateTime
9	DATETIME3	DtM	26	MicroS	DateTime	DateTime
10	DATE1	Date	10		Date 1	Date 1
11	DATE2	Date	10		Date 2	Date 2
12	DATE3	Date	10		Date 3	Date 3
13	DESCR5_1	Char	5	Mixed	Descr	Description
14	DESCR5_2	Char	5	Mixed	Descr	Description
15	DESCR5_3	Char	5	Mixed	Descr	Description
16	DESCR10	Char	10	Mixed	Descr	Description
17	DESCR20	Char	20	Mixed	Descr	Description
18	DESCR30	Char	30	Mixed	Description	Description
19	DESCR50	Char	50	Mixed	Descr	Description
20	DESCR100	Char	100	Mixed	Description	Description
21	DESCR35	Char	35	Mixed	Description	Description
22	DESCR35_1	Char	35	Mixed	Description	Description
23	DESCR50_1	Char	50	Mixed	Descr	Description
24	DESCR100_2	Char	100	Upper	Descr	Description
25	DESCRLONG	Long	0		Descr	Description

Usually Population Selection works with a predefined set of columns (field) list for selection. This predefined fields list is used in PS Query. To make the PS Query dynamic in terms of column list selection, Batch Notifications Run Control uses an approach to create PS Query with 'Expression' and use this expression as Field with a Unique name mapped to one of the appropriate fields in SCC_BAT_NTF_TGT.

For example, if a field 'D.NAME_DISPLAY' needs to be added to the select list (example from a delivered Query 'SCC_CHECKLIST'), then create an expression as follows:

This example illustrates the fields and controls on the Edit Expression Properties page.

Edit Expression Properties

***Expression Type**

Character Length

Aggregate Function Decimals

Expression Text

D.NAME_DISPLAY

[Add Prompt](#)
[Add Field](#)

Use the above Expression as field by clicking the Use as Fieldlink:

This example illustrates the fields and controls in the PSQuery Expression “Use as Field” Link Example.

Add Expression

Expressions List	Personalize	Find	First	1-3 of 3	Last
Expression Text	Use as Field	Add Criteria	Edit	Delete	
min(A.SEQ_3C)	Use as Field		Edit		
D.NAME_DISPLAY	Use as Field		Edit		
C.DESCR	Use as Field		Edit		

Click the Edit button for the field D.NAME_DISPLAY in the Fields tab of the Query manager:

This example illustrates the fields and controls on the PSQuery Fields page.

Records | Query | Expressions | Prompts | **Fields** | Criteria | Having | Transformations | View SQL | Run

Query Name SCC_CHECKLIST **Description** Person checklist Feed ▼

Working on selection Top Level of Query [Subquery/Union Navigation](#)

View field properties, or use field as criteria in query statement. Reorder / Sort

Fields	Personalize	Find	View All	First	1-4 of 4	Last			
Col	Record.FieldName	Format	Ord	XLAT	Agg	Heading Text	Add Criteria	Edit	Delete
1	D.EMPLID - ID	Char11				ID		Edit	
2	D.NAME_DISPLAY	Char50				Name		Edit	
3	C.DESCR	Char30				CheckList Descr		Edit	
4	min(A.SEQ_3C)	Num5.0				Seq3C		Edit	

Enter the appropriate Heading Text and map the Unique Field Name with one of the appropriate available fields in the results record (SCC_BAT_NTF_TGT) - in this example - DESCR50.

This example illustrates the fields and controls on the PSQuery Edit Field Properties page.

Edit Field Properties

Field Name D.NAME_DISPLAY

Heading	Aggregate
<input type="radio"/> No Heading <input type="radio"/> RFT Short	<input checked="" type="radio"/> None
<input checked="" type="radio"/> Text <input type="radio"/> RFT Long	<input type="radio"/> Sum
Heading Text <input type="text" value="Name"/>	<input type="radio"/> Count
*Unique Field Name <input type="text" value="DESCR50"/>	<input type="radio"/> Min
	<input type="radio"/> Max
	<input type="radio"/> Average

While executing such PS Queries using Population Selection, the result data is inserted in to the results record with the fields mapping. In this example, D.NAME_DISPLAY is inserted in DESCR50 and it is also used in the Batch Notifications process.

Using the Worklist Batch Process

The Worklist Batch Process (SCC_NTFWKLTO) handles Timeout and Reminder processing for worklist notifications. The process selects worklist items and then invokes the callback application class defined in the notification template setup.

The process consists of two steps:

1. Selects Worklist items that have timed out – not worked/completed and the due date has passed. For each item selected, the status is set to Timeout.
2. Selects Worklist items that may need a reminder notification to be sent – not worked/completed and the due Date has not passed.

Setting up a Recurrence for the Worklist Batch Process

The process does not have a Run Control component. The process should be run after midnight to avoid any timing issues (date changes). A recurrence (**PeopleTools > Process Scheduler > Recurrences**) must be created and then assigned to the Process Definition for SCC_NTFWKLTO.

Be sure to select the check box for “Do not schedule any processes missed from the recurrence pattern”.

This example illustrates the fields and controls on the Recurrence Definition page.

The screenshot shows the 'Recurrence Definition' page. At the top, there are two tabs: 'Recurrence Definition' (selected) and 'Recurrence Exception'. The main heading is 'Recurrence Definition'. Below this, there are several sections:

- Recurrence Name:** SCC_NTFWKLTO
- Description:** SCC_NTFWKLTO
- Schedule Next Recurrence when:** Radio buttons for 'Current request is initiated' and 'Prior recurrence has completed' (selected).
- Recurrence Pattern:** Radio buttons for 'Daily', 'Weekly', 'Monthly', and 'Customize Dates'. Under 'Daily', there are checkboxes for 'Everyday', 'Sunday', 'Monday', 'Tuesday', 'Wednesday', 'Thursday', 'Friday', and 'Saturday', all of which are checked.
- Start Request:** Date: 08/01/2013, Time: 1:00:00AM
- End Request:** Date: [empty], Time: [empty]
- Repeat:** Every: 0 Minutes, For: 0 Hours
- Do not schedule any processes missed from the recurrence pattern.
- Run on Specific Dates:** A table with columns: Run Date (From), Run Date (To), Effective Until (Year), and Description. The table is currently empty.

Once the Recurrence has been created, it can be assigned to the SCC_NTFWKLTO process definition (**PeopleTools > Process Scheduler > Processes**).

This example illustrates the fields and controls on the Process Definitions Options page.

The screenshot shows the 'Process Definition Options' page. At the top, there are five tabs: 'Process Definition', 'Process Definition Options' (selected), 'Override Options', 'Destination', and 'Page Transfer'. The main heading is 'Process Definition Options'. Below this, there are several sections:

- Process Type:** Application Engine
- Name:** SCC_NTFWKLTO
- Server Name:** [empty]
- Recurrence Name:** SCC_NTFWKLTO
- On File Creation:** File Dependency: ; Wait for File: [empty]; Time Out Max Minutes: [empty]
- System Recovery Process:** Process Type: [empty]; Process Name: [empty]
- Process Security:** Component: PRCSMULTI; Process Groups: ALLPAGES

Managing Notification Preferences

Self-service users can set and update their preferences for how they receive notifications using the Notifications Preferences page in Self Service.

See “Managing Notification Preferences in Self Service” (Campus Self Service).

Administrators can also manage notification preferences for users

Note: These preferences are ignored if the Override Notification Preferences check box has been selected on the Notification Setup page. This capability is offered for situations where a recipient must be sent a notification even if they have not set their preferences, and particularly relates to Delegated Access/New User Registration.

See [Configuring Notification Setup for the Generic Templates](#).

Page Used to Manage Notification Preferences

<i>Page Name</i>	<i>Definition Name</i>	<i>Navigation</i>	<i>Usage</i>
Notification Preferences	SCC_NTF_PREF	Campus Community > Personal Information > Biographical Attributes > Notification Preferences	Set and update users' notification preferences. > Personal

Setting and Updating Notification Preferences

Access the Notification Preferences page (**Campus Community > Personal Information > Biographical > Personal Attributes > Notification Preferences**).

This example illustrates the fields and controls on the Notification Preferences Page (Administrative).

Notification Preferences

Kimberly Adams AA0001 ★

Enable SMS Notification

Enable Email Notification

Phone Type: Mobile 414345681

Email Type: Campus HCMGENUser1@ap6023fems.us.oracle.com

Administrators can use this page to set and update users' notification preferences. Users must have at least one email or SMS type for a preference to be set.

See [Managing Personal Attributes Information](#).

See “Using Self-Service Personal Attributes Data” (Campus Self Service).

Setting Up Security for Admin Notifications

The Admin Notification pages are similar to the self-service Notifications Center pages.

See “Using the Self-Service Notifications Center” (Campus Self Service).

However, unlike the self-service pages, the admin pages include the following features:

1. They show notifications for many notification recipients.
2. Subject to security settings, announcements can be reviewed, generated and deleted from the Announcements tab.
3. Subject to security settings, Worklist items can be updated, created and deleted.

While the self-service pages are secured by user ID, the admin notifications pages are secured at the notification consumer, then user ID levels.

Before an administrator can see data in the admin pages, the administrator must have particular permission in addition to the usual page permissions. This security operates at two levels:

- **Level 1: Notification Consumer security** Before notifications belonging to a particular consumer can be seen in PIA, the consumer must be included and assigned an access code in the Campus Community Installation component. This level operates like a “master switch” and enables the consumer to control whether their notifications are visible in the notifications admin pages, and if so whether read only or read/update.
- **Level 2: User ID security** After a consumer’s notifications have been globally enabled, they can be further refined at the user ID level. For example, a Delegated Access consumer may be set as Read/Update at the installation level, but not all users may be granted that level of access and may only require Read Only access.

This topic discusses how to:

- Set up notification consumer admin access.
- Set up notification consumer security.

Pages Used to Set Up Security for Admin Notifications

<i>Page Name</i>	<i>Definition Name</i>	<i>Navigation</i>	<i>Usage</i>
Notification Consumer Admin	SCC_NTF_INSTCON	Set Up SACR > Install > Campus Community Installation > Notification Consumer Admin	Configure notification consumer admin access.

<i>Page Name</i>	<i>Definition Name</i>	<i>Navigation</i>	<i>Usage</i>
Notification Consumer Security	SCC_NTF_OPR_CON	Set Up SACR > Security > Secure Student Administration > User ID > Notification Consumer Security	Set access levels to consumers at operator level.

Setting Up Notification Consumer Admin Access

Access the Notification Consumer Admin page (**Set Up SACR > Install > Campus Community Installation > Notification Consumer Admin**).

This example illustrates the fields and controls on the Notification Consumer Admin page. You can find definitions for the fields and controls later on this page.

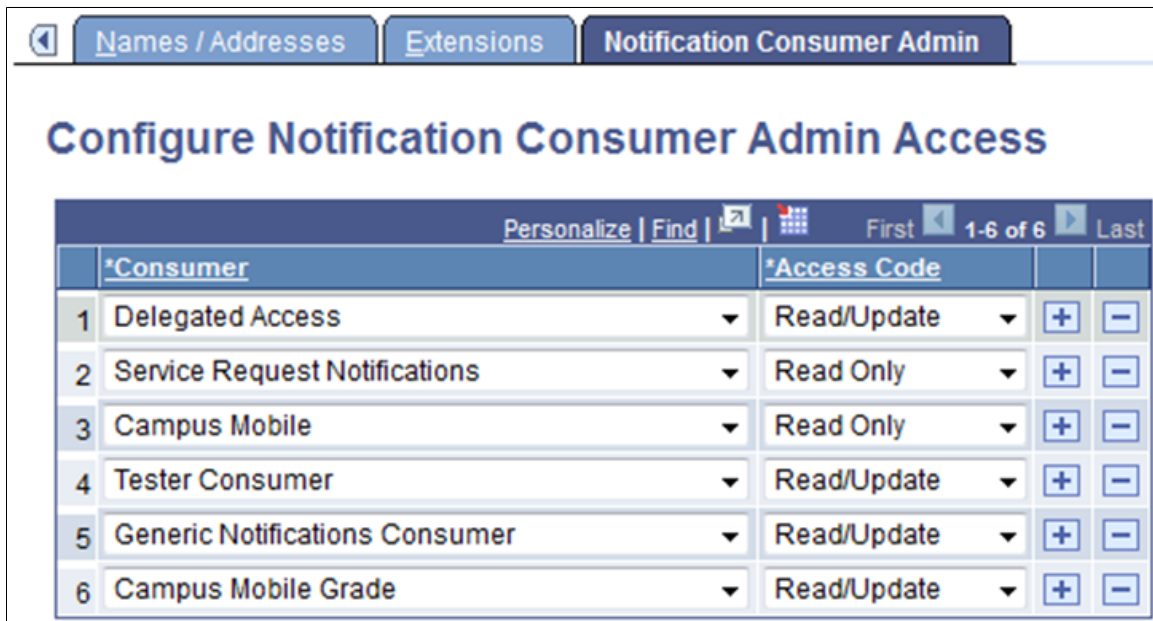

This is level 1 security setup.

<i>Field or Control</i>	<i>Description</i>
Consumer	Select a Notifications Framework Consumer with which various notifications templates and their related processing code are associated.

Field or Control	Description
Access Code	Select an Access Code to establish whether a user can only view the notification or can also update it. Note: The extent to which a notification can be updated is limited, and impacts only Worklist Items (indicating if completed) and Announcements (creation and deletion). For the other notification types, Read/Update is effectively the same as Read Only.

When level 2 security exists for a particular consumer for at least one user, you cannot change the level 1 access setup for that particular consumer. If you try to change, you receive an error message: *Cannot change the setup.*

When level 2 security exists for a particular consumer for at least one user, you cannot delete level 1 access setup for that consumer. If you try to delete, you receive an error message: *Cannot delete this row.*

Setting Up Notification Consumer Security

Access the Notification Consumer Security page (**Set Up SACR > Security > Secure Student Administration > User ID > Notification Consumer Security**).

This example illustrates the fields and controls on the Notification Consumer Security page.

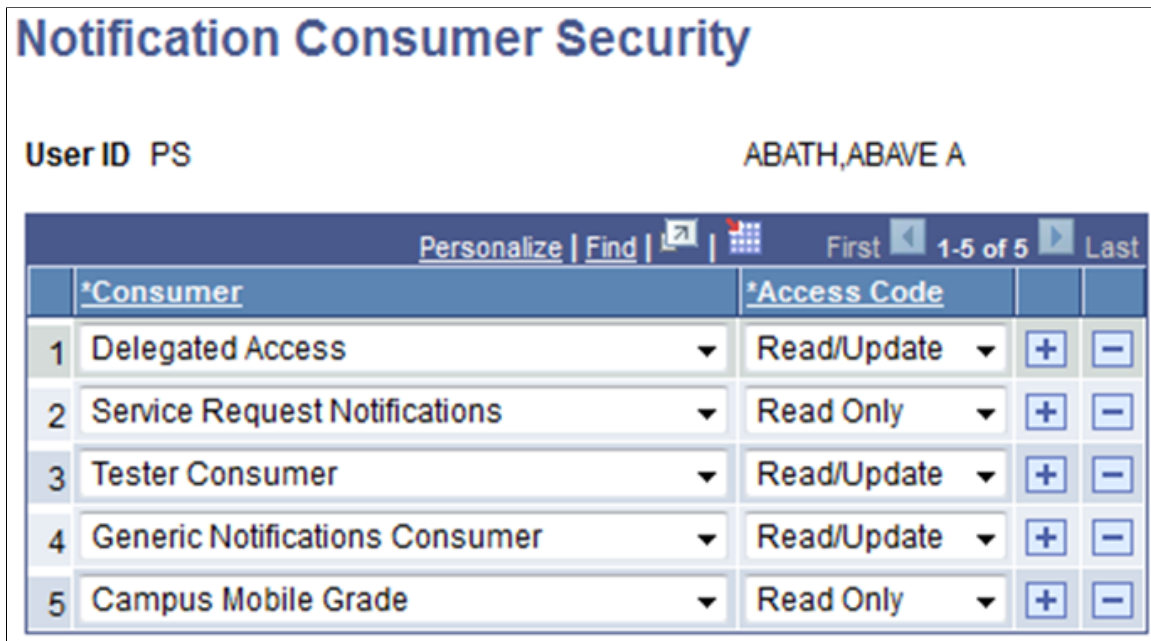

This is level 2 security setup, which is at the user level.

If level 1 security for any particular consumer is Read Only, then the only Access Code option here is Read Only.

When a logged-in user has read-only access to a particular consumer, then all details of (Email, Alert, Worklist, SMS) notifications that are created using that consumer appear in read-only mode on the

Notifications Administration Overview page and no option exists to create announcements. This is also the case if a logged-in user has read-only access to Generic Notifications Consumer.

Using Admin Notifications

While the self-service Notifications pages are intended for a user to check and interact with his or her own notifications, the Admin Notifications pages are intended for users such as a research supervisor or administrative manager who are responsible for notifications sent to particular users.

Because the Admin Notification pages can display notifications for multiple users, a search page is provided so that someone such as an administrator can either:

- Search for specific notification recipients using search criteria in the conventional manner *or*
- Show all notifications that they are permitted to view by selecting the Show All Notifications check box.

If no notifications are found, or the user lacks the requisite permissions, the Notifications Administration Overview page shows a message No Notification items found for selected criteria. Otherwise the user can view the notifications that appear in an almost identical manner to those shown for the self-service Notifications Center, with following exceptions if the administrator's access mode is set to Read/Update:

1. In the Worklist Details page, the Worklist item can be marked as completed.
2. On the Announcements tab, the trash can (deletion) icon and the Create Announcement button become available.

Page Used to Review and Manage Notifications

Page Name	Definition Name	Navigation	Usage
Notifications Administration Overview	SCC_NTF_ADMN_MAIN	Campus Community > Notifications > Admin Notifications > Notifications Administration Overview	Review and manage notifications.

Reviewing and Managing Notifications

This example illustrates the fields and controls of the Notifications Administration Overview page.

Notifications Administration Overview					
Email SMS Alert Worklist Push Announcements					
Date From	Date To	Consumer Name	Importance	Message text	
07/30/2013	04/23/2016	Generic Notifications Consumer	Low	The University Rowing Club is seeking new members - Refer to the Rowing Club website for more information.	
07/01/2013	03/25/2016	Generic Notifications Consumer	Medium	Urgent! The water main outside of the main lecture hall has burst and the area has been closed until further notice. Please check the University Maintenance website for rescheduled classes pending repairs.	
08/01/2013	04/25/2016	Generic Notifications Consumer	Medium	Acme Undergraduate Scholarship applications are now open to current undergraduate students with disabilities. Applications close August 31, 2013 and can be found at www.oracle.com .	

Create Announcement

Features of the Notifications Administration Overview page include:

- Each notification type has its own tab where notifications of that type are shown.
- The notifications are shown in descending date and time order, so that the newest one is at the top, unless the user resorts the list by another column heading.
- For Email, the Subject of the email and Sender information is shown. The emails listed here are those that were sent with this particular ID as the 'To' recipient. The emails that were sent with this ID as 'Cc' or 'Bcc' recipient are not shown.
- The Period default value is 7 days.
- All details shown on the Email tab are shown on the SMS and Alerts tabs, except Sender information. Because SMS does not have a Subject, the message text is displayed instead.
- The Worklist tab has an extra field Life Left Days that shows how many days remain until the deadline for the worklist item is reached. Similar to SMS and Alerts, the Worklist tab does not include a Sender column.
- The Worklist tab also has a Status field with the values Unactioned and Actioned. If permitted, the user can change the status of the worklist item by selecting the Details link for Worklists and selecting the Read/Actioned check box. The worklist item is then listed in the Actioned list.
- The Announcements tab also includes extra features for the creation and removal of announcements, subject to security, which is discussed in the next section.

Announcements

An administrator can use the Announcements feature to announce information to ALL students, without being restricted to specific EmplIDs. The Notifications alert channel was enhanced to provide this functionality. Announcements are essentially alert-type notifications. However, unlike alerts, there is no

recipient EMPLID for announcements; instead an audience indicator (SCC_NTF_AUDCE) is populated, indicating the particular alert is an Announcement.

The SCC_NTF_AUDCE field is found in the Notification Detail record (SCC_NTFREQ_DTL) with possible values of NA and ST. This field defaults to NA. The ST value indicates that this Alert type notification is actually an Announcement applicable for all students.

To create an announcement, the user clicks the Create Announcement button on the Announcement tab, which opens an Announcements window (shown below). The user then enters data in the required fields. Details of the template can be viewed by clicking on the information icon next to the template name. After the required details are populated, the user clicks the Publish button to send the Announcement to all students.

This example illustrates the fields and controls of the Announcements page.

The screenshot displays the 'Announcements' page with the following fields and controls:

- Consumer Name:** Generic Notifications Consumer
- Template Name:** SCC_NTF_ANNOUNCEMENT (with an information icon)
- Priority:** 1-High (dropdown menu)
- Publish From:** 04/09/2014 (calendar icon)
- Life in days:** (empty text input field)
- *Announcement Text:** A rich text editor containing the text 'Create Announcement from Admin Notifications'. The editor includes a toolbar with icons for undo, redo, bold, italic, underline, font color, background color, bulleted list, numbered list, link, unlink, and text color.

At the bottom of the form are two buttons: 'Cancel' and 'Publish'.

Announcements sent from this page can also be viewed in the self-service Notifications Center.

See “Using the Self-Service Notifications Center” (Campus Self Service).

The recent announcements also appear on the SCE springboard page.

Refer to the Simplified Campus Experience documentation in My Oracle Support (ID 1600569.1).

Features of the Announcements tab include:

- Administrators who have read/update access to Generic Notifications Consumer can create announcements using the Create Announcement button.
- All announcements including the timed-out announcements are listed on the Announcements tab.
- Depending on the access level setup for logged-in user for that consumer, the Delete icon is visible on the Announcements tab. If a user has read-only access for a consumer, the Delete icon is not visible for that particular row. When an admin user has read/update access the Delete icon is available.
- When creating announcements:
 - A user can set the priority of the announcement as High, Medium and Low.
 - The date entered in the Publish From field is displayed as the Date From field in the Announcement tab. If Publish From is greater than current date, the announcement appears in the grid from that date.
 - The value entered in the Life in days field is added to the date entered in the Publish From field and it becomes the Date To value on the Announcement tab.
 - Announcement Text is a mandatory field. If it is blank, a warning message is displayed.
 - If a user clicks the Publish button, the announcement appears in the Announcements grid.

Using Online Notifications

Online notifications functionality provides the ability for a user to create a notification manually and is implemented in the following Research Tracking components:

- Candidate Management
- Thesis Management
- Candidate Management Override
- Administrator Profile
- Administrator Self-service
- Service Request Management
- Project Management

A consumer ID has been created for each of these components with their respective templates. The bind variables which are particular to these specific components are defined in generic templates. Online notifications support Email, Alert and SMS notification channels.

See “Setting Up Online Notifications” (Student Records).

For further information about using online notifications, including the Create Notification page, see: “Using Online Notifications” (Student Records).

Implementing Online Notifications

Two generic pages are created:

1. A subpage which has the Send Notification button. (No PeopleCode is present in this. Consumers have to write PeopleCode for this button to populate the notification context, consumer ID and Bind variable data which is specific to this component. A sample PeopleCode is given below.)
2. A secondary page for selecting the values (channel, template, To, Cc, Bcc) and send notifications.

The PeopleCode for populating Consumer ID and the component specific data (that is, values for the template variables) is written at component record field (Send Notification) level in the fieldchange event. This PeopleCode varies from component to component because Consumer ID and template variables differs. Here is the sample code for the (Research Tracking) Service Request Management component. A component variable for notification context is created and consumer ID is populated.

```
import SCC_ADHOC_NTF:AdhocNotificationContext;
Component SCC_ADHOC_NTF:AdhocNotificationContext &adhoc;
&adhoc = create SCC_ADHOC_NTF:AdhocNotificationContext();
&adhoc.SCC_NTF_CONSUMER_ID = "SCC_NTF_CON_20130211040026";

Local Record &recdtl, &recPersonName;
Local string &RecipientEMPLID, &StudentName, &nRequestType, &nRequestSubtype, &nCom⇒
ment, &nStatus, &nReqCat, &URL, &instDesc, &typeDesc, &subtypeDesc, &statusDesc, &s⇒
sStatusDesc, &RecipientName, &catDesc, &ApproverName, &AssignedToName, &ap⇒
prvID, &assgnTo, &reqDt, &actionDt, &effDt;;

&Emplid = SSR_RS_REQSTHDR.EMPLID.Value;
&Institution = SSR_RS_REQSTHDR.INSTITUTION.Value;
&nRequestType = SSR_RS_REQSTHDR.SSR_RS_REQUEST_TYPE.Value;
&nRequestSubtype = SSR_RS_REQSTHDR.SSR_RS_REQ_SUBTYPE.Value;
&ReqID = SSR_RS_REQSTHDR.SSR_RS_REQUEST_ID.Value;
&candNbr = SSR_RS_REQSTHDR.SSR_RS_CANDIT_NBR.Value;
&reqNbr = SSR_RS_REQSTHDR.SSR_RS_SEQUENCE.Value;
&reqstdtl = GetLevel0() (1).GetRowset(Scroll.SSR_RS_REQSTDTL);
&recdtl = &reqstdtl.GetRow(CurrentRowNumber()).GetRecord(Record.SSR_RS_REQSTDTL);
&ReqSeq = &recdtl.SSR_RS_REQ_SEQ.Value;
&RecipientEMPLID = &recdtl.SSR_RS_ASSIGNEDTO.Value;
    &nComment = &recdtl.SSR_RS_DESCRLONG.Value;
&nStatus = &recdtl.SSR_RS_STATUS.Value;
&apprvID = &recdtl.SSR_RS_APPRVR_ID.Value;
&assgnTo = &recdtl.SSR_RS_ASSIGNEDTO.Value;
&reqDt = &recdtl.SSR_RS_REQUEST_DT.Value;
&actionDt = &recdtl.SSR_RS_ACTION_DT.Value;
&effDt = &recdtl.EFFDT.Value;
&recPersonName = CreateRecord(Record.PERSON_NAME);
&recPersonName.EMPLID.Value = &Emplid;
If &recPersonName.SelectByKey() Then
    &StudentName = &recPersonName.NAME_DISPLAY.Value;
End-If;

SQLExec("select name_display from %table(PERSON_NAME) where emplid=:1 ", &Recipient⇒
EMPLID, &RecipientName);
SQLExec("select name_display from %table(PERSON_NAME) where emplid=:1 ", &assgnTo, ⇒
&AssignedToName);
SQLExec("select A.descr100, A.ssr_Rs_request_cat from PS_SSR_RS_REQSTTYP A where in⇒
```

```

stitution=:1 and sssr_Rs_rquest_type=:2 and %effdtcheck(SSR_RS_REQSTYP efl, A, %cur⇒
rentdatein) ", &Institution, &nRequestType, &typeDesc, &nReqCat);
SQLExec("select A.descr100 from PS_SSR_RS_REQSTCAT A where A.institution=:1 and A.s⇒
sr_Rs_request_cat=:2 and %effdtcheck(SSR_RS_REQSTCAT efl, A, %currentdatein) ", &I⇒
nstitution, &nReqCat, &catDesc);
SQLExec("select A.descr50 from PS_SSR_RS_RQSUBTYP A where A.institution=:1 and A.ss⇒
r_Rs_request_type=:2 and A.ssr_Rs_req_subtype=:3 and %effdtcheck(SSR_RS_RQSUBTYP efl⇒
, A, %currentdatein) ", &Institution, &nRequestType, &nRequestSubtype, &subtypeDes⇒
c);

&adhoc.getParameterMap().Put("%1", &RecipientName);
&adhoc.getParameterMap().Put("%2", &RecipientEMPLID);
&adhoc.getParameterMap().Put("%3", &Emplid);
&adhoc.getParameterMap().Put("%4", &StudentName);
&adhoc.getParameterMap().Put("%5", &instDesc);
&adhoc.getParameterMap().Put("%6", "" | &ReqID);
&adhoc.getParameterMap().Put("%7", "" | &ReqSeq);
&adhoc.getParameterMap().Put("%8", &catDesc);
&adhoc.getParameterMap().Put("%9", &typeDesc);
&adhoc.getParameterMap().Put("%10", &subtypeDesc);
&adhoc.getParameterMap().Put("%11", &nComment);
&adhoc.getParameterMap().Put("%12", &statusDesc);
&adhoc.getParameterMap().Put("%13", &URL);
&adhoc.getParameterMap().Put("%14", &candNbr);
&adhoc.getParameterMap().Put("%15", &reqDt);
&adhoc.getParameterMap().Put("%16", &apprvID);
&adhoc.getParameterMap().Put("%17", &ApproverName);
&adhoc.getParameterMap().Put("%18", &assgnTo);
&adhoc.getParameterMap().Put("%19", &AssignedToName);
&adhoc.getParameterMap().Put("%20", &actionDt);
&adhoc.getParameterMap().Put("%21", &effDt);
&adhoc.getParameterMap().Put("%22", "" | &reqNbr);
DoModalS(Page.SCC_NTF_ADHOC, "", 0, 0);

```

Following is a sample notification setup for online notifications:

This example illustrates the fields and controls on the Notification Setup page.

Notification Setup

Notification Template ID: SCC_NTF_TMP_20130925003014

***Template Name:**

Status:

Description:

***NotificationType:** **Override Notification Preferences**

Email Content Type:

***Notification Criticality:**

***Generic Template:** [View Generic Template](#)

Recipients Configuration ?

To

- Preferred Email Address
- Custom Logic
- Static Address

This example illustrates the fields and controls on the Generic Template Definition Page for NFK

Generic Template Definition
Blackberry Email Responses

Template: SSR_ONLINE_SREQ_EMAIL

***Description:**

Instructional Text:

Priority:

***Sender:** **Email ID:**

Subject:

Message Text:

Below is the list of available variables for this template.
You can use template variables within your subject or message text.
The following variables can also be used:
%Date, %DateTime, %Time, %ServerTimeZone, %EmailAddress, %NotificationPriority, %NotificationToList, %NotificationCCList

NFK Web Services GET and SEND (SCE)

As part of Simplified Campus Experience (SCE) features, two web services were created for Notifications Framework – GET and SEND.

Refer to the Simplified Campus Experience documentation in My Oracle Support (ID 1600569.1)

- SCC_GET_NOTIFICATIONS (primarily for the retrieval of Alerts and Worklist Items, but can also be used to retrieve Item detail for Email and SMS).
- SCC_SEND_NOTIFICATIONS (primarily for sending Emails and SMS from devices that do not contain native support, but can also be used to send Alerts and Worklist Items).

These service operations have been created under a common existing service SCC_NOTIFICATIONS. The schema for the GET and SEND request messages are shown below.

GET Request

SCC_GET_NOTIF_REQ

The request message gives flexibility to retrieve from any channel type using generic filtering criteria from the Item or to search using specific Item keys if they are known. All notifications for the logged-in user are fetched by the service. Further details on the tag items are mentioned below.

```
<?xml version="1.0"?>
<SCC_GET_NOTIF_REQ xmlns="http://xmlns.oracle.com/Enterprise/services">
  <EMPLID></EMPLID>
  <SCC_NTFREQ_ID></SCC_NTFREQ_ID>
  <SCC_NTF_CON_ID></SCC_NTF_CON_ID>
  <SCC_NTFREQ_TYPE></SCC_NTFREQ_TYPE>
  <SCC_NTFREQ_ITMTAG1></SCC_NTFREQ_ITMTAG1>
  <SCC_NTFREQ_ITMTAG2></SCC_NTFREQ_ITMTAG2>
  <SCC_NTFREQ_ITMTAG3></SCC_NTFREQ_ITMTAG3>
  <SCC_NTFREQ_ITMTAG4></SCC_NTFREQ_ITMTAG4>
  <SCC_NTFREQ_ITM_STS></SCC_NTFREQ_ITM_STS>
  <SCC_NTFREQ_ITM_TAG></SCC_NTFREQ_ITM_TAG>
  <SCC_NTF_DATE_FROM></SCC_NTF_DATE_FROM>
  <SCC_NTF_DATE_TO></SCC_NTF_DATE_TO>
  <SCC_NTFREQ_SUB_STS></SCC_NTFREQ_SUB_STS>
  <SCC_NTFREQ_DTL_SEQ></SCC_NTFREQ_DTL_SEQ>
  <SCC_NTFREQ_ITM_SEQ></SCC_NTFREQ_ITM_SEQ>
  <SCC_NTF_AUDCE></SCC_NTF_AUDCE>
</SCC_GET_NOTIF_REQ>
```

Tag Item	Tag Item Details
EMPLID	The EMPLID is always populated with the logged-in user's EMPLID as it supports only self-service users.
SCC_NTFREQ_ID	When mentioned, the Notification Request ID fetches items having the same value for Request ID as what has been passed. This is essentially a filter.
SCC_NTFREQ_TYPE	Possible values are EML, SMS, WKL and ALT. When supplied, this parameter fetches only notifications of the given type for the particular EMPLID.
SCC_NTFREQ_ITM_TAG ... SCC_NTFREQ_ITMTAG4	This fetches items based on the tags associated with them.
SCC_NTFREQ_ITM_STS, SCC_NTFREQ_SUB_STS	This filters items based on their Status and Sub-Status. Items with a status such as ERROR, or sub-status such as DELETED/TIMEDOUT are not qualified for selection.
SCC_NTFREQ_DTL_SEQ, SCC_NTFREQ_ITM_SEQ	This, when combined with the notification request ID, focuses on a single item, which is then fetched by the get service.

Tag Item	Tag Item Details
SCC_NTF_DATE_FROM, SCC_NTF_DATE_TO	When values are given for from and to dates, all the SMS/EML notifications created within the given range are retrieved. For ALT/WKL all items which are active in the given date range are retrieved. This also includes all open-ended items.
SCC_NTF_AUDCE	It can have two possible values currently as mentioned above - ST/NA. When ST value is passed, only the Announcement Notifications is returned by the service. In case no value (is treated as NA) or NA value is passed, all notifications – EML/SMS/WKL/ALT – are fetched along with the announcement notifications.

This is a sample response message:

```
<?xml version="1.0"?>
<SCC_GET_NOTIF_RESP xmlns="http://xmlns.oracle.com/Enterprise/services">
  <NTK_ITEM>
    <SCC_NTFREQ_ID>282</SCC_NTFREQ_ID>
    <SCC_NTFREQ_DTL_SEQ>1</SCC_NTFREQ_DTL_SEQ>
    <SCC_NTFREQ_ITM_SEQ>1</SCC_NTFREQ_ITM_SEQ>
    <EMPLID>SR0448</EMPLID>
    <SCC_NTF_CON_ID>SCC_NTF_CON_20130512074705</SCC_NTF_CON_ID>
    <SCC_NTF_DATE_FROM>2013-07-08</SCC_NTF_DATE_FROM>
    <SCC_NTF_DATE_TO></SCC_NTF_DATE_TO>
    <SCC_NTFREQ_TYPE>ALT</SCC_NTFREQ_TYPE>
    <SCC_NTFREQ_TMPLTID>SCC_NTF_TMP_20130512074210</SCC_NTFREQ_TMPLTID>
    <SCC_NTFREQ_SUBJECT>Test Template for ALERT Notifications</SCC_NTFREQ_SUBJECT>
  >
  <SCC_NTFREQ_IMPTNCE>2</SCC_NTFREQ_IMPTNCE>
  <SCC_NTFREQ_ITM_STS>S</SCC_NTFREQ_ITM_STS>
  <SCC_NTFREQ_SUB_STS>U</SCC_NTFREQ_SUB_STS>
  <SCC_NTFREQ_ITM_TAG>VISWA</SCC_NTFREQ_ITM_TAG>
  <SCC_NTFREQ_ITMTAG1>TAG1</SCC_NTFREQ_ITMTAG1>
  <SCC_NTFREQ_ITMTAG2>TAG2</SCC_NTFREQ_ITMTAG2>
  <SCC_NTFREQ_ITMTAG3>TAG3</SCC_NTFREQ_ITMTAG3>
  <SCC_NTFREQ_ITMTAG4>TAG4</SCC_NTFREQ_ITMTAG4>
  <SCC_ROW_ADD_DTTM>07/30/2013 17:19:56.000000</SCC_ROW_ADD_DTTM>
  <SCC_NTFREQ_MSGTEXT>This is a test template for ALERT Notifications.

  Value 1 - Test1
  Value 2 - tst2
  Value 5 - tst3
  </SCC_NTFREQ_MSGTEXT>
  <SCC_NTF_AUDCE>NA</SCC_NTF_AUDCE>
  </NTK_ITEM>
</SCC_GET_NOTIF_RESP>
```

Note: If a SOAP service request XSD contains the “languageCd” parameter, then the service is enabled for National Language Support (NLS) and an ISO Locale value needs to be passed as the languageCd variable. Valid values can be found by navigating to **PeopleTools > Utilities > International > Languages**.

SEND Request

SCC_SEND_NOTIF_REQ

The Send request is comprised of the Item detail, a parameter map of tokens, and optional Base64 attachments (for the email channel only).

```
<?xml version="1.0"?>
<SCC_SEND_NOTIF_REQ xmlns="http://xmlns.oracle.com/Enterprise/services">
  <EMPLID>SR0451</EMPLID>
  <SCC_NTF_CON_ID></SCC_NTF_CON_ID>
  <SCC_NTF_DATE_FROM></SCC_NTF_DATE_FROM>
  <SCC_NTF_DATE_TO></SCC_NTF_DATE_TO>
  <SCC_NTFREQ_TMPLTID>SCC_NTF_TMP_20130404201255</SCC_NTFREQ_TMPLTID>
  <SCC_NTFREQ_IMPTNCE></SCC_NTFREQ_IMPTNCE>
  <SCC_NTFREQ_ITM_TAG>TEST</SCC_NTFREQ_ITM_TAG>
  <SCC_NTFREQ_ITMTAG1></SCC_NTFREQ_ITMTAG1>
  <SCC_NTFREQ_ITMTAG2></SCC_NTFREQ_ITMTAG2>
  <SCC_NTFREQ_ITMTAG3></SCC_NTFREQ_ITMTAG3>
  <SCC_NTFREQ_ITMTAG4></SCC_NTFREQ_ITMTAG4>
  <PARAMETER_MAP>
    <PARAMETER>
      <SCC_NTFREQ_DAT_KEY>%1</SCC_NTFREQ_DAT_KEY>
      <SCC_NTFREQ_DAT_VAL>This is a Test email.</SCC_NTFREQ_DAT_VAL>
    </PARAMETER>
    <PARAMETER>
      <SCC_NTFREQ_DAT_KEY>%2</SCC_NTFREQ_DAT_KEY>
      <SCC_NTFREQ_DAT_VAL>From the friendly NFK</SCC_NTFREQ_DAT_VAL>
    </PARAMETER>
  </PARAMETER_MAP>
  <ATTACHMENTS>
    <ATTACHMENT>
      <fileName>Scooby.jpg</fileName>
      <Base64Data>/9j/4AAQSkZJRgABAQEAYAB</Base64Data>
    </ATTACHMENT>
  </ATTACHMENTS>
</SCC_SEND_NOTIF_REQ>
```

The Send request must have the following parameters populated – EMPLID and SCC_NTFREQ_TMPLTID.

Other than the parameters already explained above, the send request also holds the template parameters - SCC_NTFREQ_DAT_KEY and SCC_NTFREQ_DAT_VAL. This holds the value of the bind variables defined in the generic template.

If the notification web service results in a successful send, an empty XML is returned as response.

NFK Web Services for Push Notifications

As part of Push Notifications, the following REST web service operation was created for Notifications Framework: SCC_DEVICE_REGISTER_POST (Used to register a device with Campus Solutions to receive push notifications).

This service operation has been created under a common existing service: SCC_NOTIFICATIONS_R.

This is the schema for the request message, SCC_DEVICE_REGISTER_REQ:

```
<?xml version="1.0"?>
<SCC_DEVICE_REGISTER_REQ isDeleted="" xmlns="http://xmlns.oracle.com/Enterprise/ser=>
```

```

vices">
  <DEVICE_TOKEN isDeleted="">
    <SCC_USERNAME></SCC_USERNAME>
    <SCC_NTF_DEV_TKNID></SCC_NTF_DEV_TKNID>
    <SCC_NTF_TOKEN_TYPE></SCC_NTF_TOKEN_TYPE>
    <SCC_NTF_MOB_APP_ID></SCC_NTF_MOB_APP_ID>
    <SCC_NTF_CREATE_DT></SCC_NTF_CREATE_DT>
  </DEVICE_TOKEN>
</SCC_DEVICE_REGISTER_REQ>

```

Tag Item	Tag Item Details
SCC_USERNAME	User Name is populated with logged-in UserName in mobile device.
SCC_NTF_DEV_TKNID	Token ID value is populated with tokenId/RegistrationId received from APNS/GCM after successful registration of the device with APNS/GCM to receive Push Notifications.
SCC_NTF_TOKEN_TYPE	Token Type is populated with value APNS/GCM based on mobile device OS. If it is Android device the value is GCM and if it is an Apple Device the value is
APNS. SCC_NTF_MOB_APP_ID	This value is Mobile Application ID to register for push Notifications with Campus Solutions.
SCC_NTF_CREATE_DT	Dummy element

This is a sample response message:

```

<SCC_DEVICE_REGISTER_RESP xmlns="http://xmlns.oracle.com/Enterprise/services">
  <DEVICE_REG_SUCCESS>Y</DEVICE_REG_SUCCESS>
</SCC_DEVICE_REGISTER_RESP>

```

NFK Web Services for Events

As part of Push Notifications, the following rest web service operations were created for the Notifications Framework:

- SCC_NTF_GET_EVENTS_R_POST (primarily for the retrieval of events list along with read/unread/total events count)
- SCC_NTF_UPDATE_EVENTS_R_POST (primarily for updating the event status which returns the latest read/unread/total events count)

These service operations have been created under a common existing service – SCC_NOTIFICATIONS_R.

SCC_NTF_GET_EVENTS_R_POST

SCC_NTF_GET_EVENTS_REQ (request message for SCC_NTF_GET_EVENTS_R_POST)

```
<?xml version="1.0"?>
<SCC_NTF_GET_EVENTS_REQ_R>
  <NUM_PAST_DAYS>7</NUM_PAST_DAYS>
  <INCLUDE_EVENTS>N</INCLUDE_EVENTS>
</SCC_NTF_GET_EVENTS_REQ_R>
```

Tag Item	Tag Item Details
NUM_PAST_DAYS	Past number of days to retrieve events.
INCLUDE_EVENTS	<ul style="list-style-type: none"> “Y” – includes events in the response along with read/unread/total events count. “N” – only read/unread/total events count in the response.

SCC_NTF_GET_EVENTS_RESP (response message for SCC_NTF_GET_EVENTS_R_POST)

```
<?xml version="1.0"?>
<SCC_NTF_GET_EVENTS_RESP xmlns="http://xmlns.oracle.com/Enterprise/services">
  <TOTAL_EVENTS_COUNT>12</TOTAL_EVENTS_COUNT>
  <READ_EVENTS_COUNT>8</READ_EVENTS_COUNT>
  <UNREAD_EVENTS_COUNT>4</UNREAD_EVENTS_COUNT>
  <EVENTS>
    <SCC_NTF_EVENT>
      <SCC_NTFEVT_REQ_ID>487</SCC_NTFEVT_REQ_ID>
      <EMPLID>SR12030</EMPLID>
      <SCC_NTFEVT_STATUS>R</SCC_NTFEVT_STATUS>
      <SCC_NTFEVT_STARTDT>03/21/2014 10:04:43.000000</SCC_NTFEVT_STARTDT>
      <SCC_NTFEVT_MESSAGE>Your final grade for SOC 103.2 has been posted.</SCC_NTFEVT_MESSAGE>
    </SCC_NTF_EVENT>
  </EVENTS>
  <DATA>
    <SCC_NTFEVT_DATA>
      <SCC_NTFEVT_DAT_KEY>CAREER</SCC_NTFEVT_DAT_KEY>
      <SCC_NTFEVT_DAT_VAL>UGRD</SCC_NTFEVT_DAT_VAL>
    </SCC_NTFEVT_DATA>
    <SCC_NTFEVT_DATA>
      <SCC_NTFEVT_DAT_KEY>EVENT_TYPE</SCC_NTFEVT_DAT_KEY>
      <SCC_NTFEVT_DAT_VAL>FINAL_GRADE_POSTED</SCC_NTFEVT_DAT_VAL>
    </SCC_NTFEVT_DATA>
    <SCC_NTFEVT_DATA>
      <SCC_NTFEVT_DAT_KEY>GOTO</SCC_NTFEVT_DAT_KEY>
      <SCC_NTFEVT_DAT_VAL>Grades</SCC_NTFEVT_DAT_VAL>
    </SCC_NTFEVT_DATA>
    <SCC_NTFEVT_DATA>
      <SCC_NTFEVT_DAT_KEY>INST</SCC_NTFEVT_DAT_KEY>
      <SCC_NTFEVT_DAT_VAL>PSUNV</SCC_NTFEVT_DAT_VAL>
    </SCC_NTFEVT_DATA>
    <SCC_NTFEVT_DATA>
      <SCC_NTFEVT_DAT_KEY>TERM</SCC_NTFEVT_DAT_KEY>
      <SCC_NTFEVT_DAT_VAL>0710</SCC_NTFEVT_DAT_VAL>
    </SCC_NTFEVT_DATA>
  </DATA>
</SCC_NTF_EVENT> </EVENTS>
</SCC_NTF_GET_EVENTS_RESP>
```

Tag Item	Tag Item Details
TOTAL_EVENTS_COUNT	Total number of events from NUM_PAST_DAYS sent in the request.
READ_EVENTS_COUNT	Total number of read events from NUM_PAST_DAYS sent in the request.
UNREAD_EVENTS_COUNT	Total number of unread events from NUM_PAST_DAYS sent in the request.
SCC_NTFEVT_REQ_ID	Event request ID which uniquely identifies an event.
EMPLID	Employee ID.
SCC_NTFEVT_STATUS	Status of the event. "R" - Read "U" - Unread .
SCC_NTFEVT_STARTDT	Event occurred datetime.
SCC_NTFEVT_MESSAGE	Event Message
SCC_NTFEVT_DAT_KEY	Key for data map (key-value pairs).
SCC_NTFEVT_DAT_VAL	Value for data map (key-value pairs).

SCC_NTF_UPDATE_EVENTS_R_POST

SCC_NTF_UPDATE_EVENTS_REQ (request message for SCC_NTF_UPDATE_EVENTS_R_POST)

```
<?xml version="1.0"?>
<SCC_NTF_UPDATE_EVENTS_REQ>
  <NUM_PAST_DAYS>7</NUM_PAST_DAYS>
  <EVENTS>
    <SCC_NTF_EVENT>
      <SCC_NTFEVT_REQ_ID>216</SCC_NTFEVT_REQ_ID>
      <SCC_NTFEVT_STATUS>R</SCC_NTFEVT_STATUS>
    </SCC_NTF_EVENT>
  </EVENTS>
</SCC_NTF_UPDATE_EVENTS_REQ>
```

Tag Item	Tag Item Details
NUM_PAST_DAYS	Past number of days to retrieve events.

<i>Tag Item</i>	<i>Tag Item Details</i>
SCC_NTFEVT_REQ_ID	Event request ID for which status has to be updated.
SCC_NTFEVT_STATUS	Status of the event to be updated. "R" - Read "U" - Unread.

SCC_NTF_UPDATE_EVENTS_RESP (response message for SCC_NTF_UPDATE_EVENTS_R_POST)

```
<?xml version="1.0"?>
<SCC_NTF_UPDATE_EVENTS_RESP xmlns="http://xmlns.oracle.com/Enterprise/services">
  <TOTAL_EVENTS_COUNT>12</TOTAL_EVENTS_COUNT>
  <READ_EVENTS_COUNT>8</READ_EVENTS_COUNT>
  <UNREAD_EVENTS_COUNT>4</UNREAD_EVENTS_COUNT>
  <RESP_DTTM>03/25/2014 12:38:47.000000</RESP_DTTM>
</SCC_NTF_UPDATE_EVENTS_RESP>
```

<i>Tag Item</i>	<i>Tag Item Details</i>
TOTAL_EVENTS_COUNT	Total number of events from NUM_PAST_DAYS sent in the request.
READ_EVENTS_COUNT	Total number of read events from NUM_PAST_DAYS sent in the request.
UNREAD_EVENTS_COUNT	Total number of unread events from NUM_PAST_DAYS sent in the request.
RESP_DTTM	Timestamp of the response.

Testing the Notifications Framework

Page Used to Test the Notifications Framework

<i>Page Name</i>	<i>Definition Name</i>	<i>Navigation</i>	<i>Usage</i>
Notification Framework Tester	SCC_NTF_TESTER	Set Up SACR > System Administration > Utilities > Notification Framework Tester.	Test email, SMS, alert and Notification Framework Tester.

Access the Notification Framework Tester page (**Set Up SACR > System Administration > Utilities > Notifications > Notification Framework Tester**).

This example illustrates the fields and controls on the Notification Framework Tester page. You can find definitions for the fields and controls later on this page.

Notification Framework Tester

***Notification Consumer:**

***Template Name:** [View Template](#) ***Employee ID:**

Description: **Notification Item Tag:**

NotificationType: Email **Notification Item Tag1:**

Notification Criticality: Informative **Notification Item Tag2:**

To: Static Address **Notification Item Tag3:**

Generic Template: NTF_EMAIL_TESTER [View Generic Template](#) **Notification Item Tag4:**

Priority: 2-Med **Notification Importance:**

Attachment File Path: **Attachment File Name:**

Subject: Tester Template For Email Notifications

Message Text:

This is a tester template for Email Notifications.

 Template Variable 1 - %1
 Template Variable 2 - %2
 Template Variable 5 - %5

Template Variables			
Notification Template ID	Data Key	Description	Value
SCC_NTF_TMP_20130512074114	%1	Template Variable 1	<input type="text" value="zcx99"/>
SCC_NTF_TMP_20130512074114	%2	Template Variable 2	<input type="text" value="zcx999"/>
SCC_NTF_TMP_20130512074114	%5	Template Variable 5	<input type="text" value="zc99"/>

Field or Control	Description
Notification Consumer	Select the consumer for which you want to test notifications. Tester Consumer has been created specifically for this purpose.
Template Name	Select the notification template that you want to use for testing the notifications framework. This list is populated based on selection of the Notification Consumer. All templates for the consumer which have a value of Preferred or Static for Email Address/Phone Number/EmplID on the Notification Setup page are available. Templates with a value of Custom Logic are not populated in the list.
View Template	Select this link to access the Notification Setup page to view the selected template.
View Generic Template	Select this link to access the Generic Template Definition page for the selected template.

Field or Control	Description
Broadcast Audience Flag	This field appears only when the Notification Type is Alert. If you select N/A, you must then select an EmplID. If you select Student, the notification is sent to all EmplIDs.
Employee ID	The Employee ID field should be populated with the context Employee ID value. The same would reside in the database in SCC_NTFREQ_DTL.EMPLID (Record.Field). Retrieval of Notification items would also be based on the same Employee ID.
Notification Item Tag (1– 4)	Enter any value for these fields, which are treated as tags for the Notification items. The same would also be populated in the Notification Context.
Notification Importance	If you set Notification Importance here, it overrides the Importance value set in the Generic Template setup.
Attachment File Path	This field appears only for Email templates. Here, you must provide the shared location and file name, for example, <code>\\slc00sun\Share\Roses.jpg</code> . The file would then appear as an attachment in the email notification as “Roses.jpg”.
Attachment File Name	This field appears only for Email templates. Enter the name of the file as you want it to display in the email attachment. If you enter “Lotus” here, the above attachment would appear as “Lotus.jpg” in the email notification. You can also override the file attachment type here. If you enter a filename “Lotus.txt”, the attachment type is changed from .jpg to .txt. If no value is entered here, the file has the original name as in the file path.

The **Notification Type**, **Notification Criticality**, **To**, **Priority**, **Subject**, and **Message Text** fields are populated based on the selected template. The template variables defined for a generic template also appear when the template is selected. Populate the **Value** field against each template variable (data key) in the grid, **Save** and then click **Send Notification**.

See [Configuring the Generic Templates for Notifications Framework](#).

See [Configuring Notification Setup for the Generic Templates](#).

Purging Notifications Framework Records

The Notifications Framework can generate a huge amount of transactional data. For performance improvement and data managing requirements, the process of archive and purge becomes very important.

PeopleSoft Data Archive Manager is used for archiving or purging NFK transaction data.

The end-user enters the date until when the archiving is required. After the date is entered, the process retrieves all data from the NFK transaction records to the corresponding NFK history records which have been created as part of this feature.

PS Query is the selection tool used for filtering the data to be archived/purged. The NFK records have been added under SCC_NTFREQ_HDR in the Query tree. Simultaneously history records were created for each NFK transaction record. This is where the archived data is available after the archive process is run. Archive object and Archive Templates are also delivered as part of this feature.

Query tree – NFK Archive: A child group has been added as shown below:

This example illustrates the NFK Archive Query Tree.

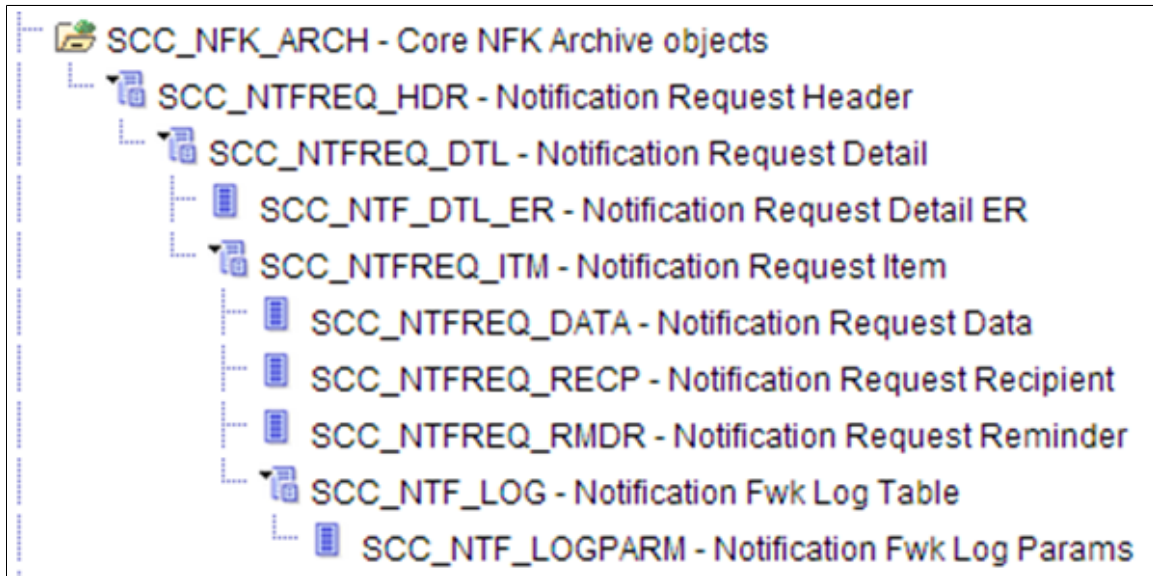

The Archive Object definition delivered. Access the Manage Archive Objects page (**PeopleTools > Data Archive Manager > Manage Archive Objects**).

This example illustrates the Manage Archive Object page for NFK Objects.

Archive Object: SCC_NFK_ARCH		Description: NFK Core Records	
Records in Archive Object			
Base Record	*Archiving Record	Description	*History Record
1 <input checked="" type="checkbox"/>	SCC_NTFREQ_HDR	Notification Request Header	SCC_NTF_HDR_HST
2 <input type="checkbox"/>	SCC_NTFREQ_DTL	Notification Request Detail	SCC_NTF_DTL_HST
3 <input type="checkbox"/>	SCC_NTFREQ_DATA	Notification Request Data	SCC_NTF_DAT_HST
4 <input type="checkbox"/>	SCC_NTFREQ_ITM	Notification Request Item	SCC_NTF_ITM_HST
5 <input type="checkbox"/>	SCC_NTFREQ_RECPC	Notification Request Recipient	SCC_NTF_REC_HST
6 <input type="checkbox"/>	SCC_NTFREQ_RMDR	Notification Request Reminder	SCC_NTF_RMD_HST
7 <input type="checkbox"/>	SCC_NTF_DTL_ER	Notification Request Detail ER	SCC_NTF_ER_HST
8 <input type="checkbox"/>	SCC_NTF_LOG	Notification Fwk Log Table	SCC_NTF_LOG_HST
9 <input type="checkbox"/>	SCC_NTF_LOGPARM	Notification Fwk Log Params	SCC_NTF_LGP_HST

The Archive Template delivered. Access the Manage Archive Templates page (**PeopleTools > Data Archive Manager > Manage Archive Templates**).

This example illustrates the Manage Archive Templates page for NFK Objects.

Archive Template: SCC_NFK		Description: NFK Data Archive	
Archive Template Objects			
Base Object	*Archive Object	Description	
<input checked="" type="checkbox"/>	SCC_NFK_ARCH	NFK Core Records	
Selective Archiving Queries			
*Query Name	Description		
SCC_NFK_ARCH	NFK Archive Process Query		
<input type="checkbox"/> Template Allows Selective Restoring of Data From History			
Selective Restoring Queries			
*Query Name	Description		
AE Processes			
*Archive Process	Pre AE Program	Post AE Program	

Access the Archive Data To History page (**PeopleTools > Data Archive Manager > Archive Data To History**).

To run the Archive/Purge process, run the SCC_NFK archive template with the following options as shown below:

This example illustrates the Archive Data To History page for NFK Objects.

Archive Template	
*Archive Template:	SCC_NFK <input type="text"/> NFK Data Archive
Archive Process	
*Process Type	Selection <input type="text"/> copying from on-line tables to history tables
Selection Criteria	
<input checked="" type="radio"/> Selective Query	SCC_NFK_ARCH <input type="text"/> NFK Archive Process Query Define Binds
<input type="radio"/> Batch Number	<input type="text"/> View Details
Commit Processing	
<input type="radio"/> Commit at End	
<input checked="" type="radio"/> Set-Based Processing	
<input type="radio"/> Row-Based Processing	
<input checked="" type="checkbox"/> Audit Row Count	

Use the Define Binds link to indicate the date until which the Archive is required.

Archiving Events

To archive the Event NFK transaction records the end-user selects a date until when the archiving is required, and check boxes for read and unread events. After those details are entered, the process retrieves all data from the Event NFK transaction records to the corresponding Event NFK history records which have been created as part of this feature.

PS Query is the selection tool used for filtering the data to be archived/purged. We have added the SCC_NTF_EVENT record under existing Query tree. Simultaneously history records were created for each Event NFK transaction record. This is where the archived data is available after the archive process is run. Archive object and Archive Templates are also delivered as part of this feature.

Query tree – Child record for Event NFK Archive:

This example illustrates the NFK Event Archive Query Tree.



PSQuery:

This example illustrates the fields and controls on the Query Properties page.

Query Properties

*Query:

Description:

Folder:

*Query Type:

*Owner:

Distinct Security Join Optimizer

Query Definition:

Last Updated Date/Time: 01/28/2014 4:10:02AM

Last Update User ID: PS

Access the Manage Archive Objects page (**PeopleTools > Data Archive Manager > Manage Archive Objects**).

This example illustrates the fields and controls on the Manage Archive Object page for NFK Events.

Manage Archive Objects

Archive Object: Description:

Records in Archive Object					
	Base Record	*Archiving Record	Description	*History Record	
1	<input checked="" type="checkbox"/>	SCC_NTF_EVENT	Event Notification	SCC_NTF_EVENT_H	<input type="checkbox"/> <input type="checkbox"/>
2	<input type="checkbox"/>	SCC_NTFEVT_DATA	Event Notification Data	SCC_NTFE_DATA_H	<input type="checkbox"/> <input type="checkbox"/>
3	<input type="checkbox"/>	SCC_NTFEVT_LOG	Event Log	SCC_NTFE_LOG_H	<input type="checkbox"/> <input type="checkbox"/>
4	<input type="checkbox"/>	SCC_NTFEVT_PARM	Event Parameter Map Data	SCC_NTFE_PARM_H	<input type="checkbox"/> <input type="checkbox"/>
5	<input type="checkbox"/>	SCC_NTFEVT_RLTN	Event Relation With NFK	SCC_NTFE_RLTN_H	<input type="checkbox"/> <input type="checkbox"/>
6	<input type="checkbox"/>	SCC_NTFEVT_LOGP	Event Log paramter	SCC_NTFE_LOGP_H	<input type="checkbox"/> <input type="checkbox"/>

Access the Manage Archive Templates page (**PeopleTools > Data Archive Manager > Manage Archive Templates**).

This example illustrates the fields and controls on the Manage Archive Templates page for NFK Events.

Manage Archive Templates

Archive Template: Description:

Archive Template Objects			
Base Object	*Archive Object	Description	
<input checked="" type="checkbox"/>	SCC_NFK_EVENT_AI	NFK Event Core Records	<input type="checkbox"/> <input type="checkbox"/>

Selective Archiving Queries			
*Query Name	Description		
SCC_NFK_EVENT_ARCHIVE	NTF Event Archive Query	<input type="checkbox"/>	<input type="checkbox"/>

Template Allows Selective Restoring of Data From History

Selective Restoring Queries			
*Query Name	Description		
		<input type="checkbox"/>	<input type="checkbox"/>

AE Processes			
*Archive Process	Pre AE Program	Post AE Program	
			<input type="checkbox"/> <input type="checkbox"/>

Access the Archive Data To History page (**PeopleTools > Data Archive Manager > Archive Data To History**).

To run the Archive/Purge process, create a run control ID, run the SCC_ENFK archive template with the following options as shown below:

This example illustrates the fields and controls on the Archive Data To History page for NFK Events.

Run Control ID: SCC_EVENT [Report Manager](#) [Process Monitor](#) Run

Archive Template

*Archive Template: NKF Event Data Archive

Archive Process

*Process Type copying from on-line tables to history tables

Selection Criteria

Selective Query NTF Event Archive Query [Define Binds](#)

Batch Number

[View Details](#)

Commit Processing

Commit at End

Set-Based Processing

Row-Based Processing

Audit Row Count

Define the date until when the Archive is required and set check boxes to select read and unread events using the **Define Binds** link.

Setting Up and Using Delegated Access Framework

Understanding Delegated Access

Delegation is when a person authorizes another to serve as his or her representative for a particular task. With the Delegated Access framework, a user can authorize another user to perform a task on their behalf by delegating access to perform a transaction.

Delegated Access is a framework owned by Campus Community that standardizes who can delegate what to whom. The framework enables you to define what components a delegator (for example, a student) can delegate to one or more proxies (for example, the parents). It integrates with the Constituent Transaction Management (CTM) framework, the New User Registration framework, the Notifications framework (email notification utility), and the PeopleTools security management to grant access to certain pages in your system.

The most common use for delegation in the Campus Solutions system is when students need to give access to a parent to view or update their personal, academic, or financial information. The parent may be unknown to the system and therefore needs to register and create a user profile to access your system.

Warning! Delegating a transaction is performed by a self-service user in a delivered self-service component called Share My Information (SS_CC_DA_SHAREINFO). Only a security administrator who is familiar with the Campus Solutions self-services components, PeopleSoft security, and how you manage your security must set up Delegated Access.

Delegation Terminology

The following terms are important to the understanding of Delegated Access framework and are used throughout the documentation:

Term	Definition
Delegation	The act of delegating one's access to another user.
Delegator	A person that delegates access to another user (for example, a student).
Proxy	A person granted access to act on behalf of another user (for example, a parent).
Revoke	When a delegated access is withdrawn.

Term	Definition
Delegation Transaction	A set of one or more components and pages whose access a delegator can delegate to a proxy. Those components are contained in a security role associated to a transaction during setup. The role is provisioned to the proxy's user profile for him or her to be allowed to perform the transaction.
Delegated Access Components	Self-service components that are configured for delegated access.
New User Registration (NUR) framework	Framework that enables the proxy to either create a user ID and password or reuse an existing user ID to sign into the Campus Solutions system and perform the delegated transaction.
Notifications framework	Framework that enables email notifications to be sent to the delegator and to the proxy when new transactions are delegated or revoked.

Delegated Access Process

This image shows the Delegated Access process.

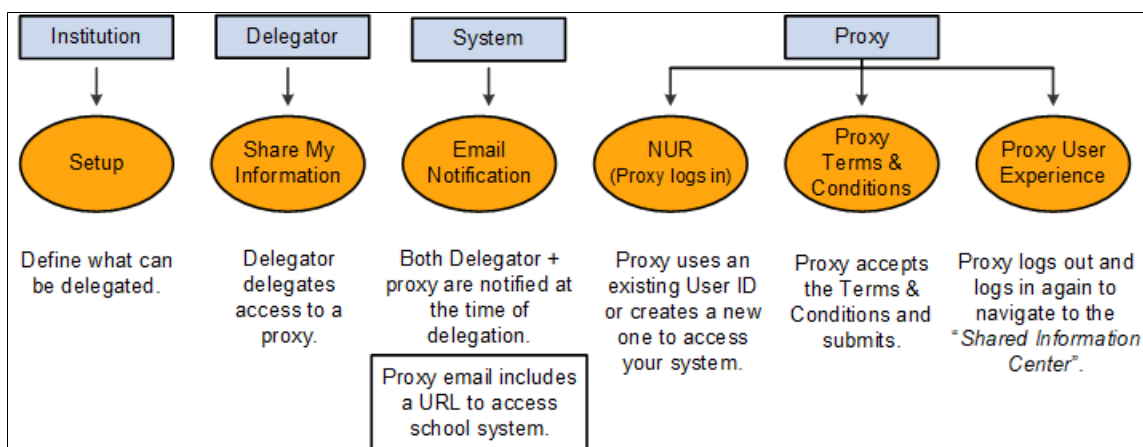

The following explains the Delegated Access (DA) process:

1. The Institution sets up the delegation transactions in the Delegation Transaction Setup page. On this page you set up a delegation transaction by listing a security role that contains one or more components that you want to delegate. These components must be configured for delegated access. The system then provisions this role to the proxies when access is delegated to them.

The Delegation Transaction Setup page also enables you to identify the security that the system requires to delegate the transaction. To identify the security, in the Delegation Transaction Setup page, select the component information that delegators must have in their user profiles in order to delegate the transaction.

2. The delegation process is always initiated by the delegator. Delegators can create proxies and delegate transactions to these proxies through the Share My Information self-service component. Each time a delegator creates a new proxy, the delegator must first accept the institution's terms and conditions. Your institution can include their terms and conditions in the delivered Share My Information - Terms and Conditions page. For example, academic institutions in the United States can display their terms and conditions in the Share My Information - Terms and Conditions page to comply with the data privacy regulations under FERPA. Once the terms and conditions are accepted, the delegator enters the name, the relationship and the email address of the proxy to whom he or she wants to delegate access. The delegator then selects the delegation transactions that he or she wants the proxy to view or update. Examples of transactions can include transactions for self-service components such as View My Class Schedule, View My Grades and so on. The delegator can delegate a transaction to one or more proxies. For example, a student can delegate access to the Emergency Contacts transaction to his or her mother and father. Conversely, a proxy can be granted access by multiple delegators (for example, this applies to a case where the parent has more than one child in an academic institution and they all delegate him or her access to their data). The delegator only sees the transaction for which he or she is allowed to delegate.
3. When the delegator identifies a proxy and delegates access to one or more transactions, the system uses the Notifications framework to send a courtesy email notification to the delegator to inform him or her that access to his or her data has been delegated to a certain person and an action email notification is sent to the proxy's email address. Both emails list the transactions that have been delegated. In addition, the email sent to the proxy also includes a security key that the proxy enters at the time of accepting the proxy terms and conditions, and a URL link that the proxy can click to access your Campus Solutions system.
4. If set up to use the New User Registration framework, the URL link is constructed with the information to access your New User Registration login page and a New User Registration Context ID value (configured for Delegated Access framework) that transfers the proxy directly to the Proxy Terms and Conditions page after the proxy successfully signs into the system. On your New User Registration login page, the proxy can either reuse an existing user ID (if the proxy already has one) or create a new one. The New User Registration framework enables the reuse or creation of a user ID. With the New User Registration Context ID value, the New User Registration framework, immediately after successfully registering and authenticating the proxy to your system, knows how to provision the proxy with proper security role to access the Proxy Terms and Conditions page and how to immediately transfer the proxy to this page.
5. On the Terms and Conditions for Accessing Somebody Else's Data page (this page is also known as the Proxy Terms and Conditions page), the proxy is asked to act responsibly with the delegator's data. You can personalize the terms and conditions to fit your institution needs. On this page, the proxy is required to accept or decline the institution's specific terms and conditions, enter the security key given in the received email notification and enter the email address where the email notification was sent. This information is the signature that proves the proxy is the right person wanting to access the delegator's data. In addition, the proxy may be asked to enter some personal information. The proxy must accept the terms and conditions stipulated by the institution before accessing the delegator's data. Once proxy submits the information, validation is in place to make sure the right person is trying to access the delegator's information. The Delegated Access framework links the proxy's user ID with the delegator's EMPLID after the system performs a successful validation. If the proxy accepted the terms and conditions, the framework updates the proxy's user profile with the security roles associated with each of the delegated transactions (Proxy Role Name). If proxy declines, then the system does not perform the role provisioning and proxy cannot access any of the transactions delegated by the delegator.

A proxy can access data only for the delegators who granted the access.

The Delegated Access framework being integrated with CTM framework allows your system to optionally associate an EMPLID with the proxy. At the time of accepting the terms and conditions, if at least one of the transactions delegated to the proxy requires an EMPLID to be associated with the proxy, Delegated Access uses the proxy's personal information entered at the time of accepting or declining the proxy terms and conditions to call the CTM framework and trigger Search/Match.

- Once the proxy has accepted the terms and conditions and the system has validated the information and provisioned the proxy's user profile with roles tied to the delegated transactions, the proxy is prompted to log out and log back in again. Then, the proxy can access the delegated information by navigating to Self Service > Shared Information Center. From there, the list of components that were delegated to the proxy by different delegators is displayed.

This example illustrates a proxy that has been delegated access to three components.

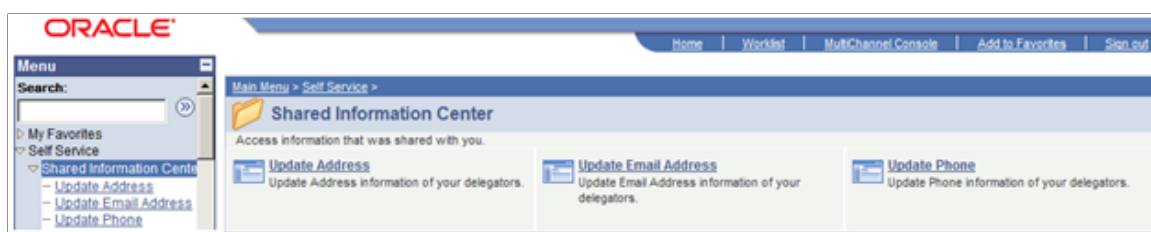

When accessing any of these components, if multiple delegators delegated access to the proxy, then the system displays a search record and returns only the names of the delegators who delegated access to the component. The proxy selects the name of the delegator for whom the proxy wants to review or update the data. The search record is delivered with your system and should override the search record for the self-service components you make available for delegated access.

A delegator revokes proxy access by deselecting one or all of the transactions delegated to a proxy in the Share My Information - Details page. When the delegator revokes proxy access, the Notifications framework sends an email to the proxy that informs the proxy which transactions were revoked. On the other hand, when the delegator adds new transactions for delegation, the Notifications framework sends an email to the proxy and to the delegator to inform them which additional transactions were delegated. When the proxy accepts the terms and conditions for a specific delegator, additional delegations or revoked delegations are automatically provisioned or de-provisioned from the proxy's user profile.

For a proxy to login to your system, you can either use your own login page (where you provide the proxy with a way to create a new User ID) or customize the New User Registration login sample page that comes with the New User Registration framework. Some self-service components configured for delegated access are delivered with the system as samples. The self-service components that are configured for delegated access are known as Delegated Access Components.

An administrative user can review the delegations made by a delegator from the Review Shared Information component. On behalf of the delegator, the administrative user can grant access to more transactions to an existing proxy and can also revoke access to already delegated transactions. The administrative user cannot create a new proxy on behalf of the delegator. Only updates to an existing proxy can be done.

Transactions delegated to a proxy can be manually revoked by a delegator, an administrative user, or by the Proxy Access Validation process. The Proxy Access Validation process ensures that a proxy

still has access to a delegated component. Validation is performed in real time or through a batch process.

Related Links

[New User Registration Framework and Delegated Access](#)

[Using Proxy Access Validation](#)

[Reviewing Delivered Delegation Transactions](#)

[Step 5: Setting Up Components for Delegated Access](#)

[Step 9: Setting Up the URL to Access the New User Registration Login Page](#)

[Using the Review Shared Information Pages](#)

[Using the New User Registration Sample User Interfaces](#)

Notifications Framework and Delegated Access

The system uses the Notifications framework to notify delegators and proxies of newly delegated or revoked transactions through email messages. Within the Delegated Access framework, only email notifications are sent. Delegated Access triggers the notifications from the Share My Information component, the Review Shared Information component, as well as from the Proxy Terms and Conditions page.

<i>The system sends an email notification to the delegator and proxy when:</i>	<i>Type of email notification sent:</i>
The delegator creates a proxy and delegates one or more transactions.	<ul style="list-style-type: none"> • To the Delegator: A courtesy email notification is sent to let the delegator know the list of transactions that were just delegated to a certain person. The delegator is advised to verify his or her account if the delegation was not intentional. The notification is sent using the DA_DELEGATOR_GRANT email template. • To the Proxy: An action email notification is sent to inform the proxy how to sign in to the system and be validated as the proper person trying to access the proper student's information. The notification also lists the transactions that have been delegated. The email message includes a security key that the proxy enters at the time of accepting the proxy terms and conditions, and a link to access your Campus Solutions system. The link (URL) is programmatically included in the email message. The system uses the URL you mark as Active inside the NUR context ID specific to Delegated Access (SCC_NURCTXT_20120918102441). You can use the auto-generated URL constructed based on your own environment information, or a custom URL. The notification is sent using the DA_PROXY_GRANT email template.

The system sends an email notification to the delegator and proxy when:	Type of email notification sent:
The delegator delegates one or more transactions to an existing proxy that has already accepted the terms and conditions and therefore been associated with the delegator (a known proxy).	<ul style="list-style-type: none"> • To the Delegator: A courtesy email is sent. • To the Proxy: An information email notification is sent to inform the known proxy of the new delegated transactions. This time, since the proxy is already associated with the delegator (and therefore has a user ID assigned), the notification only lists the transactions that have been delegated. No security key is sent. The DA_KNOWN_PROXY_GRANT email template.
The administrator delegates one or more transactions to an existing proxy on behalf of the delegators—the proxy has not yet accepted the terms and conditions.	<ul style="list-style-type: none"> • To the Delegator: A courtesy email is sent. • To the Proxy: An action email is sent.
<ul style="list-style-type: none"> • The administrator delegates one or more transactions to an existing proxy on behalf of the delegators—the proxy has accepted the terms and conditions (known proxy). 	<ul style="list-style-type: none"> • To the Delegator: A courtesy email is sent. • To the Proxy: An action email is sent.

The system sends an email notification *only* to the proxy when the:

- Delegator revokes one or more transactions for a proxy or deletes the proxy. In this case, the notification only lists the transactions that have been revoked. (Delivered with your system the notification is sent using the DA_PROXY_REVOKE email template).
- Administrator revokes one or more transactions for a proxy or deletes the proxy. In this case, the notification lists only the transactions that have been revoked. (Delivered with your system the notification is sent using the DA_PROXY_REVOKE email template).
- Proxy declines the terms and conditions. At this stage all the proxy’s delegated transactions for the delegator in question are automatically revoked. The notification lists the transactions that have been revoked. (Delivered with your system the notification is sent using the DA_PROXY_REVOKE email template).
- Administrator resets the security key for a proxy from the Review Shared Information component. The notification contains a new security key along with all the transactions delegated by the delegator. (Delivered with your system the notification is sent using the DA_PROXY_GRANT email template).

In addition, the delegator can use the **Share My Information - Details** self-service page to resend an email notification that was last sent to the proxy. The administrator can also resend an email notification from the **Review Shared Information – Details** page.

Note: The email templates intended to be sent to the proxy and delivered with your system are set up with a custom logic to retrieve the proxy's email address. This logic is delivered with your system and uses the email address entered by the delegator at the time of creating the proxy on the Share My Information - Details page. The custom logic is contained in the application class called SCC_DA:NOTIFICATION:DACustomLogicProvider. The email templates sent to the delegators are set to use the delegator's preferred email address defined in the Email addresses record.

Because Delegated Access is a security feature and sending courtesy email notifications to delegators is part of the business process to avoid security vulnerability, delegators must have an email address stored inside the Email addresses record (EMAIL_ADDRESSES record) in order to delegate any access. The courtesy email generic template (DA_DELEGATOR_GRANT) is setup with a criticality of 'Process Dependant' to enforce this (see the setup of this template in the Delivered Setup for the DA_DELG_EMAIL_ON_GRANT Template section). The process ignores or overrides the fact that delegators have not set their notification preferences and instead use the email address that is marked as Preferred inside the EMAIL_ADDRESSE record.

The email template that contains information on how the proxy can access the delegator's data is also considered 'Process Dependant'.

See [Understanding the Notifications Framework](#)

Reviewing Delivered Notification Templates for Delegated Access

Delivered with your system are four email templates that are used to send email notifications to complete the Delegated Access process flow. Generic templates establish a common format for notifications.

The following table describes the email templates that are delivered with your system, from which page they are triggered, who receives them and sends them, along with information on how the emails are set up and delivered

Template Name	Notification Description	Trigger	Recipients
<p>DA_DELEGATOR_GRANT</p>	<p>The system sends this courtesy email notification to the delegator after access to the delegator’s data has been granted to a proxy.</p> <p>Example:</p> <p>Email Subject: Access to some of your school data has been shared with John Red.</p> <p>Email Message: Dear Steven Pratt, access to your data has been granted to John Red (Neighbor) to perform or review the following transactions:</p> <ul style="list-style-type: none"> • Emergency Contacts • Update Contact Information <p>If you did not authorize this, please sign into your account and make the proper adjustments on the Share My Information page. You are solely responsible for the actions taken on your behalf by the designated person.</p> <p>This is an auto-generated email; please do not respond to this message.</p>	<ul style="list-style-type: none"> • On the Share My Information - Details page, the delegator delegates one or more transactions to a proxy and clicks the Save button. • On the Review Shared Information – Details page, the administrator delegates one or more transactions to a proxy on behalf of the delegator and clicks the Save button. 	<p>Delegator</p>

Template Name	Notification Description	Trigger	Recipients
<p>DA_PROXY_GRANT</p>	<p>The system sends this action email notification to the proxy after access to the delegator’s data has been granted to a proxy. The notification states that the proxy has been delegated access for the first time (the proxy is newly created by the delegator).</p> <p>Provides email security key for validation and a link (URL) for the proxy to access the system.</p> <hr/> <p>Note: The URL is automatically embedded in the email message. The URL that is used is the one marked Active in the NUR context ID specific to Delegated Access (SCC_NURCTXT_20120918102441). You can construct the URL through the New User Registration Installation page or create your own custom URL.</p> <hr/> <p>Example:</p> <p>Email Subject: Access to Steven Pratt's school data has been granted to you.</p> <p>Email Message: John Red, you have been granted access to Steven Pratt's data. You will be able to perform or view the following transactions on Steven's behalf:</p> <ul style="list-style-type: none"> • Emergency Contacts • Update Contact Information <p>Instructions:</p>	<ul style="list-style-type: none"> • On the Share My Information - Details page, the delegator enters a new proxy and delegates one or more transactions or delegate more transactions to a proxy that has not yet accepted the terms and conditions, and clicks the Save button. • On the Review Shared Information – Details page, the administrator presses the Reset Security Key button or delegates one or more transactions to an existing proxy on behalf of the delegators—the proxy has not yet accepted the terms and conditions 	<p>Proxy</p>

Template Name	Notification Description	Trigger	Recipients
	<ol style="list-style-type: none"> 1. Click this link to access our school system. You will be asked to sign in using your existing User ID to access our site. If you don't have one already you will be able to create one. 2. After signing into our system, you will be required to accept or decline the "Terms and conditions for accessing somebody else's data". 3. You will also be required to enter the following two pieces of information: <ol style="list-style-type: none"> a. The following security key: Security Key: 1234567 b. The email address where we sent you this notification. <p>The above steps are only required when it is the first time you register to access Steven Pratt's data.</p> <p>This is an auto-generated email; please do not respond to this message.</p>		

Template Name	Notification Description	Trigger	Recipients
<p>DA_KNOWN_PROXY_GRANT</p>	<p>The system sends an informational email notification to a known proxy after access to the delegator's data has been granted to an existing proxy. The notification states that the proxy has been delegated additional access after having previously accepted terms and conditions and going through proper validation.</p> <p>Example:</p> <p>Email Subject: Access to Steven Pratt's school data has been granted to you.</p> <p>Email Text: John Red, you have been granted access to Steven Pratt's data. You will be able to perform or view the following transactions on Steven Pratt's behalf: View To Do List</p> <p>This is an auto-generated email; please do not respond to this message.</p>	<ul style="list-style-type: none"> • On the Share My Information - Details page, the delegator delegates one or more transactions to an existing proxy and clicks the Save button. • On the Review Shared Information – Details page, the administrator delegates one or more transactions to an existing proxy and clicks the Save button. 	<p>Proxy</p>

<i>Template Name</i>	<i>Notification Description</i>	<i>Trigger</i>	<i>Recipients</i>
DA_PROXY_REVOKE	<p>The system sends an informational revoke email notification to the proxy after a delegated access is revoked. The notification states the list of transactions that have been revoked.</p> <p>Example:</p> <p>Email Text: Jean Taylor, you have been revoked access to Peter Dryfus' data. You will no longer be able to perform or view the following transactions on Peter's behalf: Emergency Contacts</p> <p>If you feel you should still have access to these transactions, please contact Peter Dryfus for inquiry.</p> <p>This is an auto-generated email; please do not respond to this message.</p>	<ul style="list-style-type: none"> • On the Share My Information - Details page, the delegator revokes one or more delegated transactions or deletes the proxy, and clicks the Save button. • On the Review Shared Information – Details page, the administrator revokes one or more delegated transactions or deletes the proxy, and clicks the Save button. • On the Proxy Terms and Conditions page, the proxy declines the terms and conditions. At that time, the delegated transactions are revoked and the email notification is sent. 	Proxy

The email templates can be modified in **PeopleTools > Workflow > Notifications > Generic Templates**.

Each template also requires additional setup to be triggered from the Notifications framework in **Set Up SACR > System Administration > Utilities > Notifications > Notification Setup**.

Delivered Setup for the DA_DELG_EMAIL_ON_GRANT Template

This example illustrates the fields and controls on the Notification Setup page for DA_DELG_EMAIL_ON_GRANT.

Notification Setup

Notification Template ID: SCC_NTF_TMP_20120625083641

***Template Name:**

Status:

Description:

***NotificationType:** **Override Notification Preferences**

***Notification Criticality:**

***Generic Template:** [View Generic Template](#)

Recipients Configuration ?

To

Preferred Email Address

Custom Logic

Static Address

Cc

None

Preferred Email Address

Custom Logic

Static Address

Bcc

None

Preferred Email Address

Custom Logic

In the setup page for DA_DELG_EMAIL_ON_GRANT (generic template DA_DELEGATOR_GRANT), Notification Criticality must be set to Process Dependant. This enforces that if the courtesy email cannot be sent (for example no email address found for the delegator), the delegation process does not go through.

Delivered Setup for the DA_PROXY_EMAIL_ON_GRANT Template

This example illustrates the fields and controls on the Notification Setup page for DA_PROXY_EMAIL_ON_GRANT.

Notification Setup

Notification Template ID: SCC_NTF_TMP_20120625083755

*Template Name:

Status:

Description:

*NotificationType: Override Notification Preferences

*Notification Criticality:

*Generic Template: [View Generic Template](#)

Recipients Configuration

To

Preferred Email Address

Custom Logic

Application Class:

Static Address

Cc

None

Preferred Email Address

Custom Logic

Static Address

Bcc

None

Preferred Email Address

Custom Logic

Static Address

In the setup page for DA_PROXY_EMAIL_ON_GRANT (generic template DA_PROXY_GRANT), Notification Criticality must be set to Process Dependant. This enforces that if the action email cannot be sent, the delegation process will not go through. Custom logic is used to retrieve the proxy's email address. This logic is delivered with your system. It uses the email address the delegator provides when the delegator creates the proxy on the Share My Information – Details page. The custom logic is contained in the application class SCC_DA:NOTIFICATION:DACustomLogicProvider.

Delivered Setup for the DA_KNOWN_PROXY_EMAIL_ON_GRANT Template

This example illustrates the fields and controls on the Notification Setup page for DA_KNOWN_PROXY_EMAIL_ON_GRANT.

Notification Setup

Notification Template ID: SCC_NTF_TMP_20120625083922

*Template Name:

Status:

Description:

*NotificationType: Override Notification Preferences

*Notification Criticality:

*Generic Template: [View Generic Template](#)

Recipients Configuration ?

To

Preferred Email Address

Custom Logic

Application Class:

Static Address

Cc

None

Preferred Email Address

Custom Logic

Static Address

Bcc

None

Preferred Email Address

Custom Logic

Static Address

In the setup page for DA_KNOWN_PROXY_EMAIL_ON_GRANT (generic template DA_KNOWN_PROXY_GRANT), Notification Criticality can be set to Informative (optional). The email informs the existing proxy that new transactions have been delegated to him or her. Custom logic is used to retrieve the proxy's email address. This logic is delivered with your system. It uses the email address the delegator provides when the delegator creates the proxy on the Share My Information – Details page. The custom logic is contained in the application class SCC_DA:NOTIFICATION:DACustomLogicProvider.

Delivered Setup for the DA_PROXY_EMAIL_ON_REVOKE Template

This example illustrates the fields and controls on the Notification Setup page for DA_PROXY_EMAIL_ON_REVOKE.

Notification Setup

Notification Template ID: SCC_NTF_TMP_20120625084012

*Template Name:

Status:

Description:

*NotificationType: Override Notification Preferences

*Notification Criticality:

*Generic Template: [View Generic Template](#)

Recipients Configuration

To

Preferred Email Address

Custom Logic

Application Class:

Static Address

Cc

None

Preferred Email Address

Custom Logic

Static Address

Bcc

None

Preferred Email Address

Custom Logic

Static Address

In the setup page for DA_PROXY_EMAIL_ON_REVOKE (generic template DA_KNOWN_PROXY_GRANT), Notification Criticality can be set to Informative (optional). The email informs the proxy that existing transactions have been revoked. Custom logic is used to retrieve the proxy’s email address. This logic is delivered with your system. It uses the email address the delegator provides when the delegator creates the proxy on the Share My Information – Details page. The custom logic is contained in the application class SCC_DA:NOTIFICATION:DACustomLogicProvider.

Note: The notifications are intended to be short and simple messages with the purpose of informing about a specific subject. The list of variables contained in each of the messages is delivered with your system and require extended coding effort to be modified.

At the time of delivering the Delegated Access framework, only these twenty five variables are available. Adding more variables requires substantial programming effort.

- %1 => delegatorName
- %2 => proxyName
- %3 => relationship
- %4 => Delegated or Revoked Transactions list
- %5 => Delegators Page Name ("Share My Information")
- %6 => URL value
- %7 => security key
- %8 => Nametype
- %9 => Nameinitials
- %10 => Nameprefix
- %11 => Suffix
- %12 => Royalprefix
- %13 => Royalsuffix
- %14 => Title
- %15 => Lastname
- %16 => Firstname
- %17 => Middlename
- %19 => PrefFirstname
- %20 => PartnerLastname
- %21 => PartnerRoyPrefix
- %22 => Display
- %23 => Formal
- %24 => Birthdate
- %25 => Relationship

You cannot change the variable numbers as these are predefined or populated in the Delegated Access app class `SCC_DA.NOTIFICATION.NOTIFY` code.

See [Setting Up and Consuming the Notifications Framework](#)

New User Registration Framework and Delegated Access

The New User Registration framework, when you integrate it with Delegated Access, enables the proxy to register and authenticate to your system and provides an easy way to transfer the proxy directly to the initial page to start the process of viewing or updating somebody else's data. The framework provides a sample New User Registration login page that you can customize and deploy to suit your institution's requirements. A proxy can use this page to sign into the system using an existing user ID or to register for a new user ID. A suggested approach to allow the proxy to access the New User Registration login page (or your own sign in page) is by including a URL in the email notification sent to the proxy when the delegator creates the proxy and delegates some transactions. The URL is used to transfer the proxy to the login page. The URL must be embedded with the location of your login page, New User Registration Gatekeeper information, and optionally, but recommended, the NUR context ID value that is delivered for Delegated Access.

New User Registration Context

After signing into your system, the very first thing a new proxy must do to start reviewing the delegator's data is to accept the terms and conditions, which proves that the proxy will act responsibly with the delegator's data. This is done in the Proxy Terms and Conditions page. Integrating Delegated Access with New User Registration offers a seamless way of automatically provisioning the proxy with the security to access this page and then to transfer the proxy to this page immediately after successfully authenticating to your system. The New User Registration Context functionality allows you to do just that. The delivered New User Registration context ID specific to Delegated Access (SCC_NURCTXT_20120918102441 (NUR_DELEGATED_ACCESS)) must be embedded in the URL the proxies use to access your New User Registration login page. This is also the URL that is programmatically inserted in the email message sent to the proxies. This URL replaces the Access URL variable in the DA_PROXY_GRANT generic email template. The context ID is used in the Delegated Access application class SCC_DA.NOTIFICATION.NOTIFY. There are two types of URL the application class can include in the generic email template: the URL that serves for testing your deployment of Delegated Access with New User Registration (Tester URL), or the URL used for when your deployment of Delegated Access is ready to be in production (Production URL). The application class selects the URL that you mark as Active, and uses it to replace the Access URL variable that is defined in the DA_PROXY_GRANT generic email template.

Note: A known proxy (proxy that has already accepted the terms and conditions for accessing a specific delegator's data and therefore programmatically associated to that delegator), should not see the Proxy Terms and Conditions page again. Therefore, when additional transactions are delegated to a known proxy, a URL could be inserted inside the information email template (DA_KNOWN_PROXY_GRANT) without being embedded with a New User Registration Context ID. In that case the proxy is transferred to your home application page after successfully signing into your system.

The NUR context ID can be set as follows:

This example illustrates a New User Registration Context ID created for Delegated Access where the Production URL is Active.

New User Registration Context

New User Registration Context ID SCC_NURCTXT_20120918102441

New User Registration Context NUR_DELEGATED_ACCESS

Description Proxy to access the DA terms and conditions page

Default:

***Status** Active

***Provisioning Context** Auto Provisioned

Security to Provision			
Role Name	Description	View Definition	
1 CS - DA Proxy TermsCondit	CS - DA Proxy TermsConditions	View Definition	+ -

Target Page

URLID

Or:

Component Name SS_CC_DA_TERMS_CC Ss Cc Da Terms Con

Menu Name: SCC_DA_PROXY Proxy Terms Conditions Menu

Menu Bar Name: USE Use

Item Name: SS_CC_DA_TERMS_CON Proxy Terms and Conditions

Page Name: SS_CC_DA_TERMS_CON Proxy Terms and Conditions Pg

Access Mode Update

***Node Name** <your Default Local Node> PS HRMS - Local Node

Context Specific URL

Tester URL: Active Customize URL

Production URL: Active Customize URL

Comments:

The system adds the Role Name you select to the proxy's user profile just-in-time after the proxy successfully goes through registration and authentication from the New User Registration login page (or your custom version of it). Make sure the selected roles grant access to the page defined in the Target Page group box. In the case of Delegated Access, the target page is the Proxy Terms and Conditions. In the sample screenshot, the defined target page transfers the proxy directly to the Proxy Terms and Conditions. The proxy's first action is to accept or decline the terms and conditions for accessing the data that belongs to someone else. Setting a target page facilitates the user experience for the proxy because the proxy does not need to manually navigate to the target page.

The following sample roles are delivered with your system, which show examples of how you can grant access to the Proxy Terms and Conditions page.

- CS – DA Proxy TermsConditions

This is the Role selected inside the delivered New User Registration Context ID shown above. It grants access to the Proxy Terms and Conditions page without menu navigation (the permission list contained inside the role does not allow a user to navigate to the page). The page can only be accessed after being successfully authenticated by New User Registration. This setup is recommended to avoid having a proxy re-accessing the Proxy Terms and Conditions page by mistake.

- CS – DA Proxy TermsCond_Test

Use this role for testing only. It grants the proxy access to the Proxy Terms and Conditions page, but with menu navigation: Self – Service > Proxy Terms and Conditions. This is not a real implementation option, but you can use this role to help your administrators test the functionality without setting up the New User Registration framework, or your own solution to authenticate a proxy to your system.

The URL that is embedded in the email notification a new proxy receives is the context specific URL you mark as Active. If you want to test the Delegated Access process without setting up a Kiosk or portal environment, set the Tester URL as the active URL. The Tester URL transfers the proxy to the NUR Tester login page. When you are ready to deploy your application, set the Production URL as Active to transfer the proxy to your real login page, which is either the NUR sample login page or your custom version of the page. The Production and Tester URLs that appear on the New User Registration Context Setup page are based on the generic URLs you set up in the New User Registration Installation page, combined with the NUR context ID. If you prefer to manually enter a URL, then on the New User Registration Context Setup page, select Customize URL and make sure you select this URL to be active. This is especially useful if you do not use the NUR framework for your security needs. If you use a customized URL, you do not need to modify the Delegated Access application class (SCC_DA.NOTIFICATION.NOTIFY) because it uses the URL you set as active regardless of whether it is automatically generated or customized.

Note: If the proxy already has a user ID to access the Campus Solutions database (for example, the proxy is an alumnus or an employee at your institution), then the proxy can reuse his or her existing user ID to access the delegator's data. The same is true if multiple delegators delegated access to the same proxy. The proxy can reuse the same user ID to access all of the delegator's data. This meets the security convention that ideally one person has one user ID to access a system. The role provisioning and the target page transfer occur regardless of whether the user ID is newly created or if an existing one was used.

See [Setting Up New User Registration Context](#).

CTM and Delegated Access

Constituent Transaction Management (CTM) framework allows the assignment of an EMPLID while a user is performing a transaction set for CTM. CTM uses the personal data information entered by the user as search data to trigger Search/Match and associate an EMPLID. The process is invisible to the user.

The Delegated Access framework triggers CTM for creating or assigning an EMPLID to the proxy if a delegation transaction requires an EMPLID to be associated with the proxy. This setup decision is

made on the Delegation Transaction Setup page. Delegated Access triggers CTM from the Proxy Terms and Conditions page after the proxy accepts or declines the terms and conditions, enters some personal information, and clicks the Submit button. At that time the SCC_DA_SUBMIT web service operation is triggered and if at least one transaction delegated to the proxy is set up to assign an EMPLID, then CTM triggers Search/Match. The constituent data entered by the proxy is stored in the CTM constituent staging tables.

Assigning an EMPLID to a proxy is an optional setup because within your institution you may have some delegation transactions that require an EMPLID to be assigned to the proxy, whereas some don't. For example, if you configure a delegation transaction to allow a proxy to donate money on behalf of the delegator, you may want to capture as much information as possible from the proxy and create an EMPLID to send further communications. Whereas if you create a delegation transaction to delegate access to the View My Class Schedule component, you may not care about gathering personal information from the proxy or assigning an EMPLID to the proxy.

On the Delegation Transaction Setup page for a specific transaction, if you elect to assign an EMPLID to the proxy you are required to enter a CTM Transaction Code. On the Proxy Terms and Conditions page, the proxy enters personal information. If that transaction was delegated, at submit time CTM triggers and uses the CTM Transaction Code to call Search/Match and assign an EMPLID to the proxy.

Note: CTM is always consumed as part of a transaction and handles constituent and, optionally, transaction data. When CTM is consumed by Delegated Access, only constituent data is involved. Delegated Access framework doesn't involve any transaction data. Once the proxy and delegator relationship is confirmed, any updates made on behalf of a delegator are saved directly in the production tables.

The personal information you capture from proxies at the time they accept or decline the terms and conditions should be sufficient for Search/Match to use as search data. The Search/Match Parameters to use are defined in the CTM Transaction Code that you enter on the Delegation Transaction Setup page.

Related Links

[Configuring Delegation Transactions](#)

[Step 8: Modifying the Proxy Terms and Conditions Page to Include Proper Constituent Fields](#)

[Understanding CTM](#)

Associating a CTM Transaction Code with Delegated Access

Associating a CTM transaction code with a delegated transaction is optional. You can set up a CTM transaction code for each delegation transaction that's defined in the Delegation Transaction Setup page. When the proxy clicks the Submit button on the Proxy Terms and Conditions page, the system determines which CTM transaction code to use by evaluating the setup of each of the delegation transaction codes that was delegated to the proxy. Because only one CTM transaction code can be used to process the proxy's constituent data, the following logic takes place.

If multiple delegation transaction codes exist for the proxy, the Delegated Access framework evaluates the setup for these delegation transaction codes in the following way:

- If one delegation transaction code is set up with Assign EMPLID to Proxy = Y, then its CTM transaction code is used to save the proxy's constituent data in CTM staging records. And then Search/Match is triggered.

- If multiple delegation transaction codes are set up with Assign EMPLID to Proxy = Y, then the first CTM transaction code is used to save the proxy’s constituent data in CTM staging records. And then Search/Match is triggered.

To illustrate this logic, consider this example. A proxy is delegated with the following transactions:

- Transaction 1: Set up with CTM Transaction Code = ‘AAAA’ and Assign EMPLID to Proxy = ‘Y’
- Transaction 2: Set up with CTM Transaction Code = ‘BBBB’ and Assign EMPLID to Proxy = ‘Y’
- Transaction 3: Set up with CTM Transaction Code = <blank> and Assign EMPLID to Proxy = ‘N’
- Transaction 4: Set up with CTM Transaction Code = ‘CCCC’ and Assign EMPLID to Proxy = ‘Y’

Because there are multiple transaction codes with Assign EMPLID to Proxy = Y, the first transaction code that’s encountered is used. In this case, CTM transaction code AAAA is used.

If none of the transactions are set up to assign an EMPLID, then CTM is simply not triggered and none of the personal information entered by the proxy inside the Proxy Terms and Conditions is saved in the CTM staging tables.

Note: You can reuse the same CTM transaction code for your transactions. Use a different value if different Data Update Rule or Search/Match Parameters should be used.

Processing New User Registration and Delegated Access Transactions

If the proxy goes through New User Registration to create a user ID, then the CTM transaction code NEW_USER_REGISTRATION is performed (this transaction code is delivered with your system). Once the proxy has entered constituent data and clicks the Submit button on the Proxy Terms and Conditions page, if a delegated transaction with a CTM transaction code exists, then the CTM Constituent Staging component indicates that a second transaction has been performed.

This example illustrates how the CTM Constituent Staging component looks like when NUR and DA are performed, and an EMPLID must be assigned (that is, Assign Proxy EMPLID = ‘Y’) but an EMPLID does not exist.

Summary Information		Constituent Details		Participation Details		Additional Personal Info		Regional	
Temporary ID:	1611	Name:	Fletcher, Mary						
User ID:	MFLETCHER	Constituent Status:	Suspended						
Created Datetime:	09/13/2012 3:42PM	ID:							
Created By:	MFLETCHER	Run Search/Match/Post							
Related Transactions									
Personalize Find View All First 1 of 1 Last									
Status	Transaction Code	Transaction Name	Status Date	Online	Search/Match Results				
Posted	NEW_USER_REGISTRATION	New User Registration	09/13/2012	<input checked="" type="checkbox"/>	Search/Match Results				
Submitted	DELEGATE_ACCESS	Delegate Access	09/13/2012	<input checked="" type="checkbox"/>	Search/Match Results				

This example illustrates how the Constituent Staging component looks like when NUR and DA are performed, and an EMPLID must be assigned (that is, Assign Proxy EMPLID = 'Y'), then an EMPLID is created.

Summary Information		Constituent Details		Participation Details		Additional Personal Info		Regional	
Temporary ID:	1810	Name:	Fletcher, Mary						
User ID:	MFLETCHER	Constituent Status:	New ID Created						
Created Datetime:	01/10/2012 4:23PM	ID:	1049						
Created By:	MFLETCHER	Post Transaction Data							
Related Transactions									
Personalize Find View All First 1-2 of 2 Last									
Status	Transaction Code	Transaction Name	Status Date	Online	Search/Match Results				
Posted	DELEGATE_ACCESS	Delegate Access	01/10/2012	<input checked="" type="checkbox"/>	Search/Match Results				
Posted	NEW_USER_REGISTRATION	New User Registration	01/10/2012	<input checked="" type="checkbox"/>	Search/Match Results				

This example illustrates how the Constituent Staging component looks like when NUR and DA are performed by creating a user ID, and an EMPLID does not have to be assigned (that is, Assign Proxy EMPLID = 'N') to a delegated transaction.

Summary Information		Constituent Details		Participation Details		Additional Personal Info		Regional	
Temporary ID:	82	Name:	Ro, Juliette						
User ID:	JULIETTE	Constituent Status:	Loaded						
Created Datetime:	11/10/2012 11:47AM	ID:							
Created By:	JULIETTE	Run Search/Match/Post							
Related Transactions									
Personalize Find View All First 1 of 1 Last									
Status	Transaction Code	Transaction Name	Status Date	Online	Search/Match Results				
Posted	NEW_USER_REGISTRATION	New User Registration	11/10/2012	<input checked="" type="checkbox"/>	Search/Match Results				

The CTM Transaction Code NEW_USER_TRANSACTION is performed only when the user creates a user ID through the New User Registration framework. If the user uses an existing user ID, a CTM transaction isn't involved. It is only during user ID creation time that the user may be asked to enter personal information. This information must first be stored in the CTM constituent staging records because an EMPLID doesn't exist for this user.

Related Links

[Understanding New User Registration](#)

(Optional) [Step 4: Setting Up the CTM Transaction for Delegated Access](#)

Entity Registry and Delegated Access

The Delegated Access framework uses the Entity Registry feature for validating and processing the proxy information at the time when the proxy accepts or declines the terms and conditions. The entities associated with Delegated Access are delivered with your system.

The following table lists the delivered Delegated Access entities.

Entity ID	Entity Name	Production Record
SCC_ENTITY_20120419155543	DA Proxy	SCC_DA_PROXY
SCC_ENTITY_20120419155813	DA Proxy Transactions	SCC_DA_PRXY_TXN

Related Links

[Setting Up Entity Registry](#)

Contact and Transaction Statuses

Contact statuses indicate whether the proxy has accepted or declined the terms and conditions for a specific delegator. Delegators can track the statuses on the Share My Information - Summary page, while administrators can track statuses from the Review Shared Information – Summary page. A contact status can be:

- **Unknown** — indicates that it is not known whether the proxy has accepted or declined the terms and conditions page.
- **Accepted** — indicates the proxy has accepted the terms and conditions.
- **Declined** — indicates the proxy has declined the terms and conditions.

Internal transaction statuses enable you to track the progress of each delegation transaction from the time the delegator delegates the transaction to the time the access is revoked. These internal statuses do not appear in self service or any other Campus Solutions pages. Combined with contact statuses, they are used to derive and display the transaction status values. An Internal transaction status can be:

- **Access Granted** — indicates the transaction has been delegated to the proxy.
- **Revoked** — indicates that access to the transaction has been revoked from the proxy.

Transaction statuses enable the delegator to track the progress of each delegation transaction from the time the delegator delegates the transaction to the time the access is revoked. These statuses appear on the Share My Information - Summary self-service page. A transaction status can be:

- **Submitted** — indicates the transaction has been delegated to the proxy, but the proxy has not yet accepted the proxy terms and conditions.
- **Access Granted** — indicates the proxy has accepted the proxy terms and conditions and can now access the delegator’s data.
- **Revoked** — indicates either the proxy has declined the proxy terms and conditions *or* the delegator has revoked the proxy’s access to the transaction.
- **Pending** — indicates the transaction has been delegated to the proxy, but is pending proxy acceptance to the proxy terms and conditions.

The following table describes the transaction statuses associated with the contact statuses that appear on the Share My Information - Summary page, as well as how the statuses are triggered.

Contact Status	Internal Transaction Status	Transaction Status	Trigger
Unknown	Access Granted	Submitted	On the Share My Information - Details page, the delegator creates a new contact (new proxy), adds the contact details, delegates one or more transactions, then clicks the Save button.
Accepted	Access Granted	Access Granted	<ul style="list-style-type: none"> Proxy clicks the I Accept button on the Proxy Terms and Conditions page. Delegator delegates new transactions to a proxy that has already accepted the terms and conditions (a known proxy).
Accepted	Revoked	Revoked	On the Share My Information - Details page, the delegator revokes access to the transaction after the proxy has accepted the terms and conditions, then clicks the Save button.
Unknown	Revoked	Revoked	On the Share My Information - Details page, the delegator revokes access to a transaction before the proxy accepts or declines the terms and conditions, then clicks the Save button .
Declined	Revoked	Revoked	Proxy clicks the I Decline button on the Proxy Terms and Conditions page.
Declined	Access Granted	Pending	On the Share My Information - Details page, the delegator delegates a new transaction to a proxy who has already declined the terms and conditions, and then clicks the Save button .

Note: Transactions that are revoked do not appear on the Share My Information – Summary page. If all the transactions delegated to the same proxy are revoked, this message appears: *No access is currently delegated to this contact.*

Revoking Proxy Access

A proxy's access to a transaction can be manually revoked either by a delegator (Share My Information – Details self-service page), or by an administrator (Review Shared Information – Details page) by simply deselecting a previously delegated transaction. At that moment, the transaction status is set to Ended (or marked in the record as Revoked) and evaluated to determine if the same transaction is also delegated by a different delegator. If that is the case, the logic does not remove the role associated to the revoked transaction from the proxy's user profile—the proxy still needs to have access to the delegated components to access other delegators' data. If no other delegators exist, then the proxy's user profile is automatically updated. At the time of revoking the transaction, the Notifications framework is triggered to notify the proxy via email about the revoked transactions.

A proxy's access to a transaction can also be programmatically revoked by the Proxy Access Validation (PAV) engine.

When a transaction is revoked, a revoke reason is given based on the condition it was revoked. The following table describes the various revoke reasons and how they are assigned.

<i>Revoke Reason Values</i>	<i>Where this value is set</i>	<i>Who or what sets that value</i>	<i>Results</i>
Manual Revoke	<ul style="list-style-type: none"> In the Share My Information – Details component, when the delegator manually deselects a transaction name In the Review Shared Information – Details component, when the administrator manually deselects a transaction name 	<ul style="list-style-type: none"> Delegator Administrator 	<ul style="list-style-type: none"> Transaction status is set to Ended (or marked in the record as Revoked) for the delegator/ proxy relation Email notification is sent to the proxy Proxy's user profile is updated by removing the role tied to the revoked transaction if the proxy's user profile is known and no other delegator delegated the proxy access to the same transaction

Revoke Reason Values	Where this value is set	Who or what sets that value	Results
Proxy Delete	<ul style="list-style-type: none"> In the Share My Information – Summary component, when the delegator manually deletes a proxy In the Review Shared Information – Summary component, when the administrator manually deletes a proxy 	<ul style="list-style-type: none"> Delegator Administrator 	<ul style="list-style-type: none"> Transaction status for all delegated transaction is set to Ended (or marked in the record as Revoked) for the delegator/proxy relation Email notification is sent to the proxy Proxy’s user profile is updated by removing the role tied to the revoked transaction if the proxy’s user profile is known and no other delegator delegated the proxy access to the same transaction
Declined Terms and Conditions	In the Proxy Terms and Conditions component when the Proxy declines the terms and conditions	Proxy	<ul style="list-style-type: none"> Transaction status for all delegated transaction is set to Ended (or marked in the record as Revoked) for the delegator/proxy relation Email notification is sent to the proxy
Security	<p>When the revoke proxy access option selected for the transaction is “Delegator no longer has access to delegate the transaction.” The following validation occurs:</p> <ul style="list-style-type: none"> When the delegator accesses the Share My Information – Summary component. When the administrator accesses the Review Shared Information – Summary component When the proxy accesses a delegated component and activates the component search record 	PAV real-time logic	<ul style="list-style-type: none"> Transaction status for all delegated transaction is set to Ended (or marked in the record as Revoked) for the delegator/proxy relation Transaction record (SCC_DA_PRXY_TXN) is flagged to be picked up later by the PAV batch process

Revoke Reason Values	Where this value is set	Who or what sets that value	Results
	<p>The Proxy Access Validation batch process runs.</p>	<p>PAV batch process</p>	<ul style="list-style-type: none"> • Transaction status is set to Ended (or marked in the record as Revoked) for the delegator/ proxy relation • Email notification is sent to the proxy • Proxy’s user profile is updated by removing the role tied to the revoked transaction if the proxy’s user profile is known and no other delegator delegated the proxy access to the same transaction
<p>Inactive Transaction</p>	<p>When the revoke proxy access option selected for the transaction is “Transaction Inactivated.” The validation occurs:</p> <ul style="list-style-type: none"> • When the delegator accesses the Share My Information – Summary component. • When the administrator accesses the Review Shared Information – Summary component • When the proxy accesses a delegated component and activates the component search record 	<p>PAV real-time logic</p>	<ul style="list-style-type: none"> • Transaction status for all delegated transaction is set to Ended (or marked in the record as Revoked) for the delegator/proxy relation • Transaction record (SCC_DA_PRXY_TXN) is flagged to be picked up later by the PAV batch process

<i>Revoke Reason Values</i>	<i>Where this value is set</i>	<i>Who or what sets that value</i>	<i>Results</i>
	The Proxy Access Validation batch process runs.	PAV batch process	<ul style="list-style-type: none"> Transaction status is set to Ended (or marked in the record as Revoked) for the delegator/ proxy relation Email notification is sent to the proxy Proxy's user profile is updated by removing the role tied to the revoked transaction if the proxy's user profile is known and no other delegator delegated the proxy access to the same transaction

Note: The revoke reason value can be seen only by an administrator in the Review Shared Information component. The delegator does not see the revoked transactions in the Share My Information component.

Related Links

[Understanding Proxy Access Validation](#)

Delegated Access Validation

The validation process runs when the proxy clicks the **I Accept** or **I Decline** button on the Proxy Terms and Conditions page, enters the security key and email address, and, optionally, some personal information, then clicks the Submit button. The validation process contains the criteria to make sure the right person is trying to access the delegator's data. This is needed because at the time of delegating access, the delegator and the system have no technical knowledge about the proxy. Both do not know the proxy's user ID or whether an EMPLID exists for the proxy. All they know is the proxy's name, email address, and relationship with the delegator.

Using the security key and the email address entered by the proxy on the Proxy Terms and Conditions page, the validation process associates the proxy (proxy's user ID) with the delegator (delegator's EMPLID). This is possible because the security key is unique for the delegator-proxy combination. Once the validation is successful, and if the proxy has accepted the terms and conditions, the system updates the proxy's user profile by provisioning the security roles associated with the delegated transactions. If the proxy declined the terms and conditions, provisioning is not performed and the delegated transactions are automatically revoked.

If at least one of the delegated transactions is set up with the Assign EMPLID to Proxy option selected, the system uses the first corresponding CTM transaction code encountered to trigger Search/Match, and an EMPLID is assigned to the proxy.

The proxy validation process is performed only once per proxy-delegator combination. If a proxy is already registered and has been validated and tied to a specific delegator, the proxy does not go through this validation again. This validation logic is performed as part of the SCC_DA web service. The SCC_DA web service contains the SCC_DA_SUBMIT (Delegate Access Submit) service operation.

Related Links

[CTM and Delegated Access](#)

Using Proxy Access Validation

This section discusses how to:

- Validate a proxy access in real time.
- Validate a proxy access using a batch process.

Understanding Proxy Access Validation

The Proxy Access Validation (PAV) logic evaluates different conditions that determine whether a proxy should have access to a delegated component. The conditions are defined for each of the delegation transactions in the Delegation Transaction Setup component.

The PAV engine uses any one of the following conditions to determine whether to revoke a proxy's access:

- *Never*. Proxies will never have their access to the transaction revoked.
- Transaction status is set to *Inactive*.
- Delegator no longer has the security access to delegate the transaction.

If any one of the above conditions is met, the PAV logic revokes the proxy access to the transaction. It sets the transaction status to Ended (or marked in the record as Revoked) and provide a reason that depends on which condition is met. The process could also result in the removal of the security role tied to the transaction from the proxy's user profile. Removing the security access from the proxy's user profile depends if another delegator has delegated the same transaction to the proxy. In that case the proxy's user profile is not updated because the proxy must continue to have access to the components to access other delegators' data. For example, Mary is the mother of Jane and Luke. Both are students in your institution and they both delegated access their mother to their View My Class Schedule component. If this transaction is set to revoke the proxy access if the delegator no longer has access to delegate the transaction and Jane lost her access to a component needed to delegate the View My Class Schedule transaction, then Mary sees her access to that transaction being revoked for Jane, but still granted for Luke. In this case PAV does not delete the role tied to the View My Class Schedule transaction from Mary's user profile. Mary still needs to keep her access to view Luke's data.

For information on how to set up a transaction with various revoke conditions, see [Configuring Delegation Transactions](#).

To make sure the proxy has the proper access to the delegated transactions at all times, the PAV engine is triggered two different ways:

- Real-time processing occurs just in time, at the time a delegated access actor (a proxy, a delegator or an administrator) accesses a component configured for PAV. Running the process in real time ensures that proxies can only access what they are allowed to access, and that delegators and administrators see an accurate picture of the delegated transactions. There is no need to wait for the batch process to run. It also ensures that if the batch process fails or was not scheduled, the security check is enforced.
- Batch processing allows the PAV engine to validate multiple transactions, delegators and proxy relationships at the same time. Proxy access validation is performed ahead of time. The batch process is an application engine process called SCC_DA_PAV and can be triggered from **Campus Community > Delegated Access > Proxy Access Validation**. It uses the same validation logic used in real-time processing. In addition, during a batch process extended database updates and notification framework calls are executed. For example, roles can be added to or removed from proxy user profiles, and email notifications are sent.

Real Time Proxy Access Validation

In real-time processing, the PAV engine validates whether a proxy should still have access to a component at the time the:

- Proxy accesses a delegated component. The PAV engine evaluates if the proxy has the security necessary to access the desired component. The PAV is triggered from the delegated component generic search record SCC_DA_SRCH_VW. For information on how to use SCC_DA_SRCH_VW, see [Step 5: Setting Up Components for Delegated Access](#).

The search record triggers the PAV engine and retrieves the user ID of the proxy that is logged in as well as the transaction code that is related to the component that the proxy is trying to access. The transaction code that is retrieved helps the process evaluate whether the revoke conditions for the transaction are met, and then returns in the search record only the names of the delegators for which the proxy still has access.

For example, Mary is the mother of Jane and Luke. Both are students in your institution and they both granted their mother access to their Emergency Contacts component. If this transaction is set to revoke the proxy access if the delegator no longer has access to delegate the transaction and Jane does not have access to a component needed to delegate this transaction, then the PAV real-time logic revokes Mary's access to Jane's data, that is, Mary is not able to access Jane's data. The search record to access the Emergency Contacts component returns only the name of Luke.

Another example would be if the Emergency Contacts transaction is set up to revoke proxy access when the transaction is made inactive. Let's pretend that this transaction has been inactivated and Mary attempts to access it. Mary navigates to the component and through the search record. The PAV process is triggered and evaluates the situation, and then revokes Mary's access to the component for all the delegators. Mary sees a search record to access the Emergency Contacts component, but it returns 'No matching values were found'. Mary is not able to access any of her delegators since she lost access because the transaction has been set to 'Inactive'.

- Delegator accesses the Share My Information component. The PAV engine evaluates all the proxies created by the delegator to determine whether any of the proxies meet any one of the revoke conditions selected in the transaction codes they have been delegated. The PAV engine is triggered from the SS_CC_DA_SHAREINFO component. The Share My Information – Summary page displays only the proxies that have current access to the delegated transactions.
- Administrator accesses the Review Shared Information component. The PAV engine evaluates all the proxies created by the selected delegator to determine whether or not any of the proxies meet any one of the revoke conditions selected in the transaction codes they have been delegated. The PAV is

triggered from the SCC_DA_ADMIN component. The Review Shared Information – Summary page only displays the proxies that have current access to the delegated transactions.

When the PAV engine determines that a proxy's access should be revoked from a certain transaction, it performs the following updates on the database:

- The transaction status is changed from 'Access Granted' (AG) to 'Revoked' (RV). This value is stored in SCC_DA_PRXY_TXN.SCC_DA_TXN_STATUS record field.
- The Revoke Reason field is populated with the reason based on why the access was revoked.
- The transaction record is flagged so that it can be picked up by the PAV batch process, and the Notifications framework can send an email notification to the proxy and its user profile can be properly updated. In the SCC_DA_PRXY_TXN record, the SCC_DA_RLTM_UPD field is set to 'Y'.

When PAV is processed in real time, an email notification is not sent to the proxy and the proxy's user profile is not updated. Instead, these actions are performed later by the PAV batch process.

Batch Proxy Access Validation

Instead of waiting for a proxy, a delegator, or an administrator to access a component, use the PAV batch process to evaluate multiple transactions, or delegator and proxy relationships to validate a proxy's access to a transaction.

When the PAV process determines that a proxy's access should be revoked from a certain transaction, it performs the following updates on the database.

- The transaction status is changed from 'Access Granted' (AG) to 'Revoked' (RV). This value is stored in SCC_DA_PRXY_TXN.SCC_DA_TXN_STATUS.
- The Revoke Reason field is populated with the reason based on why the access was revoked.
- The Notifications framework is triggered to send an email notification to the proxy to inform him about revoked transactions. The DA_PROXY_REVOKE generic template is used.
- If no other delegator gives the proxy access to the same transaction code, the proxy's user profile is updated by removing the security role tied to the transaction code to which the proxy no longer has access.
- If a transaction record was flagged by the PAV real-time process (the field SCC_DA_RLTM_UPD is set to 'Y' in the SCC_DA_PRXY_TXN record), the PAV batch process completes the full validation process by triggering the Notifications framework to send an email notification to the proxy to let him know about the revoked transactions. The batch process also determines if the proxy's user profile should be de-provisioned from the role listed in the delegated transaction. Once terminated, the PAV batch logic sets the SCC_DA_RLTM_UPD field to 'N' so the transaction is not processed the next time the batch process is run.

Related Links

[Revoking Proxy Access](#)

[Using the Review Shared Information Pages](#)

Page Used to Validate Proxy Access

<i>Page Name</i>	<i>Definition Name</i>	<i>Navigation</i>	<i>Usage</i>
Proxy Access Validation	SCC_DA_PAV_RUN_CNT	Campus Community > Delegated Access > Proxy Access Validation	Use a batch process to validate multiple transactions, delegator and proxy relationships in order to revoke access to delegated transactions.

Validating Proxy Access in Real Time

The Proxy Access Validation process validates proxy access in real time when the:

- Proxy accesses a delegated component.
- Delegator accesses the Share My Information component.
- Administrator accesses the Review Shared Information component.

Related Links

[Understanding Proxy Access Validation](#)

Validating Proxy Access in Batch

Access the Proxy Access Validation page (**Campus Community > Delegated Access > Proxy Access Validation**).

This example illustrates the fields and controls on the Proxy Access Validation page. You can find definitions for the fields and controls later on this page.

Proxy Access Validation

Run Control ID: PAV [Report Manager](#) [Process Monitor](#)

Delegator IDs or Transactions Selection

Selection: Delegator ID: Shin-Lin Yan

All Transaction Codes Specific Transaction Codes

Delegated Transaction Selection [Personalize](#) | [Find](#) | First 1 of 1 Last

	Transaction Code	Transaction Name	Transaction Status	
1	SCC_DA_TXN_201206250	View Holds	Active	<input type="button" value="+"/> <input type="button" value="-"/>

Revoke Proxy Access Options

Override Transaction Settings

Transaction Inactivated [Help](#)

Delegator no longer has access to delegate the transaction [Help](#)

The batch process evaluates whether the Transaction Status is set to 'Access Granted'. It also evaluates the transactions that are flagged as Real-time Updates by the PAV real-time process. This is when the SCC_DA_RLTM_UPD field is set to 'Y' in the SCC_DA_PRXY_TXN record.

When you run the batch process against a delegator or specific transactions, the PAV process evaluates only the transactions for the selected delegator or specified transaction codes. This means that transactions that have been updated during PAV real-time processing but do not belong to the selected delegator or transaction codes are not processed.

Delegator IDs or Transactions Selection

Use this group box to select the transactions or delegator EMPLIDs to process.

Field or Control	Description
Selection	<p>Select:</p> <ul style="list-style-type: none"> • <i>All Transactions</i> to process all transaction codes for all delegator EMPLIDs that delegated transactions. When selected, the All Transaction Codes check box is automatically selected and greyed-out. You are then not able to specify a specific transaction code. • <i>All Delegates</i> to process all delegators. When selected, you can specify to process any of the following: <ul style="list-style-type: none"> • All Transaction Codes, the result of which is similar to selecting ‘All Transactions’. • Specific Transaction Codes • <i>Specific Transactions</i> to process only particular transaction codes. When you select this option, the Specific Transaction Codes check box is selected and greyed-out, and the Delegated Transaction Selection grid appears so you can select which transaction codes you want to evaluate. • <i>One Delegator</i> to process a particular delegator. When you select this option, the Delegator ID field appears. Also, you must select whether all transaction codes or specific transaction codes should be processed for the delegator you choose.
Delegator ID	<p>Select a delegator ID for which to run the batch process. The field prompt only returns EMPLIDs for existing delegators.</p> <p>This field appears only when you select One Delegator from the Selection list.</p>
All Transaction Codes or Specific Transaction Codes	<p>Select to run the batch process for one or specific transaction codes. When one option is selected, the other one is disabled. When you select Specific Transaction Codes, the Delegated Transaction Selection grid appears.</p>

Delegated Transaction Selection

Use this grid to add one or more transaction codes for which to run the batch process.

Revoke Proxy Access Options

Use this group box to override the transaction settings that you set up in the Delegation Transaction setup page.

Note: The option ‘Never’ is not applicable for PAV when run in batch.

Configuring Delegation Transactions

This section discusses how to:

- Configure delegation transactions.
- Review delivered delegation transactions.

Note: Before you configure the Delegation Transaction Setup page, you need to identify the components you want to be available for delegation, create the menus, set up the appropriate permission lists, roles, and, optionally, CTM Transaction Code. Only a security administrator who is familiar with the Campus Solutions self-services components, PeopleSoft security, and how you manage your security must set up Delegated Access.

Related Links

[Step 5: Setting Up Components for Delegated Access](#)

Pages Used to Configure Delegation Transactions

<i>Page Name</i>	<i>Definition Name</i>	<i>Navigation</i>	<i>Usage</i>
Counter Setup	SCC_AWS_FIX_CTRS	Set Up SACR > System Administration > Utilities > Transaction Mgmt > System Administration > Counter Setup	Set up the max ID number for the constituted proxy ID. Proxy ID is created when a delegator delegates access to a new contact in the Share My Information component. This value is used programmatically and not visible in pages.
Delegation Transaction Setup	SCC_DA_SETUP	Set Up SACR > System Administration > Utilities > Delegated Access > Delegation Transaction Setup	Configure transactions for delegated

Related Links

[Setting Up Counter](#)

Configuring Delegation Transactions

Access the Delegation Transaction Setup page (**Set Up SACR > System Administration > Utilities > Delegated Access > Delegation Transaction Setup**).

This example illustrates the fields and controls on the Delegation Transaction Setup page. You can find definitions for the fields and controls later on this page.

Delegation Transaction Setup

Transaction Code: SCC_DA_TXN_20120625080659

Transaction Name:

Transaction Status:

Description:

Display Description to Delegator Reset Security Required

Delegated Access Security

*Proxy Role Name:

Assign EMPLID to Proxy?

CTM Transaction Code:

Proxy Role Name Definition Personalize | Find | View All | First 1-4 of 5 | Last

Component Name	Page Name	Menu Name	Menu Bar Name	Menu Item Name
1 SS_CC_EMERG_CNTCT	SSS_DEL_CONFIRM	SCC_DA_SS_EMRCNCT	EMERGENCY_CONTACT	SS_CC_EMERG_CNTCT
2 SS_CC_EMERG_CNTCT	SSS_SAVE_CONFIRM	SCC_DA_SS_EMRCNCT	EMERGENCY_CONTACT	SS_CC_EMERG_CNTCT
3 SS_CC_EMERG_CNTCT	SS_CC_EMERG_CNTCT_D	SCC_DA_SS_EMRCNCT	EMERGENCY_CONTACT	SS_CC_EMERG_CNTCT
4 SS_CC_EMERG_CNTCT	SS_CC_EMERG_CNTCT_L	SCC_DA_SS_EMRCNCT	EMERGENCY_CONTACT	SS_CC_EMERG_CNTCT

Security Required To Delegate This Transaction Find | View All | First 1-4 of 5 | Last

Component Name	Page Name	Action Mode	Display Only Allowed?	Menu Name	Menu Bar Name	Menu Item Name
1 SS_CC_EMERG_CNTCT	SSS_DEL_CONFIRM	U	<input type="checkbox"/>	CC_PORTFOLIO	TASKS	SS_EMERGENCY_CNTCT
2 SS_CC_EMERG_CNTCT	SSS_SAVE_CONFIRM	U	<input type="checkbox"/>	CC_PORTFOLIO	TASKS	SS_EMERGENCY_CNTCT
3 SS_CC_EMERG_CNTCT	SS_CC_EMERG_CNTCT_D	U	<input type="checkbox"/>	CC_PORTFOLIO	TASKS	SS_EMERGENCY_CNTCT
4 SS_CC_EMERG_CNTCT	SS_CC_EMERG_CNTCT_L	U	<input type="checkbox"/>	CC_PORTFOLIO	TASKS	SS_EMERGENCY_CNTCT

Revoke Proxy Access Options

Never [Help](#)

Transaction Inactivated [Help](#)

Delegator no longer has access to delegate the transaction [Help](#)

Field or Control	Description
Transaction Code	<p>Displays the auto-generated unique ID.</p> <p>When you add a new delegation transaction, this field displays the value NOID until you save the record. When you save the new delegation transaction, the field displays a unique ID that the system assigned to the delegation transaction.</p>
Transaction Name	<p>Enter the name of the transaction. This name appears on the Share My Information - Details self-service page where delegators can select the transaction names they want to delegate.</p> <p>It is strongly recommended that you always assign a meaningful transaction name because the self-service users see it.</p>

Field or Control	Description
Transaction Status	<p>Activate or inactivate the delegation transaction. When inactivated, the transaction name is no longer displayed in the Share My Information - Details self-service page even if delegators have access to delegate it.</p> <hr/> <p>Note: If you deactivate a transaction, consider revoking the access of proxies who have been delegated access to the transaction. To do so, in the Revoke Proxy Access Options group box, select Transaction Inactivated. The next time a proxy attempts to access a component included in the inactivated transaction, the Proxy Access Validation real-time logic automatically revokes the proxy access. You can also revoke proxy access by batch using the Proxy Access Validation process.</p>
Description and Display Description to Delegator	<p>Enter a description of the components that the transaction contains or for which purpose it is used.</p> <p>Select the Display Description to Delegator check box to display this description on the Share My Information - Details self-service page where delegators can select the transaction to delegate.</p>
Reset Security Required	<p>Click to reset the information entered in the Security Required To Delegate This Transaction grid. The fields in this grid are populated by default using the information defined in the Proxy Role Name you select.</p>

Delegated Access Security

Use this group box to establish security access for proxies who are delegated access to the given transaction and decide if an EMPLID should be assigned to the proxy.

Field or Control	Description
Proxy Role Name	<p>This field prompts for roles set up in the Roles component.</p> <p>Select the security role that is provisioned to the proxy's user profile once the proxy has accepted the terms and conditions for accessing a delegator's data. The selected role must contain security information that is only relevant for the transaction.</p> <p>For example, if the transaction is to delegate access to a single component like the Emergency Contacts component, the role must include only a permission list that contains the Emergency Contacts component. You can quickly validate all the components included in the role by expanding the Proxy Role Name Definition collapsible grid.</p> <p>If instead you create a transaction that should grant access to multiple components like Update Contact Information, the role you select must include the collection of components to which access should be granted as part of this transaction. For example, the role could grant access to the Email Addresses, Phones, Addresses, Languages, Names components.</p> <p>When a proxy's delegated access is revoked, (assuming the proxy has accepted the terms and conditions and therefore has been identified), the system deletes this role from the proxy's user profile, then the proxy no longer has access to the transaction component. However, if there are other delegators that delegated the proxy access to the same transaction, the role is not deleted since the proxy still needs it to access the other delegators' data.</p>
Assign EMPLID to Proxy	<p>Select if you want the CTM framework to assign an EMPLID to the proxy. When selected, you must enter a CTM Transaction Code.</p> <p>See CTM and Delegated Access.</p>
CTM Transaction Code	<p>Specify the CTM transaction code that the system should use to store the proxy's constituent data.</p> <p>If the Assign EMPLID to Proxy check box is selected, the system uses the CTM transaction code to trigger Search/Match and assign an EMPLID to the proxy.</p>

Proxy Role Name Definition

When you select the Proxy Role Name value, this grid automatically displays the components, associated pages, and menus included in the selected role. This information is to show you what the proxy is granted access to after being delegated access to the transaction. Use this grid to confirm that the right role is selected for the transaction you are creating.

Security Required To Delegate This Transaction

Note: If you do not fill out this grid, then security is not required to delegate the transaction. *All* users can delegate it.

By default, when you select the Proxy Role Name value, the system automatically populates this grid with the components, associated pages, and menus included in the selected role.

You can edit the fields in this grid. A delegator's user profile must have access to all the components, pages, action modes and menus listed in this grid to be eligible to delegate the transaction, and see the transaction name on the Share My Information - Details page. What you define here is basically who has access to delegate this transaction. In most cases the delegator must have access to the same components and page names listed in the proxy role. However, the menus or the action modes may differ. For example, a student that has access to the Names self-service component in display-only mode should not be able to delegate access to the Names self-service component in update display mode. If the student doesn't have access to update some data, the parents should also not have access to update the data.

Because all the components that are available for delegation must be added to a Delegated Access menu beforehand, the delegator will not have access to that menu. For example, the screen shot above shows that the Emergency Contacts component was added to the SCC_DA_SS_EMRCNCT menu in the proxy role name. The delegator (the student) will not have access to this menu. Instead he or she will have access to the CC_PORTFOLIO menu.

You can also use this grid if your institution has created a "parent version" of a student self-service component. For example, if you created a parent version of the View My Class Schedule component, the student will not have access to it. The student will have access to the student version. In this case make sure the proxy role contains the parent version of the component, and then in the Security Required To Delegate This Transaction grid, select the component name and other information for the student version.

Setting up the required security to delegate a transaction requires strong knowledge of the PeopleTools security management (Roles, Permission List, Menus, Components, Pages, and Action Modes). It also requires a good understanding of how your system's security is configured.

Field or Control	Description
Component Name	Enter the name of the components to which the delegator should have security access so that transactions can be delegated.
Page Name	Enter the name of the associated pages to which the delegator should have security access so that transactions can be delegated.

<i>Field or Control</i>	<i>Description</i>
Action Mode	<p>Enter the action mode in which you want to check for delegator security access. The action mode is considered while checking if the delegator has security access to the page with the same action mode. If the delegator does not have security access to the page with the specified action mode, the transaction cannot be delegated.</p> <p>When action modes are given in a permission list, the selected values are applied to all pages in the same component.</p>

Field or Control	Description
Display Only Allowed	<p>Select this check box to allow a delegator who has display-only access to pages to be able to delegate the transaction. This check box prevents a delegator from granting a proxy access to update data when the delegator only has display-only access to pages.</p> <p>Within PeopleTools security, a permission list contains pages. For each page, you can decide whether or not a user should have access to the page in display-only mode. This means that you specify whether a user is allowed to only view a page, or view <i>and</i> update a page.</p> <p>Suppose the Proxy Role Name you select contains permission lists that grant access to pages that only display information (the sample transaction View Contact Information illustrates this). In most cases you would want to allow delegators with display-only and any other modes to delegate this transaction. So then you would select the Display Only Allowed check box because even users who have display-only access should be allowed to delegate this transaction. However, if the Proxy Role Name contains permission lists that grant access to pages where information can be viewed <i>and</i> updated (the sample transactions Update Contact Information and Emergency Contacts illustrate this), you would probably <i>not</i> want to allow delegators with display-only access to be able to delegate the transaction. So then, you would not select the Display Only Allow check box.</p> <p>To further illustrate this behavior, a student with a display-only access mode to the Names self-service component should not be able to delegate access to the Names self-service component in update or display mode. In most cases, if the student doesn't have access to update some pages, the parents should also not have access to update the data.</p> <p>It is recommended that for Proxy Role Names that grant access to pages in update mode (that is, in the permission list, the Display Only flag for the page name is not selected), then delegators display-only access mode should not be allowed to delegate access to the page or transaction. This means you should <i>not</i> select the Display Only Allowed check box. Otherwise, for pages that only display data (that is, the values cannot be updated or selected on the page), you should allow delegators to be able to delegate the page.</p> <p>For more information on how permission lists are created and how pages are marked as display-only, see the product documentation for PeopleTools.</p>

Field or Control	Description
Menu Name, Menu Bar Name, and Menu Item Name	Enter or select the name of the menus to which a delegator should have access in order to delegate the transaction.

Revoke Proxy Access Options

The **Revoke Proxy Access Options** group box allows an institution to decide which conditions to use to revoke a proxy's access at the transaction level. This is used by the Proxy Access Validation real time and batch logic.

Field or Control	Description
Never	<p>By default, this check box is deselected. If you select this option, the other options are disabled.</p> <p>When selected, the Proxy Access Validation logic never revokes the proxy's access to the transaction. Use this option for transactions containing components that are generic or do not grant access to sensitive data.</p> <hr/> <p>Note: When you select this check box and the delegator loses security access to the transaction, the proxy continues to have access to the transaction. The delegator is not able to revoke proxy access. Only an administrator can revoke access to the transaction through the Review Shared Information component.</p>
Transaction Inactivated	<p>By default, this check box is selected. This option indicates that when the transaction status is set to Inactive, the proxies would no longer have access to it.</p> <p>Delegators and administrators are unable to delegate a transaction that is inactive. Inactive transactions do not appear in the Share My Information – Details and Review Shared Information – Details components. When this option is selected, proxies with previous access to the transaction will have their access revoked.</p> <hr/> <p>Note: When a transaction is set to Inactive, this does not immediately revoke a proxy's access to the transaction. Proxy access is revoked at the time the Proxy Access Validation process is run (real time or by batch).</p>

Field or Control	Description
Delegator no longer has access to delegate the transaction	<p>By default, this check box is selected. In most cases, when a delegator loses access to a transaction, the proxy should also lose access to it. This ensures that the delegator controls what a proxy has access to.</p> <p>For example, a student has delegated his parent access to his Addresses information. If the student loses access to the Addresses component and this option is selected, his parent is also not able to access the Addresses information.</p>

Reviewing Delivered Delegation Transactions

Campus Solutions provides several transactions that are pre-configured for the Delegated Access framework and accessible through the Delegation Transaction Setup page. The transactions serve only as samples and their status is set to *Inactive*.

Note: The sample transactions are configured using the delivered self-service components. These components were originally intended to be used by the person to whom the data belongs. You may want to modify these components or create a proxy version so that they make better sense for a proxy.

Transaction Name / Transaction Code	Delegation Transaction Description	Unique Role / Permission List	Component Name	Unique Menu Name / Search Record Override
View Contact Information SCC_DA_TXN_20120626014905	Delegate the ability to view your phone numbers, email addresses and addresses	CS - DA Contact Info View / HCCPCSSA1140: CS - DA Contact Info View Pages included in the permission list are defined with Display Only = Y. That way the proxy is only able to view the delegator's data.	<ul style="list-style-type: none"> • SS_CC_PERS_PHONE • SS_CC_EMAIL_ADDR • SS_CC_ADDRESSES <p>This sample shows that a collection of components can be delegated as part of a same transaction.</p>	SCC_DA_ADDR_VW / SCC_DA_SRCH_VW

Transaction Name / Transaction Code	Delegation Transaction Description	Unique Role / Permission List	Component Name	Unique Menu Name / Search Record Override
Update Contact Information SCC_DA_TXN_20120625080419 This transaction is similar to the 'View Contact Information' transaction and contains the same collection of components. However, it is set up to allow proxies to update the contact information.	Delegate the ability to update your phone numbers, email addresses and addresses	CS - DA Contact Info Update / HCCPCSSA1141: CS - DA Contact Info Update Pages included in the permission list are defined with Display Only = Y. That way the proxy is only able to view the delegator's data.	<ul style="list-style-type: none"> SS_CC_PERS_PHONE SS_CC_EMAIL_ADDR SS_CC_ADDRESSES <p>This sample shows that a collection of components can be delegated as part of a same transaction.</p>	SCC_DA_SS_ADDRESS / SCC_DA_SRCH_VW
Emergency Contacts SCC_DA_TXN_20120625080659	Delegate the ability to view and update your emergency contacts	CS - DA Emergency Contacts / HCCPCSSA1150: CS - DA Emergency Contacts	SS_CC_EMERG_CNTCT	SCC_DA_SS_EMRCNCT / SCC_DA_SRCH_VW
View To Do List SCC_DA_TXN_20120625080459	Delegate the ability to view the pending items on your to do list generated by the institution	CS - DA To Do List / HCCPCSSA1160: CS - DA To Do List	SS_CC_TODOS	SCC_DA_SS_TODO / SCC_DA_SRCH_VW
View Holds SCC_DA_TXN_20120625080559	Delegate the ability to view the holds placed on your record for specific services	CS - DA Holds / HCCPCSSA1170: CS - DA Holds	SS_CC_HOLDS	SCC_DA_SS_HOLDS / SCC_DA_SRCH_VW

Using the Review Shared Information Pages

This section describes how to:

- Use the Review Shared Information – Summary page
- Use the Review Shared Information – Details page

Pages Used to Access the Review Shared Information Pages

<i>Page Name</i>	<i>Definition Name</i>	<i>Navigation</i>	<i>Usage</i>
Review Shared Information – Summary	SCC_DA_RVIEW_SUMM	Campus Community > Delegated Access > Review Shared Information	Use to view delegation information such as proxy information, delegated transactions, and transaction status. Administrators can also use this page to delete a proxy on behalf of a delegator.
Review Shared Information – Details	SCC_DA_RVIEW_DTL	Click the Edit button on the Review Shared Information – Summary page.	Use this page to view or update proxy information. Administrators can also use this page to grant or revoke the proxy access to delegation transactions.

Using the Review Shared Information – Summary Page

Access the Review Shared Information – Summary page (**Campus Community > Delegated Access > Review Shared Information**).

This example illustrates the fields and controls on the Review Shared Information — Summary page. You can find definitions for the fields and controls later on this page.

Review Shared Information - Summary

Marie Fletcher
0068

▼ John Fletcher

Edit
Delete

Contact Information			
Contact Name	Contact Email Address	Relationship	Contact Status
John Fletcher	jffletcher@yahoo.com	Father	Accepted

Shared Transactions		
Shared Access	Start Date	Transaction Status
Update Contact Information	15/04/2013	Access Granted
Emergency Contacts	15/04/2013	Access Granted

▼ Susan Smith

Edit
Delete

Contact Information			
Contact Name	Contact Email Address	Relationship	Contact Status
Susan Smith	ssmith@yahoo.com	Mother	Unknown

Shared Transactions		
Shared Access	Start Date	Transaction Status
View Holds	15/04/2013	Submitted
Emergency Contacts	15/04/2013	Submitted

Use the Summary page to view the same delegation information a delegator sees in the Share My Information – Summary page.

From this page, administrators can:

- View proxy information for all proxies with delegated access to a delegator’s data
- View the current transactions that are delegated to each proxy
- View the transaction status
- Delete a proxy on behalf of the delegator

The administrative component does not allow an administrator to create a new proxy on behalf of the delegator. This page allows administrators to only update information on existing proxies. When administrators access this component, the PAV process runs in real time to determine whether a proxy should have access to delegated components. This gives an accurate picture of who has access to what.

Note: Exercise caution when you grant security access to the Review Shared Information component. Because the component allows a user to grant a third party (a proxy) security access to someone’s data (a delegator), it may violate your data privacy rules. Consider granting security access to the component in display-only to your regular administrators, and in full edit to your administrative super users.

Field or Control	Description
Edit	Click to access the Review Shared Information – Details page. From this page, you can execute more actions on behalf of a delegator.
Delete	Click to delete the proxy on behalf of the delegator. When you do so, all the transactions delegated to the proxy are automatically revoked, and the proxy does not appear on the Summary page. The Notifications framework is triggered and an email message is sent to the proxy to inform the proxy about the revoked access. If the proxy’s user ID is known and no other delegator gave the proxy access to the security role tied to the revoked transaction, the proxy’s user profile is removed from the security role. Note: This button is disabled when the administrator has display-only security access to this component.

Using the Review Shared Information – Details Page

Click the **Edit** button in the Review Shared Information – Summary page.

This example illustrates the fields and controls on the Review Shared Information – Details page. You can find definitions for the fields and controls later on this page.

Review Shared Information - Details

Marie Fletcher 0068

Proxy Details

*Contact Name: Susan Smith Terms and Conditions Status: Unknown
 *Relationship: Mother Terms and Conditions Reviewed Date:
 *Contact Email Address: ssmith@yahoo.com Proxy User ID:
 Proxy Emplid:

Resend Email Notification
 Reset Security Key

Current Delegation Status

Transaction Name	Description	Start Date	Transaction Status	Last Updated By
<input checked="" type="checkbox"/> Emergency Contacts	Delegate the ability to view and update your emergency contacts.	15/04/2013	Submitted	MFLETCHER
<input type="checkbox"/> Update Contact Information	Delegate the ability to update your phone numbers, email addresses and addresses.			
<input type="checkbox"/> View Contact Information	Delegate the ability to view your phone numbers, email addresses and addresses.			
<input checked="" type="checkbox"/> View Holds	Delegate the ability to view the holds placed on your record for specific services.	15/04/2013	Submitted	MFLETCHER
<input type="checkbox"/> View To Do List	Delegate the ability to view the pending items on your to do list generated by the institution.			

Past Delegation Status

Transaction Name	Description	Start Date	End Date	Transaction Status	Revoke Reason	Last Updated By
<input type="checkbox"/> View To Do List	Delegate the ability to view the pending items on your to do list generated by the institution.	15/04/2013	15/04/2013	Ended	Manual Revoke	PS

Clear All Select All
 Save Cancel

Proxy Details

Administrators use this page to view and update the proxy’s information. The contact email address listed is the email address used to send notifications to the proxy when transactions are granted or revoked. If necessary, the delegator could change this information using the Share My Information – Details page,

but it can also be done by an administrator. This group box also gives the administrator information on whether the proxy has accepted the terms and conditions to access the delegator's data. The values are 'Unknown' (proxy has not accepted or declined the terms and conditions), 'Accepted' or 'Declined'. Once accepted or declined, the Terms and Conditions Reviewed Date is populated with the date the proxy has accepted or declined the terms and conditions. The Proxy User ID field is populated only once the proxy has accepted or declined the terms and conditions. Only at that time is the proxy associated with the delegator's EMPLID. The Proxy EMPLID field is populated only after the proxy has accepted or declined the terms and conditions and at least one of the delegated transactions was set up to assign an EMPLID to the proxy. If not, the field remains blank.

Field or Control	Description
Resend Email Notification	Click to resend the last email notification sent to either the proxy or delegator.
Reset Security Key	Click to reset the security key for the proxy. Use this to reset the security key that was generated when the proxy was created. If the proxy is unable to accept the Terms and Conditions because of a security key error, you can generate a new security key.
Clear All and Select All	Deselects or selects all transactions in the Current Delegation Status and Past Delegation Status grids.

Current Delegation Status

This group box is dynamic and displays only the transactions that a delegator has access to. On behalf of the delegator, the administrator can delegate new transactions to an existing proxy and revoke access to certain transactions. To delegate or revoke transactions, select or deselect the appropriate check box for the transaction.

The grid displays the Transaction Status as well as who made the latest update.

Note: The administrator can only delegate transactions that a delegator has access to. This is why the grid limits the list of transactions. Who has access to delegate a transaction is defined in the Delegation Transaction Setup page (Security Required to Delegate this Transaction group box).

Past Delegation Status

This group box displays the transactions that a proxy previously had access to. In most cases the transactions listed in the grid are disabled and have a Transaction Status of Ended (or Revoked in the record). The Revoke Reason field is populated with proper information. This is the only place where the Revoke Reason is displayed

The grid also displays the transactions for which the delegator no longer has access to delegate, but for which the proxy still has access. This happens when a transaction was set with the option to never revoke the proxy access and the delegator later lost security access to it. If a proxy had access to a transaction set up in that manner, the grid displays the transaction with the check box selected, and allows the

administrator to revoke it. The delegator, because he or she no longer has access to that transaction, does not see it in the Share My Information self-service component, and is unable to manually revoke the proxy's access to it. In this case, only an administrator can revoke the proxy's access.

When an administrator uses the Details page to:

- Change the email address, the **Confirm Email Address** field is enabled. The administrator must also provide the new email address in the Confirm Email Address field.
- Revoke the proxy's access to a delegated transaction, a warning message appears and asks if the administrator wants to revoke access to the delegated transaction. If the administrator clicks OK, the Notifications framework is triggered and an email notification is sent to the proxy about the change (the DA_PROXY_REVOKE template is used).
- Delegate a transaction on behalf of the delegator, a warning message appears and asks if the administrator wants to delegate access to the transaction. If the administrator clicks OK, the Notifications framework is triggered, and email notifications are sent to the delegator and proxy about the change (the DA_DELEGATOR_GRANT or the DA_KNOWN_PROXY_GRANT templates are used).

Related Links

[Delegated Access Validation](#)

[Revoking Proxy Access](#)

Developer Reference for Setting Up Delegated Access

This section describes how to use the Delegated Access framework to create your own delegation transactions.

Note: Some steps to configure Delegated Access require a technical effort and require knowledge of Application Designer, web services, Integration Broker, Entity Registry and how you manage user security access at your institution.

This section discusses:

- [Step 1: Setting Up Counter for Proxy ID](#)
- [Step 2: Defining the Delegator's Terms and Conditions Message Catalog](#)
- [Step 3: Defining the Proxy's Terms and Conditions Message Catalog](#)
- [\(Optional\) Step 4: Setting Up the CTM Transaction for Delegated Access](#)
- [Step 5: Setting Up Components for Delegated Access](#)
- [Step 6: Setting Up Permission Lists and Roles for the Delegated Access Components](#)
- [Step 7: Setting Up Delegation Transactions](#)
- [Step 8: Modifying the Proxy Terms and Conditions Page to Include Proper Constituent Fields](#)
- [Step 9: Setting Up the URL to Access the New User Registration Login Page](#)

- [Step 10: Setting Up New User Registration Framework or Required Proxy Security](#)
- [Step 11: Modifying the Delegated Access Notification Templates](#)
- [Step 12: Activating the SCC_DA Web Service](#)
- [Step 13: Verifying the Existence of the Request Handler](#)

Step 1: Setting Up Counter for Proxy ID

The Delegated Access framework assigns a unique proxy ID number (which is not EMPLID or user ID) every time a delegator creates a new proxy (new contact) in the Share My Information component. To view the latest proxy ID assigned or to enter the next proxy ID that you want the system to assign when the system automatically generates proxy IDs, use the Counter Setup page (Set Up SACR, System Administration, Utilities, Counter Setup). The proxy ID value is only used for processing purposes and is never displayed.

Related Links

[Understanding CTM](#)

Step 2: Defining the Delegator's Terms and Conditions Message Catalog

The delegator's terms and conditions are displayed on the Share My Information -Terms and Conditions page (SS_CC_DA_DELEG_AGR page). Modify the message catalog number **14025, 60** to display your institution-specific terms and conditions. Each time a delegator creates a new proxy, the delegator must first accept the institution's terms and conditions. For example, academic institutions in the United States can display their terms and conditions on this page to comply with the data privacy regulations under FERPA.

Step 3: Defining the Proxy's Terms and Conditions Message Catalog

The proxy's terms and conditions are displayed on the Proxy Terms and Conditions page. Modify the message catalog number **14025, 1** to display your institution's terms and conditions that you want the proxy to accept prior to viewing the delegator's data.

(Optional) Step 4: Setting Up the CTM Transaction for Delegated Access

Access the Transaction Setup page (**Set Up SACR > System Administration > Utilities > Constituent Transaction Mgmt > Transaction Setup**).

This example illustrates the fields and controls on the Sample Transaction Setup Page for Delegated Access. You can find definitions for the fields and controls later on this page.

Transaction Setup		Search/Match Setup	
Transaction:	DELEGATE_ACCESS		
*Transaction Name:	<input type="text" value="Delegated Access"/>		
Transaction Description:	<input type="text" value="Generic CTM transaction used by Delegated Access framework to assign an EMPLID to the proxies."/>		
*Transaction Status:	<input type="text" value="Active"/>		
*Data Update Rule:	<input type="text" value="DEFAULT_UPDATE_RULE"/>		
Transaction Options			
<input checked="" type="checkbox"/> Online Transaction	Process Search/Match:	<input type="radio"/> Batch	<input type="checkbox"/> Run on Save
		<input checked="" type="radio"/> Realtime	
Transaction Handler			
*Root Package ID:	<input type="text" value="SCC_CTM"/>		
*Path:	<input type="text" value="TRANSACTION"/>		
*Application Class ID:	<input type="text" value="DefaultTransaction"/>		
Transaction Status and Date			
*Staged Record Name:	<input type="text" value="SCC_DFLT_TRANS"/> Default Transaction Status rec		
Constituent Handler			
*Root Package ID:	<input type="text" value="SCC_SL_TRANSACTION"/>		
*Path:	<input type="text" value="INTFC"/>		
*Application Class ID:	<input type="text" value="DefaultConstituent"/>		
Partition Data			
<input checked="" type="radio"/> By Constituent	<input type="radio"/> By Transaction		
Transaction Data Launch View			
Menu Name:	<input type="text"/>		
Menu Bar Name:	<input type="text"/>		
Menu Item Name:	<input type="text"/>		
Menu Page Name:	<input type="text"/>		

Each delegation transaction you create can be associated with a CTM Transaction Code. Consider reusing the same CTM Transaction Code. Generally, you will want to use different values only if a delegation transaction code requires a different Search/Match configuration, or if you want to use a different Data Update Rule configuration. It is recommended that you associate a delegation transaction with a CTM Transaction Code *only* if you want to assign an EMPLID to the proxy.

The following setup is recommended for configuring a CTM transaction for delegated access:

Transaction Options

<i>Field or Control</i>	<i>Description</i>
Online Transaction	Select this check box because the Delegated Access business process is performed through self-service pages.
Process Search/Match	Select: <ul style="list-style-type: none"> • <i>Batch</i> if you want to assign EMPLIDs at a later time and process many proxy data at once • <i>Realtime</i> if you want to process the proxy data immediately after the proxy submits the Proxy Terms and Conditions page. In this case, deselect the Run on Save check box because Delegated Access only supports triggering CTM on Submit (proxy can only submit the Proxy Terms and Conditions page).

Transaction Handler

<i>Field or Control</i>	<i>Description</i>
Root Package ID	Select <i>SCC_CTM</i> .
Path	Select <i>TRANSACTION</i> .
Application Class ID	Select <i>DefaultTransaction</i> .
Staged Record Name	Select <i>SCC_DFLT_TRANS</i> .

The *SCC_CTM.TRANSACTION.DefaultTransaction* class allows for the processing of CTM transactions that use only constituent data and do not use any transaction-specific data. Delegated Access does not involve any transaction-specific data.

Constituent Handler

<i>Field or Control</i>	<i>Description</i>
Root Package ID	Select <i>SCC_SL_TRANSACTION</i> .
Path	Select <i>INTFC</i> .
Application Class ID	Select <i>DefaultConstituent</i> .

Partition Data

<i>Field or Control</i>	<i>Description</i>
By Constituent	Select this option. The Delegated Access framework does not use transaction data.

Transaction Data Launch Parameters

The fields in this region should be left blank because there is no transaction-specific data with delegated access and therefore there is no transaction staging component for the administrative user.

Note: Set the Search/Match Setup page using the configuration of your choice.

Step 5: Setting Up Components for Delegated Access

To enable a Campus Solutions component for delegated access:

1. Determine which components should be enabled for delegated access.

Evaluate your self-service components and identify the ones you would like a proxy to look at or be able to update on behalf of the delegator (for example, the delegator can be a student).

2. Determine if a proxy version of these components should be created. If so, these proxy components should be used in the subsequent steps.

The delivered Campus Solutions self-service components are intended to be used by the person who owns the data. For example, the self-service page where a user can enter email addresses displays: “Enter your email addresses below”. If a proxy accesses this page, the text might be confusing because it is not the proxy’s email addresses that should be entered, but the delegator’s email addresses. In this case you may want to consider creating a “proxy” version of this self-service component. The same is true if you want to hide some information. For example, it might make sense to display some information to a student, but maybe not to a proxy.

3. Create a menu (DA Menu) for each of the components you would like to delegate to a proxy. A menu can include one or more components related to a specific transaction.

The menu you create is used to override the original component search record, and also to make the security to delegate more granular. Each menu can later be added to a single permission list.

You can create one menu for one component. For example, delivered with your system is a sample delegated transaction called Emergency Contacts. It only contains the emergency contacts self-service component called SS_CC_EMERG_CNTCT. This component is added to a new menu named SCC_DA_SS_EMRCNCT.

You can also create one menu for multiple components. For example, delivered with your system is a sample delegated transaction called Update Contact Information. It contains the email address self-service component (SS_CC_EMAIL_ADDR), the phone self-service component (SS_CC_PERS_PHONE) and the addresses self-service component (SS_CC_ADDRESSES). These components were added to a new menu named SCC_DA_SS_ADDRESS.

4. Create a menu search record override.

If you make a delivered Campus Solutions self-service component available for Delegated Access, the search record must be overridden. In fact, the component search record only returns the EMPLID for the person that is signed into your system (again, Campus Solutions self-service components display the information of the person that is logged in your system). When a proxy accesses one of these components, the search record should return the list of delegators that granted access to the component and for which the delegation status is Access Granted (not Revoked).

Delivered with your system is a search record called SCC_DA_SRCH_VW. This search record should be added to the menus you created for the components that you want to delegate. This search record overrides the component search record.

This example illustrates using SCC_DA_SRCH_VW to override the search record for SCC_DA_SS_ADDRESS menu. You can find definitions for the fields and controls later on this page.

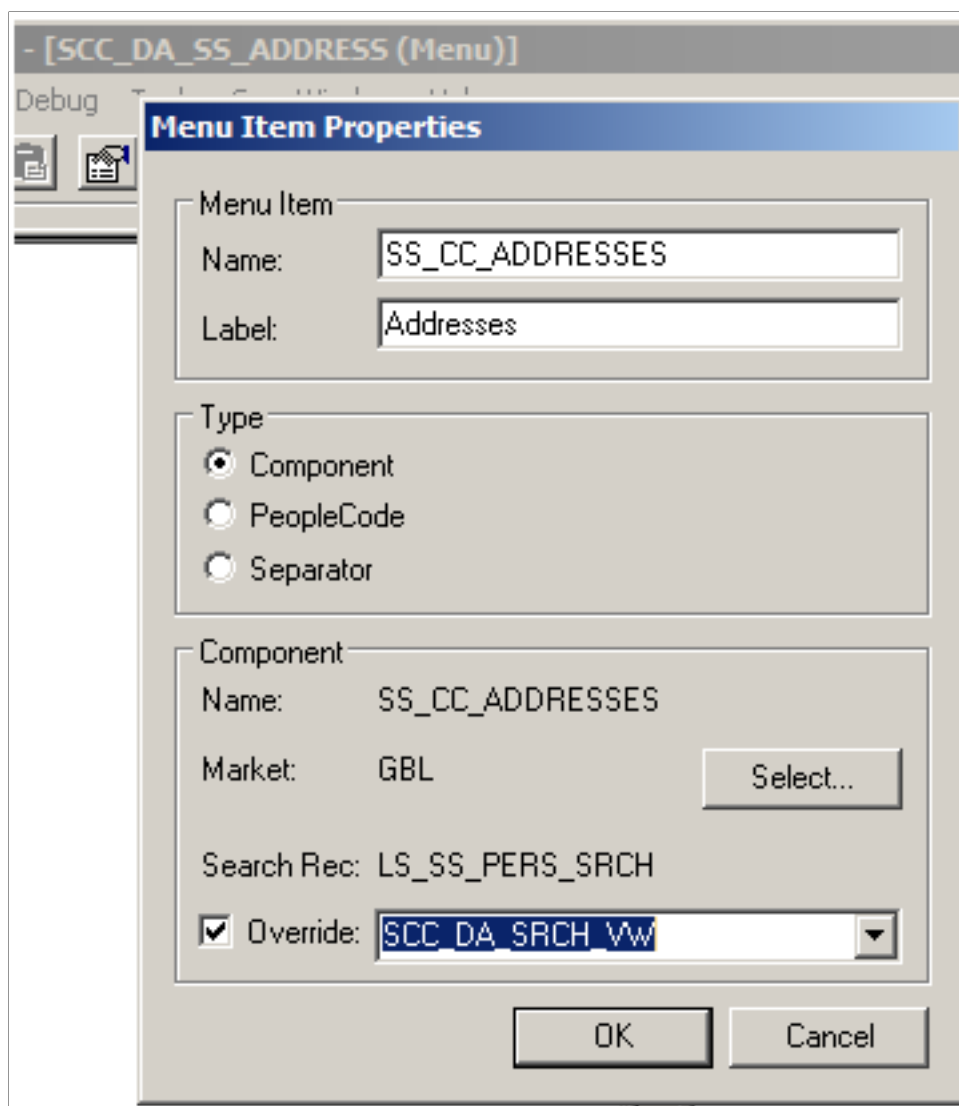

When a proxy accesses one of the components that have been delegated, only the delegator names are returned. For example, Joe, Jane, and Jack are siblings attending the same school. Joe and Jane granted their mother Mary Smith access to their Emergency Contacts data. Jack granted his mother access to a different component. When the mother accepts the terms and conditions for each of her

three kids, her user ID is tied to Joe, Jane and Jack’s EMPLIDs. When she navigates to the Emergency Contacts component (through the DA Menus), she sees a search record that returns only the names of her kids who granted her access to the component: Joe and Jane. Jack’s name is not listed because he did not grant his mother access to that component. Because we are using a DA Menu, if Mary was also a student at the institution, she wouldn’t see her own Emergency Contacts data from that navigation. To see her own data she must navigate to the regular Self Service, Campus Personal Information, Emergency Contacts component.

Note: The search record SCC_DA_SRCH_VW returns only the delegator’s name. The system does not return the EMPLIDs to avoid giving unnecessary information to the proxy. If you created a proxy version of a student self-service component, the search record SCC_DA_SRCH_VW can be added directly to the component you created.

For information on how to create a menu, see *PeopleTools: Application Designer Developer's Guide*.

5. Create a content reference to access the menu through the portal navigation.

To create content references, go to **PeopleTools > Portal > Structure and Content**.

Each of the DA menu and component combinations that you created must be added to its own content reference. For example, the SCC_DA_SS_ADDRESS menu (along with its three components) was added to the “Update Address”, “Update Email Address” and “Update Phone” content references. The following table represents the sample components delivered with your system and how they were added into a specific content reference.

Content Reference Name	Content Reference Label	Menu Name	Component Name
HC_SCC_DA_ADDRESS_UPDATE	Update Address	SCC_DA_SS_ADDRESS	SS_CC_ADDRESSES
HC_SCC_DA_EMAIL_UPDATE	Update Email Address	SCC_DA_SS_ADDRESS	SS_CC_EMAIL_ADDR
HC_SCC_DA_PHONE_UPDATE	Update Phone	SCC_DA_SS_ADDRESS	SS_CC_PERS_PHONE
HC_SCC_DA_ADDR_VIEW	View Address	SCC_DA_ADDR_VW	SS_CC_ADDRESSES
HC_SCC_DA_EMAIL_VIEW	View Email Addresses	SCC_DA_ADDR_VW	SS_CC_EMAIL_ADDR
HC_SCC_DA_VIEW_PHONE	View Phone	SCC_DA_ADDR_VW	SS_CC_PERS_PHONE
HC_SCC_DA_HOLDS	Holds	SCC_DA_SS_HOLDS	SS_CC_HOLDS
HC_SC_DA_TODO	To Do List	SCC_DA_SS_TO_DO	SS_CC_TODOS

Content Reference Name	Content Reference Label	Menu Name	Component Name
HC_SCC_DA_EMERG_CNTCT	Emergency Contact	SCC_DA_SS_EMRCNCT	SS_CC_EMERG_CNTCT

It is recommended that for each content reference you create for Delegated Access, you should add it to the Self Service, Shared Information Center portal folder. This becomes the navigation the proxy uses to see all of the components that were delegated. This also limits the number of places a proxy needs to navigate to access somebody else’s data.

This illustrates an Example of Content References in the Share Information Center Portal.

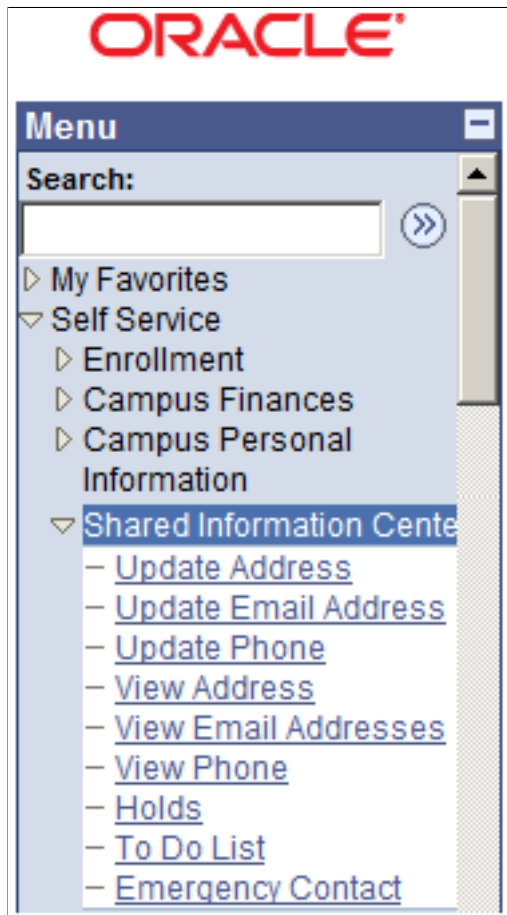

This table shows an existing student self-service component, Emergency Contacts.

Component	Component Search Record	Menu	Menu Search Record Override	Portal folder	Content Reference
SS_CC_EMERG_CNTCT	LS_SS_PERS_SRCH	CC_PORTFOLIO	N. A.	Self Service, Campus Personal Information	Emergency Contacts

This table shows how the student self-service component, Emergency Contacts, is enabled for delegated access

Component	Component Search Record	Menu	Menu Search Record Override	Portal folder	Content Reference
SS_CC_EMERG_CNTCT	LS_SS_PERS_SRCH	SCC_DA_SS_EMRCNCT	SCC_DA_SRCH_VW	Self Service, Shared Information Center	Emergency Contacts

For more information, see *PeopleTools: Portal Technology*.

Step 6: Setting Up Permission Lists and Roles for the Delegated Access Components

Use PeopleTools security components to create a permission list that contains the DA menu . To keep the security granular in order to delegate access to a specific subject at a time, consider creating one permission list per DA menu. For example, if you look at the permission list CS - DA Contact Info Update, it contains only one DA menu (SCC_DA_SS_ADDRESS). This menu grants access to several components: Addresses, Email Addresses and Phone.

After creating the permission list, you should add the permission list to a role. Again, use PeopleTools security components to create a role that includes the permission list. The role becomes the Proxy Role Name, which you use when you create the delegation transactions. It is the role that is assigned to the proxy so the proxy can perform the transaction.

The following information illustrates the permission lists and role names that contain the sample components delivered in your system.

Role Name	Permission List	Menu Name	Component Name
CS - DA Contact Info Update	HCCPCSSA1141	SCC_DA_SS_ADDRESS	SS_CC_ADDRESSES
		SCC_DA_SS_ADDRESS	SS_CC_EMAIL_ADDR
		SCC_DA_SS_ADDRESS	SS_CC_PERS_PHONE
CS - DA Contact Info View	HCCPCSSA1140	SCC_DA_ADDR_VW	SS_CC_ADDRESSES
		SCC_DA_ADDR_VW	SS_CC_EMAIL_ADDR
		SCC_DA_ADDR_VW	SS_CC_PERS_PHONE
CS - DA Emergency Contacts	HCCPCSSA1150	SCC_DA_SS_EMRCNCT	SS_CC_EMERG_CNTCT
CS - DA Holds	HCCPCSSA1170	SCC_DA_SS_HOLDS	SS_CC_HOLDS

Role Name	Permission List	Menu Name	Component Name
CS - DA To Do List	HCCPCSSA1160	SCC_DA_SS_TO_DO	SS_CC_TODOS

For information on creating roles and permission lists, see *PeopleTools: Security Administration*.

Granting access to the SCC_DA_AUTH_CHECK service operation

For each permission list that grants access to a DA menu, make sure it also grants access to the SCC_DA_AUTH_CHECK service operation. This web service is used by the Proxy Access Validation process when the proxy accesses a delegated component (PAV is triggered in realtime from the search record).

Note: If you do not grant access to the SCC_DA_AUTH_CHECK service operation, self-service users and administrators are not able to access the Share My Information component and Review Shared Information component, respectively.

This example illustrates how to Set Up SCC_DA_AUTH_CHK Service Operation in Permission Lists.

Web Service Permissions

Service: **SCC_DA**

Permission	Access
SCC_DA_AUTH_CHK	Full Access
SCC_DA_SUBMIT	No Access

1. Edit the permission list by going to **PeopleTools > Security > Permission Lists**. For example: HCCPCSSA1141.
2. Add the web service SCC_DA:
 - a. Click *Edit*.
 - b. For the SCC_DA_AUTH_CHK service operation, select *Full Access*.
3. Make sure the required security for SCC_DA_AUTH_CHK is granted from the permission list you use to grant delegators access to the Share My Information component, and also from the permission list you use to grant administrators access to the Review Shared Information component. This is necessary because the PAV process is also triggered in real-time when users access these components.

Granting access to the SCC_DA_SUBMIT service operation

Granting access to the SCC_DA_SUBMIT service operation is only needed in the permission list used to grant a proxy access to the Proxy Terms and Conditions page (HCCPCSSA1182 - CS - DA Proxy Terms&Conditions and HCCPCSSA1180 - CS - DA Proxy Terms&Cond_TEST). Access to this service is needed so the proxy can submit the information.

For information on:

- Using the SCC_DA_SUBMIT service operation, see [Delegated Access Validation](#).
- Using the permission lists with the corresponding roles in New User Registration, see [New User Registration Framework and Delegated Access](#).

Step 7: Setting Up Delegation Transactions

Use the Delegation Transaction Setup page to define a transaction and tie the role you created. This is the page where you identify the components, menu, and modes the delegator should have access to in order to delegate the transaction. A transaction can be tied to one or multiple components. For instance, you can create a transaction that only delegates access to the self-service Emergency Contacts component, or a transaction that delegates access to all the self-service personal information components at once. For examples, see the Update Contact Information and View Contact Information sample transactions.

The following is a representation of how the sample Delegated Access Transaction Codes delivered with your system were assigned a single role granting access sometimes to a collection of components, or to a single component.

<i>DA Transaction Code</i>	<i>DA Transaction Name</i>	<i>Role Name</i>	<i>Component Name</i>
SCC_DA_TXN_ 20120625080419	Update Contact Information	CS - DA Contact Info Update	SS_CC_ADDRESSES SS_CC_EMAIL_ADDR SS_CC_PERS_PHONE
SCC_DA_TXN_ 20120626014905	View Contact Information	CS - DA Contact Info View	SS_CC_ADDRESSES SS_CC_EMAIL_ADDR SS_CC_PERS_PHONE
SCC_DA_TXN_ 20120625080659	Emergency Contacts	CS - DA Emergency Contacts	SS_CC_EMERG_CNTCT
SCC_DA_TXN_ 20120625080559	View Holds	CS - DA Holds	SS_CC_HOLDS
SCC_DA_TXN_ 20120625080459	View To Do List	CS - DA To Do List	SS_CC_TODOS

Related Links

[Configuring Delegation Transactions](#)

Step 8: Modifying the Proxy Terms and Conditions Page to Include Proper Constituent Fields

Review the Proxy Terms and Conditions self-service page and consider modifying the fields in the ‘Your Personal Information’ page (SCC_DA_PERINFO_SBP). This page is delivered as a sample. Include the desired constituent fields that you need to capture personal information about the proxy. If your delegation transactions are set to create an EMPLID for the proxies, make sure you gather enough information so Search/Match can use them as search data to identify or create an EMPLID.

The constituent fields that you can include in this page must be part of the Constituent entity or part of any of its children entities (for example, Names, Email Address, Citizenship, and so on). But you need to extend the SCC_DA:UTILS:DAUtils App Class methods to capture the data from new fields on this page.

It is recommended that you do *not* modify the delivered SCC_DA_PERINFO_SBP page. Instead clone it, then rename it.

This example illustrates the fields and controls on the Proxy Terms and Conditions Page.

Terms and Conditions for accessing somebody else's data

Terms and Conditions

You have been granted access to view or update data that belongs to somebody else. By accepting these terms and conditions, you consent to protect the privacy of the data and to use or modify the data fairly and lawfully.

The following terminology applies to these Terms and Conditions: "Delegator" refers to the person who delegated you access. "Proxy" refers to you, the person authorized to view or update the Delegator's data on his or her behalf.

Agreement:
 All proxies are required to sign this agreement for each of the delegators that delegated them access to their data confirming their understanding and acceptance of this policy. You sign the agreement by accepting the terms and conditions, entering your Security Key and your email address.

If you have any questions regarding these terms and conditions please contact the Help Desk at 1-800-333-7777.

I accept terms and conditions
 I decline terms and conditions

Security Key (Security Key was included inside the email notification you received)

Contact Email (Email address where email notification was sent to you)

Your Personal Information

First Name: Middle Name:

Last Name:

Gender:

Date of Birth:

National ID:

Mailing Address

Country:

Address Line 1:

Address Line 2:

Address Line 3:

City: State: Postal:

County:

Step 9: Setting Up the URL to Access the New User Registration Login Page

The proxy receives the URL to access the New User Registration login page through an email notification, which is sent using the generic template DA_PROXY_GRANT. Use the New User Registration Installation page to let the system construct the generic URL for you. In the New User Registration Installation page, you enter your system information in order to populate the NUR constants. The constants use all the security utilities that are delivered with the NUR framework. After you enter your system information, the New User Installation page lets you generate these generic URLs:

- Tester URL, which is used to transfer the guest user to the NUR Tester page.
- Production URL, which is used to transfer the guest user to the NUR sample login page, or your custom version of the page. This is the login page you use in your production environment.

Use the New User Registration Context page to create a URL specific to Delegated Access that ensures the guest user (proxy) is immediately transferred to the Proxy Terms and Conditions page after being successfully authenticated into your system. The NUR context ID, SCC_NURCTXT_20120918102441 (NUR_DELEGATED_ACCESS), is available in your system. The New User Registration Context page constructs the URL by combining the generic URL and the NUR context ID SCC_NURCTXT_20120918102441. The NUR context ID value is referenced in the Delegated Access application class SCC_DA.NOTIFICATION.NOTIFY. The DA application class uses the URL marked as Active in the New User Registration Context page to replace the Access URL variable that is defined in the DA_PROXY_GRANT email template. If you want to test the Delegated Access process without setting up a Kiosk or portal environment, set the Tester URL as the active URL. The active URL transfers the proxy to the NUR Tester login page. When you are ready to deploy your application, set the Production URL as Active to transfer the proxy to your real login page, which is either the NUR sample login page or your custom version of the page.

If you prefer to manually enter a URL, then on the New User Registration Context page, select Customize URL and make sure you set this URL as active. This is especially useful if you do not use the NUR framework for your security needs. If you use a custom URL, you do not need to modify the Delegated Access application class (SCC_DA.NOTIFICATION.NOTIFY) because it uses the URL you set as active regardless of whether it is automatically generated or customized.

Note: The auto-generated URLs use the New User Registration framework security utilities such as switchUser, autologger and gatekeeper. If you customize the URL, you are unable to use those utilities.

Related Links

[Setting Up New User Registration Context](#)

[Step 7: Creating a URL to Access the New User Registration Login page](#)

Step 10: Setting Up New User Registration Framework or Required Proxy Security

In step 9, the URL you created transfers the proxy to the New User Registration login page or a custom version of it. Make sure the proxy can sign into your system by either allowing the proxy to create a new user ID or reuse an existing user ID. If the proxy already has a user ID, he or she should not have to create a new one. Similarly, if multiple delegators delegated access to the same proxy, this proxy should be able to access the system with the same user ID.

If you do not plan to use the New User Registration framework, make sure your proxies (whether they are new or existing users) have access to the USER_PROFILE component interface. This is needed in order to give users access to the proper role tied to the delegated transactions. The delegated role provisioning occurs after the proxies accept the terms and conditions.

Related Links

[New User Registration Framework and Delegated Access](#)

[Developer Reference to Deploy New User Registration](#)

Step 11: Modifying the Delegated Access Notification Templates

Define the text message you want to include in each of the email notifications triggered by Delegated Access. Go to **PeopleTools > Workflow > Notifications > Generic Templates**, and modify the notification templates for Delegated Access.

Note: Adding or removing template variables requires intensive code changes in the way the Delegated Access framework calls the Notifications framework. The email templates should not be used for extensive communication with the proxies or delegators.

Related Links

[Notifications Framework and Delegated Access](#)

Step 12: Activating the SCC_DA Web Service

To activate the web service:

1. Go to **PeopleTools > Integration Broker > Integration Setup > Service Operations**. The Service Operations - Search page appears.
2. Search for SCC_DA service, then select the SCC_DA_SUBMIT service operation.
3. On the General page ensure that the SCC_DA_SUBMIT service operation is active and regenerate both 'Any-to-Local' and 'Local-to-Local' routing definitions.

This example illustrates the fields and controls on the Service Operations General Page for SCC_DA.

4. To access the Web Service Access page, click **Service Operation Security**.
5. On the Web Service Access page, make sure you select a permission list for which all users have access. This permission list must be included in a role that is granted to all your users. The proxy can have a newly created user ID or use an existing user ID, but make sure the proxy has access to a role that contains the permission list.



































Note: When you set up New User Registration, you are required to create a user ID called SCC_SS_TEMPLATE. This user ID is cloned when a new User ID is created. The user ID template needs to have access to the basic security role called Standard Non-Page Permissions. This role contains the HCSPSERVICE permission list. Proxies who create a new user ID automatically have access to the SCC_DA_SUBMIT web service operation.

6. Perform steps 1–5 for the SCC_DA_AUTH_CHK service operation. In step 4, make sure all the permission lists that grant access to a delegated transaction are listed. For example, with the delivered sample delegated transactions, the following permission lists were created and should to be listed in the Service Operation Security:

This shows the Web Service Access Permission List Example.

Web Service Access

Operation: SCC_DA_AUTH_CHK

Permission			
Personalize Find  		First 	Last 
1-10 of 10			
Permission List	Access		
HCCPCSSA1000	Full Access 		
HCCPCSSA1010	Full Access 		
HCCPCSSA1140	Full Access 		
HCCPCSSA1141	Full Access 		
HCCPCSSA1150	Full Access 		
HCCPCSSA1160	Full Access 		
HCCPCSSA1170	Full Access 		
HCCPCSSA1180	Full Access 		
HCCPCSSA1181	Full Access 		
HCCPCSSA1182	Full Access 		

Related Links

[Step 6: Setting Up Permission Lists and Roles for the Delegated Access Components](#)

Step 13: Verifying the Existence of the Request Handler

To verify that the request handler exists:

1. Go to **Set Up SACR > System Administration > Integrations > Request Handlers**.
2. Search for the SCC_DA service name, then verify that the handler exists for both SCC_DA_SUBMIT and SCC_DA_AUTH_CHK service operations:

This example illustrates the Request Handler Page for SCC_DA_SUBMIT.

Request Handlers

Service Name:  Active Flag

Service Operation: 

Supported Interfaces: 

Description:

Long Description:

Security View: 

Application Class

Package Name: 

Path: 

Application Class ID: 

This example illustrates the Request Handler Page for SCC_DA_AUTH_CHK.

Request Handlers

Service Name:  Active Flag

Service Operation: 

Supported Interfaces: 

Description:

Long Description:

Security View: 

Application Class

Package Name: 

Path: 

Application Class ID: 

Troubleshooting Delegated Access

This section describes various troubleshooting scenarios.

Error message 158,963

This example illustrates Error Message 158,963.

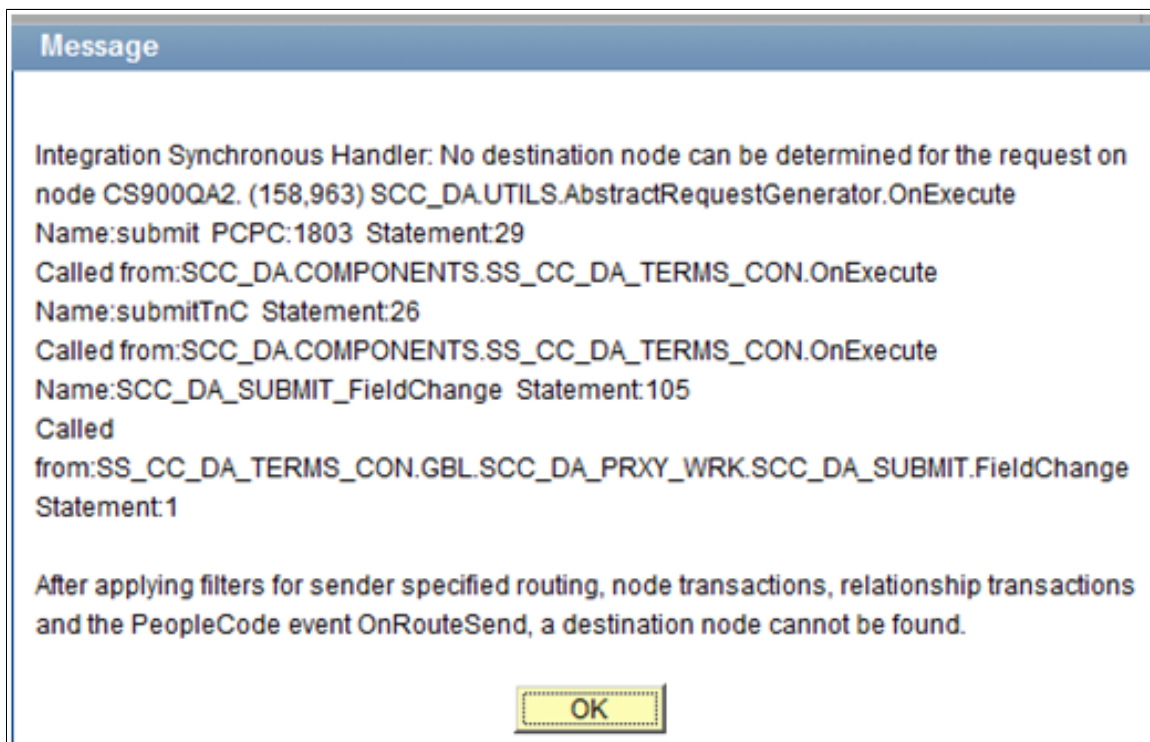

Replication

The proxy accepts the Proxy Terms and Conditions and presses the Submit button.

Resolution

Activate the web service SCC_DA.

1. Go to **PeopleTools > Integration Broker > Integration Setup > Service Operations**.
2. Select *Service = SCC_DA; Service Operation SCC_DA_SUBMIT*.
3. Make sure you select the **Active** check box, and the Routing Status is set to 'Exists'.

Error message 158,536

This example illustrates Error Message 158,536.

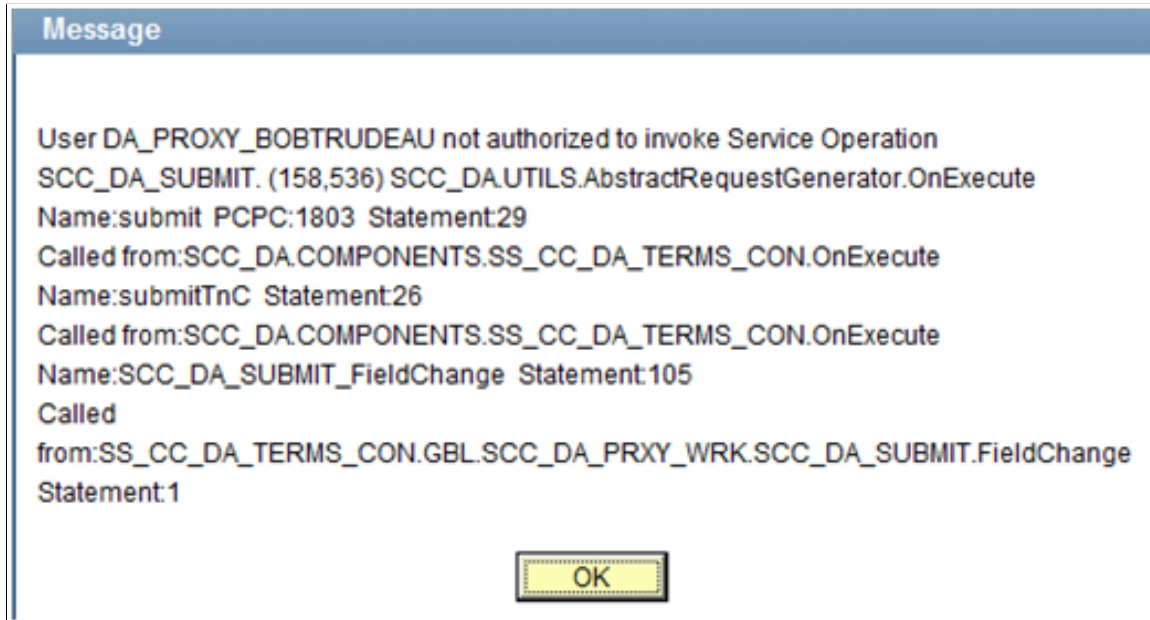

Replication

The proxy accepts the Proxy Terms and Conditions and presses the Submit button.

Resolution

- Give the proxy access to the HCCPCSSA1200 permission list, which grants access to the NUR Gatekeeper. You can include this permission list inside a role, for example: CS – NUR Gatekeeper.
- Give the proxy access to the HCCPCSSA1182 permission list, which grants access to the SCC_DA web service. You can include this permission list inside a role, for example: CS - DA Proxy TermsConditions.

Make sure all new and existing users have access to the role.

Error message 158,974

This example illustrates Error Message 158,974.

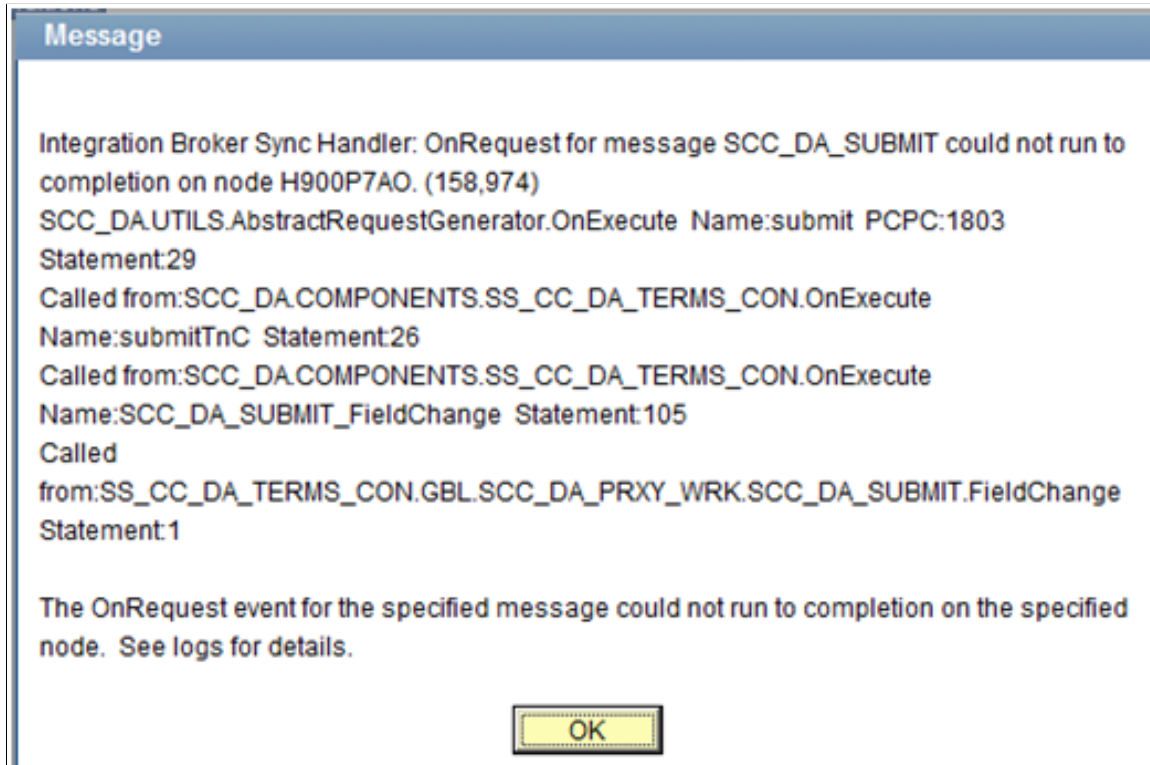

Replication

The proxy accepts the Proxy Terms and Conditions and presses the Submit button.

Resolution

The proxy user ID needs access to the USER_PROFILE component interface. To grant this access:

1. If you use the NUR framework, add the USER_PROFILE component interface to a permission list that you included in the SCC_GUEST and SCC_SS_TEMPLATE user ID templates.
2. Make sure your existing users (users that are not created by the NUR framework) have access to a permission list that gives them access to this component interface. To do this, add the permission list to a role that you assign to all your users.

Setting Up and Using New User Registration Framework

Understanding New User Registration

New User Registration is a framework that enables a user to sign in to the Campus Solutions system in order to complete a specific online self-service transaction. For example, on your institution's portal you could indicate the steps a future applicant should perform in order to apply online. In this case the specific online self-service transaction is the online application. You can provide a link to transfer the user to your Campus Solutions database where the future applicant first needs to sign in. Going through New User Registration, the user can either create a user ID and password, or use an existing user ID to sign in to your system. New User Registration assigns the newly created user profile with generic security roles that are required to access your system. When the user profile is created or when the user uses an existing user ID, New User Registration assigns security roles to the user profile that are specific to the online transaction to which the New User Registration framework is integrated. Once the user is authenticated, New User Registration immediately redirects the user to a predefined target page that is related to that specific online transaction.

In a nutshell, New User Registration offers user validation, user registration, system authentication, generic and specific (just-in-time) security provisioning, and easy navigation access by transferring the newly authenticated user to a predefined target page specific to the online self-service transaction the user elected to perform.

Consider this example. If you use Admission Applications Web Services (AAWS) and deployed an online application self-service component, an online applicant first uses New User Registration to register for a user ID (or first get authenticated if the applicant already has a user ID) and then perform the online application transaction, such as submitting an application. In this case, after being successfully authenticated to your system, the system provisions the applicant's user profile with the role security specific to access your online application page and then immediately redirects the applicant to this online application page. Another example is, if you are using the Delegated Access feature, a person who received delegated access (a proxy) could first use New User Registration to access your system by either creating a user ID or reusing an existing user ID. Once successfully authenticated through New User Registration, the system could provision the proxy's user profile with a security role needed to access the Delegated Access initial page (the Proxy Terms and Conditions page).

New User Registration provides web service operations that you can use on your user interface to:

- Create a user account (user ID) (SCC_USERREG_CREATEACCT)
- Authenticate a user (SCC_USERREG_AUTHENTICATE)
- Retrieve a user ID (SCC_USERREG_GET_USERID)
- Reset a password (SCC_USERREG_GET_PASSWORD and SCC_USERREG_GET_PSWD_HINT)

- Check if authenticated users have the proper security role (authorization) (SCC_CHECK_AUTH)

Also, New User Registration is a consumer of the Constituent Transaction Management (CTM) framework (delivered CTM transaction code is NEW_USER_REGISTRATION). This allows staging of any constituent information that is entered at the time of registering a new user ID. For example, when creating a user ID you may want to ask users to enter their name, email address, and so on. If the online transaction integrated with New User Registration is defined as a CTM transaction, it can reuse or display the constituent data that was entered at registration time in the self-service transaction pages (that is, if the CTM transaction is partitioned by constituent).

Your system is provided with two sample login pages: New User Registration login sample page and New User Registration Tester page. Both are visually similar and allow a user to create a user ID or use an existing user ID to access your system. The New User Registration login sample page is fully integrated with all the New User Registration framework security objects. It is an example of how your own custom login page can be integrated and deployed with New User Registration. For example, it can reside outside of your firewall and be set as a Kiosk. The New User Registration Tester page can be used by your developers to test and evaluate the New User Registration framework objects. The Tester page contains the same functionality included in the New User Registration login sample page, but is meant to be used inside the same database. This page should be used *only* for testing purposes and should *not* be deployed in a production environment.

The following diagram shows the workflow for a new user and a returning user when New User Registration framework is deployed:

New User Registration User Flows

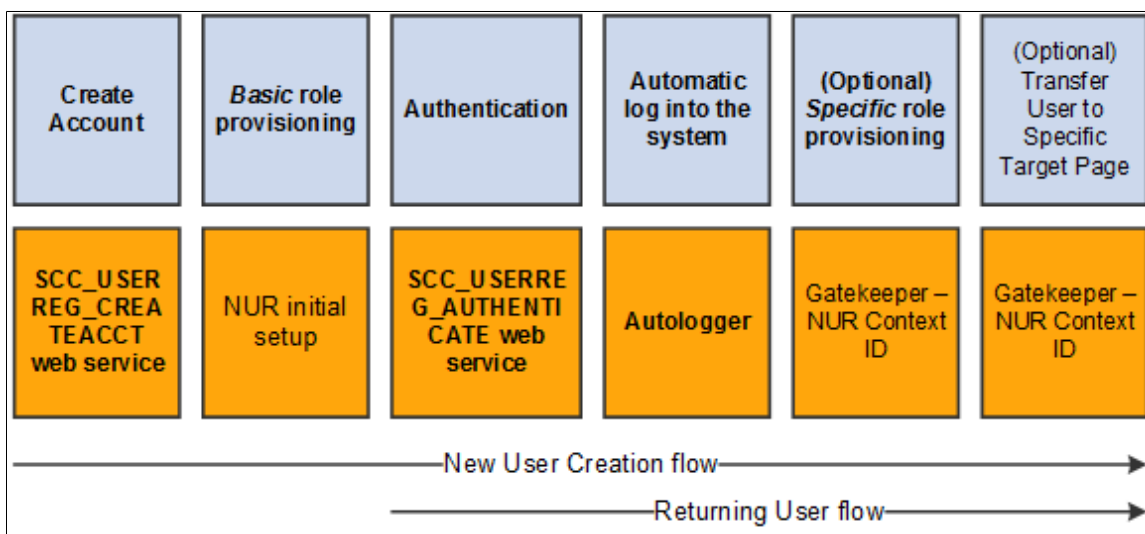

The first row of boxes indicates the steps in the workflow for a new or returning user. The second row indicates what needs to be set up so that the user can perform the step.

Related Links

[Using the New User Registration Sample User Interfaces](#)

[New User Registration Web Service Operations](#)

[Developer Reference to Deploy New User Registration](#)

[Understanding CTM](#)

New User Registration Terminology

The following terms are important to the understanding of New User Registration framework and are used throughout the documentation.

Term	Description
Guest	New user. A person who is unknown to the Campus Solutions system and who wants to perform an online transaction. A guest needs to register for a user ID to access the system.
Returning User	A person known to the Campus Solutions system and who wants to perform an online transaction. This person uses an existing user ID and password to access the system.
CTM	Constituent Transaction Management. This is a framework that allows a user to perform an online transaction without having an EMPLID known. CTM stores the constituent and the transaction-specific data in staging records. The system assigns an EMPLID only after the user saves or submits the online transaction. Using CTM allows no interruption for a user to complete an online transaction because the process that the system uses to assign an EMPLID is completely transparent to the online user.
Online transaction or online self-service transaction	This refers to the transaction that consumes the New User Registration framework.
Login page	The page used to access the Campus Solutions system. The login page is integrated with the New User Registration framework security objects. Institutions customize the sample login page or use their own page to comply with their security management requirements.
Target page	The page to which the guest or the returning user is redirected after being authenticated through the New User Registration framework. The target page is defined in the New User Registration Context setup component.
Landing page	The page to which the guest or user is redirected before registration and authentication by the system.
Autologger	An object that the New User Registration framework delivers. This object allows signing in the guest or the returning user directly into your system after being successfully authenticated.

Term	Description
Gatekeeper	<p>A utility that the New User Registration framework delivers. This utility acts as a router for all requests from external clients wishing to access Campus Solutions self-service pages. An external client is a user interface that is built by an institution and that lie outside the PeopleSoft system.</p> <p>The Gatekeeper uses the New User Registration Context ID to provision application-specific security role and transfer the user to a specific target page after authentication.</p>
SwitchUser	A PeopleTools function used by the New User Registration Tester sample page to autolog the guest's or the returning user's entered user ID. The function switches a signed in user to another one.
Anonymous user	When the guest elects to create a new user ID, he or she is first considered an anonymous user by the system.
Provisioning	<p>New User Registration provisions security roles at two levels:</p> <p>Basic provisioning: When a guest creates a new user ID through New User Registration, basic roles are provisioned to the newly created user profile. Basic roles grant access to generic information that all users are required to have to access and navigate in your system. This provisioning is required.</p> <p>Specific provisioning: When a New User Registration Context is used, the guest or the returning user is provisioned just-in-time after being authenticated with application level security. The security provisioning done here is specific to the application integrated with New User Registration. This provisioning is optional.</p>

Constituent Transaction Management and New User Registration

You can configure your login page to request additional personal information such as first name, last name, email address and so on when a user creates a new user ID. To store this information in the production tables, an EMPLID is required. If the user does not have an EMPLID at the time of registration, New User Registration uses the Constituent Transaction Management (CTM) framework to store the personal information in the CTM constituent staging tables. During this process, the system enters the information using a temporary ID (SCC_TEMP_ID), and uses the CTM transaction code NEW_USER_REGISTRATION that is delivered with your system. If New User Registration is followed by a subsequent CTM online transaction (and that CTM transaction is set up to be partitioned by constituent), the system can gather additional personal information, create or assign an EMPLID, then promote the staged constituent data to the respective production tables.

The following diagrams show where CTM takes place as part of the New User Registration flow:

This example illustrates the fields and controls on the Create Account Page for New Users. You can find definitions for the fields and controls later on this page.

The diagram shows a 'Create Account' form with the following fields: 'Choose your User ID', 'Create a password', 'Confirm your password', 'Email Address', 'First Name', and 'Last Name'. A 'Create Account' button is at the bottom. Brackets on the right indicate data storage destinations: the first three fields are linked to a grey box labeled 'Used to register and authenticate the new user', and the last three fields are linked to a red box labeled 'Data stored in the CTM constituent staging tables (keyed by User ID and Temp ID)'.

This example illustrates the fields and controls on the Login Page for Existing Users. You can find definitions for the fields and controls later on this page.

The diagram shows a login form with 'User ID:' and 'Password:' labels above input fields, and a 'Sign In' button. A bracket on the right indicates the data storage destination: a grey box labeled 'Used to authenticate the returning user'.

When New User Registration consumes CTM, the system does not trigger the process to create EMPLIDs. This prevents non-serious individuals from creating user records for themselves in your system and populating your database with dummy names or with users that never pursue any other actions with your institution. To prevent this, CTM triggers Search/Match only when the guest performs a subsequent transaction such as an online application. Only then is the constituent data considered valid.

Note: CTM is not involved when an existing user signs into your system through New User Registration. This is because at the time of authentication the returning user is typically only asked to enter a user ID and a password.

The self-service online transaction that you integrate with New User Registration does not need to be a CTM transaction. A self-service online transaction is usually configured for CTM when the data provided by the self-service user needs to be staged before it is moved to the production tables, or when an EMPLID needs to be associated with the self-service user. Using CTM allows for no user interruption to assign an EMPLID. If the integrated self-service online transaction does not require an EMPLID to be assigned or no data to be staged, it can still be integrated with New User Registration.

See [Setting Up CTM for New User Registration](#).

Notifications Framework and New User Registration

The New User Registration framework uses the Notifications framework as part of the Forgot User ID utility. New User Registration triggers the Notifications framework from the New User Registration sample login page or New User Registration Tester page. When users click the Forgot your User ID link and enters their address, the system validates the email address and the user ID is retrieved. The Notifications framework sends an email to the user that contains the user's ID.

An email template for sending an email message that contains the user's ID is delivered with your system. It uses a custom logic to retrieve the user's email address. This logic is delivered with your system and it matches the email address in the user's profile with the email address users provide

when they use the Forgot User ID utility. The custom logic is contained in the application class `SCC_IDENTITY_MGR:NOTIFICATION:NURCustomLogicprovider`.

Notification Templates for New User Registration

Email templates are delivered with your system. These generic templates establish a common format for notifications.

<i>Template Name</i>	<i>Description</i>	<i>Trigger</i>	<i>Recipient</i>
NUR_EMAIL_OPRID	<p>A basic email that includes the user ID of the requestor.</p> <p>Example:</p> <p>Email Subject: Your User ID to access the Campus Solutions system. Email Message: You are receiving this email message because you had forgotten your User ID to access the Campus Solutions system. Your User ID is TEST100 This is an auto generated email; please do not respond to this message.</p>	<p>When a user clicks the Forgot your User ID link on the New User Registration sample login or Tester page. The user provides an email address, which the system validates. When the email address is valid, the user ID is retrieved and is sent through an email message.</p>	<p>Users who have forgotten their user IDs.</p>

To modify the template, go to **PeopleTools > Workflow > Notifications > Generic Templates**.

Currently, only the following variables are defined and delivered with the Forgot User ID utility. Adding more variables requires substantial programming effort.

- %1 => OPRID
- %2 => URL Link (not used in the delivered template)

Warning! Notifications are intended to be short and simple messages with the purpose of informing about a specific subject. The list of variables contained in each message is delivered with your system and require extensive coding effort to be modified.

Note: As part of New User Registration framework, only the Forgot User ID utility consumes the Notifications framework. The Forgot Password utility uses the PeopleTools Send Password Email utility.

See [Understanding the Notifications Framework](#)

New User Registration Context

A New User Registration context is optionally used when the New User Registration framework is consumed by a specific self-service online transaction. A New User Registration context is defined through a New User Registration context ID. The context ID is an *optional* element. You embed the context ID in a URL that is used to transfer a user to the New User Registration login page. You need a

New User Registration context ID if you want to seamlessly assign application-specific security roles to the newly authenticated user, and then transfer the user to the target page for the self-service online transaction that the user wants to access. The Gatekeeper uses the Context ID that you include in the URL to grant the user the required security roles, and to access the target page.

The New User Registration Context ID is read by the Gatekeeper immediately after a user is successfully authenticated into your system. The New User Registration Context ID defines the security roles that the system should assign to the user. This ensures that the user has the required security roles to be automatically transferred to the target page for that specific self-service transaction and perform the online transaction. Both security provisioning and page transfer occur after a guest or returning user is successfully authenticated by New User Registration into your system. You can define a New User Registration Context for each online self-service transaction that you integrate with New User Registration. Each transaction has its own security provisioned and target page information.

To define a New User Registration Context, use the New User Registration Context page (SCC_APPL_CONTEXT). The security provisioning is defined by roles and the target page can either be a PeopleSoft Internet Architecture (PIA) page defined in your PeopleSoft system or a URL to an external site. Provisioning security or transferring to a target page is optional. Create a New User Registration Context for your integrated self-service transaction only if you want to provision specific security for the transaction or to transfer the user directly to a target page related to the self-service transaction.

You can create a default New User Registration Context ID. If there is no New User Registration Context ID in the URL when a user accesses the New User Registration login page, the default context ID is used to provision security or transfer the user to a target page. In this case, you should set up your default context ID to contain generic information such as your institution's home page, which is then used as the target page.

See:

- [Provisioning Access Through the Gatekeeper](#)
- [Setting Up New User Registration Context](#)
- [Deploying New User Registration](#)

New User Registration Web Service Operations

The New User Registration framework provides the SCC_USERREG service. The SCC_USERREG service includes the following service operations that are described in this section:

- SCC_USERREG_CREATEACCT—creates a user account.
- SCC_USERREG_AUTHENTICATE—authenticates a user.
- SCC_USERREG_GET_USERID—retrieves the user ID.
- SCC_USERREG_GET_PSWD_HINT—retrieves the password hint.
- SCC_USERREG_GET_PASSWORD—resets user password.
- SCC_CHECK_AUTH—authenticates a user, and checks if the user has the required security role (authorization)

Note: If a SOAP service request XSD contains the 'languageCd' parameter then the service is enabled for National Language Support (NLS). An ISO Locale value must be passed as the languageCd variable. Valid values can be found in **PeopleTools > Utilities > International > Languages**.

The following diagram shows the SCC_USERREG web service operations and their messages. The diagram also shows the location from where an online transaction can access the SCC_USERREG web service.

This example illustrates the fields and controls on the SCC_USERREG Web Services and Locator Example. You can find definitions for the fields and controls later on this page.

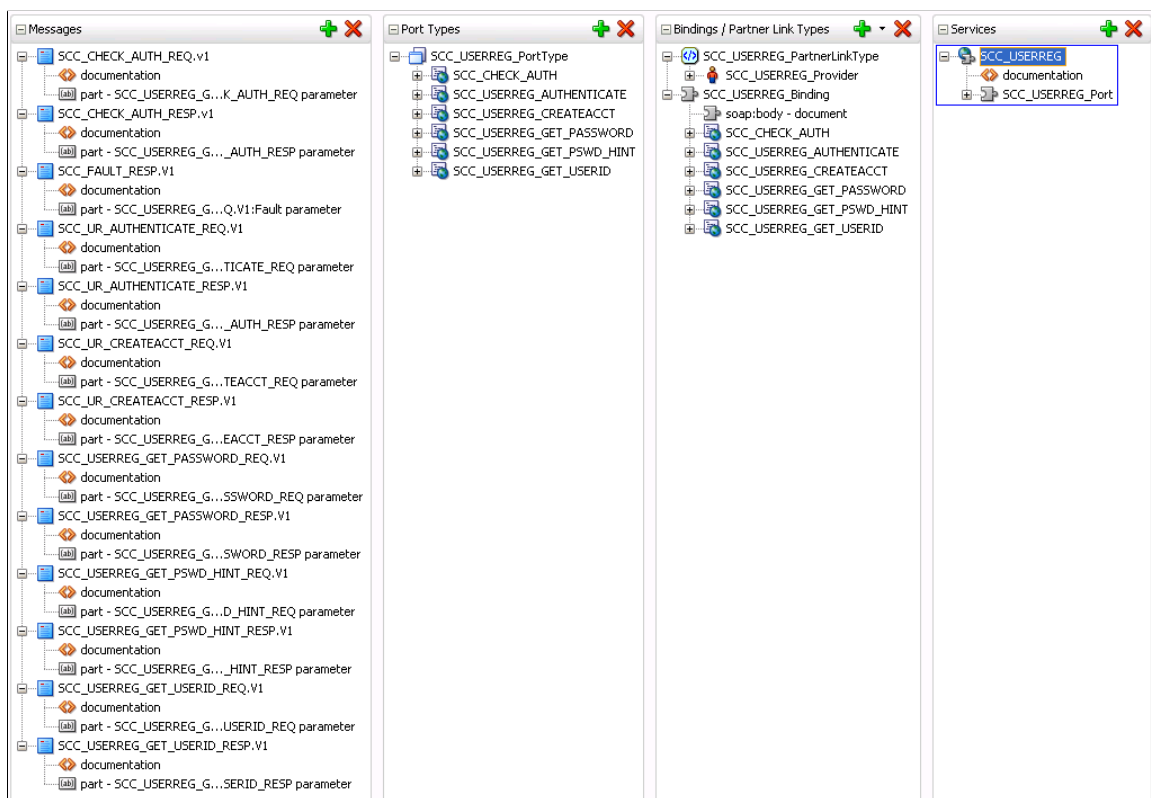

Create User Account (SCC_USERREG_CREATEACCT) Service Operation

Use this service operation to enable an online user to create a user name (user ID) and password. This service operation creates a new PeopleTools user profile.

The service operation supports the PeopleTools user management system. The service operation also supports other user management systems through the adapter architecture. To allow your PeopleSoft system to interact with another user management system through SCC_USERREG, a new adapter must be created.

When calling the Create User Account service operation, the user is required to choose a user name and password, and optionally to enter some constituent information such as first name, last name, email address, and so on. This either creates or does not create a single user account in the user management system you configure. If the user name is valid and does not already exist in the user management system, the service operation creates a user account. The new user account can be used immediately (no need for the new user to manually login). The user account is created based on an existing user ID that serves as a template (the SCC_SS_TEMPLATE user ID). This account must contain the basic role and permission

security to access and use your system. This is also referred as the generic role provisioning. The service operation copies the user default information contained in this template, to create the new account. Therefore, you must set up the SCC_SS_TEMPLATE user account to allow an online transaction to use New User Registration. A second user ID that needs to be created and which also serves as a template to create user profiles is SCC_GUEST.

See [Developer Reference to Deploy New User Registration](#), “Step 1: Initial Setup for New User Registration.”

The Create User Account service operation:

1. Verifies whether the required input parameters have been passed in the user registration page (user name, password, and confirm password).
2. Retrieves any constituent information from the input parameters, if included in the registration page, and validates the information. The constituent information is stored in the CTM constituent staging tables using the CTM transaction NEW_USER_REGISTRATION.
3. Calls the user management adapter to:
 - a. Verify that the requested user name does not exist in the user management system.
 - b. Verify your Password Controls setup is respected. This is defined in **PeopleTools > Security > Password Configuration > Password Controls**.
 - c. Create the new user account.
 - d. Authenticate the user and signs the user into the online transaction.
4. Prepares the response message. The service operation either creates a new user account which the user can immediately use or returns an error. The service error returns an error in the following conditions:
 - User name, password or confirm password input parameters are invalid.
 - Constituent information provided through the input parameters is invalid.
 - The PeopleSoft Password Controls rules are not respected.
 - An account for the same user name already exists in the user management system.

Note: If you intend to use the Forgot User ID and Forgot Password utilities, you must require the user to enter an email address when they create an account. To do this, you must select the **Email Address** check box in the New User Registration Installation page. The email address the user provides is stored in the newly created user profile and serves to send user ID or reset password if the user later forgets his or her user ID or password. The New User Registration sample login page and New User Registration Tester page are integrated with the Forgot User ID and Forgot Password utilities. To take advantage of this integration, make sure you select the **Email Address** check box in the New User Registration Installation page.

See [Defining Installation Options for New User Registration](#).

The Create User Account service operation includes the following three messages:

Input message: SCC_UR_CREATEACCT_REQ

The following diagram shows the input parameters that the SCC_USERREG_CREATEACCT service operation receives from a calling online transaction (mostly the user registration page):

This example illustrates the fields and controls on the SCC_UR_CREATEACCT_REQ Message Parameters. You can find definitions for the fields and controls later on this page.

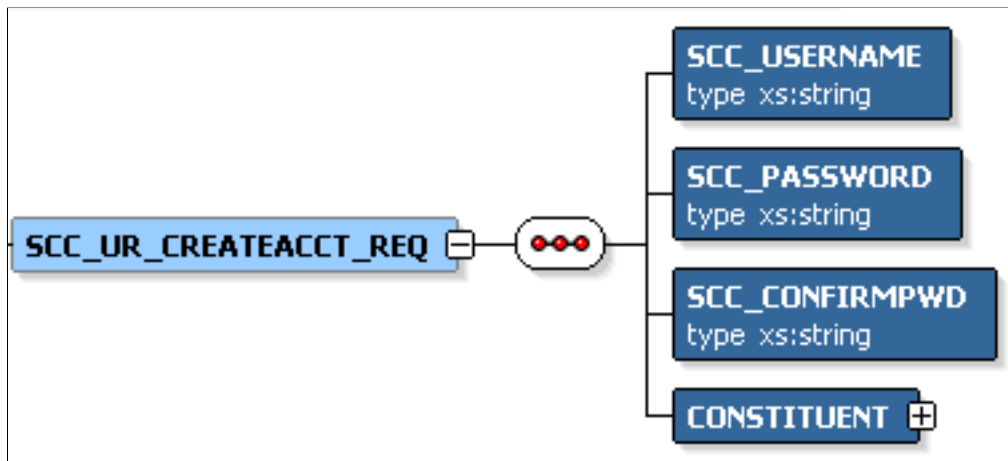

The following input parameters are mandatory by the registration page to pass to the service operation:

- SCC_USERNAME
- SCC_PASSWORD
- SCC_CONFIRMPWD
- CONSTITUENT

While the CONSTITUENT tag is required in the request message (as indicated in the request message schema: `<xs:element maxOccurs="1" minOccurs="1" ref="CONSTITUENT"/>`) the CONSTITUENT elements can be empty in the request. This is because it is possible, but optional to gather constituent information at registration time.

Constituent is an entity defined in the Entity Registry. Use the PeopleTools Schema page to access the SCC_ENTITY_CONSTITUENT message schema (**PeopleTools** > **Integration Broker** > **Integration Setup** > **Messages** > **Schema**). Any attributes contained in the schema can be used in the registration page.

See [Setting Up Entity Registry](#).

The following is an example of the SCC_UR_CREATEACCT_REQ message that the SCC_USERREG_CREATEACCT service operation receives from a user registration page:

```
<?xml version="1.0"?>
<SCC_UR_CREATEACCT_REQ>
  <SCC_USERNAME>KANGA</SCC_USERNAME>
  <SCC_PASSWORD>Rooly23</SCC_PASSWORD>
  <SCC_CONFIRMPWD>Rooly23</SCC_CONFIRMPWD>
  <CONSTITUENT>
    <!-- Constituent data shape -->
  </CONSTITUENT>
</SCC_UR_CREATEACCT_REQ>
```

Output message: SCC_UR_CREATEACCT_RESP

The following diagram shows the output parameters that the SCC_USERREG_CREATEACCT service operation passes to the calling online transaction:

This example illustrates the fields and controls on the SCC_UR_CREATEACCT_RESP Message Parameters. You can find definitions for the fields and controls later on this page.

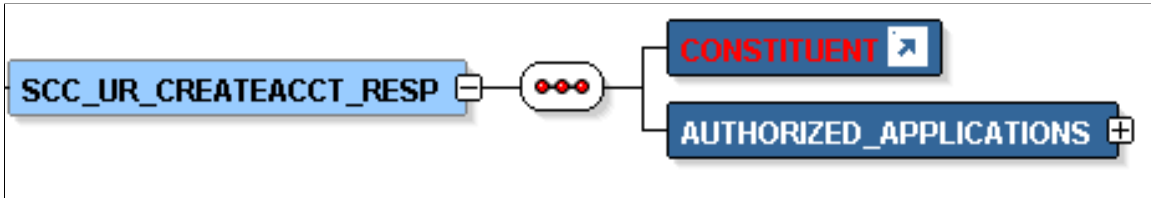

Constituent is an entity defined in the Entity Registry. Use the PeopleTools Schema page to access the SCC_ENTITY_CONSTITUENT schema (**PeopleTools > Integration Broker > Integration Setup > Messages > Schema**).

This example illustrates the fields and controls on the Example of the SCC_UR_CREATEACCT_RESP message that the SCC_USERREG_CREATEACCT service operation responds to the calling online transaction. You can find definitions for the fields and controls later on this page.

```
<?xml version="1.0"?>
<SCC_UR_CREATEACCT_RESP>
  <CONSTITUENT>
    <!-- Constituent data shape -->
  </CONSTITUENT>
  <NUR_REGISTRATION_CONTEXT>
    <SCC_APPL_CONXTXT_ID>SCC_NURCTXT_20120918102441</SCC_APPL_CONXTXT_ID>
    <SCC_APPL_CONTEXT>NUR_DELEGATED_ACCESS</SCC_APPL_CONTEXT>
    <URL>http%3a%2f%2fyourKioskServer.yourKioskDomain.com%2fpsc%2fyourCSPSoftWebsiteName%
2fEMPLOYEE%2fHRMS%2fc%2fSCC_NUR.SCC_NUR_REG.GBL%3dstart%3fCAMPUS_URL%3dhttp%253a%
252f%252fyourCSServerName.yourCSDomainName%252fpsc%252fyourCSPSoftWebsiteName%
252fEMPLOYEE%252fHRMS%252fs%252fWEBLIB_SCC_NUR.SCC_SS_GATEKEE
PER.FieldFormula.Iscript_SCC_GateKeeper%253fSCC_APPL_CONXTXT_ID%253dSCC_NURCTXT_
20120918102441</URL>
  </NUR_REGISTRATION_CONTEXT>
</SCC_UR_CREATEACCT_RESP>
```

Fault message: SCC_FAULT_RESP

If the service operation encounters an error condition, it responds with the SCC_FAULT_RESP message.

The following diagram shows the output parameters that the SCC_FAULT_RESP service operation passes to the calling online transaction:

This example illustrates the fields and controls on the SCC_FAULT_RESP Message Parameters. You can find definitions for the fields and controls later on this page.

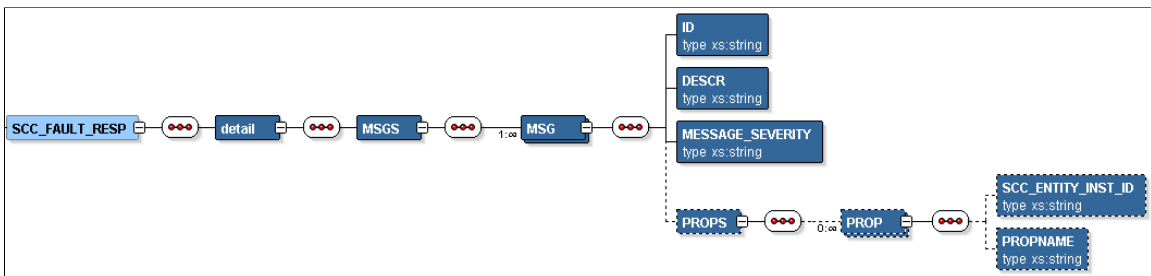

Authenticate User (SCC_USERREG_AUTHENTICATE) Service Operation

This service operation uses the delivered User Manager adapter to validate a username (user ID) and password combination with the installed user management system. The service operation is delivered with the ability to authenticate a user using the PeopleTools user management system.

A call to the SCC_USERREG_AUTHENTICATE service operation verifies whether the supplied username and password combination is correct using the configured user management system. If the username and password combination is correct, then the user is signed into the PeopleSoft system. All users accessing the SCC_USERREG_AUTHENTICATE operation have an Anonymous status until they have been successfully authenticated. Anonymous users only have minimal system access.

Use SCC_USERREG_AUTHENTICATE to allow a user to access your system through a front door, such as a login page.

The Authenticate User (SCC_USERREG_AUTHENTICATE) service operation:

1. Verifies whether the input parameters exist (user name and password).
2. Calls the user management adapter to validate the user name and password combination.
3. If an EMPLID is tied to the retrieved user profile, uses the EMPLID to retrieve constituent information on the authenticated person.
4. Prepares the response message. The service operation either signs in the user to the PeopleSoft system or returns an error. The service error returns an error in the following conditions:
 - Input parameters, username and password, are invalid.
 - User name and password combination cannot be authenticated using the user management system.

The Authenticate User service operation includes the following messages:

Input message: SCC_UR_AUTHENTICATE_REQ

The following diagram shows the input parameters that the SCC_USERREG_AUTHENTICATE service operation receives from a calling online transaction (mostly the user login page):

This example illustrates the fields and controls on the SCC_UR_AUTHENTICATE_REQ Message Parameters. You can find definitions for the fields and controls later on this page.

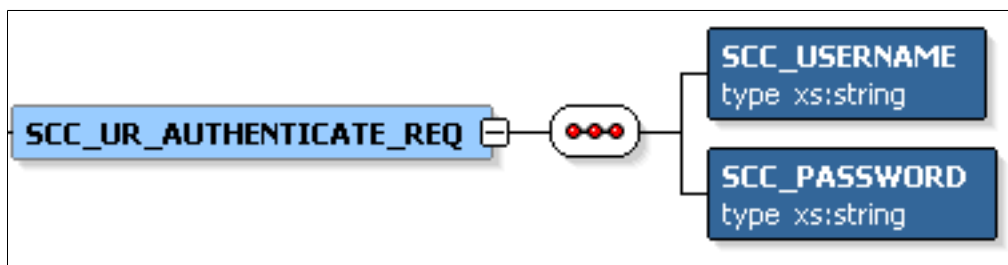

The following input parameters are mandatory for the login page to pass to the service operation:

- Username

- Password

The following is an example of the SCC_UR_AUTHENTICATE_REQ message that the SCC_USERREG_AUTHENTICATE service operation receives from a login page:

```
<?xml version="1.0"?>
<SCC_UR_AUTHENTICATE_REQ>
  <SCC_USERNAME>KANGA</SCC_USERNAME>
  <SCC_PASSWORD>Ro0ly23</SCC_PASSWORD>
</SCC_UR_AUTHENTICATE_REQ>
```

Output message: SCC_UR_AUTHENTICATE_RESP

The following diagram shows the output parameter that the SCC_USERREG_AUTHENTICATE service operation passes to the calling online transaction:

This example illustrates the fields and controls on the SCC_UR_AUTHENTICATE_RESP Message Parameters. You can find definitions for the fields and controls later on this page.

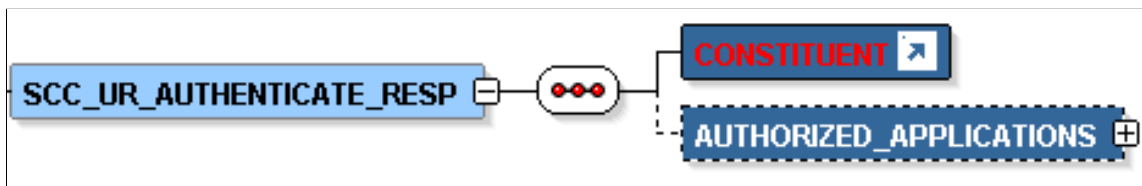

Constituent is an entity defined in the Entity Registry. Use the PeopleTools Schema page to access the SCC_ENTITY_CONSTITUENT schema (**PeopleTools > Integration Broker > Integration Setup > Messages > Schema**).

This example illustrates the fields and controls on the Example of the SCC_UR_AUTHENTICATE_RESP message that the SCC_USERREG_AUTHENTICATE service operation transmits to the calling online transaction. You can find definitions for the fields and controls later on this page.

```
<?xml version="1.0"?>
<SCC_UR_AUTHENTICATE_RESP>
  <CONSTITUENT>
    <!-- Constituent data shape -->
  </CONSTITUENT>
  <NUR_REGISTRATION_CONTEXT>
    <SCC_APPL_CONXTXT_ID>SCC_NURCTXT_20120918102441</SCC_APPL_CONXTXT_ID>
    <SCC_APPL_CONTEXT>NUR_DELEGATED_ACCESS</SCC_APPL_CONTEXT>
    <URL>http%3a%2f%2fyourKioskServer.yourKioskDomain.com%2fpsc%2fyourCSPSoftWebsiteName%2fEMPLOYEE%
      2fHRMS%2fc%2fSCC_NUR.SCC_NUR_REG.GBL%3dstart%3fCAMPUS_URL%3dhttp%253a%252f%
      252fyourCSServerName.yourCSDomainName%252fpsc%252fyourCSPSoftWebsiteName%252fEMPLOYEE%
      252fHRMS%252fs%252fWEBLIB_SCC_NUR.SCC_SS_GATEKEEPER.FieldFormula.IScript_SCC_GateKeeper%
      253fSCC_APPL_CONXTXT_ID%253dSCC_NURCTXT_20120918102441</URL>
  </NUR_REGISTRATION_CONTEXT>
</SCC_UR_AUTHENTICATE_RESP>
```

```
<?xml version="1.0"?>
<SCC_UR_CREATEACCT_RESP>
  <CONSTITUENT>
    <!-- Constituent data shape -->
  </CONSTITUENT>
  <NUR_REGISTRATION_CONTEXT>
    <SCC_APPL_CONXTXT_ID>SCC_NURCTXT_20120918102441</SCC_APPL_CONXTXT_ID>
    <SCC_APPL_CONTEXT>NUR_DELEGATED_ACCESS</SCC_APPL_CONTEXT>
    <URL>http://yourServer.yourDomain.com/EMPLOYEE/SCC_DA_PROXY/SS_CC_DA_TERMS_CON</=>
  URL>
```

```
</NUR_REGISTRATION_CONTEXT>  
</SCC_UR_CREATEACCT_RESP>
```

Fault message: SCC_FAULT_RESP

Refer to the SCC_FAULT_RESP message example in the SCC_USERREG_CREATEACCT service operation section.

Retrieve User ID (SCC_USERREG_GET_USERID) Service Operation

This service operation retrieves a user's ID using the Forgot User ID utility. A user must provide the email address that is associated with his or her OPRID (stored inside the user's profile) in order to retrieve the user ID. The user ID is retrieved only if one OPRID is associated with the email address. The New User Registration framework uses the Notifications framework to generate the email message that contains the user ID.

The Retrieve User ID service operation:

1. Verifies whether the required input parameter (email address) has been passed to the Forgot my User ID page.
2. Validates whether the email address entered is associated with only one user ID (OPRID) (from the PSOPRDEFN and PSUSEREMAIL records).
3. Prepares the response message. The service operation either retrieves the user ID and uses the Notifications framework to send an email that contains the user ID, or returns an error. An error is returned when:
 - The email address is not found.
 - The email address is associated with multiple user IDs (OPRIDs), or to no user ID.

See Notifications Framework and New User Registration.

The Retrieve User ID service operation includes the following messages:

Input Message: SCC_USERREG_GET_USERID_REQ

The email address is a mandatory input parameter to pass to the service operation. The utility evaluates whether there is only one OPRID assigned to the email address. If so, the user ID is retrieved.

Output Message: SCC_USERREG_GET_USERID_RESP

When the user ID is retrieved, an email that contains the user ID is sent to the user as part of the response. The Notifications framework is triggered to send the email message.

If more than one user ID is assigned to an email address or no user ID is found, the user ID is not retrieved and an error message appears.

See:

- [Using the Forgot User ID Utility](#)

- [Step 9: Configuring the Forgot User ID Utility](#)

Retrieve Password Hint (SCC_USERREG_GET_PSWD_HINT) Service Operation

This service operation retrieves the Forgot Password Hint set when a user forgets his or her password and triggers the PeopleTools Forgot Password utility. The PeopleTools Forgot Password utility requires that Forgot Password Hints should be defined. A user must provide his or her user ID in order to reset and receive a new password. When a user forgets his or her password and invokes the Forgot Password utility, the user ID that is provided is used to fetch the email address and Forgot Password hint set. The user's response is compared with the information stored in the database.

The Retrieve Password Hint service operation:

1. Verifies whether the required input parameter, user ID (OPRID), has been passed in the Forgot my password page.
2. Evaluates whether the user ID is valid.
3. Prepares the response message. If the user ID is valid, the service operation retrieves the associated email address and displays the password hint set, or returns an error. An error is returned when:
 - The user ID is not found.
 - The user ID is not associated with a Forgot Password hint set.
 - The user ID is not associated with an email address, so an email cannot be sent.

See [Using the Forgot Password Utility](#).

The Retrieve Password Hint service operation includes the following messages:

Input Message: SCC_USERREG_GET_PSWDHINT_REQ

The user ID (OPRID) is a mandatory parameter to pass to the service operation. The service operation evaluates whether the user ID is valid. If so, the associated email address and hint question are retrieved.

Output Message: SCC_USERREG_GET_PSWDHINT_RESP

If the user ID is valid, the associated email address and hint question are returned. If the user ID does not exist, is not associated with an email address or hint question, the service operation displays an error.

See [Developer Reference to Deploy New User Registration](#), “Step 10: Configuring the Forgot Password Utility.”

Reset Password (SCC_USERREG_GET_PASSWORD) Service Operation

This service operation resets a user's password using the PeopleTools Forgot Password utility. When a user forgets his or her password and uses the Forgot Password utility, the user ID that is provided is used to fetch the associated Forgot Password hint set. The user must provide the correct response to the hint question. The response is compared with the information stored in the database, and when the information matches, a new password is generated and emailed to the user.

The Reset Password service operation:

1. Evaluates whether the user's response to the hint question matches the information stored in the database.
2. Generates a new password if the user's response and the information in the database match.

The Reset Password service operation includes the following messages:

Input Message: SCC_USERREG_GET_PASSWORD_REQ

The hint response is a mandatory parameter to pass to the service operation. The custom interface SCC_NUR_EMAIL_PSWD is invoked. If the hint response matches the information in the database, the password is reset and all the PeopleTools tables are updated with the new password.

Output Message: SCC_USERREG_GET_PASSWORD_RESP

A new password is generated and emailed to the user through the PeopleTools Forget Password email utility.

Check Authorization (SCC_CHECK_AUTH) Service Operation

This service operation uses the User Manager adapter to validate a user name (user ID) and password combination against your user management system. The service operation provides an additional facility to return authorization information for an authenticated user. The service operation also authenticates a user using the PeopleTools user management system.

A call to the SCC_CHECK_AUTH service operation verifies whether the supplied user name and password combination is correct using the configured user management system. If the user name and password combination is correct, then the user is signed into the PeopleSoft system. Optionally, this service operation can return Role Based Access control (RBAC) authorization information for the authenticated user. The service caller can include optional role filter criteria in the request. The optional role filter criteria is compared against the PeopleSoft RBAC information associated with the user profile, and the matching role information is then returned to the client. This means that the user has access to the returned roles. All users accessing the SCC_CHECK_AUTH operation have an Anonymous status until they have been successfully authenticated. Anonymous users only have minimal system access.

Use SCC_CHECK_AUTH to allow a user to access your system through a front door, such as a login page, and to validate role authorization information.

The Check Authorization service operation:

1. Verifies whether the input parameters exist (user name and password and optional Role filters).
2. Calls the user management adapter to validate the user name and password combination.
3. Matches the roles to the user profile roles and returns *only* roles that are common, if the optional role filters are provided.
4. Prepares the response message. The service operation either signs in the user to the PeopleSoft system or returns an error. An error is returned when:
 - The input parameters, user name and password, are invalid.

- The user name and password combination cannot be authenticated using the user management system.

The Check Authorization User service operation includes the following messages:

Input message: SCC_CHECK_AUTH_REQ

The following diagram shows the input parameters that the SCC_CHECK_AUTH service operation receives from a calling online transaction. For example, the user login page:

This example illustrates the fields and controls on the SCC_CHECK_AUTH_REQ Message Parameters. You can find definitions for the fields and controls later on this page.

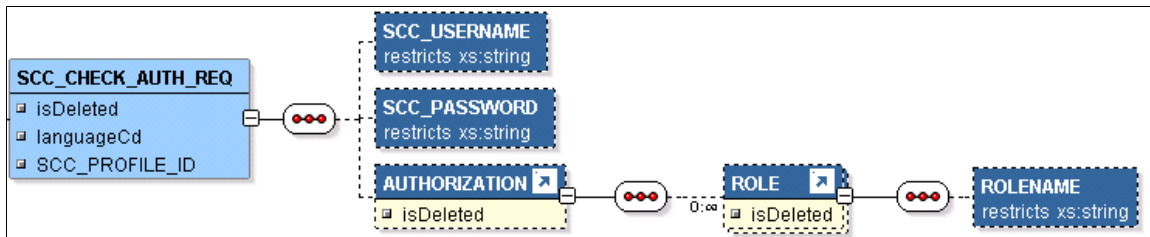

The following input parameters are mandatory for the login page to pass to the service operation:

- User name
- Password

The following is an example of the SCC_CHECK_AUTH_REQ message that the SCC_CHECK_AUTH service operation receives from a login page:

```

<?xml version="1.0"?>
<SCC_CHECK_AUTH_REQ>
  <SCC_USERNAME>KANGA</SCC_USERNAME>
  <SCC_PASSWORD>Rooly</SCC_PASSWORD>
  <AUTHORIZATION>
    <ROLE>
      <ROLENAME>CS - Prospect</ROLENAME>
      <ROLENAME>CS - Student</ROLENAME>
    </ROLE>
  </AUTHORIZATION>
</SCC_CHECK_AUTH_REQ>
  
```

Output message: SCC_CHECK_AUTH_RESP

The following diagram shows the output parameter that the SCC_CHECK_AUTH service operation passes to the calling online transaction:

This example illustrates the fields and controls on the SCC_CHECK_AUTH_RESP Message Parameters. You can find definitions for the fields and controls later on this page.

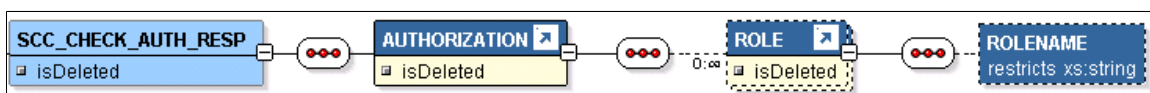

The following is an example of the SCC_CHECK_AUTH_RESP message that the SCC_CHECK_AUTH service operation transmits to the calling online transaction:

```
<?xml version="1.0"?>
<SCC_CHECK_AUTH_RESP xmlns="http://xmlns.oracle.com/Enterprise/services">
  <AUTHORIZATION>
    <ROLE>
      <ROLENAME>CS - Student</ROLENAME>
    </ROLE>
  </AUTHORIZATION>
</SCC_CHECK_AUTH_RESP>
```

Fault message: SCC_FAULT_RESP

See [Create User Account \(SCC_USERREG_CREATEACCT\) Service Operation](#), Fault message: SCC_FAULT_RESP.

Using the New User Registration Sample User Interfaces

This section describes the New User Registration sample pages and discusses the:

- New User Registration login sample page.
- New User Registration Tester page.
- User Flow for a returning user
- User Flow for a guest
- Forgot User ID Utility.
- Forgot Password Utility.

The New User Registration sample login pages are visually similar. These pages allow a user to create a new user account or use an existing account to access your system. These pages are meant to be used only as a reference or guide for implementing New User Registration in your institution. The sample login page serves as an example of how your own custom (institution-specific) login page can be integrated and deployed with New User Registration. The sample page works only with the Kiosk setup. For example, it can reside outside of your firewall and be set up as a kiosk.

The New User Registration Tester page is used for testing purposes such as evaluating the security objects that comprises the New User Registration framework. The Tester page contains the same functionality included in the New User Registration login sample page (except the Autologger and Gatekeeper), but is meant to be used in the same database. The Tester page is intended to be used *only* for testing purposes.

While both sample login pages are visually similar, the New User Registration sample login page is fully integrated with all the delivered New User Registration framework security objects in order to:

- Provision the basic roles set up in SCC_SS_TEMPLATE.
- Trigger the New User Registration web service operations for creating and authenticating a user (SCC_USERREG_CREATEACCT and SCC_USERREG_AUTHENTICATE).
- Use the delivered New User Registration CTM transaction (NEW_USER_REGISTRATION).

- Take advantage of the New User Registration Context ID.
- Validate user authorization and authentication based on PeopleTools security.
- Allow a user to launch the Forgot User ID or Forgot Password utility.

You can deploy New User Registration fully or partially, or if you already have your own security management system, you can continue to use it.

Note: The New User Registration sample login pages are not intended to be deployed in a production environment for end users.

Pages Used to Access New User Registration Sample User Interfaces

<i>Page Name</i>	<i>Definition Name</i>	<i>Navigation</i>	<i>Usage</i>
New User Registration	SCC_NUR_REG	Set Up SACR > System Administration > Utilities > Sample User Interfaces > New User Registration	Shows an example of how to integrate and deploy your custom login page with New User Registration.
New User Registration Tester	SCC_NUR_TESTER	Set Up SACR > System Administration > Utilities > Sample User Interfaces > New User Registration Tester	Tests and evaluates New User Registration framework objects.
Forgot my User ID	SCC_NUR_FRGT_USRID	Click the Forgot your User ID link on the New User Registration or New User Registration Tester page.	Retrieves user ID.
Forgot My Password	SCC_NUR_FRGT_PSWD	Click the Forgot your password link on the New User Registration or New User Registration Tester page.	Resets user password.

Using the New User Registration Login Sample Page

The New User Registration login sample page is also integrated with the following New User Registration framework security objects:

- The Autologger to immediately sign in the user into your system.
- The Gatekeeper to optionally provision specific application role level security and to transfer to an application specific target page.
- A specific or defaulted New User Registration Context ID specified in the URL to access your login sample page.

- The language links to access your system in the user’s preferred language (requires that your system supports translation for at least one language other than the base language).

The New User Registration login sample page is intended to be used outside of your system firewall, for example within a Kiosk. When the page is deployed, the login page (or a custom version of it) is accessed through a URL (not from a Peoplesoft regular menu navigation). The URL is embedded with the Gatekeeper information and, optionally, a New User Registration Context ID.

The following diagram shows how the login sample page deployed with a Kiosk can be represented:

Deployment Example of New User Registration login sample page

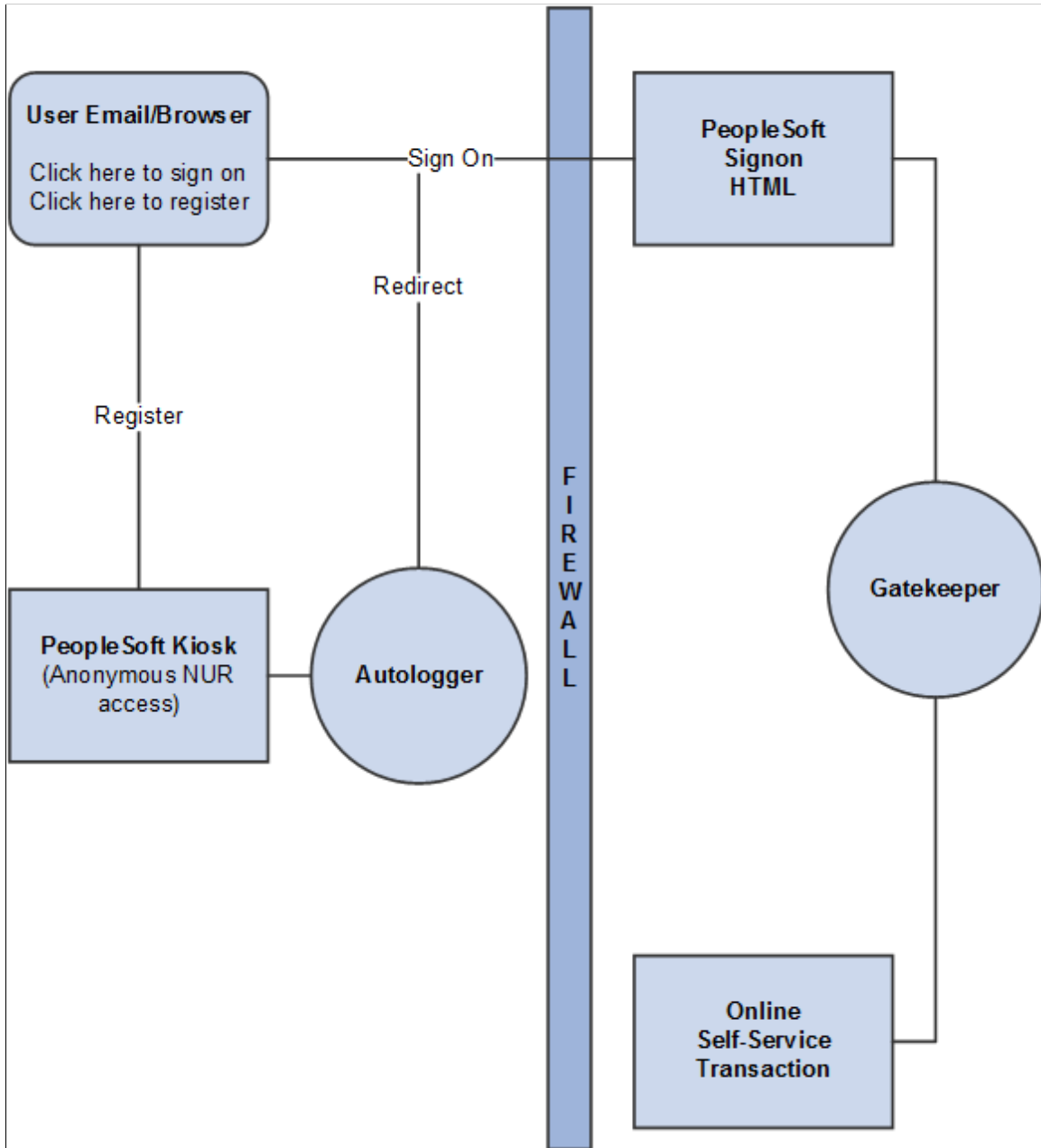

The self service Kiosk allows anonymous users access to the New User Registration page outside the firewall.

After an account is created, a user is authenticated via the standard PeopleTools login page. To allow for a seamless experience, the Autologger facilitates the automatic sign-on after account creation. In the case of account creation, the embedded URL (CAMPUS_URL) is used to retain information on the target page. The following diagram shows the orchestration and flow between the various components:

Orchestration of various New User Registration framework elements

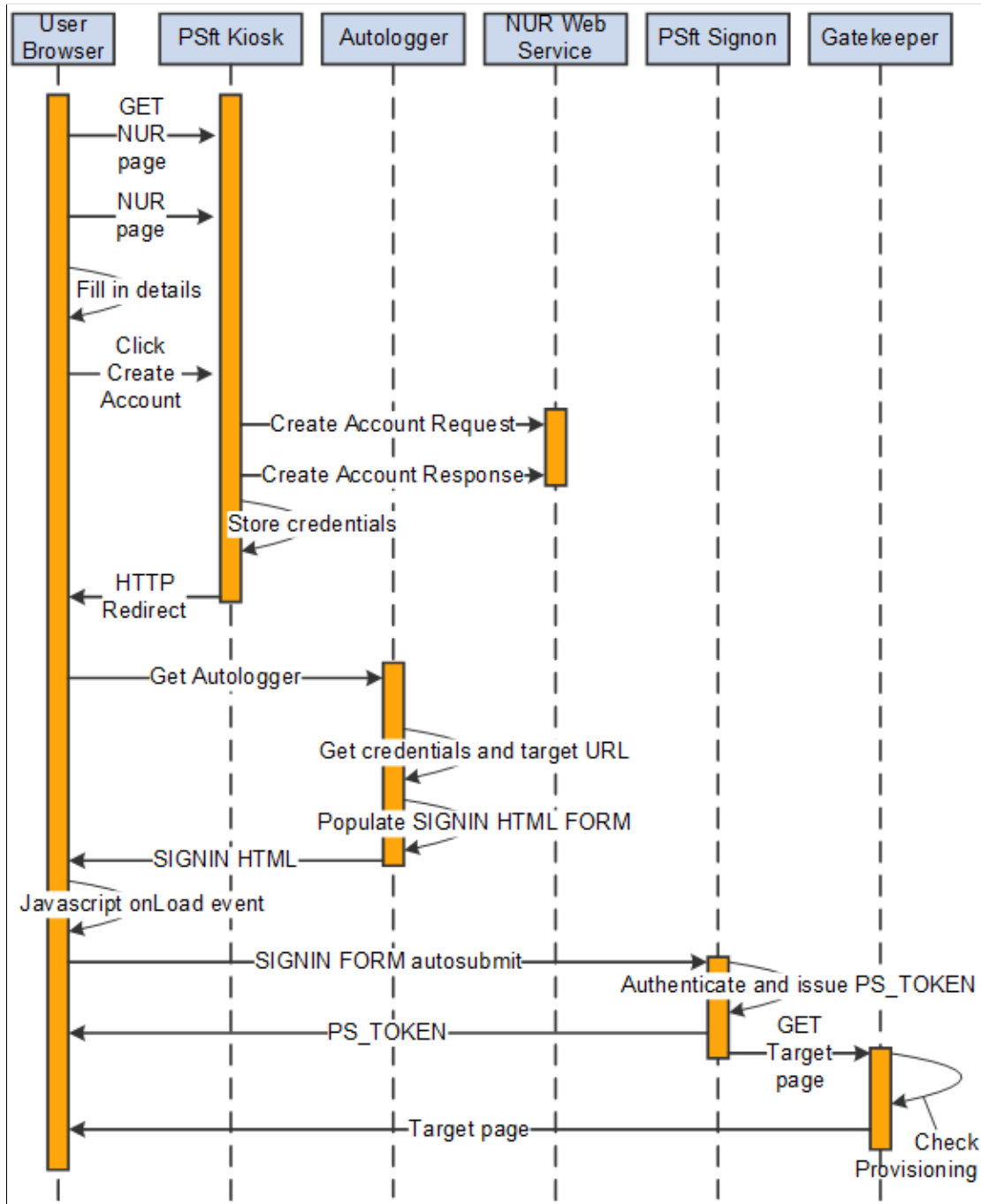

All sign-in related request and response processing should occur over a secure transport layer (SSL) until such a point as the PS_TOKEN cookie is issued to the browser.

Using the New User Registration Tester Page

The New User Registration Tester page is visually similar to the New User Registration login sample page, but has the following use and implementation differences:

- The page is deployed within your firewall (resides inside the production database). It is only for testing and evaluating the New User Registration framework. Your developers should use the tester page to review and understand the different pieces contained in the New User Registration framework.
- It is accessed by a system administrator (not by an end user) from a PeopleSoft menu navigation, not from a URL.
- The Autologger is replaced by the SwitchUser function. Because the page is contained in your system database and is accessed by a system administrator, the SwitchUser function signs off the administrative user ID to sign in the newly created user ID or the existing user ID you enter in the login page.
- Because a URL is not used, a New User Registration context ID is not specified. Instead, the New User Registration Tester page uses the New User Registration context ID you set with the Default field checked.
- Clicking the displayed language links do not change the language in which the newly created user or the returning user sees the system. Because the New User Registration Tester is first accessed by the system administrator, the SwitchUser function does not change the languages.

Note: The tester page is intended for testing purposes and should *not* be deployed in a production environment.

User Flow For a Returning User

1. Navigate to the New User Registration Tester page or access the New User Registration login sample page from a predefined URL.

This example illustrates the fields and controls on the New User Registration login sample page or Tester page. You can find definitions for the fields and controls later on this page.

Field or Control	Description
User ID	Provide an existing user ID.
Password	Provide the password.
Sign In	Click to sign into the system. The system validates whether the user ID and password match a valid user profile. If the validation passes without errors, the system triggers the SCC_USERREG_AUTHENTICATE service operation, auto logger, and gatekeeper.
Select a Language	Displays the list of languages supported by your system. The guest can select a language from this list in which he or she can view and use the PeopleSoft system, as well as locale formatting conventions for dates, times, and number.
Forgot your User ID	Click to access the Forgot my User ID page.
Forgot your password	Click to access the Forgot My Password page.

- The returning user enters the user ID and password, and clicks the Sign In button. This triggers the SCC_USERREG_AUTHENTICATE service operation, auto logger (or SwitchUser if the New User Registration Tester page is used) and gatekeeper.
- If the New User Registration login sample page is used, the new user is authenticated through the PeopleTools security logic to access your system. Because of that the user sees, for a few seconds, your regular login page pre-populated with the user ID and the password entered by the returning user. Below is an example of what the user sees if the delivered PeopleTools login page is used:

This example illustrates the fields and controls on the PeopleTools login page . You can find definitions for the fields and controls later on this page.

Depending on how you deploy the user registration page, you may want to replace this page with a message such as, “Please be patient while we are transferring you to our system.” To customize the message, you modify the HTML found in the SCC_PT_SIGNON.HTML object in application designer, then replace the text with the message: *Please be patient while we are transferring you to our system.*

You will view the main login page only when signing in through the New User Registration login sample page. If the New User Registration Tester page is used, you will not see it because the authentication is performed within the same database and you are signed into the system through the SwitchUser function.

- After successful authentication, the returning user is automatically signed into the system. If a New User Registration Context ID is known (whether it is passed through a URL if the New User Registration login sample page is used or a default New User Registration Context ID is identified in the case of the New User Registration Tester page), and security role(s) are listed, the system provisions the application level security role(s) defined. If the New User Registration Context ID includes a target page, the system transfers the returning user directly to the target page. Else, the system transfers the returning user to the application client’s home page.

User Flow For a Guest

1. Navigate to the New User Registration Tester page or access the New User Registration login sample page from a predefined URL. From these pages, the new user registration fields appear below the sign-in fields (under Create Account) and users without an existing user ID can directly register a new account.

If the New User Registration login sample page is used, then after pressing the Create Account button, the new user is authenticated through the PeopleTools security logic to access your system. Because of that the user sees, for a few seconds, your regular login page pre-populated with the user ID and the password entered by the guest. Below is an example of what the user sees if the delivered PeopleTools login page is used:

This example illustrates the fields and controls on the PeopleTools login page . You can find definitions for the fields and controls later on this page.

The screenshot shows the Oracle PeopleSoft Enterprise login interface. At the top center is the Oracle logo in red, with 'PEOPLESOFT ENTERPRISE' in black text below it. The main content area is divided into two sections. On the left, there is a login form with the following elements: 'User ID:' followed by an input field containing 'BSmith'; 'Password:' followed by an input field with seven dots; and a 'Sign In' button below the password field. On the right, there is a 'Select a Language:' section with a list of language links arranged in two columns. The first column includes: English, Dansk, Français, Italiano, Nederlands, Polski, Suomi, Čeština, 한국어, ไทย, 繁體中文, and UK English. The second column includes: Español, Deutsch, Français du Canada, Magyar, Norsk, Português, Svenska, 日本語, Русский, 简体中文, and العربية.

Depending on how you deploy the user registration page, you may want to replace this page with a message like: “Please be patient while we are transferring you to our system.” To customize the message, you modify the HTML found in the SCC_PT_SIGNON.HTML object in application designer, replace the text with the message: *Please be patient while we are transferring you to our system.*

You see the main login page only when signing in through the New User Registration login sample page. If the New User Registration Tester page is used, you do not see it because the authentication is performed within the same database and you are signed into the system through the SwitchUser function.

2. Clicking the Create Account button triggers the SCC_USERREG_CREATEACCT service operation, auto logger (or SwitchUser if the New User Registration Tester page is used), and gatekeeper.
3. After successful authentication, the new user is automatically signed into the system. If a New User Registration Context ID is known (whether it is passed through a URL if the New User Registration

login sample page is used or a default New User Registration Context ID is identified in the case of the New User Registration Tester page), and security role(s) are listed, the system provisions the application level security role(s) defined. If the New User Registration Context ID includes a target page, the system transfers the new user directly to the target page. Else, the system transfers the new user to the application client's home page.

The following table describes the registration fields in the New User Registration login sample or Tester page:

Field or Control	Description
Choose your User ID	<p>Enter a user ID.</p> <p>Some institutions might prefer to create user IDs by prefixing some letters, using their own algorithm (for example, an institution named PeopleSoft University may want their user IDs to start with the letters PU). No such algorithm is delivered with this sample user interface. If required, institutions can add logic to their user interface for user ID creation.</p>
Create a password and Confirm your password	<p>Enter a password.</p> <p>The system performs the validation when the user clicks the Create Account button.</p>

Field or Control	Description
Email Address, First Name and Last Name	<p>(Optional) Enter constituent information.</p> <p>If you select the Email Address check box in the New User Registration Installation page, you can require users to enter an email address.</p> <p>Although the SCC_USERREG_CREATEACCT service operation supports most of the constituent fields, the sample New User Registration login pages include only these three constituent fields. You can add more constituent fields if required, or remove fields if you do not want to gather constituent information at account creation time. The values that the guest enters in these constituent fields are stored in the constituent staging records. Additionally, the email address is also stored in the newly created user profile.</p> <p>The email address in the user profile is used in the Forgot User ID and Forgot Password utilities. Use the PeopleTools Schema page to access the SCC_ENTITY_CONSTITUENT schema (PeopleTools > Integration Broker > Integration Setup > Messages > Schema). Any attributes contained in the schema can be used in the registration page.</p> <p>The constituent information is stored in the CTM constituent staging tables and can be viewed using the Constituent Staging component under the CTM transaction code called NEW_USER_TRANSACTION. At this stage no EMPLID is assigned so the data cannot be promoted to the corresponding production tables. Staging the data allows retrieval from inside a subsequent CTM transaction. Because the subsequent transaction also stores the data in the CTM constituent staging tables, the self-service user does not have to enter the same information twice. For example, during registration or while performing the subsequent CTM transaction.</p> <p>See:</p> <ul style="list-style-type: none"> • Understanding New User Registration, “CTM and New User Registration” • Understanding CTM • Defining Installation Options for New User Registration

Field or Control	Description
Create Account	<p>Click to create your account.</p> <p>The system verifies whether the:</p> <ul style="list-style-type: none"> information in the Create a password and Confirm your password fields match. If they do not match, an error message appears. user ID exists in the PeopleTools security table (PSOPRDEFN record). information in the constituent fields is valid (for example, whether the email address is valid). <p>If the validation passes without errors, the system stores the constituent information in the CTM staging records and triggers the SCC_USERREG_CREATEACCT service operation.</p>

Using the Forgot User ID Utility

Click the **Forgot your User ID** link on the New User Registration login sample page or New User Registration Tester page.

Field or Control	Description
Enter your Email address	<p>Provide an email address. This is used to retrieve the user ID (OPRID).</p> <p>The email address you provide must match one and only one user ID in the system. If so, a successful message appears: <i>Your request was successful. Your User ID will be sent at the email address you entered.</i> If the email address is either associated to multiple user IDs or to no user ID, an error message appears: <i>We cannot retrieve your username at this time.</i></p>
Retrieve User ID	<p>Click to validate the email address. If the process locates the email address inside a user profile, it triggers the Notifications Framework to send an email message that contains the user ID.</p> <p>See Understanding the Notifications Framework.</p>
Return to the logon page	Click to cancel the process and return to the login page.

Note: Before you deploy this functionality and to enable users to invoke the Forgot User ID utility, all user IDs in your system must have an associated email address in the user profile. If user IDs are created using the SCC_USERREG_CREATEACCT service operation, make sure users are required to provide an email address when they create an account. To require users to provide an email address, select the **Email Address** check box in the New User Registration Installation page. The email address is used to retrieve the user ID and to send the email notification message that includes the user ID. The delivered New User Registration login sample page and New User Registration Tester page require the email address field to be populated at account creation time. This ensures that user IDs created through New User Registration have an email address stored in the user profile.

Related Links

[Developer Reference to Deploy New User Registration](#)

Using the Forgot Password Utility

Click the **Forgot your password** link on the New User Registration login sample page or New User Registration Tester page.

<i>Field or Control</i>	<i>Description</i>
User ID	Enter your user ID. This is used to retrieve the user's email address from the user's user profile so that the password can be regenerated and emailed to the user.
Continue	Click to access the Answer security question page. When you click Continue , the system validates whether the user ID has an associated email address in the user profile. The email address is used to send the new password. If no email address is found, the following message is sent: <i>A new password cannot be sent as no email address was found. Contact your system administrator.</i>

Note: Before you deploy this functionality and to enable users to invoke the Forgot Password utility, all user IDs in your system must have an associated email address in the user profile. If user IDs are created using the SCC_USERREG_CREATEACCT service operation, make sure users are required to provide an email address when they create an account. To require users to provide an email address, select the **Email Address** check box in the New User Registration Installation page. The email address is used to retrieve the user ID and to send the email notification message that includes the user ID. The delivered New User Registration login sample page and New User Registration Tester page require the email address field to be populated at account creation time. This ensures that user IDs created through New User Registration have an email address stored in the user profile.

See [Defining Installation Options for New User Registration](#).

Field or Control	Description
Question	<p>Shows the security question the user previously answered.</p> <p>If a security question has not previously been answered, the user cannot reset his or her password. The following error message appears: <i>A security question has not previously been answered. Contact your system administrator.</i></p> <p>As delivered with the generic PeopleTools security, a self-service user can answer a security question by going to Home page > My System Profile. In the General Profile Information page, click the Change or set up forgotten password help link. The user can select a security question and enter a response. This page is delivered with your system and security needs to be granted to all of your users. Alternatively, a simpler self-service version of this page could be created.</p>
Response	Enter the answer to the security question.
Email New Password	<p>Click to trigger the email template utility and auto-generate a temporary password.</p> <p>An email with a temporary password is sent only if the response to the security question is correct and there is an email address stored in the PSOPRDEFN.EMAILID field for the user ID that was provided. The password is automatically reset in the user’s profile (in the PSOPRDEFN table).</p> <p>The following is an example of an email message that might be sent to a user requesting his or her password to be reset:</p> <p><i>You are receiving this auto-generated email message because you requested your Campus Solutions password to be reset. Use the following temporary password: JMWFBUEU. Press this link or copy the below URL to access the system with your newly generated password. You will be requested to change the temporary password immediately. http://yourServer.yourDomain.com/psp/ps/EMPLOYEE/HRMS/s/WEBLIB_SCC_NUR.SCC_SS_GATEKEEPER.FieldFormula.IScript_SCC_GateKeeper?SCC_APPL_CONTEXT=SCC_NURCTXT_20130211110717</i></p>

See [Developer Reference to Deploy New User Registration](#), “Step 10: Configuring the Forgot Password Utility.”

Setting Up CTM for New User Registration

Access the Transaction Setup page (**Set Up SACR > System Administration > Utilities > Constituent Transaction Mgmt > Transaction Setup**).

This example illustrates the fields and controls on the Transaction Setup page - New User Registration. You can find definitions for the fields and controls later on this page.

Transaction Setup	
Transaction:	NEW_USER_REGISTRATION
*Transaction Name:	<input type="text" value="New User Registration"/>
Transaction Description:	<input type="text" value="New User Registration Transaction"/>
*Transaction Status:	<input type="text" value="Active"/>
Transaction Options	
<input checked="" type="checkbox"/> Online Transaction	<input checked="" type="checkbox"/> New User Registration
Transaction Handler	
*Root Package ID:	<input type="text" value="SCC_CTM"/>
*Path:	<input type="text" value="TRANSACTION"/>
*Application Class ID:	<input type="text" value="DefaultTransaction"/>
Transaction Status and Date	
*Staged Record Name:	<input type="text" value="SCC_STG_CONSTIT"/> Constituent
Constituent Handler	
*Root Package ID:	<input type="text" value="SCC_SL_TRANSACTION"/>
*Path:	<input type="text" value="INTFC"/>
*Application Class ID:	<input type="text" value="DefaultConstituent"/>

A New User Registration CTM transaction called NEW_USER_REGISTRATION is delivered with your system.

Verify the delivered and recommended setup for this transaction by accessing the CTM Transaction Setup page.

See [Setting Up CTM](#), “Setting Up a Transaction.”

Defining Installation Options for New User Registration

Access the New User Registration Installation page (**Setup SACR > System Administration > Utilities > New User Registration > New User Registration Install**).

This example illustrates the fields and controls on the New User Registration Installation page 1 of 2. You can find definitions for the fields and controls later on this page.

New User Registration Installation

Required values when creating an account

Email Address [Explain](#)

Construct Generic URL to access New User Registration login page

Communication Protocol

http:// (Hypertext Transfer Protocol)

https:// (Hypertext Transfer Protocol Secure)

New User Registration Constants ?

*Define Constants For: Tester URL

Tester URL ?

*CS Server Name: server

*CS Domain Name: us.oracle.com

CS Domain Port Number: 8000

*Servlet Name: psp

*CS PS Website Name: dbnamex

*Portal Name: EMPLOYEE

*Node Name: SA 🔍

*NUR Tester Content ID: SCC_NUR_TESTER.SCC_NUR_TESTER.GBL

*Content Parameter: &cmd=start?

This example illustrates the fields and controls on the New User Registration Installation page 2 of 2. You can find definitions for the fields and controls later on this page.

Production URL ?

CS Server Name 	Kiosk Server Name
CS Domain Name 	Kiosk Domain Name
CS Domain Port Number 	Kiosk Domain Port Number
Servlet Name 	
CS PS Website Name 	Kiosk PS Website Name
Portal Name 	
Node Name 	
Kiosk Content ID 	
Content Parameter 	
<input checked="" type="checkbox"/> Use Autologger	
Autologger: WEBLIB_SCC_NUR.SCC_SS_AUTOLOGGER.FieldFormula.IScript_SCC_AutoLogger	
Gatekeeper: WEBLIB_SCC_NUR.SCC_SS_GATEKEEPER.FieldFormula.IScript_SCC_GateKeeper?SCC_APPL_CONTEXT_ID	

Autogenerate Generic URLs URLs not auto generated. None of your users will be able to access your login page.

Generic URL

Tester URL

Production URL

User Data Encryption

Encryption Profile ID

Decryption Profile ID

986

Copyright © 1988, 2024, Oracle and/or its affiliates.

The New User Registration Installation page lets you define the install options that are required for New User Registration.

Required values when creating an account

Select the field you want to define as a required field in a New User Registration service operation.

Field or Control	Description
Email Address	<p>By default, this check box is deselected.</p> <p>Select this option if you want to require an email address to be entered when a user ID is created through the SCC_USERREG_CREATEACCT service operation. For example, when a user ID is created in the New User Registration sample login page or in the New User Registration Tester page. When you set the email address as a required field, users must enter an email address at account creation time.</p> <hr/> <p>Note: The email address entered at account creation time is used to populate the email address field in the newly created user profile. If you deploy the Forgot Password or Forgot User ID utility, an email address must exist in the user's profile.</p> <hr/>

Construct Generic URL to access NUR Logon Page

This group box contains information such as communication protocol and NUR constants (your environment parameters) that are necessary so the system can automatically generate a generic URL. The generic URL can be used to access the NUR sample login page or a custom version of it (production URL), or the NUR Tester page (tester URL) or both. The generic URLs, if a default NUR Context ID does not exist in your system, transfer the end user to the proper login page. Once the user is successfully authenticated, the user is transferred to the application home page. A specific application role level security is *not* provisioned and a transfer to an application-specific target page does not occur.

Communication Protocol

Specify the communication protocol prefix for the generic URL. By default, *https://* is selected. HTTPS ensures that the information that is transmitted over the network is secured through SSL/TLS.

New User Registration Constants

Use this group box to define the NUR constants that are needed to generate the Production and the Tester URLs.

Field or Control	Description
Define Constants For	<p>Select:</p> <ul style="list-style-type: none"> <p><i>None</i>. By default, this value is selected. Use this value when you do not want to define any URL.</p> <p>If you select this value, the Production and Tester URL group boxes are disabled.</p> <p><i>Both Production & Tester URLs</i> to specify the NUR constants for generating both the production and tester URLs.</p> <p>If you select this value, the Production and Tester URL group boxes are enabled.</p> <p><i>Production URL</i> to specify the NUR constants for generating the production URL to access the NUR login sample page.</p> <p>If you select this value, the Production URL group box is enabled, and the Tester URL group box is disabled.</p> <p><i>Tester URL</i> to specify the NUR constants for generating the tester URL to access the NUR Tester page.</p> <p>If you select this value, the Tester URL group box is enabled, and the Production URL group box is disabled.</p>

Tester URL

Use this group box to specify the NUR constants that are required to construct the URL that transfers a user to the NUR Tester page.

Field or Control	Description
CS Server Name	Enter the server name of the Campus Solutions database.
CS Domain Name	Enter the domain name of the Campus Solutions database.
CS Domain Port Number	Enter the port number that your Campus Solutions database domain uses.

Field or Control	Description
Servlet Name	<p>Define the type of content that is used to build URLs. By default, no value is selected.</p> <p>Select:</p> <ul style="list-style-type: none"> • psp for portal service type. <p>If you select <i>psp</i> and populate the Tester URL group box, the URL that is created transfers the user to the NUR Tester page and shows the left menu navigation. This is okay because the Tester URL is used for testing purposes.</p> <ul style="list-style-type: none"> • psc for content servlet type. <p>If you select <i>psc</i> and populate the Production URL group box, the URL that is created transfers the user to the NUR login sample page (or your custom version of the page) and hides the left menu navigation.</p>
CS PS Website Name (Campus Solutions PeopleSoft Website Name)	<p>Enter the name of the website that was used when PeopleSoft Internet Architecture (PIA) was installed to create your Campus Solutions database.</p> <p>If you selected the default values when you installed the database, then you must enter <i>ps</i>.</p>
Portal Name	Enter the name of the portal that is used to access the login page.
Node Name	Enter the name of the node that is used to access the login page.
NUR Tester Content ID	<p>Enter the location of the NUR Tester page. The page is located in SCC_NUR_TESTER.SCC_NUR_TESTER.GBL.</p> <p>If you haven't changed the location, enter SCC_NUR_TESTER.SCC_NUR_TESTER.GBL. Otherwise, enter the information by concatenating its menu name, component name and market.</p>
Content Parameter	Enter the query string parameter (name value pair) for the content. If you use PeopleTools as delivered, this value is "&cmd=start?" (without the quotes). This takes the user to the target page setup in the NUR Context ID mentioned in the URL.

Production URL

Use this group box to specify the NUR constants that are required to construct the URL that transfers a user to the NUR sample login page.

The fields in this group box are the same as the Tester URL, except for:

Field or Control	Description
Kiosk Server Name	Enter the server name of the environment where your kiosk is deployed.
Kiosk Domain Name	Enter the domain name of the environment where your kiosk is deployed.
Kiosk Domain Port Number	Enter the port number that your kiosk database domain uses.
Kiosk PS Website Name (Kiosk PeopleSoft Website Name)	<p>Enter the name of the website that was used when PeopleSoft Pure Internet Architecture (PIA) was installed to create your kiosk database.</p> <p>If you selected the default values when you installed the database, then you must enter <i>ps</i>.</p>
Kiosk Content ID	<p>Enter the location of the NUR sample login page (or your own custom version of it). The page is located in <code>SCC_NUR.SCC_NUR_REG.GBL</code>.</p> <p>If you haven't changed the location, enter <code>SCC_NUR.SCC_NUR_REG.GBL</code>. Otherwise, enter the information by concatenating its menu name, component name and market.</p>
Use Autologger	<p>By default, this check box is selected. If you deselect this check box, the Autologger field does not appear.</p> <p>The Gatekeeper uses this check box to decide whether to allow users to be automatically logged in to your production page when they log in through your Kiosk, or to request users to enter their login credentials before they access your production page.</p>
Autologger	This field does not appear if the Use Autologger check box is deselected. Otherwise, this field is view-only and displays the location of the Autologger that is used for NUR.
Gatekeeper	This field is view-only. It displays the location of the Gatekeeper that is used for New User Registration.

<i>Field or Control</i>	<i>Description</i>
Sign In Command	This field is displayed when the Use Autologger is deselected. If the delivered Autologger logic is not used, enter the interface details where your transfer logic is stored.

Autogenerate Generic URL

Click to create the URL for either the production or tester URLs, or both. The generated URLs appear in the appropriate URL field.

This button is enabled only when you specify values for the NUR constants or change the communication protocol and then save the page.

Note: After you save the page, you must click the Autogenerate Generic URLs button in order to populate the Tester URL and the Production URL. If you close the page without auto-generating URLs, your self-service users are unable to access your login page through a URL.

Generic URL

This group box contains the generic production and tester URLs based on the installation options you specified. The generic URLs are later used to construct the specific URLs when you set up a NUR context ID for a specific online transaction. If an online transaction does not need to use a NUR context ID, you can give your users the generic URL to transfer them to your regular homepage. In this case, roles are not provisioned or page transfers do not occur.

<i>Field or Control</i>	<i>Description</i>
Tester URL	This field is view-only. It displays the URL that your administrators can use to access the NUR Tester page. The tester page is used when you do not set up a kiosk, but want to test the URL with the tester page before you switch to production. The NUR Tester page can also be accessed by your administrators by navigating to Setup SACR > System Administration > Utilities > Sample User Interfaces > New User Registration Tester . Use the Tester URL to test your NUR Constants values and the NUR Context ID settings that are needed for a specific online transaction.
Production URL	This field is view-only. It displays the URL that your users can use to access the NUR login sample page or your custom version of the sample login page. The NUR login sample page is used when you set up a kiosk.

When you deploy a kiosk database, make sure the values you specify in the New User Registration Installation page are the same you enter in your production database.

User Data Encryption

Use this section to define the profile IDs you want to use for encryption and decryption of passwords for Create Account and User Authentication. Filling out these fields is optional. The profiles you will see are the ones you defined in **PeopleTools > Security > Define Encryption Profiles**.

For information, see *Securing Data with PeopleSoft Encryption Technology (PeopleTools: Security Administration)*.

Setting Up New User Registration Encryption Profiles

This section provides an example of how to set up a New User Registration (NUR) encryption profile, which uses PeopleSoft Encryption Technology (PET).

Generate a Key

Before you begin with the rest of the instructions, you need to generate keys for the algorithm keyset and encryption profile.

The key value in the keyset and Initialization Vector (IV) parameter in the encryption profile are not the same values. These values in the encryption profile should match their corresponding values in the decryption profile. The value is a hexadecimal (hex) string that begins with 0x and continues with hex digits for a particular length. A hex digit is a single character in the list 0-9 and a-f (lowercase). Both the IV and the key value have the same length. To determine the length of the key, you need the number of bits of the algorithm.

For example, the algorithm `aes_ks256_cbc_encrypt` requires a 256 binary digit (bit) key. Divide the key length by 4 to get the number of hex digits. For example, $256 / 4 = 64$. This means that you need a 64-character hex string for a 256-bit algorithm. Generate a random hex string of the necessary length, prepend the string with 0x, and this becomes your key. Create a separate key for the keyset and for the IV parameter (in Encryption Profile).

Here is an example of an algorithm to generate a hex string of a given length.

```
/* Generate a random hex key of the specified length */
Arg length
hexstring=''
Do While length > 0
  length = length - 1
  digitpos = random(0,15) + 1
  hexchar = substr('0123456789abcdef',digitpos,1)
  hexstring=hexstring||hexchar
End
Say hexstring
```

Load the Encryption Library

To load the library:

1. From the command prompt, locate the name of the encryption library for PET SSL. For example:

```
ls -al|grep -i 'pet'
```

You will see all libraries that contain the term `pet`.

2. To load this library, go to **PeopleTools > Security > Encryption > Load Encryption Libraries**.
 - Library ID: PSPETSSL
 - In Library File, enter `libpspetsl64.so`, for example. This is the PSPETSSL library.

Define Algorithm Chains

Define the algorithm chains for the following IDs:

- SCC_NUR_ENCRYPT_23A
- SCC_NUR_DECRYPT_23A

This example illustrates the fields and controls on the Algorithm Chain page for SCC_NUR_ENCRYPT_23A.

Algorithm Chain

Algorithm Chain ID SCC_NUR_ENCRYPT_23A

Algorithm Chain Description New User Reg Encrypt 23a

Algorithm Chain	Personalize Find	First 1-4 of 4	Last
Algorithm ID	Sequence		
<input style="width: 90%;" type="text" value="PSUnicodeToAscii"/>	<input style="width: 50%;" type="text" value="1"/>	+	-
<input style="width: 90%;" type="text" value="aes_ks256_cbc_encrypt"/>	<input style="width: 50%;" type="text" value="2"/>	+	-
<input style="width: 90%;" type="text" value="base64_encode"/>	<input style="width: 50%;" type="text" value="3"/>	+	-
<input style="width: 90%;" type="text" value="PSAsciiToUnicode"/>	<input style="width: 50%;" type="text" value="4"/>	+	-

Save
 Add
 Update/Display

1. Go to **PeopleTools > Security > Encryption > Algorithm Chains**.
2. For SCC_NUR_ENCRYPT_23A, use this information:
 - Algorithm Chain ID: SCC_NUR_ENCRYPT_23A
 - In Algorithm Chain Description, enter *New User Reg Encrypt 23a*.
 - In Algorithm Chains, enter these IDs in the following sequence:
 - PSUnicodeToAscii
 - aes_ks256_cbc_encrypt

- base64_encode
 - PSAsciiToUnicode
3. For SCC_NUR_DECRYPT_23A, use this information:
- Algorithm Chain ID: SCC_NUR_DECRYPT_23A
 - In Algorithm Chain Description, enter *New User Reg Decrypt 23a*.
 - In Algorithm Chains, enter these IDs in the following sequence:
 - PSUnicodeToAscii
 - base64_decode
 - aes_ks256_cbc_decrypt
 - PSAsciiToUnicode

Define the Algorithm Keyset

To define the keyset for encryption and decryption:

1. Go to **PeopleTools > Security > Encryption > Encryption Algorithm Keyset**.
2. Define the keyset for encryption:
 - a. Algorithm ID: aes_ks256_cbc_encrypt
 - b. In Keyset ID, enter *SCC_NUR_ENCRYPT_23A*.
 - c. Select *Use Entered Value*, then in Key Value, enter *0x<random 64 digit hex string>*.
You need to have generated a key value for your test. See [Generate a Key](#).
3. Define the keyset for decryption:
 - a. Algorithm ID: aes_ks256_cbc_decrypt
 - b. In Keyset ID, enter *SCC_NUR_DECRYPT_23A*.
 - c. Select *Use Entered Value*, then in Key Value, enter the same value that was used for encryption.

This example illustrates the fields and controls on the Algorithm Keyset page for SCC_NUR_ENCRYPT_23A.

The screenshot shows the 'Algorithm Keyset' configuration page. At the top, the 'Algorithm ID' is 'aes_ks256_cbc_encrypt'. Below this is a 'Keysets' section with a search bar containing 'SCC_NUR_ENCRYPT_23A'. There are two radio button options: 'Use Certificate Store Value' (unselected) and 'Use Entered Value' (selected). Under 'Use Certificate Store Value', there is a 'Certificate Alias' field and two radio buttons for 'Certificate' and 'Private Key'. Under 'Use Entered Value', there is a 'Key Value' field containing the hex string '0xf2ea1e2b5c34842866e18bc5a917d916ac6873c0f013cc4ff9a4d76ee5ece2a8'. At the bottom, there are four buttons: 'Save', 'Return to Search', 'Previous in List', and 'Next in List'.

Define the Encryption Profile

To define the encryption profile:

1. Go to **PeopleTools > Security > Encryption > Define Encryption Profile**.
2. For SCC_NUR_ENCRYPT_23A:
 - Encryption Profile ID: SCC_NUR_ENCRYPT_23A
 - In Algorithm Chain ID, enter *SCC_NUR_ENCRYPT_23A*.
 - In Description, enter *New User Registration Encrypt*.
 - In Parameter Value for IV, enter *0x<random 64 character hex string>*.
To generate the key, see [Generate a Key](#).
 - In Parameter Value for SYMMETRICKEY, use *SCC_NUR_ENCRYPT_23A*.
3. For SCC_NUR_DECRYPT_23A:

- Encryption Profile ID: `SCC_NUR_DECRYPT_23A`
- In Algorithm Chain ID, enter `SCC_NUR_DECRYPT_23A`.
- In Description, enter *New User Registration Decrypt*.
- In Parameter Value for IV, use the same value as the one for encrypt IV parameter (in step 2).
- In Parameter Value for SYMMETRICKEY, use `SCC_NUR_DECRYPT_23A`.

This example illustrates the fields and controls on the Encryption Profile page for `SCC_NUR_ENCRYPT_23A`.

Encryption Profile

Encryption Profile ID `SCC_NUR_ENCRYPT_23A`

*Algorithm Chain ID

Description

Parameters		Find	First	1-4 of 4	Last
Algorithm ID	PSUnicodeToAscii				Chain Sequence 1
Algorithm ID	aes_ks256_cbc_encrypt				Chain Sequence 2
Parameter Values		Find	First	1-2 of 2	Last
Parameter Name	IV			<input type="checkbox"/>	From Keyset
Parameter Value	<input type="text" value="0xc1c45516d4e7e86cdfbfe90257947283dbae23523e6f058b57257ab5f2ec334"/>				
Parameter Name	SYMMETRICKEY			<input checked="" type="checkbox"/>	From Keyset
Parameter Value	<input type="text" value="SCC_NUR_ENCRYPT_23A"/>				
Algorithm ID	base64_encode				Chain Sequence 3
Algorithm ID	PSAsciiToUnicode				Chain Sequence 4

(Test) Encrypt a String

To encrypt a string:

1. Go to **PeopleTools > Security > Encryption > Test Encryption Profile**.
2. Enter any sample text to be encrypted.
3. In Encryption Profile ID, use `SCC_NUR_ENCRYPT_23A`.
4. Click *Run Encryption Profile*.

The encrypted text appears.

This example illustrates the fields and controls on the Encryption Demo page for SCC_NUR_ENCRYPT_23A.

Encryption Demo

Encryption Profile ID:
 Run Encryption Profile

Text to be Encrypted:

Encrypted Text:
Z88qhZ8Tn1OgFaast4GLmo6P361MAgmnytUIVwjSI0n7A81ayE8OMLhVI40IURp7
eXm9SkzNNNo0spK3z5J68qA==

Save
Notify

(Test) Decrypt the Encrypted String

To decrypt the string:

1. Go to **PeopleTools > Security > Encryption > Test Encryption Profile**.
2. In Encryption Profile ID, use *SCC_NUR_DECRYPT_23A*.
3. Copy then paste the encrypted text you got when you encrypted a string in [\(Test\) Encrypt a String](#).
4. Click *Run Encryption Profile*.

Verify that the encrypted text shows the sample text you chose to encrypt.

This example illustrates the fields and controls on the Encryption Demo page for SCC_NUR_DECRYPT_23A.

Encryption Demo

Encryption Profile ID:
 Run Encryption Profile

Text to be Encrypted:

Encrypted Text:
Let us rejoice in this day that has been given unto us.

Setting Up New User Registration Context

Access the New User Registration Context page (**Set Up SACR > System Administration > Utilities > New User Registration > New User Registration Context**).

This example illustrates the fields and controls on the New User Registration Context page. You can find definitions for the fields and controls later on this page.

New User Registration Context

New User Registration Context ID SCC_NURCTXT_20120918102441

New User Registration Context

Description

Default:

***Status**

***Provisioning Context**

Role Name	Description	View Definition
1 CS - DA Proxy TermsCondit	CS - DA Proxy TermsConditions	View Definition

Target Page

URLID

Or:

Component Name Ss Cc Da Terms Con

Menu Name: Proxy Terms Conditions Menu

Menu Bar Name: Use

Item Name: Proxy Terms and Conditions

Page Name: Proxy Terms and Conditions Pg

Access Mode

***Node Name**

Context Specific URL

Tester URL: Active Customize URL

Production URL: Active Customize URL

Comments:

Create a NUR context ID only if the online self-service transaction requires the user to be either provisioned with application-specific security roles or needs to be transferred to a specific target page.

The NUR context ID is used by the NUR framework only when it is embedded in the URL you provide to your users to access your login page.

By default, once the New User Registration Installation page is populated the URL is automatically created for you. While you can directly provide the URL to your users, we recommend to programmatically retrieving the URL by evaluating which one is marked as Active.

Field or Control	Description
New User Registration Context ID	<p>Displays the unique ID that the system assigns when you add a NUR context.</p> <p>When you add a context, this field displays the value NOID until you save the record. When you save the new context, the field displays the ID that the system assigned to the context.</p> <p>By default, the context ID is automatically appended to the generic URLs you auto-generated in the NUR Installation page. The resulting URLs are then specific to the online self-service transaction. The NUR framework uses this value, which is embedded in the URL used to log in to your system, to assign the security roles and/or transfer the user to the target page accordingly.</p>
New User Registration Context	<p>Enter the name of the context for the NUR context ID. For example, if you create a NUR context ID so users can access your Admissions online application page, you could enter <i>Online Application</i>.</p>
Description	<p>Enter a longer description for the New User Registration context (50 characters).</p>
Default	<p>Select to mark the NUR context as default. Only one NUR context can be marked as default.</p> <p>The system uses the default NUR context when a NUR context is not passed in the URL that the user clicks to access the login page. When the NUR context is not passed, the system looks for the default NUR context ID.</p> <p>If the system does not find the default context ID or the default context ID is inactive, then the user is transferred to the home page and application-specific security roles are not provisioned.</p> <hr/> <p>Note: It is optional to pass the NUR context in the URL.</p> <hr/>
Status	<p>Select to set status. Default is <i>Active</i>.</p> <p>If the URL provided to your users to access your system refers to an inactive NUR context, then the URL is embedded with “No URL defined.” Your users are unable to access your login page.</p>

Field or Control	Description
Provisioning Context	<p>Select <i>Auto Provisioned</i> if context should be Public.</p> <p>When Auto Provisioned is selected, the guest or the returning user is provisioned with application role level security dynamically just-in-time by the Gatekeeper. The Gatekeeper gets these roles from the list of roles you select in the Security to Provision grid. After real-time provisioning, the user is redirected to the specified target page, if one is provided.</p>

(Optional) Security to Provision

Use this grid to define a list of security roles that are specific to the consuming self-service transaction (such as AAWS Online Application or Delegated Access) for which the New User Registration context is created. The roles that you enter in this grid are assigned only to the users who are successfully authenticated by the NUR framework for a specific consuming self-service transaction. These roles are assigned by the Gatekeeper to the user profile of the newly created user or the returning user after the user is successfully authenticated by your system.

Field or Control	Description
Role Name	<p>Select the application-level security role names that you want to provision the user’s profile going through the NUR framework with this NUR context. The prompt returns the roles set up in the PeopleTools Roles component (PeopleTools > Security > Permissions & Roles > Roles).</p> <p>If you specify a target page, make sure you enter a role name that grants access to the specified target page. Otherwise, the user is not transferred to the target page due to lack of security.</p>

(Optional) Target Page

Depending on the online self-service transaction that consumes NUR, it may make sense to transfer the user directly to a target page instead of making the user manually navigate to the desired page after successful authentication into the system. For instance, if you have deployed an online application self-service transaction, the system can direct the user to your Online Application homepage. In Delegated Access, the system should direct the proxy directly to the very first page that the proxy should access to take advantage of the delegated accesses (the Proxy Terms and Conditions page). The target page can also be an external URL.

If you do not identify the target page in this group box, the user is redirected to the application home page.

Field or Control	Description
URL	If the target page lies outside the PeopleSoft system, provide the URL to access the page. After successful authentication, the user is immediately transferred to the URL address.
Component Name, Menu Name, Bar Name, Item Name, Page Name	If the target page is built within the PeopleSoft system, list the menu objects to retrieve the proper page. If you are using an external UI that lies outside the PeopleSoft system (a URL ID), these fields are disabled.
Access Mode	Select the mode in which the target page, built within the PeopleSoft system, should open when the user is transferred to the target page. Applicable values are: Add, Correction, Update and Update All. See Access Mode field.
Node Name	This is a required field regardless of whether the target page is a URL or a PeopleSoft component name. Select the name of the local node defined for the database where the target page is located (for a typical installation, select your default local node). The default local node is defined in the Integration Broker Nodes component (PeopleTools > Integration Broker > Integration Setup > Nodes). The Gatekeeper uses this node to transfer the user to the specified target page. Your system includes the following NUR context IDs: <ul style="list-style-type: none"> • SCC_NURCTXT_20120918102441 - NUR_DELEGATED_ACCESS (used for Delegated Access functionality) • SCC_NURCTXT_20130211110717 - NUR_CHANGE_PASSWORD (used by the NUR Forgot Password utility) If you intend to use these contexts, you must update the Node Name from the default value 'LOCAL' to your local node name.

Access Mode field

If one of the roles you list in the Security to Provision grid includes a permission list that grants access to the component and menu names that are listed in the Target Page group box, make sure you select the action mode used in the permission list for the page name you select. For example, the image that illustrates the NUR Context page shows the role 'CS - DA Proxy TermsConditions'. This role contains a permission list that grants access to the SCC_DA_PROXY menu and the SS_CC_DA_TERMS_CON

component, which contains the page `SS_CC_DA_TERMS_CON`. When you open the page permission, the Actions selected is Update/Display. You should select Update.

This example illustrates the fields and controls on the Page Permissions page..

Page Permissions

SA_LEARNER_SERVICES / Home / Proxy Terms and Conditions

Pages			Actions
Personalize Find First 1 of 1 Last			
Panel Item Name	Authorized?	Display Only	<input type="checkbox"/> Add
Ss Cc Da Terms Con	<input checked="" type="checkbox"/>	<input type="checkbox"/>	<input checked="" type="checkbox"/> Update/Display
			<input type="checkbox"/> Update/Display All
			<input type="checkbox"/> Correction

Select All

Deselect All

If you did not list any roles, make sure you select an Action Mode for which the component was created. For example, the preceding graphic shows the component name `SS_CC_DA_TERMS_CON`. If you open this component using Application Designer, the Component Properties show that the possible Actions selected is Update/Display. In this case, you select Update.

This example illustrates the fields and controls on the Component Properties window.

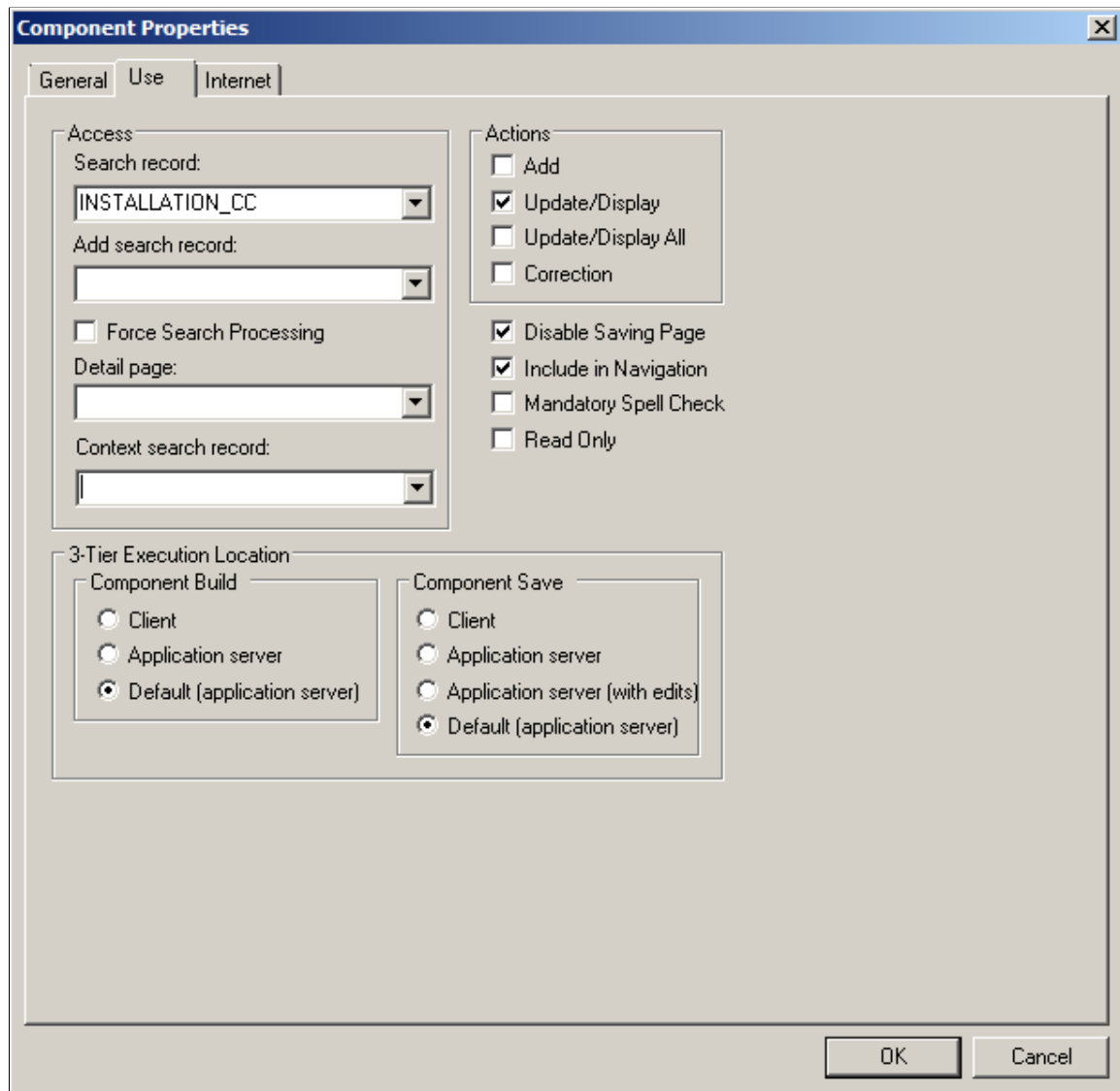

Context Specific URL

By default, the URLs that appear in this group box are the respective auto-generated URLs from the New User Registration Installation page appended with the NUR context ID that is specific to the NUR consumer. The Tester URL transfers the proxy to the NUR Tester login page and the Production URL transfers the user to the NUR sample login page or your own custom version of the page.

If you did not auto-generate the generic URL for any one of these fields, then these fields do not display any value.

If you select the corresponding Customize URL for any one of these fields, the field becomes editable and you can specify your own URL. For example, in the Production URL field you can specify the URL to your custom login page. You can specify your own URL even if you do not use the NUR framework.

The Active check box allows you to test the deployment of your online self-service transaction by selecting the Tester URL. When your self-service transaction is ready, make sure you set the Production

URL to Active. The Active check box allows you to test a new online self-service transaction while others may be in production.

The specific Production and Tester URL can be directly provided to your users to access (or test) your login page and do the proper authentication. However, it is recommended to programmatically retrieve the URL that is marked as Active. This way you will always be certain the URL is updated with the latest installation information. For example, if your Campus Solutions domain port number is modified in the New User Registration Installation page, the new port number will be automatically reflected in the specific URL.

By default, the Active and Customize URL check boxes for the Production and Tester URLs are deselected.

Only one URL can be active at any one time. Use the Tester URL only for testing the deployment of your online self-service transaction. When your self-service transaction is ready, make sure you come back to the NUR context ID settings to set the Production URL to Active.

Field or Control	Description
Production URL	<p>Displays the URL that is used to access the NUR sample login page or your custom version of the page.</p> <p>The production URL is used when you set up a kiosk for the production environment.</p> <p>If you select the:</p> <ul style="list-style-type: none"> Active check box for the Production URL, then the Active check box for the Tester URL is disabled. Customize URL check box for the Production URL, then the production URL can be edited; you can enter the URL of your choice.
Tester URL	<p>Displays the URL that is used to access the NUR Tester page.</p> <p>The tester URL is used when you do not set up a kiosk, but want to test the URL with the NUR Tester page before you switch to production.</p> <p>If you select the:</p> <ul style="list-style-type: none"> Active check box for the Tester URL, then the Active check box for the Production URL is disabled. Customize URL check box for the Tester URL, then the tester URL can be edited; you can enter the URL of your choice.

Related Links

[Step 7: Creating a URL to Access the New User Registration Login page](#)

Provisioning Access Through the Gatekeeper

The Gatekeeper is a Campus Solutions security utility that has the responsibility of dynamically provisioning application level security access and navigational orchestration to Campus Solutions pages or even navigation outside of Campus Solutions to a newly authenticated user. Prior to redirecting a user to a specific target page, the Gatekeeper is also responsible for validating that the self-service requestor is authorized (provisioned) to access a particular self-service application.

The New User Registration framework is PeopleTools web service based and therefore usable from any technology that supports SOAP over HTTP web service integration.

The Gatekeeper and New User Registration

The New User Registration framework, after having successfully authenticated a user to your system, uses the Gatekeeper to optionally perform the following two tasks:

1. Provisions the newly authenticated user with the security needed to perform the self-service transaction for which the user has signed in through New User Registration.
2. Transfers the newly authenticated user to the target page defined for the self-service transaction for which the user has signed in through New User Registration.

The application level provisioning is performed just-in-time. The user's user profile is being provisioned with the roles listed in the New User Registration Context ID used at the final moment when the user accesses the Campus system to perform a specific self-service transaction. Once provisioning is completed, if a target page is entered in the New User Registration Context ID, the Gatekeeper verifies the user has security access to the target page and if so, transfers the user.

The context in which the security role and the target page are defined is specific to the self-service transaction. The information is set up in the New User Registration Context setup page and stored under a New User Registration Context ID. The New User Registration Context ID is what the Gatekeeper needs to know to perform the security provisioning and the page transfer.

The use of the Gatekeeper within New User Registration is possible when the New User Registration login page is accessed from a launching point to perform a subsequent self-service transaction. For example, from your institution's web site, you could advertise that it is possible to apply online at your institution and display a Click here to apply link. The link URL must include:

- the content reference where the New User Registration login page is located so the user can be redirected to it
- gatekeeper information
- (optional) New User Registration context ID

From the launching point, the user is transferred to the New User Registration login page. Once successfully authenticated, New User Registration, through the Gatekeeper and the New User Registration Context ID passed in the URL, provisions the security role(s) related to the self-service transaction (for example, security role needed to access the Online Application page) and then transfers the user directly to the target page defined for performing the self-service transaction for which the user launched the New User Registration process. When no New User Registration Context ID is passed, the Gatekeeper uses the New User Registration Context ID you marked as the default.

Warning! When you deploy New User Registration framework, all the existing users you have in your system need to have access to the Gatekeeper in order to use their existing user ID to sign in through a New User Registration login page. The new users (the guest creating a user ID through New User Registration) are provisioned with the Gatekeeper security as part of the “basic provisioning” defined in the SCC_SS_TEMPLATE user ID.

Related Links

[Setting Up New User Registration Context](#)

[Step 1: Initial Setup for New User Registration](#)

[Step 7: Creating a URL to Access the New User Registration Login page](#)

[Step 8: Provisioning the Gatekeeper Permission List to all of Your Users](#)

Deploying New User Registration

This section presents some examples for deploying New User Registration. Institutions can adopt these examples, only pieces of it, or continue using their own security implementation (for example, with an identity management solution, LDAP or any other user management system).

The New User Registration login page should be accessed from where an unidentified user wants to perform a specific transaction that requires signing in to your system.

New User Registration can be triggered from a:

- Launching object on the institution’s web site. For example, a link, a button, or an image.
- URL sent through an email notification.

For example, if you deployed an Online Application self-service transaction, your portal may include a button or a link “Click here to apply online.” The URL you configure behind the button or the link can contain information to first transfer the future applicant to the New User Registration login page (or your custom version of it) prior to being transferred directly to your online application page. For these events to occur, the URL must contain information about which context the self-service transaction is performed. Another example for accessing the New User Registration login page is when a user receives an email notification and you include a link in the text so the user can easily sign in to your system and perform a specific transaction. Your system comes with the Delegated Access functionality that uses this deployment: proxies receive an email notification that instructs them how to access the system (includes a hyperlink), accept the terms and conditions, and review the access delegated by a specific person.

The underlying steps involved in providing an anonymous user access to your Campus Solutions system to perform a specific online transaction are as follows:

1. Use the New User Registration Installation page to generate the generic URL that you embed in the link, button, UI element, or email message. Optionally, if the online self-service transaction requires provisioning the newly authenticated user with application-specific security role or needs to transfer that same user to a specific target page, use the New User Registration Context page to automatically create a URL specific to that transaction.
2. Have your guests or returning users access the New User Registration login page by either:

- Sending them an email notification that contains the link to access your Campus Solutions system. The link is a URL that transfers users to your NUR login page.
 - Providing a button, link, or any other UI element in your portal or web site to invite users to perform a self-service transaction. The UI element is embedded with a URL that redirects users to your NUR login page. You can place the UI element on a website outside of your Campus Solutions system.
3. If users already have an account, they can use their existing account to sign in to your system. The authentication occurs through the NUR authenticate service operation, vanilla PeopleTools login page, or a federated login page.
 4. If users do not have an account, they can register a new account through the NUR login page. The user profile creation occurs through the NUR Create Account service operation. The NUR authenticate service operation authenticates users and, if authentication is successful, allows them to sign in.
 5. After a user is authenticated, the Gatekeeper interrogates the URL queryString parameter to determine which context (NUR context ID) the user requests access to. The Gatekeeper uses the user ID (OPRID) and a combination of the SCC_IDM_PROVISN and SCC_IDM_APPS tables to determine whether the user has been given access to the application or needs to be given just-in-time access.

 SCC_IDM_APPS contains the setup for the specific NUR context ID, or the setup for the NUR Context ID that is marked as default.

 SCC_IDM_PROVISN contains all the user profiles that have been previously provisioned a security role from a specific NUR Context ID.
 6. If a NUR context ID is found and it contains a security role that must be provisioned, the system calls the Campus Identity Manager provisionTran() API method. This method provisions the user profile with the roles contained in the NUR context ID in real time.
 7. If the NUR context ID also contains a target page, the Gatekeeper validates whether the user has the required security to access the target page. If so, the Gatekeeper transfers the user to the target page. Otherwise, an error appears and the user is not transferred.

Note: The New User Registration framework uses the PeopleTools security validation and authentication logic.

The following diagram illustrates where New User Registration (NUR) takes place when it is triggered from a button, link, or any other UI element located outside of your Campus Solutions system, for example, as part of your Online Application (AAWS) transaction; and when it is triggered from a link (a URL) in an email notification, for example as part of the Delegated Access (DA) process:

Example of a Self-Service Transaction using New User Registration

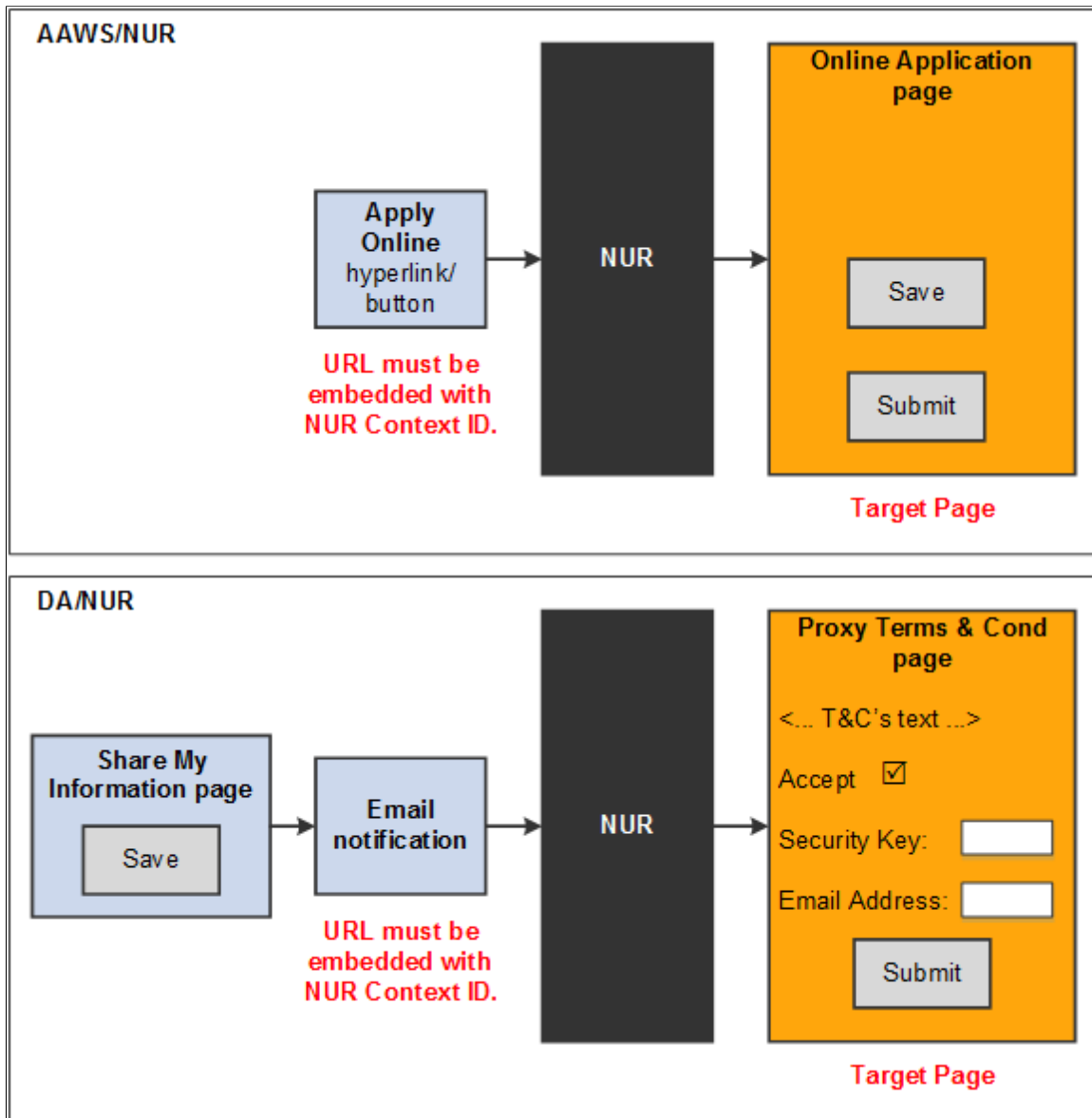

The diagram shows that NUR is considered a black box, independent from any logic specific to the online self-service transactions that are consuming it. New User Registration takes place before performing the self-service transaction. This is because within PeopleTools security management the security must be provisioned before a component is accessed.

The following describes the logic in the New User Registration black block.

1. Users click a link or button or any other user interface elements configured with a URL that is embedded with a NUR context ID (this link could be on the institution's website or in an email message).
2. The login page authenticates the user (and provides the option of creating a user account). An institution can implement this through the NUR service operations. After successful authentication or account creation, the gatekeeper provisions security defined in the NUR context ID that is passed, then redirects the user to the target page to perform the self-service transaction.

3. The user registration page should be publicly accessible to anonymous users.
4. The New User Registration web service operations inspect the SCC_IDM_PROVISN record to determine which applications the user has access to. The information is then returned to the user interface in the web service operation response message. The user interface may choose to use this information to assist in the user navigation. The <URL> attribute contains the link to access the target page specified for the NUR Context ID in the NUR Context setup page. For example, the following Create Account or Authentication service operation response message shows that the newly authenticated user should be transferred to the SS_CC_DA_TERMS_CON page, which is the target page for the Delegated Access application:

```
<NUR_REGISTRATION_CONTEXT>
  <SCC_APPL_CONTEXT_ID>SCC_NURCTXT_20120918102441</SCC_APPL_CONTEXT_ID>
  <SCC_APPL_CONTEXT>NUR_DELEGATED_ACCESS</SCC_APPL_CONTEXT>
  <URL>https://yourCSServerName.yourCSDomainName:1234/psc/ps/EMPLOYEE/HRMS/C/SC⇒
C_DA_PROXY.SS_CC_DA_TERMS_CON.GBL&amp;cmd=start?</URL>
</NUR_REGISTRATION_CONTEXT>
```

If you do use the NUR framework as it is delivered, you do not need to configure your user interface to read the response message in order to transfer your user to the proper target page. The Gatekeeper does it for you.

Note: The <URL> attribute is populated with the link to access the target page defined for the returned NUR Context ID. If the target page was defined as an external URL (a URLID was populated), the same value is populated between the tags. If the target page was defined as a PeopleSoft Architecture (PIA) page, then the link is constructed using the New User Registration Installation values entered for the Production URL and embedded with the specified target page.

5. If you do not use the NUR context and want to implement real-time application processing, then you must include the logic in your applications to call the Campus Identity Manager IDM interface method API, provisionApp(), to insert a row to the provisioning table, SCC_IDM_PROVISN. This could be done, for example, from an online component.
6. When a user is successfully authenticated, the URL that contains the context is processed. The Gatekeeper checks the provisioning context defined in the NUR context ID. These are the possible outcomes:
 - A NUR context ID does not exist. If this is the case, the Gatekeeper responds with an error that is equivalent to an HTTP 403 Forbidden response - Failed attempt.
 - A NUR Context ID exists with a target page defined, but the user does not have security access to the target page. In this case, the Gatekeeper responds with an error that is equivalent to an HTTP 401 Unauthorized response - Failed attempt.
 - A NUR Context ID exists with a target page defined and the user has security access to the target page. The Gatekeeper performs a lookup on the NURContext configuration table based on the supplied SCC_APPL_CONTEXT and responds with an HTTP redirect that is equivalent to a 407 Temporary redirect response - Successful attempt.
7. At this point, control falls within the domain of the individual application.

If an application requires further real-time transaction-level provisioning, then you must include a logic in the application to call the Campus Identity Manager IDM interface method (API,

provisionTran(), to insert a row in the SCC_IDM_PROVISN provisioning table. This could be done, for example, from an online component.

Developer Reference to Deploy New User Registration

Step 1: Initial Setup for New User Registration

To create user accounts, New User Registration requires two pre-defined user profiles set with the following user IDs: SCC_GUEST and SCC_SS_TEMPLATE.

Once created, those user profiles can be used as templates to grant your guests basic security access to your PeopleSoft system.

To be provisioned with application level security and transfer to a specific target page, the newly created user ID must be provisioned with a security role granting access to the Gatekeeper.

Creating a Role

You must create a role that contains security access to the security objects that is needed to use New User Registration (e.g. Gatekeeper and Forgot Password/Forgot User ID utilities). To create the role, use the Roles component (**PeopleTools > Security > Permissions & Roles > Roles**), then enter the following information:

<i>Field</i>	<i>Value</i>
Role Name	<name of your choice. E.g. 'CS - NUR GateKeeper'>
Description	<description of your choice>

Field	Value
<p>Permission Lists</p>	<p>HCCPCSSA1200 - CS NUR GateKeeper. This permission list is delivered with your system. It grants security access to generic NUR objects:</p> <ul style="list-style-type: none"> • Web library: WEBLIB_SCC_NUR. This web library contains the following permissions and access should be set accordingly: <ul style="list-style-type: none"> • SCC_SS_AUTOLOGGER.FieldFormula.IScript_SCC_AutoLogger = Full Access • SCC_SS_GATEKEEPER.FieldFormula.IScript_SCC_GateKeeper = Full Access • SCC_SS_GATEKEEPER.FieldFormula.IScript_SCC_setPSToken The function is set with Access Permissions = No Access. • Page access <ul style="list-style-type: none"> • Menu Name = SCC_NUR • Component Name = SCC_NUR_REG (contains the delivered sample NUR Sample login page) • Web services used for generic registration and authentication logic <ul style="list-style-type: none"> • SCC_USERREG_AUTHENTICATION (Full Access) • SCC_USERREG_CREATEACCT (Full Access) <p>HCCPCSSA1210 - CS NUR Utilities. This permission list is delivered with your system. It grants security access to optional NUR utilities such as Forgot Password and Forgot User ID:</p> <ul style="list-style-type: none"> • Page access to the PeopleTools delivered ‘Change My Password’ <ul style="list-style-type: none"> • Menu Name = MAINTAIN_SECURITY • Component Name = CHANGE_PASSWORD • Web services used for the Forgot Password and the Forgot User ID utilities: <ul style="list-style-type: none"> • SCC_USERREG_GET_PASSWORD (Full Access)

Field	Value
	<ul style="list-style-type: none"> • SCC_USERREG_GET_USERID (Full Access) • SCC_USERREG_GET_PSWD_HINT (Full Access) • Component Interface: SCC_NUR_EMAIL_PSWD <ul style="list-style-type: none"> • Cancel – Full Access • Find – Full Access • Get – Full Access • Save – Full Access • Component Interface: USERPROFDIST_ADD_CI <ul style="list-style-type: none"> • Cancel – Full Access • Find – Full Access • Get – Full Access • Save – Full Access • Component Interface: USERPROFDIST_UPD_CI <ul style="list-style-type: none"> • Cancel – Full Access • Find – Full Access • Get – Full Access • Save – Full Access • Allow Password to be Emailed = ‘Y’ (used for the Forgot Password utility).
Role Grant	Any role which includes permission lists which allow NUR Gatekeeper access and is used to grant security access to other roles must include Role Grant definitions.

See *PeopleTools: Security Administration*, “Implementing Distributed User Profiles”.

Creating SCC_GUEST user ID

In PeopleTools 8.5+, any anonymous inbound request originates from the ANONYMOUS node. For example, when a guest (unknown person) requests for a user ID, the user registration service operation associates the request with the ANONYMOUS node.

To enable anonymous access to Campus Solutions web services in a secure fashion, the PeopleSoft system, by default, associates all anonymous requests with a default account: SCC_GUEST. Therefore, to use New User Registration, you need to set up a default user profile that has minimal system access. This default user profile should be set with the User ID SCC_GUEST.

To create the SCC_GUEST account, use the User Profiles component (**PeopleTools > Security > User Profiles > User Profiles**) and enter the following information:

Field or Control	Description
User ID	SCC_GUEST
Symbolic ID	<As defined for your institution>
Password	<password of your choice>
Confirm Password	<password of your choice>
Language Code	<Language of your choice>
ID Type	None
Role Name	<p>PeopleTools and Standard Non-Page Permissions and either CS – NUR GateKeeper or the role name you created above to grant access to the New User Registration Gatekeeper.</p> <hr/> <p>Note: The anonymous user needs access to a role that contains the permission list HCCPCSSA1210 – CS NUR Utilities. In this way, the anonymous user can use the Forgot User ID and Forgot Password utilities.</p> <hr/>

Perform the following steps to update the ANONYMOUS Integration Broker node:

1. Access the Node Definitions page (**PeopleTools > Integration Broker > Integration Setup > Nodes**), and select Node Name *ANONYMOUS*.
2. In the Node Definitions tab, ensure that Node Type is set to *External*, the Default User ID is set to *SCC_GUEST*, and the Active Node and Segment Aware options are selected.
3. In the WS Security tab, enable WS-Security for this node by selecting an authentication token type (for instance Username Token).

Note: It is assumed that you have performed and validated all the basic Integration Broker setups prior to setting up the node. See *PeopleTools: Integration Broker* for information on Integration Broker gateway setup and service configuration.

Creating SCC_SS_TEMPLATE User ID

After successfully processing the user registration request, the user registration service operation creates a new account for the user. In other words, the service operation creates a PeopleTools user profile for the guest. The service operation uses the template account SCC_SS_TEMPLATE to clone its security setup and create a new account for the guest.

Create the SCC_SS_TEMPLATE account and assign any common default values that your institution wants new users to automatically receive when registering. To be authenticated to your system through New User Registration, the new user needs to have access to the Gatekeeper. Add to this user ID template the role you created above to grant access to the Gatekeeper.

To create the SCC_SS_TEMPLATE account, use the User Profiles component (**PeopleTools > Security > User Profiles > User Profiles**) and enter the following information:

Field or Control	Description
User ID	Enter <i>SCC_SS_TEMPLATE</i> .
Symbolic ID	<As defined for your institution>
Password	<password of your choice>
Confirm Password	<password of your choice>
Language Code	<Language of your choice>
Navigator Homepage	Enter <i>HCSPNAVHP</i> .
Process Profile	Enter <i>HCSPPRFL</i> .
Primary	Enter <i>HCPPALL</i> . Identifying a Primary Permission List is needed for personal data information getting its security information from there. For example, Citizenship, Visa Permit, Demographic Data Access (DDA), and so on.
Row Security	Enter <i>HCDPALL</i> .
ID Type	None

Field or Control	Description
Role Name	<p>Examples: PeopleSoft User, Standard Non-Page Permissions and either CS – NUR GateKeeper or the role name you created above to grant access to the New User Registration Gatekeeper. Also, add any other roles you want to grant access your guests at the moment of registering.</p> <p>Make sure the role names you include in this generic user ID template only grant access to basic components and security objects to access your PeopleSoft Campus Solutions system. The role names provided here are only examples.</p>

Warning! The information given in the grid above related to SCC_SS_TEMPLATE role assignment and configuration are for use only in a testing or demo environment. Before migrating your transaction setup and the web services to a production environment, it is recommended that you complete a thorough analysis of your institution's security requirements.

It is also recommended that you allocate the SCC_SS_TEMPLATE user ID only a minimal amount of system access that is required to execute the needed web services for your self-service transactions. You define Web Services access under **PeopleTools > Security > Permissions & Roles > Permission Lists > Web Services**. For instance, any roles that you assign to the SCC_SS_TEMPLATE should contain at least a Permission List that has access to the following web services:

Web Services	Service Operations	Access	Definition
<custom services>	<custom service operations>	Full Access	<p>Web services you created to perform your self-service transactions.</p> <p>For example, to perform the AAWS online application transactions, select Service <i>SAD_ADMISSIONS</i> and select Full Access to each of the service operations. If you setup a transaction for Delegated Access, select Service <i>SCC_DA</i> and select Full Access to each of the service operations.</p>
SCC_USERREG	SCC_USERREG_AUTHENTICATE SCC_USERREG_CREATEACCT	Full Access	Web services to use New User Registration and User Authentication.

Web Services	Service Operations	Access	Definition
SCC_LOV	SCC_GET_LOV	Full Access	Optional. Web service to use List of Values.
SCC_SM_SERVICE	SCC_SM_SERVICE_SYNC	Full Access	Optional. Grant access only if you use External Search/Match.
SCC_SM_FETCH	SCC_SM_FETCH_SYNC	Full Access	Optional. Grant access only if you use External Search/Match.

Similarly, any roles that you assign to the SCC_SS_TEMPLATE user ID template should contain at least a Permission List that has access to the following HCM component interfaces that are required to operate these services (which are used by CTM to access the HCM Person data):

- HCR_EMPLOYEE_CHECKLIST_SRV
- HCR_IDENTIFICATN_DATA_SRV
- HCR_JOB_DATA_POI_SRV
- HCR_MIL_EE_TRK_SRV
- HCR_NAMES_OTHER_SRV
- HCR_PERSONAL_DATA_SRV

Assigning Specific Security Roles to a User

Because different online transactions integrated with New User Registration can have their own security needs, each online transaction can define these roles in the New User Registration Context page.

See Step 3: Defining New User Registration Contexts.

Step 2: Validating the CTM Transaction Delivered for New User Registration

See Setting Up CTM for New User Registration.

(Optional) Step 3: Defining New User Registration Contexts

For each of the online transactions you want to integrate with New User Registration, create a New User Registration Context ID or create a New User Registration Context ID that serves as default.

See [Setting Up New User Registration Context](#).

Step 4: Designing Your Registration or Login page

See [Using the New User Registration Sample User Interfaces](#).

Step 5: Setting Up a Kiosk

Set up the following on the database of the Kiosk:

- The User Exception check box needs to set on the Routing Definition page of the Kiosk. When the check box is selected, in case an error is encountered during processing it allows the system to capture the SOAP fault and display it. Else, when the check box is not selected the system responds with a HTTP 500 error. To access the Routing Definition page, select **PeopleTools > Integration Broker > Integration Setup > Routings**.

This example illustrates the fields and controls on the Routing Definitions page. You can find definitions for the fields and controls later on this page.

The screenshot displays the 'Routing Definitions' page with the following fields and controls:

- Routing Name:** -IMPORTED~12317
- *Service Operation:** SCC_USERREG_CREATEACCT
- Version:** V1
- *Description:** Imported service operation
- Comments:** (Empty text area)
- *Sender Node:** S900P20
- *Receiver Node:** WSDL_NODE
- Operation Type:** Synchronous
- Owner ID:** (Empty dropdown menu)
- *Log Detail:** Header and Detail
- Active:**
- System Generated:**
- User Exception:**
- Graphical View:** [Graphical View](#)
- Save:** (Yellow button)

Navigation tabs at the top: [Routing Definitions](#) | [Parameters](#) | [Connector Properties](#) | [Routing Properties](#)

Footer navigation: [Routing Definitions](#) | [Parameters](#) | [Connector Properties](#) | [Routing Properties](#)

- Verify that the gateway is active. To access the Gateways page, select **PeopleTools > Integration Broker > Configuration > Gateways**.

This example illustrates the fields and controls on the Gateways page. You can find definitions for the fields and controls later on this page.

Gateways

Gateway ID LOCAL [Inbound Gateways](#)

Local Gateway Load Balancer

URL [Ping Gateway](#)

[Gateway Setup Properties](#)

[Load Gateway Connectors](#)

Connectors				Personalize Find		First	1-10 of 10	Last
	*Connector ID	Description	*Connector Class Name	Properties	+	-		
1	AS2TARGET		AS2TargetConnector	Properties	+	-		
2	EXAMPLETARGETCONN		ExampleTargetConnector	Properties	+	-		
3	FILEOUTPUT		SimpleFileTargetConnector	Properties	+	-		
4	FTPTARGET		FTPTargetConnector	Properties	+	-		
5	GETMAILTARGET		GetMailTargetConnector	Properties	+	-		
6	HTTPTARGET		HttpTargetConnector	Properties	+	-		
7	JMSTARGET		JMSTargetConnector	Properties	+	-		
8	PSFT81TARGET		ApplicationMessagingTargetConnector	Properties	+	-		
9	PSFTTARGET		PeopleSoftTargetConnector	Properties	+	-		
10	SMTPTARGET		SMTPTargetConnector	Properties	+	-		

Press the Ping Gateway button to make sure the gateway is active. The Status displays ACTIVE.

Note: The gateway needs to be active on both the Kiosk as well as the production environments.

- Verify that the setup target location is configured. To access the Target Locations page, select **PeopleTools > Integration Broker > Configuration > Service Configuration**. In the Service Configuration tab, click the **Setup Target Locations** link.

This example illustrates the fields and controls on the Target Locations page. You can find definitions for the fields and controls later on this page.

Target Locations

Web Services Target Locations

***Target Location**

Example http://<machine>:<port>/PSIGW/PeopleSoftServiceListeningConnector

Alternate Example http://<machine>:<port>/PSIGW/PeopleSoftServiceListeningConnector/<defaultlocalnode>

Secure Target Location

Example https://<machine>:<port>/PSIGW/PeopleSoftServiceListeningConnector

Alternate Example https://<machine>:<port>/PSIGW/PeopleSoftServiceListeningConnector/<defaultlocalnode>

REST Services Target Locations

Target Location

Example http://<machine>:<port>/PSIGW/RETLISTENINGCONNECTOR

Alternate Example http://<machine>:<port>/PSIGW/RETLISTENINGCONNECTOR/<defaultlocalnode>

Secure Target Location

Example https://<machine>:<port>/PSIGW/RETLISTENINGCONNECTOR

Alternate Example https://<machine>:<port>/PSIGW/RETLISTENINGCONNECTOR/<defaultlocalnode>

- Verify that you can ping the node. To access the Connectors page, select **PeopleTools > Integration Broker > Integration Setup > Nodes > Connectors**. From the Connectors page, press the Ping Node button.

Click the Ping Node button to verify the results. Make sure Message Text shows *Success*.

This example illustrates the fields and controls on the Connectors page. You can find definitions for the fields and controls later on this page.

Node Definitions
Connectors
Portal
WS Security
Routings

Node Name Your node name

Details

Gateway ID: PeopleSoft Nodes are configured via the [Gateway Setup Properties](#)

Connector ID:

***Delivery Mode:**

This connector does not have properties. Use Gateways Page to setup.

- During the consume web services step ensure that the Build Documents Message check box is cleared. To access the Consume Web Services wizard, select **PeopleTools > Integration Broker > Web Services > Consume Web Service**.

This example illustrates the fields and controls on the Consume Web Service Wizard page. You can find definitions for the fields and controls later on this page.

Consume Web Service Wizard **Step 1 of 8**

1 2 3 4 5 6 7 8 Next >

Select WSDL Source

Select the source of the WSDL you would like to consume.

WSDL Sources

- UDDI
- WSDL URL
- WSIL URL
- File
- Legacy WSDL (Prior to 8.48)
- Build Document Messages

- Verify that schema exists for the imported message. To access this schema, first navigate to the General page of the service operation (**PeopleTools > Integration Broker > Integration Setup > Service Operations**), then click the **View Message** link for the message, and finally click the Schema tab.

This example illustrates the fields and controls on the Schema page. You can find definitions for the fields and controls later on this page.

Message Definition
Schema

Message: M269733502

Version: V1

Updated: 09/03/2012 1:42:44AM

Edit Schema
Delete Schema

Schema:

```
<?xml version="1.0"?>
<xs:schema elementFormDefault="qualified" targetNamespace="http://xmlns.oracle.com/Enterprise/HCM/services" xmlns:xs="http://www.w3.org/2001/XMLSchema">
  <xs:include schemaLocation="SCC_ENTITY_CONSTITUENT.V1.xsd"/>
  <xs:element name="SCC_UR_CREATEACCT_REQ">
    <xs:complexType>
      <xs:sequence>
        <xs:element maxOccurs="1" minOccurs="1" name="SCC_USERNAME" type="xs:string"/>
        <xs:element maxOccurs="1" minOccurs="1" name="SCC_PASSWORD" type="xs:string"/>
        <xs:element maxOccurs="1" minOccurs="1" name="SCC_CONFIRMPWD" type="xs:string"/>
        <xs:element maxOccurs="1" minOccurs="0" name="SCC_ENTITY_INST_ID"
type="xs:string"/>
        <xs:element maxOccurs="1" minOccurs="1" ref="CONSTITUENT"/>
      </xs:sequence>
    </xs:complexType>
  </xs:element>
</xs:schema>
```

[Message Definition](#) | [Schema](#)

Step 6: Ensuring that the New User Registration Web Services are Running

Use the Provide Web Service page to publish the SCC_USERREG web service (**PeopleTools** > **Integration Broker** > **Web Services** > **Provide Web Service**).

New User Registration includes the SCC_USERREG web service with the following service operations:

- SCC_USERREG_AUTHENTICATE
- SCC_USERREG_CREATEACCT
- SCC_USERREG_GET_PASSWORD
- SCC_USERREG_GET_PSWD_HINT
- SCC_USERREG_GET_USERID
- SCC_CHECK_AUTH

Note: Activate this *only* if you use Simplified Campus Experience

See the product documentation for *PeopleSoft Integration Broker*.

Step 7: Creating a URL to Access the New User Registration Login page

The URL triggers the NUR framework. It transfers your anonymous users to your New User Registration login page. To facilitate the consumption of the NUR framework, you can use the New User Registration Installation page to automatically generate the URL. The URL is embedded with the environment information you specify as well as the logic that the NUR framework provides. For example, the autologger and gatekeeper information. You use the New User Registration Installation page, and, optionally, the New User Registration Context page to configure the NUR constants, and activate the Production or Tester URL. Use the Production URL if you are ready to deploy your online transactions, and the Tester URL to test your online transactions.

You can hardcode the URL in your applications, although it is recommended to use logic to dynamically refer to the URL. As part of the NUR framework, the application class `SCC_IDENTITY_MGR.UTIL.NURConstants` contains the logic to use the URL that you specify as Active in the New User Registration Context page. To see an example of how the application class is extended, see the Delegated Access application class `SCC_DA.NOTIFICATION.NOTIFY.OnExecute`. In this application class, the NUR context ID for Delegated Access is hardcoded: `SCC_NURCTXT_20120918102441`. The method `ActiveAutoGenURL` is implemented to retrieve the proper URL that you would include in an email message. For Delegated Access, an email message is sent to the proxies to inform them how to access the school system. It includes the URL (a hyperlink) that is also dynamically retrieved.

When you dynamically refer to the URL, it ensures that if there are any changes to the New User Registration constants, the current URL is always retrieved. It also allows you to easily switch between your Tester URL and Production URL.

See product documentation for *PeopleTools: Portal Technology*, *Configuring the Portal Environment*, *Understanding Web Profiles*.

Related Links

[Defining Installation Options for New User Registration](#)

[Setting Up New User Registration Context](#)

[Understanding New User Registration](#)

Step 8: Provisioning the Gatekeeper Permission List to all of Your Users

The permission list `HCCPCSSA1200 - CS NUR GateKeeper` is used to access the Gatekeeper. Add this permission list to a role that you want to assign to all of your users that could potentially register with your system through a New User Registration login page. For example, students, alumni, applicants, and so on.

The `HCCPCSSA1200` permission list grants access to the web library `WEBLIB_SCC_NUR`.

This example illustrates the fields and controls on the HCCPCSSA1200 Web Service Permissions Page.

Web Service Permissions

Service: SCC_USERREG

Service Operation	Access
SCC_USERREG_GET_PASSWORD	Full Access
SCC_USERREG_GET_PSWD_HINT	Full Access
SCC_USERREG_GET_USERID	Full Access
SCC_CHECK_AUTH	No Access
SCC_USERREG_AUTHENTICATE	No Access
SCC_USERREG_CREATEACCT	No Access

OK Cancel

The web library grants access to the following permissions:

This example illustrates the fields and controls on the WEBLIB_SCC_NUR Weblib Permissions Page.

Weblib Permissions

WEBLIB_SCC_NUR

Web Library Permission	*Access Permissions	View Content References for this Script
SCC_SS_AUTOLOGGER.FieldFormula.IScript_SCC_AutoLogger	Full Access	View
SCC_SS_GATEKEEPER.FieldFormula.IScript_SCC_GateKeeper	Full Access	View
SCC_SS_GATEKEEPER.FieldFormula.IScript_SCC_setPSToken	No Access	View

Having security access to the Gatekeeper allows your existing users to sign in through New User Registration login page with an existing user ID and password, and take advantage of the Gatekeeper functions. For example, automatic application level provisioning and page transfer after successfully signing into your system. If users do not have access to the Gatekeeper, they see the following error after they are authenticated: *Not Authorized*.

If you implement the New User Registration Forgot Password and Forgot User ID utilities, your existing users also need to have access to the HCCPCSSA1210 permission list. This permission list grants access to the web services that are needed for the Forgot Password and Forgot User ID utilities.

This example illustrates the fields and controls on the HCCPCSSA1210 Web Service Permissions Page.

Web Service Permissions

Service: SCC_USERREG

Service Operation	Access
SCC_USERREG_GET_PASSWORD	Full Access
SCC_USERREG_GET_PSWD_HINT	Full Access
SCC_USERREG_GET_USERID	Full Access
SCC_USERREG_AUTHENTICATE	No Access
SCC_USERREG_CREATEACCT	No Access

Full Access (All)

No Access (All)

OK Cancel

For guest users, create a new role that exclusively contains the HCCPCSSA1200 permission list. Also, when you implement the New User Registration Forgot Password and Forgot User ID utilities, include the HCCPCSSA1210 permission list. Add this role to the SCC_SS_TEMPLATE user ID. By default, the guest is provisioned with all the security setup inside that user ID.

Related Links

[Step 1: Initial Setup for New User Registration](#)

Step 9: Configuring the Forgot User ID Utility

To configure the Forgot User ID Utility:

1. Store email addresses in the PSOPRDEFN.EMAILID and PSUSEREMAIL.EMAILID records where PRIMARY_EMAIL = 'Y'.

To take advantage of the Forgot User ID utility, all users *must* have an email address stored in their user profile. When users forget their user ID, they are asked to enter their email address. The email address is matched to the one stored in your system. This email address must match *only* one user profile stored in your system.

You can require users that are created through the SCC_USERREG_CREATEACCT service operation to enter an email address. For example, guests who create their own account using the New User Registration login page. To require users to enter an email address, select this option in the New User Registration Installation page. The email address users enter at account creation time is automatically stored in the newly created user profile. The email address is used to populate the records PSOPRDEFN.EMAILID and PSUSEREMAIL.EMAILID with an email type (EMAILTYPE field), and the PRIMARY_EMAIL field must be selected.

See:

- [Defining Installation Options for New User Registration](#)

- *PeopleTools: Security Administration*, “Setting General User Profile Attributes”
2. Set up the Notifications Framework.
 - a. If necessary, set up the generic template NUR_EMAIL_OPRID. The generic template NUR_EMAIL_OPRID is configured for the Forgot User ID email message. You can modify the text of this template. To set up the template, go to **PeopleTools** > **Workflow** > **Notifications** > **Generic Templates**.

See [Understanding New User Registration, Notifications Framework and New User Registration](#).
 - b. Verify the notification setup and the email recipients for the generic template. This setup is delivered with your system as sample data (Notification Template ID SCC_NTF_TMP_20130213051038 – NUR_EMAIL_OPRID). To view the setup, go to **Set up SACR** > **System Administration** > **Utilities** > **Notifications** > **Notification Setup**.
 - c. Verify the setup for the notification consumer for New User Registration. This is delivered with your system as sample data (Notification Consumer ID SCC_NTF_CON_20121212000832 – New User Registration). To view the setup, go to **Set up SACR** > **System Administration** > **Utilities** > **Notifications** > **Notification Consumer Setup**.
 3. Grant all users access to a permission list that is set up to grant access to the Forgot My User ID page.

See [Step 1: Initial Setup for New User Registration](#).

Step 10: Configuring the Forgot Password Utility

To configure the Forgot Password Utility:

1. Store email addresses in the PSOPRDEFN.EMAILID and PSUSEREMAIL.EMAILID records where PRIMARY_EMAIL = ‘Y’.

The New User Registration Forgot Password utility leverages the PeopleTools security function for forgotten passwords. This function uses the PeopleTools Workflow and requires users to have an email address stored in their user profile (General tab, **Edit Email Address** link).

To take advantage of the Forgot Password utility, you can require users that are created through the SCC_USERREG_CREATEACCT service operation to enter an email address. For example, guests who create their own account using the New User Registration login page. To require users to enter an email address, select this option in the New User Registration Installation page. The email address users enter at account creation time is automatically stored in the newly created user profile. The email address is used to populate the records PSOPRDEFN.EMAILID and PSUSEREMAIL.EMAILID with an email type (EMAILTYPE field), and the PRIMARY_EMAIL field must be selected.

See:

- [Defining Installation Options for New User Registration](#)
- *PeopleTools: Security Administration*, “Setting General User Profile Attributes”

2. Create the URL you include in the forgotten password email text.

When you use the Forgot Password utility, the user receives an email message that contains the newly generated password. In the email message, it is recommended that you include a URL to access the New User Registration login page. Use the URL to force users to reset the temporary password they received. After users log in with their temporary password, they should be automatically redirected to the Change Password page. The URL you use must be embedded with the New User Registration context ID that grants the newly authenticated user the security to access and immediate transfer to the Change Password page. Your system includes a New User Registration Context ID sample: SCC_NURCTXT_20130211110717 - NUR_CHANGE_PASSWORD. Make sure the generic URL you use has been configured using the New User Registration Installation page.

See:

- [Step 7: Creating a URL to Access the New User Registration Login page](#) [Defining Installation Options for New User Registration](#)
- [Setting Up New User Registration Context](#)

3. Create password hint questions.

To use the Forgot Password utility, users need to answer a security question or password hint question. To create password hint questions, go to **PeopleTools > Security > Password Configuration > Forgot Password Hint**.

See *PeopleTools: Security Administration*, “Creating Hints for Forgot Passwords.”

4. Set up the Forgot Password email text.

When the user initiates the Forgot Password utility and successfully answers the security question, an email message is sent to the email address that is stored in the user's profile. It includes a newly generated password. You can configure the email message text by going to **PeopleTools > Security > Password Configuration > Forgot Password Email text**.

The email text must include the <<%PASSWORD>> tag. PeopleTools replaces the tag with the newly generated password. To facilitate user experience, it is recommended that you also include a URL that transfers the user automatically to the New User Registration sample login page (or your own version of this page). This is the URL you create in step 2. This forces the user to immediately change the newly received password. The PeopleTools email text editor allows you to easily paste a URL. You can use the URL you marked as *Active* in the New User Registration context ID in your system (SCC_NURCTXT_20130211110717 - NUR_CHANGE_PASSWORD).

This is an example of an email text:

You are receiving this auto-generated email message because you requested your Campus Solutions password to be reset. Use the following temporary password: <<%PASSWORD>>. Click this link or copy the below URL to access the system with your newly generated password. You will be requested to change the temporary password immediately.” https://yourKioskServer.yourKioskDomain.com/psc/ps/EMPLOYEE/HRMS/c/SCC_NUR.SCC_NUR_REG.GBL=start?CAMPUS_URL=https%3a%2f%2fyourCSServer.yourCSDomain.com%2fpsc%2f%2fEMPLOYEE%2fHRMS%2f%2fWEBLIB_SCC_NUR.SCC_SS_GATEKEEPER.FieldFormula.IScript_SCC_GateKeeper%3fSCC_APPL_CONTEXT_ID%3dSCC_NURCTXT_20130211110717

See *PeopleTools: Security Administration*, “Working with Passwords.”

5. Grant all your users access to a self-service page where they can respond to a security question.

Delivered with your system with the generic PeopleTools security a self-service user can answer is a security question under Home page, My System Profile. In the General Profile Information page (USER_SELF_SERVICE), by clicking the link Change or set up forgotten password help, the user can select a question and enter a response. This page is delivered with your system and security needs to be granted to all of your users. Alternatively, a simpler self-service version of this page could be created.

6. Configure the Forget My Password page.

This is a delivered custom version of the Tools page EMAIL_PSWD as public.

See *PeopleTools: Security Administration*, “Working with User Profiles Across Multiple PeopleSoft Databases, Implementing Default User Profile Synchronization.”

7. Make sure you grant all your users access to a permission list set up with Allow Password to be Emailed and Forgot My Password.

See [Step 1: Initial Setup for New User Registration](#).

8. Set up the New User Registration context ID for the Change My Password page, or use the SCC_NURCTXT_20130211110717 - NUR_CHANGE_PASSWORD context ID.

9. Set the PeopleTools Workflow to activate email.

The New User Registration Forgot Password utility leverages the PeopleTools send password functionality. Because this functionality uses the PeopleTools Workflow, the following setup is required:

- a. Go to **PeopleTools > Workflow > Defaults & Messages > Set Workflow Defaults**.
- b. In the **Worklist System Defaults page > System Wide Route Processing** make sure the Worklists Active and the Email Active check boxes are selected.
- c. Reboot the application server for the changes to take effect.

Troubleshooting New User Registration

- Ensure that the service operations created for the consuming self-service transactions and the service operations delivered with the New User Registration framework are configured with Full Access security. To do so, access the General page (**PeopleTools > Integration Broker > Integration Setup > Service Operations > General**) for the desired service operation. Click the Service Operation Security link and make sure the permission lists used inside SCC_SS_TEMPLATE have Full Access.
- If you use the New User Registration Forgot Password utility and you see the following Integration Broker error, it means your user does not have access to a permission list set to 'Allow Password to be Emailed = 'Y':

This example illustrates the fields and controls on the Integration Broken error. You can find definitions for the fields and controls later on this page.

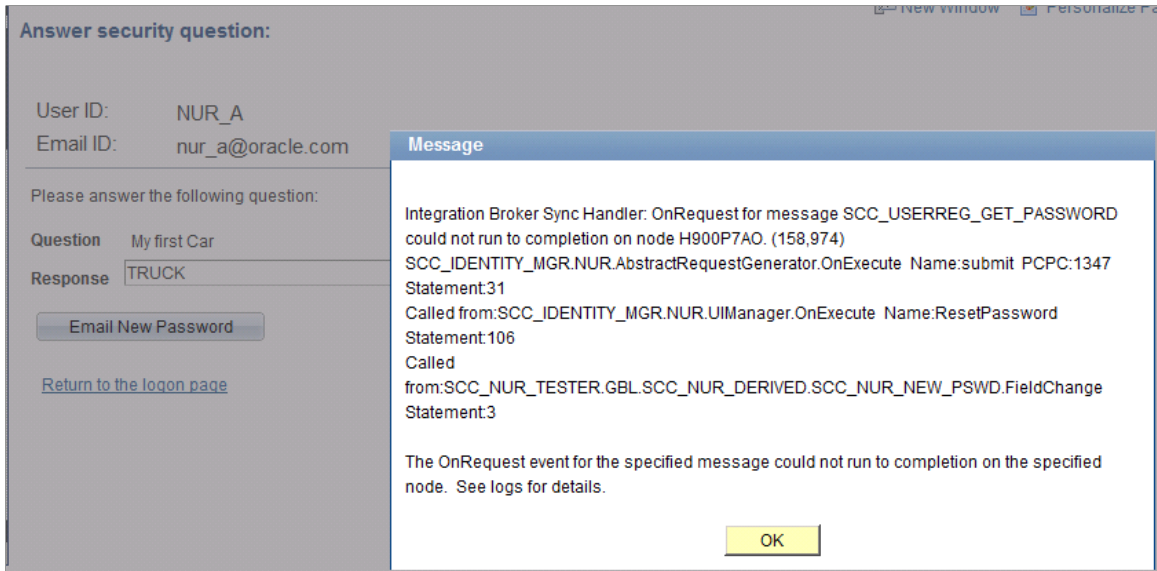

Working with the Rules Engine

Understanding the Rules Engine

This section discusses:

- Rules Engine components.
- A high level description of the Rules Engine.
- Rules Engine Manager and Entity Registry.

The Rules Engine provides:

- a non-programmer user interface to create complex business rules.
- a secure way to retrieve data from the system in a logical manner, perform calculations and evaluations, and update data.
- a way to use the Entity Registry, a familiar logical hierarchy, to retrieve data from the system; for example, the curriculum structure of the Academic Item Registry (AIR) or the results structure of the Academic Progress Tracker (APT).
- System Variables and Functions for creating Rules.
- a compiler (Rule Builder) that compiles and readies Rules for execution.
- a means to manage changes to Rules over time and a large number of Rules using versioning.

Rules Engine Components

There are three components used to manage the Rules Engine feature:

- Rules Engine Manager

The Rules Engine Manager is the interface for creating institution business rules. The Rules Engine Manager can be deployed for two Rule building Skill Levels, Expert and Developer, each with its own set of Rules-building capabilities. The Rules Engine Manager uses the Entity Registry by allowing users to build Rules using a familiar logical hierarchy; for example, the curriculum structure.

- Rules Engine

The Rules Engine builds (compiles) and executes the user-created business rules.

- Rules Engine Categories.

Rules Engine Categories are used to restrict access to pre-defined and secured areas of application functionality including access to Rules in other Rules Engine Categories and what types of Rules can be created: Triggers, Functions or Rules.

High Level Description of the Rules Engine

This diagram shows Rules Function functionality:

Rules Engine Business Process (Generic)

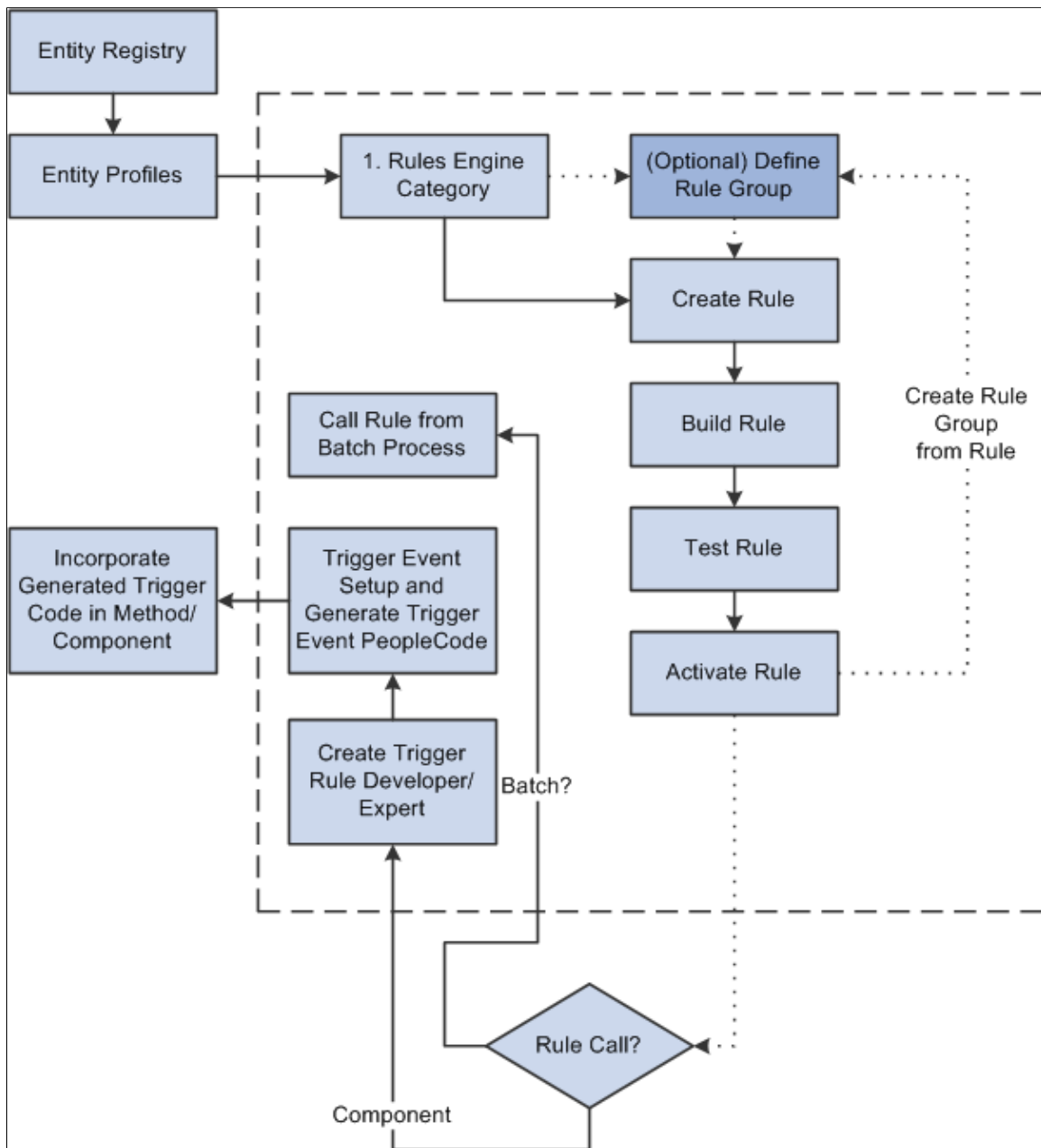

Rules Engine Manager and Entity Registry

This section discusses the relationship between the Rules Engine and the Entity Registry.

Entity Registry

When building Rules you need access to the data in your system. For Query Manager and Equation Engine, data access is based on granting the user access to specific records in the system.

However, data access for the Rules Engine is controlled through the Entity Registry. An Entity is an object that provides access (view, create, update) to data in a record. The properties on the Entity represent the fields in the actual records.

By design, an Entity is the primary point of access to the underlying records. This avoids potential inconsistencies of having the same logic in multiple places and helps in making relevant code reusable and maintenance easier. This becomes relevant when the same data is accessed or updated in multiple ways: a user-interface, web services, or the Rules Engine.

Entity relationships are represented in a tree-like hierarchy, making the underlying data structure logical for functional users to understand. When building a Rule that needs to access specific system data, you first choose which Base Entity you want to with.

For more information about Entity Registry:

See [Setting Up Entity Registry](#).

Note: Although the Rules Engine can be used with any Entity Registry delivered with the system, it is the Entity Registries created for data records from the Program Enrollment Academic Item Registry (AIR) and Academic Progress Tracker (APT) features that are optimized for Rules Engine use. These Entities are used throughout this document as examples of how Entity-based data can be used in the Rules Engine.

For more information about AIR and APT, see:

- “Understanding Program Enrollment” (Student Records)
- “Understanding the Academic Progress Tracker” (Student Records)

Here is a example that shows part of the APT Entity Registry Hierarchy:

This example illustrates the fields and controls on the Academic Progress Tracker Program of Study Entity Registry Hierarchy example. You can find definitions for the fields and controls later on this page.

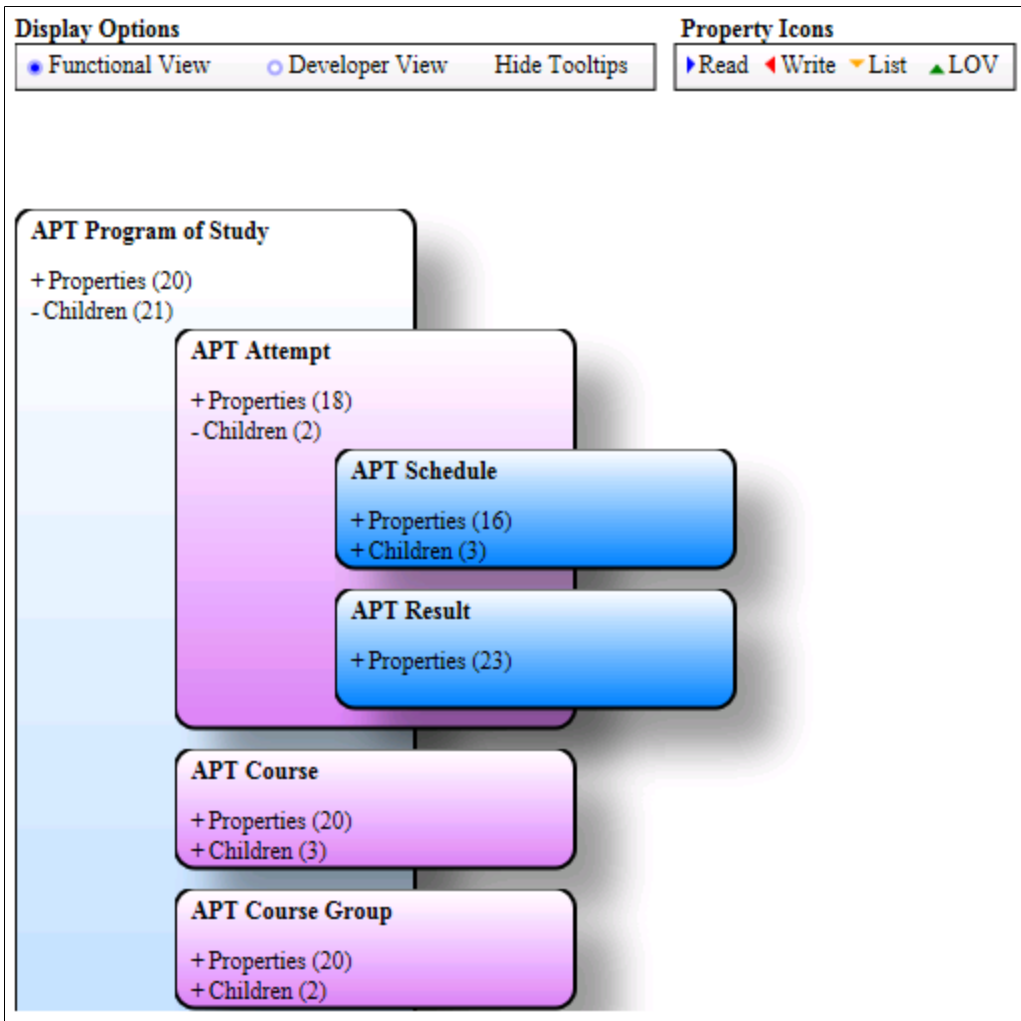

Here is an example that shows the entities APT Year, APT Study Period, and APT Semester. The properties of APT Semester are expanded and shown:

This example illustrates the fields and controls on the Academic Progress Tracker Program, other children of the APT Program of Study example. You can find definitions for the fields and controls later on this page.

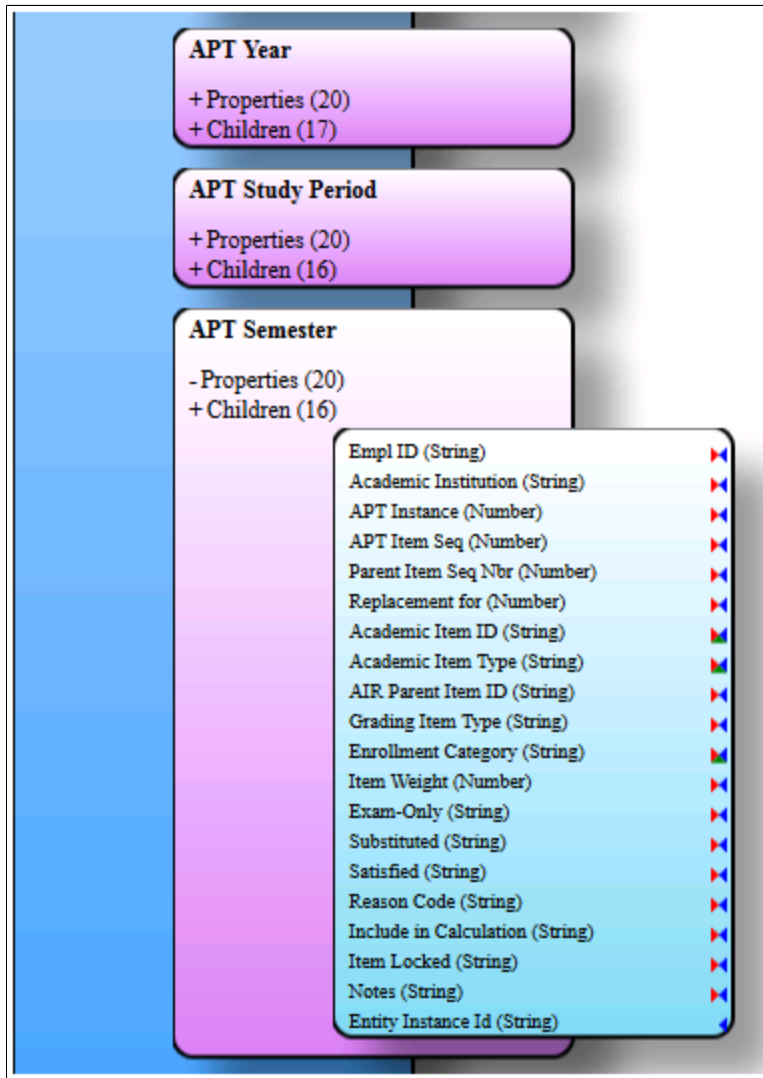

In the example above, the APT Year, APT Study Period, and APT Semester entities have been generated from non-system Academic Item Types Year, Study Period, and Semester. AIR and APT structures are unique in that they can be specified using institution specific objects. The Entity Registry reflects this.

The hierarchical relationships between Program of Study, APT year and APT semester are reflected in the APT hierarchy tree and are very similar to how the Curriculum structure reflects in a student's APT:

This example illustrates the fields and controls on the Example of the Academic Progress Tracker Tree. You can find definitions for the fields and controls later on this page.

Status	AIR Item Description	Item Type	Enrollment Category
○	Bachelor of Psychology (Sem: Differentiation Paths)	Program of Study	
○	- Bachelor Psychology Propeduse	Phase	
○	- - Bachelor Psychology Year 1	Year	
○	- - - Bachelor of Psychology Year 1 Semester 1	Semester	
○	- - - - Bachelor Psychology Year 1 Semester 1 Compulsory	Course List	Compulsory
✓	- - - - - PSYCH 500005: Academic Skills: Psychology 1	Course	Compulsory
✓	- - - - - PSYCH 530000: Experimental Psychology	Course	Compulsory
✓	- - - - - PSYCH 595101: Intro Psych & History of Psych	Course	Compulsory
✓	- - - - - PSYCH 424502: Intro Research Methodology	Course	Compulsory
✓	- - - - - PSYCH 500006: Academic Skills: Psychology 2	Course	Compulsory
✓	- - - - - PSYCH 500301: Brain and Behaviour	Course	Compulsory
✓	- - - - - PSYCH 550006: Psychology of Personality	Course	Compulsory
○	- - - - Bachelor of Psychology Year 1 Semester 2	Semester	
○	- - - - - Bachelor Psychology Year 1 Semester 2 Compulsory	Course List	Compulsory
✓	- - - - - PSYCH 500008: Academic Skills: Psych 3: paper	Course	Compulsory
✓	- - - - - PSYCH 424504: Introduction to Statistics	Course	Compulsory
✓	- - - - - PSYCH 421001: Psychopathology First-year Std	Course	Compulsory
✓	- - - - - PSYCH 500305: Social Psychology	Course	Compulsory
✓	- - - - - PSYCH 500308: Cultural Psychology	Course	Compulsory
✓	- - - - - PSYCH 560100: Developmental Psychology	Course	Compulsory

The results from the student’s APT are reflected in a similar fashion in the Entity Registry Structure:

This example illustrates the fields and controls on the Academic Progress Tracker Course Entity Registry Hierarchy example. You can find definitions for the fields and controls later on this page.

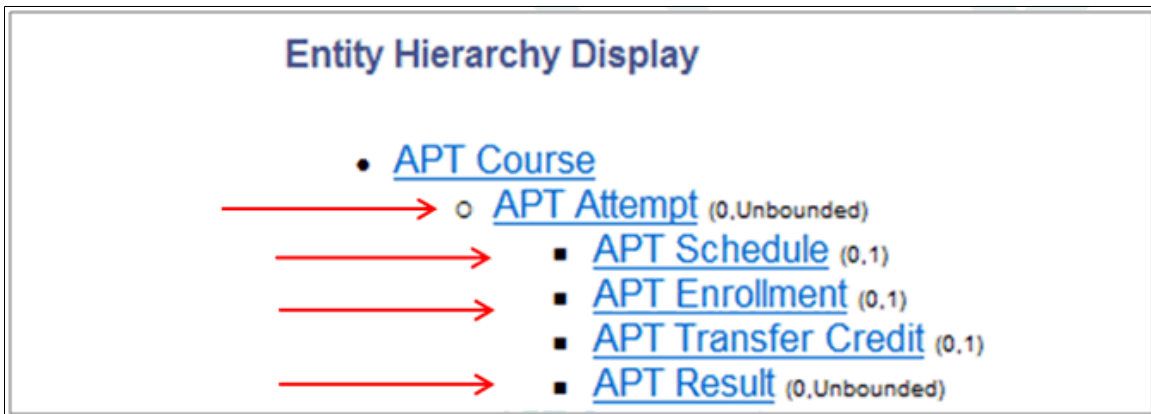

This example illustrates the fields and controls on the Example of Academic Item Attempt. You can find definitions for the fields and controls later on this page.

The screenshot shows a web interface for an Academic Item Attempt. It is divided into four main sections, each with a red arrow pointing to it from the right side of the image:

- Attempt:** This section contains form fields for 'Attempt Nbr' (value: 1), '*Approval Status' (value: Not Required), 'Attempt Status' (value: Finalized), and 'Attempt Outcome' (value: Passed). It also includes checkboxes for 'Locked', 'Print in Transcript', 'Eligible for Retake', and 'Include in Calculation'.
- Schedule:** This section is a table with columns: Year of Program, Academic Year, Term, Description, Session, *Progress Level, and Credit Type. The data row shows: 1st Year, 2010, 2100, Acad year 2010-2011, Semester 1, 20-Planned.
- Enrollment:** This section is a table with columns: Career, Term, Class Nbr, Enrollment Status, Units, Grade Scheme, Grading Basis, and Official Grade. The data row shows: Undergraduate, 2010, 1004, Enrolled, 2.00, Undergraduate Grading Scheme, Graded, 8.1.
- Results:** This section is a table with columns: *Result Nbr, Result Type, Result Scale, Result Value, *Result Status, and Include in Calc. It shows two rows: one for '10 RESULT' with a scale of '10-PNT' and value '8.1', and another for '20 ECTS' with a scale of '10-Calcula' and value '2'.

Entity Properties

Table fields are represented as properties in the Entity Registry. The Rules Engine uses properties to retrieve or update information.

This example illustrates the fields and controls on the Example of Entity Properties for Academic Item Attempt. You can find definitions for the fields and controls later on this page.

Prompt for Entity Properties

*Field Name Property contains Search

Property	Entity	Type
Attempt Nbr	APT Attempt	Number
Course ID	APT Attempt	String
Course Offering Nbr	APT Attempt	Number
Course Topic ID	APT Attempt	Number
Empl ID	APT Attempt	String
Attempt Locked	APT Attempt	String
Academic Institution	APT Attempt	String
Entity Instance Id	APT Attempt	String
Advisor Approval Status	APT Attempt	String
APT Instance	APT Attempt	Number
APT Item Seg	APT Attempt	Number
Attempt Outcome	APT Attempt	String
Attempt Status	APT Attempt	String
Credits	APT Attempt	Number
Include in Calculation	APT Attempt	String
Notes	APT Attempt	String
Eligible for Retake	APT Attempt	String
Print in Transcript	APT Attempt	String

Return

Entity Profiles

Entity Profiles are used to grant or restrict access to specific Entities and/or Entity properties. For example, you want to allow a specific user to create Rules which retrieve information from APT like the Grade Result Value for a Course, but do not want to allow the ability for this same Rule to retrieve any administrative notes that have been added by the supervisor. Through setup of specific Entity Profiles, you can restrict access to the property that represents the Result Notes.

Security for access to specific Entities via the Rules Engine Manager is enforced by associating specific Entity Profiles with Rules Engine Entity Categories.

Additional Rules Engine Features

This section discusses Rules Engine major features.

Rules Engine Categories

Rules Engine security is enforced through the set up of Rules Engine Categories. A Rules Engine Category is user-defined and tied to one or more Roles and/or specific Users. Rules Engine Category security determines which Entities can be accessed by these Roles and Users and what types of Rules can

be created. There are three types of Rules: Triggers, Functions, and Rules. For example, specific Rules Engine Categories may allow the creation of Triggers but not of Rules or Functions. Also, Rules Engine Categories can be set up to use other Rules Engine Categories.

Rule Groups

A Rule Group is a template which can be used to create new Rules that share the same functional purpose. A Rule Group provides a predefined set of input and output parameters for a Rule or Function and an option to predefine a Base Entity. Whenever a Rule is created using the predefined Rule Group, all the Input and Output variables are populated using the Rule Group Template options. By using the same parameters, all Rules created in the same Rule Group can be used the same way. This is beneficial when, for example, you need multiple Rules to be called from a user interface, and you need all of those Rules all to provide similar feedback; like a message that can be displayed on screen. You may also want to dictate that the Input for all of these Rules needs to be the same, namely confined to the information available on the user interface. A Rule Group can subsequently be used to dynamically call all Rules associated with that Rule Group.

Creation of Rule Groups is optional.

Rule Creation

You can use the Rules Engine Manager component to Create, Build, Test, and Version a Rule, and determine if a Rule is used by other Rules.

- *Creating*

You can identify and select a functional application area from which to retrieve data by selecting an Entity and, in the case of a Rule, defining the Criteria which need to be used to select specific data. Use Statements to act upon the selected entity by creating evaluative statements, performing calculations, calling other Rules and Functions, and updating and inserting data in the system.

- *Building*

Once a Rule is created, you must build (compile) it before testing and using it. The Build action compiles the created Rule and converts it into executable code, which means the Rule is ready to perform evaluation and calculation tasks.

- *Testing*

After Rules have been created and built, you can test them with the Rules Engine Tester. The Tester allows users to define and save one or more Test Profiles with test specific data so that multiple scenarios can be tested for the same Rule.

- *Versioning*

The Rules Engine Manager allows the user to create new versions of a Rule and administer one or more version codes and/or code and comments whenever a new version of a Rule is created.

- *Cross Referencing*

The Cross Reference page lists all Functions and Rules which reference the Rule in context.

Calling Rules and Creating Triggers

After Rules have been created, built, tested, and activated, they are ready to use. To use a Rule as part of a functional business process, it needs to be associated with and called from that process. For example, you can set up a Trigger and use the code created by the Trigger to call Rules from a user interface; keeping in mind that the Trigger-generated code may need some adjustment to work for the specific purpose for which you need it.

Note: The determination of where you want to use Rules and how to make them available must be discussed with the technical team that supports Campus Solutions at your school.

Rules can be called and executed from the following application functionality:

- Rules Engine Manager Tester
- Rules Engine Batch Processing Component
- Application Component (for example, a user interface)

See [Constructing Rules](#), “Defining Rule Triggers.”

Setting Up the Rules Engine

This section discusses how to:

- Set Up Rules Engine Install Options.
- Define Rule Category Security.
- Define Color Codes for Rules Engine Manager Elements.
- Define Rules Engine Statements.
- Define Rules Version Reason Codes.
- Set up Rules Engine Variables.
- Define Lists of Values for Rules Engine Variables.

Pages Used to Setup the Rules Engine

<i>Page Name</i>	<i>Definition Name</i>	<i>Navigation</i>	<i>Usage</i>
Rules Engine Install Options	SCC_INSTALL_RE	Set up SACR > System Administration > Rules Engine > Setup > Install Options > Rules Engine Install Options	Set up Rules Engine Install Options.

Page Name	Definition Name	Navigation	Usage
Rule Category Definition	SCC_RULE_CAT_SETUP	Set up SACR > System Administration > Rules Engine > Setup > Define Categories > Definition	Add and define Rule Categories to control the ability to create Rules by Rule Usage. Control Rule Category access to called Rules and Functions and assign a valid Entity Profile.
Rule Category Rule Groups	SCC_RULE_CAT_RLGRP	Set up SACR > System Administration > Rules Engine > Setup > Define Categories > Rule Groups	Determine if Rule Groups are required for a Rule Category and assign valid Rule Groups.
Rule Category Security	SCC_RULE_CAT_SCRTY	Set up SACR > System Administration > Rules Engine > Setup > Define Categories > Security	Assign valid roles and additional users that have access to a Rule Category.
Rule Category Cross Reference	SCC_RULE_CAT_XREF	Set up SACR > System Administration > Rules Engine > Setup > Define Categories > Cross Reference	Displays Rules, Rule Groups, System Variables, and Triggers associated with the Rule Category.
Define Colors	SCC_COLORS	Set up SACR > System Administration > Rules Engine > Setup > Define Colors	Define colors to associate with Rules Engine user interface elements.
Define Rules Engine Text Colors	SCC_RULE_TXT_COLOR	Set up SACR > System Administration > Rules Engine > Setup > Define Text Color	Associate colors with Rules Engine user interface elements.
Define Rules Engine Statements	SCC_RULE_STMT_TBL	Set up SACR > System Administration > Rules Engine > Setup > Define Statements	Define Statements to use in Rule evaluations and calculations.
Define Version Reason Codes	SCC_RULE_VRSN_TBL	Set up SACR > System Administration > Rules Engine > Setup > Define Version Reason Codes	Define Rules Version Reason Codes to use when creating new versions of existing Rules.
Define System Variables	SCC_RULE_SYSVAR	Set up SACR > System Administration > Rules Engine > Setup > Define System Variables > Definition	Define System Variables to use when creating Rules.

Page Name	Definition Name	Navigation	Usage
System Variables Cross Reference	SCC_RULE_SYSV_XREF	Set up SACR > System Administration > Rules Engine > Setup > Define System Variables > Cross Reference	Displays Rules and Rule Groups associated with the System Variable.
Define Data Sets	SCC_RULE_EDS	Set up SACR > System Administration > Rules Engine > Setup > Define Data Sets	Define Data Sets to use as a temporary storage when creating Rules.
Data Set Property Details	SCC_EDS_PROP_DTLS	Click the Details link on the Define Data Sets page.	Define Data Set property details.
Data Set Cross Reference	SCC_RULE_EDS_XREF	Set up SACR > System Administration > Rules Engine > Setup > Define Data Sets > Cross Reference	Displays Rule and Rule Groups associated with the Data Set.
Define List of Values	SCC_RULE_LOV_DEFN	Set up SACR > System Administration > Rules Engine > Setup > Define List of Values	Define lists of values to use for property prompting when creating Rules.
List of Values Cross Reference	SCC_RULE_LOV_XREF	Set up SACR > System Administration > Rules Engine > Setup > Define List of Values > Cross Reference	Displays Rule and Rule Groups associated with the List of Values.

Setting Up Rules Engine Install Options

Access the Rules Engine Install Options page (**Set up SACR > System Administration > Rules Engine > Setup > Install Options > Rules Engine Install Options**).

This example illustrates the fields and controls on the Rules Engine Install Options page. You can find definitions for the fields and controls later on this page.

Rules Engine Install Options

Active Rule Behavior

Allow Changes to Active Rules

Rules Engine LOV Default Values

*LOV Context Option ▼

*LOV Context

*LOV Record 🔍

*LOV Field 🔍

<i>Field or Control</i>	<i>Description</i>
<p>Allow Changes to Active Rules</p>	<p>Select this check box to allow changes to active Rules or Functions. You can use this flag to override the feature that makes Rules features inaccessible when Rules or Functions are active. This option can be useful in non-production environments in cases where it should be possible to change active Rules.</p> <p>The check box is not selected by default.</p> <p>When Allow Changes to Active Rules is not selected only the following can be changed or accessed by the user when accessing the Rules Engine Manager Component:</p> <ul style="list-style-type: none"> Rule Long Description (change) View of Variables (access) View of Evaluations and Calculation Details. (access) <p>When Allow Changes to Active Rules is not selected, the following Action Drop down options are not available:</p> <ul style="list-style-type: none"> Create new Version of Rule Delete Rule Inactivate Rule Remove Rule Group from Rule Delete Rule Group Inactivate Rule Group <p>When Allow Changes to Active Rules is not selected, Rule Groups that are selected to be Available In Dynamic Rules cannot be altered.</p>

Field or Control	Description
Rules Engine LOV Default Values	<p>Rules Engine List of Values (LOV) allows you to define Rules Engine prompting for variables created and used in the Rules Engine Manager. The system-delivered default values of the fields in this group box control LOV functionality in the Rules Engine Manager.</p> <hr/> <p>Warning! Do not change the values delivered with the system.</p> <hr/>

Defining Rule Category Security

Rules Engine Categories provide a means of administering various Rules Engine settings by Role and/or User. Every Rule that is created must belong to one predefined Rule Category. The Rule Category is used to control the following:

- The type of Rule that can be created as defined by Rule Usage: Rule, Function, and/or Trigger. Rule Usage determines how a Rule can be used in a business process.
- Access to Rules in other Rule Categories. Multiple Rule Categories can be added to the Rule Category definition. When these Rule Categories are added, Rules or Functions belonging to the associated Rules Category can be called from the main Rule.
- Access to Data through Entities. The Entity Profile attached to the Rule Category defines which Entities can be used as a Base Entity in the Rule created. The Base Entity is the starting point from which the logic in the Rule is built. Depending upon the Entity Profile setup, you may have access to one or more Base Entities *and* all or a defined set of Entity Properties.

See [Setting Up Entity Registry](#).

- Valid Rule Groups. Valid Rule Groups can be associated with a Rules Category. Restrictions may be applied so that you can only build Rules from a Rule Group. This can be beneficial in circumstances where you want to guide a group of users with Rule creation by making sure that they build their Rule according to the defaults provided by the Rule Group or Rule Groups associated with this Rule Category.

Note: For Rule Categories delivered with the system, only the **Long Description** on the Definition page and Rule Groups and Security pages can be modified. Rules Engine Categories delivered with the system are marked by the words “System Data” to the right of the **Rule Category** field.

Access the Rule Category Definition page (**Set up SACR > System Administration > Rules Engine > Setup > Define Categories > Definition**).

This example illustrates the fields and controls on the Rule Category Definition page. You can find definitions for the fields and controls later on this page.

The screenshot shows the 'Definition' tab of the Rule Category Definition page. The 'Rule Category' field is set to 'SCC_RULE_CAT_20140213080312'. The '*Rule Category Name' field contains 'Admissions Rules'. The '*Long Description' field also contains 'Admissions Rules'. There is an 'Available To All Categories' checkbox which is unchecked. The 'Entity Profile Name' field is set to 'Admissions and Recruiting'. Below this are three checkboxes: 'Allow Rules' (checked), 'Allow Functions' (checked), and 'Allow Triggers' (unchecked). A table titled 'Valid Rule Categories' is displayed, listing categories like DateTime, Debug, Math, Notification Framework, Number, String, Testing, and Text Messages. An 'Add a Category' button is at the bottom.

Using this category as an example, you cannot create Functions or Rules in category Math, but you can create Functions and Rules in category AIR Functions and CALL Functions in category Math.

Field or Control	Description
Rule Category	Displays a unique ID generated by the system. When adding a new Rule Category, the default value is <i>NOID</i> . After saving the Rule Category, a unique ID is generated by the system and assigned to the Rule Category. The ID is created by combining prefix “SCC_RULE_CAT_” with the system date and time stamp in format YYYYMMDDHHMMSS.
Rule Category Name	Enter a Rule Category Name. The Rule Category Name is used when searching for a Rule Category and for display.
Long Description	Enter descriptive text explaining the function of the Rule Category .

Field or Control	Description
Available to All Categories	<p>Select this check box to make this Category automatically available as a valid Category in other Categories. Categories that are defined as “Available to all Categories” cannot have any Valid Categories of its own. When this check box is deselected, the Category is no longer available in other Categories.</p> <hr/> <p>Note: Security settings on the Rule Category affect all Rules, Functions and Triggers which have been called from or created in this Category.</p> <hr/> <p>In the example below the Category Math has been made available to Category “Admissions Rules” as a Valid Rule Category. Every Function and Rule Created in Category Math can now be called from a Function or Rule created in Category “Admissions Rules”.</p> <hr/> <p>Note: Deselecting “Available to All Categories” on category Math would remove the Category from Admissions Rules and invalidate the security on the Call statement of rules which have already been created. Although this would not break compiled Rules it would cause problems when users want to change those rules.</p>
Entity Profile Name	<p>Enter the Entity Profile Name that you want to associate to this Rule Category. Rules, Functions and Triggers can be built using the Base Entities which have been setup in this Entity Profile. If the Entity Profiles uses Views, access to certain properties within an Entity may have been restricted.</p>
Allow Rules	<p>Select this check box to allow the creation of Rules with this Rule Category.</p>
Allow Functions	<p>Select this check box to allow the creation of Functions with this Rule Category.</p>
Allow Triggers	<p>Select this check box to allow the creation of Triggers with this Rule Category.</p>
Valid Rule Categories	<p>Select Rule Categories available to this Rule Category. The Rules, Functions, and Triggers of the selected categories can be called by Rules created in the main Category.</p> <hr/> <p>Note: This is not an inheritance model. Adding a valid Rule Category here gives you access to the Rules, Functions, and Triggers <i>native to</i> that Rule Category but <i>not</i> to Rules, Functions, and Triggers of any Rule Categories associated with the selected Rule Category.</p>

Access the Rule Category Rule Groups page (**Set up SACR > System Administration > Rules Engine > Setup > Define Categories > Rule Groups**).

Use this page to add valid Rule Groups to this Rule Category or to restrict users to only being able to build Rules by using one of the associated Rule Groups.

<i>Field or Control</i>	<i>Description</i>
Rule Group Required	Select to enforce Rule Group usage. When building Rules users must select one of the Valid Rule Groups before being able to build their Rules.
Valid Rule Groups	Select Rule Groups. Note: Rule Groups are added to this setup page automatically when you add Rules to a Rule Group by using the Create Rule Group option from Rules Engine Manager or by using Create Rule Group from a Rule when on the Rules Engine Search option page.

Access the Rule Category Security page (**Set up SACR > System Administration > Rules Engine > Setup > Define Categories > Security**).

This example illustrates the fields and controls on the Rule Category Security page. You can find definitions for the fields and controls later on this page.

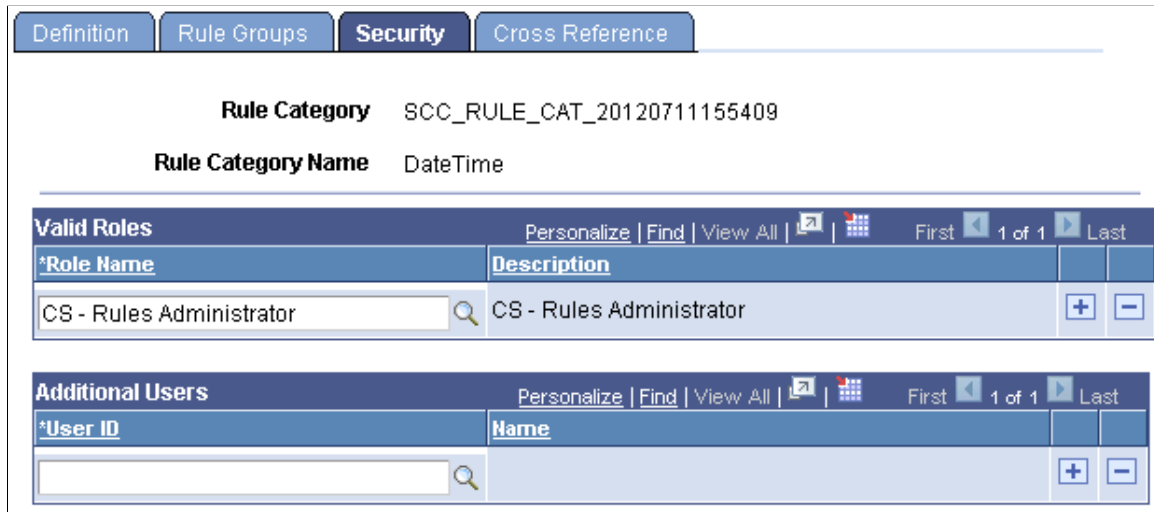

<i>Field or Control</i>	<i>Description</i>
Valid Roles	Enter Valid Roles for which the Rules Category definition is valid. These are Roles that are set up using the standard PeopleTools Security function.
Additional Users	Enter additional users for which the Category Definition is valid. The registration of Additional Users is supplemental to the Valid Roles .

Access the Rule Category Cross Reference page (**Set up SACR > System Administration > Rules Engine > Setup > Define Categories > Cross Reference**).

This example illustrates the fields and controls on the Rule Category Cross Reference page. You can find definitions for the fields and controls later on this page.

Definition
Rule Groups
Security
Cross Reference

Rule Category SCC_RULE_CAT_20120711155409

Rule Category Name DateTime

Rule Cross Reference		
Rule Name	Version	Rule Status
AddDaysToDate	1	Active
AddMonthsToDate	1	Active
AddYearsToDate	1	Active
Day	1	Active
DaysBetweenDates	1	Active
DaysToWeeks	1	Active
GetCurrentDate	1	Active
Hour	1	Active
Minute	1	Active
Month	1	Active

This category is not used by any rule groups

System Variable Cross Reference	
System Variable Name	Type
Current Date	Date
Current Date Time	Datetime
Current Time	Time

This category is not used by any triggers

This page shows Rules, Rule Groups, System Variables, and Triggers which have been created as part of this Category.

Field or Control	Description
Rule Name, Rule Group Name, System Variable Name, and Trigger Name	<p>Displays to authorized users a link for any of these Rules Engine objects that have been created in this Rule Category. If a user is not authorized, the link is disabled.</p> <p>Click a link to transfer out of the component and to the referenced object.</p> <hr/> <p>Warning! Make sure you have saved any data that you need to before confirming you want to transfer to the referenced object in a new component.</p> <hr/> <p>If no objects are associated with the Rule Category, a notification is shown in place of the object details. for example, "This Category is not used by any triggers".</p>
Version	Displays the Rule Version Number.
Rule Status and Rule Group Status	Displays the status of the Rule Group or Rule Name (<i>In Progress, Active, In-active</i>).

Field or Control	Description
Type	Displays the Type of System Variable.

Defining Color Codes for Rules Engine Manager Elements

Note: The assigning of different colors to different Rules Engine Manager Elements for purposes of displaying the Elements in different colors in user interfaces is *optional* and does not affect how a Rule is used in System processing. If no color setup is done, all Element text is displayed in black.

A set of predefined color codes for the Rules Engine Manager user interface are delivered. The different colors represent different types of elements of the Rule; for example, Rule Names, Statements, Variables, etc. You can customize the colors and the Rule elements with which they are associated. The following color codes are delivered:

Color	Color Code ID
Dark Purple	380B61
Black	000000
Blue	0000ff
Red	ff0000
Green	008000
Purple	800080
Brown	a52a2a
Gray	808080
Dark Blue	0000a0
Yellow	ffff00
Orange	ffa500
Maroon	800000

Note: Colors delivered with the system cannot be modified.

Access the Define Colors page (**Set up SACR > System Administration > Rules Engine > Setup > Define Colors**).

This example illustrates the fields and controls on the Define Colors page. You can find definitions for the fields and controls later on this page.

Define Colors

System Data

Color Code Id SCC_COLORS_20120423180017

Color Name Green

Color Code 008000
Green



Although Oracle recommends using the pre-delivered color range, you can add new colors to the system for the Rules Engine Manager user interface elements. New colors can be added simply by adding a new entry, specifying a Color Name and a Color Code which conforms to the HTML color code standard.

Field or Control	Description
Color Code ID	Displays a unique ID generated by the system. When adding a new value the default value is <i>NOID</i> . The unique ID is generated when the Color Code is saved. The Color Code ID is created by combining prefix SCC_COLORS_ with the system date and time stamp in format YYYYMMDDHHMMSS.
Color Name	Enter the name of the color; for example, Sky Blue.
Color Code	<p>Enter an HTML standard color code. New color codes can be defined using HTML standards.</p> <ul style="list-style-type: none"> • HTML color codes format – Each HTML code contains the symbol "#" and 6 letters or numbers. These numbers are in hexadecimal numeral system; for example, "FF" in hexadecimal represents number 255 in decimal. • Meaning of the HTML color codes format – After the “#” symbol, the first two positions in HTML color code represent the intensity of red color. “00” is the least, and “FF” is the most intense. The third and fourth positions represent the intensity of green color, and the fifth and sixth positions represent the intensity of blue color. By varying the intensity of red, green and blue, you can create a large number of colors.

Access the Define Rules Engine Text Colors page (**Set up SACR > System Administration > Rules Engine > Setup > Define Text Color**).

This example illustrates the fields and controls on the Define Rules Engine Text Colors page. You can find definitions for the fields and controls later on this page.

Define Rules Engine Text Colors

Entity String Color	<input type="text" value="Orange"/>	
Hard Coded Text Color	<input type="text" value="Red"/>	
Property Color	<input type="text" value="Purple"/>	
Rule Name Color	<input type="text" value="Maroon"/>	
Statement Color	<input type="text" value="Blue"/>	
Text Color	<input type="text" value="Black"/>	
Variable Color	<input type="text" value="Green"/>	
Call Argument Color	<input type="text" value="Dark Blue"/>	
Call Return Color	<input type="text" value="Violet"/>	

Use this page to assign colors to Rules Engine Manager elements. The following elements can be color coded:

- **Entity String**
- **Hard Coded Text**
- **Property**
- **Rule Name**
- **Statement**
- **Text**
- **Variable**
- **Call Argument**
- **Call Return**

Defining Rules Engine Statements

Rules Engine Statements help you create business rules in the Rules Engine Manager to perform specific processing Functions like assigning values to variables or creating Evaluative Statements. An extensive set of Statements is delivered with the system to facilitate the creation of a comprehensive set of Rules. The processing functionality for each statement is defined in Application Class PeopleCode and associated with a Rules Engine Manager secondary page through a predefined work record. This secondary page is used to display fields and logic associated with the Statement.

For more information, see [Using Statements for Evaluation and Calculation in a Rule](#).

Note: For Statements delivered with the system, only the **Long Description** can be modified.

Note: Oracle may deliver additional Statements in the future. You are advised *not* to create your own Statements at this time.

Access the Define Rules Engine Statements (**Set up SACR > System Administration > Rules Engine > Setup > Define Statements**).

This example illustrates the fields and controls on the Define Rules Engine Statements page. You can find definitions for the fields and controls later on this page.

Define Rules Engine Statements

System Data

Statement	SCC_RULE_STMT_20111116184122
Name	ASSIGN
Long Description	<input style="width: 90%; height: 40px;" type="text" value="Assign data to an object"/>
Application Class	SCC_RULES_ENGINE:Statements:ASSIGN_Statement
Page Name	SCC_RULE_ASGN_SEC
Record Name	SCC_RULE_AS_WRK
Search Page Title	Define Assignment Statement
	<input type="checkbox"/> Encompassing

<i>Field or Control</i>	<i>Description</i>
Statement	Displays a unique system-generated Rules Engine Statement identifier. When adding a new value the default value is <i>NOID</i> . The unique ID is generated when the Rules Engine Statement is saved. The Rules Engine Statement ID is created by combining prefix <code>SCC_RULE_STMT_</code> with the system date and time stamp in format <code>YYYYMMDDHHMMSS</code> .
Name	Enter a Statement Name . The Statement Name is used when searching for a Statement and for display.
Long Description	Enter descriptive text explaining the function of the Statement .

Field or Control	Description
Application Class	<p>Enter the Application Class for this Rules Engine Statement. Logic for system-delivered Statement functionality uses the SCC_RULES_ENGINE:Statements Application Class.</p> <hr/> <p>Warning! To ensure that delivered functionality works as intended, do <i>not</i> change delivered Application Classes.</p> <hr/>
Page Name	<p>Enter the Page Name for this Rules Engine Statement. Each Statement references a secondary page specifically created for this Statement. The secondary page is used to display Statement functionality to the end user. The Statement secondary pages are pre-delivered and are designed to render Statement logic in a specific way.</p> <hr/> <p>Warning! To ensure that delivered functionality works as intended, do <i>not</i> change the Page Name for the Statement.</p> <hr/>
Record Name	<p>Enter the Record Name for this Rules Engine Statement. Each Statement has a unique work record reference. The associated work record is used to technically facilitate the information shown on the secondary pages. The Statement work records are pre-delivered and have been designed to render Statement logic in a specific way.</p> <hr/> <p>Warning! To ensure that delivered functionality works as intended, do <i>not</i> change the Record Name for the Statement.</p> <hr/>
Search Page Title	<p>Enter the Page Title for the Rules Engine Statement. The Page Title is displayed at the top of the Statement grid once the Statement has been selected for use in the Rule.</p>
Encompassing	<p>Select to indicate whether the Statement created is an encompassing statement. An Encompassing Statement is one which can enclose one or more other Statements in the Rule. The following delivered statements are encompassing:</p> <ul style="list-style-type: none"> • IF (ELSE) • For-each • Create-Entity <p>For more information, see Using Statements for Evaluation and Calculation in a Rule.</p>

Define Rules Version Reason Codes

New versions of Rules can be created for each Rule, Trigger or Function. Rule Versions are managed on the Rules Engine Manager Rule Version Page. New versions of Rules can be created for reasons like needing to incorporate new Rule logic or correcting Rule mistakes. To facilitate Rule maintenance, use

Rule Version reason codes to indicate why a new version was created. Define Rule Version Codes on the Rules Version Reason Code setup page.

Note: For Version Reason Codes delivered with the system, only the **Description** can be modified.

Note: The system-delivered **Version Reason Code** of *New Version of the rule* is used automatically whenever a new version of a rule is created. This **Version Reason Code** is delivered with the **Initial Version Default** check box *selected*. If the **Initial Version Default** check box is *not selected*, the **Version Reason Code** of *New Version of the rule* can be selected to be both the Initial Version Reason Code as well as the New Version Reason Code.

Access the Define Version Reason Codes page (**Set up SACR > System Administration > Rules Engine > Setup > Define Version Reason Codes**).

This example illustrates the fields and controls on the Define Version Reason Codes page. You can find definitions for the fields and controls later on this page.

Define Version Reason Codes

System Data

Version Reason Code	SCC_RULE_VRSN_20130513214508
Name	New Version of a Rule
Description	<input style="width: 90%;" type="text" value="New Version of a Rule"/>

New Version Default

Field or Control	Description
Version Reason Code	Displays a unique ID generated by the system. When adding a new value the default value is <i>NOID</i> . The unique ID is generated when Version Reason Code is saved. The ID is created by combining prefix SCC_RULE_VRSN_ with the system date and time stamp in format YYYYMMDDHHMMSS.
Name	Enter a Version Reason Name . The Version Reason Name is used when searching for a Version Reason and for display.
Description	Enter descriptive text explaining the function of the Version Reason Code .
Initial Version Default	Select this check box to use this Version Reason code automatically when the rule is created. Comments can be added to the Version Reason code before the Version page is saved. The system-delivered Version Reason Code <i>Initial Version of the Rule</i> is delivered with this check box selected.

Field or Control	Description
New Version Default	<p>Select this check box to use this Version Reason Code automatically whenever a new version of a rule is created. The system-delivered Version Reason Code <i>New Version of the rule</i> is delivered with this check box selected.</p> <p>If the Initial Version Default check box for the system-delivered Version Reason Code <i>Initial Version of the Rule</i> is <i>not selected</i> and the system-delivered Version Reason Code <i>New Version of the rule</i> is <i>selected</i>, the New Version Default reason is used for both.</p>

Setting Up Rules Engine Variables

This section discusses setting up Rules Engine Variables.

Understanding Rules Engine Variables

Variables provide you with a flexible way to create a temporary placeholder or storage location which can be used in a Rule or passed from the current Rule to another. A Variable has a name and a certain type; for example, “Text” or “Number”. The Variable starts out as empty storage and can be assigned a value, cleared, and re-used.

For example, a Variable named “Total Units” is a variable of type “Number”. The Variable is used in a Function that calculates Total Units from Course Units that are found in a specific Course List. At the end of the Function, the Variable “Total Units” is displayed as the result or outcome of the Rule.

The following Variables can be created when working with the Rules Engine Manager:

- Rules Engine Manager Variables
- System Variables
- Data Sets

Rules Engine Manager Variables are created in a specific Rule and act as a storage place to temporarily store a value in that particular Rule. The previously mentioned “Total Units” is an example. Such a variable can be passed from one Rule to another, but it cannot be referenced by another Rule without having been passed.

System Variables have been predefined in the Define System Variable component and have a specific predefined value. System Variables are available for all Rules in the system and are intended to provide values which are generic and are Variables that are appropriate in multiple situations. Their values do not need to change from one Rule to the next. An example is “Current Date” which always provides the user with value of the current system date. System Variables are typically created by Developers but, once created, can be used by Functional Expert Users in their Rules.

Data Sets allow you to define multiple Variables that can be referenced as a group. When building more complex Rules you may need more than one Variable as a temporary placeholder. There may be situations where you need multiple temporary placeholders that can be stored together as a logical set of Variables. For example, when calculating Total Units for multiple students in batch, you may need to not only store the “Total Units” but also the Student (in the example below we store Student ID as well as Student

Name) and the Course List ID. In this case you may want to create three temporary Variables that can be referenced together as a group. This is a Data Set. The Data Set described above would allow you to store the following example data:

Student ID	Student Name	Course List ID	Total Units
0000012	Brad Wilkinson	Math100	12
0000011	Brenda Benson	Math100	22
0000010	Billy Mathews	Math100	18

Defining Rules Engine Manager Variables

Rules Engine Manager Variables can be defined whenever you need to use a named temporary storage space of a specific type in which to store a value in the Rules Engine. You can pass that Variable to other Rules or use the Variable to store data retrieved from other Rules. Variables are always created within a Rule itself.

For more information, see *Adding Variables to a Rule*.

Defining Rules Engine System Variables

A System Variable is predefined in the system typically by a developer or programmer. Once created, the System Variable can be used in Rules built by functional experts. System Variables can be created to provide re-usable defaults for commonly used values such as system date, Operator ID, etc.

Note: Rules Engine System Variables delivered with the system cannot be modified.

Access the Define System Variables page (**Set up SACR > System Administration > Rules Engine > Setup > Define System Variables > Definition**).

This example illustrates the fields and controls on the Define System Variables page. You can find definitions for the fields and controls later on this page.

Definition

Cross Reference

System Data

System Variable ID	SCC_RULE_SYSVAR_20120822173654
System Variable Name	Current Date
Long Description	Returns the current date.
Type	Date
Base Application Package	SCC_RULE_SYSTEM_VARIABLES:SystemVariables.Date:CurrentDate
Rule Category Name	DateTime
	<input type="checkbox"/> List Variable

<i>Field or Control</i>	<i>Description</i>
System Variable ID	Displays a unique ID generated by the system. When adding a new value the default value is <i>NOID</i> . The unique ID is generated when the system variable is saved. The Statement ID is created by combining prefix <code>SCC_RULE_SYSVAR_</code> with the system date and time stamp in format <code>YYYYMMDDHHMMSS</code> .
System Variable Name	Enter a System Variable Name . The System Variable Name is used when searching for a System Variable and for display.
Long Description	Enter descriptive text explaining the function of the System Variable .
Type	Select the Type of Variable. Values are: <ul style="list-style-type: none"> • Date • DateTime • Text • Time • Number • True/False (This Variable Type accommodates Boolean values.)

Field or Control	Description
Base Application Package	<p>Enter the Base Application Package for this System Variable. The Base Application Package contains the logic that returns the System Variable. System Variables can only be assigned using application package PeopleCode. Delivered system variables have been created in the reserved application package: SCC_RULE_SYSTEM_VARIABLES:SystemVariables.</p> <hr/> <p>Note: Oracle expects to make new system variables available as needed.</p> <hr/>
Rule Category Name	Enter the Rule Category Name for this System Variable. This restricts direct access to specific System Variables.
List Variable	Select this check box if the System Variable needs to accommodate the return of multiple values.

For a complete listing of System Variables delivered with the system for use in Rules and Functions by an Expert user, see [Library of System-Delivered Rules Engine Objects](#)

Access the Define System Variables Cross Reference page (**Set up SACR > System Administration > Rules Engine > Setup > Define System Variables > Cross Reference**).

This example illustrates the fields and controls on the Define System Variables Cross Reference page. You can find definitions for the fields and controls later on this page.

Definition
Cross Reference

System Variable ID SCC_RULE_SYSVAR_20120822173654

System Variable Name Current Date

Rule Cross Reference				
Rule Name	Version	Rule Status	Variable Name	Rule Category Name
Test Date Functions (CALL all DateTime Functions)	1	Active	Current Date	SystemTest

This system variable is not used in any rule groups.

This page shows Rules and Rule Groups associated with this System Variable.

Field or Control	Description
Rule Name and Rule Group Name	<p>Displays to authorized users a link for any of these Rules Engine objects which use this System Variable. If a user is not authorized, the link is disabled.</p> <p>Click a link to transfer out of the component and to the referenced object.</p> <hr/> <p>Warning! Make sure you have saved any data that you need to before confirming you want to transfer to the referenced object in a new component.</p> <hr/> <p>If no objects use the System Variable, a notification is shown in place of the object details. for example, “This System Variable is not used by any Rule Groups”.</p>
Version	Displays the Rule Version Number.
Rule Status and Rule Group Status	Displays the status of the Rule Group or Rule Name (<i>In Progress, Active, In-active</i>).
Variable Name	Displays the name of the Variable associated with the System Variable.
Rule Category Name	Displays the Rule Category Name in which the Rule or Rule Group has been created.

Defining Rules Engine Data Sets

Data Sets can be used in Rules when you need to create placeholders or temporary storage for multiple Variables and reference those Variables together as a logical group. The Data Set can be used across any Rule in the system and is not specific for one Rule alone.

Access the Define Data Sets page (**Set up SACR > System Administration > Rules Engine > Setup > Define Data Sets**).

This example illustrates the fields and controls on the Define Data Sets page. You can find definitions for the fields and controls later on this page.

Define Data Sets
Cross Reference

System Data

Data Set ID SCC_ENTITY_20130306064022

Name AIR Courses

Description AIR Courses

Data Set Properties		
Label	Property Type	Details
Campus	String	Details
Catalog Number	String	Details
Course ID	String	Details
Course Offer Number	Number	Details
Course Topic	Number	Details
Descr	String	Details
Effective Date	Date	Details
Max Units	Number	Details
Min Units	Number	Details
Number of attempts	Number	Details
Subject Area	String	Details

Data Set Grouping	
Data Set Profile Name	
System Profile for Data Sets	

Field or Control	Description
Data Set ID	Displays a unique ID generated by the system. When adding a new value the default value is <i>NOID</i> . The unique ID is generated when the Data Set is saved. The Statement ID is created by combining prefix SCC_ENTITY_ with the system date and time stamp in format YYYYMMDDHHMMSS.
Name	Enter a Data Set Name . The Data Set Name is used when searching for a Data Set and for display.
Actions	<ul style="list-style-type: none"> • <i>Clone Data Set</i> – Select this option to copy from an existing Data Set. A prompt is presented from which a Data Set can be selected. • <i>Copy Properties from</i> – Select this option to copy from an Entity. A prompt is presented from which an Entity can be selected. A Data Set Property is created for each Property which exists on the selected Entity.
Description	Enter descriptive text explaining the function of the Data Set .

Field or Control	Description
Label	Enter a Label for each of your Data Set properties. This Label is used in the Rules Engine Manager to display the Data Set Property.
Property Type	Select the Property Type : <ul style="list-style-type: none"> • Date • DateTime • Number • String • Time
Details	Click on the Details link to access more information about each Data Set Property.

Access the Data Sets Details page (click the **Details** link on the Define Data Sets page).

This example illustrates the fields and controls on the Data Set Property Details page. You can find definitions for the fields and controls later on this page.

Data Set Property Details

Label	<input style="width: 80%;" type="text" value="APT Course Academic Item ID"/>
Property Name	<input style="width: 80%;" type="text" value="APT_Course_Academic_Item_ID"/>
Property Type	<input style="border-bottom: 1px solid #ccc;" type="text" value="String"/> ▼
Description	<div style="border: 1px solid #ccc; height: 100px; width: 100%;"></div>
LOV Unique ID	<input style="width: 40%;" type="text"/> <input style="width: 10px; height: 10px; border: 1px solid #ccc; border-radius: 50%; vertical-align: middle;" type="button" value="🔍"/>

The Data Set Property details page allows you to add a long Description for a Property and List of Values (LOV) which can be used to enforce Prompt Edits.

For more information, see *Defining Lists of Values for Rules Engine Variables*.

Field or Control	Description
Data Set Profile Name	Select Entity Profiles to associate multiple Data Sets to a group of Data Sets. The Category is used to search for Data Sets when associating Rules Engine Variables with created Data Sets. There is no security tied into this functionality. A created Data Set can be used by any Rule in the system.

Access the Define Data Sets Cross Reference page (**Set up SACR > System Administration > Rules Engine > Setup > Define Data Sets > Cross Reference**).

This example illustrates the fields and controls on the Define Data Sets Cross Reference page. You can find definitions for the fields and controls later on this page.

Define Data Sets
Cross Reference

Data Set ID SCC_ENTITY_20130306064022

Name AIR Courses

Rule Cross Reference
Personalize | Find | View All | | First 1-8 of 8 Last

Rule Name	Version	Rule Status	Variable Name	Rule Category Name
Copy of AIR function : AIR course	1	Active	Course DataSet	AIR Functions
Copy of AIR function : AIR course	1	Active	Course Information Retrieved	AIR Functions
SystemTest: Rule Retrieves AIR and Course Catalog Course information	1	Active	Course DataSet	AIR Functions
SystemTest: Rule Retrieves AIR and Course Catalog Course information	1	Active	Course Information Retrieved	AIR Functions
Test List Functions III (Data Set list)	1	Active	DataSetList2	SystemTest
Test List Functions III (Data Set list)	1	Active	DataSetList3	SystemTest
Test List Functions III (Data Set list)	1	Active	DataSetAux	SystemTest
Test List Functions III (Data Set list)	1	Active	DataSetList1	SystemTest

Rule Group Cross Reference
Personalize | Find | View All | | First 1 of 1 Last

Rule Group Name	Rule Group Status	Variable Name	Rule Category Name
Copy of AIR function	Active	Course Information Retrieved	AIR Functions

This page shows Rules and Rule Groups associated with this System Variable.

Field or Control	Description
Rule Name and Rule Group Name	<p>Displays to authorized users a link for either of these Rules Engine objects which use this Data Set. If a user is not authorized, the link is disabled.</p> <p>Click a link to transfer out of the component and to the referenced object.</p> <hr/> <p>Warning! Make sure you have saved any data that you need to before confirming you want to transfer to the referenced object in a new component.</p> <hr/> <p>If no objects use the Data Set, a notification is shown in place of the object details. for example, “This Data Set is not used by any Rule Groups”.</p>
Version	Displays the Rule Version Number.
Rule Status and Rule Group Status	Displays the status of the Rule Group or Rule Name (<i>In Progress, Active, In-active</i>).
Variable Name	Displays the name of the Variable associated with the System Variable.
Rule Category Name	Displays the Rule Category Name in which the Rule or Rule Group has been created.

Defining Lists of Values for Rules Engine Variables

This section discusses defining lists of values for use with Rules Engine Variables. There are cross references to information about adding lists of values to Entity Properties and Data Set Properties.

Understanding Lists of Values for Rules Engine Variables

List of Values (LOV) functionality allows you to add the functionality of prompting with edits against a defined List of Values where there were no edits defined before. In Rules Engine Manager, a LOV can be added to properties or variables of the following Types:

- Rules Engine Variable
- Entity Property
- Data Set Property

For example, take a Variable created in Rules Engine named “Institution” . When defined as a Variable of type String and referenced in a Rules Engine Rule, any String value can be added to the Variable and no editing is enforced. However, you may want to enforce that users can only add values to this

Variable that are valid according to the Institution Table defined in the system (Set up SACR, Foundation Tables, Academic Structure, Institution Table). In order to enforce that edit, you can define a LOV on the Institution Table. Once defined, the LOV can be tied to any Rules Engine Variable, Entity Property, or DataSet Property which has the same Type (for example, String) as the defined LOV.

LOV Prompts may already exist on an Entity Registry Property. The Entity Registry automatically adds a LOV prompt to a property for which the underlying record field contains a Prompt Table. Adding an LOV to a property which already has an automatic prompt table defined overwrites that functionality.

For the Lists of Values are delivered with the system for the Rules Engine, see [Library of System-Delivered Rules Engine Objects](#).

Note: Lists of Values delivered with the system cannot be modified, but the Test button can be used to test return of valid LOV values.

To understand more about how to add an LOV to an Entity Property, see [Setting Up Entity Registry](#), “Setting Up Entity Property Details.”

To understand more about how to add an LOV to a Data Set Property, see [Defining Rules Engine Data Sets](#).

To understand more about how LOV functionality can be used throughout the system, see [Setting Up List of Values](#).

Defining Lists of Values – Ad Hoc Values

Access the Define List Of Values page (**Set up SACR > System Administration > Rules Engine > Setup > Define List of Values**).

This example illustrates the fields and controls on the Define List of Values – Ad Hoc Values page. You can find definitions for the fields and controls later on this page.

Definition		Cross Reference
System Data		
LOV Unique ID	SCC_LOV_20130218102906	
Description	MinorMax	<input type="button" value="Test"/>
LOV Type		
<input checked="" type="radio"/> Ad Hoc Values <input type="radio"/> Table <input type="radio"/> Translate Values		
Ad Hoc Values		
Find View All First 1 of 2 Last		
Value	MAX	
Description	Maximum	

Select **LOV Type Ad Hoc Values** if you want to prompt on a user-defined Value or List of Values that is not related to a translate table or an existing prompt table.

Field or Control	Description
LOV Unique ID	Displays a unique ID generated by the system. When adding a new value the default value is <i>NOID</i> . The unique ID is generated when the LOV is saved. The UID is created by combining prefix <i>SCC_LOV_</i> with the system date and time stamp in format <i>YYYYMMDDHHMMSS</i> .
Description	Enter a LOV Description. The LOV Description is used when searching for a LOV and for display.
LOV Type – Ad Hoc Values selected	Create an LOV of <i>Ad Hoc Values</i> if you want to prompt on a user-defined value or List of Values that is not related to a translate table or an existing prompt table.
LOV Unique ID – Copy Ad Hoc Values From grid	Select an LOV to copy by using the Search icon to find an existing LOV Unique ID. Then add custom values in the Ad Hoc Values grid.
Value – Copy Ad Hoc Values grid	Enter an Ad Hoc Value from which you would like to copy existing Ad Hoc values.
Description – Copy Ad Hoc Values grid	Enter a Description for the Ad Hoc Value .
Test	Click the Test button to display a preview of the values that will be returned by the LOV when it is deployed as a prompt edit.

Defining Lists of Values – Table

Access the Define List Of Values page (**Set up SACR > System Administration > Rules Engine > Setup > Define List of Values**) and select the **Table** radio button.

This example illustrates the fields and controls on the Define List of Values – Table. You can find definitions for the fields and controls later on this page.

Definition
Cross Reference

LOV Unique ID SCC_LOV_20130225065837

Description RE Institution Table Look up

Rule Cross Reference				
Rule Name	Version	Rule Status	Variable Name	Rule Category Name
GetSessionInformation	1	Active	Institution	Student Records Generic
GetTermInformation	1	Active	Institution	Student Records Generic
ValidateStudentAPTCareer	1	Active	Institution	Student Records Generic
ValidateStudentAPTPlan	1	Active	Institution	Student Records Generic
ValidateStudentAPTProgram	1	Active	Institution	Student Records Generic
ValidateStudentAPTSubplan	1	Active	Institution	Student Records Generic

This list of values is not used in any rule groups

Select an **LOV Type** of *Table* if you want to prompt on an existing Campus Solutions Prompt Table.

Field or Control	Description
LOV Unique ID	Displays a unique ID generated by the system. When adding a new value the default value is <i>NOID</i> . The unique ID is generated when the LOV is saved. The UID is created by combining prefix <i>SCC_LOV_</i> with the system date and time stamp in format <i>YYYYMMDDHHMMSS</i> .
Description	Enter a LOV Description. The LOV Description is used when searching for a LOV and for display.
LOV Type – Table selected	Create an LOV of type <i>Table</i> if you want to prompt on an existing Campus Solutions Prompt Table.
Record	Enter the Record where the prompt is found.
Field	Select a Field for the prompt.
Description Field	Select the Field from which the description should be taken.
Prompt Table Filters	Select Field Names to further specify the selection. For example in case of the Honors and Awards Table, the setup is defined by Institution. To specify that only values from institution PSUNV be retrieved, add the Field Name <i>Institution</i> and Field Value <i>PSUNV</i> .

Field or Control	Description
Exclude Prompt Field Values	<ul style="list-style-type: none"> • Insert All Values – Click button to add all LOV values to the excluded values list. • Remove All Values – Click button to remove all LOV values from the excluded values list.
Test	Click the Test button to display a preview of the values that are returned by the LOV when it is deployed as a prompt edit. The Test functionality uses the Exclude Prompt Field Values and Prompt Table Filter settings.

Defining Lists of Values – Translate Values

Access the Define List Of Values page (**Set up SACR > System Administration > Rules Engine > Setup > Define List of Values**) and select the **Translate Values** radio button.

Create an LOV of type *Translate Values* if you want to prompt on an existing Campus Solutions Translate Value.

This example illustrates the fields and controls on the Define List of Values – Translate Values. You can find definitions for the fields and controls later on this page.

Definition | Cross Reference

System Data

LOV Unique ID SCC_LOV_20130220075625

Description APT Approval Status Test

LOV Type

Ad Hoc Values Table Translate Values

Define Translate Definition

Field SSR_ADVR_APPR_STAT

Translate Usage Use Long Description

Select an **LOV Type** of *Translate Values* if you want to prompt on an existing Campus Solutions Translate Values.

Field or Control	Description
LOV Unique ID	Displays a unique ID generated by the system. When adding a new value the default value is <i>NOID</i> . The unique ID is generated when the LOV is saved. The unique ID is created by combining prefix <i>SCC_LOV_</i> with the system date and time stamp in format <i>YYYYMMDDHHMMSS</i> .

Field or Control	Description
Description	Enter a LOV Description. The LOV Description is used when searching for a LOV and for display.
Field	Enter the Record where the prompt is found.
Translate Usage	Select the Translate Usage to be returned: <ul style="list-style-type: none"> • Use Long Description • Use Short Description
Exclude Prompt Field Values	<ul style="list-style-type: none"> • Insert All Values – Click button to add all LOV values to the excluded values list. • Remove All Values – Click button to remove all LOV values from the excluded values list.
Test	Click the Test button to display a preview of the values that will be returned by the LOV when it is deployed as a prompt edit. The Test functionality uses the Exclude Prompt Field Values and Prompt Table Filter settings.

Access the Define List of Values Cross Reference page (**Set up SACR > System Administration > Rules Engine > Setup > Define List of Values > Cross Reference**).

This example illustrates the fields and controls on the Define List of Values Cross Reference. You can find definitions for the fields and controls later on this page.

Definition
Cross Reference

LOV Unique ID SCC_LOV_20130225065837

Description RE Institution Table Look up

Rule Name	Version	Rule Status	Variable Name	Rule Category Name
GetSessionInformation	1	Active	Institution	Student Records Generic
GetTermInformation	1	Active	Institution	Student Records Generic
ValidateStudentAPTCareer	1	Active	Institution	Student Records Generic
ValidateStudentAPTPlan	1	Active	Institution	Student Records Generic
ValidateStudentAPTProgram	1	Active	Institution	Student Records Generic
ValidateStudentAPTSubplan	1	Active	Institution	Student Records Generic

This list of values is not used in any rule groups

This page shows Rules and Rule Groups associated with this System Variable.

Field or Control	Description
Rule Name and Rule Group Name	<p>Displays to authorized users a link for either of these Rules Engine objects which uses a variable with this List of Values. If a user is not authorized, the link is disabled.</p> <p>Click a link to transfer out of the component and to the referenced object.</p> <hr/> <p>Warning! Make sure you have saved any data that you need to before confirming you want to transfer to the referenced object in a new component.</p> <hr/> <p>If no objects use the List of Values, a notification is shown in place of the object details. for example, “This List of Values is not used by any Rule Groups”.</p>
Version	Displays the Rule Version Number.
Rule Status and Rule Group Status	Displays the status of the Rule Group or Rule Name (<i>In Progress, Active, In-active</i>).
Variable Name	Displays the name of the Variable that uses this List of Values.
Rule Category Name	Displays the Rule Category Name in which the Rule or Rule Group has been created.

Example of an LOV Added to a Property from Record Field Prompts

The following is an example of an Entity Registry LOV which has been added to the Property due to the fact that the underlying Record field was defined with a prompt table value. In this Rule, the Entity Academic Program is used to retrieve applicants.

This example illustrates the Define Rule page using a LOV from Field Record Prompts.

In this example in the **Criteria** grid, the **Type** of the Property with the **Label** of *EmplID* is set to *Text*. Click the Search prompt button to the right of the **Object** (value) for Property **EMPLID** to open a Lookup table. This is the PEOPLE_SRCH **Prompt** for table. This functionality also works whenever a Property with a Lookup table is used in combination with the Assign or IF Evaluative statements. The same Search values are available and, if relevant, permission level security is enforced:

This example illustrates the Prompt Window for Example Of Define Rule Page Using A LOV From Field Record Prompts.

The Search function behaves the same as if prompted from a normal search record or component:

This example illustrates Prompt Options from Component Search Record (Student Admissions, Application Maintenance, Maintain Applications).

Look Up ID
✕

ID: begins with ▼

Campus ID: begins with ▼

National ID: begins with ▼

Last Name: begins with ▼

First Name: begins with ▼

Look Up
Clear
Cancel
Basic Lookup

Search Results

View 100
First 1 of 1 Last

ID	Name	Gender	Date of Birth	Campus ID	National ID	National ID Country	NID Short Description	Last Name	First Name
SSRNL00002	Bermuda,Nils	Male	****/****	(blank)	*****	NLD	BSN	BERMUDA	NILS

The Lookup functionality for EmplID Property is enabled by the Entity Registry. To view the Entity Prompts, access the Entity Registry page (**Set Up SACR > System Administration > Entity > Entity Registry**).

This example illustrates the Entity Registry Window for Example of Define Rule Page Using a LOV from Field Record Prompts

The screenshot displays the 'Entity Registry' window, which is used for configuring entities. The window has a title bar 'Entity Registry' and a sub-header 'Entity Configuration'. The configuration details are as follows:

Entity ID:	SCC_ENTITY_20090521093827
Name:	Academic Program
Status:	Active
Entity Type:	Staged Entity
Description:	Academic Program
AppClass:	SAD_ADM_APPL:Accessors:AcademicProgram
Prod Record:	ADM_APPL_PROG
Stage Record:	SAD_APL_PRG_STG
Element (XML):	ADM_APPL_PROG
	<input type="checkbox"/> Apply Data Update Rule
Action:	

Select *Edit Properties* from the **Action** drop-down to view the Entity properties:

This example illustrates Entity Properties Window for Example Of Define Rule Page Using a LOV from Field Record Prompts.

Entity Properties												
Entity Name		Academic Program										
Property Details												
Order	Property Name	Property Type	Field Name	In Stage	In Production	Attribute	Viewable	Editable	Required	LOV	Details	
1	SCC_TEMP_ID	Number	SCC_TEMP_ID	<input checked="" type="checkbox"/>	<input type="checkbox"/>	<input type="checkbox"/>	<input checked="" type="checkbox"/>	<input checked="" type="checkbox"/>	<input type="checkbox"/>	<input type="checkbox"/>	Details	+ -
2	EMPLID	String	EMPLID	<input type="checkbox"/>	<input checked="" type="checkbox"/>	<input type="checkbox"/>	<input checked="" type="checkbox"/>	<input checked="" type="checkbox"/>	<input type="checkbox"/>	<input type="checkbox"/>	Details	+ -
3	ACAD_CAREER	String	ACAD_CAREER	<input checked="" type="checkbox"/>	<input checked="" type="checkbox"/>	<input type="checkbox"/>	<input checked="" type="checkbox"/>	<input checked="" type="checkbox"/>	<input checked="" type="checkbox"/>	<input type="checkbox"/>	Details	+ -
4	STDNT_CAR_NBR	Number	STDNT_CAR_NBR	<input checked="" type="checkbox"/>	<input checked="" type="checkbox"/>	<input type="checkbox"/>	<input checked="" type="checkbox"/>	<input checked="" type="checkbox"/>	<input type="checkbox"/>	<input type="checkbox"/>	Details	+ -
5	ADM_APPL_NBR	String	ADM_APPL_NBR	<input checked="" type="checkbox"/>	<input checked="" type="checkbox"/>	<input type="checkbox"/>	<input checked="" type="checkbox"/>	<input checked="" type="checkbox"/>	<input type="checkbox"/>	<input type="checkbox"/>	Details	+ -
6	APPL_PROG_NBR	Number	APPL_PROG_NBR	<input checked="" type="checkbox"/>	<input checked="" type="checkbox"/>	<input type="checkbox"/>	<input checked="" type="checkbox"/>	<input checked="" type="checkbox"/>	<input type="checkbox"/>	<input type="checkbox"/>	Details	+ -
7	INSTITUTION	String	INSTITUTION	<input checked="" type="checkbox"/>	<input checked="" type="checkbox"/>	<input type="checkbox"/>	<input checked="" type="checkbox"/>	<input checked="" type="checkbox"/>	<input checked="" type="checkbox"/>	<input type="checkbox"/>	Details	+ -
8	EFFDT	Date	EFFDT	<input type="checkbox"/>	<input checked="" type="checkbox"/>	<input type="checkbox"/>	<input checked="" type="checkbox"/>	<input checked="" type="checkbox"/>	<input type="checkbox"/>	<input type="checkbox"/>	Details	+ -
9	ACAD_PROG	String	ACAD_PROG	<input checked="" type="checkbox"/>	<input checked="" type="checkbox"/>	<input type="checkbox"/>	<input checked="" type="checkbox"/>	<input checked="" type="checkbox"/>	<input checked="" type="checkbox"/>	<input type="checkbox"/>	Details	+ -
10	EFFSEQ	Number	EFFSEQ	<input type="checkbox"/>	<input checked="" type="checkbox"/>	<input type="checkbox"/>	<input checked="" type="checkbox"/>	<input checked="" type="checkbox"/>	<input type="checkbox"/>	<input type="checkbox"/>	Details	+ -
11	PROG_STATUS	String	PROG_STATUS	<input checked="" type="checkbox"/>	<input checked="" type="checkbox"/>	<input type="checkbox"/>	<input checked="" type="checkbox"/>	<input checked="" type="checkbox"/>	<input checked="" type="checkbox"/>	<input type="checkbox"/>	Details	+ -
12	PROG_ACTION	String	PROG_ACTION	<input checked="" type="checkbox"/>	<input checked="" type="checkbox"/>	<input type="checkbox"/>	<input checked="" type="checkbox"/>	<input checked="" type="checkbox"/>	<input checked="" type="checkbox"/>	<input type="checkbox"/>	Details	+ -
13	ACTION_DT	Date	ACTION_DT	<input checked="" type="checkbox"/>	<input checked="" type="checkbox"/>	<input type="checkbox"/>	<input checked="" type="checkbox"/>	<input checked="" type="checkbox"/>	<input type="checkbox"/>	<input type="checkbox"/>	Details	+ -
14	PROG_REASON	String	PROG_REASON	<input checked="" type="checkbox"/>	<input checked="" type="checkbox"/>	<input type="checkbox"/>	<input checked="" type="checkbox"/>	<input checked="" type="checkbox"/>	<input type="checkbox"/>	<input type="checkbox"/>	Details	+ -
15	ADMIT_TERM	String	ADMIT_TERM	<input checked="" type="checkbox"/>	<input checked="" type="checkbox"/>	<input type="checkbox"/>	<input checked="" type="checkbox"/>	<input checked="" type="checkbox"/>	<input checked="" type="checkbox"/>	<input type="checkbox"/>	Details	+ -
16	EXP_GRAD_TERM	String	EXP_GRAD_TERM	<input checked="" type="checkbox"/>	<input checked="" type="checkbox"/>	<input type="checkbox"/>	<input checked="" type="checkbox"/>	<input checked="" type="checkbox"/>	<input type="checkbox"/>	<input type="checkbox"/>	Details	+ -
17	REQ_TERM	String	REQ_TERM	<input checked="" type="checkbox"/>	<input checked="" type="checkbox"/>	<input type="checkbox"/>	<input checked="" type="checkbox"/>	<input checked="" type="checkbox"/>	<input type="checkbox"/>	<input type="checkbox"/>	Details	+ -
18	ACAD_LOAD_APPR	String	ACAD_LOAD_APPR	<input checked="" type="checkbox"/>	<input checked="" type="checkbox"/>	<input type="checkbox"/>	<input checked="" type="checkbox"/>	<input checked="" type="checkbox"/>	<input checked="" type="checkbox"/>	<input type="checkbox"/>	Details	+ -

Prompt values present in a production record or staging record of an Entity are added to the Entity Registry automatically. Any Property which has inherited a Prompt from a production or staging record is displayed as view-only in the **LOV** column of the **Entity Properties** page. In this example the field EMPLID has inherited a prompt to the PEOPLE_SRCH table from the ADM_APPL_PROG production record:

This illustrates the Property and Prompt Table for Example of Define Rule Page Using a LOV from Field Record Prompts

Record Fields		Record Type							
	Nu	Field Name	Type	Req	Edit	Prompt Table	Set Control Field	Rs Dt	Event
	1	EMPLID	Char	Yes	Prompt	PEOPLE_SRCH		No	Yes
	2	ACAD_CAREER	Char	Yes	Prompt	STDNT_CAREER		No	Yes
	3	STDNT_CAR_NBR	Nbr	No				No	No
	4	ADM_APPL_NBR	Char	Yes	Prompt	ADM_APPL_DATA		No	No
	5	APPL_PROG_NBR	Nbr	No	Prompt	ADM_APP_CAR_SEQ		No	Yes

When the Academic Program Entity is used to build Rules in the Rules Engine Manager, the prompt to PEOPLE_SRCH becomes active. These prompts cannot be removed; however, they can be overridden by adding a new LOV Lookup Table value to the Property.

For an example of a LOV Look Up Table that is NOT present on the production or staging record and has been added to an Entity Property, select the **Details** link for property ACAD_CAREER in the **Entity Properties** page example. This opens the **Entity Properties Detail** page where an LOV Lookup Table can be added using the **LOV Unique ID** field for a relevant LOV:

This illustrates the Entity Property Details Window for Example of Define Rule Page Using a LOV from Field Record Prompts.

Entity Property Details

Property Name ACAD_CAREER

Property Type String

In Stage In Production Attribute List

Viewable Editable Required

Show LOV Description

Element (XML)

Default Value

Label

Description

LOV Unique ID Translate values of ACAD_CAREE

Note: The Rules Engine automatically enforces the security used by security views by the OPRID or OPRCLASS of the user who built the rule to the security view.

Note: %EDITABLE prompts do not enable look-up functionality in the Rules Engine.

Note: Performance should be considered when using prompts in the Rules Engine. Do not use look-up tables in the Rules Engine user interface without providing at least one relevant field value.

Constructing Rules

This section discusses how to:

- Use Rules Engine Search.
- Use Rule Engine Groups Search.
- Create Functional Rules.
- Add Variables to a Rule.

- Add Criteria to a Rule.
- Define Rule Groups.
- Define Rule Triggers.

You create all Rules, including Functions and Triggers, using the Rules Engine Manager. Functionality available to create Rules is determined by:

- Skill Level (Expert or Developer)
- Rule Usage (Rule, Function, or Trigger)
- Rule Category
- Rule Group

Depending on user security as set up in Rule Category Security, the Rules Engine Manager can be accessed using different Skill Levels. Skill Levels that can be selected are Expert or Developer, with Developer having ability to create Rules where the logic is defined in Application Class PeopleCode. Experts create Rule logic in the Rules Engine Manager Define Rule Page.

Note: Currently, the Rules Engine Manager can only be used by users with a Skill Level of *Expert* or *Developer*.

An Example Rule

To help describe the process of creating a new Rule, an example scenario of creating a new academic progression Rule is used throughout this documentation. This Rule evaluates data in the Academic Progress Tracker (APT). The example assumes that the Rule is run as part of a batch process at the end of a specific Academic Year; targeting all students in a specific Academic Program (Bachelor of Psychology) and student cohort. The purpose of the Rule is to find out whether students have obtained enough credits to progress to the from Year 1 to Year 2 of their academic program. The Rule is setup to run for a particular student.

Pages Used for Constructing Rules

Page Name	Definition Name	Navigation	Usage
Rule Search	SCC_RULE_SRCH_SEC	Set up SACR > System Administration > Rules Engine > Rules Engine Manager , select the Search for a Rule radio button and click Next.	Search for existing Rules. You can also save Searches.
Rule Group Search	SCC_RULEGRSRCH_SEC	Set up SACR > System Administration > Rules Engine > Define Rule Groups , select the Search for a Rule radio button and click Next.	Search for existing Rule Groups. You can also save Searches.

<i>Page Name</i>	<i>Definition Name</i>	<i>Navigation</i>	<i>Usage</i>
Define Rule	SCC_RULE_GOV	<p>Set up SACR > System Administration > Rules Engine > Rules Engine Manager, select the Search for a Rule radio button and click Next. Enter Search criteria, click the Search button, select a Rule from the results and click Next.</p> <p>Set up SACR > System Administration > Rules Engine > Rules Engine Manager, select the Add a New Rule radio button and click Next.</p> <p>Set up SACR > System Administration > Rules Engine > Rules Engine Manager, select the Create a Rule from a Rule radio button and click Next.</p> <p>Set up SACR > System Administration > Rules Engine > Rules Engine Manager, select the Create a Rule from a Rule radio button and click Next. Enter Search criteria, click the Search button, select a Rule Group from the results, and click Next.</p>	Define Rules.
Add a New Variable	SCC_RULE_VARD_SEC	Click the Add a New Variable button on the Define Rule page.	Add Variables to a Rule.

<i>Page Name</i>	<i>Definition Name</i>	<i>Navigation</i>	<i>Usage</i>
Rule Groups Categories	SCC_RULEGR_CAT	<p>Set up SACR > System Administration > Rules Engine > Define Rule Groups, select the Search for a Rule Group radio button and click Next. Enter Search criteria, click the Search button, select a Rule Group from the results, and click the Categories tab.</p> <p>Set up SACR > System Administration > Rules Engine > Define Rule Groups, select the Add a New Rule Group radio button, click Next and click the Categories tab.</p> <p>Set up SACR > System Administration > Rules Engine > Define Rule Groups, select the Create a Rule Group from Group radio button and click Next. Enter Search criteria, click the Search button, select a Rule Group from results, and click the Categories tab.</p>	Define valid Rule Categories for a Rule Group.

<i>Page Name</i>	<i>Definition Name</i>	<i>Navigation</i>	<i>Usage</i>
Define Rule Groups Definition	SCC_RULEGR_MGR	<p>Set up SACR > System Administration > Rules Engine > Define Rule Groups, select the Search for a Rule Group radio button and click Next. Enter Search criteria, click Search button, select a Rule Group from results.</p> <p>Set Up SACR > System Administration > Rules Engine > Define Rule Groups, select the Add a New Rule Group radio button and click Next.</p> <p>Set Up SACR > System Administration > Rules Engine > Define Rule Groups, select the Create a Rule Group from Rule radio button and click Next. Enter Search criteria, click the Search button, and select a Rule from the results.</p> <p>Set Up SACR > System Administration > Rules Engine > Define Rule Groups, select the Create a Rule Group from Group radio button and click Next. Enter Search criteria, click the Search button, and select a Rule Group from the results.</p>	Define Rule Groups.

Page Name	Definition Name	Navigation	Usage
Rule Groups Cross Reference	SCC_RULEGR_MGR	<p>Set Up SACR > System Administration > Rules Engine > Define Rule Groups, select the Search for a Rule Group radio button and click Next. Enter Search criteria, click the Search button, select a Rule Group from results, click the Cross Reference tab.</p> <p>Set Up SACR > System Administration > Rules Engine > Define Rule Groups, select the Add a New Rule Group radio button, click Next, and click the Cross Reference tab.</p> <p>Set Up SACR > System Administration > Rules Engine > Define Rule Groups, select the Create a Rule Group from Rule radio button and click Next. Enter Search criteria, click Search button, select a Rule from results, and click the Cross Reference tab.</p> <p>Set Up SACR > System Administration > Rules Engine > Define Rule Groups, select the Create a Rule Group from Group radio button and click Next. Enter Search criteria, click Search button, select a Rule Group from results, click the Cross Reference tab.</p>	View Rules associated with the Rule Group.
Define Rule Triggers	SCC_RULE_TRIG	Set Up SACR > System Administration > Rules Engine > Setup > Define Rule Triggers	Define Rule Triggers to determine from where in the system a Rule can be called.

Using Rules Engine Search

Rules Engine Search is the starting point for the following activities:

- Searching for Rules.
- Adding new Rules.
- Creating a new Rule from an existing Rule.

- Creating a new Rule for a Rule Group.

Access the Rules Engine Search page (**Set up SACR > System Administration > Rules Engine > Rules Engine Manager**).

This example illustrates the fields and controls on the Rules Engine Manager Search page. You can find definitions for the fields and controls later on this page.

Rules Engine Manager Search Option Information ?

Search for a Rule

Add a New Rule

Create a Rule from a Rule

Create a Rule from Rule Group

Next

Searching for a Rule

In the Rule Engine Manager search page, select **Search for a Rule** and click on the **Next** button to open Rules Search options page.

This example illustrates the fields and controls on the Rule Search Options page. You can find definitions for the fields and controls later on this page.

Rule Search Search Information ?

Saved Search 🔍

Save Delete

***Rule Category Name** 🔍

Rule Name

Rule ID

Rule Group Name

Long Description

Rule Usage ▼

Rule Status ▼

Entity Name 🔍

Search Reset

Select	Rule Name	Version	Status	Details
<input type="checkbox"/>	Copy of AIR function : AIR course	1	Active	🔍
<input type="checkbox"/>	SystemTest: Rule Retrieves AIR and Course Catalog Course information	1	Active	🔍

Cancel

Rule Category Name is a required field. If a unique **Rule ID** is known and the user has access to the Rule Category, the Rule Category is automatically selected and not required.

The following fields can be used with wildcard search option “%” and are *case-sensitive*:

- Rule Name
- Rule Group Name
- Long Description

Click the **Search** button and any results are displayed in a grid below the Search fields. If there are no results, a message appears.

Click the **Reset** button to clear the Search fields.

Click the **Cancel** button to return to the **Rules Engine Manager** search page.

To save the Search, enter a name in the **Saved Search** field and click the **Save** button.

To delete a **Saved Search**, enter the name in the **Saved Search** field and click the **Delete** button.

In the Search results grid, select the **Select** check box or click on the **Details** icon to select a Rule. Clicking the **Details** icon also displays a panel below the Search results grid displaying the **Long Description**, **Rule Category**, **Rule Group Name**, **Rule Usage**, and **Entity Name** of the Rule.

Click the **Next** button to open the selected Rule in the Rules Engine Manager and edit your Rule.

Click the **Previous** button to return to the Rules Engine Manager search page.

Adding a New Rule

In the Rules Engine Manager search page, select **Add a new Rule** and click on the **Next** button to open the Rules Engine Manager page where you can define the parameters of your new Rule.

For more information, see [Constructing Rules](#).

Creating a New Rule from an Existing Rule

In the Rules Engine Manager search page, select **Create a Rule from a Rule** and click on the **Next** button to open the Rule Search page.

When you have found the Rule you want to clone, click **Next** to open the **Create New Rule from Rule** page and provide a **New Rule Name** and/or **Long Description**.

This illustrates the Create New Rule From Rule page.

Create New Rule from Rule Page Help Text ?

Provide a Unique Rule Name

Rule Name: Precondition for 2155 : Expert

New Rule Name:

Change the Long Description if Appropriate

Long Description:

Student must have satisfied the requirements for 'Economics Year 1 Option List A' (1743), and must have completed MGMT 1001 with at least a grade of C.

A new Rule is created with Rule Status *In Progress* , and it inherits all the Variables, Criteria, and evaluative statements from the Rule you selected to clone

<i>Field or Control</i>	<i>Description</i>
New Rule Name	Enter a name for the new Rule. The New Rule Name must be different from the original Rule Name .
Long Description	The Long Description of the original Rule populates this field and can be edited for the new Rule.

Creating a New Rule from a Rule Group

In the Rules Engine Manager search page, select **Create a Rule from a Rule Group** and click on the **Next** button to open the Rule Group Search page, which is similar to the Rule Search page.

When you have found the Rule Group to which you want to add a Rule, click **Next** to open the **Create a New Rule from Rule Group** page and provide a **New Rule Name** and/or **Long Description**. A new Rule is created with **Rule Status** *In Progress*, and it has inherited the Input and Output Variables, Entity Profile, Rule Category Name, Rule Usage, Entity name, and Skill Level of the Rule Group to which it has been added. This means that the Rule Category Name, Rule Group Name, Rule Usage, Entity Name, and Skill Level are predetermined and cannot be altered for this new Rule.

Additional Rule Search Options

Access the Rule Definition page (**Set Up SACR > System Administration > Rules Engine > Rules Engine Manager**, select Search for a Rule, search for and select a Rule, Define Rule).

This example illustrates the fields and controls on the Rule Search Results and Select Action Options Example. You can find definitions for the fields and controls later on this page.

The screenshot displays a web interface for rule management. At the top, there are three tabs: 'Define Rule' (selected), 'Version History', and 'Cross Reference'. Below the tabs, the 'System Data' section contains the following information:

- Rule ID:** SCC_RULE_ID_20120716173508
- Version:** 1
- Rule Status:** Active
- Rule Name:** SubtractRound
- Long Description:** Subtract one value from another giving a result rounded to the precision. Result = Round(Value 1 - Value 2), Precision
- Rule Category Name:** Math
- Rule Group Name:** (empty)
- Rule Usage:** Function
- Entity Name:** (empty)
- Skill Level:** Developer
- Rule Application Class:** SCC_RULE_LIBRARY_GENERIC:Math:SubtractRound_V1
- Available To Be Used

At the bottom of the page, there are two buttons: 'Search Results' and 'Select Actions'.

Field or Control	Description
Search Result	Click this button to return to the Rule Search Options Page. Search results are displayed from last executed search, and the last selected Rule is highlighted. The Search Results button is only available when the search actions <i>Search for a Rule</i> or <i>Create Rule from Rule</i> are used.
Select Actions	Click this button to return to the Rules Engine Manager to select a new search action: <i>Search for a Rule</i> , <i>Add a new Rule</i> , <i>Create Rule from Rule</i> , or <i>Create a Rule from Rule Group</i> .

Using Rule Groups Search

Rule Groups Search is similar to Rules Engine Search and is the starting point for the following activities:

- Searching for a Rule Group.
- Adding a new Rule Group.
- Creating a new Rule Group from an existing Rule.
- Creating a new Rule Group from an existing Rule Group.

Access the Define Rule Groups Search page (**Set Up SACR > System Administration > Rules Engine > Define Rule Groups**).

Searching for a Rule Group

In the Rule Group search page, select **Search for a Rule Group** and click on the **Next** button to open Rule Group Search options page.

This example illustrates the fields and controls on the Rule Group Search Options page. You can find definitions for the fields and controls later on this page.

Rule Group Search Search Information ?

Saved Search

*Rule Category Name APT Functions

Rule Group ID

Rule Group Name

Long Description

Rule Usage

Rule Status

Entity Name

Select	Rule Group Name	Status	Details
<input checked="" type="checkbox"/>	Academic Progress Tracker Item	Active	<input type="button" value="Details"/>

Rule Category Name is a required field. If a unique **Rule Group ID** is known and the user has access to the Rule Category, the Rule Category is automatically selected and not required.

The following fields can be used with wildcard search option “%” and are *case-sensitive*:

- Rule Category Name
- Rule Name
- Rule Group Name
- Long Description

Click the **Search** button and any results are displayed in a grid below the Search fields. If there are no results, a message appears.

Click the **Reset** button to clear the Search fields.

Click the **Cancel** button to return to the **Define Rule Groups** search page.

To save the Search, enter a name in the **Saved Search** field and click the **Save** button.

To delete a **Saved Search**, enter the name in the **Saved Search** field and click the **Delete** button.

In the Search results grid, select the **Select** check box or click on the **Details** icon to select a Rule. Clicking the **Details** icon also displays a panel below the Search results grid displaying the **Long Description**, **Rule Category Name**, **Entity Name**, **Rule Usage**, and all Input and Output variables as they are key features of the Rule Group Template.

Click the **Next** button to open the selected Rule Group in the Rule Groups Manager and edit your Rule Group.

Click the **Previous** button to return to the Define Rule Groups search page.

Adding a New Rule Group

In the Define Rule Groups page, select **Add a New Rule Group** and click on the **Next** button to open the Rules Groups Definition page where you can define the parameters of your new Rule Group.

For more information, see *Defining Rule Groups*.

Creating a New Rule Group from an Existing Rule

In the Define Rule Groups search page, select **Create a Rule Group from Rule** and click on the **Next** button to open the **Rule Search** options page.

When you have found the Rule you want to base your new Rule Group on, click **Next** to open the Rule Groups Manager component. A new Rule Group is created with **Rule Group Status** *In Progress*, and it has inherited all the Variables, Entity Name, Skill Level and Rule Usage from the Rule you selected.

Note: The Rule Name is also copied. As a first step, you should rename the **Rule Group Name** to avoid confusion.

Creating a New Rule Group from an Existing Rule Group

In the Define Rule Groups search page, select **Create a Rule Group from Group** and click on the **Next** button to open the Rule Group Search page, which is similar to the Rule Search page.

When you have found the Rule Group that you want to clone for a new Rule Group, click **Next** to open the Rule Group Manager component. A new Rule Group is created with **Rule Group Status** *In Progress*, and it has inherited the Input and Output Variables, Entity Profile, Rule Category Name, Rule Usage, Entity Name, and Skill Level of the Rule Group chosen to clone.

Note: The Rule Group Name is also copied from the selected Rule Group. As a first step you should rename this Rule as to avoid confusion.

For more information on how to create and edit Rules, see *Defining Rule Groups*.

Additional Rule Group Search Options

Access the Rule Definition page (**Set Up SACR > System Administration > Rules Engine > Define Rule Groups**), select Search for a Rule Group, search for and select a Rule Group, Definition).

This example illustrates the fields and controls on the Rule Group Search Results and Select Action Options Example. You can find definitions for the fields and controls later on this page.

<i>Field or Control</i>	<i>Description</i>
Search Result	Click this button to return to the Rule Groups Search Options page. Search results are displayed from last executed search, and the last selected Rule Group is highlighted. The Search Results button is only available when the search actions <i>Search for a Rule Group</i> or <i>Create Rule Group from Group</i> are used.
Select Actions	Click this button to return to the Define Rule Groups search page to select a new search action: <i>Search for a Rule Group</i> , <i>Add a New Rule Group</i> , <i>Create a Rule Group from Rule</i> , or <i>Create a Rule Group from Group</i> .

Creating Functional Rules

The section describes how to create functional Rules.

Access the Rules Engine Manager Define Rule page (**Set up SACR > System Administration > Rules Engine > Rules Engine Manager**, select Add a New Rule, Define Rule).

This example illustrates the fields and controls on the Define Rule page. You can find definitions for the fields and controls later on this page.

Define Rule
Version History
Cross Reference

System Data

Rule ID	SCC_RULE_ID_20130521094603	Action	<input type="text" value=""/>
Version	1	Rule Build Status	Build Successful
Rule Status	Active	Status Last Date/Time	06/07/2013 10:28AM PDT
Rule Name	AM Fixed Penalty Rule		
Long Description	The AM Fixed Late Penalty inserts on a new result row for the student with the value indicated on the fixed late penalty rule.		
Rule Category Name	AM Calculation Rules		
Rule Group Name			
Rule Usage	Rule		
Entity Name			
Skill Level	Expert		
Logging Level	No Message Logging		
	<input checked="" type="checkbox"/> Available To Be Used		

▶ Variables

▶ Criteria

Evaluations and Calculations		Personalize Find First 1-4 of 4 Last
Active	Statement Description	Details
<input checked="" type="checkbox"/>	ASSIGN Penalized Mark = Penalty Mark	
<input checked="" type="checkbox"/>	IF Penalized Mark < Scale Minimum Mark	
<input checked="" type="checkbox"/>	- ASSIGN Penalized Mark = Scale Minimum Mark	
<input checked="" type="checkbox"/>	ASSIGN Result Sub Type = L, Include in Calc = Y, Result Status = 10, Penalized Mark = Penalized Mark	

Note: For Rules delivered with the system and that have *System Data* displayed in the Rules Engine user interfaces, only the **Long Description** can be modified.

Field or Control	Description
Rule ID	Displays a unique ID generated by the system. When adding a new value the default value is <i>NOID</i> . The unique ID is generated when the Rule is saved. The Rule ID is created by combining prefix <i>SCC_RULE_ID_</i> with the system date and time stamp in format <i>YYYYMMDDHHMMSS</i> .

Field or Control	Description
Action	<hr/> <p>Note: The list of available Actions is dynamic depending upon the Rule Status.</p> <hr/> <p>Note: For System-delivered Rules, only the <i>Build Rule</i>, <i>Create New Group from Rule</i>, <i>Create New Rule from Rule</i>, and <i>Update Status Information</i> (if Rule Status is <i>Not Built</i>) Actions are available.</p> <hr/> <p>Select an Action for this Rule Group:</p> <ul style="list-style-type: none"> • <i>Activate Rule</i> – An <i>In Progress</i> Rule can be activated using the Activate Rule Action. • <i>Build Rule</i> – Opens the Build Rule window. • <i>Create New Group from Rule</i> – Selecting this Action transfers you to the Rule Group component. This Action is only available when a Rule is <i>Active</i> and not used by another Rule. The parameters for the new Rule Group are predefined based on the Rule from which it is being created. • <i>Create New Rule from Rule</i> – This action clones the current Rule and creates a new Rule using the values from this Rule. <hr/> <p>Note: The Name of the new Rule is copied exactly from the current Rule so your first action should be to rename the Rule.</p> <hr/> <ul style="list-style-type: none"> • <i>Create New Version of Rule</i> – Use this Action to introduce changes to Active Rules. By design, Rules are versioned rather than effective dated. Only one Version of a Rule can be active at any given time. This Action creates a new Version of the Rule with status <i>In Progress</i>. Activating the newest Version inactivates the previous Version automatically. • <i>Delete Rule</i> – Rules can be deleted. When choosing this Action, a warning is displayed, and, after choosing “OK”, the Rule is deleted. • <i>Inactivate Rule</i> – An <i>In Progress</i> Rule can be inactivated using the Inactivate Rule Action. • <i>Remove Base Entity</i> – Use this Action to remove the Base Entity from this Rule. This Action is available when Rules have a status of <i>In Progress</i> or <i>Active</i>. For Active rules, the setup option to allow changes to active rules must be selected. If the Rule has references to any Entity or Property which is logically part of the Base Entity Hierarchy structure, for example a child Entity or Property, then a warning is displayed. <hr/> <p>Note: The Base Entity cannot be removed if the Rule is attached to a Rule Group.</p>

Field or Control	Description
	<ul style="list-style-type: none"> <li data-bbox="865 226 1474 373">• <i>Remove Rule Group from Rule</i> – If you use this Action, create new version of Rule and deselect the “Available in Other Rules” check box in the old Version/inactivated version. This Action is only available when a Rule is part of a Rule Group and has a Rule Status of <i>In Progress</i>. <hr/> <p data-bbox="911 407 1474 464">Note: Concerning the effects of adding a New Rule Group to an existing Rule: When a Rule Group needs to change and new Input or Output Parameters need to be added or removed, the process requires that you create a new copy (clone) of the Rule Group. New Parameters and Fields are then added to the New Rule Group. As the Rule Group provides the template for Rule Input and Output, all Rules associated with the old Rule Group need to move to the new Rule Group. This can be done using the following steps:</p> <ol style="list-style-type: none"> <li data-bbox="911 688 1474 745">1. Deselect the Available in Other Rules option of the Rule attached to old Rule Group. <li data-bbox="911 751 1474 835">2. Create a new Version of the Rule attached to the old Rule Group. This action creates a new Version of the Rule with a Rule Status of <i>In Progress</i>. <li data-bbox="911 842 1474 898">3. Remove the Rule Group attached to the new Version of the Rule. <li data-bbox="911 905 1474 961">4. Add a new Rule Group to the new Version of the Rule. <p data-bbox="911 968 1474 1066">When a Rule Group is removed using the <i>Remove Rule Group from Rule</i> option, a new Rule Group can be added using the Rule Group Name prompt search. When adding a Rule Group to a Rule, the Rule must have the same or fewer input and output parameters than the Rule Group. New input and output Parameters can be added from the Rule Group to a Rule. In the case where there are input or output parameters defined on the Rule which do <i>not</i> exist in the Rule Group, they must be removed from the Rule first before adding it to the Rule Group.</p> <p data-bbox="911 1073 1474 1318">Make any other needed changes to the new Version of the Rule, build the Rule, and test all changes. Then, activate the new Version of the Rule. The old version of the Rule is automatically deactivated.</p> <hr/> <ul style="list-style-type: none"> <li data-bbox="865 1360 1474 1444">• <i>Test Rule</i> – Opens the Test Rule window. For more information, see <i>Testing Rules</i>. <li data-bbox="865 1472 1474 1528">• <i>Update Status Information</i> – Use this Action to refresh page information and view the latest Rule Build Status.
Version	<p data-bbox="865 1577 1474 1612">Displays the Version number of the Rule.</p> <p data-bbox="865 1640 1474 1801">Rules are automatically versioned. The first version of a Rule is 1. Only one version of a Rule can be active at any given time. The Action drop down can be used to inactivate an <i>Active</i> Rule and to create a new Rule Version. When creating a new Version, the previous Version automatically becomes <i>Inactive</i>.</p>

Field or Control	Description
Rule Status	<p>Displays the Rule Status</p> <ul style="list-style-type: none"> • Active • Inactive • In Progress. This is the initial Rule Status assigned when creating a Rule.
Rule Build Status	<p>Displays the Rule Build Status. Values are:</p> <ul style="list-style-type: none"> • <i>Rule Not Built</i> – The Rule has never been built. • <i>Build Not Current</i> – A change has been made to this Rule since the last build which may warrant a rebuild.) • <i>Build Failed</i> – The build/compilation process for the Rule ran to error. Consult the process scheduler message log to view the error. • <i>Build Successful</i> — The Rule was built without errors.
Status Last Date/Time	<p>Displays the Last Date/Time of the Rule Build Status in native format including an indication of time zone. This field does not display until after an attempt to build this Rule.</p>
Rule Name	<p>Enter a Rule Name. The Rule Name is used when searching for a Rule and for display.</p>
Long Description	<p>Enter descriptive text explaining the function of the Rule.</p>
Rule Category Name	<p>Enter the Rule Category Name. The Rule Category restricts access to Rule Usages, Rule Categories, and Entities.</p> <p>Available Rule Categories are limited to those for which you have been authorized. This is determined by a Role or our User ID.</p> <p>If you have access to multiple Rule Categories, you should choose the Rule Category that is most appropriate considering the data that the Rule needs to access and any Functions that the Rule may need to call. Functional Expert users who create Rules may not necessarily be familiar with how to create Rule Categories so should be provided with instructions by Rules Engine Administrators about the Rule Categories for which they have been authorized. For example, depending on your institution's policy, Functional Experts may only be authorized to use a single Rule Category.</p>

Field or Control	Description
Rule Group Name	<p>Enter a Rule Group Name if this Rule needs to conform to a specific template with predefined input and output Variables and a predetermined Base Entity.</p> <hr/> <p>Note: Oracle recommends adding a Rule Group Name directly after you have created your Rule or Function and before adding Entity Profiles, Rule Usages, or Variables as they may conflict with those that are defined in the Rule Group. If you select a Rule Group that has Variables, a Rule Usage, or Base Entity that conflicts with the Rules you are creating, a warning message appears and the Rule Group is not added.</p> <hr/>

Field or Control	Description
Rule Usage	<p>Select a Rule Usage of <i>Function, Rule, or Trigger</i>. The available Rule Usages are limited to those for which the user has been authorized through Rule Category setup.</p> <p>The selected Rule Usage impacts availability of Rules Engine Manager functionality as follows:</p> <ul style="list-style-type: none"> • Rule: The Criteria grid, the Variables Grid, and Evaluations and Calculations grids are available. • Function or Trigger: The Variables grid and Evaluations and Calculations grids are available. The Criteria grid is not available. <p>Selection of Rule Usage needs to consider how this Rule is used and what tasks it needs to perform.</p> <ul style="list-style-type: none"> • Rule – Rules can be used stand-alone (when executed from the Rules Tester), called from other Rules, or called from a Batch Process. Rules need criteria in order for the correct data to be selected from the system. • Trigger – Triggers are meant to be tied to a specific system event using the Trigger component. Triggers which are delivered with the System can be versioned; unlike other Rules or Functions. This means that when a Trigger has been attached to a Trigger component and marked as System, you can create a new Version of the Trigger which can subsequently be edited. • Function – A Function is a reusable Rule that performs a specific task, often performed in the context of a larger Rule. For example, when creating a Rule that evaluates whether Total Credit is greater than a specific Credit amount, first the Sum of all Credit needs to be established. The “Add” Function could be used to do nothing other than add retrieved Credit to a Credit total. The “Add” Function could be used to add any numeric value in the system, not just Credit, making it very reusable. A Function does not need specific criteria in order to determine an exact set of data. In this Rule Creation example, it only needs a numeric input to perform its task. <p>When a Function uses a Base Entity, information to determine an exact set of data is passed from the calling Rule to the called Function using Contextual Reference.</p> <p><i>See Understanding Contextual Referencing.</i></p> <p>This example is using a Rule Usage of <i>Rule</i> and Skill Level of <i>Expert</i> to demonstrate the use of Criteria to identify a specific set of data. The Criteria in this example are used to identify the exact student Academic Progress Tracker data from the Base Entity as chosen by selecting an Entity Name. If data from other application areas is needed, it can be collected using other Functions.</p>

Field or Control	Description
Entity Name	<p>Enter the Entity to use as the Base Entity for the Rule. The Base Entity controls which application data you have access to when creating a <i>Rule</i>, <i>Function</i>, or <i>Trigger</i>. The Entities available are limited to those for which user has been authorized by attaching Entity Profiles to Rule Categories in the Rule Category setup.</p> <p>Identifying which data to use by designating the Base Entity can be considered the “starting point” of the creation of a functional Rule. Further, using the designated Base Entity with the Rule Criteria makes it possible to identify the exact record to use in the Rule. For a Function that uses a Base Entity, the exact data needed is passed from caller to called Function using Contextual Reference.</p> <p>In this example, a Rule is being created that look at Student Progression; therefore, the Rule needs to access Student Results Data as stored in the Academic Progress Tracker (APT) records. The APT data is represented in the Entity <i>APT Header</i>. By selecting the APT Header as the Base Entity, you can access all of the data associated with the APT Header Entity Tree. This means that you have access to all logical child Entities in that Tree structure like APT Program of Study, APT Course List, and APT Course as well as other data associated with those Entities.</p> <p>As with Rule Categories, Functional Expert users should be provided with instructions on selecting Base Entities. Also consider that since the available Base Entity is determined by the selected Rule Category, it could be that only one Base Entity is presented for selection.</p> <p>For more information, refer to <i>Defining Rule Category Security</i> and <i>Understanding Contextual Referencing</i>.</p> <p>See Setting Up Entity Registry.</p>
View Entity Hierarchy	Click this link to display the Entity Hierarchy view for the Base Entity attached to the Rule.
Skill Level	<p>Select the Skill Level required for creating this Rule:</p> <ul style="list-style-type: none"> • <i>Expert</i> – This Skill Level has access to all features delivered with Rules Engine. • <i>Developer</i> – This Skill Level has limited access to Rules Engine features. A user accessing the Rules Engine Manager and selecting <i>Developer Skill Level</i> is assumed to create Rules using Application Package PeopleCode. The Criteria Grid and Evaluations and Statements Grid are not available with <i>Developer Skill Level</i>. <p>In this example, a functional Rule is being created and there is no “coding” occurring. Therefore, a Skill Level of <i>Expert</i> is being used to demonstrate the Statement, Operator, Function, and Variable features.</p>

Field or Control	Description
Rule Application Class	<p>Note: This field is available and required when Skill Level is <i>Developer</i>.</p> <hr/> <p>Enter or select a Rule Application Class. A Rule Application Class can be selected from a list of Extension Application Classes.</p> <hr/> <p>Warning! Developer Rules should be built by Developers/ Programmers who have extensive experience with Application Package/Class PeopleCode programming. Developers working with the Rules Engine should be familiar with Entity Registry concepts.</p> <hr/>
Entity Data Load Option	<p>Note: This field is available and required when the Rule Usage is <i>Rule</i> and an Entity Name has been entered.</p> <hr/> <p>Select the Data Load Option when creating a Rule.</p> <ul style="list-style-type: none"> • <i>Select Data by Criteria:</i> This is the default option. The Criteria grid is available. Data from the attached Entity is selected according to Criteria provided. • <i>Select All Data:</i> The Criteria grid is not available. All data is retrieved from attached Entity and brought into the Rule. • <i>Select No Data:</i> The Criteria grid is not available. No data is retrieved from the attached Entity. Use this option when the intent is to insert a new row of data into the Base Entity using the CREATE-ENTITY statement without first retrieving data.

Field or Control	Description
Logging Level	<p>Select the Logging Level to use when testing this Rule:</p> <ul style="list-style-type: none"> • <i>Error Messages</i> – The first level of logging. This option only show errors. • <i>Informational Messages</i> – This option shows all informational messages. • <i>No Message Logging</i> – Turns off logging at the build level. <hr/> <p>Note: Oracle recommends that all Rules run on a production environment have this setting to optimize performance.</p> <hr/> <ul style="list-style-type: none"> • <i>Trace Logging</i> – Show all errors, warning, errors, information messages, and the following: <hr/> <p>Note: Oracle recommends using the <i>Trace Logging</i> option to see correct trace results when testing Rules.</p> <hr/> <ul style="list-style-type: none"> • Statements <p>Descriptions from the Rules Engine for every Statement that is run. If the internal Function has Trace Logging, its Statements are also shown. An internal Function is a Function which is called by the main Rule. If the Function itself does not have Trace Logging settings, no trace options are shown for the called Function.</p> • Variable Maps <p>The complete Variable Map, every variable and its value, is shown at the beginning and the end of each run along with any Variable Map for any called Function or Rule if Trace Logging for that Function or Rule is turned on.</p> <p>A Variable map example is Assign V_StudentID = ‘SSRN0012’ as an example to where a Variable is assigned.</p> • Call Statements <p>All arguments sent in and all returns received in the log file.</p> • XML Dump of the Entity Before Rule Execution <p>The XML Dump is created for rules with Entity Processing. The XML Dump contains a dump of the Base Entity prior to Entity processing.</p> • XML Dump of the Entity after Rule Execution <p>The XML Dump is created for rules with Entity Processing. The XML Dump contains a dump of the Base Entity after Entity processing has completed.</p>

Field or Control	Description
	<p>Any changes to the Entity (inserted or updated data) are reflected in the Entity Dump.</p> <ul style="list-style-type: none"> • <i>Warning Messages</i> – This options shows all errors and warnings. • <i>Write to Log</i> – Select this option to create a log file when processing Rules in Batch. <i>Write to Log</i> can be used in combination with Statement “Write To Log” <hr/> <p>Note: Oracle recommends using the <i>Trace Logging</i> option to see correct trace results when testing Rules.</p>
Available To Be Used	<p>Select this check box if you want to allow this Rule or Function to be available for use by other Rules or feature functionality. If you do select this check box, it is recommended that you do so <i>after</i> adding Variables and Criteria to the Rule and finalizing the functionality for your Rule.</p>

Note: Save the Rule after completing the first portion of the Definition tab (everything above the **Available in Other Rules** check box) *and before* adding Variables and Criteria. At this point the **Rule Status** is *In Progress*, and the Rule can still be changed and retested.

Note: You *cannot* version Rules with a **Rule Usage** of *Rule* or *Function* that are delivered with the System and that have *System Data* displayed in the Rules Engine user interfaces. These Rules must be copied (cloned) and a new Rule or Function created.

You *can* version Rules with a **Rule Usage** of *Trigger* that are delivered with the System and have *System Data* displayed in the Rules Engine user interfaces.

Adding Variables to a Rule

Once Rule options are defined, you can add the Variables you want to use in the Rule. The Variables grid on the Rules Engine Manager Definitions tabs is display-only. The grid shows whether variables are in use and whether they are used as input, output or required. Variables can be created before starting to incorporate evaluations or calculations or added on the fly.

Since the object of this example Rule is to determine whether students may or may not progress from Year 1 to Year 2 within an Academic Program, you already know that you want to return the Progression Status as *output*. You also know that you want to ensure that the process that calls this Rule can pass the correct parameters to retrieve a specific student. That is our *input*.

To add a Variable, access the Add a New Variable page (click the **Add a Variable** button on the Rule Definition page).

This example illustrates the fields and controls on the Add a New Variable page. You can find definitions for the fields and controls later on this page.

Add a New Variable

Type

List System Variable

*Argument Name

*Long Description

Input Output

LOV Search Name

Default Value

<i>Field or Control</i>	<i>Description</i>
Type	<p>Select the Variable Type that you want to add:</p> <ul style="list-style-type: none"> • <i>Data Set</i> • <i>Date</i> • <i>Datetime</i> • <i>Number</i> • <i>Text</i> • <i>Time</i> • <i>True/False</i> <p>Type is displayed in the Variables grid and can be selected when viewing or adding Variables.</p>
List	<p>Select this check box if the variable is a List variable which can contain multiple values. Use this option in combination with Type to obtain a list of specific values. List is displayed in the Variables grid and can be selected when viewing or adding Variables. Selecting this check box activates the Default Values button and the Default List Values field.</p>
System Variable	<p>Select this check box if the variable is a System Variable predefined in setup outside of this Rule. System Variable is displayed as <i>System</i> in the Variables grid and can be selected when viewing or adding Variables. Selecting this check box activates the System Variable Search button and the System Variable Name field.</p>

Field or Control	Description
Argument Name	Enter an Argument Name for Variable. The Argument Name is used when searching for a Variable and for display.
Long Description	Enter descriptive text explaining the function of the Variable .
Input	Select this check box if the variable is an Input Variable. Input is displayed in the Variables grid and can be selected when viewing or adding Variables .
Required	Select this check box if the variable is required. Required is displayed in the Variables grid and can be selected when viewing or adding Variables .
Output	Select this check box if the variable is an Output Variable. Output is displayed in the Variables grid and can be selected when viewing or adding Variables .
Default Value	<p>Click this button to open the Create Default List Values page. Add List Values in the Value column and click the OK button.</p> <hr/> <p>Note: This button is available when the <i>List</i> option is selected.</p> <hr/> <p>To remove a List Value, select the corresponding Remove check box for a Value and click the Remove Selected Values button.</p> <hr/> <p>Note: If the <i>List</i> option is not selected, Default Value is an edit field. A Default Value can be entered here for this Variable.</p> <hr/>
Default List Values	Displays values for this Variable created using the Create Default List Values page.
System Variable Search	Click this button to open the Prompt for Rules Engine System Variables page. This button only appears when System Variable is selected above.
System Variable Name	Displays the selected System Variable Name. This field only appears when System Variable is selected above.

Field or Control	Description
LOV Search	<p>Click this button to open the Prompt for LOV Searches page.</p> <p>Search on a Field Name of <i>Description, Dropdown Prompt Filed, Edit Table, LOV Context, or LOV Unique ID</i>.</p> <p>Results display a Descr (description) link. Click the link to select an LOV. This returns you to the Add a New Variable page with the LOV Search Name displayed.</p> <hr/> <p>Note: LOV Search results display a list of all available LOV values. The list is not limited to those LOV values which have been created specifically for the Rules Engine.</p> <hr/>
Delete LOV	Click this button to remove an LOV. This button becomes visible when a LOV has been attached to the variable
LOV Search Name	Displays selected LOV.
Default Value Search	<p>Click this button to open the Prompt for (selected LOV) page.</p> <p>Search on a Field Name of <i>Description or Value</i>.</p> <p>Results display a Values link.</p> <p>Click the link to select a Default Value. This returns you to the Add a Variable page with the Default Value displayed.</p>
Default Value	Displays Default Value .
Clear Default Value	Removes default value from Variable.

Adding a Data Set Variable to a Rule

When a *Data Set* variable **Type** is selected, there are different options to select.

This example illustrates the fields and controls on the Add a New Variable – Data Set Option. You can find definitions for the fields and controls later on this page.

Add a New Variable

Type List System Variable

***Argument Name**

***Long Description**

Input Output

Data Set Name AIR Courses

Data Set Properties		
	Property Type	Label
1	String	Campus
2	String	Catalog Number
3	String	Course ID
4	Number	Course Offer Number
5	Number	Course Topic
6	String	Descr
7	Date	Effective Date
8	Number	Max Units
9	Number	Min Units
10	Number	Number of attempts
11	String	Subject Area

▶ Variables

Field or Control	Description
Data Set Search	<p>Click this button to open the Prompt for Entity page.</p> <p>Search on a Field Name of <i>Data Set ID</i>, <i>Entity Name</i>, or <i>Entity Profile Name</i>.</p> <p>Results display a Entity Profile link. Click the link to select an Entity. This returns you to the Add a New Variable page with the Data Set Name and the Data Set Properties grid displayed. The Data Set Properties grid displays the Property Type and Label of each Variable in the Data Set</p>
Data Set Name	Displays the Data Set Name.
Clear Data Set Value	Click this button to remove the Data Set from the Variable.

Field or Control	Description
Edit Data Set	Click this button to open a secondary page to add default values to the Data Set.

Adding Criteria to a Rule

Once Rule options are defined and Variables are added for a **Rule Usage** of *Rule*, you can add Criteria to identify data from the chosen Base Entity. In the example being followed in this documentation, you want to add all criteria needed to identify and select the correct APT instance record for a particular student.

Note: If you are creating a Rule with a **Rule Usage** of *Function*, there is no option to add Criteria. For more information, see *Understanding Contextual Referencing*.

To add **Criteria**, expand the Criteria group box by clicking the arrow to the left of **Criteria** in the group box header.

This example illustrates the fields and controls on the Criteria Grid – Initial Row. You can find definitions for the fields and controls later on this page.

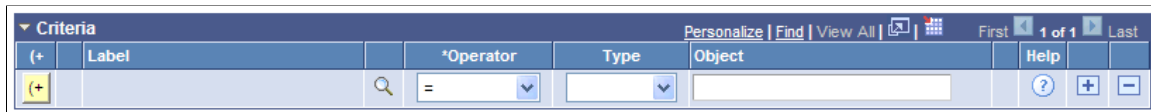

Then, click the Search icon to the right of the **Label** field to open the **Prompt for** page where you can select an Entity Property.

This example illustrates the fields and controls on the Prompt for page. You can find definitions for the fields and controls later on this page.

*Field Name contains

Property	Entity	Type	Key
ID	APT Header	String	*
Academic Institution	APT Header	String	*
APT Instance	APT Header	Number	*
Academic Career	APT Header	String	
Student Career Nbr	APT Header	Number	
Academic Plan	APT Header	String	
Academic Item ID	APT Header	String	
APT Status	APT Header	String	
Advisor Approval Status	APT Header	String	
Cohort ID	APT Header	String	
Cohort Term	APT Header	String	
Requirement Term	APT Header	String	
Locked	APT Header	String	
Created By	APT Header	String	
Created	APT Header	Datetime	
Updated By	APT Header	String	
Last Update Date/Time	APT Header	Datetime	

Click the *Academic Institution* link to select it as a **Property**. The Prompt for page closes, and you return to the **Criteria** grid with the **Label** column in the first row populated with *Academic Institution*. The Operator you want to use is = and the Variable Type you want to use is *Variable*, both of are already populated by default in this case. Since Type Variable is selected, the Search icon appears to the right of the **Object** field.

This example illustrates the fields and controls on the Example of Criteria Grid – Label Populated. You can find definitions for the fields and controls later on this page.

Criteria		Personalize Find View All			First	1 of 1	Last
(+)	Label	*Operator	Type	Object	Help		
(+)	Academic Institution	=	Variable		?	+	-

Click the Search icon to the right of the Object field to open the **Add/Select Variable** page.

This example illustrates the fields and controls on the Add/Select a Variable page. You can find definitions for the fields and controls later on this page.

Add/Select a Variable

Variables								
Type	*Argument Name	*Long Description	List	System	Input	Output	Required	
<input type="checkbox"/>	Text	Institution	Institution	<input type="checkbox"/>	<input type="checkbox"/>	<input checked="" type="checkbox"/>	<input type="checkbox"/>	<input checked="" type="checkbox"/>
<input type="checkbox"/>	Text	Academic Career	Academic Career	<input type="checkbox"/>	<input type="checkbox"/>	<input checked="" type="checkbox"/>	<input type="checkbox"/>	<input checked="" type="checkbox"/>
<input type="checkbox"/>	Text	Emplid	Emplid	<input type="checkbox"/>	<input type="checkbox"/>	<input checked="" type="checkbox"/>	<input type="checkbox"/>	<input checked="" type="checkbox"/>
<input type="checkbox"/>	Text	Cohort Term	Cohort Term	<input type="checkbox"/>	<input type="checkbox"/>	<input checked="" type="checkbox"/>	<input type="checkbox"/>	<input checked="" type="checkbox"/>
<input type="checkbox"/>	Text	Academic Item ID	Academic Item ID	<input type="checkbox"/>	<input type="checkbox"/>	<input checked="" type="checkbox"/>	<input type="checkbox"/>	<input checked="" type="checkbox"/>
<input type="checkbox"/>	Text	APT Status	APT Status	<input type="checkbox"/>	<input type="checkbox"/>	<input checked="" type="checkbox"/>	<input type="checkbox"/>	<input type="checkbox"/>
<input type="checkbox"/>	Text	Year of Program	Year of Program	<input type="checkbox"/>	<input type="checkbox"/>	<input checked="" type="checkbox"/>	<input type="checkbox"/>	<input checked="" type="checkbox"/>
<input type="checkbox"/>	Text	ProgressionOutcome	ProgressionOutcome	<input type="checkbox"/>	<input type="checkbox"/>	<input type="checkbox"/>	<input checked="" type="checkbox"/>	<input type="checkbox"/>
<input type="checkbox"/>	Text	AcademicYear	AcademicYear	<input type="checkbox"/>	<input type="checkbox"/>	<input checked="" type="checkbox"/>	<input type="checkbox"/>	<input checked="" type="checkbox"/>
<input type="checkbox"/>	Text	ValidCourse	ValidCourse	<input type="checkbox"/>	<input type="checkbox"/>	<input type="checkbox"/>	<input type="checkbox"/>	<input type="checkbox"/>

Select the check box next to the Variable you want to add, and click the Add button.

Once you've selected all the Criteria you want to add, the Criteria grid looks something like this:

This example illustrates the fields and controls on the Example of Criteria Grid. You can find definitions for the fields and controls later on this page.

Criteria

	(+)	Label	*Operator	Type	Object	Help		
	(+)	Academic Institution	=	Variable	Institution	?	+	-
And	(+)	Academic Career	=	Variable	Academic Career	?	+	-
And	(+)	ID	=	Variable	Emplid	?	+	-
And	(+)	Cohort Term	=	Variable	Cohort Term	?	+	-
And	(+)	Academic Item ID	=	Variable	Academic Item ID	?	+	-
And	(+)	APT Status	=	Variable	APT Status	?	+	-

In this example, there is an assumption that a batch process is responsible for supplying the correct Variables to our Rule. This is why the Variables selected for the Criteria grid are Input Variables.

Here is more information about fields in the Criteria grid:

Field or Control	Description
Label	Displays the name of the Property . Clicking the Search icon to the right of the Label field opens the Prompt for page where you can select from a list of properties from the Base Entity that is added in field Entity Name on the Rule Definition page.
Connectors and Parentheses	In the left-most columns of the Criteria grid are the AND/OR connectors and parenthesis. Select these to create complex (nested) Select Criteria.

This example illustrates the fields and controls on the Example of Connectors and Parentheses. You can find definitions for the fields and controls later on this page.













 Add Parenthesis to the left of the criteria

 Add Parenthesis the right of the criteria

 Remove Parenthesis from left of criteria

 Remove Parenthesis from right of criteria

For example:

And		(ID		=	Variable	Emplid					
Or	)	APT Instance		=	Variable	APTInstance	)			

Field or Control	Description
Operator	<p>Select an Operator to relate the Property Label to the Type/Variable. The Operator is a symbol or function used to express a mathematical function or logical action. The following Operators can be used when adding a Criteria line:</p> <ul style="list-style-type: none"> • < (less than) • <= (less than or equal to) • <> (not equal to) • = (equal to) • > (greater than) • >= (greater than or equal to) • <i>Exists</i> and <i>Not Exists</i> – The <i>Exists</i> and <i>Not Exists</i> operators can be used in combination with Types Text, Variable, Numbers, Date, Datetime, and Time. When using these Operators, an argument only exists on the left side of the operator, the Label. These Operators work differently based on the Object type: <ul style="list-style-type: none"> • If the Object is a string, <i>Exists</i> is true if Argument 1 is a non-blank value. • If the Object type is a number, <i>Exists</i> is true then whenever a value greater than 0 is found. • If the Object type is a date, time or date time, <i>Exists</i> is true if the value is anything other than null. • If the Object type is Boolean, the operator always returns <i>True</i> since true and false are both valid values. • <i>In</i> and <i>Not In</i> – The <i>In</i> and <i>Not In</i> operators can only be used in combination with Type of <i>Variable</i>. The Variable in question needs to be a Variable of type List. • <i>Like</i> and <i>Not Like</i> – The <i>Like</i> and <i>Not Like</i> operators can be used in combination with Type Text and Variable. Numeric values in string fields can also be evaluated: <ul style="list-style-type: none"> • “%” (percent sign) – Use at the beginning or end of string to replace any length value in the comparison. • “_” (underscore) – Use to replace a single alphabetic value in the comparison. • “#” (hash or pound sign) – Use to replace a single numeric value in the comparison. • <i>AsOfDate</i> – This operator automatically performs Effective Date selection as per standard Effective Dated processing. The <i>AsOfdate</i> operator is only available when the Base Entity has an Effective Date Key field.

Field or Control	Description
	<ul style="list-style-type: none"> • <i>FirstSeq</i> and <i>LastSeq</i> – These operators allow you to select a minimum or maximum effective sequence for those Entities that have an effective sequence Key field. The <i>LastSeq</i> and <i>FirstSeq</i> are only available on Base Entities with key field Effective Sequence.
Type	<p>Select the Type of Object Property to be compared to the Label Property. The chosen Operator controls what Types are available.</p> <p>For the Operators <i>Exists</i> and <i>Not Exists</i>, no Type can be chosen.</p> <p>For the Operators <i>In</i> and <i>Not In</i>, only Variables of Type List can be chosen.</p> <p>Here are the available types:</p> <ul style="list-style-type: none"> • <i>Date</i> • <i>Datetime</i> • <i>Number</i> • <i>Property</i> • <i>Text</i> • <i>Time</i> • <i>True/False</i> • <i>Variable</i>
Object	<p>The Object field behaves differently depending on which Type or Operator is chosen.</p> <p>The Object field is an open edit field except in the following cases:</p> <ul style="list-style-type: none"> • The Object field is not available when the Operator is <i>Exists</i> or <i>Not Exists</i>. • The Object field changes to a prompt when the Type is <i>Variable</i>, <i>True/False</i>, <i>Property</i>, or when LOV prompting has been enabled for properties. <p>For more information, see the <i>Defining Lists of Values for Rules Engine Variables</i> section.</p>
Help	<p>Hover your cursor over the Help icon (question mark) to open a popup window for information on how to use the selected Type and/or Operator.</p>

Here are possible options for Types and Objects in the Criteria grid:

Label	Operator	Type	Object
<i>Numeric</i> Property	= <> > >= < <=	Variable or Number	Open field or Prompts on <i>Number</i> Variables.
<i>String</i> Property	= <> > >= < <=	Variable or Text	Open field or Prompts on <i>Text</i> Variables.
<i>Date(time)</i> Property	= <> > >= < <=	Variable or Date(time)	Open field or Prompts on <i>Date(time)</i> Variables.
<i>Date</i> Property and field name is Effective Date	Asofdate	Variable	Variable Special handling exists for selection of Effective Date. For Entities with an Effective Date, you can choose to have the system automatically select the maximum Effective Date.

Label	Operator	Type	Object
<i>Number</i> Property and field name is Effective Sequence	FirstSeq LastSeq	No value available	Special handling exists for selection of Effective sequence. For entities with an effective sequence the user can choose to have the system automatically select the maximum or minimum effective sequence. Can be used in combination with the Asofdate option.
<i>List</i> Property	In Not In	Variable	<i>List</i> Variable which matches property Type
<i>Text</i> Property	Like Not like	Variable Text	Open field or <i>Text</i> Variable
Property of any type	Exists Not exists	No value available	<no value> If the Property is a Date or Date(time), any value not equal to Null exists. If the Property is a Number, any number unequal to 0 (zero) exists. If the Property is a String, any value unequal to space (blank) exists.

Defining Rule Groups

This section covers defining Rule Groups.

Understanding Rule Groups

Rules that share the functional purpose and have similar functionality, input and output can be grouped together in a Rule Group. For Rules to share the same Rule group, they must:

- Be based on data in the same Entity Tree and use the same Entity Registry item as the basis for that Rule. This Entity is known as the Base Entity.
- Share the same required input parameters.
- Share a subset of non-required input parameters.

- Share the same output parameters and can pass back required output.
- Belong to the same Rule Category, giving them the same security Rules.

One advantage of combining Rules in Rule Groups is that it allows you to call all Rules associated with a Rule Group dynamically. You would not have to know before the fact which Rules you are calling. Rule Groups that have been created can be called from other Rules, Triggers or Functions in the Rules Engine Manager using the “CALL DYNAMIC RULE GROUP” Statement. In short, by allowing Rules to call Rules from Rule Groups dynamically without specifying Rules or Functions directly, it is possible to dynamically call one or more Rules with similar functionality.

For example, an institution has created an Academic Item Registry program with courses from which the student can choose. For all those courses that require a prerequisite, a functional Rule is created that takes the course selected as input and checks whether the student meets the prerequisite requirement. When students select courses to add to their Academic Progress Tracker (APT), the prerequisite is checked, and, based on the outcome, a message is displayed to the student indicating whether or not he or she may add the course to their APT.

Example Rules for this scenario could be:

- Students must have completed Introduction to Calculus or Elementary Algebra before attempting Advanced Calculus
- Students must have completed Introduction to Psychology and have completed 10 credits from the “Human Studies” Course List before attempting Advanced Psychology.

Another advantage to creating Rules in the same Rule Group is the ability to control that the input and output for all Rules in the Rule Group is the same.

Each of these Rules needs to take the selected Course as input as well as information from the program of study and the student. All Rules above would return a similar outcome of true or false as well as a message that can be displayed. The Rules can be grouped together in the same Rule Group.

Note: Rule Groups should be created by Rules Engine Experts or Developers. The settings used in Rule Groups are enforced for any Rule added to the Rule Group. Once a Rule has been added to a Rule Group, the Rule's input and output parameters cannot be altered; however, it is still possible to add to and alter Statements in the Evaluations and Calculations grid. Also, Rule Groups with Active Rules attached cannot be changed.

You may find it challenging to define a new Rule Group with input and output variables and specifications for the Base Entity if you have not built the actual Rule that will be using the Rule Group. When building Rules, some experimentation is in order, and it is not always clear before the fact what exactly the input and the output of a Rule needs to be. Rule logic is optimized during the build process, and input or output Variables may need to be added based on new specifications or insights. Therefore, it may not be possible to define a template for input and output before any Rule has been built.

Rule Groups can also be created from Active Rules using the Rules Engine Manager **Action Create Rule Group**. Rule Groups can also be created using one of the available Rules Engine Search options.

Defining New Rule Groups

Access the Rule Groups Manager Categories page (**Set up SACR > System Administration > Rules Engine > Define Rule Groups**, select Add a New Rule Group, select the Categories tab).

This example illustrates the fields and controls on the Define Rule Groups Categories page. You can find definitions for the fields and controls later on this page.

Note: For Rule Categories delivered with the system, only the Long Description on the Definition page and Rule Groups and Security pages can be modified

<i>Field or Control</i>	<i>Description</i>
Rule Category	Enter the Rule Categories for this Rule Group. Rule Groups are tied to one or more Rule Category Names. Note: Assign categories first before selecting a Base Entity in the Definition tab.
Entity Name	Enter the Entity for the Rule Group. The Entity entered here is the Default Base Entity for any Rules added to this Rule Group. The Base Entity controls which application data You have access to when building the Rule, Function, or Trigger.
View Entity Hierarchy	Click this link to display the Entity Hierarchy view for the Base Entity attached to the Rule Group.

Access the Rule Groups Manager Definition page (**Set up SACR > System Administration > Rules Engine > Define Rule Groups**, select Add a New Rule Group, select the Definitions tab).

This example illustrates the fields and controls on the Define Rule Groups Definition page. You can find definitions for the fields and controls later on this page.

Definition
Categories
Cross Reference

Rule Group ID SCC_RULEGR_ID_20130829015545

Rule Group Status Active

Rule Group Name Copy of AIR function

***Long Description** Previous Name: SystemTest: Rule Retrieves AIR and Course Catalog Course information ***
SystemTest: Rule Retrieves AIR and Course Catalog Course information based on a specified

Rule Usage Rule
 Available To Be Used

Action

Used by 1 rules.

Personalize | Find | View All | | First | 1-5 of 5 | Last

Variable Name	Type	List	System	Input	Output	Required	Details
Dynamic Rule Variable	Text	<input type="checkbox"/>	<input type="checkbox"/>	<input checked="" type="checkbox"/>	<input type="checkbox"/>	<input checked="" type="checkbox"/>	
Institution	Text	<input type="checkbox"/>	<input type="checkbox"/>	<input checked="" type="checkbox"/>	<input type="checkbox"/>	<input checked="" type="checkbox"/>	
Academic Item ID	Text	<input type="checkbox"/>	<input type="checkbox"/>	<input checked="" type="checkbox"/>	<input type="checkbox"/>	<input checked="" type="checkbox"/>	
Effective Date	Date	<input type="checkbox"/>	<input type="checkbox"/>	<input checked="" type="checkbox"/>	<input type="checkbox"/>	<input checked="" type="checkbox"/>	
Course Information Retrieved	Data Set	<input checked="" type="checkbox"/>	<input type="checkbox"/>	<input type="checkbox"/>	<input checked="" type="checkbox"/>		

Save
Search Results
Select Actions

Field or Control	Description
Action	<hr/> <p>Note: For System-delivered Rule Groups, only the <i>Create Rule from Rule Group</i> and <i>Create Rule Group from Group</i> Actions are available.</p> <hr/> <p>Select an Action for this Rule Group:</p> <ul style="list-style-type: none"> • <i>Activate Rule Group</i> – In Progress Rule Group can be Activated using the Activate Rule Group option. <hr/> <p>Note: When creating a Rule Group from an Active or In Progress Rule, the Rule Group is immediately active and does not need not be activated. The Activate Rule Group action is not available.</p> <hr/> <ul style="list-style-type: none"> • <i>Create Rule from Rule Group</i> – This action creates a Rule from the current Rule Group using the values (Variables, Rule Usage, Entity Profile from the Current Group). If multiple Categories are present for the Rule Group you are prompted to select one. <hr/> <p>Note: The <i>Create Rule from Group</i> action is only available for Active Rule Groups.</p> <hr/> <ul style="list-style-type: none"> • <i>Create Rule Group from Group</i> – This action clones the current Rule Group and creates a new Rule Group using the values from this Rule Group. <hr/> <p>Note: The Name of the new Rule Group is copied exactly from the current Rule Group so your first action should be to rename the Rule Group.</p> <hr/> <ul style="list-style-type: none"> • <i>Delete Rule Group</i> – Rule Groups can be deleted. When choosing this option a warning is displayed first. After choosing OK the Rule is Deleted. This is only available if no Rules are attached to this Rule Group • <i>Inactivate Rule Group</i> – Active Rule Groups can be inactivated using the Inactivate Rule Group option. This is only possible if <i>no</i> Rules are attached to the Rule Group • <i>Remove Base Entity</i> – Use this Action to remove the Base Entity from this Rule Group. This Action is available when Rules have a status of <i>In Progress</i> or <i>Active</i>. For Active Rule Groups, the setup option to allow changes to active Rules must be selected. If an Active Rule Group has Rules attached, then the Base Entity may not be removed.

Field or Control	Description
	<p>Note: The Base Entity cannot be removed if the Rule is attached to a Rule Group.</p> <hr/> <p>Note: The <i>Inactivate Rule Group</i> and <i>Delete Rule Group</i> actions are not available for Rule Groups with Active Rules attached.</p> <hr/>
Rule Group ID	<p>Displays a unique ID generated by the system. When adding a new value the default value is <i>NOID</i>. The unique ID is generated when the Rule Group is saved. The Rule Group ID is created by combining prefix <code>SCC_RULEGR_ID_</code> with the system date and time stamp in format <code>YYYYMMDDHHMMSS</code>.</p>
Rule Group Status	<ul style="list-style-type: none"> • In Progress • Active
Used By X Rules	<p>Displays the number of Rules associated with this Rule Group; includes Active and Inactive Rules.</p>
Rule Group Name	<p>Enter a Rule Group Name. The Rule Group Name is used when searching for a Rule Group and for display.</p>
Long Description	<p>Enter descriptive text explaining the function of the Rule Group.</p>
Rule Usage	<ul style="list-style-type: none"> • Function • Rule • Trigger
Available To Be Used	<p>Select this check box if you want this Rule Group to be available for use by the statement <code>CALL DYNAMIC RULE GROUP</code>.</p> <hr/> <p>Note: If the Allow Changes to Active Rules check box on the Rule Engine Install Options page is not selected, the Available in Dynamic Rules check box cannot be selected here.</p> <hr/>

Field or Control	Description
<i>Dynamic Rule Variable</i>	A Dynamic Rule Variable is always created when a Rule Group is created. This Variable is used when calling Rules using the Dynamic Rule Group statement to call the required Rule ID.
Add a Variable	Select this button to open the Add a New Variable page. For more information, see <i>Adding Variables to a Rule</i> .

Access the Rule Groups Manager Cross Reference page (**Set up SACR > System Administration > Rules Engine > Define Rule Groups**, search for a Rule Group and select the Cross Reference tab).

This example illustrates the fields and controls on the Define Rule Groups Cross Reference page. You can find definitions for the fields and controls later on this page.

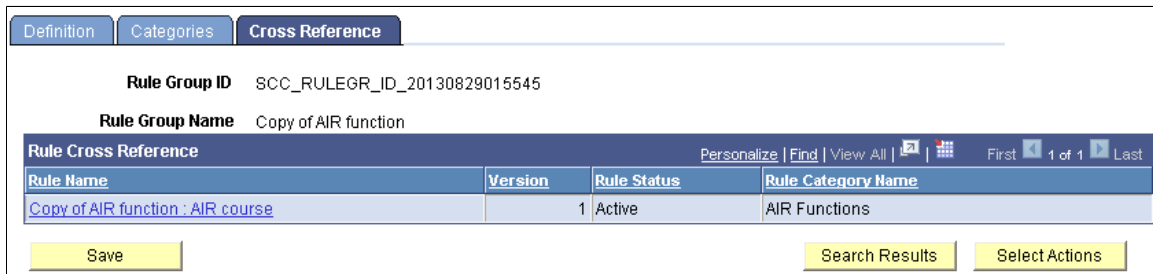

This page shows Rules and Rule Groups associated with this System Variable.

Field or Control	Description
Rule Name	Displays to authorized users links for Rules attached to this Rule Group. If a user is not authorized, the link is disabled. Click a link to transfer out of the component and to the referenced object. Warning! Make sure you have saved any data that you need to before confirming you want to transfer to the referenced object in a new component. If no objects use the Rule Group , a notification is shown in place of the object details; for example, “This Rule Group is not used by any Rules”.
Version	Displays the Rule Version Number.

Field or Control	Description
Rule Status	Displays the status of the Rule (<i>In Progress, Active, In-active</i>).
Rule Category Name	Displays the Rule Category Name in which the Rule has been created.

Defining Rule Triggers

After a Trigger Rule is defined, a Trigger Definition can be created. Trigger Definitions allow you to associate the Trigger Rule to a Component Event or an Entity Method and generate PeopleCode that can be added to the associated component, record, or field event specified on the Define Rule Triggers page using the Generate Code button.

Note: The component helps to generate Template PeopleCode but does not automatically add this code to the specified event. You may want or need to adjust generated code to add institution specific business logic.

Access the Define Rule Triggers page (**Set Up SACR > System Administration > Rules Engine > Setup > Define Rule Triggers**).

This example illustrates the fields and controls on the Define Rule Triggers page. You can find definitions for the fields and controls later on this page.

Define Rule Triggers

Trigger ID: SCC_RTRIG_20121030134809

*Name:

Trigger Description:

*Event:

Component: 

*Record: 

*Field: 

*Rule Category Name: 

*Rule Name: 

Field or Control	Description
Trigger ID	Displays a unique ID generated by the system. When adding a new value the default value is <i>NOID</i> . The unique ID is generated when the Rule Trigger is saved. The Trigger ID is created by combining prefix <i>SCC_RTRIG_</i> with the system date and time stamp in format <i>YYYYMMDDHHMMSS</i> .
Name	Enter a Trigger Name . The Trigger Name is used when searching for a Trigger and for display.
Trigger Description	Enter descriptive text explaining the function of the Trigger .
Event	<p>Note: This field is only available if the Trigger Type is Online Application.</p> <hr/> <p>Choose the PeopleCode Component Event to add to the Trigger:</p> <ul style="list-style-type: none"> • FieldEdit • FieldChange • SavePostChange • SaveFieldChange
Component	<p>Note: This field is only available if the Trigger Type is Online Application.</p> <hr/> <p>Select from a list of available Components in the environment by Component Name or Description.</p>
Record	<p>Note: This field is only available if the Trigger Type is Online Application.</p> <hr/> <p>Select from a list of available records for the selected Component <i>or</i> any record in the system if no Component is selected by Record Name or Description.</p>
Field	<p>Note: This field is only available if the Trigger Type is Online Application.</p> <hr/> <p>Select from a list of available fields for the selected Record selected by Field Name or Description.</p>
Rule Category Name	Select from a list of Rule Categories for which the “Allow Trigger” option has been selected on the Define Rule Categories definition page by Rule Category Name or Long Description.

<i>Field or Control</i>	<i>Description</i>
Rule Name	Select a Rule to associate with the Trigger.

For information about integrating the Rules Engine with a user interface, see [Integrating User Interfaces with the Rules Engine](#)

Using Statements for Evaluation and Calculation in a Rule

The section discusses how to:

- Activate and move Statements within a Rule.
- Apply Rule concepts and add Statements to a Rule.

Pages for Using Statements for Evaluation and Calculation in a Rule

<i>Page Name</i>	<i>Definition Name</i>	<i>Navigation</i>	<i>Usage</i>
Select a Statement	SCC_RULE_STMT_SEC	On the Define Rule page, click the Details icon on a blank row in the Evaluations and Calculations group box.	Select a Statement to add to a Rule.
Define If Statement	SCC_RULE_IF_SEC	On the Select a Statement page, select IF.	Select an If Statement for a Rule.
Define Else Statement	SCC_RULE_ELSE_SEC	On the Select a Statement page, select ELSE.	Select an Else Statement for a Rule.
Define For-Each Statement	SCC_RULE_FOR_SEC	On the Select a Statement page, select FOR EACH.	Select a For-Each Statement for generic loop processing for a Rule.
Exit For-Each Statement	SCC_RULE_EXTF_SEC	On the Select a Statement page, select EXIT FOR EACH.	Select to exit a For-Each loop.
Define Assignment Statement	SCC_RULE_ASGN_SEC	On the Select a Statement page, select ASSIGN.	Select an Assignment Statement to assign data to an object.
Define Call Statement	SCC_RULE_CALL_SEC	On the Select a Statement page, select CALL.	Select a Call Statement to call a Rule.

Page Name	Definition Name	Navigation	Usage
Exit Rule Statement	SCC_RULE_EXTR_SEC	On the Select a Statement page, select EXIT RULE.	Insert to exit a Rule.
Create Entity	SCC_RULE_CREN_SEC	On the Select a Statement page, select CREATE ENTITY.	Create an Entity within a Rule.
Call Dynamic Rule Group	SCC_RULE_DYNR_SEC	On the Select a Statement page, select CALL DYNAMIC RULE GROUP.	Insert to call a dynamic Rule Group.
Define Add To List Statement	SCC_RULE_LADD_SEC	On the Select a Statement page, select ADD TO LIST.	Select an Add to List Statement to add a value to a list in a Rule.
Define Length of List Statement	SCC_RULE_LENL_SEC	On the Select a Statement page, select LENGTH OF LIST.	Select a Length of List Statement to return the length of a list in a Rule.
Define Sort List Statement	SCC_RULE_SRTL_SEC	On the Select a Statement page, select SORT LIST.	Define an Sort List Statement to sort a list for a Rule.
Define Clear List Statement	SCC_RULE_LCLR_SEC	On the Select a Statement page, select CLEAR LIST.	Select a Clear List Statement to reset a List variable to empty in a Rule.
Write to Log Statement	SCC_RULE_WLOG_SEC	On the Select a Statement page, select WRITE TO LOG	Select a WRITE TO LOG statement to log the contents of variables.

Understanding Statements for Evaluation and Calculation in a Rule

You can use delivered Rules Engine Statements in the Rules Engine Manager **Evaluations and Calculations** grid to set up evaluative logic for your business Rules or Functions. Available Statements can be used to perform a specific task in the Rule you have created.

Access the Select a Statement page (click the **Details** icon on the left side of an empty row in the **Evaluations and Calculations** grid).

This example illustrates the fields and controls on the Delivered Statements. You can find definitions for the fields and controls later on this page.

Select a Statement	
Name	Description
<input type="checkbox"/> ADD TO LIST	Add a value to a list.
<input type="checkbox"/> ASSIGN	Assign data to an object
<input type="checkbox"/> CALL	Call Rule
<input type="checkbox"/> CALL DYNAMIC RULE GROUP	Call Dynamic Rule Group
<input type="checkbox"/> CLEAR LIST	Resets a list variable to an empty state.
<input type="checkbox"/> CREATE ENTITY	Create an entity and make the new entity the current context
<input type="checkbox"/> EXIT RULE	Exit a rule at this statement
<input type="checkbox"/> FOR EACH	For generic loop processing.
<input type="checkbox"/> IF	If
<input type="checkbox"/> LENGTH OF LIST	Returns the length of a list
<input type="checkbox"/> SORT LIST	Sort a list
<input type="checkbox"/> WRITE TO LOG	Write to Log Statement

Understanding Common Statement Attributes

When you select a Statement, a Define Statement page opens. Each Statement has a Define Statement page created specifically for that Statement. Although each Define Statement page is different, there are common fields and elements shared by all Statements. Each Define Statement page for each delivered Statement is explained below, but, first, to illustrate the common attributes of the Statement, access the Define If Statement page (select the check box next to the *IF* Statement **Name** on the **Select a Statement** page).

This example illustrates the fields and controls on the Example of Common Statement Attributes on a Statement page.. You can find definitions for the fields and controls later on this page.

Define If Statement

Current Context

Entity Name

Rule Statement Summary

IF Lowest Mark < 7.0

| - EXIT RULE

ELSE

| - IF Average Mark >= 8.0

| | - ASSIGN Honors Award Code = Cum Laude

| | - EXIT RULE

| - ELSE IF Average Mark >= 8.0

| | - IF Average Mark >= 7.0

| | | - ASSIGN Honors Award Code = Distinction

Current Statement

Generated Description IF Lowest Mark < 7.0

Override Auto Descriptions

If Statement Definition

Type	Value	Operator	Type	Value
Variable	Lowest Mark	<	Number	7.0

Personalize | Find | View All | First 1 of 1 Last

Connectors and Parentheses

Use the AND/OR connectors and parenthesis to create complex (nested) Statement definitions.

This example illustrates the fields and controls on the Example of Connectors and Parentheses. You can find definitions for the fields and controls later on this page.

Add Parenthesis to the left of the criteria
 Add Parenthesis the right of the criteria
 Remove Parenthesis from left of criteria
 Remove Parenthesis from right of criteria

For example:

And	(+)	(ID	=	Variable	Emplid	(-)	?	+	-
Or	(+))	APT Instance	=	Variable	APTInstance)	?	+	-

Current Context

Displays the **Current Context** of the Statement. The **Current Context** provides information about the current Entity you are working with when you have a Rule that accesses multiple layers in a Data Hierarchy represented by the Base Entity. You always have access to properties from the Current Context and the immediate Parent. For example, when working with the Academic Progress Tracker (APT) using System Data only, your Current Context could be one of the following:

This example illustrates the fields and controls on the Example of Academic Progress Tracker Entity Hierarchy. You can find definitions for the fields and controls later on this page.

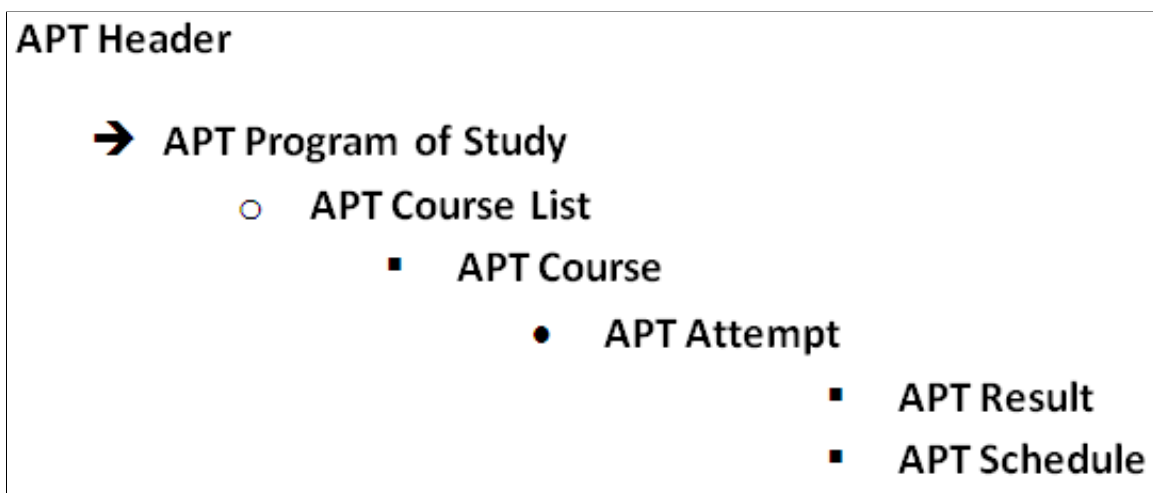

In our example, the context is set to APT Header which means that we are able to use as data, within our IF Statement, all properties from the APT Header. If our current context had been APT Program of Study we would have been able to use all properties from the APT Program of study as well as the APT Header.

Rule Statement Summary

Displays a summary of the entire evaluative statement. The view is shown in color. Bold type indicates which Statement you are currently working with.

If you have not yet added a Statement, this is shown as "Current New Row".

Current Statement

Displays the short description of the **Current Statement** you are working with as well as the options for this Statement.

Override Auto Description

Select the **Override Auto Description** check box to override the **Generated Description** and provide your own using a Rich Text Editor.

Understanding Statement-Specific Attributes

Each delivered Statement contains Statement-specific features; as described below with examples.

IF Statements

Use this statement to create evaluative Statements in your business rule. This is an encompassing statement; meaning that within the context of this statement, you can use other statements.

This example evaluates whether or not a student has achieved a sum of credits higher than 60 in Year 1 of his program. If the condition is met, the student may progress to Year 2.

This example illustrates the fields and controls on the Example of IF Statement before Saving. You can find definitions for the fields and controls later on this page.

The screenshot shows the 'Define If Statement' interface. It includes sections for 'Current Context' (Entity Name), 'Rule Statement Summary' (IF Total Credit >= 60), 'Current Statement' (Generated Description: IF Total Credit >= 60, and an unchecked 'Override Auto Descriptions' checkbox), and an 'If Statement Definition' table. The table has columns for Type, Value, Operator, Type, and Value. The first row shows 'Variable' for Type, 'Total Credit' for Value, '>=' for Operator, 'Number' for Type, and '60' for Value.

If Statement Definition					
	Type	Value	Operator	Type	Value
(+)	Variable	Total Credit	>=	Number	60

The possible combinations of Objects and Types in IF Statements are:

Type	Object	Operator	Type	Value
Property or Data Set Property (DS Prop) or Variable	Prompts on Properties or Prompts on Variables	> < >= <= = Like Not like	Variable or Text (<i>String</i> Property) or Number (<i>Number</i> Property or <i>Number</i> Variable) or Date(time) or Data Set Property	Prompt on Variable which matches a <i>Data Set Property</i> or <i>Variable</i> Type. or Text entry in an open field if Type is <i>Text</i> . or Numeric entry in open field if a Variable is numeric. or Date(time) in an open field if a <i>Data Set Property</i> or <i>Variable</i> is Date(time). or Prompt on <i>Data Set Property</i> which matches <i>Property</i> or <i>Variable</i> Type
Property or Data Set Property (DS Prop) or Variable	Prompts on Data Set Properties or Variables	In Not in	Variable	<i>List</i> Variable

<i>Type</i>	<i>Object</i>	<i>Operator</i>	<i>Type</i>	<i>Value</i>
Property	Prompts on Data Set Properties	Exists	no value	no value
or		Not exists		
Data Set Property (DS Prop)	or			
or	Variables			
Variable				

The saved IF Statement looks like this:

This example illustrates the fields and controls on the Example of IF Statement After Saving. You can find definitions for the fields and controls later on this page.

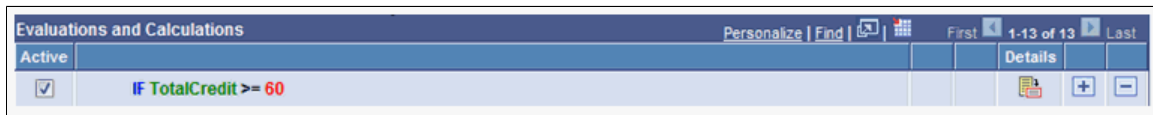

ELSE Statements

Combine ELSE statements with IF statements to create complex evaluative business Logic. This statement can only exist in the context of an IF statement. The ELSE statement page itself offers no features besides the possibility to override the auto-generated text.

Note: If you do not already have an IF statement in your Rule, the ELSE statement is not shown as an option on the **Select a Statement** page.

This example evaluates whether or not a student has achieved a sum of credits higher than 60 in Year 1 of his program. If the condition is met, the student may progress to Year 2. However, if the student has less than 60 credits but greater than 40 credits, this student may need to repeat courses from Year 1.

This example illustrates the fields and controls on the Define ELSE Statement page. You can find definitions for the fields and controls later on this page.

Define Else Statement

Current Context

Entity Name

▼ Rule Statement Summary

```

IF TotalCredit >= 60
ASSIGN ProgressionOutcome = Pass

ELSE IF TotalCredit >= 60

IF TotalCredit >= 42
|- ASSIGN ProgressionOutcome = ConditionalPass
ELSE IF TotalCredit >= 42
|- IF TotalCredit >= 36
|- ASSIGN ProgressionOutcome = RepeatYear1
|- ELSE IF TotalCredit >= 36
|- IF TotalCredit < 36
|- ASSIGN ProgressionOutcome = Fail
|- ELSE IF TotalCredit < 36
|- ASSIGN ProgressionOutcome = Undetermined
    
```

Current Statement

Generated Description ELSE [IF TotalCredit >= 60]

Override Auto Descriptions

Here is an example of how an Evaluative Statement can be created combining IF and ELSE statements:

This example illustrates the fields and controls on the Example of IF and ELSE Statements Used Together. You can find definitions for the fields and controls later on this page.

Evaluations and Calculations		Personalize Find	First 1-13 of 13 Last
Active			Details
<input checked="" type="checkbox"/>	IF TotalCredit >= 60		+ -
<input checked="" type="checkbox"/>	ASSIGN ProgressionOutcome = Pass	▲ ▼	+ -
<input checked="" type="checkbox"/>	ELSE IF TotalCredit >= 60	▼	+ -
<input checked="" type="checkbox"/>	IF TotalCredit >= 42	▲ ▼	+ -
<input checked="" type="checkbox"/>	- ASSIGN ProgressionOutcome = ConditionalPass	▲ ▼	+ -
<input checked="" type="checkbox"/>	ELSE IF TotalCredit >= 42	▼	+ -
<input checked="" type="checkbox"/>	- IF TotalCredit >= 36	▲ ▼	+ -
<input checked="" type="checkbox"/>	- ASSIGN ProgressionOutcome = RepeatYear1	▲ ▼	+ -
<input checked="" type="checkbox"/>	- ELSE IF TotalCredit >= 36	▼	+ -
<input checked="" type="checkbox"/>	- IF TotalCredit < 36	▲ ▼	+ -
<input checked="" type="checkbox"/>	- ASSIGN ProgressionOutcome = Fail	▲ ▼	+ -
<input checked="" type="checkbox"/>	- ELSE IF TotalCredit < 36	▼	+ -
<input checked="" type="checkbox"/>	- ASSIGN ProgressionOutcome = Undetermined	▲ ▼	+ -

FOR EACH Statements

Use this statement to scroll through a set of elements which has been retrieved into the Rule. These elements can be Entities retrieved in the context of a Rule or Variables from a list of Variables. The FOR-EACH statement is an encompassing statement; meaning you can use other statements within the context of the FOR-EACH.

For example, to scroll through the Academic Progress Tracker entity to retrieve all courses in a program, select a FOR-EACH statement:

This example illustrates the fields and controls on the Define FOR-EACH Statement page. You can find definitions for the fields and controls later on this page.

Statement-specific fields on this page are:

Field or Control	Description
Entity Processing	Select this option to activate the Entity Name prompt and Process Immediate Children Only check box.
List Variable (list variable radio button)	Select this option to activate the List Variable prompt.
Entity Name	Select an Entity.
List Variable (list variable field)	Select a List Variable.
Process Immediate Children Only	Select this check box to process only immediate child records of the selected Entity . This means only a direct child record of the Entity is used in the process; <i>not</i> grand children of great-grand children in the same Entity structure.

For example, you want to evaluate whether a student has achieved a sum of credits higher than 60 in Year 1 of his program of study in order to progress to Year 2. To calculate the overall credit total, you must first retrieve all courses for Year 1 and sum the credits of each course. First, you retrieve Year 1 for the student, and then you use a FOR EACH (course) statement to loop through all courses and retrieve the credits.

Since the Courses in Year 1 may be part of a Course List or a Requirement and not an immediate child of the Year, you do not want to select the "Process Immediate Children Only" option. However, if you wanted to make sure that you only process immediate children of the Year, you do want to select this option.

EXIT FOR EACH Statement

The EXIT FOR EACH statement is only available in the context of a FOR EACH statement. Use this statement to exit scrolling through a set of elements which has been retrieved into the Rule. These elements can be Entities retrieved in the context of a Rule or Variables from a list of Variables.

For example, you want to evaluate whether a student completed Course Math 101 in Year 1 of his program of study. If the condition is met, the student may progress to Year 2. When the condition has been met (Math 101 course has been found), there is no need to retrieve other Courses from the system. The EXIT FOR EACH can be used to exit the for each loop at this time.

ASSIGN Statements

Use this statement to assign values to Variables or Properties in your Rule

For example, to assign Credit = 2 to Variable Credit, select the *ASSIGN* statement from the **Select a Statement** page:

This example illustrates the fields and controls on the Define Assignment Statement page. You can find definitions for the fields and controls later on this page.

Define Assignment Statement

Current Context

Entity Name APT Header

Rule Statement Summary

ASSIGN TotalCredit = 0, ProgressionOutcome = NORESULT

FOR-EACH APT Course
 :- Check whether course is in year 01
 :- IF CheckCourseSchedule = True
 :- FOR-EACH APT Result
 :- IF APT Result.Result Type = ECTS And APT Result.Include in Calculation = Y
 :- ASSIGN Credit = APT Result.Result Value
 :- CALL Function Add passing in Credit as Value1, TotalCredit as Value2 returning Result as TotalCredit
 CALL Function NLD Function Credit Progression Year 1 passing in TotalCredit as TotalCredit returning ProgressionOutcome as ProgressionOutcome

Current Statement

Generated Description ASSIGN TotalCredit = 0, ProgressionOutcome = NORESULT

Override Auto Descriptions

Assignment Statement Definition		Personalize Find View All First 1-2 of 2 Last			
Type	Value		Type	Value	
1	Variable TotalCredit	=	Number	0	+ -
2	Variable ProgressionOutcome	=	Text	NORESULT	+ -

The possible combinations of Objects and Types in ASSIGN Statements are:

Type	Object	Operator	Type	Value
Property or Data Set Property (DS Prop) or Variable	Prompts on Properties or Prompts on Variables	=	Variable or Text (<i>String</i> Property or Number (<i>Number</i> Property or <i>Number</i> Variable) or Date(time) or Data Set Property	Prompt on Variable which matches Data Set Property Type or Variable Type. or Text entry in open field if Type is Text. or Numeric entry in open field if Data Set Property or Variable is numeric. or Date(time) in open field if Data Set Property or variable type is Date (time). or Prompt on Data Set Property which matches Property or Variable Type.

CALL Statements

Use this statement to call a Function or Rule from within the current Function or Rule. The current Rule is the Calling Rule. The Function or Rule called executes a piece of business logic in the context of the Calling Rule.

When you call a *Rule*, you need to pass all Criteria for that Rule as input to that Rule otherwise the correct data cannot be selected.

When you call a *Function* which uses Entity Data, you do *not* need to provide Criteria to find the correct data. That data is passed to the called Function automatically through Contextual Referencing.

In this example, a student is evaluated to see if he has achieved a sum of credits greater than 60 in Year 1 of his program of study 1. If that condition is met, the student may progress to Year 2. In order to obtain the student's credit total, you must first to retrieve all courses for Year 1 and sum the credit result by retrieving each course to obtain the overall sum of credit. This is done using a FOR EACH statement that retrieves Year 1 and loops through all Courses and retrieves credits. This uses an Add math Function to add Course Credits to a variable, SumCredit. At the end of the FOR EACH loop, the total number of

credits for all courses in Year 1 is counted. Here is a similar example of the Add Function Add being called from a Rule:

This example illustrates the fields and controls on the Define Call Statement page. You can find definitions for the fields and controls later on this page.

Define Call Statement

Current Context

Entity Name APT Course

▼ Rule Statement Summary

FOR EACH APT Course

| - CALL Function Add passing in Retrieved Credits as Value 1, Total Credits as Value 2 returning Result as Total Credits

Current Statement

Generated Description CALL Function Add passing in Retrieved Credits as Value 1, Total Credits as Value 2 returning Result as Total Credits

Override Auto Descriptions

Rule Category Name Math 🔍

Rule Name Add 🔍 📄

Inputs Personalize | Find | View All | 📄 | 📅 | First 1-2 of 2 Last

Arguments	=	Type	Value	🔍	Required
Value 1	=	Variable ▾	Retrieved Credits	🔍	☑
Value 2	=	Variable ▾	Total Credits	🔍	☑

Outputs Personalize | Find | View All | 📄 | 📅 | First 1 of 1 Last

Type	Value	🔍	=	Return
Variable ▾	Total Credits	🔍	=	Result

These are the Call Statement-Specific fields:

Field or Control	Description
Rule Category	Select a valid Rule Category from which to retrieve the Function you want to use. The Rule Category available must be one of the valid categories on the Rule Category Definition page.
Rule Name	<p>Click the Search icon to the right of the Rule Name to open the Rules Engine Search page and select a Rule.</p> <p>Click the Go To icon to the right of the Rule Name to open a new page that displays information on Rule Definition, Version History, and Cross Reference.</p>

Field or Control	Description
Inputs	Select an Argument and Type for each Object . This is required so that all Input can be passed from the Calling Rule to the Called Function. The arguments are the Input Variables that have been defined in the Called Function. The Operator field is restricted to only show the <i>Equals to</i> operator. The Type is restricted to the Type that is assigned to the Argument .
Outputs	Select a Type and Object for each Output . The Return represents the Variable(s) that has been defined as Output Variable in the called Function. The Type is restricted to the Type that is assigned to the Argument .

EXIT RULE Statement

Use this statement to exit a Rule or Function in its entirety. The outcome for this Rule would be to process to success.

For example, to find out whether a student completed Course Math 101 in Year 1 of his program of study, you can create a Rule to retrieve only that information. If you have use a FOR EACH statement in the Called Rule to scroll through all of the courses in Year 1, you can use an EXIT RULE statement to exit the FOR EACH loop and the Rule entirely once the condition has been met.

CREATE ENTITY Statement

Use this statement to create an Entity. After the Entity is created, the user is transferred to the context of the created Entity and all Entity properties are available.

You can only create an Entity in the context of a parent Entity. For example, when in the context of APT Course, you can create Entity APT Attempt, and when working in the context of APT Attempt, you can create and APT Result Entity or APT Schedule Entity.

This example illustrates the fields and controls on the Example of APT Header Hierarchy. You can find definitions for the fields and controls later on this page.

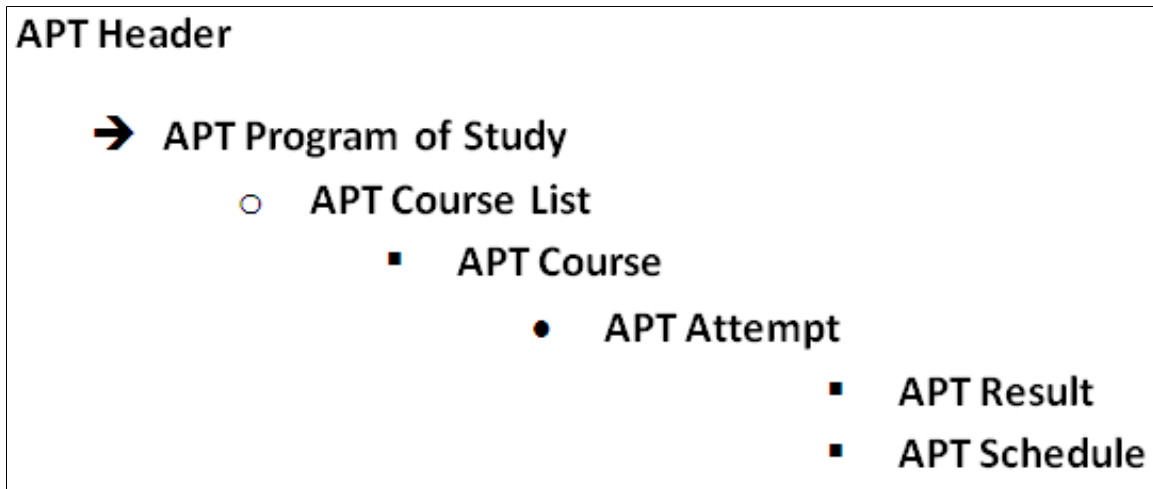

When the Entity is created, it does not yet exist in the database. The CREATE ENTITY statement can be used together with the delivered Function Save Entity to insert new rows into database tables.

Note: You can only create an Entity as a child within the Entity of the Current Context.

The following Functions can be used after having changed an entity or after having created an entity:

<i>Function</i>	<i>Function Description</i>
SaveEntity	Saves the Current Entity in context and all of its children. Performs all validation and pre-save logic and deletes any entities marked for deletion.
SaveAllEntities	Saves all the Entities in context and all of their children. Performs all validation and pre-save logic and deletes any entities marked for deletion.
DeleteEntity	Marks the Current Entity and all of its children for deletion. SaveEntity Function must be called to actually delete the Entity.
UndeleteEntity	Marks the Current Entity and all of its children to be undeleted. SaveEntity Function must be called to actually delete the Entity

Warning! Using the CREATE ENTITY statement in combination with delivered Functions which can save an Entity, like the Save Entity Function, inserts data into referenced database tables. These Statements and Functions should only be used by experienced users with a Skill Level of *Expert* who have a good understanding of the Campus Solutions record structure. Rules Engine administrators should minimize risk by allowing Functional Experts to create Entities but not authorizing them to use one of the Save Entity Functions *or* by creating separate Functions in which CREATE ENTITY and SAVE ENTITY statements are combined.

For example, continuing the example of evaluating whether a student has achieved a sum of credit higher than 60 in his program of study year 1, you can use the CREATE ENTITY statement to create an Entity to store the result of that calculation in the APT result. Once the Entity is created, you populate the appropriate fields with values. In this case, Result value with the Sum of Credits retrieved by the Rule. To do this, use the Assign statement to assign the actual Sum of Credits to the Result value property for Result Type *Sum Credit*. Once assigned, you can save the Entity, which creates a row in the database using the system delivered Function Save Entity.

Note: The Rules Engine Manager has logic which validates nested Create Entity Statements that are present in the Evaluations and Calculations Grid upon saving the Rule. A Create Entity Statement cannot be added to a Rule that is invalid, but it is possible to invalidate an existing Create Entity statement by removing a Statement from the Evaluations and Calculations grid or by deactivating a line on the Evaluations and Calculations grid. This would make the overall Rule invalid. For example, if a Create Entity statement is used to create the APT Attempt followed by a Create Entity statement to create the APT Result row, and the Create Entity APT attempt row is removed from the Evaluations and Calculations grid or moved to a new position after having been added, the overall Rule becomes invalid. The APT Result can only exist in the Rule as a child to APT Course and not as a child to APT Attempt. Deletion, moving, and deactivating statements while the Rule is being built is allowed because the action may have been done in the course of correcting the Rule. However, when the Rule is saved, the whole Rule is validated and appropriate warning messages are displayed.

CALL DYNAMIC RULE GROUP Statements

Use this statement to call a Rule from a dynamic Rule Group. A Rule Group provides Rules with a standard template with predefined input and output parameters as well as a Base Entity. Rules which share the same template characteristics can be grouped in the same Rule Group. When calling Dynamic Rule Groups, all Rules belonging to this Rule Group are called and executed. The following example passes a retrieved Rule ID to the Rule Group PRECON-Minor Precondition. The Rule associated with the ID is then called.

For more information, see *Understanding Rule Groups* and *Define Rule Groups*.

This example illustrates the fields and controls on the CALL DYNAMIC RULE GROUP Statement page. You can find definitions for the fields and controls later on this page.

Call Dynamic Rule Group

Current Context

Entity Name APT Course

▼ Rule Statement Summary

CALL DYNAMIC RULE GROUP Rule Academic Progress Tracker Item calling rule in Rule ID as Dynamic Rule Variable passing in Student ID as in_EMPLID, Institution as in_INSTITUTION, APT Instance as in_SSR_APT_INSTANCE, Academic Item ID as in_SSR_ITEM_ID, Process full as in_SSR_RUN_FULL_RULE, Item Sequence as in_SSR_APT_ITEM_SEQ returning out_RETURN_CODE as Out Return Code, out_MESSAGES as Message Catalog Messages

Current Statement

Generated Description CALL DYNAMIC RULE GROUP Rule Academic Progress Tracker Item calling rule in Rule ID as Dynamic Rule Variable passing in Student ID as in_EMPLID, Institution as in_INSTITUTION, APT Instance as in_SSR_APT_INSTANCE, Academic Item ID as in_SSR_ITEM_ID, Process full as in_SSR_RUN_FULL_RULE, Item Sequence as in_SSR_APT_ITEM_SEQ returning out_RETURN_CODE as Out Return Code, out_MESSAGES as Message Catalog Messages

Override Auto Descriptions

Rule Category Name APT Functions

Rule Group Name Academic Progress Tracker Item

Inputs Personalize | Find | View All | First 1-7 of 7 Last

Arguments	Type	Value	Required
1 Dynamic Rule Variable	= Variable	Rule ID	<input checked="" type="checkbox"/>
2 in_EMPLID	= Variable	Student ID	<input checked="" type="checkbox"/>
3 in_INSTITUTION	= Variable	Institution	<input checked="" type="checkbox"/>
4 in_SSR_APT_INSTANCE	= Variable	APT Instance	<input checked="" type="checkbox"/>
5 in_SSR_ITEM_ID	= Variable	Academic Item ID	<input type="checkbox"/>
6 in_SSR_RUN_FULL_RULE	= Variable	Process full	<input type="checkbox"/>
7 in_SSR_APT_ITEM_SEQ	= Variable	Item Sequence	<input type="checkbox"/>

Outputs Personalize | Find | View All | First 1-2 of 2 Last

Type	Value	Return
1 Variable	Out Return Code	= out_RETURN_CODE
2 Variable	Message Catalog Messages	= out_MESSAGES

These are the Call Statement-Specific fields:

Field or Control	Description
Rule Category	Select a valid Rule Category from which to retrieve the Rule Group you want to use. The Rule Category available must be one of the valid categories on the Rule Group Category Definition page.
Rule Group Name	Click the Search icon to the right of the Rule Name to open the Rule Group Search page and select a Rule Group. Click the Go To icon to the right of the Rule Group Name to open a new page that displays information on Rule Group Definition, Categories, and Cross Reference.

Field or Control	Description
Inputs	Select an Argument and Type for each Object . This is required so that all Input can be passed from the Calling Rule to the Called Function. The arguments are the Input Variables that have been defined in the Called Function. The Dynamic Rule Variable is always the first required Input parameter when calling Dynamic Rule Groups. The Operator field is restricted to only show the <i>Equals to</i> operator. The Type is restricted to the Type that is assigned to the Argument .
Outputs	Select a Type and Object for each Output . The Return represents the Variable(s) that has been defined as Output Variable in the called Function. The Type is restricted to the Type that is assigned to the Argument .

ADD TO LIST Statements

Use this statement add values to a List.

The List to which you want add Variables must have been created before using this statement. ADD TO LIST statements can also be used in the context of a FOR EACH loop; however, when using ADD TO LIST, you cannot add to the same List that you are scrolling through within the context of a FOR EACH loop.

This example illustrates the fields and controls on the Define ADD TO LIST Statement page. You can find definitions for the fields and controls later on this page.

Define Add To List Statement

Current Context

Entity Name

▼ Rule Statement Summary

Current New Row

Current Statement

Override Auto Descriptions

List 

Click the Search icon to the right of the List field to open the Add/Select a Variable page:

This example illustrates the fields and controls on the Example of Add/Select a Variable page with only List Variables. You can find definitions for the fields and controls later on this page.

Add/Select a Variable								
Variables								
Type	*Argument Name	*Long Description	List	System	Input	Output	Required	
<input type="checkbox"/> Data Set	Message Catalog List	Message Catalog List	<input checked="" type="checkbox"/>	<input type="checkbox"/>	<input type="checkbox"/>	<input type="checkbox"/>	<input type="checkbox"/>	<input type="checkbox"/>
<input type="checkbox"/> Text	List of Courses	List of Courses	<input checked="" type="checkbox"/>	<input type="checkbox"/>	<input type="checkbox"/>	<input type="checkbox"/>	<input type="checkbox"/>	<input type="checkbox"/>

After having selected the List, you are returned to the ADD TO LIST statement page to add relevant Variables to the list:

This example illustrates the fields and controls on the Example of ADD TO LIST statement page with Value to Add to the List Grid. You can find definitions for the fields and controls later on this page.

Define Add To List Statement	
Current Context	
Entity Name	APT Course
▼ Rule Statement Summary	
ADD TO LIST Using List Failed Economics Courses Value Economics Failed Courses	
Current Statement	
Generated Description	ADD TO LIST Using List Failed Economics Courses Value Economics Failed Courses
<input type="checkbox"/> Override Auto Descriptions	
List	Failed Economics Courses
Value to Add to the List	
Type	Value
Variable	Economics Failed Courses

- If the selected List is a Data Set, you may only add Type Variable to the List, and the Variable must be a Data Set.
- If the list is *not* a Data Set, you may add the following to the List:
 - A Variable which matches the **Type** of the List (for example, *Text*).
 - A Data Set Property which matches the **Type** of the List.
 - A Property which matches the **Type** of the List.
 - A user-defined value of **Type Text**.

For example, a curriculum requirement dictates that students may only fail three courses in subject area “Economics”. A Rule is needed to capture a List which contains both the Course as well as the failed Mark. For this, use a Data Set for the purpose of capturing the failed courses in subject area Economics. At the time of creation, the List is empty. Associate the List Variable with the created Data set. In the same Rule, also add a simple List containing all Courses. In a FOR EACH loop which scrolls through all the Courses in a program of study, evaluate the subject area for each course, determine whether the course is failed and, if meeting the criteria, add the Course ID as well as the Mark to the Data Set list. Use a ADD TO LIST to add Course ID’s and Marks as they are found.

LENGTH OF LIST Statement

Use this statement to determine the length of any List.

Click the Search icon to the right of the **List** field to open the Add/Select a Variable page.

Enter a Number Variable in the **Length** field or create a Numeric Variable on the fly to designate the **Length** of the **List**.

SORT LIST Statements

Use the SORT LIST statement to sort a List by any List value. Depending of the type of List you select, you are presented different options upon returning to the Define statement page.

For Lists that *are not* Data Sets, select a **Sort Order** of *Ascending* or *Descending*.

This example illustrates the fields and controls on the Example of a Sort Order Specification that is not a Data Set. You can find definitions for the fields and controls later on this page.

The screenshot shows a form titled "Current Statement" with a blue header. Below the header is a checkbox labeled "Override Auto Descriptions". Underneath is a "List" field containing the text "Courses Simple List" and a search icon to its right. Below the "List" field is a "Sort Order" dropdown menu currently set to "Ascending".

For Lists that *are* Data Sets, select the Search icon to the right of the Object to open the **Data Set Property Search** page and select a Data Set. Upon return to the Define SORT LIST statement page, select a **Sort Order** of *Ascending* or *Descending* for selected Data Set.

This example illustrates the fields and controls on the Example of a Sort Order Specification that is a Data Set. You can find definitions for the fields and controls later on this page.

The screenshot shows a form titled "Current Statement" with a blue header. Below the header is a checkbox labeled "Override Auto Descriptions". Underneath is a "List" field containing the text "Economics Failed Courses" and a search icon to its right. Below the "List" field is a "Value to Add to the List" section with a table. The table has a blue header with columns "Value", "Search", and "Sort Order". The "Value" column contains "Economics Failed Courses.Course ID". The "Sort Order" column contains a dropdown menu set to "Ascending". To the right of the table are navigation buttons: "Personalize", "Find", "View All", "First", "1 of 1", and "Last".

CLEAR LIST Statements

Use this statement to clear a list and remove all list data.

Click the Search icon to the right of the List field to open the Add/Select a Variable page and select a List.

WRITE TO LOG Statements

Write to Log functionality can be used to provide Rule users with useful processing feedback when Rules are run in batch. For example, a log file can show information such as numbers of rows processed or retrieved.

The **Logging Level Write to Log** must be set for a log file to be created. Subsequently, the a Write to Log statement can be used to write text strings as well as the contents of Variables, Data Set Properties, and Entity Properties to a log file.

This example illustrates the fields and controls on the Define Write To Log Statement page. You can find definitions for the fields and controls later on this page.

Define Write To Log Statement

Current Context

Entity Name Academic Program

Rule Statement Summary

FOR EACH Academic Program
] - CALL Function Add passing in 1 as Value 1, Total number of rows as Value 2 returning Result as Total number of rows
 ASSIGN LOV prompt = Y
 CALL Function CreateTextMessage passing in 14907 as Message Set Number, 12 as Message Number, Default Text as Default Text, as Parameter 1, as Parameter 2, as Parameter 3, as Parameter 4, as Parameter 5, as Parameter 6, as Parameter 7, as Parameter 8, as Parameter 9 returning Text Message Data Set as Message Catalog
 ASSIGN Total Number of rows = Total Number of rows :
 CALL Function NumberToString passing in Total number of rows as Initial Number returning Result as Number as text
 CALL Function Concatenate passing in Total Number of rows as String 1, Number as text as String 2 returning Result as Total Number of rows
WRITE TO LOG Text * Start of Log File *****, Data Set Property Message Catalog.Explain Text, Text ***** Academic Information Processed *****, Property Academic Program.Approved Academic Load, Property Academic Program.Academic Program, Property Academic Program.Academic Career, Text ******* Number of Rows Processed *******, Data Set Message Catalog, Variable Total Number of rows, Text ******* end of Log file**

Current Statement

Generated Description WRITE TO LOG Text *** Start of Log File ***, Data Set Property Message Catalog.Explain Text, Text *** Academic Information Processed ***, Property Academic Program.Approved Academic Load, Property Academic Program.Academic Program, Property Academic Program.Academic Career, Text ***** Number of Rows Processed *****, Data Set Message Catalog, Variable Total Number of rows, Text ***** end of Log file

Override Auto Descriptions

Display the Contents of all Variables

Write To Log Statement Definition			Personalize	Find	First	1-10 of 10	Last
Order	Type	Value					
1	Text	*** Start of Log File ***					+ -
2	DS Prop	Message Catalog.Explain Text					+ -
3	Text	*** Academic Information Processed ***					+ -
4	Property	Academic Program.Approved Academic Load					+ -
5	Property	Academic Program.Academic Program					+ -
6	Property	Academic Program.Academic Career					+ -
7	Text	***** Number of Rows Processed *****					+ -
8	Data Set	Message Catalog					+ -
9	Variable	Total Number of rows					+ -
10	Text	***** end of Log file					+ -

Field or Control	Description
Display the Contents of All Variables	Select this option to write all Rule Variable and their contents to the log file.

Use the **Write to Log Statement Definition** grid to add one or more values to be written to the log file. The Order number is automatically augmented when rows are added. Rows are written to the log file in the same order.

Field or Control	Description
Type	<p>Select a Value Type to include in the log:</p> <ul style="list-style-type: none"> • <i>Data Set</i> — The contents of the complete Data Set are written to the log file. This includes the Data Set Property Name followed by the Data Set Property Content. This option is available if the Rule references a Data Set • <i>DS Prop (data set property)</i> — The value of the selected Data Set Property. This option is available if the Rule references a Data Set Variable. • <i>Property</i> — The contents of the Entity Property are written to the log file. • <i>Text</i> — Text entered by the user. • <i>Variable</i> — Only Variables of type <i>Text</i> can be written to the log file. If you need to write the contents of a number Variable to a log, use the function <i>NumberToString</i> to convert your value first.

Activating and Moving Statements within a Rule

Once Statements are added to a Rule, they can be activated or inactivated, and they can be moved within the Rule to alter the Rule logic.

Activating and Inactivating Statements

Select the Active check box to the right of each Statement to activate or inactivate the Statement.

An Inactive statement (check box is unchecked) is ignored by the Rules Engine compiler and skipped when executing a Rule build. Inactivated statements are displayed in non-bold italic text.

Moving Statements within a Rule

One way that Rule logic can be modified is by moving Statements within the Rule. There are two ways that a Statement can be moved within a Rule:

- Up and Down

Use the Up and Down Toggle fields to move a Statement before or after other Statements, changing the order in which Statements are executed. The type of Statement and where it is located in relation to other Statements determines if it can be moved up and/or down.

- By Indentation

Use the Indentation Toggle fields to move a Statement within or outside of other Statements, changing when a Statement is executed in relation to Statements above or below it.

This example illustrates the fields and controls on the Example Showing Statements with Indentations and Up and Down Toggles. You can find definitions for the fields and controls later on this page.

Evaluations and Calculations		Personalize	Find	First	1-9 of 9	Last
Active						Details
<input checked="" type="checkbox"/>	ASSIGN TotalCredit = 0, ProgressionOutcome = NORESULT					
<input checked="" type="checkbox"/>	FOR-EACH APT Course					
<input checked="" type="checkbox"/>	;- Check whether course is in year 01					
<input checked="" type="checkbox"/>	;- IF CheckCourseSchedule = True					
<input checked="" type="checkbox"/>	;- FOR-EACH APT Result					
<input checked="" type="checkbox"/>	;- IF APT Result.Result Type = ECTS And APT Result.Include in Calculation = Y					
<input checked="" type="checkbox"/>	;- ASSIGN Credit = APT Result.Result Value					
<input checked="" type="checkbox"/>	;- CALL Function Add passing in Credit as Value1, TotalCredit as Value2 returning Result as TotalCredit					
<input checked="" type="checkbox"/>	CALL Function NLD Function Credit Progression Year 1 passing in TotalCredit as TotalCredit returning ProgressionOutcome as ProgressionOutcome					

For an example of incorrectly indented Statements, see *Applying Rule Concepts and Adding Statements to a Rule, Add a CALL Statement to Determine Academic Progression*.

Applying Rule Concepts and Adding Statements to a Rule

In this section, an example Rule illustrates how Rule Options, Variables, Criteria, and Statements are used together. Previous sections of the documentation describe creating Variables, using Criteria to define a data set, and the features of delivered Statements for Rule evaluation and calculation.

The objective of this example Rule is to evaluate whether a student has obtained enough credits to be able to progress to the next phase of an academic program after having completed Year 1. To start, the Rule accesses the courses for the program of study for Year 1 and sums the credits for the courses the student has passed. In order to insure an accurate TotalCredit value, the Rule sets the TotalCredit Variable to zero prior to passing the sum result into a Variable, TotalCredit.

This example illustrates the fields and controls on the Example of Define Rule page for Progression Rule. You can find definitions for the fields and controls later on this page.

Define Rule	Version History	Cross Reference
Rule ID	SCC_RULE_ID_20130702044102	Action
Version	1	Rule Build Status
Rule Status	Active	Status Last Date/Time
*Rule Name	Documentation Example: Progression Rule for Undergraduate Year 1	
*Long Description	Documentation Example: Progression Rule for Undergraduate Year 1	
Rule Category Name	Documentation Examples	
Rule Group Name		
*Rule Usage	Rule	
Entity Name	APT Header	
*Skill Level	Expert	
*Logging Level	Trace Logging	
<input type="checkbox"/> Available To Be Used		

Add an ASSIGN Statement to Set the TotalCredit Field to Zero

With Rule Options, Variables, and Criteria defined, begin by adding an ASSIGN statement that selects the Variable *TotalCredit* and set it equal to the Number 0 (zero):

This example illustrates the fields and controls on the Example of Assignment Statement Definition. You can find definitions for the fields and controls later on this page.

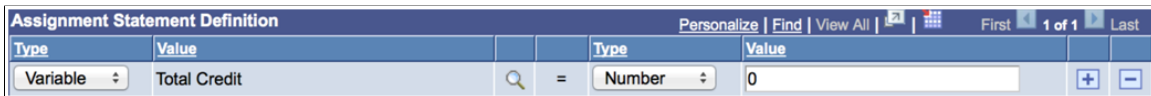

Upon saving, the ASSIGN statement is added to the Evaluations and Calculations grid of the Define Rule page with the Rule text automatically generated using the text color setup:

This example illustrates the fields and controls on the Example of ASSIGN Rule Text. You can find definitions for the fields and controls later on this page.



For more information about ASSIGN statements, see “Understanding Statement-Specific Attributes, ASSIGN Statements.”

Add a FOR EACH Statement to Select All Courses

The next step is to retrieve all courses for the academic program of study which is associated with the Academic Progress tracker through the APT header. You need to retrieve the correct APT Program of Study before selecting all associated courses. Select the APT program of study using a FOR-Each statement.

This example illustrates the fields and controls on the Example of FOR EACH Statement Definition. You can find definitions for the fields and controls later on this page.

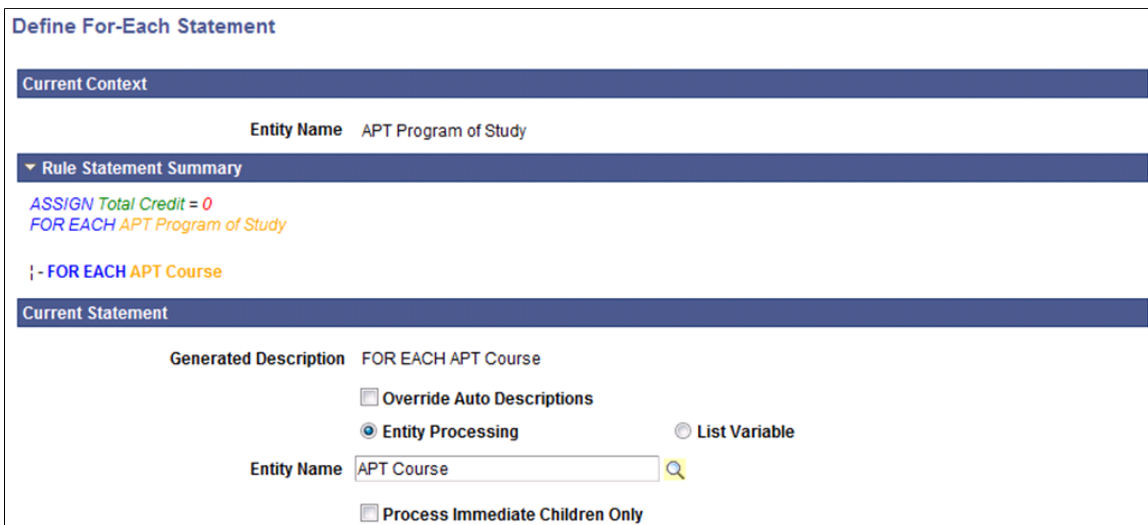

Select **Entity Processing** to activate the Entity Name field and prompt. Select the Search icon and choose the *APT Course* Entity. By selecting *APT Course*, you can retrieve all courses that are part of the APT instance selected as Base Entity. Do *not* select **Process Immediate Children Only** so the Rule selects

Courses wherever they exist in the structure and not just the immediate children of the APT Program of Study.

Upon saving, the FOR EACH statement is added to the Evaluations and Calculations grid of the Define Rule page with the Rule text automatically generated using the text color setup:

This example illustrates the fields and controls on the Example of FOR EACH Rule Text. You can find definitions for the fields and controls later on this page.

Evaluations and Calculations		Personalize	Find	First	1-3 of 3	Last
Active	Statement Description				Details	
<input checked="" type="checkbox"/>	ASSIGN Total Credit = 0					
<input checked="" type="checkbox"/>	FOR EACH APT Program of Study					
<input checked="" type="checkbox"/>	- FOR EACH APT Course					

Add a FOR EACH Statement to Select a Result for Each Course

Next, you add another FOR EACH Statement to Select APT Results for each Course. This statement is indented under the FOR EACH APT Course Statement so that it is executed for each to retrieve the APT Result for each APT Course.

This example illustrates the fields and controls on the Example of Indented FOR EACH APT Result Rule Text. You can find definitions for the fields and controls later on this page.

Evaluations and Calculations		Personalize	Find	First	1-5 of 5	Last
Active	Statement Description				Details	
<input checked="" type="checkbox"/>	ASSIGN Total Credit = 0					
<input checked="" type="checkbox"/>	FOR EACH APT Program of Study					
<input checked="" type="checkbox"/>	- FOR EACH APT Course					
<input checked="" type="checkbox"/>	- FOR EACH APT Attempt					
<input checked="" type="checkbox"/>	- FOR EACH APT Result					

Note: The Rules Engine Manager has logic which validates FOR EACH statements upon saving the Rule. A FOR EACH statement cannot be added to a Rule that is invalid, but it is possible to invalidate an existing FOR EACH statement by removing a statement from the Evaluations and Calculations grid or by deactivating a line on the Evaluations and Calculations grid. This would make the overall Rule invalid. For example, if an APT Attempt row is removed from the Evaluations and Calculations grid or moved to a new position after having been added, the overall Rule becomes invalid.

The APT Result can only exist in the rule as a child to APT Course and not as a child to APT attempt. This allowed while the Rule is being built because the action may have been done in the course of correcting the rule. However, when the rule is saved, the whole Rule is validated and appropriate warning messages are displayed. If a nested FOR EACH statement is used in combination with a CREATE ENTITY statement, the same logic applies.

Add an IF Statement

Next add an IF statement to make sure that we select the correct result before we add it to our total credit count. Do this by restricting the APT Results by Result Type and whether the Result is included in the Calculation:

This example illustrates the fields and controls on the Example of Define IF Statement Definition. You can find definitions for the fields and controls later on this page.

Define If Statement

Current Context

Entity Name APT Result

▼ Rule Statement Summary

ASSIGN Total Credit = 0
 FOR EACH APT Program of Study
 | - FOR EACH APT Course
 | | - FOR EACH APT Attempt
 | | | - FOR EACH APT Result

| | | | - Current New Row

Current Statement

Override Auto Descriptions

If Statement Definition

		Personalize		Find	View All	First	1-2 of 2	Last
	(+)	Type	Value	Operator	Type	Value		
	(+)	Property	APT Result.Result Type	=	Text	RESULT		
And	(+)	Property	APT Result.Include in Calculation	=	Text	Y		

Add a CALL Statement to Sum Credits

After adding specified criteria for selecting results, use a CALL statement to call a Function to sum the retrieved credits. In the Define CALL Statement page, pre-delivered Functions are available that are restricted to those which are available in the Rule Categories, including common math functions.

When calling a Function, the required parameters are automatically displayed and the available parameter values are restricted to those that can be retrieved for the Rule. For example, when selecting **Rule Category Math** and **Rule Name Add**, the **Input** and **Output** parameters are displayed. The selection of variables and properties and variables are restricted to show the correct property and variable types. In this case only numeric variables and properties can be selected:

This example illustrates the fields and controls on the Example of Define CALL Statement. You can find definitions for the fields and controls later on this page.

Define Call Statement

Current Context

Entity Name APT Result

▼ Rule Statement Summary

ASSIGN Total Credit = 0
 FOR EACH APT Program of Study
 | - FOR EACH APT Course
 | | - FOR EACH APT Attempt
 | | | - FOR EACH APT Result
 | | | | - IF APT Result.Result Type = RESULT And APT Attempt.Include in Calculation = Y

| | | | | - Current New Row

Current Statement

Override Auto Descriptions

Rule Category Name Math

Rule Name

When calling a Function, the Function itself indicates which Input and Output parameters are required. Only the valid Property and Variable Types are shown. In this case, only numeric Variables and Properties can be selected:

This example illustrates the fields and controls on the Example of CALL Statement Inputs and Outputs. You can find definitions for the fields and controls later on this page.

Inputs		Personalize Find View All [grid icon]		First	1 of 1	Last
Arguments	Type	Object				Required
Total Credit	= Variable	Total Credit				<input checked="" type="checkbox"/>

Outputs		Personalize Find View All [grid icon]		First	1 of 1	Last
Type	Object	Return				
Variable	Progression Outcome	= ProgressionOutcome				

Upon saving, the CALL statement is added to the Evaluations and Calculations grid of the Define Rule page with the Rule text automatically generated using the text color setup:

This example illustrates the fields and controls on the Example of CALL Statement Rule Text. You can find definitions for the fields and controls later on this page.

<input checked="" type="checkbox"/>	CALL Function Add passing in APT.Result.Result Value as Value 1, Total Credit as Value 2 returning Result as Total Credit	[up] [down] [grid] [plus] [minus]
-------------------------------------	---	-----------------------------------

Add a CALL Statement to Determine Academic Progression

After calculating a student's total credits, you can use that result to evaluate whether the student may progress to Year 2 of his program of study. Assuming that multiple programs of study use the same credit requirement for academic progression, you can create a Rule of type Function that can be used by multiple academic progression Rules:

This example illustrates the fields and controls on the Example of Academic Progression Function (1 of 2). You can find definitions for the fields and controls later on this page.

Rule ID	SCC_RULE_ID_20130702070804	Action	[dropdown]
Version	1	Rule Build Status	Build Successful
Rule Status	Active	Status Last Date/Time	02-07-2013 07:12 PDT
*Rule Name	Credit Progression for Year 1		
*Long Description	Credit Progression for Year 1 This evaluative statement can be applied to multiple programs which have the same progression rules.		
Rule Category Name	Documentation Examples		[magnifying glass]
Rule Group Name	[input]		[magnifying glass]
*Rule Usage	Function		[dropdown]
Entity Name	[input]		[magnifying glass]
*Skill Level	Expert		[dropdown]
*Logging Level	Informational Messages		[dropdown]
	<input checked="" type="checkbox"/> Available To Be Used		
Variables			
Add a Variable			

This example illustrates the fields and controls on the Example of Academic Progression Function (2 of 2). You can find definitions for the fields and controls later on this page.

Evaluations and Calculations									
Active	Statement Description							Details	
<input checked="" type="checkbox"/>	IF Total Credit >= 60								
<input checked="" type="checkbox"/>	;- ASSIGN ProgressionOutcome = Pass								
<input checked="" type="checkbox"/>	ELSE IF Total Credit >= 60								
<input checked="" type="checkbox"/>	;- IF Total Credit >= 42								
<input checked="" type="checkbox"/>	;; - ASSIGN ProgressionOutcome = ConditionalPass								
<input checked="" type="checkbox"/>	;- ELSE IF Total Credit >= 42								
<input checked="" type="checkbox"/>	;; - IF Total Credit >= 36								
<input checked="" type="checkbox"/>	;;; - ASSIGN ProgressionOutcome = RepeatYear1								
<input checked="" type="checkbox"/>	;; - ELSE IF Total Credit >= 36								
<input checked="" type="checkbox"/>	;;; - IF Total Credit < 36								
<input checked="" type="checkbox"/>	;;; - ASSIGN ProgressionOutcome = Fail								
<input checked="" type="checkbox"/>	;; - ELSE IF Total Credit < 36								
<input checked="" type="checkbox"/>	;;; - ASSIGN ProgressionOutcome = Undetermined								

This Function can be called from the main Rule by adding a row to the Evaluations and Calculations grid and using the CALL statement. The Parameters from the Rule are automatically offered as Input and Output parameters on the Define Call Statement page:

This example illustrates the fields and controls on the Example of Academic Progression Function Input and Output. You can find definitions for the fields and controls later on this page.

Variables									
Argument Name	Type	List	System	Input	Output	Required	Count	Details	
Total Credit	Number	<input type="checkbox"/>	<input type="checkbox"/>	<input checked="" type="checkbox"/>	<input type="checkbox"/>	<input checked="" type="checkbox"/>	4		
ProgressionOutcome	Text	<input type="checkbox"/>	<input type="checkbox"/>	<input type="checkbox"/>	<input checked="" type="checkbox"/>		5		

Upon saving, the academic progress CALL Function is added to the Evaluations and Calculations grid of the Define Rule page with the Rule text automatically generated using the text color setup. However, its placement would result in its being executed at the wrong time:

This example illustrates the fields and controls on the Example of Academic Progression Rule Text with Progression Function Incorrectly Indented. You can find definitions for the fields and controls later on this page.

<input checked="" type="checkbox"/>		;; - CALL Function Add passing in APT Result.Result Value as Value 1, Total Credit as Value 2 returning Result as Total Credit							
<input checked="" type="checkbox"/>		;; - CALL Function Credit Progression for Year 1 passing in Total Credit as Total Credit returning ProgressionOutcome as Progression Outcome							

With the CALL Function in the current position, the evaluation takes place for each result selected as follows:

- Fetch of Course A
 - Retrieval of Result for Course A
 - — Add retrieved result for Course A to TotalCredit

- — Call Function Credit progression Year 1
- Fetch of Course *B*
 - Retrieval of Result for Course *A*
 - — Add retrieved result for Course *B* to TotalCredit
 - — Call Function Credit progression Year 1

The evaluation of academic progression takes place each time a result is retrieved. This is not what you want the Rule to do. What you want is for the academic progression evaluation to take place after all the course credit have been added up:

- Fetch of Course *A*
 - Retrieval of Result for Course *A*
 - — Add retrieved result for Course *A* to TotalCredit
- Fetch of Course *B*
 - Retrieval of Result for Course *A*
 - — Add retrieved result for Course *B* to TotalCredit
- Call Function Credit progression Year 1

Use the remove indentation field to place the statement in the correct place:

This example illustrates the fields and controls on the Example of Academic Progression Rule Text with Progression Function Correctly Indented. You can find definitions for the fields and controls later on this page.

<input checked="" type="checkbox"/>	- CALL Function Add passing in APT Result.Result Value as Value 1, Total Credit as Value 2 returning Result as Total Credit	▲ ▼		+ -
<input checked="" type="checkbox"/>	▶ CALL Function Credit Progression for Year 1 passing in Total Credit as Total Credit returning ProgressionOutcome as Progression Outcome	▲ ▼		+ -

Understanding Contextual Referencing

The Rules Engine includes a feature called Contextual Reference. This feature ensures that when Functions are called by other Rules (Calling Rules), the Entity of the Calling Rule is passed to the called Function.

The following is an example of a Rule using Contextual Referencing which does the following:

1. Selects all relevant Courses.
2. For each Course, determines whether an enrollment record exists in Year 1 of the academic program according to the APT schedule record using user defined Function.
3. Selects the appropriate result which is stored in the result record as Result Type “ECTS”.

4. Uses the result value obtained in the previous step to calculate the sum of credit using delivered math Function “Add” in Category “Math”.
5. Evaluates whether total credit is enough to progress to year 2 of the academic program using user defined Function.

This example illustrates the fields and controls on the Example of Progression Rule for Contextual Reference Example (1 of 2). You can find definitions for the fields and controls later on this page.

The screenshot shows a configuration page for a rule. At the top, it displays the Rule ID (SCC_RULE_ID_20130702082429), Version (1), and Rule Build Status (Build Successful). The Rule Status is 'In Progress' with a status last date/time of '02-07-2013 08:47 PDT'. The Rule Name and Long Description are both 'Documentation Example: Progression Rule for Undergraduate Year 1'. Below this, the Rule Category Name is 'Documentation Examples' and the Rule Group Name is empty. The Rule Usage is set to 'Rule', Skill Level to 'Expert', and Entity Name to 'APT Header'. The Entity Data Load Option is 'Retrieve Data By Criteria' and the Logging Level is 'Trace Logging'. There is an unchecked checkbox for 'Available To Be Used'. At the bottom, there is a 'Variables' section with an 'Add a Variable' button.

This example illustrates the fields and controls on the Progression Rule for Contextual Reference Example (2 of 2). You can find definitions for the fields and controls later on this page.

The screenshot shows a table titled 'Criteria' with a sub-header 'Evaluations and Calculations'. The table has columns for 'Active', 'Statement Description', and 'Details'. It lists several criteria with checkboxes in the 'Active' column and expand/collapse icons in the 'Details' column. The criteria include: 'ASSIGN Total Credit = 0', 'FOR EACH APT Program of Study', 'FOR EACH APT Course', 'FOR EACH APT Attempt', 'CALL Function Schedule Check Check specific Year of Program against the Attempt passing in Year of program as Year of Program, Curriculum Term as Term returning Year of Program is Correct as Year of Program is Year 1', 'IF Year of Program is Year 1 = True', 'FOR EACH APT Result', 'IF APT Result.Result Type = ECTS And APT Attempt.Include in Calculation = Y', 'CALL Function Add passing in APT Result.Result Value as Value 1, Total Credit as Value 2 returning Result as Total Credit', and 'CALL Function Credit Progression for Year 1 passing in Total Credit as Total Credit returning ProgressionOutcome as Progression Outcome'.

The Functions used to perform summing of Total Credit (Steps 4 and 5) receive either an Input value of type Variable or Property directly from the Calling Rule. An input Variable is all that these Functions need to execute the required processing logic. The Function performs a series of evaluative Statements using the single input Variable *TotalCredit* and passes back the result into Variable *Progressionoutcome*. The Function has no Entity of its own and is without criteria.

Shown below is an example of the custom Function “NLD Function Credit Progression Year 1”.

This example illustrates the fields and controls on the Example of Progression Function for Contextual Reference (1 of 2). You can find definitions for the fields and controls later on this page.

Define Rule | Version History | Cross Reference

Rule ID: SCC_RULE_ID_20120801120231 Action: [Dropdown]

Version: 1 Rule Build Status: Build Successful

Rule Status: Active Status Last Date/Time: 03/15/2013 3:03PM PDT

*Rule Name: NLD Function Credit Progression Year 1

*Long Description: NLD Progression Rule For Year 1:
>= 60 then Pass
Between 42 and 60 Conditional Pass

*Rule Category Name: NLD Demo Rules

Rule Group Name: [Empty]

*Rule Usage: Function

Entity Name: [Empty]

*Skill Level: Expert

*Logging Level: Informational Messages

Available in Other Rules

Variables									
Argument Name	Type	List	System	Input	Output	Required	Count	Details	
TotalCredit	Number	<input type="checkbox"/>	<input type="checkbox"/>	<input checked="" type="checkbox"/>	<input type="checkbox"/>	<input type="checkbox"/>	4	[Icon]	[Minus]
ProgressionOutcome	Text	<input type="checkbox"/>	<input type="checkbox"/>	<input type="checkbox"/>	<input checked="" type="checkbox"/>	<input type="checkbox"/>	5	[Icon]	[Minus]

Add a Variable

This example illustrates the fields and controls on the Example of Progression Function for Contextual Reference (2 of 2). You can find definitions for the fields and controls later on this page.

Evaluations and Calculations									
Active								Details	
<input checked="" type="checkbox"/>	IF	TotalCredit	>=	60				[Icon]	[Plus] [Minus]
<input checked="" type="checkbox"/>	-	ASSIGN	ProgressionOutcome	=	Pass			[Icon]	[Plus] [Minus]
<input checked="" type="checkbox"/>	ELSE IF	TotalCredit	>=	60				[Icon]	[Plus] [Minus]
<input checked="" type="checkbox"/>	-	IF	TotalCredit	>=	42			[Icon]	[Plus] [Minus]
<input checked="" type="checkbox"/>	-	ASSIGN	ProgressionOutcome	=	ConditionalPass			[Icon]	[Plus] [Minus]
<input checked="" type="checkbox"/>	-	ELSE IF	TotalCredit	>=	42			[Icon]	[Plus] [Minus]
<input checked="" type="checkbox"/>	-	IF	TotalCredit	>=	36			[Icon]	[Plus] [Minus]
<input checked="" type="checkbox"/>	-	ASSIGN	ProgressionOutcome	=	RepeatYear1			[Icon]	[Plus] [Minus]
<input checked="" type="checkbox"/>	-	ELSE IF	TotalCredit	>=	36			[Icon]	[Plus] [Minus]
<input checked="" type="checkbox"/>	-	IF	TotalCredit	<	36			[Icon]	[Plus] [Minus]
<input checked="" type="checkbox"/>	-	ASSIGN	ProgressionOutcome	=	Fail			[Icon]	[Plus] [Minus]
<input checked="" type="checkbox"/>	-	ELSE IF	TotalCredit	<	36			[Icon]	[Plus] [Minus]
<input checked="" type="checkbox"/>	-	ASSIGN	ProgressionOutcome	=	Undetermined			[Icon]	[Plus] [Minus]

Save Return

Next is an example of the Function “Schedule Check, Check specific Year of Program against the Attempt”. This Function does have its own Base Entity “APT Attempt”, but only Input and Output parameters are defined in the Call Statement shown after the Function example. The criteria identifying the exact APT Attempt are not explicitly passed from the Calling Rule to the Called Function.

However, when the Function is called, the exact Attempt information is passed from the calling Rule to the called Function by virtue of Contextual Reference. This is because the called Function's Base Entity is APT Attempt which is the same context that the Calling Rule is working from when retrieving Attempts using the FOR-EACH loop.

This example illustrates the fields and controls on the Example of Program Course Function for Contextual Reference. You can find definitions for the fields and controls later on this page.

Define Rule
Version History
Cross Reference

Rule ID: SCC_RULE_ID_20130702082840

Version: 1

Rule Status: Active

*Rule Name: Schedule Check Check specific Year of Program against the Attempt

*Long Description: Schedule Check Check specific Year of Program

Rule Category Name: Documentation Examples

Rule Group Name:

*Rule Usage: Function

Entity Name: APT Attempt

*Skill Level: Expert

*Logging Level: No Message Logging

Available To Be Used

Action: ▼

Rule Build Status: Build Successful

Status Last Date/Time: 02-07-2013 08:32 PDT

Variables

Add a Variable

Evaluations and Calculations		Personalize Find First 1-3 of 3 Last
Active	Statement Description	Details
<input checked="" type="checkbox"/>	FOR EACH APT Schedule	▼ + -
<input checked="" type="checkbox"/>	;- IF APT Schedule.Year of Program = Year of Program And APT Schedule.Term = Term	▲ ▼ + -
<input checked="" type="checkbox"/>	;- ASSIGN Year of Program is Correct = True	▲ + -

This example illustrates the fields and controls on the Example of Call Statement for Contextual Reference. You can find definitions for the fields and controls later on this page.

Current Statement

Generated Description: CALL Function Schedule Check Check specific Year of Program against the Attempt passing in Year of program as Year of Program, Curriculum Term as Term returning Year of Program is Correct as Year of Program is Year 1

Override Auto Descriptions

Rule Category Name: Documentation Examples

Rule Name: Schedule Check Check specific Year of Program against the Attempt

Inputs				Personalize Find View All First 1-2 of 2 Last
Arguments	Type	Object	Required	
Year of Program	= Variable	Year of program	<input checked="" type="checkbox"/>	▼
Term	= Variable	Curriculum Term	<input checked="" type="checkbox"/>	▼

Outputs				Personalize Find View All First 1 of 1 Last
Type	Object	Return		
Variable	Year of Program is Year 1	=	Year of Program is Correct	▼

Building and Testing Rules

This section discusses how to:

- Build Rules.
- Test Rules.
- Create a new version of a Rule.
- View the Page Process Flow.
- View Rule Cross-references.

Pages for Building and Testing Rules

<i>Page Name</i>	<i>Definition Name</i>	<i>Navigation</i>	<i>Usage</i>
Rule Builder	SCC_RULE_BUILDER	Set up SACR > System Administration > Rules Engine > Rules Engine Manager , select Search for a Rule, Define Rule, select an Action of Build Rule.	Select Rules to build.
Build Rules	SCC_RULE_REBUILD	Set up SACR > System Administration > Rules Engine > Setup > Build Rules	Search for Rules to build.
Rules Engine Tester	SCC_RULE_REBUILD	Set up SACR > System Administration > Rules Engine > Rules Engine Manager , select Search for a Rule, Define Rule, select an Action of Test Rule.	Test a Rule.
Rules Engine Manager Version History	SCC_RULE_VERSION	Set up SACR > System Administration > Rules Engine > Rules Engine Manager , select Search for a Rule, Version History tab.	View and manage Version History for a Rule.
Rules Engine Manager Cross Reference	SCC_RULE_XREF	Set up SACR > System Administration > Rules Engine > Rules Engine Manager , select Search for a Rule, Cross Reference tab.	View the other Rules where this Rule is used.

Page Name	Definition Name	Navigation	Usage
Rules Engine Tester	SCC_RULE_REBUILD	Set up SACR > System Administration > Rules Engine > Rules Engine Manager , select Search for a Rule, Define Rule, select an Action of Test Rule.	Test a Rule.

Building Rules

Before a Rule can be tested or used, the code in the Rule needs to be converted to executable code. This is done by the Rules Engine Build code compilation process. This process can be initiated:

- From an individual Rule using the Rule **Action Build** on the Define Rule page.
- In batch using the Build Rules process, where you can build multiple Rules simultaneously.

Building a Rule from the Define Rule Page

Access the Define Rule page (**Set up SACR > System Administration > Rules Engine > Rules Engine Manager**, select Search for a Rule, Define Rule).

Select the *Update Status Information Action* to display the current **Rule Build Status**.

Then, select the *Build Action* to open the **Rule Builder** page, select the Rule, and click the **Build** button to compile the Rule:

This example illustrates the fields and controls on the Rule Builder Page. You can find definitions for the fields and controls later on this page.

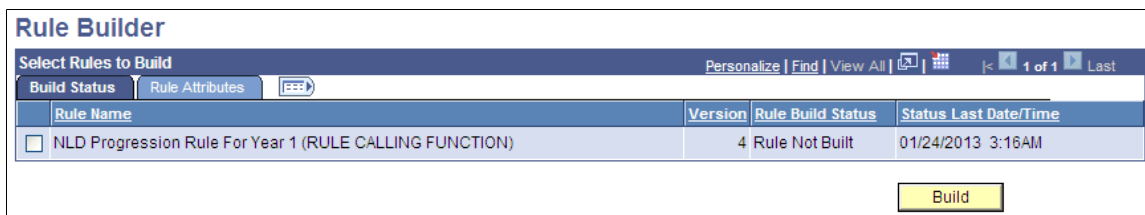

Rule Builder			
Select Rules to Build			
Build Status	Rule Attributes		
Rule Name	Version	Rule Build Status	Status Last Date/Time
<input type="checkbox"/> NLD Progression Rule For Year 1 (RULE CALLING FUNCTION)	4	Rule Not Built	01/24/2013 3:16AM

Build

If the **Rule Build Status** is updated to *Build Successful*, you may proceed to testing the Rule. Otherwise, consult your Rule for Current Logic. A flaw in Rule Logic may be the issue.

Building Multiple Rules at the Same Time

Access the Build Rules page (**Set up SACR > System Administration > Rules Engine > Setup > Build Rules**).

Select any search parameter fields you want to use to search for Rules you want to build and click the Search button. If you click the Search button without making any parameter selection, all Rules are returned.

Select the Rules you want to build and click the **Build** button.

Testing Rules

After a Rule is built successfully, you can test the Rule.

Access the Define Rule page (**Set up SACR > System Administration > Rules Engine > Rules Engine Manager**, select Search for a Rule, Define Rule).

Select the *Test Rule Action* to open the **Rules Engine Tester** page:

This example illustrates the fields and controls on the Rules Engine Tester page. You can find definitions for the fields and controls later on this page.

Rules Engine Tester

Rule Name Doc Example: Determine Average Result and Credit for Year 1 UGRD, Psych
Rule ID SCC_RULE_ID_20130627053910
Version 1 **Rule Status** Active
Entity ID APT Header

Test Data Profiles

Test Data Profile

Inputs

Type	Variable Name	Long Description	Required	Arguments	Search
Text	Institution	Institution	<input checked="" type="checkbox"/>		
Text	Academic Career	Academic Career	<input checked="" type="checkbox"/>		
Text	APT Status	APT Status	<input checked="" type="checkbox"/>	Test	
Text	Term	Term	<input checked="" type="checkbox"/>		
Text	Valid Academic Items	Valid Academic Items	<input checked="" type="checkbox"/>	Click Search for input list	

Execute Test

Outputs

Type	Variable Name	Long Description	Return
Number	Sum ECTS	Sum ECTS	
True/False	Result Mark is Stored	Result Mark is Stored	
Text	Result Mark is Not Sored	Result Mark is Not Sored	
True/False	Result ECTS is stored	Result ECTS is stored	
Text	Result ECTS is not stored	Result ECTS is not stored	

This example illustrates the fields and controls on the Rules Engine Tester page (Inputs and Outputs). You can find definitions for the fields and controls later on this page.

Inputs

Type	Variable Name	Long Description	Arguments
Number	Number1	Number1	<input type="text" value="10"/>
Number	Number2	Number2	<input type="text" value="11"/>

Execute Test **Elapsed Time** 0:0:0.0

Outputs

Type	Variable Name	Long Description	Return	Details
Number	NumberList1	NumberList1	Click Details for output list	
Number	ListLenght	ListLenght	4	
Number	NumberList2	NumberList2	Click Details for output list	

This example illustrates the fields and controls on the Example of Rules Engine Tester List Output. You can find definitions for the fields and controls later on this page.

View List Values

Variable Name NumberList2

Type Number

List Values
First 1-4 of 4 Last

[Personalize](#) | [Find](#) | |

Object
2
7
10
11

Default List Values

(2;7;10;11)

Enter the required Arguments that are needed to test the Rule. After test parameters have been added the Parameters can be saved as a Rule Test Profile.

Field or Control	Description
Test Data Profile	Select a saved Test Data Profile.
Delete	Click this button to delete a stored Test Data Profile.
Update	Click this button to update a stored Test Data Profile with new parameters.
Add a New Test Data Profile and Add	Enter a name if you want to save a new Test Data Profile and click the Add button. A Test Data Profile can be added after the Rule has been executed using the listed parameters
Inputs	Displays all Parameters/Variables which have been listed as Input. <hr/> Note: The text <i>Click Search for input list</i> appears next to <i>List Input Variables</i> . Click the Search icon to provide input.
Arguments	Enter the required Arguments needed to test the Rule.

Field or Control	Description
Execute Test	Select this button to execute the Rule. If a Rule needs parameters and none are provided, the Rule cannot be executed.
Outputs	Displays all output Parameters/Variables with the output result when the Rule executes successfully. Note: The text <i>Click details for output list</i> appears in the Output grid for <i>List</i> Variables only. Click on the Details icon to view <i>List</i> Variable output on a secondary page.
Debug Log Information	Displays debug information is shown if the Logging Level is set on the Define Rule page. The Debug Log Information shows the execution logic of the Rule in order of execution. Refer to the “Starting Query” for information about how the Base Entity is selected and with which criteria the selection is done. If this is a Rule, a Select statement is generated based on the underlying tables associated with the Base Entity attached to the Rule. The Criteria attached to the Rule is used to create the Starting Query's Criteria. Refer to the individual debug statements to view what information was selected per statement. The timestamp option shows the elapsed time.
Return	Select this button to return to the Rules Engine Manager page.

XML Dumps of the Entity, before and after Rule execution, are also displayed:

This example illustrates the fields and controls on the Example of XML Dump in Rule Tester. You can find definitions for the fields and controls later on this page.

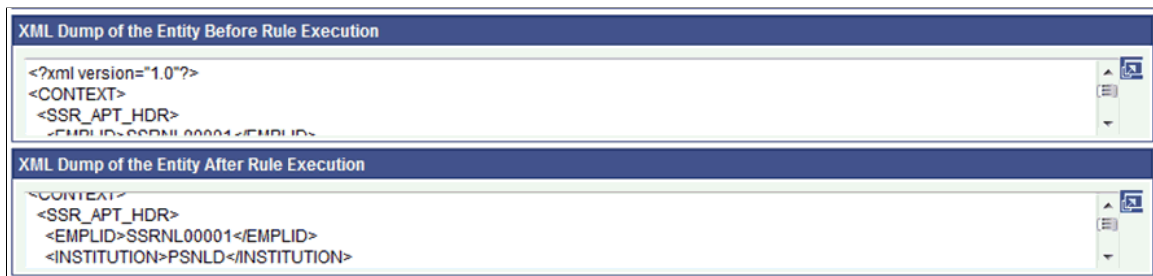

Field or Control	Description
XML Dump of the Entity Before Execution	Displays all data selected for the Base Entity and made available to the Rule.

<i>Field or Control</i>	<i>Description</i>
XML Dump of the Entity after Execution	Displays all current data for the Base Entity after the Rule is executed. This information is relevant in instances where the Rule is used to update or insert data in the database.

Creating a New Version of a Rule

Active Rules can be referenced by other Rules or by online triggers and/or batch processes. In a production environment, it should not be possible to change anything in an active Rule. Changing an Active Rule can be disruptive to business processes. Therefore, Rule changes should be made by creating a new version of an Active Rule. Only one Active version of a Rule exists for any Rule at any given time. Since Rules are referenced by other systems using the **Rule ID**, it is always the Active version of the Rule that is executed. Use the *Create new Version of Rule* Action on the **Define Rule** page to create a new version of an Active Rule.

After the option Create new version of Rule has been selected the user is shown a warning message:

This example illustrates the fields and controls on the Example of Create New Rule Warning Message. You can find definitions for the fields and controls later on this page.

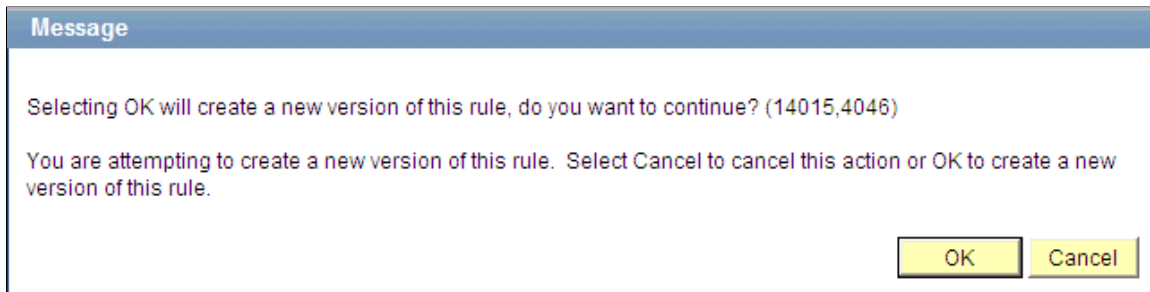

After clicking OK on the warning message, the **Version History** page opens:

This example illustrates the fields and controls on the Version History page. You can find definitions for the fields and controls later on this page.

Define Rule	Version History	Process Flow	Cross Reference
Rule ID	SCC_RULE_ID_20120802063334		
Version	3	Rule Status	In Progress
Rule Name	NLD Progression Rule For Year 1 (RULE CALLING FUNCTION)		
Change Reason			
Find View All First 1 of 1 Last			
*Version Code	Correct Rule Mistake		
Comments	correcting mistake		
Last Updated By	PS		
Last Updated On	26-11-2012 05:33:52		
Version History			
Version 1			
Initial Version of the Rule			
Last update by on			
Version 2			
TestingPurposes			
testing			
Last update by PS on 26 November 2012			

Note: You may also access the Version History by navigating to **Set up SACR > System Administration > Rules Engine > Rules Engine Manage > Version History**.

Older versions of the Rule are shown as Version History. Any Version Codes and Comments are displayed by Version. You can still ignore the new Rule **Version** created by cancelling out of the page without saving.

After saving the Rule Version, an Operator ID and Date Time stamp are automatically updated, and the status of the new **Version** is *In Progress*. In the example illustrated above, **Version 2** remains *Active* until Version 3 is activated. When activating **Version 3**, **Version 2** becomes Inactive automatically.

Note: It is not possible to reactivate “old” versions of Rules.

Viewing Rule Cross References

Access Rules Engine Manager Cross Reference page (Set up SACR, System Administration, Rules Engine, Rules Engine Manager, Cross Reference).

This example illustrates the fields and controls on the Cross Reference page. You can find definitions for the fields and controls later on this page.

Define Rule
Version History
Process Flow
Cross Reference

Rule ID SCC_RULE_ID_20120801120231

Version 1 Rule Status Active

Rule Name NLD Function Credit Progression Year 1

Rule Cross-Reference			
	Version	Rule Status	Rule Category Name
NLD Progression Rule For Year 1 (RULE WITH SCHEDULE CHECKS)	2	Inactive	NLD Demo Rules
NLD Progression Rule For Year 1 (RULE CALLING 1 RULE AND 1 FUNCTION)	1	Active	NLD Demo Rules
NLD Progression Rule For Year 1 (RULE CALLING FUNCTION)	1	Inactive	NLD Demo Rules
NLD Progression Rule For Year 1 (RULE CALLING FUNCTION)	2	Inactive	NLD Demo Rules
NLD Progression Rule For Year 1 (RULE CALLING FUNCTION)	3	Active	NLD Demo Rules
NLD Progression Rule for Year 1 Rebuild (RULE CALLING FUNCTION)	1	Active	NLD Demo Rules
NLD Progression Rule for Year 1 Rebuild (RULE WITH SCHEDULE CHECKS)	1	Active	NLD Demo Rules
NLD Progression Rule for Year 1 Rebuild (RULE CALLING FUNCTION- CE without Save)	1	Active	NLD Demo Rules
NLD Progression Rule for Year 1 Rebuild (RULE CALLING FUNCTION- CREATE ENTITY) 1	1	Active	NLD Demo Rules
NLD Progression Rule for Year 1 Copy (RULE CALLING FUNCTION- CREATE ENTITY)	1	In Progress	NLD Demo Rules

A Rule Cross Reference page is available which shows all Rules which are referencing the current Rule via a call statement. Click the link to navigate directly to the referenced Rule. If there no other Rules reference the current Rule, a message is displayed: “This Rule is not used by another Rule.”

Running Rules in Batch

Active Rules can be run in batch. Run Rules as a one off process or scheduled them to run at regular intervals.

Page Used for Running Rules in Batch

Page Name	Definition Name	Navigation	Usage
Process Rules in Batch	SCC_RULE_RC_BAT	Set Up SACR > System Administration > Rules Engine > Batch Processes > Run Rules in Batch	Use this page to run Active Rules in batch.

Running Rules in Batch

Access the Run Rules in Batch page (**Set Up SACR > System Administration > Rules Engine > Batch Processes > Run Rules in Batch**).

This example illustrates the fields and controls on the Process Rules in Batch page. You can find definitions for the fields and controls later on this page.

Process Rules in Batch

Run Control ID: Batch_example Report Manager Process Monitor Run

Rule Category Name Admissions and Recruiting 🔍

Rule Name Assign Recruiting Category and a Recruiter to an Applicant 🔍

Version 1

Description Assign Recruiting Category and a Recruiter to an Applicant based on the following criteria:
 For any applicant with the status admitted or applicant from the selected Admit Term, Institution and Academic Career the highest Test score is retrieved and evaluated.

The following must be true:
 1. For ACT's Tests the GE test score must be > 33
 or
 2. For SAT's the Test score for Math and VERB > 700

If conditions are met the recruiter category of Honors is assigned to the applicant as well as a dedicated recruiter (ADREC1)

Entity Name Academic Program

Type	Argument Name	Description	Required	Object	Search
1 Text	Academic Career	Academic Career	<input checked="" type="checkbox"/>	UGRD	🔍
2 Text	institution	institution	<input checked="" type="checkbox"/>	PSNLD	🔍
3 Text	Admit Term	Admit Term	<input checked="" type="checkbox"/>	<input type="text" value="0610"/>	
4 Text	Academic Program	Academic Program	<input checked="" type="checkbox"/>	<input type="text" value="LAU"/>	

Field or Control	Description
Rule Category Name	Select a Rule Category . The Rule Category search is restricted to those for which you are authorized.
Rule Name	Select a Rule. Available Rules are filtered using the following criteria: <ul style="list-style-type: none"> Rule Usage is <i>Rule</i>. Rule Status is <i>Active</i>. Available to be Used is <i>True</i> (selected).
Version	Displays the version of the selected rule
Description	Displays the Description of the Rule, if any.
Entity Name	Displays the Base Entity of the Rule, if any.
Rule Group Name	Displays the Rule Group Name of the Rule, if any.

Variables

After selecting a Rule Name, the required variables are displayed in a grid. You must provide an **Object** input value for each required Variables before running or scheduling a Rule. If LOV prompting has been added to a Variable, the same LOV prompting functionality can be used to provide an **Object** input for the Variable.

Batch Process Logging

The Rules Engine Batch process generates log files for the Rule and any called Rules or Functions if the Rules and or called Functions have been built using one of these Rules Engine logging levels:

- Informational Messages
- Trace Logging
- Error Messages
- Warning Messages

With Trace Logging, three files are generated:

- RuleDebugFile – A log file with a transcript of Call Statements, Variable Maps and Contents, and Statements.
- RuleEntityPostExecute – An XML file containing a dump of the Entity structure *prior to* processing.
- RuleEntityPreExecution – An XML file containing a dump of the Entity structure *after* processing. Any updates and or inserts into the system are logged in the XML file.

Integrating User Interfaces with the Rules Engine

In addition to the system-delivered interfaces with the Rules Engine (Rules Engine Tester, Rules Engine Batch Processing, and selected user interfaces in Program Enrollment, Activity Management, Research Tracking, and Evaluation Management System), you can create custom integrations to the Rules Engine for user interfaces throughout Campus Solutions.

In this topic, we are illustrating the creation of a custom interface to the Rules Engine to meet the following business requirement:

Provide a button on component Records and Enrollment > Student Term Information > Term History > Student Special GPA that calculates a Special Grade Point Average based on courses from a student's major and displays the result on the page.

The steps to meet this requirement are:

1. Build and test a Functional Rule.
2. Generate a Trigger to call the Functional Rule.
3. Generate boilerplate code.

4. Attach the generated code to the component event.

Building and Testing a Functional Rule

The first step is to build and the test a Functional Rule to integrate with Student Special GPA page; in this example, a Rule that calculates a Special Grade Point Average based on a student's Academic Program, Academic Plan, or Academic Sub-Plan. Using the functional business requirement as a starting point, start by looking at how to retrieve the needed data.

Data and Entity Considerations

To determine how to retrieve the data, decide which role to use to build the Rule: Functional Expert Role or Developer Role. This example uses the Functional Expert Role instead of the Developer Role to create an *Expert Rule*. This assumes that Functional Experts want to create similar grade point average calculation Rules at a later stage and/or adjust the business logic for the created Rule over time. Rules created by a Developer Role are created in Application Package PeopleCode by developers. So, while Functional Experts are able to use such Rules, they have no means to adjust their business logic. By creating an Expert Rule, Functional Experts are able to clone or adjust the Rule.

Since this is an Expert Rule, an Entity is required to be in place for this data. For this example, system-delivered Entities are used, but new Entities can be created if needed. For information on creating Entities, see [Creating a New Entity](#).

In this example, the Student Grade Inquiry page (Records and Enrollment > Student Term Information > Student Grades) is based on the record view CLASS_TBL_SE_VW, which contains all the information needed for this Rule. Since record tables are not being updated with this Rule, a record view is suitable.

This example illustrates the Student Special GPA page before a custom integration with the Rules Engine.

Navigate to the Entity Registry (**Set Up SACR > System Administration > Entity > Entity Registry**) to find that there is an existing matching Entity, *Student Enrollment – Read Only*, for record view CLASS_TBL_SE_VW. For this Entity, **Entity Type** is set to *Read Only* for **Prod Record CLASS_TBL_SE_VW**. The *Read Only Entity Type* does not allow an update or save to be executed by the Rules Engine. The **Entity Status** is set to *Active*. No AppClass (application class) is needed for Read Only Entities. The AppClass is reserved for Application Class PeopleCode which controls the save

Validation logic for the Entity. Use the **Action** drop down and select *View Hierarchy* to view the Entity structure and its properties.

This example illustrates the Entity Registry page for the Student Enrollment – Read Only Entity.

Entity Registry

Entity Configuration

Entity ID: SCC_ENTITY_20140218085710

Name:

Status:

Entity Type:

Description: This entity is used to pull enrollment information for a specific student using CLASS_TBL_SE_VW.

AppClass:

Prod Record:

Element (XML):

Action:

Children									
Order	*Entity Name	Status	Embed	*Min	*Max	Element Wrapper (XML)	Hide	View	
1	<input type="text" value=""/>		<input type="checkbox"/>	0	0	<input type="text" value=""/>	<input type="checkbox"/>	View	+ -

Although this Rule is not updating CLASS_TB_SE_VW, it does access and update the calculated Special GPA. The production record for Special GPA is STDNT_SPCL_GPA.

Navigate to the Entity Registry (**Set Up SACR > System Administration > Entity > Entity Registry**) to find that there is an existing matching Entity, *Student Special GPA*, for production record STDNT_SPCL_GPA. For this Entity, **Entity Type** is set to *Unvalidated Entity* for **Prod Record** STDNT_SPCL_GPA. The *Unvalidated Entity* **Type** allows data to be inserted and updated with *no* validation. The **Entity Status** is set to *Active*. No AppClass (application class) is needed for Unvalidated Entities. The AppClass is reserved for Application Class PeopleCode which controls the save Validation logic for the Entity. Use the **Action** drop down and select *View Hierarchy* to view the Entity structure and its properties.

This example illustrates the Entity Registry page for the Student Special GPA Entity.

Entity Registry

Entity Configuration

Entity ID: SCC_ENTITY_20140214090313

Name:

Status:

Entity Type:

Description:

AppClass:

Prod Record:

Element (XML):

Action:

Children

Order	*Entity Name	Status	Embed	*Min	*Max	Element Wrapper (XML)	Hide	View	
1	<input type="text" value=""/>		<input type="checkbox"/>	0	0	<input type="text" value=""/>	<input type="checkbox"/>	View	+ -

If you want to limit access to only certain properties of any Entity that you are using, you can do so by creating an Entity View. Do this by selecting *Entity View* from the **Action** drop down on the Entity Registry page.

This example illustrates the Entity View Editing page for the Student Enrollment Partial View of the Student Enrollment – Read Only Entity.

Entity View ID: SCC_EVIEW_20140224074906

Entity Name: Student Enrollment - Read Only

*Entity View Name: Student Enrollment Partial View

Entity Description: Student Enrollment Partial View 

Default new items to disabled

Entity Properties			
Property Name	Viewable	Editable	LOV
EMPLID	<input checked="" type="checkbox"/>	<input type="checkbox"/>	<input type="checkbox"/>
ACAD_CAREER	<input checked="" type="checkbox"/>	<input type="checkbox"/>	<input type="checkbox"/>
INSTITUTION	<input checked="" type="checkbox"/>	<input type="checkbox"/>	<input type="checkbox"/>
STRM	<input checked="" type="checkbox"/>	<input type="checkbox"/>	<input type="checkbox"/>
CLASS_NBR	<input checked="" type="checkbox"/>	<input type="checkbox"/>	<input type="checkbox"/>
ACAD_GROUP	<input checked="" type="checkbox"/>	<input type="checkbox"/>	<input type="checkbox"/>
SUBJECT	<input checked="" type="checkbox"/>	<input type="checkbox"/>	<input type="checkbox"/>
CATALOG_NBR	<input checked="" type="checkbox"/>	<input type="checkbox"/>	<input type="checkbox"/>
SESSION_CODE	<input checked="" type="checkbox"/>	<input type="checkbox"/>	<input type="checkbox"/>
CLASS_SECTION	<input checked="" type="checkbox"/>	<input type="checkbox"/>	<input type="checkbox"/>
CRSE_CAREER	<input checked="" type="checkbox"/>	<input type="checkbox"/>	<input type="checkbox"/>
SSR_COMPONENT	<input checked="" type="checkbox"/>	<input type="checkbox"/>	<input type="checkbox"/>
ENRL_CAP	<input type="checkbox"/>	<input type="checkbox"/>	<input type="checkbox"/>
ENRL_TOT	<input type="checkbox"/>	<input type="checkbox"/>	<input type="checkbox"/>
DESCR	<input checked="" type="checkbox"/>	<input type="checkbox"/>	<input type="checkbox"/>
GRADING_BASIS_ENRL	<input checked="" type="checkbox"/>	<input type="checkbox"/>	<input type="checkbox"/>

Provide the Entity View with a name and deselect the property options as required:

- Viewable – The property can be viewed by not changed.
- Editable – The property is changed when saved.

Note: When a new Entity is created from a production record and saved, the Entity Registry is automatically updated. The record fields become available as Entity Properties and existing Yes/No, translate value, and prompt table validations on the RECORD.FIELD definition are made available for prompting without specifically defining a LOV. .

Providing Entity Security Access

Before an Entity can be used in the Rules Engine, you must create the appropriate security setup. This is done using the Entity Profile and Define Rule Category setups.

The Entity Profile controls how the Entity can be accessed by selection of a **Profile Type**. In this example, *Rules Engine*. The Entity Profile also controls whether the Rule is allowed to use the Entity Structure as a starting point for data access in the Rule. This is controlled by the selecting *Base Entity* for each **Entity Name** in the **Entity Profile** to which you want to have access.

This example illustrates the Entity Profile page for Student Car Term Information for the Rules Engine User Interface Example.

Entity Profile ID:	SCC_EPRFL_20140214091401
Entity Profile Name:	<input type="text" value="Student Car Term Information"/>
Profile Description	<input type="text" value="Student data in STDNT_CAR_TERM and child records."/>
*Profile Type	<input type="text" value="Rules Engine"/>
Parent Profile	<input type="text" value=""/>

Entity Name	*Entity View	Base Entity	View	Hierarchy		
Student Enrollment - Read Only	<input type="text" value="Student Enrollment Partial View"/>	<input checked="" type="checkbox"/>	View	Hierarchy		<input type="button" value="+"/> <input type="button" value="-"/>
Student Special GPA	<input type="text" value="Complete"/>	<input checked="" type="checkbox"/>	View	Hierarchy		<input type="button" value="+"/> <input type="button" value="-"/>
Student Term	<input type="text" value="Complete"/>	<input checked="" type="checkbox"/>	View	Hierarchy		<input type="button" value="+"/> <input type="button" value="-"/>

Entity Profile

The next part of Entity Security is setup using Rule Category Definition. Here, you can:

- Create a Category in which to create the Functional Rule. In this example, we want all Student Car Term related Rules created in one Rule Category.
- Grant access to the Entity Profile *Student Car Term Information*.
- Control access to types of Rules. we want to create Functions, Rules and Triggers.
- Control which from Valid Rule Categories business logic can be accessed. We are creating a Rule that uses business logic from other Rule Categories; for example, to perform calculations (category Math) .
- Control who can create Rules for Student Car Term Information; this may be one or more specified users or all users in associated Role.

This example illustrates the Define Categories page for Rules Engine User Interface Integration Example.

Definition

Rule Groups

Security

Cross Reference

Rule Category SCC_RULE_CAT_20140214091448

***Rule Category Name**

***Long Description**

Student Car Term Info

Available To All Categories

Entity Profile Name

Allow Rules

Allow Functions

Allow Triggers

Valid Rule Categories	
Rule Category Name	-
DateTime	-
Debug	-
Math	-
Notification Framework	-
Number	-
String	-
Testing 2	-
Text Messages	-

Build and Test the Functional Rule

With Entity security in place, the Functional Rule to calculate the Special GPA for our business case can be created and tested.

Access the Define Rule page (**Set Up SACR > System Administration > Rules Engine > Rules Engine Manager > Add a New Rule**).

This example illustrates the Define Rule page for Functional Rule for Rules Engine User Interface Example

Define Rule
Version History
Cross Reference

Rule ID: SCC_RULE_ID_20140224065859

Version: 1

Rule Status: Active

*Rule Name: GPA Calculation Rule

*Long Description: GPA Calculation Rule

Rule Category Name: Student Car Term Info

Rule Group Name:

*Rule Usage: Rule

Entity Name: Student Enrollment - Read Only

*Skill Level: Expert

*Logging Level: Trace Logging

Available To Be Used

Action:

Rule Build Status: Build Successful

Status Last Date/Time: 04/03/2014 12:39 PST

Variables

Add a Variable

Criteria

Evaluations and Calculations		Personalize Find	First 1-7 of 7 Last
Active	Statement Description		Details
1 <input checked="" type="checkbox"/>	FOR EACH Student Enrollment - Read Only		+ -
2 <input checked="" type="checkbox"/>	- IF Student Enrollment - Read Only.Include in GPA = Y		+ -
3 <input checked="" type="checkbox"/>	- CALL Function Multiply passing in Student Enrollment - Read Only.Grade Points Per Unit as Value 1, Student Enrollment - Read Only.Units Taken as Value 2 returning Result as TotalGradePoints		+ -
4 <input checked="" type="checkbox"/>	- CALL Function Add passing in TotalGradePoints as Value 1, SumGradePoints as Value 2 returning Result as SumGradePoints		+ -
5 <input checked="" type="checkbox"/>	- CALL Function Add passing in Student Enrollment - Read Only.Units Taken as Value 1, SumUnits as Value 2 returning Result as SumUnits		+ -
6 <input checked="" type="checkbox"/>	IF SumUnits > 0 And SumGradePoints > 0		+ -
7 <input checked="" type="checkbox"/>	- CALL Function DivideRound passing in SumGradePoints as Dividend, SumUnits as Divisor, 2 as Precision returning Quotient as GPA		+ -

This Functional Rule uses the *Student Enrollment – Read Only* Entity, created from production record CLASS_TBL_SE_VW. Assumed is the selection of data using the following Criteria:

- EmplID
- Academic Career
- Institution
- Term
- Subject

Using these Criteria, the Rule returns all Psychology class results for the specified Student ID, Academic Career, Institution and those Academic Terms which are less than or equal to the specified Term. The Criteria need to be passed into this Rule. The needed Values are obtained from Variables designated as required input:

This example illustrates the Variables and Criteria for Define Rule Page for Functional Rule for Rules Engine User Interface Example.

Variables									
Variable Name	Type	List	System	Input	Output	Required	Count	Details	
term	Text	<input type="checkbox"/>	<input type="checkbox"/>	<input checked="" type="checkbox"/>	<input type="checkbox"/>	<input checked="" type="checkbox"/>	1		
Institution	Text	<input type="checkbox"/>	<input type="checkbox"/>	<input checked="" type="checkbox"/>	<input type="checkbox"/>	<input checked="" type="checkbox"/>	1		
Academic Career	Text	<input type="checkbox"/>	<input type="checkbox"/>	<input checked="" type="checkbox"/>	<input type="checkbox"/>	<input checked="" type="checkbox"/>	1		
Emplid	Text	<input type="checkbox"/>	<input type="checkbox"/>	<input checked="" type="checkbox"/>	<input type="checkbox"/>	<input checked="" type="checkbox"/>	1		
GPA	Number	<input type="checkbox"/>	<input type="checkbox"/>	<input type="checkbox"/>	<input checked="" type="checkbox"/>	<input type="checkbox"/>	1		
SumUnits	Number	<input type="checkbox"/>	<input type="checkbox"/>	<input type="checkbox"/>	<input type="checkbox"/>	<input type="checkbox"/>	4		
SumGradePoints	Number	<input type="checkbox"/>	<input type="checkbox"/>	<input type="checkbox"/>	<input type="checkbox"/>	<input type="checkbox"/>	4		
TotalGradePoints	Number	<input type="checkbox"/>	<input type="checkbox"/>	<input type="checkbox"/>	<input type="checkbox"/>	<input type="checkbox"/>	2		

[Add a Variable](#)

Criteria									
Connector	Label	*Operator	Type	Object	Help				
	Empl ID	=	Variable	Emplid					
And	Academic Career	=	Variable	Academic Career					
And	Academic Institution	=	Variable	Institution					
And	Term	<=	Variable	term					
And	Subject Area	=	Text	PSYCH					

Test the Rule (select *Test Rule* from the **Action** drop down on the **Define Rule** page) to ensure it is producing the desired results before proceeding with the next step of generating a Trigger to call the Rule.

Create a Trigger to Call the Functional Rule

Note: This example describes the creation of a Functional Rule and a separate Trigger Rule. However, the separation of business logic and user interface integration, although beneficial, is not strictly necessary. You may create one Rule that performs both functions.

The Trigger is the connection between the user interface and the Functional Rule. The Trigger calls the Functional Rule and passes the information from the user interface to the Functional Rule. Using a Trigger Rule allows you to separate the functional business logic (in this case the GPA calculation) from the logic which dictates when and how that Functional Rule is called. Over time, the Functional Rule may change due to changes in the business case whereas the Trigger Rule controls the interaction with the user interface and the how and when of calling the Functional Rule.

In this example, the Trigger must pass the specified input values (EmplID, Academic Career, Institution, Term, and Subject area) from the user interface to the Functional Rule to successfully select Grade Points and Units from the Student Enrollment Entity and calculate the GPA. A Component Event using PeopleCode (in this example, clicking a button) calls the Trigger which then calls the Functional Rule. This is discussed further in [Generate Boilerplate Code](#).

There are two approaches to creating a Trigger in this example:

- Method A: Pass the needed Variables to the Functional Rule by retrieving and passing the Entity to the Rule.

Considerations for Using Method A

- The Rule Usage is Function or Trigger and has a Base Entity. A Function or Trigger does not have criteria. This means that for this Function to work with the Base Entity attached, it needs Entity information obtained by the calling Rule or the Component Event PeopleCode which calls the Trigger or Function.
 - There is a need to act upon multiple sections of a flexible Entity Structure (for example Entities for Program Enrollment) or Entity Tree.
 - You do not want to lock-down the Input Variables for the Trigger or Function as the data needed may change over time.
 - The execution of the Rule depends on the data in the component, which may not be the same as the data saved in the database. Any changes in the Rule update the component from which the data is retrieved and does not save the data to the database directly.
- Method B: Pass the needed Variables to the Functional Rule using Variables taking their values from the user interface.

Considerations for Using Method B

- The Rule Usage is Trigger so the component needs to pass input Variables to a called Rule.
- The Trigger Rule should not have a base entity defined.
- The Input Variables are not expected to change over time.
- Any data needed by the rules and not passed in using input Variables must be retrieved in a rule called from the trigger rule as the base entity defined by the criteria of a rule.
- If the Rule changes values in the component, the data must be returned to the component as output Variables.

Creating a Trigger Using Method A: Passing an Entity using an Entity

In Method A, the Trigger is defined to work with the Student Special GPA Entity as a Base Entity. The production record for this Base Entity, STDNT_SPCL_GPA, is available on the user interface from which the Trigger is called. The needed information from the Entity can be passed directly to the Trigger. Although the Trigger has no Criteria, the correct Entity is provided to the Trigger.

This example illustrates the Define Rule page for Creating Method A Trigger for Rules Engine User Interface Integration Example.

Define Rule
Version History
Cross Reference

Rule ID: SCC_RULE_ID_20140218093117

Version: 1

Rule Status: Active

*Rule Name: ECA Based Trigger Rule to Calc to Create a Major GPA for Psych Students

*Long Description: ECA Based Trigger Rule to Calc to Create a Major GPA for Psych Students

Rule Category Name: Student Car Term Info

Rule Group Name:

*Rule Usage: Trigger

Entity Name: Student Special GPA

*Skill Level: Expert

*Logging Level: No Message Logging

Available To Be Used

Action: ▼

Rule Build Status: Build Successful

Status Last Date/Time: 04/03/2014 10:04 PST

[View Entity Hierarchy](#)

▸ Variables

Add a Variable

Evaluations and Calculations		Personalize Find First 1-2 of 2 Last
Active	Statement Description	Details
1 <input checked="" type="checkbox"/>	CALL Rule GPA Calculation Psych Major passing in Student Special GPA.Empl ID as Emplid, Student Special GPA.Academic Career as Academic Career, Student Special GPA.Academic Institution as Institution, Student Special GPA.Term as term returning GPA as Calculated GPA	▼ + -
2 <input checked="" type="checkbox"/>	ASSIGN Student Special GPA.GPA = Calculated GPA	▲ + -

This Trigger updates the Student Special GPA Entity with the calculated GPA. This update is displayed on the Special GPA page. This is the Define Call Statement to the GPA Calculation Rule:

This example illustrates the Define Call Statement page for Creating Method A Trigger for Rules Engine User Interface Integration Example

Define Call Statement

Current Context

Entity Name Student Special GPA

▼ Rule Statement Summary

CALL Rule GPA Calculation Psych Major passing in Student Special GPA.Empl ID as Emplid, Student Special GPA.Academic Career as Academic Career, Student Special GPA.Academic Institution as Institution, Student Special GPA.Term as term returning GPA as Calculated GPA

ASSIGN Student Special GPA.GPA = Calculated GPA

Current Statement

Generated Description CALL Rule GPA Calculation Psych Major passing in Student Special GPA.Empl ID as Emplid, Student Special GPA.Academic Career as Academic Career, Student Special GPA.Academic Institution as Institution, Student Special GPA.Term as term returning GPA as Calculated GPA

Override Auto Descriptions

Rule Category Name Student Car Term Info

Rule Name

Inputs Personalize | Find | View All | | | First 1-4 of 4 Last

Arguments	Type	Value		Required
Emplid	= Property	Student Special GPA.Empl ID	<input type="text"/>	<input checked="" type="checkbox"/>
Academic Career	= Property	Student Special GPA.Academic Career	<input type="text"/>	<input checked="" type="checkbox"/>
Institution	= Property	Student Special GPA.Academic Institution	<input type="text"/>	<input checked="" type="checkbox"/>
term	= Property	Student Special GPA.Term	<input type="text"/>	<input checked="" type="checkbox"/>

Outputs Personalize | Find | View All | | | First 1 of 1 Last

Type	Value	Return
Variable	Calculated GPA	<input type="text"/> = GPA

From the call to the Functional GPA rule, it is apparent that the input values needed are passed in using Entity Properties from Student Special GPA Entity.

Creating a Trigger Using Method B: Passing Parameters

In Method B, the Trigger is defined to receive all input values as Variables from the user interface. There is no Base Entity as it is not needed to provide the called GPA Functional Rule with the values it needs.

This example illustrates the Define Rule page for Creating Method B Trigger for Rules Engine User Interface Integration Example

Define Rule
Version History
Cross Reference

Rule ID: SCC_RULE_ID_20140218095142

Version: 1

Rule Status: Active

*Rule Name: Parameter Based Trigger Rule to Calc to Create a Major GPA for Psych Students

*Long Description: Parameter Based Trigger Rule to Calc to Create a Major GPA for Psych Students

Rule Category Name: Student Car Term Info

Rule Group Name:

*Rule Usage: Trigger

Entity Name:

*Skill Level: Expert

*Logging Level: No Message Logging

Available To Be Used

Action: ▼

Rule Build Status: Build Successful

Status Last Date/Time: 24/02/2014 09:25 PST

Variables									
Variable Name	Type	List	System	Input	Output	Required	Count	Details	
Emplid	Text	<input type="checkbox"/>	<input type="checkbox"/>	<input checked="" type="checkbox"/>	<input type="checkbox"/>	<input checked="" type="checkbox"/>	1		
Institution	Text	<input type="checkbox"/>	<input type="checkbox"/>	<input checked="" type="checkbox"/>	<input type="checkbox"/>	<input checked="" type="checkbox"/>	1		
Career	Text	<input type="checkbox"/>	<input type="checkbox"/>	<input checked="" type="checkbox"/>	<input type="checkbox"/>	<input checked="" type="checkbox"/>	1		
Term	Text	<input type="checkbox"/>	<input type="checkbox"/>	<input checked="" type="checkbox"/>	<input type="checkbox"/>	<input checked="" type="checkbox"/>	1		
GPA	Number	<input type="checkbox"/>	<input type="checkbox"/>	<input type="checkbox"/>	<input checked="" type="checkbox"/>	<input type="checkbox"/>	1		

Add a Variable

Evaluations and Calculations			
Active	Statement Description	Details	
1	<input checked="" type="checkbox"/> CALL Rule GPA Calculation Psych Major passing in Emplid as Emplid, Career as Academic Career, Institution as Institution, Term as term returning GPA as GPA		

The calculated GPA is passed into a GPA output Variable. The calling PeopleCode event takes this value and updates the GPA on the Special GPA page. This is the Define Call Statement to the GPA Calculation Rule:

This example illustrates the Define Call Statement page for Creating Method B Trigger for Rules Engine User Interface Integration Example.

Define Call Statement

Current Context

Entity Name

Rule Statement Summary

CALL Rule GPA Calculation Psych Major passing in Emplid as Emplid, Career as Academic Career, Institution as Institution, Term as term returning GPA as GPA

Current Statement

Generated Description CALL Rule GPA Calculation Psych Major passing in Emplid as Emplid, Career as Academic Career, Institution as Institution, Term as term returning GPA as GPA

Override Auto Descriptions

Rule Category Name Student Car Term Info

Rule Name

Inputs Personalize | Find | View All | | First 1-4 of 4 Last

Arguments	=	Type	Value		Required
Emplid	=	Variable	Emplid	<input type="text"/>	<input checked="" type="checkbox"/>
Academic Career	=	Variable	Career	<input type="text"/>	<input checked="" type="checkbox"/>
Institution	=	Variable	Institution	<input type="text"/>	<input checked="" type="checkbox"/>
term	=	Variable	Term	<input type="text"/>	<input checked="" type="checkbox"/>

Outputs Personalize | Find | View All | | First 1 of 1 Last

Type	Value		Return
Variable	GPA	<input type="text"/>	= GPA

Generate Boilerplate Code

With a Trigger created, the boilerplate code can be generated and connected it to a Component Event. In this example, the code calls the Rule to calculate the GPA by clicking a button on the Student Special GPA page. The example shows two new buttons added: **ECA Calc**, representing the Method A approach to the Trigger, and **Parm Calc**, representing the Method B approach to the Trigger. You would likely only use one approach in the customization of your system and would, therefore, only have one button.

This example illustrates the Student Special GPA page after Customization for Rule Engine User Interface Example.

The screenshot shows a web application interface for 'Student Special GPA'. At the top, there are navigation tabs: 'Term Withdrawal', 'Session Withdrawal', 'Academic Standing', 'Student Grade Review', and 'Student Special GPA'. Below the tabs, the user's name 'Pamela Knudsen' and ID 'SFRP0028' are displayed. The interface is organized into sections with search and navigation options:

- Academic Career:** Undergraduate
- Term:** 2013 Spring, PeopleSoft University
- *GPA Type:** PL01 (with a search icon)
- *GPA:** 2.670
- Academic Program:** (with a search icon)
- Academic Plan:** (with a search icon)
- Academic Sub-Plan:** (with a search icon)
- User ID:** PS
- Psych Major GPA:** Entered Online (checkbox), ECA Calc (button), Parm Calc (button)
- Sequence:** 1 (with + and - buttons)
- Action Date:** 05/03/2014

 The interface also includes 'Find | View All' and 'First 1 of 1 Last' navigation links for each section.

The act of clicking a button is the *FieldChange* Event to which the PeopleCode should be added to call the Trigger.

Use the Define Rule Triggers page (Set up SACR > System Administration > Rules Engine > Setup > Define Rule Triggers) to generate boilerplate code and attach that code to the Component Event. The setup created here also acts as an administrative reference to Events and associated Rules. You must minimally specify a PeopleCode **Event**, a **Record**, and a **Field**. The following PeopleCode Events can be selected:

- FieldChange
- FieldEdit
- SavePostChange
- SavePreChange

You may also add a **Component** for reference. Once you have the setup, click the **Generate Code** button to generate the boilerplate PeopleCode. The **Generate Code** option uses information from the Trigger to create a Code example which can be used to call the Trigger from the Component.

Generating Code for the ECA Calc

This example shows a Trigger based on Method A, which contains an Entity and assumes that an Entity is passed to the Trigger. The calculated GPA is updated directly on the Entity.

Access the Define Rule Triggers page (Set Up SACR > System Administration > Rules Engine > Setup > Define Rule Triggers).

This example illustrates the Define Rule Triggers page for Parm Calc for Rules Engine User Interface Integration Example.

Define Rule Triggers

Trigger ID SCC_RTRIG_20140218095510

***Name**

Trigger Description

***Event**

Component

***Record**

***Field**

Rule Category

Rule Name

Here is the example generated code:

```

* ----- About This Example Code ----- */
/* The following Example Code has been created as a starting point from */
/* which to create Rule -UI Integration. In the code you will find that the */
/* rule refers to the Trigger Rule provided on the component as well as its */
/* Arguments. The code below will need to be adjusted before it can be used */
/* to call the (Trigger) Rule. For more information please refer to the */
/* PeopleBooks documentation available for Rules Engine Functionality. */
/* ----- Understanding this Example Code ----- */
/* There are two ways to bring information from a Page or Component into a */
/* Rule: */
/* Method 1: Providing Arguments from Rowset */
/* Provide Local Strings with Values obtained from the appropriate Component */
/* Rowset. This method may be appropriate when calling a Rule or Function */
/* without an Entity which requires a set of input Arguments (Variables) or */
/* for a Rule with a Base Entity which requires a set of parameters which can */
/* be easily obtained and passed into the Rule. */
/* Method 2: Providing Entity using EntityComponentAdapter */
/* Use the Entity Component Adapter to obtain Entity values from the */
/* Component. This method should be used when calling a Function with a Base */
/* Entity which needs to work with that Entity information from the UI. */
* ----- */

import SCC_RULES_ENGINE:Util:RuleFactory;
import SCC_RULES_ENGINE:Util:RuleInterface;
import SCC_COMMON:ENTITY:COMPONENT:EntityComponentAdapterAbstract;
import SCC_COMMON:ENTITY:IEntity;

Local RuleFactory &scRuleFactory = create RuleFactory();
Local RuleInterface &SCC_RTRIG_20140218092909= &scRuleFactory.getRule("SCC_RULE_ID⇒
_20140218093117", true);

Local EntityComponentAdapterAbstract &objECA;
Local array of SCC_COMMON:ENTITY:IEntity &arrIEntity;
Local SCC_COMMON:ENTITY:IEntity &objIEntity;
Local row &row;

```

```

Local number &i;

/* Make sure you are using the proper Entity Component Adapter implementation for y⇒
our Component */
/* Remove the comment markers below to implement the ECA */

/* &objECA=CreateObject("SCC_COMMON:ENTITY:COMPONENT:ECAErrorGrid"); */

/* If the current row is not the row where the entity exists, replace logic below ⇒
to get the correct row in the component */

&row = getrow();

/* Bind the row of data in the comonent to an entity */
/* Be sure to correctly bind the component to the entities used by the rule */

/* &arrIEntity = CreateArrayRept(&objIEntity, 0); */
/* &arrIEntity.Push(&objECA.BindToUIFromRowWithEntityID(&row, "SCC_ENTITY_201402140⇒
90313")); */
/* &SCC_RTRIG_20140218092909.Context = &arrIEntity; */

/* Execute the Rule */

&SCC_RTRIG_20140218092909.Invoke();

```

Generate Code for the Parm Calc

This example shows a Trigger based on Method B, which only contains Input Variables. The calculated GPA is passed back to the Component Event which takes care of updating the GPA value.

Access the Define Rule Triggers page (**Set Up SACR > System Administration > Rules Engine > Setup > Define Rule Triggers**).

This example illustrates the Define Rule Triggers page for Parm Calc for Rules Engine User Interface Integration Example.

Define Rule Triggers

Trigger ID	SCC_RTRIG_20140218095510
*Name	<input type="text" value="Parm Calculation of Major GPA"/>
Trigger Description	<input style="height: 40px;" type="text" value="Parm Calculation of Major GPA"/>
*Event	<input style="border: none; border-bottom: 1px solid #ccc; width: 100%;" type="text" value="FieldChange"/>
Component	<input type="text" value="TERM_HISTORY"/> <input style="float: right;" type="button" value="🔍"/>
*Record	<input type="text" value="SCC_RE_ECA_WRK"/> <input style="float: right;" type="button" value="🔍"/>
*Field	<input type="text" value="SCC_RE_TR_PARM_PB"/> <input style="float: right;" type="button" value="🔍"/>
Rule Category	<input type="text" value="Student Car Term Info"/> <input style="float: right;" type="button" value="🔍"/>
Rule Name	<input type="text" value="Parameter Based Trigger Rule to Calc to Create a Major GPA for Psych Students"/> <input style="float: right;" type="button" value="🔍"/>
<input type="button" value="Generate Code"/>	

Here is the example generated code:

```

/* ----- About This Example Code ----- */
/* The following Example Code has been created as a starting point from */
/* which to create Rule -UI Integration. In the code you will find that the */
/* rule refers to the Trigger Rule provided on the component as well as its */
/* Arguments. The code below will need to be adjusted before it can be used */
/* to call the (Trigger) Rule. For more information please refer to the */
/* PeopleBooks documentation available for Rules Engine Functionality. */
/* ----- Understanding this Example Code ----- */
/* There are two ways to bring information from a Page or Component into a */
/* Rule: */
/* Method 1: Providing Arguments from Rowset */
/* Provide Local Strings with Values obtained from the appropriate Component */
/* Rowset. This method may be appropriate when calling a Rule or Function */
/* without an Entity which requires a set of input Arguments (Variables) or */
/* for a Rule with a Base Entity which requires a set of parameters which can */
/* be easily obtained and passed into the Rule. */
/* Method 2: Providing Entity using EntityComponentAdapter */
/* Use the Entity Component Adapter to obtain Entity values from the */
/* Component. This method should be used when calling a Function with a Base */
/* Entity which needs to work with that Entity information from the UI. */
/* ----- */

import SCC_RULES_ENGINE:Util:RuleFactory;
import SCC_RULES_ENGINE:Util:RuleInterface;
import SCC_COMMON:ENTITY:COMPONENT:EntityComponentAdapterAbstract;
import SCC_COMMON:ENTITY:IEntity;

Local RuleFactory &scRuleFactory = create RuleFactory();
Local RuleInterface &SCC_RTRIG_20140218095510= &scRuleFactory.getRule("SCC_RULE_ID⇒
_20140218095142", true);

Local EntityComponentAdapterAbstract &objECA;
Local array of SCC_COMMON:ENTITY:IEntity &arrIEntity;
Local SCC_COMMON:ENTITY:IEntity &objIEntity;
Local row &row;
Local number &i;

/* Make sure you are using the proper Entity Component Adapter implementation for y⇒
our Component */
/* Remove the comment markers below to implement the ECA */

/* &objECA=CreateObject("SCC_COMMON:ENTITY:COMPONENT:ECAErrorGrid"); */

/* Input Variable Declaration */

Local String &Emplid;
Local String &Institution;
Local String &Career;
Local String &Term;
/* Output Variable Declaration */

Local Number &GPA; /* Maps to Rule Output GPA*/

<*/

/* Assign values from the component to the rule variables */
/* Replace ? with the appropriate values */
/* Required variables must have values passed into the rule */
/* If optional variables do not need values assigned, leave the line commented out ⇒
*/

&Emplid = ?; /* Maps to Rule Input Emplid (Required) */

```

```

&Institution = ?; /* Maps to Rule Input Institution (Required) */
&Career = ?; /* Maps to Rule Input Career (Required) */
&Term = ?; /* Maps to Rule Input Term (Required) */

*>

ObjectSetProperty(&SCC_RTRIG_20140218095510, "V0001" , &Emplid);
ObjectSetProperty(&SCC_RTRIG_20140218095510, "V0003" , &Institution);
ObjectSetProperty(&SCC_RTRIG_20140218095510, "V0005" , &Career);
ObjectSetProperty(&SCC_RTRIG_20140218095510, "V0007" , &Term);/* Execute the Rule *⇒

/

&SCC_RTRIG_20140218095510.Invoke();

/* Assign values from the rule back to the component */
/* Replace ? with appropriate values */

&GPA = ObjectGetProperty(&SCC_RTRIG_20140218095510,"V0013");

```

Understanding the Generated Code

The generated code contains a reference to the *EntityComponentAdapterAbstract* because the Trigger uses a Base Entity. The Entity information must be passed from the Component to the Trigger Rule. The Entity Component Adapter provides the following functionality:

- The *EntityComponentAdapterAbstract* (ECA) is code that maps the data in the component to the Base Entity attached to the Rule.
- If the Base Entity has child Entities, the ECA also maps the Entity children.
- Rather than pulling data from the database, the ECA uses data in the component which may include unsaved changes. This means that the Rule can interact directly with data from the component.
- Changes made to the Entities in the Rule are made to the component data also.

The *ECAErrorGrid* handles any Errors which may be generated by the *EntityComponentAdapter*. This code is required whenever an ECA is used and provides the necessary Error Handling for the Entity Component Adapter. Two error methods exist:

- *ECAErrorGrid* – This code takes care of the error messages coming back from the ECA.
- *ECAErrorPoPup* – Opens a popup page which displays the errors coming back from the ECA.

The *IEntity* array needs to be instantiated as an Array object before you can map the data from a Component to the base Entity of a rule. Errors are generated if the Entity is directly pulled into the code without a push to the array first. In this example, the data is being retrieved and mapped using the *BindToUIFromRowWithEntityID* method.

BindtoUIfromRowWithEntity selects the correct Entity based on the Base Entity ID associated with the Trigger Rule on the Trigger Component. This generated code has already placed the *BaseEntityID* in the *BindtoUIfromRowWithEntity* construct.

Other methods are available through which to retrieve the Entity. They can be added but are not included in the Generated Code:

- *BindToUI*: This grabs the Entity Based on the record on level 0. This would be the first non–Work, non–View encountered in the Component.

Note: For any Component which uses, for example, a record such as INSTALLATION on level 0, this does not work well. Binding at level 0 also implies you may be creating a relatively large Entity Tree. Performance is a consideration.

- *BindToUIfromRow:* This picks the first Entity on that rowset level for example level 1. It assumes that the Component structure and the Entity structure are going to be similar or the same. It “walks” the Component and tries to match what is in the Component with what is in the Entity.

Note: This returns the first Entity found based on the RowSet indicated. Problems may occur when there are multiple RowSets in the Component on that level.

- *BindToUIfromRecord:* This picks the Entity from the user interface based on the record indicated. This record is assumed to be the Production Record from which the Entity is mapped.

Note: Multiple Entities could be mapped to the same Production Record. In this case, the first Entity is returned which may not be the right one.

For more extensive and technical information regarding these Entity Methods, see [Setting Up Entity Registry](#).

Attach Generated Code to the Component Event

The code can be copied from the Generated Code window and pasted into the PeopleCode Event. Open Application Designer and navigate to the PeopleCode Event. In this example, the Event is added to the *FieldChange* event of a *WorkRecord* field:

This example illustrates the Application Designer Example for Rules Engine User Interface Integration Example.

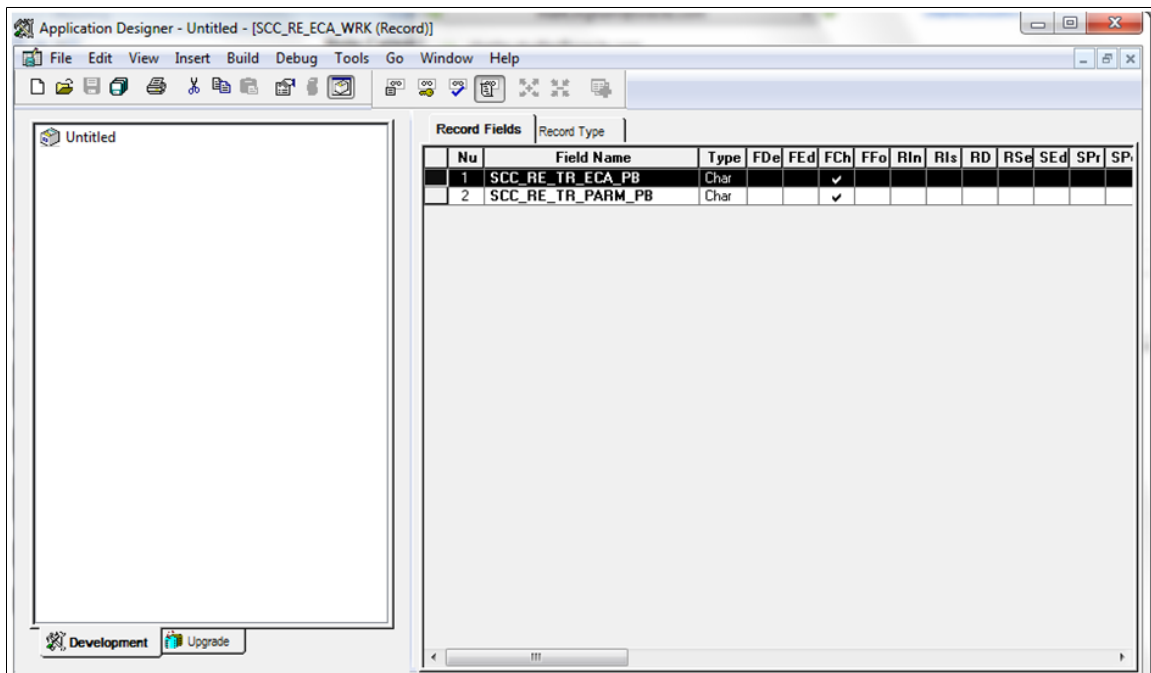

Open the *FieldChange* event and paste the Generated Code for the ECA Trigger into the appropriate event. Adjust the code to retrieve the correct row from which to select the Entity. This is the adjusted PeopleCode on the *FieldChange* Event of field *SCC_RE_TR_ECA_PB* which is the field for the **ECA Calc** button:

```
import SCC_RULES_ENGINE:Util:RuleFactory;
import SCC_RULES_ENGINE:Util:RuleInterface;
import SCC_COMMON:ENTITY:COMPONENT:EntityComponentAdapterAbstract;
import SCC_COMMON:ENTITY:IEntity;

Local SCC_RULES_ENGINE:Util:RuleFactory &scRuleFactory = create SCC_RULES_ENGINE:⇒
Util:RuleFactory();
Local SCC_RULES_ENGINE:Util:RuleInterface &SCC_RTRIG_20140218092909 = &scRuleFact⇒
ory.getRule("SCC_RULE_ID_20140218093117", True);

Local SCC_COMMON:ENTITY:COMPONENT:EntityComponentAdapterAbstract &objECA;
Local array of SCC_COMMON:ENTITY:IEntity &arrIEntity;
Local SCC_COMMON:ENTITY:IEntity &objIEntity;
Local Row &row;
Local number &i;

/* Make sure you are using the proper Entity Component Adapter implementation for ⇒
your Component */
/* Remove the comment markers below to implement the ECA */
&objECA = CreateObject("SCC_COMMON:ENTITY:COMPONENT:ECAErrorGrid");

/* If the current row is not the row where the entity exists, replace logic below ⇒
to get the correct row in the component */
&row = GetRow();

/* Bind the row of data in the component to an entity */
/* Be sure to correctly bind the component to the entities used by the rule */

&arrIEntity = CreateArrayRept(&objIEntity, 0);
&arrIEntity.Push(&objECA.BindToUIFromRowWithEntityID(&row, "SCC_ENTITY_20140214090⇒
313"));
&SCC_RTRIG_20140218092909.Context = &arrIEntity;

&SCC_RTRIG_20140218092909.Invoke();
```

Based on the level 1 row in this example, the Entity can be selected from the current row. References to Variable and Calculated_GPA have been removed from code. As we are using the Rule to update the GPA Entity Property, there is no need to declare or assign a value to the &Calculated_GPA variable in this PeopleCode.

This is the adjusted PeopleCode on the *FieldChange* Event of field *SCC_RE_TR_PARM_PB* which is the field for the **Parm Calc** button:

```
import SCC_RULES_ENGINE:Util:RuleFactory;
import SCC_RULES_ENGINE:Util:RuleInterface;
import SCC_COMMON:ENTITY:COMPONENT:EntityComponentAdapterAbstract;

Local SCC_RULES_ENGINE:Util:RuleFactory &scRuleFactory = create SCC_RULES_ENGINE:⇒
Util:RuleFactory();
Local SCC_RULES_ENGINE:Util:RuleInterface &SCC_RTRIG_20140218095510 = &scRuleFact⇒
ory.getRule("SCC_RULE_ID_20140218095142", True);
```

```

Local SCC_COMMON:ENTITY:COMPONENT:EntityComponentAdapterAbstract &objECA;
Local Row &row;
Local number &i;

/* Make sure you are using the proper Entity Component Adapter implementation for =>
your Component */
/* Remove the comment markers below to implement the ECA */
/* &objECA=CreateObject("SCC_COMMON:ENTITY:COMPONENT:ECAErrorGrid"); */

/* If the current row is not the row where the entity exists, replace logic below=>
to get the correct row in the component */
&row = GetRow();

/* Bind the row of data in the comonent to an entity */
/* Be sure to correctly bind the component to the entities used by the rule */
/* &SCC_RTRIG_20140218095510.Context = CreateArrayRept(&objECA.BindToUIFromRowWith=>
EntityID(&row, "SCC_ENTITY_20140214090313"), 1); */

/* Input Variable Declaration */

Local string &Emplid;
Local string &Institution;
Local string &Career;
Local string &Term;
Local number &Sequence_Number;
Local string &GPA_Type;

/* Output Variable Declaration */

Local number &GPA; /* Maps to Rule Output GPA*/

/* Assign values from the component to the rule variables */
/* Replace ? with the appropriate values */
/* Required variables must have values passed into the rule */
/* Optional variables do not need values assigned, leave the line commented out */

&Emplid = &row.STDNT_SPCL_GPA.EMPLID.Value; /* Maps to Rule Input Emplid (Required=>
) */
&Institution = &row.STDNT_SPCL_GPA.INSTITUTION.Value; /* Maps to Rule Input Instit=>
ution (Required) */
&Career = &row.STDNT_SPCL_GPA.ACAD_CAREER.Value; /* Maps to Rule Input Career (Req=>
uired) */
&Term = &row.STDNT_SPCL_GPA.STRM.Value; /* Maps to Rule Input Term (Required) */
&Sequence_Number = &row.STDNT_SPCL_GPA.SEQ_NUM.Value; /* Maps to Rule Input Sequen=>
ce Number (Required) */
&GPA_Type = &row.STDNT_SPCL_GPA.GPA_TYPE.Value; /* Maps to Rule Input GPA Type (Re=>
quired) */

ObjectSetProperty(&SCC_RTRIG_20140218095510, "V0001", &Emplid);
ObjectSetProperty(&SCC_RTRIG_20140218095510, "V0003", &Institution);
ObjectSetProperty(&SCC_RTRIG_20140218095510, "V0005", &Career);
ObjectSetProperty(&SCC_RTRIG_20140218095510, "V0007", &Term);

&SCC_RTRIG_20140218095510.Invoke();

/* Assign values from the rule back to the component */
/* Replace ? with appropriate values */

&GPA = ObjectGetProperty(&SCC_RTRIG_20140218095510, "V0013");

&row.STDNT_SPCL_GPA.LS_GPA.Value = &GPA;

```

The PeopleCode has been adjusted to provide a *FieldValue* for each Variable to be provided to the Trigger. For example, `&Emplid = &row.STDNT_SPCL_GPA.EMPLID.Value`. In this example, the `&GPA` value retrieved is updated on the component by updating `&row.STDNT_SPCL_GPA.LS_GPA.Value`.

When the Events PeopleCode has been adjusted, the user interface integration can be tested from the Component page.

Library of System-Delivered Rules Engine Objects

This section lists all objects, including Lists of Values, Functions, Rules, Categories, Data Sets, and Entity Profiles that are delivered as System Data for Rules Engine. These System Functions, Rules, Categories and Entity Profiles are delivered as part of Rules Engine feature and have a specific purpose. Those which have a similar purpose or intended usage are grouped together into the same Rules Engine Category. Categories with Rules that access data are delivered with an appropriate entity profile.

Lists of Values

The following Lists of Values can be used in the Rules Engine when referenced by a Rules Engine Variable. The LOV provides Prompt Table functionality when variables are used in Rule criteria or evaluative statements.

LOV ID	Description	LOV Type	LOV Prompt Record	LOV Prompt Field
SCC_LOV_20130225065505	RE Honors	Table	HONOR_AWARD_TBL	AWARD_CODE
SCC_LOV_20131220070639	NFK Notification	Translate Values	PSXLATITEM	SCC_NTFREQ_TYPE
SCC_LOV_20140123052943	NFK Announcement Audience	Translate Values	PSXLATITEM	SCC_NTF_AUDCE
SCC_LOV_20140130120917	Yes/No Prompt	Ad Hoc Values	N/A	Y (Yes) N (No)
SCC_LOV_20140204053537	Rules Engine NFK Templates	Table	SCC_RULE_NTF_VW	SCC_NTFREQ_TMPLTID
SCC_LOV_20140204054709	Rules Engine Notification ID	Table	SCC_NTF_CON_CFG	SCC_NTFREQ_TMPLTID

System Variables

The following System Variables can be used in the Rules Engine when referenced by a Rules Engine Variable. The Rule Category Name is here for reference only as System Variables are considered available for use in any Rule.

System Variable Name	Rule Category Name	Function
Current Date	DateTime	Returns the Current Date in format YYYY-MM-DD.
Current date Time	DateTime	Returns the Current Date in format YYYY-MM-DD HH:MM:SS.
Current Time	DateTime	Returns the Current Time in format HH:MM:SS.
Operator Id	Text	Returns the value for the Current Operator ID.
User Language	Text	Returns the User Language based on User Defaults.

Data Sets

These System Data Sets can be attached to Rules Engine Variables and used as “placeholders” for multiple combined values. Data Sets can be used as lists.

Data Set ID	Name	Long Description	Purpose
SCC_ENTITY_ 20130418162950	Message Catalog Data Set	Message Catalog Data Set	This Data Set can be used in combination with a function to retrieve formatted Message Catalog Text from the system.
SCC_ENTITY_ 20130306064022	AIR Courses	AIR Courses	This data set can be used to as a placeholder for AIR course values
SCC_ENTITY_ 20130528134954	AM Results	AM Weights and Marks used for calculating the Primary Course Result	This data set is used in an primary Course result calculation Rule.
SCC_ENTITY_ 20130711074744	Academic Term	Academic Term	This Data Set is used in function Getterminformation and provides a combined set of Term setup table values.

Data Set ID	Name	Long Description	Purpose
SCC_ENTITY_ 20130711075100	Academic Session Information	Academic Session Information	This data set is used in a function which provides information for a term session.
SCC_ENTITY_ 20140120043511	ActiveResearchSupervisors	Active Research Supervisors	This data set is used in a function which provides information for a Research Supervisor.
SCC_ENTITY_ 20140120083337	ActiveResearchAdminProfiles	Active research administrator profiles	This data set is used in a function which provides information for a Research Affiliation Profile.
SCC_ENTITY_ 20140226150042	EMS Evaluation Information	EMS Evaluation Information	This data set aggregates relevant information about the Evaluation. Used to pass Evaluation data to Rules.
SCC_ENTITY_ 20140226150400	EMS Evaluation Keys	EMS Evaluation Keys	<p>This data set contains evaluation key data (for example, Evaluation Instance, EMPLID, INSTITUTION). Used to pass key data to Rules in a generic fashion (for example, KEY_1, KEY_2, etc).</p> <hr/> <p>Note: EMPLID and INSTITUTION properties have been added to the EMS Evaluation Information Dataset to simplify access to those fields.</p> <hr/>
SCC_ENTITY_ 20140226150717	EMS Evaluation XRef Keys	EMS Evaluation Cross-Reference Keys	This data set contains the Cross-Reference Keys of the Evaluation. Used to pass key data to Rules in a generic fashion (for example, KEY_1, KEY_2, etc).
SCC_ENTITY_ 20140226152106	EMS Rating Component	EMS Rating Component	This data set contains Rating Component fields. Used to pass Rating Component Information to Rules.

Data Set ID	Name	Long Description	Purpose
SCC_ENTITY_ 20140130004615	Text Catalog Data Set	Data set for Text Catalog based messages	This data set can be used in combination with System Function “CreateTextCatalogMessage “. This function retrieves message text from the Text Catalog and populates the data set.
SCC_ENTITY_ 20140224074528	NFK Template Variables	NFK Template Variables	This data set is used by delivered Notification Framework rules to populate required notification variables.
SCC_ENTITY_ 20140224073623	Email Attachments	Email Attachments	This data set is used by Notification Framework Rules to populate Email Attachment values.

System Delivered Categories

Category ID	Name	Long Description	Purpose
SCC_RULE_CAT_ 20130211055805	APT Functions	APT Functions	General purpose functions which can be used by institutions as an example of how to build similar Rules.
SCC_RULE_CAT_ 20120711155409	DateTime	All Generic Date, Time, and DateTime Functions	These functions can be used to perform different Date and DateTime manipulations. For example AddDaystoDate, which adds a specified number of days to date and returns the new date.
SCC_RULE_CAT_ 20120807013921	Debug	Functions to assist in debugging issues	These functions can be called for debugging purposes. The functions put debugging information into a log file.
SCC_RULE_CAT_ 20120802213716	Entity Functions	Functions for dealing with the entity context. Save, Validate, Add, Remove etc.	These functions can be used to Save, Validate, Add, and Remove Entities. These are the functions that are commonly used to insert and/or update data into data tables.

Category ID	Name	Long Description	Purpose
SCC_RULE_CAT_20180625213833	HESA DF Field Derivation Rules	HESA Data Futures Field Derivation Rules	These functions utilize the rules engine for field derivation.
SCC_RULE_CAT_20180618014748	HESA Derivation Steps	HESA Derivation Steps	These functions utilize the rules engine for field derivation.
SCC_RULE_CAT_20120711124111	Math	All Generic Math Functions	These functions can be used to perform math functions. For example Add, Divide, Subtract.
SCC_RULE_CAT_20121203135246	Number	All Generic Number Functions	Currently no number functions have been delivered. This Category is a place holder for future usage.
SCC_RULE_CAT_20120711141824	String	All Generic String Functions	These functions can be used to perform manipulations of string values. For example, Uppercase which converts lowercase text to uppercase text.
SCC_RULE_CAT_20130510122554	Student Records Generic	Student Records Generic Functions	Student Records Generic Functions.
SCC_RULE_CAT_20130121071454	SystemTest	This Category exists to build and test Delivered Developer functions and system variables. The System Test Category consists of self-sustaining mini test suites that can test whether delivered functions work the way they should.	System Test Functions which should be used on test environments for system testing only. These Rules can be on test environments to test basic functionality of the Rules Engine. System Tests include a basic test run of all delivered functions and Rules and includes data delivered as test profile where possible. The test profile data is based on Campus Solutions demo data and may need to be changed for use on your test environment.

Category ID	Name	Long Description	Purpose
SCC_RULE_CAT_ 20130530144109	Text Messages	Text Messages	These functions can be used to populate Message text from either the Message Text Catalog or the Text Catalog. Use functions from this category if you want to retrieve formatted Message text into your Rule.
SCC_RULE_CAT_ 20171115051258	Transcript Fee Functions	Transcript Fee Functions	This can be used by institutions to build rules for assessing transcript fees for requests made through Fluid user interface. A sample rule is included, Transcript Fee Calculation Sample, to demonstrate calculating a discount when a student requests three or more transcripts.

Category for Activities Management

Rule Category for the Activities Management feature.

Category ID	Name	Long Description	Purpose
SCC_RULE_CAT_ 20130425123523	AM Calculation Rules	AM Calculation Rules	These Rules are delivered as part of the Activity Management (AM) feature.

Categories for Program Enrollment

Rule Categories for the Program Enrollment feature.

Category ID	Name	Long Description	Purpose
SCC_RULE_CAT_ 20130219025032	AIR Functions	AIR Functions	General purpose functions that access the academic item registry and can be used by institutions as an example of how to build similar Rules or be leverages as-is into their own Rules

Category ID	Name	Long Description	Purpose
SCC_RULE_CAT_ 20130211055805	APT Functions	APT Functions	General purpose functions that access the academic progress tracker and can be used by institutions as an example of how to build similar Rules or be leveraged as-is into their own Rules

Categories for Research

Rule Categories defined for Research are listed below. They are used for Service Requests components, Research Self Service components, and for online edits in Research administrative components.

Category ID	Name	Long Description	Purpose
SCC_RULE_CAT_ 20140120040657	Research Functions	Research Functions	These functions are used in Rules belonging to the other Research categories.
SCC_RULE_CAT_ 20140116030817	Research Candidates	Research Candidate Rules This includes Consumption and Thesis Rules as the primary keys for these entities are the same as for a candidate.	These Rules are most likely used in the Research Rule Types Component.
SCC_RULE_CAT_ 20130823033945	Research Supervisors	Research Supervisor Rules	These Rules are most likely used in the Research Rule Types Component.
SCC_RULE_CAT_ 20140122021007	Research Topics	Research Topic Rules	These Rules are most likely used in the Research Rule Types Component.
SCC_RULE_CAT_ 20140205035611	Research Assignments	Research Assignment Rules	These Rules are most likely used in the Research Rule Types Component
SCC_RULE_CAT_ 20140128233029	Service Request Functions	Service Request Functions	These Functions would be used in Service Request Category Rules.

Category ID	Name	Long Description	Purpose
SCC_RULE_CAT_ 20131028041439	Service Requests	Research and non research service request Rules	These Rules are used in Rule Trigger definitions for Research Service Requests Components for student and administrators.
SCC_RULE_CAT_ 20140115030355	Research Self Service	Task Rules used to determine the recipient of the notification, when the student performs a Service on the Research Candidate self service page	These Rules are used in the Research Service ID Setup component to determine the Notification Recipient EmplID.

Category for Evaluation Management System (EMS)

Rule Category defined for Evaluation Management System are listed below. They are used for calculating Rating Component Values and Rating Scheme values.

Category ID	Name	Long Description	Purpose
SCC_RULE_CAT_ 20140226144850	Evaluation Management System	Evaluation Management System	Contains Rule Groups and Data Sets required to implement Rules Engine processing for EMS; along with several example Rules.

Entity Profiles

Profile ID	Name	Long Description	Purpose
SCC_EPRFL_ 20130329103345	System Profile AIR & APT	System Profile AIR & APT	Used by Rules Engine Category AIR Functions and APT functions which need to access System Academic Items.
SCC_EPRFL_ 20130306044322	System Data Set	System Data Set	Data Set Profile which is used to deliver System Data Sets.
SCC_EPRFL_ 20130510082227	System Profile AM	System Profile Activity Management	This profile is used by system —delivered Categories for Activity Management.

Profile ID	Name	Long Description	Purpose
SCC_EPRFL_ 20140214091401	Student Car Term Information	Student data in STDNT_CAR_TERM and child records.	This profile is used to illustrate the proof of concept for Rules Engine user interface integration.

Entities

The following Entities are delivered as Rules Engine objects.

Entity ID	Name	Long Description	Purpose
SCC_ENTITY_ 20140218085710	Student Enrollment - Read Only	This entity is used to pull enrollment information for a specific student using CLASS_TBL_SE_VW.	This Entity is used to illustrate the proof of concept for Rules Engine user interface integration.
SCC_ENTITY_ 20140214090313	Student Special GPA	Entity for Student Special GPA in Student Records using STDNT_SPCL_GPA.	This Entity is used to illustrate the Proof of concept for Rules Engine user interface integration.

Rule Groups

Rule Groups provide a template in which Category, Base Entity, Rule Usage and Input and output Variables are predefined. Each Rule created in a Rule Group inherits the same characteristics as the Rule Group. Rule Groups are commonly used to provide a template for User Interface integration or when there is the need to call multiple Rules in the same manner using the same characteristics.

Rule Group ID	Name	Long Description	Purpose
SCC_RULEGR_ID_ 20140226153734	EMS Rating Component Calculation	EMS Rating Component Calculation	All Rules calculating Rating Component values within a Rating Scheme must use this Rule group.
SCC_RULEGR_ID_ 20140226154255	EMS Rating Scheme Calculation	EMS Rating Scheme Calculation	All Rules calculating Rating Scheme Overall Rating values must use this Rule group.

Rule Group ID	Name	Long Description	Purpose
SCC_RULEGR_ID_ 20140224091018	Academic Progress Tracker Item (version 1.1)	Academic Progress Tracker Item Rule Group	This Rule Group provides a uniform set of input and output parameters to all Rules attached. The uniform template enables interaction with the Academic Progress Tracker user interface functionality delivered for Program Enrollment. This Rule group replaces Rule Group “Academic Progress Tracker Item” with ID SCC_RULEGR_ID_ 20130603144145
SCC_RULEGR_ID_ 20130603144145	Academic Progress Tracker Item	Academic Progress Tracker Item Rule Group	This Rule Group has been Inactivated.
SCC_RULEGR_ID_ 20140122023122	Research Assignments	Research Assignments Rule Group	This Rule Group provides a uniform set of input and output parameters to all Research Assignment Rules attached to this Rule Group.
SCC_RULEGR_ID_ 20140116025712	Research Candidate	Research Candidate Rule Group	This Rule Group provides a uniform set of input and output parameters to all Research Candidate Rules attached to this Rule Group.
SCC_RULEGR_ID_ 20140206012041	Research Thesis	Research Thesis Rule Group	This Rule Group provides a uniform set of input and output parameters to all Research Thesis Rules attached to this Rule Group.
SCC_RULEGR_ID_ 20140115031545	Research Self Service Task	Research Self Service Task	This Rule Group provides a uniform set of input and output parameters to all Research Self Service Rules attached to this Rule Group.
SCC_RULEGR_ID_ 20131202050022	Research Supervisor	Research Supervisor	This Rule Group provides a uniform set of input and output parameters to all Research Supervisor Rules attached to this Rule Group.

Rule Group ID	Name	Long Description	Purpose
SCC_RULEGR_ID_20140205033942	Research Topic	Research Topic Rule Group	This Rule Group provides a uniform set of input and output parameters to all Research Topic Rules attached to this Rule Group.
SCC_RULEGR_ID_20131028050041	Service Request	Service Request Rule Group based on Service Request Header entity	
SCC_RULEGR_ID_20160829054915	Overall Calculation with Multiple Scales	Overall Calculation with Multiple Scales	This Rule Group definition is specifically for the creation of rules that can be invoked from components used in AM result calculation when there is a result row for an activity that uses a different result scale from the parent.

System Test Category Functions

Rule ID	Name	Long Description
SCC_RULE_ID_20130218075844	System Test: Simple Evaluative Statement Test (Honors Example)	This system test Rule tests a simple evaluative statement. The basis for this test is a simplified example of an Honors Classification Evaluation Rule (Judicium).
SCC_RULE_ID_20130129055908	Test Math Functions (CALL all Math Functions)	This Function has been created to test through all delivered math functions. Testing includes the following functions in Category "Math": <ul style="list-style-type: none"> • Add • Subtract • Multiply • Divide • Round • Truncate • Mod
SCC_RULE_ID_20130129073324	Test String Functions (CALL all String Functions)	This function Tests through all delivered String Functions.

Rule ID	Name	Long Description
SCC_RULE_ID_20130212065258	System Test: APT Entities: Example Simple Judicium/Honors Rule	<p>This Rule has been created to Test the Rules Engine interacting with System Delivered APT Academic Items. The Rule uses Entities created from System Delivered academic Item Types in APT and tests whether delivered functions and statements interact correctly with these entities.</p> <hr/> <p>Note: This Rule should NOT be run on a production Environment.</p> <hr/> <p>Example Rule:</p> <p>The student has completed a Bachelor's program and thinks that based on his grades that he should be able to request an Honors classification on his degree. To determine whether an Honors classification applies, a number of things need to be evaluated:</p> <ul style="list-style-type: none"> • Total Credit needs to be equal to or above specified amount • Average Mark must be above specified minimum • Lowest Mark must be above specified minimum <p>PREREQUISITE: You need to have three distinct Result Types defined which can be used to enter Results against planned academic item types in the Academic Progress Tracker. These Result Types Names should be added to the following variables as defaults:</p> <ul style="list-style-type: none"> • Variable Result Type: For numeric results stored against the Course academic Item. • Variable Result Type Credits: For numeric credit results stored against the Course academic item. • Variable Honor Result Type: For alphanumeric result which holds the Honors Classification. Use a Text field and not a prompt table.

Rule ID	Name	Long Description
SCC_RULE_ID_20130121071654	Test List Functions (Copy List Via Assign)	<p>The purpose of this System test function is to run through several scenario's in which list functions are tested:</p> <ol style="list-style-type: none"> 1. Assignment of complete list to List (Text). 2. Assignment of complete list to List (Number), 3. Assign value from list to individual Variable in For-Each and evaluate content. 4. Evaluate value from list in For-Each without assigning to Variable first.
SCC_RULE_ID_20130524045353	Test List Functions II (call All list functions)	<p>The purpose of this System test function is to run through several scenarios in which list functions and variables are tested:</p> <ol style="list-style-type: none"> 1. Add to list. 2. Length of list. 3. Sort list. 4. Assign list. 5. Clear list.
SCC_RULE_ID_20130516005432	Test List Functions III (Data Set list)	<p>The purpose of this System test function is to run through several scenarios in which list functions using data set variables are tested:</p> <ol style="list-style-type: none"> 1. Add to list. 2. Length of list. 3. Sort list. 4. Assign list. 5. Clear list.

Rule ID	Name	Long Description
SCC_RULE_ID_20130205094910	Test Date Functions (CALL all DateTime Functions)	<p>Test Date Function (CALL all DateTime Functions)</p> <ul style="list-style-type: none"> • Add Days to Date • Add Months to Date • Retrieve Day from CurrentDate • Retrieve Hour, Minute, Seconds from Time • Add Years to Date • Return Day from Date • Get Current Date • Compare Current Dates • Return Hour from Time • Return Minute from Time • Subtract Days and Months and Years from Date • Retrieve Current Year from Date

AIR Category Functions

Rule ID	Name	Long Description
SCC_RULE_ID_20130219023428	SystemTest: Rule Retrieves AIR and Course Catalog information	SystemTest: Rule Retrieves AIR and Course Catalog Course information based on a specified Academic Item ID, an institution value and an effective date. The information retrieved is passed into a Data Set.
SCC_RULE_ID_20160425080318	AIR description	Get AIR header setup description filtering by Academic Institution, Academic Item ID and Date.

APT Category Functions

Rule ID	Name	Long Description
SCC_RULE_ID_20130212023549	Retrieve Maximum Attempt	<p>Functions Tested:</p> <p>This Rule retrieves the Maximum Attempt row for a specified academic item in the student's Academic Progress Tracker.</p> <p>Input variables needed are the following key fields which are needed to identify the specific Academic Item Attempt row. The information can be retrieved from the Academic Item for which you need to retrieve the maximum attempt:</p> <ul style="list-style-type: none"> • Student ID • Institution • APT Instance • APT Item sequence <p>Example Use: You want to add a new attempt row into to the Academic Progress Tracker for Course Math101 because the student failed the previous attempt, but you need to know what the maximum registered attempt is prior to inserting.</p>
SCC_RULE_ID_20130305043300	SystemTest Function: Assign APT Result Values and Save	<p>This Function can be used to assign a Result Type and a Numeric Result or Alphanumeric Result to an APT Result row in the Student Academic Progress Tracker. The Save Entity Statement is called as part of this function to immediately save the created or updated Row. Attempt Outcome is set to "Conditional" status 20. Include in Calculation Flag is set to Yes.</p>
SCC_RULE_ID_20160524125846	Get Begin Date for APT Curriculum Term.	Get Begin Date for APT Curriculum Term.

APT Category Function Rules

Rule ID	Name	Long Description
SCC_RULE_ID_20130607153122	Check for Sub-Plan Condition: Marketing (Version 3 is Active.)	Checks APT/Program stack for MARKETING Sub-Plan as a condition for selecting an APT option.
SCC_RULE_ID_20130603165523	Precondition for 2155: Expert (Version 3 is Active.)	Student must have satisfied the requirements for 'Economics Year 1 Option List A' (1743), and must have completed MGMT 1001 with at least a grade of C.
SCC_RULE_ID_20140320070913	Check for Sub-Plan Condition: Marketing TEXT CATALOG (Version 2 is Active.)	Checks APT/Program stack for MARKETING Sub-Plan as a condition for selecting an APT option using TEXT CATALOG.

Activity Management Calculation Category Rules

Rule ID	Name	Long Description
SCC_RULE_ID_20130508133749	AM One Time Late Penalty	The AM One Time Late Penalty subtracts the one time penalty from the student's earned mark and inserts a new result row for the student.
SCC_RULE_ID_20130425124530	AM Primary Course Result	AM Primary Course Result.
SCC_RULE_ID_20130521103202	AM Capped Late Penalty	The AM Capped Late Penalty evaluates the earned mark entered. If the earned mark is less than the capped mark parameter, the student's earned mark is retained. If the earned mark is greater than the capped mark, the student receives the capped mark.
SCC_RULE_ID_20130521095817	AM Daily Late Penalty	The AM Daily Late Penalty evaluates the earned mark entered and the number of days the submission is late. The late penalty is inserted on a new result row for the student.

Rule ID	Name	Long Description
SCC_RULE_ID_20130521094603	AM Fixed Penalty Rule	The AM Fixed Late Penalty inserts on a new result row for the student with the value indicated on the fixed late penalty Rule.
SCC_RULE_ID_20130516135412	AM Expires to Zero Penalty	AM Expires to Zero Penalty.
SCC_RULE_ID_20130515141726	AM Weekly Late Penalty	The AM Weekly Late Penalty evaluates the earned mark entered and the number of weeks the submission is late. The late penalty is inserted on a new result row for the student.
SCC_RULE_ID_20130515130457	AM Late Penalty Online Driver Rule	This Rule applies late penalties automatically on the IAM Result pages (Result Roster, including both the administrative and WorkCenter rosters); and IAM Result Details) when a mark is entered with a submission date after the due date for a specific assessment item. The Rule returns a late penalty value and a new row indicating the penalty is inserted on the student's result. Late penalty parameters are setup on either the Activity Registry or the Activity Manager. The late penalty options include: a one-time penalty, a daily penalty, a weekly penalty, a fixed penalty or a capped penalty. Depending on the chosen parameter this Rule calls the associated penalty Rule for the calculation of the penalized mark
SCC_RULE_ID_20140808043722	Get Outcome for a Mark in Result Scale	Get Outcome for a Mark in Result Scale
SCC_RULE_ID_20140807093640	Get Result Scale Detail Setup	Get Result Scale Detail Setup
SCC_RULE_ID_20140807153130	Get Result Scale Option Setup	Get Result Scale Option Setup: get decimals and enable setup for a Result Scale
SCC_RULE_ID_20140521131818	IAM Resit Evaluation	IAM Resit Evaluation
SCC_RULE_ID_20140508022130	IAMGetNextExam	IAMGetNextExam
SCC_RULE_ID_20160824092103	Overall Calculation with Multiple Scales 1: Main Rule	Overall Calculation with Multiple Scales 1: Main Rule

Rule ID	Name	Long Description
SCC_RULE_ID_20160823074658	Overall Calculation with Multiple Scales 2: Mathematical conversion	Overall Calculation with Multiple Scales 2: Mathematical conversion
SCC_RULE_ID_20140812101105	Resit Calculation	Resit Calculation
SCC_RULE_ID_20140806043742	Resit Calculation 1 Get Activity Setup (Calculation Option & Supplemental)	Resit Calculation 1A Get Activity Setup: Get Calculation option and supplemental activity from Resit Options. (ACM_MAIN entity) Calculation Options: Average All Marks or Highest Mark or Most Recent Mark
SCC_RULE_ID_20141028114928	Resit Calculation 2 Get Attempts and Results for Assessment Item	Resit Calculation 2 Get Attempts and Results for Assessment Item
SCC_RULE_ID_20161010085709	Resit Calculation 2 Get Attempts and Results for Category	Resit Calculation 2 Get Attempts and Results for Category
SCC_RULE_ID_20141030022736	Resit Calculation 2 Get Attempts and Results for Exam	Resit Calculation 2 Get Attempts and Results for Exam
SCC_RULE_ID_20141103014315	Resit Evaluation 1A Get Activities by Registry_id for Assessment item Entity	Resit Evaluation 1A Get Activities by Registry_id for Assessment item Entity
SCC_RULE_ID_20160926062235	Resit Evaluation 1A Get Activities by Registry_id for Category	Resit Evaluation 1A Get Activities by Registry_id for Category
SCC_RULE_ID_20141105073654	Resit Evaluation 1A Get Activities by Registry_id for Exam Entity	Resit Evaluation 1A Get Activity Setup for Assessment item Entity: Content Type, Parent Activity Id, Supplemental Activity Id, Resit Period Option, Allowed Attempts
SCC_RULE_ID_20141030052857	Resit Evaluation 1A Get Activity Setup for Assessment item Entity	Resit Evaluation 1A Get Activity Setup for Assessment item Entity: Content Type, Parent Activity Id, Supplemental Activity Id, Resit Period Option, Allowed Attempts
SCC_RULE_ID_20160926074059	Resit Evaluation 1A Get Activity Setup for Category Entity	Resit Evaluation 1A Get Activity Setup for Category item Entity: Content Type, Parent Activity Id, Supplemental Activity Id, Resit Period Option, Allowed Attempts

Rule ID	Name	Long Description
SCC_RULE_ID_20141030100416	Resit Evaluation 1A Get Activity Setup for Exam Entity	Resit Evaluation 1A Get Activity Setup for Exam Entity: Content Type, Parent Activity Id, Supplemental Activity Id, Resit Period Option, Allowed Attempts
SCC_RULE_ID_20140512003813	Resit Evaluation 2 Get Student, Activity Data	Resit Evaluation 2 Get Student, Activity Data
SCC_RULE_ID_20140603155223	Resit Evaluation 2B Get Academic Period Data	Resit Evaluation 2B Get Academic Period Data
SCC_RULE_ID_20141103024942	Resit Evaluation 3 Get Number of PREVIOUS Attempts used for Assessment Item	Resit Evaluation 3 Get Number of PREVIOUS Attempts used for Assessment Item
SCC_RULE_ID_20160926103714	Resit Evaluation 3 Get Number of PREVIOUS Attempts used for Category	Resit Evaluation 3 Get Number of PREVIOUS Attempts used for Category
SCC_RULE_ID_20141105054414	Resit Evaluation 3 Get Number of PREVIOUS Attempts used for Exam	Resit Evaluation 3 Get Number of PREVIOUS Attempts used for Exam
SCC_RULE_ID_20141102022917	Resit Evaluation 3 Get and Evaluate Number of Attempts used for Assessment Item	Resit Evaluation Get and Evaluate Number of Attempts used for Assessment Item entity
SCC_RULE_ID_20160926065724	Resit Evaluation 3 Get and Evaluate Number of Attempts used for Category	Resit Evaluation Get and Evaluate Number of Attempts used for Category entity
SCC_RULE_ID_20141102023250	Resit Evaluation 3 Get and Evaluate Number of Attempts used for Exam	Resit Evaluation Get and Evaluate Number of Attempts used for Exam entity
SCC_RULE_ID_20140618045703	Resit Evaluation 4 Exam Resit Setup Next Period	Resit Evaluation 4 Exam Resit Setup Next Period

Date and Time Category Functions

Functions in the following category can be used to execute business logic using Date and Time values. For example, you can use the functions to convert Strings to Date or to calculate the number of days between two Date values.

Rule ID	Name	Long Description
SCC_RULE_ID_20120711162453	GetCurrentDate	Gets the Current Date from the System.

Rule ID	Name	Long Description
SCC_RULE_ID_20130513065254	DaysToWeeks	This function takes the number of days and convert it to weeks, truncating the calculated value.
SCC_RULE_ID_20130509114010	YearsBetweenDates	This function takes two dates and calculates the number of years, truncating any partial year between the two dates. If the Date From value is later than the Date To field, the result is a negative number.
SCC_RULE_ID_20130508165644	MonthsBetweenDates	This function takes two dates and calculates the number of months truncating any partial month between the two dates. If the Date From value is later than the Date To field, the result is a negative number.
SCC_RULE_ID_20130508164259	WeeksBetweenDates	This function takes two dates and calculates the number of weeks truncating any partial week between the two dates. If the Date From value is later than the Date To field, the result is a negative number.
SCC_RULE_ID_20130508152325	DaysBetweenDates	This function takes two dates and calculates the number of days between the two dates. If the Date From value is later than the Date To field, the result is a negative number.
SCC_RULE_ID_20120711181602	Year	Returns the year value from a date.
SCC_RULE_ID_20120711180936	Month	Returns the month value from a date.
SCC_RULE_ID_20120711180404	Hour	Returns the hour value from a time.
SCC_RULE_ID_20120711171519	SubtractYearsFromDate	Subtract a specific number of years from a date returning the calculated date.
SCC_RULE_ID_20120711171113	SubtractMonthsFromDate	Subtract a specific number of months from a date returning the calculated date.
SCC_RULE_ID_20120711165819	SubtractDaysFromDate	Subtracts a specific number of days from a date returning the calculated date.
SCC_RULE_ID_20120711165049	AddYearsToDate	Add a specific number of years to a date returning the calculated date.

Rule ID	Name	Long Description
SCC_RULE_ID_20120711164350	AddMonthsToDate	Add a specific number of months to a date returning the calculated date.
SCC_RULE_ID_20120711163227	AddDaysToDate	Add a specific number of days to a date returning the calculated date.
SCC_RULE_ID_20120725170243	Second	Returns the second value from a time.
SCC_RULE_ID_20120725165438	Minute	Returns the minute value from a time.
SCC_RULE_ID_20120725163802	Day	Returns the day value from a date
SCC_RULE_ID_20131119192253	StringToDate	Convert a String in the format YYYY-MM-DD to a Date.
SCC_RULE_ID_20131119193042	StringToDateTime	Convert a String to a Date Time value.
SCC_RULE_ID_20131119193911	StringtoTime	Convert a String to a Time value.

Debug Category Functions

Rule ID	Name	Long Description
SCC_RULE_ID_20120807014818	Debug Current Context	Outputs the current context as XML.
SCC_RULE_ID_20120807014738	Debug Context	Outputs the current full context in xml to the debug log in informational logging level.

Entity Category Functions

Rule ID	Name	Long Description
SCC_RULE_ID_20120802214353	SaveAllEntity	Saves all the entities in the Context and their children. It performing all validation and pre-save logic and deleting any entities marked for deletion.
SCC_RULE_ID_20120806111753	ValidateEntity	Runs entity validation, providing the error/warning state.

Rule ID	Name	Long Description
SCC_RULE_ID_20120802213958	SaveEntity	Saves the Current Entity Context and all Children. It performs all validation and pre-save logic and deleting any entities marked for deletion.
SCC_RULE_ID_20120802215742	UnDeleteEntity	Marks the current entity and all it's children for to be undeleted. This simply marks the entity for undeletion, to finish the undelete call save.
SCC_RULE_ID_20120802215730	DeleteEntity	Marks the current entity and all it's children for deletion. This simply marks the entity for deletion, to finish the delete call save.

Math Functions

Rule ID	Name	Long Description
SCC_RULE_ID_20120711125620	Subtract	Subtract one value from another giving a result. Result = Sum(Value 1 - Value 2)
SCC_RULE_ID_20120711124755	Add	Add two values into a results Result = Add(Value 1 + Value 2)
SCC_RULE_ID_20120716174126	SubtractTruncate	Subtract one value from another giving a result truncated to the precision. Result = Sum(Value 1 - Value 2), Precision
SCC_RULE_ID_20120716173508	SubtractRound	Subtract one value from another giving a result rounded to the precision. Result = Round(Value 1 - Value 2), Precision
SCC_RULE_ID_20120716173227	AddTruncate	Add two values together giving a result rounding to the given precision. Result = Round(Value 1 + Value 2)

Rule ID	Name	Long Description
SCC_RULE_ID_20120712162241	AddRound	Add two values together giving a result rounding to the given precision. Result = Round(Value 1 + Value 2)
SCC_RULE_ID_20120712161717	MultiplyTruncate	Multiply two values together giving a result truncating to the given precision. Result = Truncate(Value 1 * Value 2), Precision
SCC_RULE_ID_20120712160911	MultiplyRound	Multiply two values giving a result rounding it to the given precision. Result = Round(Value 1 * Value 2)
SCC_RULE_ID_20121204164104	AverageTruncate	Sum the contents of a list and divide by the number of items in the list, truncating the result by the precision. Ave = Truncate(Sum(List)/Len(List), Precision)
SCC_RULE_ID_20121204163908	AverageRoundDown	Sum the contents of a list and divide by the number of items in the list, rounding down the result by the precision. Ave = RoundDown(Sum(List)/Len(List), Precision)
SCC_RULE_ID_20121204163746	AverageRoundUp	Sum the contents of a list and divide by the number of items in the list, rounding up the result by the precision. Ave = RoundUp(Sum(List)/Len(List), Precision)
SCC_RULE_ID_20121204163355	AverageRound	Sum the contents of a list and divide by the number of items in the list, rounding the result by the precision. Ave = Round(Sum(List)/Len(List), Precision)
SCC_RULE_ID_20121204161244	Average	Sum the contents of a list and divide by the number of items in the list. Ave = Sum(List)/Len(List)

Rule ID	Name	Long Description
SCC_RULE_ID_20120712155703	DivideRoundDown	Divide one value from another giving a result rounding down to the given precision. Result = Divide(Value 1 / Value 2)
SCC_RULE_ID_20120712151532	DivideRoundUp	Divide one value into another giving a result rounding up to the given precision. Result = RoundUp(Value 1 / Value 2)
SCC_RULE_ID_20120712130748	DivideTruncate	Divide one value from another giving a result truncating it to the given precision. Result = Divide(Value 1 / Value 2)
SCC_RULE_ID_20120712125721	DivideRound	Divide one value from another giving a result rounding it to the given precision. Result = Divide(Value 1 / Value 2)
SCC_RULE_ID_20120712121748	RoundDown	Round a numeric value to a specific number of digits. Result = RoundDown(Value, Decimal Places) This function performs rounding where value less than 1.0 would result the value being truncated unless the number is negative, then it is rounded down.
SCC_RULE_ID_20120712114110	RoundUp	Round a numeric value to a specific number of digits. Result = RoundUp(Value, Decimal Places) This function performs rounding where value greater than 0.0 would result the value being rounded to 1, and values at 0.0 would result in the value not being rounded.
SCC_RULE_ID_20120730124647	SubtractRoundUp	Subtract one value from another giving a result rounded up to the precision. Result = RoundDown(Value 1 - Value 2), Precision

Rule ID	Name	Long Description
SCC_RULE_ID_20120730123301	AddRoundDown	Add two values together giving a result rounding down to the given precision. Result = Round(Value 1 + Value 2), Precision
SCC_RULE_ID_20120730121901	MultiplyRoundDown	Multiply two values giving a result rounding down to the given precision. Result = RoundDown(Value 1 * Value 2), Precision
SCC_RULE_ID_20120730121234	MultiplyRoundUp	Multiply two values giving a result rounding up to the given precision. Result = RoundUp(Value 1 * Value 2), Precision
SCC_RULE_ID_20120730124327	SubtractRoundDown	Subtract one value from another giving a result rounded down to the precision. Result = RoundDown(Value 1 - Value 2), Precision
SCC_RULE_ID_20120730123457	AddRoundUp	Add two values together giving a result rounding up to the given precision. Result = RoundUp(Value 1 + Value 2), Precision
SCC_RULE_ID_20120711130546	Multiply	Multiply Value 2 values giving a result. Result = Multiply(Value 1 x Value 2)
SCC_RULE_ID_20120711140717	Mod	This function performs the modulus math function, returning the remainder when dividing one number by another. Result = Modulus(Value 1 / Value 2)
SCC_RULE_ID_20120711134943	Truncate	Truncate the decimal number to a specific precision. Result = Truncate(Value, Precision)

Rule ID	Name	Long Description
SCC_RULE_ID_20120711133255	Round	Round a numeric value to a specific number of digits. Result = Round(Value, Decimal Places) This function performs natural rounding, where value of 0.5 or higher would result the value being rounded to 1, and values lower than 0.5 would result in the value being rounded to 0.
SCC_RULE_ID_20120711131114	Divide	Divide one value from another giving a result. Result = Divide(Value 1 / Value 2)
SCC_RULE_ID_20131119134507	StringToNumber	Convert a string to a number.
SCC_RULE_ID_20131120095322	Max	Retrieves the maximum value from a list of numbers.
SCC_RULE_ID_20131120095954	Min	Retrieves the minimum value from a list of numbers.

String Category Functions

Functions in the following category can be used to execute business logic using string values. For example, you can use the functions to convert DateTime or Numbers to String.

Rule ID	Category Name	Name	Long Description
SCC_RULE_ID_20130419101915	String	Concatenate	Concatenate two strings into a single string.
SCC_RULE_ID_20120711154104	String	UpperCase	Converts a string to upper case.
SCC_RULE_ID_20120711154450	String	LowerCase	Convert a string to lower case.
SCC_RULE_ID_20120711153301	String	Substring	Returns a string from a longer string based on position.
SCC_RULE_ID_20120711152058	String	StringLength	Returns the length of a string.

Rule ID	Category Name	Name	Long Description
SCC_RULE_ID_20131119143620	DateTimeToString	Convert a DateTime value to a String	SCC_RULE_ID_20131119143620
SCC_RULE_ID_20131119140237	DateToString	Convert a Date to a String	SCC_RULE_ID_20131119140237
SCC_RULE_ID_20131119135320	NumberToString	Convert a Number To a String	SCC_RULE_ID_20131119135320
SCC_RULE_ID_20131119185227	TimeToString	Convert a Time value to a String	SCC_RULE_ID_20131119185227

Number Category Functions

Functions in the following category can be used to execute business logic using numeric values. For example, you can use the functions to convert numbers to string or retrieve a maximum number from a number list.

Rule ID	Name	Long Description
SCC_RULE_ID_20131119134507	StringToNumber	Convert a string to a number.
SCC_RULE_ID_20131120095322	Max	Retrieves the maximum value from a list of numbers.
SCC_RULE_ID_20131120095954	Min	Retrieves the minimum value from a list of numbers.

Using Number Category Functions

- Using Min and Max
 - Description: When using delivered statements Min or Max in the Number Category, you can retrieve a minimum or maximum Mark, respectively. A minimum or maximum number can be retrieved from a Variable of Type List which contains all numeric values or from Lists of type Data Set. In this case the minimum or maximum can be retrieved from the property of type number.
 - How to Use: You create a Data Set List which contains a list of courses with accompanying Course Mark. From this list, you want to retrieve the Course with the highest Course Mark. The function Max can be used to retrieve the Maximum result from the list.
- Using StringToNumber

- **Description:** This function converts a numeric string into a true number. Because a numeric value obtained from a property of type string can only be assigned to a Variable of type String, it may be necessary to convert the numeric string to a number before it can be used.
- **How to Use:** For example, a value, 77, is retrieved from a property of type string. You would like to use this value in a calculation. The Math function Add only accepts numeric values or values from a numeric variable as input. In order to use the function Add, the variable which contains value 77 must first be converted into a true number. This can be done with function StringToNumber.

Student Records Generic Category Functions

Rule ID	Name	Long Description
SCC_RULE_ID_20130510122816	GetTermInformation	This Rule returns all information from the TERM_TBL.
SCC_RULE_ID_20130511184959	ValidateStudentAPTProgram	Validate Student Program using the academic program information in the APT.
SCC_RULE_ID_20130511192230	ValidateStudentAPTCareer	Validate Student Career using the academic program information in the APT.
SCC_RULE_ID_20130511190534	ValidateStudentAPTSubplan	Validate Student Subplan using the academic program information in the APT.
SCC_RULE_ID_20130511183011	ValidateStudentAPTPlan	Validate Student Plan using the academic program information in the APT.
SCC_RULE_ID_20130510201105	ValidateStudentSubplan	Validate Student Subplan.
SCC_RULE_ID_20130510195809	ValidateStudentPlan	Validate Student Plan.
SCC_RULE_ID_20130510193556	ValidateStudentProgram	Validate Student Program.
SCC_RULE_ID_20130510180645	ValidateStudentCareer	Validate Student Career.
SCC_RULE_ID_20130510163902	GetSessionInformation	Get information for a term session.

Create Text Message Category Functions

<i>Rule ID</i>	<i>Name</i>	<i>Long Description</i>
SCC_RULE_ID_20130530144525	CreateTextMessage	Create a text message data set and populate it with a message from the message catalog. Up to 9 parameters for the message can be used.
SCC_RULE_ID_20140217002205	CreateTextCatalogMessage	Create a text catalog message data set and populate it with a message from Text Catalog. Up to 4 context keys and 5 parameters for the message can be used.

Using Delivered Text Message Rules

Functions in the Text Message Category allow you to retrieve a formatted Text Message from the System. Text messages can be retrieved from the following functionality:

- Message Text Catalog
- Text Catalog

To use Message Text Catalog Text in your Rule, a message catalog text entry needs to exist.

Access Message Text catalog via **PeopleTools > System Administration > Utilities > Administration > Message Catalog** to view or create Message Catalog entries.

This example illustrates the fields and controls for the Maintain Text Catalog Page for Rules Engine Create Text Message Example.

Maintain Text Catalog

Student Records Sub ID: PE

Text ID: 14731_836 Usage: Error/Warning

Description: Check for Sub-Plan Condition

Effective Date Find | View All First 1 of 1 Last

Effective Date: 01/01/1900 31 + -

Context Keys and Text Find | View All First 1 of 1 Last

Entity Profile ID: + -

Component Name: + -

Panel Name: + -

You must have declared the %1 SubPlan for the %2 Concentration.

[View/Edit as HTML](#)

Sub IDs must be created prior to creating a Text Catalog Text entry.

Access **Set Up Common Objects > Common Definitions > Text Catalog and Notepad > Configure Text Catalog** to set up Configure Text Catalog to add a relevant Sub ID for the relevant application area.

This example illustrates the fields and controls for the Configure Text Catalog Page for Rules Engine Create Text Message Example.

Configure Text Catalog

General
Key 1
Key 2
Key 3
Key 4

Owner ID	Sub ID	Description	Allow Cache	Display Text Id	
HCM Shared Component ▼	AWE	Approval Workflow E	<input checked="" type="checkbox"/>	<input type="checkbox"/>	[-]
HCM Shared Component ▼	HCDL	Delegation	<input checked="" type="checkbox"/>	<input type="checkbox"/>	[-]
HCM Shared Component ▼	PH	Page Help	<input checked="" type="checkbox"/>	<input type="checkbox"/>	[-]
eBenefits ▼			<input checked="" type="checkbox"/>	<input type="checkbox"/>	[-]
ePerformance Management ▼		Performance	<input checked="" type="checkbox"/>	<input type="checkbox"/>	[-]
ePerformance Management ▼	D	Developmental	<input checked="" type="checkbox"/>	<input type="checkbox"/>	[-]
Absence Management ▼		Absence Managemt	<input checked="" type="checkbox"/>	<input type="checkbox"/>	[-]
Human Resources ▼	DRPT		<input checked="" type="checkbox"/>	<input type="checkbox"/>	[-]
Human Resources ▼	I9	I9 Module	<input checked="" type="checkbox"/>	<input type="checkbox"/>	[-]
Human Resources ▼	MNG	Manage Hires	<input checked="" type="checkbox"/>	<input type="checkbox"/>	[-]
Human Resources ▼	NP		<input checked="" type="checkbox"/>	<input type="checkbox"/>	[-]
Human Resources ▼	PSS	Person Search Simj	<input checked="" type="checkbox"/>	<input type="checkbox"/>	[-]
Human Resources ▼	TBH	Template-Based Hi	<input checked="" type="checkbox"/>	<input type="checkbox"/>	[-]
HCM Profile Management ▼	INT	Interest Lists	<input checked="" type="checkbox"/>	<input type="checkbox"/>	[-]
HCM Profile Management ▼	JP	Profiles	<input checked="" type="checkbox"/>	<input type="checkbox"/>	[-]
HCM Profile Management ▼	SRCH	Verity Search	<input checked="" type="checkbox"/>	<input type="checkbox"/>	[-]
RS Applicant Manager ▼		RS Candidate Facin	<input checked="" type="checkbox"/>	<input type="checkbox"/>	[-]
RS Common Components ▼		RS Admin Keys	<input checked="" type="checkbox"/>	<input type="checkbox"/>	[-]
TL Scheduling ▼			<input checked="" type="checkbox"/>	<input type="checkbox"/>	[-]
Campus Community ▼	ER	Entity Regisrty	<input checked="" type="checkbox"/>	<input type="checkbox"/>	[-]
Student Records ▼	PE	Program Enrollmen	<input checked="" type="checkbox"/>	<input type="checkbox"/>	[-]

+

This is an example of a call to a Function that retrieves the Text Catalog:

This example illustrates the fields and controls for an example of a Function Call to the CreateTextCatalogMessage rule that uses the Text Catalog.

Current Statement

Generated Description CALL Function CreateTextCatalogMessage passing in SSR as Application ID, PE as Sub ID, 14731_700 as Text ID, MARKETING as Parameter 1, Marketing as Parameter 2, as Parameter 3, as Parameter 4, as Parameter 5, as Key Value 1, as Key Value 2, as Key Value 3, as Key Value 4, as Severity returning Text Catalog Data Set as bt_catalog_MESSAGE

Override Auto Descriptions

Rule Category Name Text Messages

Rule Name CreateTextCatalogMessage

Inputs

Arguments	Type	Value	Required
Application ID	= Text	SSR	<input checked="" type="checkbox"/>
Sub ID	= Text	PE	<input checked="" type="checkbox"/>
Text ID	= Text	14731_700	<input checked="" type="checkbox"/>
Parameter 1	= Text	MARKETING	<input type="checkbox"/>
Parameter 2	= Text	Marketing	<input type="checkbox"/>
Parameter 3	= Text		<input type="checkbox"/>
Parameter 4	= Text		<input type="checkbox"/>
Parameter 5	= Text		<input type="checkbox"/>
Key Value 1	= Text		<input type="checkbox"/>
Key Value 2	= Text		<input type="checkbox"/>

Outputs

Type	Value	Return
Variable	bt_catalog_MESSAGE	= Text Catalog Data Set

To retrieve a formatted text message supply the appropriate input defined as arguments:

Argument Name	Details	How does this relate to setup
Application ID	A Text value. This argument is required.	This corresponds to Application ID in the Maintain Text Catalog set up from which a Text Message is retrieved.
Sub ID	A Text Value. This argument is required.	This corresponds to Sub ID in the Maintain Text Catalog set up from which a Text Message is retrieved.
Text ID	A Text Value. This argument is required.	This corresponds to the unique Text ID in the Maintain Text Catalog set up from which a Text Message is retrieved.
Parameter 1 through 5	Text. Optional	This value replaces Message Text variables %1 through %5 with a value. Provide a Variable, Text Value or (data set) property.

Argument Name	Details	How does this relate to setup
Key Value 1 through 4	Text, Optional	Context Keys can be used for granular selection of Context Catalog Text's added to a Text Catalog ID.
Text Catalog Data Set	Required	Provide a Data Set Variable which references system Data Set "Text Catalog Data Set".

Evaluation Management System (EMS) Category Rules

Rules in the following category are delivered as examples to demonstrate the use of an automated rating scheme as part of an Evaluation. All Rules created which interact with the Evaluation records should be built under this category to take advantage of the delivered data sets and Rule group which support Rules processing for Evaluations.

Rule ID	Name	Long Description
SCC_RULE_ID_20140306170755	Rating Scheme Calculation Example	This Rule can be used at the Evaluation Rating Scheme level as an alternate calculation of the Overall Rating value for the scheme. This example returns the sum of the component rating values.
SCC_RULE_ID_20140303114951	Test Score Rule Example	This Rule returns a rating value for the rating component based upon the highest score value in a comparison of ACT scores and SAT I scores. Calls a number of Rules to get the scores from the test score records, evaluate those results against a rating scale to obtain the rating value to populate the rating component.
SCC_RULE_ID_20140306173039	Academic Qualification Example	This Rule returns a rating value to the rating component based upon education data fields of percentile rank and converted GPA contained in External Academic Summary. Calls a number of other Rules which get the GPA and percentile values, evaluate those results against a rating scale to obtain the rating value to populate the rating component.
SCC_RULE_ID_20140306172622	Courses Completed Requirement Example	This Rule returns a rating value to the rating component based on a count of completed subjects in External Academic Subjects.

Rule ID	Name	Long Description
SCC_RULE_ID_20140304120320	Get ACT Rating Value Example	Returns the rating value for an ACT score.
SCC_RULE_ID_20140306141320	Get Course Count Rating Example	Gets the rating value for Course Count.
SCC_RULE_ID_20140306143945	Get Course Requirement Rating Example	Returns a rating value based on the number of Courses Completed for all Academic History entries that have External Academic Data rows where External Career = HS and Transcript Type = OFF.
SCC_RULE_ID_20140306161125	Get Courses Completed Count Example	Returns a count of completed courses in External Academic Subjects.
SCC_RULE_ID_20140304123947	Get GPA Rating Example	Returns the rating value for a GPA.
SCC_RULE_ID_20140304162158	Get High School Rating Example	Gets the highest rating value of the Converted GPA and Percentile values and passes to Get High School Rating Driver Rule.
SCC_RULE_ID_20140304170413	Get High School Rating Driver Example	Loops through External Academic Data where External Career = HS for an EMPLID and calls Get High School Rating. Returns the highest High School Rating.
SCC_RULE_ID_20140226160705	Get Highest Test Component Score Example	Returns the highest score for the specified EMPLID, TEST_ID, and TEST_COMPONENT.
SCC_RULE_ID_20140304155504	Get Percentile Rating Example	Returns the rating value for a Percentile Rank.
SCC_RULE_ID_20140304121526	Get SAT I Rating Value Example	Returns a rating value for a SAT I Test Score Total.
SCC_RULE_ID_20140226155857	Get Test Component Scores Example	Returns a list of test component scores for the specified EMPLID, TEST_ID and TEST_COMPONENT.

Research Self Service Task Category Rule

The Rule in this category can be used to Return Notification recipient EMPLID for the Research Candidate in context.

Rule ID	Name	Description
SCC_RULE_ID_20140115033240	Research Std SS task notification recipient	Returns the Active Primary Supervisor ID for the Research/Project Candidate in context.

Service Request Functions Category Rules

Rules and Functions in this category can be used to Return information relating to the Research Service Request in context.

Rule ID	Name	Description
SCC_RULE_ID_20131017052110	Service Request Assignment: getSetup	Returns the Advisor Type, Default EMPLID from the Service Request Assignment Setup for the Institution, service request type and subtype.
SCC_RULE_ID_20131018043858	Service Request Assignment: getTYPESetup	Returns the Service Request Category for the given Service Request Type.
SCC_RULE_ID_20131017060725	Service Request Assignment: getCATSetup	Returns the “SR Assigned to” EMPLID from the Service Request Category Setup for the Service Request in context.
SCC_RULE_ID_20131017014805	Service Request Assignment:Research Advisor	Returns the “Advisor” EMPLID from the Student Advisor History for the Service Request in context.
SCC_RULE_ID_20131016061345	Service Request Assignment:Research Supervisor	Derive the Primary Research supervisor for the Service Request in context.
SCC_RULE_ID_20131017014916	Default Service Request Assignment Logic	Returns EMPLID to which the service request will be assigned.

Service Requests Category Rule

The Rules in this category can be used to derive AssignedTO EMPLID for the Research Service Request in context.

Rule ID	Name	Description
SCC_RULE_ID_20140205065106	Service Request AssignedTo : Rule Trigger	This Trigger Rule is called from Rule Trigger definition to derive Service Request AssignedTo in Research Service Requests Student and admin components.

Research Functions Category Rules

Functions in this category can be used to return Active Supervisors and Admin Affiliation Profiles for the Research Service Request in context.

Rule ID	Name	Description
SCC_RULE_ID_20140206024642	Match Topic Title	Matches Title of active Research Topics of given status with the passed Thesis Title parameter. If topic records exist but title doesn't match, then it returns false, else true.
SCC_RULE_ID_20140120052534	Get Active Research Supervisors	Returns the List of active Research Supervisors for the candidate in context.
SCC_RULE_ID_20140120083423	Get Active Admin Profiles	Returns the List of active Research/Project Admin Affiliation Profiles for the candidate in context.

Research Candidates Category Rules

Rules and Functions in this category can be used to return true/false with a list of messages for the Research Candidate in context. These Rules can be used in the Research Rule Types and Execution Event Context components to display the warning messages in the Research Components.

Rule ID	Name	Description
SCC_RULE_ID_20140116235214	Candidate has active Supervisors	Checks if the candidate has active Supervisors. Returns message if not found.
SCC_RULE_ID_20140120084414	Candidate has non available research Supervisors	Checks if Candidate has any Research Supervisors who are not available anymore. If so returns a message.
SCC_RULE_ID_20140121001258	Candidate has non available Project Supervisors	Checks if Candidate Project has any Project Supervisors who are not available anymore. If so returns a message.
SCC_RULE_ID_20140206012715	Compare Thesis Title	Checks if Candidate Thesis Title matches any of the active Approved Topic Titles. If Not, returns a message.

Notification Framework Category Rules

Using delivered functions, you can create a notification in a specific channel. The Notification Rule can be called by other Rules. This makes it possible to send notifications conditionally based on an evaluation or calculation result for a specific selection of students in your database.

Rule ID	Name	Description
SCC_RULE_ID_20140203094013	Announcement Notification	An Announcement Notification can be created for the channel Alert. (for example, an informational message that appears on a portal homepage). Note that an Announcement is an Alert created not for one Recipient but for all recipients.
SCC_RULE_ID_20131219093336	Email Notification	A notification can be created for the Email Channel. Use this Notification to send Emails to one or more persons using the TO, CC and BCC email options. Attachments can be included.
SCC_RULE_ID_20140211033859	Push Notification	A notification can be created for the channel Push. Push Notifications are created for mobile apps on iOS/Android.
SCC_RULE_ID_20140211080755	SMS Notification	A notification can be created for the channel SMS.
SCC_RULE_ID_20140211033801	Worklist Notification	A notification can be created for the channel Worklist. This Rule creates a Worklist Item on a Portal Homepage with actionable hyperlink.
SCC_RULE_ID_20140211092724	Alert Notification	A notification can be created for the channel Alert.(for example, Informational message that appears on a portal homepage).

Using Notification Framework Rules

To use the Notification Rules, you must complete the Notification Framework setup. To facilitate usage of Notification Rules, Oracle delivers a Notification Consumer Setup.

Rules Engine Notification Consumer ID

The Consumer ID controls which consumers can send Notifications through the Notification Framework. Oracle delivers a Notification Consumer ID for Rules Engine.

UID	Name	Long Description	Purpose
SCC_NTF_CON_20131112191211	Rules Engine	Notification Consumer for Rules Engine. Attached Templates are delivered as examples and can be used to send Rules Engine Notifications.	The following Consumer ID is used to send Rules Engine Notifications. The Consumer ID is linked to active Notification Rules.

Navigate to **Set Up SACR > System Administration > Utilities > Notifications > Notification Consumer Setup.**

This example illustrates the fields and controls for the Notification Consumer Setup Page for Rules Engine Example.

Notification Consumer Setup

Notification Consumer ID: SCC_NTF_CON_20131112191211

*Consumer Name:

Status:

Description:

Notification Templates						Personalize Find View All First 1-5 of 5 Last
	Template Name	Notification Type	Template Status	Application Class		
1	<input type="text" value="Rules Engine Email"/>	Email	Active	SCC_COMMON:NOTIFICATION:I	View Template Name	+ -
2	<input type="text" value="Rules Engine Alert"/>	Alert	Active	SCC_COMMON:NOTIFICATION:I	View Template Name	+ -
3	<input type="text" value="Rules Engine Workflow"/>	Worklist	Active	SCC_COMMON:NOTIFICATION:I	View Template Name	+ -
4	<input type="text" value="Rules Engine Push"/>	Push	Active	SCC_COMMON:NOTIFICATION:I	View Template Name	+ -
5	<input type="text" value="Rules Engine SMS"/>	SMS	Active	SCC_COMMON:NOTIFICATION:I	View Template Name	+ -

The Rules Engine can create and send a Notification in these Channels:

- Email
- Alert
- Workflow
- Push
- SMS

There is a corresponding Notification Setup Template for each channel supported by Rules Engine. The associated application class is a dummy class which has been added as a placeholder. The application class does not contain any logic or functionality but must be added as a default application class for any Institution Template added to Notification Consumer Setup for Rules Engine.

Rules Engine Templates

Templates allow you to set up the recipients for the Notifications. A template has been created for each notification supported by Rules Engine. Oracle delivers these Template ID's for Rules Engine:

<i>Template ID</i>	<i>Name</i>	<i>Long Description</i>	<i>Associated Generic Template</i>
SCC_NTF_TMP_20131112191858	Rules Engine Email	Example Template for sending Rules Engine Notifications of type Email	SCC_RULES_ENGINE_EMAIL
SCC_NTF_TMP_20140123062439	Rules Engine Alert	Example Template for sending Rules Engine Notifications of type Alert as well as Announcements	SCC_RULES_ENGINE_ALERT
SCC_NTF_TMP_20140123070158	Rules Engine Workflow	Example Template for sending Rules Engine Notifications of type Workflow	SCC_RULES_ENGINE_WL
SCC_NTF_TMP_20140204030502	Rules Engine Push	Example Template for sending Rules Engine Notifications of type Push	SCC_RULES_ENGINE_PUSH
SCC_NTF_TMP_20140204030858	Rules Engine SMS	Example Template for sending Rules Engine Notifications of type SMS	SCC_RULES_ENGINE_SMS

Click on View Template Name on the Notification Consumer Setup Page or navigate to **Set Up SACR > System Administration > Utilities > Notifications > Notification Setup** to view delivered Notification IDs. This screen shot shows the delivered Rules Engine Template for channel Email. You can adjust the Template to suit your needs; however, Oracle recommends that you create your own Templates.

This example illustrates the fields and controls for the Notification Setup Page for Rules Engine Example.

Notification Setup

Notification Template ID: SCC_NTF_TMP_20131112191858

***Template Name:**

Status:

Description:

***NotificationType:** **Override Notification Preferences**

Email Content Type:

***Notification Criticality:**

***Generic Template:**

Recipients Configuration ?

To

Preferred Email Address
 Custom Logic
 Static Address

Cc

None
 Preferred Email Address
 Custom Logic
 Static Address

Bcc

None
 Preferred Email Address
 Custom Logic
 Static Address

Rules Engine Generic Templates

Each Template ID is associated with a Generic template. The Generic Template controls the Message Text and the Variables to include in the Notification Message. The attached Generic Template can be adjusted to suit Institution requirements or can be replaced by an institution specific Template. Access PeopleTools, Workflow, Notifications, Generic Templates to adjust Generic Templates or use the prompt option on the Template ID setup to access. Oracle delivers the following Generic Templates for Rules Engine:

Template ID	Name	Template Variables
SCC_RULES_ENGINE_EMAIL	Rules Engine Email	%1 Subject %2 Message Body
SCC_RULES_ENGINE_ALERT	Rules Engine Alert	%1 Subject %2 Message Body
SCC_RULES_ENGINE_WL	Rules Engine Workflow	%1 Subject %2 Message Body
SCC_RULES_ENGINE_PUSH	Rules Engine Push	%1 Subject %2 Message Body
SCC_RULES_ENGINE_SMS	Rules Engine SMS	%1 Subject %2 Message Body

This example illustrates the fields and controls for the Generic Template Definition Example for Rules Engine.

Generic Template Definition

Blackberry Email Responses

Template: SCC_RULES_ENGINE_EMAIL

***Description:**

Instructional Text:

Type names or email addresses in the To, CC, or BCC fields, using a semi-colon as a separator. Click LOOKUP RECIPIENT to search for a name. Click DELIVERY OPTIONS to view or change the method of

Priority:

***Sender:** **Email ID:**

Subject:

Message Text:

<p>%2</p>

Below is the list of available variables for this template.
You can use template variables within your subject or message text.
The following variables can also be used:
%Date, %DateTime, %Time, %ServerTimeZone, %EmailAddress, %NotificationPriority, %NotificationToList, %NotificationCCList

Template Variables			
*Value	*Description		
%1	Subject	+	-
%2	Message Body	+	-

Understanding the Interaction between the Notification Framework and the Notification Rule

The Rules delivered in the Notification Framework Category can be used to send a Notification in one or more notification channels. The following Rules are delivered:

- Email Notification
- SMS Notification
- Alert Notification
- Announcement Notification
- Worklist Notification

Access the Rules Engine Manager to access Notification Rules (**Set Up SACR > System Administration > Rules Engine > Rules Engine Manager**, select Search for a Rule. Use the prompt to select Rule Category Name *Notification Framework*. Click Search and select the desired Notification Rule (Email, SMS, Alert, Push, or Worklist).

This example illustrates the fields and controls for the Define Rule Page for Rules Engine Notification Example.

Define Rule
Version History
Cross Reference

System Data

Rule ID: SCC_RULE_ID_20131219093336 Action:

Version: 1

Rule Status: Active

Rule Name: Email Notification

Long Description:

A notification can be created for the Email Channel. Use this Notification to send Emails to one or more persons using the TO, CC and BCC email options. Attachments can be included.

Rule Category Name: Notification Framework

Rule Group Name:

Rule Usage: Rule

Entity Name:

Skill Level: Developer

Rule Application Class: SCC_RULE_LIBRARY_GENERIC:Notifications:EmailNotification_V1

Available To Be Used

Variables									
Internal Argument Name	Variable Name	Type	List	System	Input	Output	Required	Details	
ConsumerID	Consumer ID	Text	<input type="checkbox"/>	<input type="checkbox"/>	<input checked="" type="checkbox"/>	<input type="checkbox"/>	<input checked="" type="checkbox"/>		<input type="text"/>
TemplateID	Template ID	Text	<input type="checkbox"/>	<input type="checkbox"/>	<input checked="" type="checkbox"/>	<input type="checkbox"/>	<input checked="" type="checkbox"/>		<input type="text"/>
arrTOEmplids	List of To Emplids	Text	<input checked="" type="checkbox"/>	<input type="checkbox"/>	<input checked="" type="checkbox"/>	<input type="checkbox"/>	<input checked="" type="checkbox"/>		<input type="text"/>
arrCCEmplids	List of CC Emplids	Text	<input checked="" type="checkbox"/>	<input type="checkbox"/>	<input checked="" type="checkbox"/>	<input type="checkbox"/>	<input type="checkbox"/>		<input type="text"/>
arrBCCEmplids	List of BCC Emplids	Text	<input checked="" type="checkbox"/>	<input type="checkbox"/>	<input checked="" type="checkbox"/>	<input type="checkbox"/>	<input type="checkbox"/>		<input type="text"/>
arrDSTemplateVariables	List of NFK Template Variables	Data Set	<input checked="" type="checkbox"/>	<input type="checkbox"/>	<input checked="" type="checkbox"/>	<input type="checkbox"/>	<input type="checkbox"/>		<input type="text"/>
arrDSEmailAttachments	List of Email Attachments	Data Set	<input checked="" type="checkbox"/>	<input type="checkbox"/>	<input checked="" type="checkbox"/>	<input type="checkbox"/>	<input type="checkbox"/>		<input type="text"/>
NotificationStatusCode	Notification Status Code	Text	<input type="checkbox"/>	<input type="checkbox"/>	<input type="checkbox"/>	<input checked="" type="checkbox"/>	<input type="checkbox"/>		<input type="text"/>
NotificationStatus	Notification Status	Text	<input type="checkbox"/>	<input type="checkbox"/>	<input type="checkbox"/>	<input checked="" type="checkbox"/>	<input type="checkbox"/>		<input type="text"/>
arrErrorMessages	List of Error Messages	Text	<input checked="" type="checkbox"/>	<input type="checkbox"/>	<input type="checkbox"/>	<input checked="" type="checkbox"/>	<input type="checkbox"/>		<input type="text"/>

When the Notification Rule completes, you should be able to review the Notification in the Notification Framework Admin Page *and* view the notification as output by channel (For example, by verifying that an email has been sent). The recipient can review the Notification via Self Service Notifications.

This table describes each variable and its relationship to the Notification Framework Rule functionality:

Variable Name	Details	How does this relate to Notification Framework setup
Emplid List of To Emplids List of CC Emplids List of BCC Emplids	EMPLID to which the Notification is to be sent. Valid for Notification Channels: ALERT, WORKFLOW, EMAIL, PUSH	<p>The Rule uses the settings on the Notification Template to determine where the notification needs to be sent. A recipient is selected according to the settings which have been administered on the Notification Template. For example, Preferred Email address.</p> <p>For Template SCC_RULES_ENGINE_EMAIL this could be a Preferred Email Address, Custom Logic or a Static address.</p> <p>For Notification channel email a notification can be sent to the following recipients:</p> <ul style="list-style-type: none"> • TO • CC • BCC • Other channels support only one recipient <p>In the Notification Email Rule, it is required to provide an Emplid for the TO recipient. Emplid can be provided for recipients CC and BCC.</p> <p>Multiple recipients can be added for the Email channel.</p>
List of Email Attachments Attachment File Name	File Name to be added to email Valid for Notification Channels: EMAIL	<p>The Notification Rule for channel EMAIL allows you to specify an attachment file Path and File Name. The File name is retrieved from the specified file Path, added to the email sent by the Notification Framework, and sent to the listed Recipients.</p> <hr/> <p>Note: Although not required, when an Attachment file name is specified, the Attachment file path should also be specified and vice versa.</p> <hr/> <p>Multiple attachments can be added</p>

Variable Name	Details	How does this relate to Notification Framework setup
List of Email Attachments Attachment File Path	File Location of the File which is to be added to email Valid for Notification Channels: EMAIL	Refer to Attachment File Name.
Consumer ID	The Notification Consumer ID of the consumer sending the notification. Valid for all Notification Channels.	A LOV prompt is attached to this LOV so that only the Consumer ID Rules Engine can be selected.
Template ID	The Notification Template ID of the template to be used for the Notification. The Notification Template holds information about the notification type and recipients configuration. Valid for all Notification Channels	A LOV Prompt is to this LOV so that only templates relevant for Consumer ID Rules Engine can be selected. The Notification Template controls the Notification Type and Recipient information.
Template Variables	The names of the Template Variables which are set up on the Notification Template as Variables. The Variable Names and Order should match those of the Template (for example %1). Valid for all Notification Channels.	Template Variables can be added to a List Variable. The Template Variables added to the list should correspond to the Variables which have been created on the Generic Notification Template for this specific Notification. The Variables are used to provide the Email with appropriate text for the Message Subject as well as body.
Template Variable Values	The values to be placed into the Variables which have been defined on the Notification Template. Valid for all Notification Channels.	Variables can be added to this List Variable. The Variables are used to populate the Template Variables as they have been created on the Generic Template. It is possible to add hard-coded text as well as Variables to the Template Variable Values list. The order in which the text and variables are added to the list must match the order of the Template Variables list.

Variable Name	Details	How does this relate to Notification Framework setup
Notification Type Created	<p>If the Notification has been generated successfully, the Notification type is filled.</p> <p>Valid for all Notification Channels.</p>	<p>Possible Values:</p> <ul style="list-style-type: none"> • ALT: An Alert has been sent to the Notification Framework. • EML: An email has been sent to the Notification Framework. • PSH: A Push notification has been sent to the Notification Framework. • SMS: A SMS has been successfully sent to the Notification Framework. • WKL: A Worklist has been successfully sent to the Notification framework. <hr/> <p>Note: The Rule itself does not create the Notification but sends a Notification to the Notification Framework which in turn handles the actual Notification. The Rule can only indicate whether the Notification was handed to the Notification Framework using the appropriate channel. The Rule cannot determine whether the notification (for example email) was sent successfully.</p>
Error Message	<p>The Notification was not generated successfully Valid for all Notification Channels.</p>	<p>If the notification has not been generated successfully the following output field contains an error message. Again this only concerns an error which may have occurred passing values to the Notification Framework.</p>
Component	<p>Component Name</p> <p>Valid for Notification Channels: WORK LIST</p>	<p>The component to which the Notification applies. For a notification referring to campus community, Personal Information (Student), Add/Update Person, Biographical Details the value would be : SCC_BIO_DEMO.</p>

Variable Name	Details	How does this relate to Notification Framework setup
Menu Name	Menu Name Valid for Notification Channels: WORK LIST	The Menu name to which the Notification applies. For a notification referring to campus community, Personal Information (Student), Add/Update Person, Biographical Details the value would be : CC_BIO_DEMO_DATA_STDNT.
Menu Bar Name	Menu Bar Name Valid for Notification Channels: WORK LIST	The Menu Bar name to which the Notification applies. For a notification referring to campus community, Personal Information (Student), Add/Update Person, Biographical Details the value would be : USE.
Menu Item Name	Menu Item Name Valid for Notification Channels: WORK LIST	The Menu Item name to which the Notification applies. For a notification referring to campus community, Personal Information (Student), Add/Update Person, Biographical Details the value would be : SCC_BIO_DEMO .
Page Name	Page Name Valid for Notification Channels: WORK LIST	The Page name to which the Notification applies. For a notification referring to campus community, Personal Information (Student), Add/Update Person, Biographical Details the value would be : SCC_BIO_DEMO_PERS.
Mode	Mode Valid for Notification Channels: WORK LIST	The Mode in which the component should be opened. For a notification referring to campus community, Personal Information (Student), Add/Update Person, Biographical Details the value would be: U (Update/Display).
Market	Market Valid for Notification Channels: WORK LIST	The Market to which the environments portal applies For a notification referring to campus community, Personal Information (Student), Add/Update Person, Biographical Details the value would be GBL.

Variable Name	Details	How does this relate to Notification Framework setup
URL	URL Valid for Notification Channels: WORK LIST	<p>The generated URL which is used by the Notification for the corresponding notification email.</p> <p>This is an example of the value for a generated notification URL referring to Campus Community, Personal information (student), Add/Update Person, Biographical Details: http://<EnvironmentName>/EMPLOYEE/HRMS/c/CC_BIO_DEMO_DATA_STDNT.SCC_BIO_DEMO.GBL?Page=SCC_BIO_DEMO_PERS&ACAD_CAREER=UGRD&EMPLID=<StudentID>&Action=U</p>

Testing the Notification Rule

In this example, the Email Notification Rule is used. Select the *Test Rule Action* as shown below:

This example illustrates the fields and controls for the Rules Engine Tester Page for Rules Engine Notification Example

Rules Engine Tester

Rule Name Email Notification
 Rule ID SCC_RULE_ID_20131219093336
 Version 1 Rule Status Active
 Entity ID

Test Data Profiles

Test Data Profile

Add a New Test Data Profile

Inputs

Type	Variable Name	Long Description	Required	Arguments	Search
Text	Consumer ID	The Notification Consumer ID of the consumer sending the notification.	<input checked="" type="checkbox"/>	SCC_NTF_CON_20131112191211	<input type="button" value="Q"/>
Text	Template ID	The Notification Template ID of the template to be utilized for the Notification. The Notification Template holds information about the notification type and recipients configuration.	<input checked="" type="checkbox"/>	SCC_NTF_TMP_20131112191858	<input type="button" value="Q"/>
Text	List of To Emplids	EMPLID to which the Notification is to be sent, Notification will be selected according to the settings which have been administered on the Notification Template, for example Preferred Email address	<input checked="" type="checkbox"/>	Click Search for input list	<input type="button" value="Q"/>
Text	List of CC Emplids	List of CC Emplids		Click Search for input list	<input type="button" value="Q"/>
Text	List of BCC Emplids	List of BCC Emplids		Click Search for input list	<input type="button" value="Q"/>
Data Set	List of NFK Template Variables	List of NFK Template Variables		Click Search for input values for the data set	<input type="button" value="Q"/>
Data Set	List of Email Attachments	List of Email Attachments		Click Search for input values for the data set	<input type="button" value="Q"/>

Elapsed Time 0:0:0.398

Outputs

Type	Variable Name	Long Description	Return	Details
Text	Notification Status Code	Notification Status Code for the Transaction	R	
Text	Notification Status	Notification Status for the Transaction	Partial Success	
Text	List of Error Messages	List of Error Messages	Click Details for output list	<input type="button" value="Details"/>

Variable	Instructions
List of To Emplids	Provide an Emplid or multiple Emplids. The Emplid selected should have the correct setup in place to receive this notification. For Example, in order to send an email to this EmplID, a valid EmplID must have been entered as Preferred Email address (for example via Campus community, Personal information (student), Biographical (student), addresses/phones, Electronic addresses).
Consumer ID	Use provided prompt to select the Consumer ID for Rules Engine.
Template ID	Use the provided prompt to select a Template ID which has been created for Consumer ID Rules Engine.

Variable	Instructions
List of NFK Template Variables	Use the provided prompt to provide a list of Template Variables. <hr/> Note: When using the Tester you must provide Text values. When calling the Notification Rule from another Rule, you can provide Variables for all or some list Values. <hr/>

Click **Execute Test** to test the Notification Rule. The **Outputs** grid displays information from the Notification Framework indicating the successful handling of the Notification; such as the Notification status Code, the Notification Status, and any relevant Error Messages.

After the Rule completes Generated notifications can be viewed via the Notification Admin component Open the Notification Admin component (Campus Community, Notifications, Admin Notifications). Select the appropriate Notification to view:

This example illustrates fields and controls for the Notifications Administration Overview Page for Rules Engine Notification Example.

Notifications Administration Overview

Period: 7 days ▼

ID	Name	Created on	Sender	Consumer Name	Importance	Subject	Details
SSRNL00001	Blok,Renske	04/02/2014 06:08:34	CampusRulesEngine@oracle.com	Rules Engine	Medium	Rules Engine Message	Details
SSRNL00001	Blok,Renske	04/02/2014 05:51:21	CampusRulesEngine@oracle.com	Rules Engine	Medium	Application Status	Details
SSRNL00001	Blok,Renske	04/02/2014 05:30:14	CampusRulesEngine@oracle.com	Rules Engine	Medium	Application Status	Details
SSRNL00001	Blok,Renske	04/02/2014 05:17:06	CampusRulesEngine@oracle.com	Rules Engine	Medium	Rules Engine Message	Details
SSRNL00001	Blok,Renske	04/02/2014 05:13:11	CampusRulesEngine@oracle.com	Rules Engine	Medium	Testing 123	Details

Calling the Notification Rule

The Notification Rule can be called from another Rule. This allows you to generate Notifications in a notification channel for multiple students which are selected based on the logic you have created in the calling Rule. The following is an example of a Rule calling the Notification Rule. This simple Rule sends a notification to active applicants in a selected career: The call statement has been added simply by selecting the Notification Rule and providing required Input values. The prompt functionality for Consumer ID and Template ID also works on the call statement.

This example illustrates the fields and controls for the Define Rule Page for Notification Rule Call Example.

Version	1	Rule Build Status	Build Successful
Rule Status	Active	Status Last Date/Time	03/17/2014 6:46PM PDT
*Rule Name	Email to Activated Applicants		
*Long Description	Email to Activated Applicants		
Rule Category Name	Admissions & Notifications		
Rule Group Name			
*Rule Usage	Rule		
*Skill Level	Expert		
Entity Name	Academic Program	View Entity Hierarchy	
*Entity Data Load Option	Retrieve Data By Criteria		
*Logging Level	Trace Logging		
	<input type="checkbox"/> Available To Be Used		

▶ Variables

Add a Variable

▶ Criteria

Evaluations and Calculations		Personalize Find	First	1-4 of 4	Last
Active	Statement Description			Details	
1	<input checked="" type="checkbox"/> ADD TO LIST Using List Mail Subject and Message Value Mail Subject, Value Mail Body Message		▼		+ -
2	<input checked="" type="checkbox"/> FOR EACH Academic Program		▲ ▼		+ -
3	<input checked="" type="checkbox"/> - IF Academic Program.Academic Program Status = AC		▲ ▼		+ -
4	<input checked="" type="checkbox"/> - CALL Rule Notification Rule (Email, SMS, Alert, Push, Worklist) passing in Academic Program.Empl ID as To EMPLID, SCC_NTF_CON_20131112191211 as Consumer ID, SCC_NTF_TMP_20131112191858 as Template ID, Template Variables as Template Variables, Mail Subject and Message as Template Variable Values		▲		+ -

Setting Up and Using the Generic Service Tester

Understanding the Generic Service Tester

The Generic Service Tester (GST) is a tool to test web service functionality by configuring the tester for a specific web service operation. This tool leverages the entity framework, part of Campus Solutions, for retrieving the entity-related information. If a service does not use the entity framework, a fabricated or temporary entity can be created to leverage and use the service tester.

The Generic Service Tester consists of the following components:

- Service Tester Setup
- Service Tester

The components are delivered using the permission list HCCPCSSA1000 (CS Administration — All Pages).

See [Setting Up Entity Registry](#).

Setting Up the Service Tester

This section discusses:

- Configuring the Service Tester.
- Copying a service tester configuration.
- Defining input parameters.

Pages Used to Set Up the Service Tester

<i>Page Name</i>	<i>Definition Name</i>	<i>Navigation</i>	<i>Usage</i>
Service Tester Setup	SCC_ST_SETUP	Set Up SACR > System Administration > Utilities > Generic Service Tester > Service Tester Setup	Set up the service tester for service operation.

Page Name	Definition Name	Navigation	Usage
Service Tester Setup Copy	SCC_ST_SETUP_COPY	Click the Copy button on the Service Tester Setup page.	Copy and modify an existing service tester configuration.
Input Parameters	SCC_ST_ENT_PROPS	Click a Properties link on the Service Tester Setup page.	Configure the property details for each entity.

Configuring the Service Tester

Access the Service Tester Setup page (**Set Up SACR > System Administration > Utilities > Generic Service Tester > Service Tester Setup**).

This example illustrates the fields and controls on the Service Tester Setup page. You can find definitions for the fields and controls later on this page.

Use the Service Tester Setup page to set up the service tester for a service operation using entities. You can set up the default values to test the service operation based on your requirements. You must set up one service tester ID for each service operation.

Field or Control	Description
Copy	Click to access the Service Tester setup copy page to copy and modify an existing service tester configuration.
Default Sign on (WS security)	Provide a user ID and password to be used as the default sign-in credentials.
Application Class	Select an application class code to customize the generation of the request XML.

Field or Control	Description
Entity Name	Select the entities you want to include in the service tester setup.
Embed	<p>GST uses only the entities, but <i>not</i> the entity hierarchy from the entity registry.</p> <p>Select the Embed check box if you want the child entity data to be embedded in the parent entity data. This is useful for certain sibling record purposes where you do not want the XML to show the child at a separate level from the parent.</p>
Parent Entity	If required, select a parent entity.
Override Entity to XML	<p>By default, the Override Entity to XML check box is not selected and the XML is generated using the to XML option.</p> <p>However, if you need to generate only a request XML with the properties rendered as fields on the GST page and not with all the tags from the entity registry, then select the Override Entity to XML check box.</p> <p>See Setting Up Entity Registry, “Setting Up Entity Properties.”</p>
Properties	<p>Click to access the Input Parameters page and configure the rendering of the service tester. For example, define the default value of an input parameter. The to XML option is found on the Entity Properties page when you set up the entity registry.</p> <p>See Defining Input Parameters.</p>

Copying a Service Tester Configuration

Click the **Copy** button on the Service Tester Setup page.

Use this page to copy an existing service tester configuration. You can then modify the properties of the new service tester to fit your requirements.

Field or Control	Description
*Service Tester ID	Enter a new service tester ID.

Defining Input Parameters

Click the **Properties** link that corresponds to an entity whose properties you want to define.

This example illustrates the fields and controls on the Input Parameters page. You can find definitions for the fields and controls later on this page.

Input Parameters

Entity Name CourseSearchRequest

Property Details						
Order	Property Name	UI Widget Type	Display on Page	Required Field	Property Default	Override Label
1	INSTITUTION	Prompt	<input checked="" type="checkbox"/>	<input checked="" type="checkbox"/>	PSUNV	
2	SSR_ALPHANUM	Edit Box	<input checked="" type="checkbox"/>	<input type="checkbox"/>	A	
3	SUBJECT	Prompt	<input checked="" type="checkbox"/>	<input type="checkbox"/>		Subject
4	ASOFDATE	Date	<input checked="" type="checkbox"/>	<input type="checkbox"/>		
5	SSR_CRS_SRCH_MODE	Drop Down	<input checked="" type="checkbox"/>	<input type="checkbox"/>	H	Search Mode
999	SCC_ENTITY_INST_ID		<input type="checkbox"/>	<input type="checkbox"/>		
999	SSR_FREE_FORM_SRCH		<input type="checkbox"/>	<input type="checkbox"/>		
999	STRM		<input type="checkbox"/>	<input type="checkbox"/>		
999	ACAD_CAREER		<input type="checkbox"/>	<input type="checkbox"/>		

Use this page to define the property details of the input parameters.

<i>Field or Control</i>	<i>Description</i>
Property Default	Specify the default value you want to use.

Testing Web Services

This section discusses how to use the Generic Service Tester to test a web service.

Page Used to Test a Web Service

<i>Page Name</i>	<i>Definition Name</i>	<i>Navigation</i>	<i>Usage</i>
Service Tester	SCC_ST_TESTER	Set Up SACR > System Administration > Utilities > Generic Service Tester > Service Tester	Test a web service.

Using the Generic Service Tester to Test a Web Service

Access the Service Tester page (Set Up SACR > System Administration > Utilities > Generic Service Tester > Service Tester).

This example illustrates the fields and controls on the Service Tester page. You can find definitions for the fields and controls later on this page.

Service Tester

'Service Tester ID

Service Name SSR_COURSE

Service Operation SSR_GET_COURSES **Request ID**

Sign on (WS security)

User ID **Password**

CourseSearchRequest

'Academic Institution

Search Character

Subject

As Of Date

Search Mode

Clear All
Create Request

Request

```

<?xml version="1.0"?>
<SSR_GET_COURSES_REQ xmlns="http://xmlns.oracle.com/Enterprise/HCM/services">
  <COURSE_SEARCH_REQUEST>
    <INSTITUTION>PSUNV</INSTITUTION>
    <SSR_ALPHANUM>A</SSR_ALPHANUM>
    <SUBJECT></SUBJECT>
    <ASOFDATE></ASOFDATE>
    <SSR_CRS_SRCH_MODE>H</SSR_CRS_SRCH_MODE>
  </COURSE_SEARCH_REQUEST>
</SSR_GET_COURSES_REQ>
    
```

Save Request
Submit

Response

```

<SUBJECT_LOVDescr>Art History</SUBJECT_LOVDescr><SUBJECT_CRS_COUNT>6</SUBJECT_CRS_COUNT>
<COURSE_SUMMARIES/></SUBJECT><SUBJECT><INSTITUTION>PSUNV</INSTITUTION>
<INSTITUTION_LOVDescr>PeopleSoft University</INSTITUTION_LOVDescr><SUBJECT>ASTRO</SUBJECT>
<SUBJECT_LOVDescr>Astronomy</SUBJECT_LOVDescr><SUBJECT_CRS_COUNT>1</SUBJECT_CRS_COUNT>
<COURSE_SUMMARIES/></SUBJECT><SUBJECT><INSTITUTION>PSUNV</INSTITUTION>
<INSTITUTION_LOVDescr>PeopleSoft University</INSTITUTION_LOVDescr><SUBJECT>ACCT</SUBJECT>
<SUBJECT_LOVDescr>Accounting</SUBJECT_LOVDescr><SUBJECT_CRS_COUNT>7</SUBJECT_CRS_COUNT>
<COURSE_SUMMARIES/></SUBJECT></SUBJECTS></COURSE_SEARCH_RESULT></SSR_GET_COURSES_RESP>
    
```

Element name View Data in Grid

No. of rows: 6

INSTITUTION	INSTITUTION_LOVDescr	SUBJECT	SUBJECT_LOVDescr	SUBJECT_CRS_COUNT	COURSE_SUMMARIES
PSUNV	PeopleSoft University	ANATOMY	Anatomy	1	
PSUNV	PeopleSoft University	ANTHRO	Anthropology	21	
PSUNV	PeopleSoft University	ART	Art	31	
PSUNV	PeopleSoft University	ARTHIST	Art History	6	
PSUNV	PeopleSoft University	ASTRO	Astronomy	1	
PSUNV	PeopleSoft University	ACCT	Accounting	7	

Use the Service Tester page to test the functionality of a web service. The response XML that the Service Tester generates helps you ensure:

- All required attributes are included in the XML.
- The correct sequence of attributes. For example, codes and descriptions are tied together.
- Naming conventions are implemented.
- Responses are correct following the desired functionality.

- The parent-child relationship of entities is observed following the required functionality.

However, you cannot use the Service Tester to test technical issues like:

- Schema definition
- Username token in SOAP headers
- Namespace-related issues

Note: The Generic Service Tester uses different Service Tester IDs for Self Service and Admin modes. When you test web service operations that have Admin and Self Services modes, make sure you select the appropriate Service Tester ID.

<i>Field or Control</i>	<i>Description</i>
Service Tester ID	Select a Tester ID to run a configuration you set up in the Service Tester Setup page.
Request ID	Load a previously saved request XML.
Create Request	Click to create the request XML.
Save Request	Click to save the request message XML in the PS_SCC_ST_REQXML record. You can reload the XML again for testing. Note: If you choose another Service Tester ID after you click Save Request , the Service Tester page is rendered with two tester regions. This is a known issue with the HTML areas that are used. If two tester regions appear, reload the page by selecting the page from the menu.
Submit	Click to invoke the service operation using the request XML. The response XML appears in the Response scroll area.
Element name	Select an element name to display in a grid.
View Data in Grid	When you click this button, the response XML is parsed and begins a search for all occurrences of the selected element name. The XML data is displayed in a grid format. Using this feature, you can verify the response XML immediately.

Delivered Service Operations

The following table lists the service operations that are configured and delivered as part of the Generic Service Tester.

Service Name	Service Operations
SAD_ADMISSIONS (Admin and Self Service Modes)	SAD_CREATEAPPL SAD_GETAPPL SAD_GETAPPLS SAD_GETATTACH SAD_SAVEAPPL SAD_SUBMITAPPL
SCC_LOV (Admin and Self Service Modes)	SCC_GET_LOV
SCC_USERREG (Admin and Self Service Modes)	SCC_USERREG_CREATEACCT SCC_USERREG_AUTHENTICATE
SCC_SHOPPING_CART	SCC_SC_ADDITEM SCC_SC_CLEARCART SCC_SC_GETCART SCC_SC_GETITEM SCC_SC_REMOVEITEM SCC_SC_VALIDATE SCC_SC_SAVECART SCC_SC_CHECKOUT
SSR_CLASS	SSR_GET_CLASSES SSR_GET_CLASS_SECTION SSR_STDNT_ENRL_OPTIONS
SSR_COURSE	SSR_GET_COURSES SSR_GET_COURSE_OFFERING

Service Name	Service Operations
SSR_ENROLLMENT	SSR_ADD_ENROLLMENT SSR_DROP_ENROLLMENT SSR_EDIT_ENROLLMENT SSR_SWAP_ENROLLMENT SSR_ENR_VALIDATE SSR_GET_ENROLLMENT SSR_STUDYLIST_DEADLINES

Working with Common Attribute Framework

Understanding Common Attribute Framework

Common Attribute Framework enables you to define a common attribute and add the common attribute as a data field to a Campus Solutions page. A user can then enter a value on the page for the data field.

A common attribute is a data element and is associated with a record in the system. A common attribute has the following properties:

- Name
- Type
- Default value (for example, a common attribute field on the user interface can show a default value that a user can change)
- Format (for example, suppose a user enters a value in a common attribute zip code field. In such a case, you may want the system to automatically append a hyphen between the fifth and sixth character when saving the value to the database)
- Validation

The framework delivers the following attribute types:

- Date
- Time
- Yes/No
- Number
- Long text
- Text (maximum number of characters is 50)
- Short text (maximum number of characters is 20)
- List of values

To implement a common attribute, you must perform the following steps.

1. Use the Application Designer to:
 - a. Identify the record that needs to be extended with attributes. For example, to add attributes to the General Materials page, choose the GENL_MATERIALS record.

- b. Create a child record with the same key fields as the identified record. Add the CAF subrecord SCC_CAF_SBR to this child record. The framework uses this child record to store attribute data.
 - c. On pages where the identified record is used, add the delivered subpage (SCC_CAF_LAUNCH_SBP or SCC_CAF_SBP depending on the desired user interface experience).
2. Use the Common Attribute page to:
 - a. Create attributes that you intend to associate with the identified record. For example, if you want to add Passport Number and Primary Institution fields to the General Materials page, create two attributes: Passport Number and Primary Institution.
 - b. Define the attribute type and format.
 3. Use the Record Context page to associate the attributes to the record. Continuing with the above example, use this page to add the two attributes to the GENL_MATERIALS record so that the two fields appear on the General Materials page.

In the following sections of this documentation, we use this example of adding attributes to the General Materials page to illustrate the implementation.

Using Application Designer to Configure a Record

Steps:

1. Identify the record to which attributes should be associated. For example, the following shows a record in Application Designer:

This example illustrates the fields and controls on the GENL_MATERIALS record. You can find definitions for the fields and controls later on this page.

	Num	Field Name	Type	Key	Ordr	Dir	CurC
	1	EMPLID	Char	Key	1	Asc	
	2	GENL_MATL_GROUP	Char	Key	2	Asc	
	3	GENL_MATL_TYPE	Char	Key	3	Asc	
	4	GENL_MATL_NBR	Nbr	Key	4	Desc	
	5	CHKLST_ITM_UPDT	Char				
	6	DT_RECVD	Date				

2. Create a child record for the identified record.
3. Make sure the child record has all the keys of the parent record and the subrecord SCC_CAF_SBR. The SCC_CAF_SBR subrecord adds a new key SCC_CAF_ATTR_SEQ to this new record, thereby making this a true child record to GENL_MATERIALS as this new record now has one additional key. The following shows the child record that you can create for the GENL_MATERIALS record:

This example illustrates the fields and controls on the New child record: GENL_MATERLS_CA. You can find definitions for the fields and controls later on this page.

Num	Field Name	Type	Key	Ordr	Dir	CurC
1	EMPLID	Char	Key	1	Asc	
2	GENL_MATL_GROUP	Char	Key	2	Asc	
3	GENL_MATL_TYPE	Char	Key	3	Asc	
4	GENL_MATL_NBR	Nbr	Key	4	Desc	
5	SCC_CAF_SBR	SRec				
	SCC_CAF_ATTR_SEQ	Nbr	Key	5	Asc	
	SCC_CAF_ATTRIB_NM	Char				
	SCC_CAF_ATTR_VAL	Char				
	SCC_CAF_ATTR_NVAL	Nbr				
	SCC_CAF_ATTR_DVAL	Date				
	SCC_CAF_ATTR_TVAL	Char				
	SCC_CAF_ATTR_LVAL	Long				

The framework uses this child record to store the attribute data.

Note: The SCC_CAF_LN_SBR subrecord provides multi-language functionality. This subrecord has an additional key field LANGUAGE_CD and all the fields from the SC_CAF_SBR subrecord that can contain descriptions such as SCC_CAF_ATTR_VAL and SCC_CAF_ATTR_TVAL.

In cases where the CAF field is added to a non-transaction table, Oracle recommends that you also create a related language record as appropriate. For an example of CAF functionality on a non-transactional table, refer to the CAF subrecord PS_EXT_ORG_TBL_CA created for table PS_EXT_PROG_TBL.

Adding a language table enables you to administer Long Text and Text fields in multiple languages. However, when administering CAF of type List of Values, a multi-language institution must ensure that a List of Values retains the same value in each language to prevent different values being stored for different languages.

- Modify the definition of the runtime page that displays the attributes. To do so, choose from the two delivered subpages:
 - SCC_CAF_LAUNCH_SBP: Displays attributes in a secondary page.
 - SCC_CAF_SBP: Displays attributes in a scroll area.

These two generic subpages, which the framework delivers, enable a user to access and manipulate the attributes in two different ways. The SCC_CAF_LAUNCH_SBP subpage displays a link. When the user clicks the link, the system launches a secondary page with all attributes associated with a record. The other subpage SCC_CAF_SBP displays attributes in a scroll area. You can choose one of these subpages for a quick implementation. There are no further technical changes or coding required. If you require a different type of user interface, then you must use the Common Attribute API.

See [Common Attribute Framework Application Class Reference](#).

Generic subpage SCC_CAF_LAUNCH_SBP

The following is the SCC_CAF_LAUNCH_SBP subpage:

This example illustrates the fields and controls on the SCC_CAF_LAUNCH_SBP subpage in Application Designer. You can find definitions for the fields and controls later on this page.



This subpage displays only a hyperlink on the page. Click this link to launch a modal secondary page containing all the attributes associated with the record. You can customize the hyperlink label on the Record Context page.

Considerations for using this subpage:

- If you want a small user-interface footprint on an existing page.
- This subpage does not contain a scroll area. This means that users cannot add multiple instances of an attribute; therefore, employ this option only in areas where a single instance of an attribute is required. Use this subpage to record only a single value for an attribute, such as Which Social Media Tool Do You Use.
- If you add this subpage to an effective dated table, you must add a PeopleCode snippet that ensures copying of forward field values onto a new effective dated row, when a new row is inserted into the scroll area. For details, see [Adding Common Attributes to Effective Dated Tables](#).

You must place this subpage in the scroll area where the extended record is the primary record. Also, ensure that the subpage is in the same component buffer level as the record in the page order tab.

This example shows the addition of SCC_CAF_LAUNCH_SBP to GENL_MATERIALS in Application Designer:

This example illustrates the fields and controls on the Adding SCC_CAF_LAUNCH_SBP subpage to GENL_MATERIALS. You can find definitions for the fields and controls later on this page.

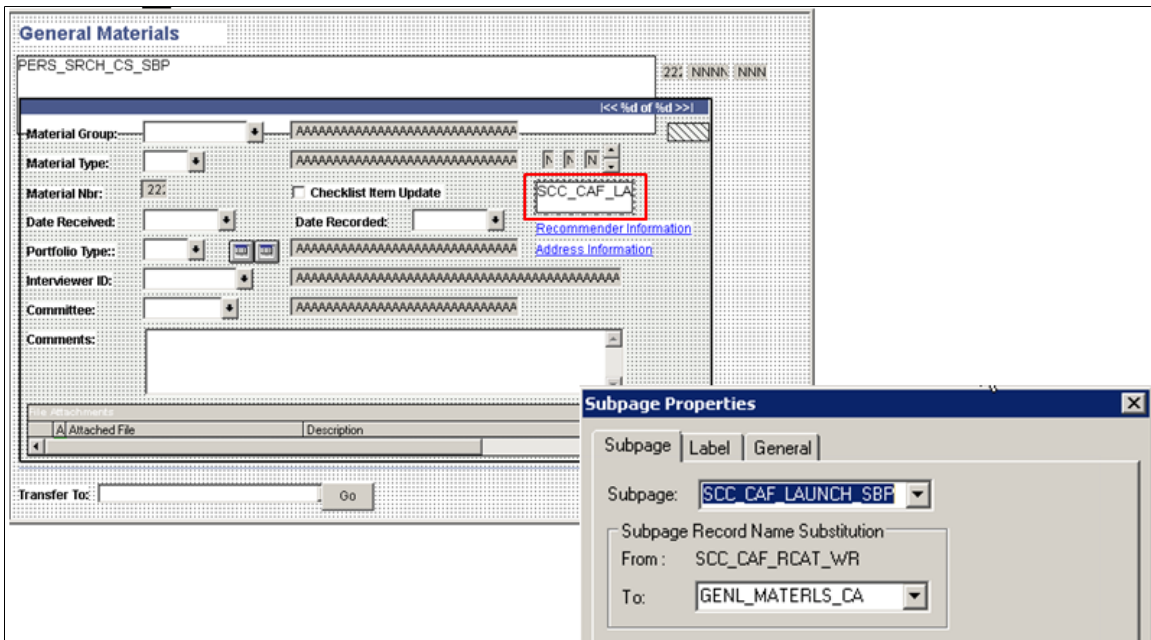

As shown in the above example, the attribute record (the new child record) must be entered in the **To** field of the Subpage Record Name Substitution section in the Subpage Properties window.

The following example shows the runtime result of implementing SCC_CAF_LAUNCH_SBP. In the example, the user can click the **Attributes** link on the General Materials page to enter the passport number and primary institution.

This example illustrates the fields and controls on the Attributes on a secondary page. You can find definitions for the fields and controls later on this page.

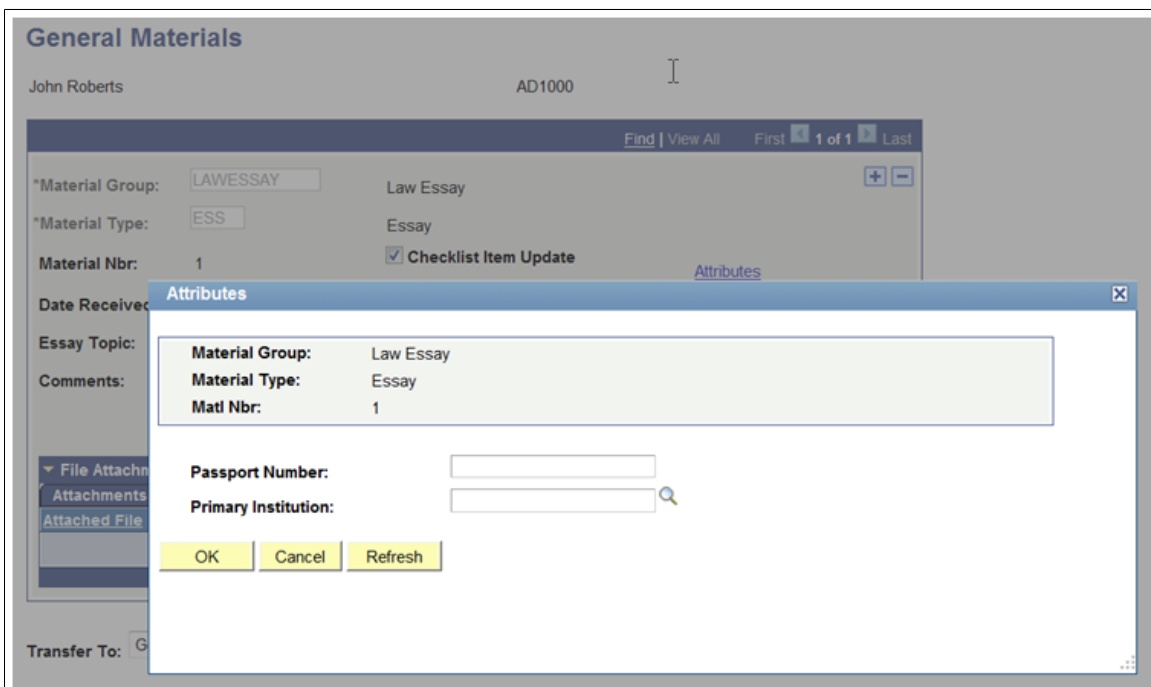

Generic Subpage SCC_CAF_SBP

The following is the SCC_CAF_SBP subpage:

This example illustrates the fields and controls on the SCC_CAF_SBP subpage in Application Designer. You can find definitions for the fields and controls later on this page.

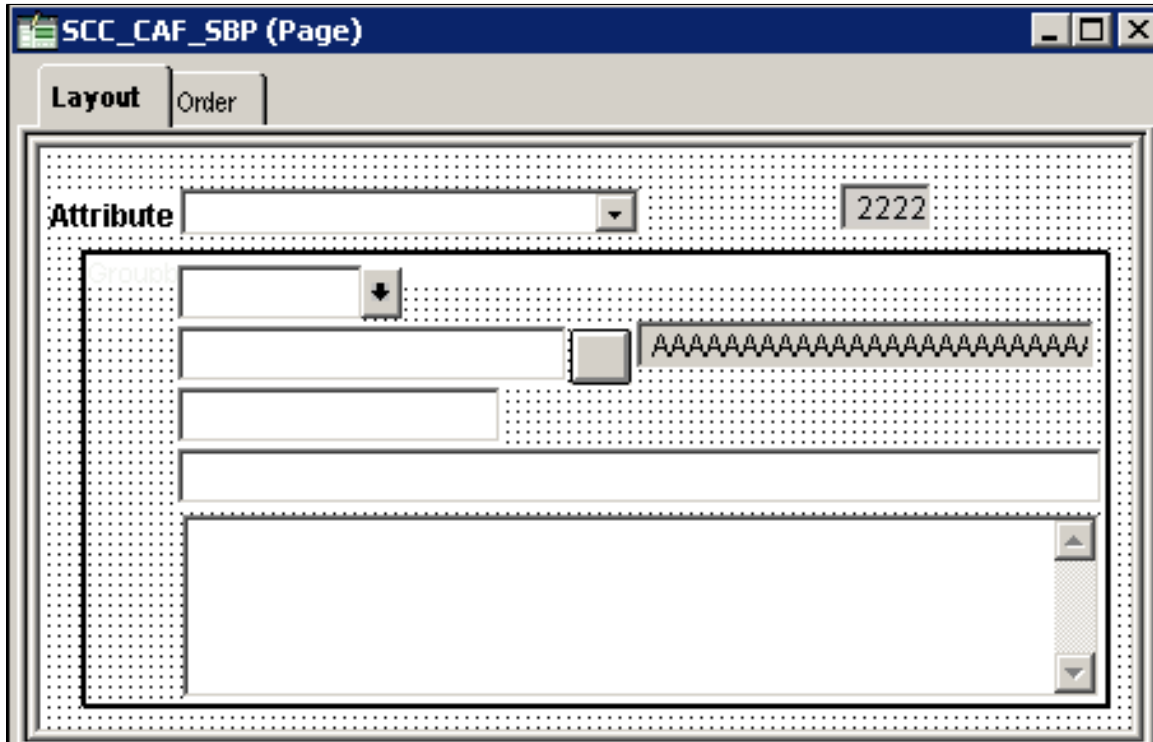

This subpage displays the associated attributes directly on the page. You must place this subpage inside the scroll area of the page. Also, the attribute record (the new child record) must be entered in the **To** field of the Subpage Record Name Substitution section in the Subpage Properties window. The component level of the scroll area should be one level higher than the record being extended.

Considerations for using this subpage:

- The user-interface footprint on an existing page is not an issue.
- There is a functional requirement for a scroll area, where users need to enter multiple instances of a repeatable attribute. For example, if you want to enable the user to record multiple values for a Which Social Media Tool Do You Use attribute, use this subpage.

The following example shows the runtime result of implementing SCC_CAF_SBP:

This example illustrates the fields and controls on the Attributes on the primary page. You can find definitions for the fields and controls later on this page.

The screenshot displays the 'Additional Information' tab of a web application. At the top, there are navigation tabs: 'Thesis Submission', 'Evaluation', 'Comments', 'Additional Information', and 'Attachments'. Below these, the user's name 'Arlene Brinton' is shown along with a star icon and a chat icon. The main content area contains the following information:

- ADRET000001** (with a star icon)
- Academic Institution:** PeopleSoft University
- Candidate Number:** 000000000001
- Min Submission Date:** 11/30/2011
- Academic Career:** Medical School
- Career Nbr:** 0
- Max Submission Date:** 12/30/2011
- Academic Program:** Medicine
- Days Remaining:** 0.00
- Academic Plan:** Animal Testing Research 1

Below this information, there is a section for 'Local Attributes' with a search bar and navigation controls. Two attributes are listed:

- *Attribute:** Passport Number (dropdown menu) with a text input field containing 'Enter Passport Nbr'.
- *Attribute:** Primary Institution (dropdown menu) with a search input field containing 'PSUNV' and a dropdown menu showing 'PeopleSoft University'.

Viewing the Common Attribute Type Details

This section discusses how to view the details of the delivered common attribute types.

Page Used to View the Common Attribute Type Details

<i>Page Name</i>	<i>Definition Name</i>	<i>Navigation</i>	<i>Usage</i>
Attribute Type	SCC_CAF_ATTR_TYPE	Set Up SACR > System Administration > Utilities > Common Attributes Setup > Attribute Type	View the details of the delivered common attribute types.

Viewing the Common Attribute Type Details

Access the Attribute Type page (Set Up SACR > System Administration > Utilities > Common Attributes Setup > Attribute Type).

This example illustrates the fields and controls on the Attribute Type page. You can find definitions for the fields and controls later on this page.

Attribute Type

Attribute Type: 05

Status: Active

Description: Date

Application Class: SCC_COMMON_ATTRIBUTE_FW:Adpaters:AbstractAttributeType

Value Fieldname: SCC_CAF_ATTR_DVAL

Defining a Common Attribute

This section discusses how to define a common attribute and how to:

- Create a common attribute.
- Define a list of values for a common attribute.

Pages Used to Define a Common Attribute

<i>Page Name</i>	<i>Definition Name</i>	<i>Navigation</i>	<i>Usage</i>
Common Attribute	SCC_CAF_ATTRIBUTES	Set Up SACR > Common Definitions > Common Attributes Setup > Common Attribute	Create, delete, or modify a common attribute.
CAF Values - LOV Definition	SCC_LOV_DEFN	Click the Create New CAF Values link or the Open CAF Value Setup link on the Common Attribute page.	Create or modify a list of values for an attribute of a list of values type. You can create a list of values yourself or you can have the framework retrieve the list of values from either a table or a translate field at runtime.

Creating a Common Attribute

Access the Common Attribute page (**Set Up SACR > Common Definitions > Common Attributes Setup > Common Attribute**).

This example illustrates the fields and controls on the Common Attribute page. You can find definitions for the fields and controls later on this page.

Common Attribute

Common Attribute: NLD_CLUSTER Delete Attribute

*Description:

*Attribute Type:

CAF Values

CAF Value Setup: 🔍

[Create New CAF Values](#) [Open CAF Value Setup](#)

	Attribute Value	Formal Description
1	CLUSTER A	Cluster A
2	CLUSTER B	Cluster B
3	CLUSTER C	Cluster C

Attribute Format

Attribute Format:

Record Context References View All | 🗨️ | 1 of 1 | Last

	Record Name	Description
1	SSR_AIR_HDR	Academic Item Attributes

Continuing with the GENL_MATERIALS record example that was discussed in the Application Designer section, we use the Common Attribute page to create the common attribute - Passport Number - as shown in this example screenshot:

This example illustrates the fields and controls on the Example of a Common Attribute . You can find definitions for the fields and controls later on this page.

Common Attribute

Common Attribute: DEMO Delete Attribute

*Description:

*Attribute Type:

Default Value:

Attribute Format

Attribute Format:

The value that you select in the **Attribute Type** field determines which fields are available for entry on this page. For example, the CAF Values group box is available only when you select an attribute type of *List of Values*.

Field or Control	Description
Common Attribute	Displays the name of the attribute. You specify an attribute name when you access the page in Add mode.
Delete Attribute	Available only after you save an attribute.
Description	The description that you enter here appears as a label for the attribute in the delivered subpages.
Attribute Type	<p>The Attribute Type determines the type of value that a user can enter for the attribute.</p> <p>Select:</p> <ul style="list-style-type: none"> • <i>Date</i>: The attribute appears as a date control on the delivered subpages. • <i>Time</i>: The attribute appears as a time control on the delivered subpages. • <i>Yes/No</i>: The attribute appears as a yes/no field on the delivered subpages. • <i>Number</i>: The attribute appears as a number data control on the delivered subpages. • <i>Long text</i>: The attribute appears as a long edit box on the delivered subpages. • <i>Text</i>: The attribute appears as a regular edit box on the delivered subpages. The maximum number of characters that a user can enter for this type is 50. • <i>Short text</i>: The attribute appears as a regular edit box on the delivered subpages. The maximum number of characters that a user can enter for this type is 20. • <i>List of values</i>: The attribute appears as an edit box with a lookup icon on the delivered subpages. Users can click the lookup icon and select a value for the attribute. Users can also enter a value in the box and when they tab out, the framework validates if the entered value exists in the list of values. If the entered value does not exist in the list, then the system displays an error message.

Field or Control	Description
Integer Position	<p>Available only when the Attribute Type is <i>Number</i>.</p> <p>Enter the maximum number of digits that are allowed before the decimal for numeric attribute types. For example, if you enter 3 here and the user enters a value 9934.89 for the attribute, the system returns an error. However, if you enter 3 here and if the user enters a value 993.89, it means the user is entering the number in the correct format.</p>
Decimal Position	<p>Available only when the Attribute Type is <i>Number</i>.</p> <p>Enter the maximum number of decimal places that are allowed for numeric attribute types. For example, if you enter 1 here and the user enters a value 993.89 for the attribute, the system returns an error. However, if you enter 1 here and if the user enters a value 993.8, it means the user is entering the number in the correct format.</p>
Enable Rich Text Editing	<p>Available only when the Attribute Type is <i>Long Text</i>.</p> <p>Select this check box if you want enable editing and formatting capabilities for users when they edit the attribute value in the delivered subpages.</p>
Default Value	<p>Available only when the Attribute Type is <i>Short Text</i>, <i>Long Text</i>, <i>Number</i>, <i>Text</i>, or <i>Yes/No</i>. When the Attribute Type is <i>Yes/No</i>, you can set the default value by selecting the Yes or No radio button.</p> <p>The value that you enter here appears as the default value for the attribute in the delivered subpages.</p>
Default to current date	<p>Available only when the Attribute Type is <i>Date</i>.</p> <p>Select this check box if you want the system date to appear as the default value for the attribute in the delivered subpages.</p>
Default to current time	<p>Available only when the Attribute Type is <i>Time</i>.</p> <p>Select this check box if you want the system time to appear as the default value for the attribute in the delivered subpages.</p>

CAF Values

This group box is available only when the **Attribute Type** is *List of Values*.

This example illustrates the fields and controls on the Example of a Common Attribute page for List of Values. You can find definitions for the fields and controls later on this page.

Common Attribute

Common Attribute: TST_EXAM_LANGUAGE Delete Attribute

*Description:

*Attribute Type:

CAF Values

CAF Value Setup: 🔍

[Create New CAF Values](#) [Open CAF Value Setup](#)

	Attribute Value	Formal Description
1	ENGLISH	English Language Exam
2	FRENCH	French Language Exam
3	GERMAN	German Language Exam

Personalize | Find | View All | 📄 | 📊
First ◀ 1-3 of 3 ▶ Last

Attribute Format

Attribute Format:

Use the CAF Values group box to define the values in the list.

Field or Control	Description
CAF Value Setup	<p>Indicates the list of values definition that you have selected for the attribute.</p> <p>If you enter this page in Add mode, the CAF Value Setup field is blank. You can either use this field to select a list of values that already exists in the system or click the Create New CAF Values link to create a new list of values definition.</p>
Create New CAF Values	Click to access the CAF Values - LOV Definition page where you can define a new list of values for the attribute.
Open CAF Value Setup	<p>This link appears only if the CAF Value Setup field is populated.</p> <p>Click this link to access the CAF Values - LOV Definition page where you can view or edit the list of values that is selected for the attribute.</p>

Filters

When a common attribute with a List of Values type based on Ad Hoc Values or Table is saved and the associated CAF value setup in the CAF Values - LOV Definition page uses a filter field, the Filters grid is available on the Common Attribute component:

This example illustrates the fields and controls on the Example of a Common Attribute page with the Filters grid. You can find definitions for the fields and controls later on this page.

Common Attribute

Common Attribute: TEST_ADHOC Delete Attribute

*Description:

*Attribute Type: List Of Values ▼

CAF Values

CAF Value Setup: 🔍

[Create New CAF Values](#) [Open CAF Value Setup](#)

Filters	
Field Name	Field Value
1	INSTITUTION

Personalize | Find | 📄 | 📊 First ◀ 1 of 1 ▶ Last Refresh

Attribute Value		Formal Description	
1	02	Description for 02	
2	03	Description for 03	

Attribute Format

Attribute Format: ▼

This feature enables you to preview the values that will be available to a user based on the filter field values defined in the CAF Values - LOV Definition page. To preview the values that are available, enter a field value in the Filters grid and click the **Refresh** button.

See [Defining a Common Attribute](#), “Defining a List of Values for a Common Attribute.”

Attribute Format

Use this group box to specify the formatting and validation that the framework must perform on the attribute value. Select from the delivered formatting and validation options, or specify your own custom application class.

Field or Control	Description
Attribute Format	<p>Specify the formatting and validation that the framework must perform on the attribute value:</p> <ul style="list-style-type: none"> • <i>Email Address</i>: Validates if the value entered for the attribute is a valid email address or not. The validation logic used in Campus Community Bio/Demo pages is used here. • <i>ISO Country Code</i>: Verifies if the data entered for the attribute is a valid ISO country code. • <i>US State Code</i>: Verifies if the data entered for the attribute is a valid US state code. • <i>US Zip Code</i>: This is a formatting class. If the attribute value is of 9 digits, it introduces a hyphen between the 5th and 6th character on tab out. • <i>Custom Class</i>: Enables you to specify an application class that performs the formatting and validation.
Application Class	<p>Available only when the Attribute Format is <i>Custom Class</i>.</p> <p>Specify the application class that formats and validates the attribute value.</p> <p>To write a custom class using PeopleCode, see Writing Custom Logic for Validation and Formatting.</p>

Record Context References

This section lists all the record contexts with which the attribute is associated. Click the link on the Description column to access the Record Context component for the particular record context.

When you define a common attribute, the Record Context References section does not appear on the page. The section appears only after you associate the common attribute to one or more records using the Record Context component.

Defining a List of Values for a Common Attribute

Access the CAF Values - LOV Definition page (click the **Create New CAF Values** link or the **Open CAF Value Setup** link on the Common Attribute page).

Field or Control	Description
LOV Unique ID	Displays the system-assigned ID for the list of values. When you create a new list of values, this field displays <i>NOID</i> . When you save the list, the system assigns an ID.
CAF Value Type	Specify whether you want to define the values yourself (Ad Hoc Values), or whether you want the framework to retrieve the values from a table (Table) or a translate field (Translate Values). The fields on the page change depending on the CAF value type that you select.

Defining Ad Hoc List of Values

If the **CAF Value Type** is *Ad Hoc Values*, then you can enter a free-form list of value and description pairs.

This example illustrates the fields and controls on the CAF Values - LOV Definition page (Ad Hoc list of values). You can find definitions for the fields and controls later on this page.

CAF Values

LOV Unique ID: SCC_LOV_20120613235848

*Description: TEST_LANGUAGES

CAF Value Type

Ad Hoc Values
 Table
 Translate Values

Copy Ad Hoc values from

? Copy

Filter Field: ?

Ad Hoc Values Find | View 1 First 1 1-3 of 3 Last

*Value:	English	+ -
*Description:	English Language Exam	
<hr/>		
*Value:	French	+ -
*Description:	French Language Exam	
<hr/>		
*Value:	German	+ -
*Description:	German Language Exam	

Enter the value-description pairs in the Ad Hoc Values group box.

Use the Copy Ad Hoc Values From group box to copy values from an existing list. To copy values from an existing list: Click the lookup icon in the Copy Ad Hoc Values From group box, select a list, and click the **Copy** button. If you want to define new values for the list, leave the group box blank.

If the ad hoc list of values, which an attribute on a page displays, should be filtered based on a field value in that page, then select the field name in Filter Field. When you select a filter field, the Extension grid becomes available in the Ad Hoc Values scroll area. Use the Extension grid to specify the field value for which a value-description pair becomes available. For example, suppose you have a list of values attribute on a page and the same page has an Institution field. When a user enters *PSAUS* in the Institution field, you want the attribute to display *02* and *03* as the list of values. And when a user enters *PSGBR* in the Institution field, you want the attribute to display *01* and *03* as the list of values. The following example shows how to set up this scenario:

This example illustrates the fields and controls on the Example of filtering an attribute's list of values (1 of 2). You can find definitions for the fields and controls later on this page.

CAF Values

LOV Unique ID: SCC_LOV_20120608101414

*Description: Adhoc Values

CAF Value Type

Ad Hoc Values
 Table
 Translate Values

Copy Ad Hoc values from

Copy

Filter Field: INSTITUTION 🔍

Extension Field Value Defaults 📄 1 of 1 Add to Extension

	*Field Value		
1	<input style="width: 95%;" type="text"/>	+	-

Ad Hoc Values Find | View 1 First 1-3 of 3 Last

*Value: 01 + -

*Description: Value 1

Extension Personalize | Find | View All 📄 1 of 1 Last

	*Field Value		
1	PSGBR	+	-

This example illustrates the fields and controls on the Example of filtering an attribute's list of values (2 of 2). You can find definitions for the fields and controls later on this page.

The screenshot displays two panels for filtering attribute values. Each panel includes a text field for the value, a description field, and an 'Extension' grid. The top panel shows a value of '02' and a description of 'Description for 02'. The 'Extension' grid has one row with the value '1' and 'PSAUS'. The bottom panel shows a value of '03' and a description of 'Description for 03'. The 'Extension' grid has two rows: the first with '1' and 'PSAUS', and the second with '2' and 'PSGBR'. Each row in the grid has '+' and '-' buttons. At the bottom of the interface are 'OK', 'Cancel', and 'Apply' buttons.

To aid in data entry, you can use the Extension Field Value Defaults grid to quickly add a field value to all the Extension grids in the Ad Hoc Values scroll area. Enter a field value in the Extension Field Value Defaults grid and then click the **Add to Extension** button to add the field value to all the Extension grids.

Note: Field Value is a free-form field. Therefore, you must be careful to provide the correct value for the Extension grid. The value you enter as the Field Value is case sensitive.

Defining List of Values from a Table

If the **CAF Value Type** is *Table*, then specify the record (Prompt Table) and field (Prompt) on which the list of values should be based.

This example illustrates the fields and controls on the CAF Values - LOV Definition page (list of values retrieved from a table). You can find definitions for the fields and controls later on this page.

CAF Values

LOV Unique ID: NOID

*Description:

CAF Value Type

Ad Hoc Values
 Table
 Translate Values

*Prompt Table: 🔍

*Prompt: 🔍

Description Fieldname: 🔍

Prompt Table Filters Personalize | Find | 🔍 First 1-2 of 2 Last

#	*Field Name	Source	Constant Value	Allow Blanks	
1	<input type="text" value="INSTITUTION"/> 🔍	Constant ▼	<input type="text" value="PSUNV"/>	<input type="checkbox"/>	+ -
2	<input type="text" value="ACAD_CAREER"/> 🔍	Request XML ▼		<input type="checkbox"/>	+ -

Exclude Prompt Field Values

Excluded Values Personalize | Find | View All | 🔍 First 1 of 1 Last

#	Value	Description	
1	<input type="text"/>	<input type="text"/>	+ -

Use **Description** Fieldname to indicate the description field for the value's description.

If there are any fields in the prompt table whose value the system should use to filter the list of values, specify these fields in the **Prompt Table Filters** grid.

If you select a source option of *Constant*, then you can enter the filter value in the **Constant Value** field. If you select a source option of *Request XML*, then the framework will try to automatically figure out the value of the filter field from the page at runtime. For example, suppose you have added an Academic Program list of values attribute on a page, and the same page displays an Institution and Academic Career field. You want the list of values to display academic programs for only the *PSUNV* institution and for the academic career which the user selects. The above screenshot shows how to set up this scenario.

To exclude any values from being displayed at runtime, specify these values in the **Exclude Prompt Field Values** grid. Click the **Populate Valid Values** button to populate the **Excluded Values** grid with the field's (Prompt's) values. Click the **Remove All Values** button to remove all the values from the **Excluded Values** grid.

Defining Translate List of Values

If the **CAF Value Type** is *Translate Values*, then specify the translate field (Prompt) on which the list of values should be based.

This example illustrates the fields and controls on the CAF Values - LOV Definition page (list of values retrieved from a translate field). You can find definitions for the fields and controls later on this page.

CAF Values

LOV Unique ID: NOID

*Description:

CAF Value Type

Ad Hoc Values
 Table
 Translate Values

*Prompt: 🔍

Translate Usage

Use Long Description
 Use Short Description

Exclude Prompt Field Values

Excluded Values		Personalize Find View All	First 1-2 of 2 Last
	Value	Description	
1	<input type="text" value="P"/>	<input type="text" value="Enrolled Part-Time"/> 🔍	+ -
2	<input type="text" value="T"/>	<input type="text" value="Three Quarter Time"/> 🔍	+ -

Use the **Translate Usage** grid to specify if the framework should use the translate long description or short description as the value's description.

Associating a Common Attribute to a Record

After configuring the record with Application Designer and creating the attributes, extend the record with these attributes.

Pages Used to Associate a Common Attribute to a Record

Page Name	Definition Name	Navigation	Usage
Record Context	SCC_CAF_REC_ATTRIB	Set Up SACR > Common Definitions > Common Attributes Setup > Record Context	Associate an attribute with a record. Later on, you can modify or delete this association.
Secondary Page Options	SCC_CAF_SECPG_OPTN	Set Up SACR > Common Definitions > Common Attributes Setup > Record Context > Secondary Page Options	Set up the secondary page if you are using SCC_CAF_LAUNCH_SBP subpage.

Associating a Common Attribute to a Record

Access the Record Context page (Set Up SACR > Common Definitions > Common Attributes Setup > Record Context).

This example illustrates the fields and controls on the Record Context page. You can find definitions for the fields and controls later on this page.

The screenshot displays the 'Record Context' configuration page. At the top, there are tabs for 'Record Context' and 'Secondary Page Options'. A 'Delete Record Context' button is visible. The main form includes the following fields and controls:

- Record (Table) Name:** ACAD_SUBPLAN
- *Description:** Student Subplan attributes
- *Attribute Record:** SSR_SUBPLAN_CAF (with a search icon)
- Override Prompt Table:** (with a search icon)
- System Data:**
- Extend to staging record:**
- Entity Name:** Student SubPlan Attribute (with a search icon)
- Attribute Filter Class:** (with a search icon)
- Attribute Display Type:** Radio buttons for 'Inline Subpage' and 'Secondary Page' (selected).
- Copy Attributes from:** (with a search icon) and a 'Copy' button.
- Attributes Table:**
 - Find | View All | First | 1 of 1 | Last
 - *Attribute Sequence: 1
 - Status: Active (dropdown)
 - *Common Attribute: (with a search icon)
 - Required:
 - Entity Associations: (with a right-pointing arrow)

Continuing with the GENL_MATERIALS record example that was discussed in the Application Designer section: After we use the **Common Attribute** page to create the common attributes—Passport Number and Primary Institution—we use the **Record Context** page to associate the GENL_MATERIALS record with these two attributes.

Note: Extending a record with an attribute is similar to adding a new field to that record. The advantage of extending a record with an attribute is that there is no impact on any existing functionality in the system that uses this record. Additionally, it is possible to change the number and order of attributes at runtime dynamically without having any impact on existing extensions to this record.

Warning! For performance reasons, Oracle recommends that you limit the number of attributes for a given record context to no more than 25.

Field or Control	Description
Record (Table) Name	Displays the record that you are extending (that is, displays the record in context). You specify this record when you access the page in Add mode.
Delete Record Context	Available only after you save a record in context.
Description	This field is informational only and is not used in any processing.
System Data	This check box indicates if the Record Context is delivered. The check box defaults to <i>not selected</i> for records added by an institution.
Attribute Record	Specify the record that contains the SCC_CAF_SBR subrecord. The framework uses this mapping to store the attribute data, entered at runtime, in this record. This record should be a child record of the record in context.
Override Prompt Table	This field enables consumers of Common Attribute Framework who choose to deploy their own user interface (UI) – rather than the delivered subpage or secondary page – to use a regular edit box rather than the default behavior of a drop-down list box that lists all attribute values. This enables consumers to filter the available values using a custom view to implement their own filtering logic. For example, assume that you have an ABC list box. For user M, the ABC list box should display a different list of values. For user N, the ABC list box should display a different list of values. In such a case, you should use the Override Prompt Table field.

Field or Control	Description
Extend to Staging Record	<p>Select to indicate that any common attributes assigned to this record context is valid for its staging record. This enables consumers to share attributes rather than having to keep separate record context definitions in sync. When you select this check box, the Staging Record and Staging Attribute Record fields become available for edit.</p> <p>A staging record defines a table to store data that is brought into the system through some kind of import process or interface, before the data is moved into actual production tables.</p> <p>Here is an example of when you need to select this check box and use its two associated fields (Staging Record and Staging Attribute Record): Assume that user 1 uses 123 attribute with record context ABC. Record ABC is populated via a data import into staging record XYZ. In such a case, attribute 123 would need to be associated with both record contexts — ABC and XYZ. By selecting this check box and providing the staging record name (XYZ), user 1 can enable the attribute 123 (and all other attributes defined for record context ABC) for the staging record without creating a separate record context definition.</p>
Entity Name	<p>Use this field to map a record context definition to its corresponding common attributes entity in the Entity Registry. The Entity Registry framework uses this mapping internally, to create, retrieve, update and delete data in the attribute record (SAD_TESTDT_CAF is the attribute record in the example graphic titled <i>Record Context page</i>). This field is used when attributes are exposed as properties of associated entities in the Entity Registry.</p>
Attribute Filter Class	<p>Specify a class that implements <code>SCC_COMMON_ATTRIBUTE_FW:Interfaces:iAttributeFilter</code>. This class provides an entity ID at runtime which is used by the framework to limit (filter) the available attributes on the transaction page at runtime. For information about creating an Attribute Filter class, see “Attribute Filter Class.”</p>

Attribute Display Type

Field or Control	Description
Inline Subpage	<p>When you save the page and more than twenty five attributes are present in the Attributes scroll area, the system displays a warning message. Select the Inline Subpage option if you do not want the system to display this message.</p> <p>The inline subpage (SCC_CAF_SBP) can display any number of attributes in the transaction component. So, this limit of twenty five attributes is not applicable to the inline subpage.</p>

<i>Field or Control</i>	<i>Description</i>
Secondary Page	<p>When you select this option:</p> <ul style="list-style-type: none"> • The fields on the Secondary Page Options page become available for edit. • The system displays a warning message when you save the Record Context page and more than twenty five attributes are present in the Attributes scroll area. • The Attributes scroll area does not display the Repeatable check box. Attributes cannot be repeated in a secondary page.

Copy Attributes from

To populate the list of attributes in the Attributes scroll area from another record context, specify the record name and click the **Copy** button. This clears any existing data in the Attributes scroll area and inserts all the attributes from the other record context.

Attributes

Use this scroll area to specify a list of attributes that you would like the record to be extended with. Remember, this is similar to adding fields to the record.

<i>Field or Control</i>	<i>Description</i>
Attribute Sequence	Determines the order of display of the attributes.

You can mark the attributes as required and repeatable. There is a small variation in the way the framework implements this feature in the two delivered subpages, as described in the following table:

SCC_CAF_LAUNCH_SBP	SCC_CAF_SBP
<p>Implication if you select the Required check box:</p> <p>The user must enter a value for this attribute before save. If the user does not enter a value and clicks the Save button, the system displays an error message: <i>Field is required</i>.</p>	<p>Implication if you select the Required check box:</p> <p>With this subpage, the user selects the attribute from a down-down list and then enters the value (refer to the example screenshot titled <i>Attributes on the primary page</i> in the "Using Application Designer to Configure the Record" section).</p> <p>The system inserts the attributes identified as required into the subpage at run time and the user must enter a value in order to save the component. A user cannot delete a required attribute because the system disables the delete button for the required rows. Also, the user cannot change the required attribute to a non-required attribute.</p>
<p>Implication if you select the Repeatable check box:</p> <p>This feature is not applicable here.</p>	<p>Implication if you select the Repeatable check box:</p> <p>The user can enter multiple instances of this attribute and its corresponding values in the scroll area.</p> <p>If you do not select the Repeatable check box and the user tries to enter multiple instances of this attribute in the scroll area, the system displays an error message.</p>

Field or Control	Description
Entity Association	<p>Enter the entities for which the attribute is valid. If the Attribute filter class provides an entity at runtime that matches an entity entered here, then the system displays this attribute on the runtime page. Conversely, if the Attribute filter class provides an entity at runtime that does <i>not</i> match an entity entered here, then the system does not display the attribute on the runtime page.</p> <p>If an attribute's entity association grid is blank, then the system does not filter the attribute and the attribute is always available on the runtime page irrespective of the entity provided by the attribute filter class at runtime.</p>

Related Links

[Setting Up Entity Registry](#)

Setting Up Secondary Page Options

Access the Secondary Page Options page (**Set Up SACR > Common Definitions > Common Attributes Setup > Record Context > Secondary Page Options**).

This example illustrates the fields and controls on the Secondary Page Options page. You can find definitions for the fields and controls later on this page.

The screenshot shows the 'Secondary Page Options' page for record context 'ACAD_SUBPLAN'. It includes an 'Override Secondary Page' field, a 'Link Label' section with 'Message Set Number' (14220), 'Message Number' (206), and 'Message Text' (Additional Fields). Below is a 'Header Fields' table with columns for Field Name, Use Short Label, Field Label, Related Table, Related Field, and Show Only Description. The table lists four fields: EMPLID, ACAD_CAREER, STDNT_CAR_NBR, and ACAD_PLAN.

*Field Name	Use Short Label	*Field Label	Related Table	Related Field	Show Only Description		
1 EMPLID	<input type="checkbox"/>	Empl ID	HCR_PERSON_NM	NAME_DISPLAY	<input type="checkbox"/>	+	-
2 ACAD_CAREER	<input type="checkbox"/>	Academic Career	ACAD_CAR_TBL	ACAD_CAREER	<input checked="" type="checkbox"/>	+	-
3 STDNT_CAR_NBR	<input type="checkbox"/>	Student Career Nbr	ACAD_PROG	STDNT_CAR_NBR	<input checked="" type="checkbox"/>	+	-
4 ACAD_PLAN	<input type="checkbox"/>	Academic Plan	ACAD_PLAN_TBL	ACAD_PLAN	<input checked="" type="checkbox"/>	+	-

Note: The fields on this page are available for edit only if you have selected the Secondary Page option on the Record Context page.

Link Label

The default hyperlink label in the subpage SCC_CAF_LAUNCH_SBP is *Attributes*. If you want a different label, specify the message catalog entry of the required text in this group box and that label is displayed on the page.

See *PeopleTools: System and Server Administration*, Message Catalog.

Header Fields

Optionally, you can use this grid to define header fields for the CAF_LAUNCH_SBP subpage. The fields you enter here display as read-only fields on the header region of the subpage.

Field or Control	Description
Field Name	Select the field you want to display on the header region of CAF_LAUNCH_SBP. The prompt lists all of the fields in the record context (GENL_MATERIALS in the example).
Use Short Label	Select this check box to use the default short name as the field label.

Field or Control	Description
Field Label	<p>Indicates the field label that the system displays on the header region of CAF_LAUNCH_SBP.</p> <p>When you select a Field Name, the Field Label field is automatically populated with the default long name. If you select the Use Short Label check box, the Field Label field is automatically populated with the default short name.</p> <p>If more names are available and you do not want to use the default value, you can select a different value as the field label.</p> <hr/> <p>Note: If the Header Fields grid contains rows where Use Short Label is selected for at least one but not all field names, then the grid displays two Field Label columns. The left column lists the long names, while the right column lists the short names.</p> <hr/>
Related Table	<p>The prompt lists all tables where the selected field (Field Name) exists. This enables you to add a related display field to the header. For example, if the field INSTITUTION is added to the header, there might be a need to display the description from the INSTITUTION_TBL.</p>
Related Field	<p>Prompts against the selected related table. The field you select here appears on the header. Continuing with the previous example, if you select INSTITUTION_TBL as the related table, then to display the institution's description you must select DESCR, DESCRFORMAL, or DESCRSHORT as the related field.</p>
Show Only Description	<p>This check box is available only when you select a related field.</p> <p>When this check box is selected, the subpage header displays only the related field value's description (rather than both the field value and the related field value's description). For example, suppose you select this check box for the EMPLID field name, select ID as the field label, select PERSONAL_DATA as related table, and select FIRST_NAME as related field. In such a case, if you select the Show Only Description check box, only the first name is displayed next to the ID label (for example, the header displays <i>ID: Arlene</i>). If you do not select the Show Only Description check box, both the ID number and first name are displayed (for example, <i>ID: 3765 Arlene</i>).</p>

Writing Custom Logic for Validation and Formatting

On the Common Attribute page, it is possible to associate formatting and validation logic with an attribute. If the delivered list of attribute format options is not sufficient, you can write your own application class with custom logic and associate that class with the attribute on the Common Attribute page.

The custom class must extend the interface
 SCC_COMM_ATTRIBUTE_FW:Interfaces:iAttributeModifier.

This interface has two methods: *Validate* and *Format*.

Validate method:

Write PeopleCode in this method that validates the data in the attribute. The framework invokes this method when the user tabs out of the attribute field after entering a value or clicks the Save button after entering the attribute value. If you want to display a message, populate the *&p_msg* object with the required message. The framework shows this message when the user tabs out of the attribute field after entering a value or clicks the Save button after entering the attribute value. The framework picks the severity of the message from the message catalog entry's severity.

Here is the sample code for populating the *&p_msg* object.

```
method validate
    /* &p_value as Any, +/
    /* &p_msg as SCC_COMMON:ENTITY:LOG:MessageLogBase out +/
    /* Returns Boolean +/
    /* Extends/implements
    SCC_COMMON_ATTRIBUTE_FW:Interfaces:iAttributeModifier.validate +/
    Local SCC_COMMON:ENTITY:LOG:MessageLogBase &msg =
    create SCC_COMMON:ENTITY:LOG:MessageLogBase ();
    Local SCC_COMMON:ENTITY:LOG:MessageEntry &me;
    If Len(String(&p_value)) >= 3 Then
        Local Record &rec = CreateRecord(Record.COUNTRY_TBL);
        &rec.COUNTRY.Value = String(Substring(&p_value, 1, 3));
        If &rec.SelectByKey() Then
            Return True;
        Else
            &me = create SCC_COMMON:ENTITY:LOG:MessageEntry ();
            &me.MsgSet = 14098;
            &me.MsgID = 10;
            &me.Severity = &me.Severity_Error;
            &msg.writeEntry (&me);
```

```

        &p_msg = &msg;
        Return False;
    End-If;
Else
    &me = create SCC_COMMON:ENTITY:LOG:MessageEntry();
    &me.MsgSet = 14098;
    &me.MsgID = 11;
    &me.Severity = &me.Severity_Error;
    &msg.writeEntry(&me);
    &p_msg = &msg;
    Return False;
End-If;
end-method;

```

The return value of this method indicates if the validation passed or failed. If the return value is *True*, then the framework assumes that the validation has passed and continues processing. But if the return value is *False*, the framework halts processing and displays the messages if any in the *&p_msg* object. Based on the severity of the message, the user is either forced to make changes to the attribute data (severity error) or just dismiss the message and continue with other attributes on the page.

Format method

The framework invokes this method on *fieldchange* event. Write PeopleCode in this method that formats the attribute value. The framework then displays the formatted value on the page.

Here is an example of formatting an attribute value to appear as a US zip code.

```

method format
    /* &p_value as Any */
    /* Returns String */
    /* Extends/implements
    SCC_COMMON_ATTRIBUTE_FW:Interfaces:iAttributeModifier.format */
    Local string &str = String(&p_value);
    If Len(&str) = 9 Then
        Return (Substring(&str, 1, 5) | "-" | Substring(&str, 5, 4));
    Else
        Return &str;
    End-If;
end-method;

```

Understanding the Common Attribute API

The Common Attribute Application Programming Interface (API) is intended to simplify the access and manipulation of attributes through PeopleCode. If attributes need to be accessed and manipulated in a different way compared to the delivered generic subpages, the framework provides some utility methods and classes that have a simple interface for manipulating attribute data.

The API supports retrieving attributes based on record context definitions. An attribute object received through this API can then be used to set the data, validate, format, get list of values, and save to backend. The CAF API is internally used by the delivered generic subpages and subrecord.

The API is contained in the application package: *SCC_COMMON_ATTRIBUTE_FW*. The *SCC_COMMON_ATTRIBUTE_FW:AttributeManager* application class provides a set of utility methods that can be used to fetch relevant attributes. This class behaves as a sort of object factory that provides attribute objects.

Attribute objects are instances of the *SCC_COMMON_ATTRIBUTE_FW:Attribute* class. This class encapsulates all the basic properties and behaviors of an attribute. It is possible to manipulate an attribute using its various methods. For the complete list of available methods in this class, see [Common Attribute Framework Application Class Reference](#).

The following diagram shows the application packages and classes in the Common Attribute Framework API:

This example illustrates the fields and controls on the Common Attribute Framework API. You can find definitions for the fields and controls later on this page.

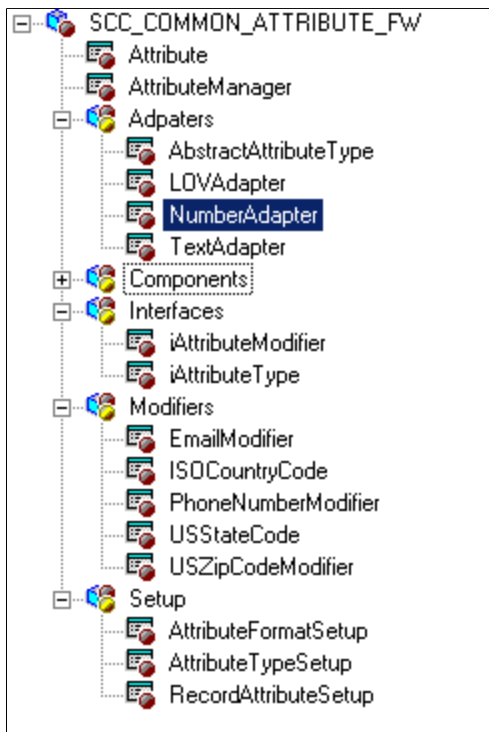

Using and Creating an Attribute Filter Class

An attribute filter class can be used to control the availability of attributes in a transaction page. You can specify the attribute filter class in the Record Context page.

The Common Attribute Framework creates an instance of this class at runtime and accesses its EntityID property. All the attributes that are mapped with this entity ID in the Record Context page are available in the transaction page. Any attribute that does not have an entity association is also available.

Creating an Attribute Filter Class

Attribute Filter classes must implement the interface `SCC_COMMON_ATTRIBUTE_FW:Interfaces:iAttributeFilter`. Implementing teams can then code the getter method of EntityID property to return a value based on any runtime data like component buffer values or external table values.

Here is an example of an attribute filter class:

```
import SCC_COMMON_ATTRIBUTE_FW:Interfaces:iAttributeFilter;

class AIAFilter implements
SCC_COMMON_ATTRIBUTE_FW:Interfaces:iAttributeFilter

    property Record ParentRecord;

    property string EntityID get;

end-class;

get EntityID

    /+ Returns String +/

    /+ Extends/implements
SCC_COMMON_ATTRIBUTE_FW:Interfaces:iAttributeFilter.EntityID +/

    rem Local Rowset &rs = GetLevel0() (1).GetRowset(Scroll.SSR_AIR_HDR);

    Local Record &rec = CreateRecord(Record.SSR_ITEM_TYPE);

    rem &rec.SSR_ITEM_TYPE.Value =
&rs(CurrentRowNumber(&rs.Level)).SSR_AIR_HDR.SSR_ITEM_TYPE.Value;

    &rec.SSR_ITEM_TYPE.Value = &ParentRecord.SSR_ITEM_TYPE.Value;

    &rec.SelectByKey();

    Return &rec.SCC_ENTITY_ID.Value;

end-get;
```

The property `ParentRecord` is populated by the framework with the runtime component buffer object of the parent record. This object can then be used to access other records, rows, rowsets, and so on from the component buffer thereby giving access to any field value in the runtime component.

Common Attribute Framework Application Class Reference

This section discusses the application classes that you can use for accessing and manipulation of attributes through PeopleCode.

Attribute Manager

```
class SCC_COMMON_ATTRIBUTE_FW:AttributeManager
```

This class provides a set of utility methods that can be used to fetch relevant attributes. This class behaves as a sort of object factory that provides attribute objects.

Summary

Constructor Summary

Access Control	Details
public	AttributeManager ()

Method Summary

Access Control	Details
public boolean	deleteAllAttributes (Record p_parentRec) Deletes all attributes associated with a record
public array of Attribute	getActiveRecordAttributes (Record p_parentRec) Returns all active attributes associated with a record
public Attribute	getAttributeFromChildRecord (Record p_childRec) Returns an Attribute object based on the attribute record
public any	getAttributeValue (Record p_rec, string p_AttributeName) Returns the value of an attribute from the child record based on the name of the attribute provided
public array of Attribute	getFilteredRecordAttributes(Record p_parentRec, string p_EntityID) Returns all attributes associated with a record filtered by Entity ID

Access Control	Details
public Attribute	getRecordAttribute (Record p_parentRec, string p_AttributeName) Returns attribute associated with a record
public array of Attribute	getRecordAttributes (Record p_parentRec) Returns all attributes associated with a record
public array of Attribute	getRecordAttributesV2 (Record p_parentRec) Returns all attributes associated with a record
public void	setAttributeToChildRecord (Record p_childRec out, Attribute p_Attribute) Sets the correct field in the record with value in the Attribute Object
public void	setAttributeValue (Record p_rec out, string p_AttributeName, any p_AttributeValue) Sets the value of an attribute from the child record based on the name of the attribute provided

Detail

Constructor Detail

Access Control	Details
public	AttributeManager ()

Method Detail

Method	Details
deleteAllAttributes	<p>public boolean deleteAllAttributes (Record p_parentRec)</p> <p>Deletes all attributes associated with a record.</p> <p>Parameters:</p> <p>p_parentRec - The record which has been extended with attributes.</p> <p>Returns:</p> <p>boolean</p>
getActiveRecordAttributes	<p>public boolean deleteAllAttributes (Record p_parentRec)</p> <p>Returns all active attributes associated with a record</p> <p>Parameters:</p> <p>p_parentRec - The record which has been extended with attributes.</p> <p>Returns:</p> <p>Array of Attribute</p>
getAttributeFromChildRecord	<p>public Attribute getAttributeFromChildRecord (Record p_childRec)</p> <p>Returns an Attribute object based on the attribute record.</p> <p>Parameters:</p> <p>p_childRec - The record populated with data from a row in the attribute child record containing the subrecord SCC_CAF_SBR.</p> <p>Returns:</p> <p>Attribute</p>

Method	Details
getAttributeValue	<p>public any getAttributeValue (Record p_rec, string p_AttributeName)</p> <p>Returns the value of an attribute from the child record based on the name of the attribute provided.</p> <p>Parameters:</p> <ul style="list-style-type: none"> • p_rec - The record populated with data from a row in the attribute child record containing the subrecord SCC_CAF_SBR. • p_AttributeName - Name of the attribute as string. <p>Returns:</p> <p>any</p>
getFilteredRecordAttributes	<p>public boolean deleteAllAttributes (Record p_parentRec)</p> <p>Returns all attributes associated with a record filtered by entity ID.</p> <p>Parameters:</p> <ul style="list-style-type: none"> • p_parentRec - The record which has been extended with attributes. • string p_EntityID <p>Returns:</p> <p>Array of Attribute</p>
getRecordAttribute	<p>public Attribute getRecordAttribute (Record p_parentRec, string p_AttributeName)</p> <p>Returns attribute associated with a record.</p> <p>Parameters:</p> <ul style="list-style-type: none"> • p_parentRec - The record which has been extended with attributes. • p_AttributeName - Name of the attribute as string. <p>Returns:</p> <p>Attribute</p>

Method	Details
getRecordAttributes	<p>public array of Attribute getRecordAttributes (Record p_parentRec)</p> <p>Returns all attributes associated with a record.</p> <p>Parameters:</p> <p>p_parentRec - The record which has been extended with attributes.</p> <p>Returns:</p> <p>array of Attribute</p>
getRecordAttributesV2	<p>public array of Attribute getRecordAttributesV2 (Record p_parentRec)</p> <p>Returns all attributes associated with a record.</p> <p>Parameters:</p> <p>p_parentRec - The record which has been extended with attributes.</p> <p>Returns:</p> <p>array of Attribute</p>
setAttributeToChildRecord	<p>public void setAttributeToChildRecord (Record p_childRec out, Attribute p_Attribute)</p> <p>Sets the correct field in the record with value in the Attribute Object.</p> <p>Parameters:</p> <ul style="list-style-type: none"> • p_childRec - The record populated with data from a row in the attribute child record containing the subrecord SCC_CAF_SBR. • p_Attribute - Instantiated Attribute Object.

Method	Details
setAttributeValue	<p>public void setAttributeValue (Record p_rec out, string p_AttributeName, any p_AttributeValue)</p> <p>Sets the value of an attribute from the child record based on the name of the attribute provided.</p> <p>Parameters:</p> <ul style="list-style-type: none"> • p_rec - The record populated with data from a row in the attribute child record containing the subrecord SCC_CAF_SBR. • p_AttributeName - Name of the attribute as string. • p_AttributeValue - Value of the attribute; data type depends on the attribute type.

Class Attribute

```
class SCC_COMMON_ATTRIBUTE_FW:Attribute
```

This class encapsulates all the basic properties and behavior of an attribute. It is possible to manipulate an attribute using its various methods.

Summary

Property Summary

Access Control	Property
public Array of string	arrRequestKeyField
public iAttributeModifier	AttributeModifier
public iAttributeType	AttributeType
public Record	DataRecord
public string	DataType readonly
public string	DESCR
public string	FIELDNAME

Access Control	Property
public string	FormattedValue
public Boolean	HasLOV
public Boolean	isRepeatable
public Boolean	isRequired
public StringHashMap	LOVKeys
public string	RECNAME
public string	SCC_APPCLASSNAME
public string	SCC_CAF_ALLOW_BLNK
public string	SCC_CAF_ALLOW_MULT
public string	SCC_CAF_ATR_FORMAT
public number	SCC_CAF_ATTR_DEC
public string	SCC_CAF_ATTR_DEF
public number	SCC_CAF_ATTR_INT
public string	SCC_CAF_ATTR_TYPE
public string	SCC_CAF_ATTRIB_NM
public string	SCC_CAF_FIELDNAME
public string	SCC_SL_LOV_CONTEXT
public Boolean	SelfServiceMode
public any	Value

Constructor Summary

Access Control	Details
public	Attribute (string p_SCC_CAF_ATTRIB_NM, Record p_rec) Constructor

Method Summary

Access Control, Type	Details
public void	close ()
public boolean	delete (MessageLogBase p_msg out) Deletes the attribute from the backend table.
public string	format (any p_value) This method contains logic related to formatting of the attribute data. This is driven by the attribute type associated with the attribute. If a modifier or validator class is associated with this attribute then the format method in that class is invoked instead. Value passed in as parameter is validated in this method. This is useful for validating data in a field in the component buffer.
public StringHashMap	getListOfValues () Returns the list of values (code and description pair) associated with this attribute.
public void	init (Record p_rec) This methods contains logic to initialize properties and variables. This is called by the framework after the object is created.
public boolean	save (MessageLogBase p_msg out) Saves the attribute to the backend table.
public void	setDefault () This methods contains logic to initialize attribute data with default values.

Access Control, Type	Details
public boolean	<p>validate (MessageLogBase p_msg out)</p> <p>This method contains validation logic. Validations are driven by the attribute type associated with the attribute. If a modifier or validator class is associated with this attribute then the validate method in that class is invoked instead. Value of the attribute is validated in this method.</p>
public boolean	<p>validateValue (any p_value, MessageLogBase p_msg out)</p> <p>This method contains validation logic. Validations are driven by the attribute type associated with the attribute. If a modifier or validator class is associated with this attribute then the validate method in that class is invoked instead. Value passed in as parameter is validated in this method. This is useful for validating data in a field in the component buffer.</p>

Detail

Property Detail

Property	Details
arrRequestKeyField	public Array of string
AttributeModifier	public iAttributeModifier
AttributeType	public iAttributeType
DataRecord	public Record
DataType	readonly public string
DESCR	public string
FIELDNAME	public string
FormattedValue	public string
HasLOV	public boolean

Property	Details
isRepeatable	public boolean
isRequired	public boolean
LOVKeys	public StringHashMap
RECNAME	public string
SCC_APPCLASSNAME	public string
SCC_CAF_ALLOW_BLNK	public string
SCC_CAF_ALLOW_MULT	public string
SCC_CAF_ATR_FORMAT	public string
SCC_CAF_ATTR_DEC	public number
SCC_CAF_ATTR_DEF	public string
SCC_CAF_ATTR_INT	public number
SCC_CAF_ATTR_TYPE	public string
SCC_CAF_ATTRIB_NM	public string
SCC_CAF_FIELDNAME	public string
SCC_SL_LOV_CONTEXT	public string
SelfServiceMode	public boolean
Value	public any

Constructor Detail

<p>Attribute</p>	<p>public Attribute (string p_SCC_CAF_ATTRIB_NM, Record p_rec)</p> <p>Constructor</p> <p>Parameters:</p> <ul style="list-style-type: none"> • p_SCC_CAF_ATTRIB_NM - Name of the attribute. • p_rec - Data record of the attribute containing the SCC_CAF_SBR subrecord.
------------------	---

Method Detail

Method	Details
<p>delete</p>	<p>public boolean delete (MessageLogBase p_msg out)</p> <p>Deletes the attribute from the backend table.</p> <p>Parameters:</p> <p>p_msg</p> <p>Returns:</p> <p>boolean</p>
<p>format</p>	<p>public string format (any p_value)</p> <p>This method contains logic related to formatting of the attribute data. This is driven by the attribute type associated with the attribute. If a modifier or validator class is associated with this attribute then the format method in that class is invoked instead. Value passed in as parameter is validated in this method. This is useful for validating data in a field in the component buffer.</p> <p>Parameters:</p> <p>p_value - The value to be formatted.</p> <p>Returns:</p> <p>string</p>

Method	Details
getListOfValues	<p>public StringHashMap getListOfValues ()</p> <p>Returns the list of values (code and description pair) associated with this attribute.</p> <p>Returns:</p> <p>StringHashMap</p>
init	<p>public void init (Record p_rec)</p> <p>This method contains logic to initialize properties and variables. This is called by the framework after the object is created.</p> <p>Parameters:</p> <p>p_rec - Record containing the SCC_CAF_SBR subrecord.</p>
save	<p>public boolean save (MessageLogBase p_msg out)</p> <p>Saves the attribute to the backend table.</p> <p>Parameters:</p> <p>p_msg</p> <p>Returns:</p> <p>boolean</p>
setDefault	<p>public void setDefault ()</p> <p>This method contains logic to initialize attribute data with default values.</p>

Method	Details
validate	<p>public boolean validate (MessageLogBase p_msg out)</p> <p>This method contains validation logic. Validations are driven by the attribute type associated with the attribute. If a modifier or validator class is associated with this attribute then the validate method in that class is invoked instead. Value of the attribute is validated in this method.</p> <p>Parameters:</p> <p>p_msg - This object is populated with any validation messages generated in the method.</p> <p>Returns:</p> <p>boolean</p>
validateValue	<p>public boolean validateValue (any p_value, MessageLogBase p_msg out)</p> <p>This method contains validation logic. Validations are driven by the attribute type associated with the attribute. If a modifier or validator class is associated with this attribute then the validate method in that class is invoked instead. Value passed in as parameter is validated in this method. This is useful for validating data in a field in the component buffer.</p> <p>Parameters:</p> <ul style="list-style-type: none"> • p_value - The value to be validated. • p_msg - This object is populated with any validation messages generated in the method. <p>Returns:</p> <p>boolean</p>

Adding Common Attributes to Effective Dated Tables

When adding a SCC_CAF_LAUNCH_SBP subpage to an effective dated table, you must add a PeopleCode snippet that ensures copying of forward field values onto a new effective dated row, when a new row is inserted into the scroll area.

Using PeopleCode to copy forward default values

The following code samples illustrate the enabling of the copy forward of values onto a newly inserted effective dated row, using either inline code or an application class. While both options deliver the same result, you may select the code which provides you with the smaller footprint.

Inline Code example

The following inline code example uses the Academic Structure, Academic Plan Table ACAD_PLAN_TBL record and page.

On the SCC_CAF_LAUNCH_SBP subpage, in the **RowInsert** event of the CAF-enabled record, set the RowInserted property to *True*. We recommend you add the following inline code in the Component Record PeopleCode:

```
import SCC_COMMON_ATTRIBUTE_FW:Components:SCC_CAF_LAUNCH_SBP;
Component SCC_COMMON_ATTRIBUTE_FW:Components:SCC_CAF_LAUNCH_SBP &pop;
&pop.RowInserted = True;
```

This example illustrates using inline code on the SCC_CAF_LAUNCH_SBP subpage.

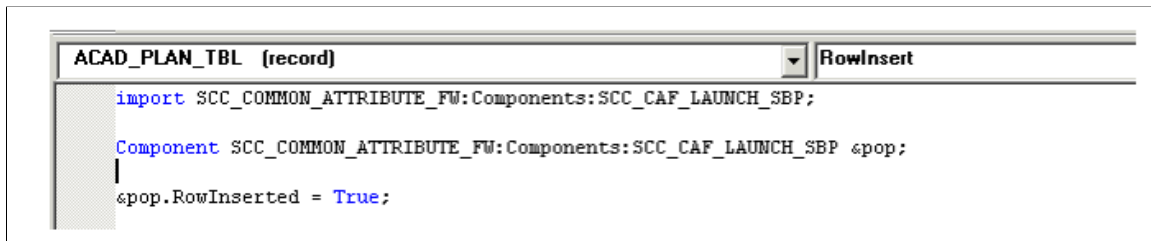

```
ACAD_PLAN_TBL (record) RowInsert
import SCC_COMMON_ATTRIBUTE_FW:Components:SCC_CAF_LAUNCH_SBP;
Component SCC_COMMON_ATTRIBUTE_FW:Components:SCC_CAF_LAUNCH_SBP &pop;
&pop.RowInserted = True;
```

Application Class Code Example

On the SCC_CAF_LAUNCH_SBP subpage, in the **RowInsert** event of the CAF-enabled record, set the RowInserted property to *True*. We recommend this method if other Component PeopleCode has been administered or is to be administered in a dedicated Application Class.

1. Set the RowInserted property by adding a new method to either to an existing application class or to a new application class. In this example, the method is added to SSR_COMMON_UTILITIES:COMPONENTS.

```
import SCC_COMMON_ATTRIBUTE_FW:Components:SCC_CAF_LAUNCH_SBP;
Class ACAD_PLAN_TBL
Method ACAD_PLAN_TBL_RowInsert();
End-class;

Component SCC_COMMON_ATTRIBUTE_FW:Components:SCC_CAF_LAUNCH_SBP &pop;
method ACAD_PLAN_TBL_RowInsert
&pop.RowInserted = True;
end-method;
```

This example illustrates using application class code on the SCC_CAF_LAUNCH_SBP subpage.

```

ACAD_PLAN_TBL (application_class)

import SCC_COMMON_ATTRIBUTE_FW:Components:SCC_CAF_LAUNCH_SBP;

class ACAD_PLAN_TBL
    method ACAD_PLAN_TBL_RowInsert();
end-class;

Component SCC_COMMON_ATTRIBUTE_FW:Components:SCC_CAF_LAUNCH_SBP &pop;

method ACAD_PLAN_TBL_RowInsert
    &pop.RowInserted = True;
end-method;

```

2. Call the new method in the record's RowInsert event.

```

import SSR_COMMON_UTILITIES:Components:ACAD_PLAN_TBL;
Component SSR_COMMON_UTILITIES:Components:ACAD_PLAN_TBL &acadPlan;
&acadPlan.ACAD_PLAN_TBL_RowInsert();

```

This example illustrates using application class code on the SCC_CAF_LAUNCH_SBP subpage.

```

ACAD_PLAN_TBL (record)

import SSR_COMMON_UTILITIES:COMPONENTS:ACAD_PLAN_TBL;

Component SSR_COMMON_UTILITIES:COMPONENTS:ACAD_PLAN_TBL &acadPlan;

&acadPlan.ACAD_PLAN_TBL_RowInsert();

```

Using the Shopping Cart Framework

Understanding the Shopping Cart Framework

Note: Technical developers, consultants and, implementers should use the information in this section to identify the skills that are required for implementing the framework and to determine the scope of data that the shopping cart web service operations can exchange between a self-service user interface (that the academic institution builds) and the PeopleSoft Campus Solutions system. The framework uses the Campus Community Entity Registry feature to perform the data exchange and PeopleTools Integration Broker for the web services. Business and functional analysts should use this documentation to understand how the generic Shopping Cart framework functions.

The Shopping Cart framework provides the generic SCC_SHOPPING_CART service. You can use this service to implement a shopping cart for any Campus Solutions feature.

Like the other Campus Community frameworks, such as List of Values and Entity Registry, the Shopping Cart framework can be used by all Campus Solutions applications. Therefore, the Campus Solutions system maintains the framework code separately as Campus Community shared components. Examples of Campus Solutions applications include Campus Community, Financial Aid, Student Records, Recruiting and Admissions, and Student Financials.

The benefits of using the Shopping Cart framework include:

- Your effort in building a shopping cart for a Campus Solutions application or a feature is greatly reduced.

The Shopping Cart framework supports the functionality common to all shopping carts, such as adding items, checking out items, and so on. With the framework already supporting the common functionality, your technical staff can focus their efforts in implementing user interfaces that use this framework.

- You can improve the code maintenance.

For example, multiple shopping carts for various Campus Solutions applications or features can use the same Shopping Cart framework code. Therefore, with this framework, you are not repeating the code that is common to all shopping carts.

- A Campus Solutions application or feature can store the shopping cart data in its own tables, and add, delete, or modify this data.
- A shopping cart specific to an application or feature can have its own business logic.

For example, you could add your own logic to validate whether the items, which the user wants to add to a shopping cart, satisfy certain conditions.

The following table lists the service operations for the SCC_SHOPPING_CART service.

Service Operation	Operation Description	Request Message	Response Message
SCC_SC_ADDITEM	Add an item to the cart	SCC_SC_ADDITEM_REQ	SCC_SC_ADDITEM_RESP
SCC_SC_CLEARCART	Clears the cart	SCC_SC_CLEARCART_REQ	SCC_SC_CLEARCART_RESP
SCC_SC_GETCART	Get cart request.	SCC_SC_GETCART_REQ	SCC_SC_GETCART_RESP
SCC_SC_GETITEM	Get an item from the cart.	SCC_SC_GETITEM_REQ	SCC_SC_GETITEM_RESP
SCC_SC_REMOVEITEM	Remove an item from the cart.	SCC_SC_REMOVEITEM_REQ	SCC_SC_REMOVEITEM_RESP
SCC_SC_SAVECART	Save the cart.	SCC_SC_SAVECART_REQ	SCC_SC_SAVECART_RESP
SCC_SC_VALIDATE	Validate cart item.	SCC_SC_VALIDATE_REQ	SCC_SC_VALIDATE_RESP
SCC_SC_CHECKOUT	Check out from the cart.	SCC_SC_CHECKOUT_REQ	SCC_SC_CHECKOUT_RESP

Note: The service operations listed in the preceding table are synchronous. These service operations use the SCC_FAULT_RESP message to return the error messages to the online user interface. The SCC_FAULT_RESP message is not part of the Shopping Cart framework, but is a common fault response message owned by Campus Community which any service operation could use to define fault response.

Assessing Staff Skills

Developers working on the implementation of shopping cart should have strong skills in:

- A tool or technology to build and deploy a user interface, especially if you want to create the user interface outside of the PeopleSoft Campus Solutions system using a language different than PeopleTools.
- PeopleSoft Integration Broker.
- PeopleCode.
- Web services concepts mainly XML, SOAP, and WSDL.
- Campus Community Entity Registry functionality.

Shopping Cart Service Operations

This section discusses the shopping cart service operations.

SCC_SC_ADDITEM

This service operation adds a single or multiple items to a user's shopping cart. The operation adds the items to the item table specific to the Campus Solutions application implementing the shopping cart.

The service operation first checks if the item, which the user wants to add, already exists in the cart. If the item already exists, the operation deletes the item from the cart and then adds the item as a new item to the cart. Therefore, a user interface can also use this operation to update an existing cart item.

Once the item is added to the cart, the service operation retrieves all the cart items for the user and sends them back in the response message.

Example: Suppose your institution has an enrollment shopping cart. A student can use this enrollment shopping cart to add the classes in which he or she wants to enroll. The enrollment shopping cart uses the SCC_SC_ADDITEM operation to add a class to the enrollment shopping cart item table.

Example when a shopping cart can use SCC_SC_ADDITEM to modify an existing item: Suppose a student wants to change an enrollment option. For example, the student wants to change the *Units* for an item that has already been added to the enrollment shopping cart. The student can add the same item with a changed value for *Units*. In this case, SCC_SC_ADDITEM deletes the existing item and adds it again with the new value for *Units*.

SCC_SC_CLEARCART

This service operation deletes all the items from the cart for a user. The operation deletes the items from the item table specific to the Campus Solutions application implementing the shopping cart.

Example: A student deletes all the classes that he or she added previously to the enrollment shopping cart. In such a case, the enrollment shopping cart uses the SCC_SC_CLEARCART operation to delete all the classes added by the student.

SCC_SC_GETCART

This service operation retrieves all the items added to the shopping cart for a user. The operation retrieves the items from the item table specific to the Campus Solutions application implementing the shopping cart.

Example: A student accesses the enrollment shopping cart to make additional changes. The shopping cart displays all the classes that the student had previously entered. In such a case, the enrollment shopping cart uses the SCC_SC_GETCART operation to retrieve all the classes that the user had previously added to the enrollment shopping cart.

SCC_SC_GETITEM

This service operation retrieves a particular item from the shopping cart for a user, based on an index number. The index number is a numeric value that represents the position of an item in the cart.

A user interface can send the index number as a request parameter to this service operation. The service operation then uses the index number to retrieve the appropriate item from the cart. The operation first validates the index number and then retrieves the item only if it is a valid index number. If index number is not valid, the operation sends back an error message to the user interface stating that the index number is invalid.

For instance, if the index number in the request message passed to this service operation is greater than the number of items in the cart, then an error message is sent back to the user interface.

Example: A student wants to review details of a specific class that he or she had previously added to the enrollment shopping cart. To review the class details, the student clicks the class number link. In such a case, the enrollment shopping cart feature uses the `SCC_SC_GETITEM` operation to retrieve the details of the particular class.

The user interface could initially use the `SCC_SC_GETCART` operation to display only the basic information (for example, Class Nbr) for all the cart items (academic classes). To get more information about the classes, the student can click any class number. When the student clicks a class number, the user interface can use the `SCC_SC_GETITEM` operation to retrieve and display the complete information for that item.

SCC_SC_REMOVEITEM

This service operation removes a single or multiple items from the shopping cart for a user.

Once the item is removed from the cart, the service operation retrieves all the remaining cart items for the user and sends them back in the response message. In other words, the response message contains the remaining cart items. However, the response message is blank if the cart is empty after the removal of an item.

Example: A student deletes one or more classes from the enrollment shopping cart. In such a case, the enrollment shopping cart uses the `SCC_SC_REMOVEITEM` operation to remove a class from the enrollment shopping cart.

SCC_SC_SAVECART

This service operation saves a single or multiple items to the cart for a user. The service operation first deletes all the items in the cart for the user and then adds the new items to the cart.

Once the items are saved to the cart, the service operation retrieves all the cart items for the user and sends them back in the response message. In other words, if an error does not occur, the response message contains all the cart items.

There is a difference between `SCC_SC_ADDITEM` and `SCC_SC_SAVECART`. If an item already exists in the cart and the user adds it again, `SCC_SC_ADDITEM` first removes the item from the table and then adds the item again. `SCC_SC_SAVECART` first deletes all the existing cart items and then adds all the items that are in the request message.

Example: A student uses the enrollment shopping cart to clear all the existing cart items and then adds the new classes in which he or she wants to enroll. After adding the new classes, the student clicks the save link. In such a case, the enrollment shopping cart uses the `SCC_SC_SAVECART` operation to first remove the existing cart items and then add the new classes to the enrollment shopping cart item table.

SCC_SC_VALIDATE

This service operation validates the items in the cart for a user. A user interface can use this operation to validate a single or multiple items in the cart. The validation results of all the items indicating a success or failure is sent back in the response message.

Example: A student adds three classes to the enrollment shopping cart. Before the student checks out these classes, the user interface validates the class choices. After validation, the user interface determines that the student is eligible to enroll only in one specific class. The enrollment shopping cart uses the `SCC_SC_VALIDATE` operation to perform such a pre enrollment validation.

The `SCC_SC_VALIDATE` operation enables a user interface to first validate the classes that exist in the enrollment shopping cart, before the user interface invokes the `SCC_SC_CHECKOUT` operation to enroll the student in the classes. On successful validation of the class, the `SCC_SC_VALIDATE` operation sends back a response message: *OK to Add*. If any error occurs during validation, the response message contains the appropriate error message.

Note: The validation code should be specific to the shopping cart feature that you are implementing. Therefore, whoever implements a shopping cart needs to create feature-specific validation logic as part of the adopting feature's application class. In the preceding example, the enrollment validation logic is not part of the Shopping Cart framework. We have incorporated this enrollment validation logic in the `CourseShoppingCart` application class, `validateCart` method (part of `SSR_COURSE` application package). This class and method are specific to the enrollment shopping cart. The `validateCart` method executes when the enrollment shopping cart user interface invokes the `SCC_SC_VALIDATE` service operation.

SCC_SC_CHECKOUT

This service operation checks out the items that the user has added to the cart. A user interface can use this operation for a single or multiple cart items. The service operation sends back a response message indicating success or failure.

Example: After adding all the desired classes to the enrollment shopping cart, the student confirms his or her choices by checking out the items. The enrollment shopping cart uses the `SCC_SC_CHECKOUT` operation to check out (enroll) the classes added to the enrollment shopping cart. On successful enrollment, the response message returns the following message to the student: *The class has been added to your schedule*. If any error occurs during enrollment, the response message contains the appropriate error message.

Note: The checkout code should be specific to the shopping cart feature that you are implementing. Therefore, whoever implements a shopping cart needs to create feature-specific checkout logic as part of the adopting feature's application class. In the preceding example, the enrollment checkout logic is not part of the Shopping Cart framework. We have incorporated this enrollment checkout logic in the `CourseShoppingCart` application class, `purchase` method (part of `SSR_COURSE` application package). This class and method are specific to the enrollment shopping cart. The `purchase` method executes when the enrollment shopping cart user interface invokes the `SCC_SC_CHECKOUT` service operation.

Shopping Cart Framework APIs

This section discusses the classes that you can use for implementing a shopping cart.

The Shopping Cart framework supports a set of Application Programming Interfaces (APIs) that comprise the functionality common to all shopping carts. These APIs are application classes. These APIs exist in the `SCC_COMMON` application package as shown in the following diagram:

This example illustrates the fields and controls on the Shopping cart APIs in the SCC_COMMON application package. You can find definitions for the fields and controls later on this page.

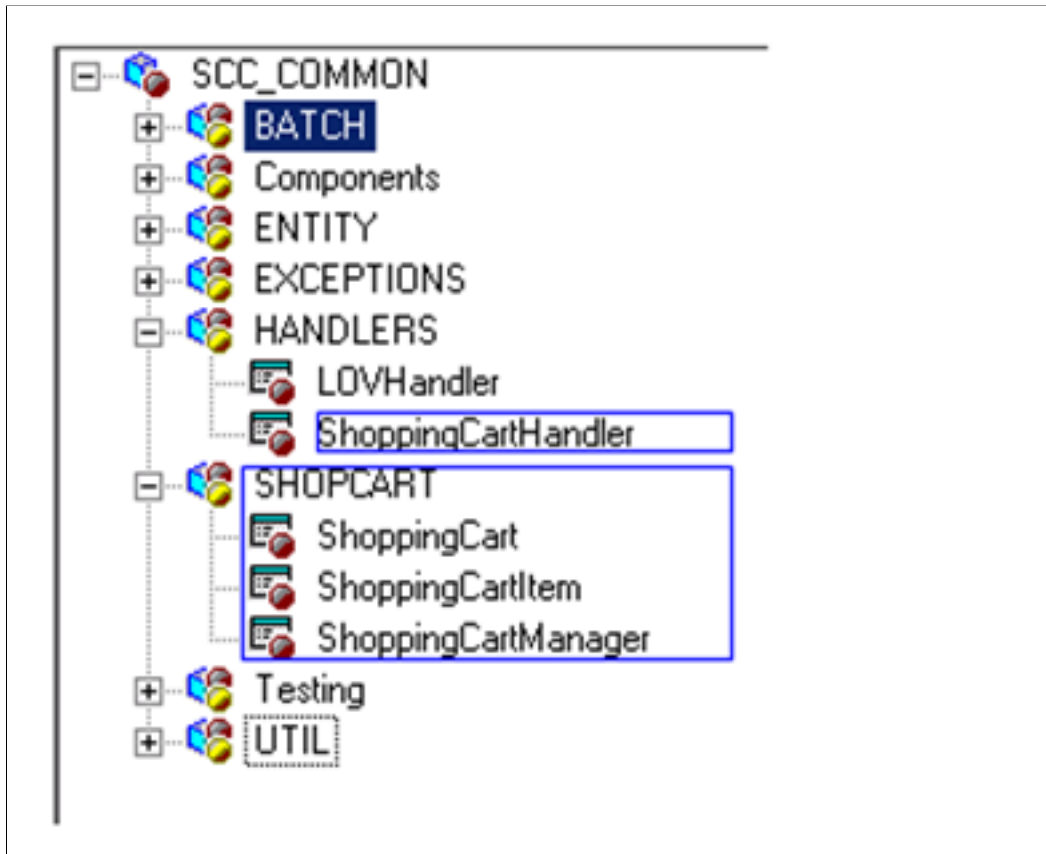

The following diagram shows the delivered enrollment shopping cart implementation. This implementation uses the Shopping Cart framework, and the delivered CourseShoppingCart and CourseShoppingCartItem entities.

This example illustrates the fields and controls on the Example of a delivered shopping cart implementation. You can find definitions for the fields and controls later on this page.

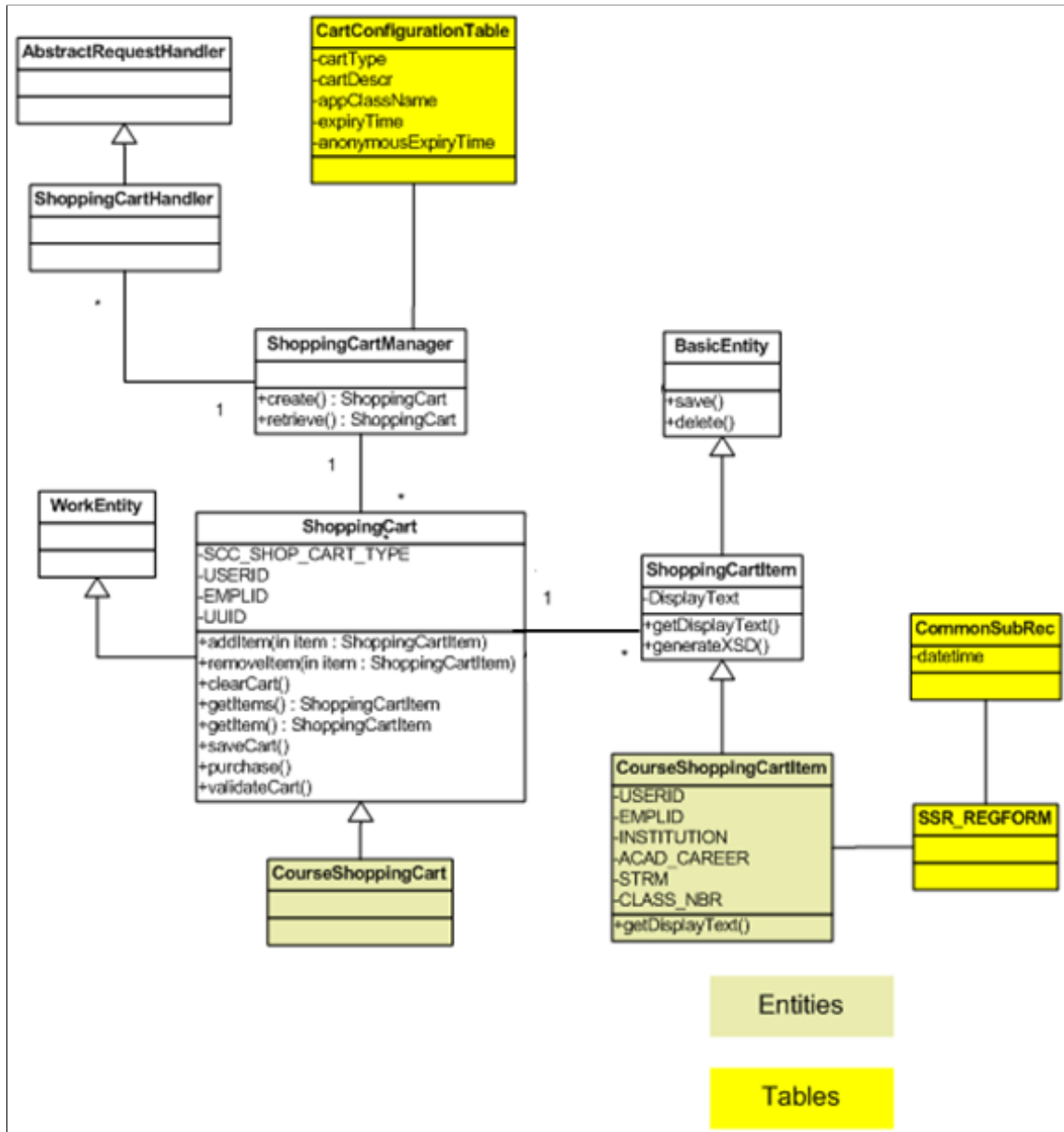

The following table describes the delivered classes that are shown in the preceding diagram.

Classes/Tables	Description
CartConfigurationTable	This table contains details about the available carts and the implementation classes that support these carts. The database table for CartConfigurationTable is SCC_SHOPCART.

Classes/Tables	Description
ShoppingCartHandler	This class is the only web service handler that the system needs to drive the shopping cart. To access the Shopping Cart framework, all the web services will use this web service handler. This class is part of the SCC_COMMON application package.
ShoppingCartManager	The generic handler class uses the ShoppingCartManager core class to create and return the appropriate entity specific to the Campus Solutions application. Additionally, a user interface can use the ShoppingCartManager class to retrieve the items from a cart specific to the Campus Solutions application. This class is part of the SCC_COMMON application package.
ShoppingCart	<p>This core class contains the common functions available to all carts. Note that we have modeled this class as a WorkEntity and therefore, this class does not require real database persistence (table). The feature, adopting the Shopping Cart framework, must extend this class. This class is part of the SCC_COMMON package.</p> <hr/> <p>Note: The purchase() & validateCart() methods, which are used by the SCC_SC_CHECKOUT and SCC_SC_VALIDATE service operations respectively, are defined as abstract in the ShoppingCart class. Therefore, you must provide the implementation code in the adopting class.</p> <hr/>
ShoppingCartItem	The adopting feature must extend this core class to hold any items in the cart. Note that we have modeled this class as a BasicEntity having a real underlying database table that contains the cart items. This class is part of the SCC_COMMON package.
BasicEntity	You must create the adopting feature entity with an entity type set to ShoppingCartItem. We have defined this type with the base application class called SCC:COMMON:SHOPCART:ShoppingCartItem. This base class extends the SCC_COMMON:ENTITY:BasicEntity application class. Therefore, when creating a shopping cart, you create an application class that extends the BasicEntity class. The BasicEntity class is part of the SCC_COMMON package.
CommonSubRecord	This is a table that contains the Shopping Cart framework's common fields that any adopting feature's item table should include. This enables the cart to track the common system data, with no effort from the adopting feature. The database table for CommonSubRecord is SCC_SHOPCART_SBR.

Classes/Tables	Description
CourseShoppingCart	<p>This class pertains to the implementation for enrollment shopping cart. This class is part of the SSR_COURSE application package.</p> <p>The CourseShoppingCart class extends the core ShoppingCart class. The CourseShoppingCart class contains the implementation for the purchase() & validateCart() methods that are abstract in the core ShoppingCart class.</p> <p>Note that the CourseShoppingCart class is attached to a work entity (SCC_SHOPCRT_WRK) because the class has nothing to save and therefore does not require a real database table.</p>
CourseShoppingCartItem	<p>This class pertains to the implementation for enrollment shopping cart (which is specific to the Student Records Campus Solutions application). This class is part of the SSR_COURSE application package. This class handles the storage of the enrollment shopping cart items (academic classes). The CourseShoppingCartItem entity is attached to the enrollment shopping cart item table (SSR_REGFORM) that holds the enrollment shopping cart items (academic classes).</p>
WorkEntity	<p>This class is extended by entities that have nothing to save, meaning they do not have a real underlying database table. The core ShoppingCart class extends WorkEntity. The WorkEntity class is part of the SCC_COMMON package.</p>

Defining a Shopping Cart

This section describes how to use the Shopping Cart framework as a base to create a shopping cart specific to a Campus Solutions application. The section uses the delivered enrollment shopping cart to show an example of how this is done.

This section discusses how to:

- Create application class.
- Set up entity registry.
- Generate code for application classes.
- Configure shopping cart.
- Generate a common XSD for the shopping carts.

Creating Application Classes

Create feature-specific shopping cart application classes to customize the business logic specific to the Campus Solutions application. At this stage, create only the application classes inside the proper application package. Add the PeopleCode at a later step.

Typically, any shopping cart feature would include XXXShoppingCart & XXXShoppingCartItem classes where XXX points to the specific feature for which the shopping cart is created (for example, Course and Student Financials). These are the application class names that you associate with the corresponding entities on the Entity Registry page in the next step.

The XXXShoppingCart class extends the core ShoppingCart class and contains the implementation code for the purchase() method. The SCC_SC_CHECKOUT service operation uses the purchase() method and the SCC_SC_VALIDATE service operation uses the validateCart() method. The system has defined the purchase() method and validateCart() method as abstract in the ShoppingCart base class. The XXXShoppingCart class can also override any other class provided by the base class for providing customized implementation specific to the Campus Solutions application.

The XXXShoppingCartItem class must point to the record where the system stores the shopping cart items.

For example, for the enrollment shopping cart we created the following two classes (APIs):

- CourseShoppingCart.
- CourseShoppingCartItem.

The following diagram shows that we have included both the classes inside the SSR_COURSE application package. This package is specific to the Campus Solutions Student Records application. The CourseShoppingCartItem class points to the SSR_REGFORM record. The system stores the cart items (academic classes in the case of enrollment shopping cart) in the SSR_REGFORM record.

This example illustrates the fields and controls on the Example of how you can create the classes for a shopping cart. You can find definitions for the fields and controls later on this page.

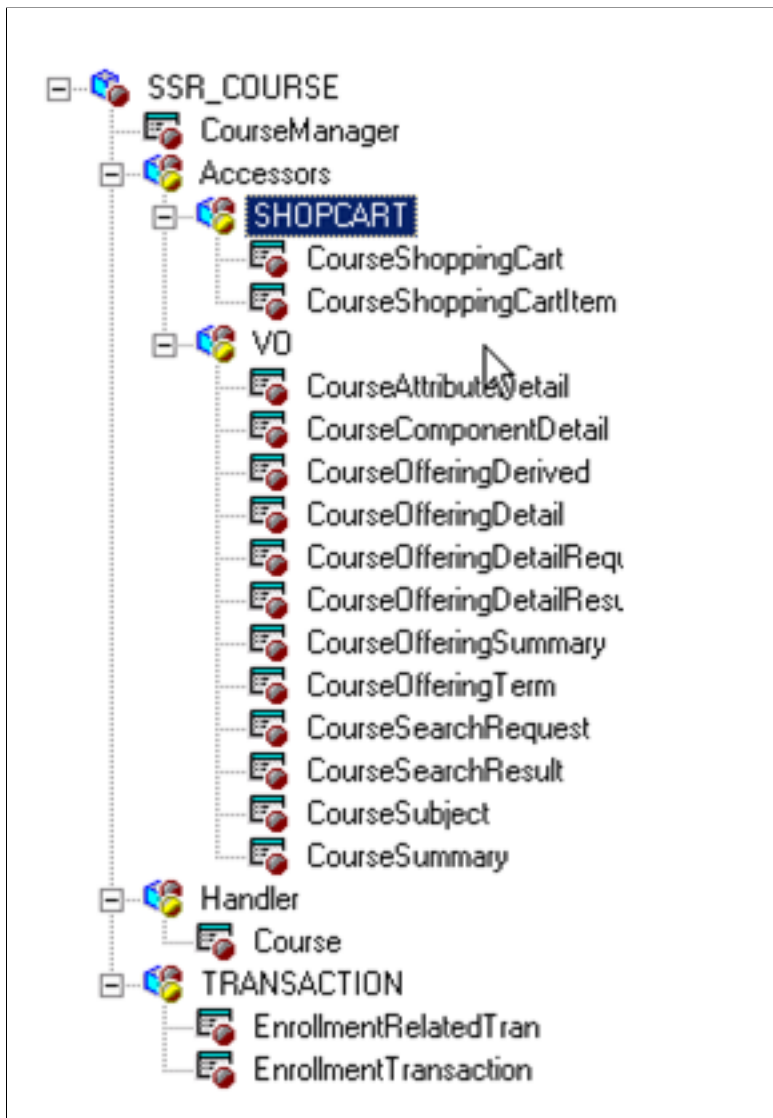

Setting Up Entity Registry

Access the Entity Registry page (**Set Up SACR > System Administration > Entity > Entity Registry**).

The Shopping Cart framework uses the Entity Registry component for processing shopping cart requests specific to the Campus Solutions application. Use the Entity Registry component to define entity registries for each application-specific cart.

See [Setting Up Entity Registry](#).

In the previous subsection (Creating Application Classes), we created two application classes: CourseShoppingCart and CourseShoppingCartItem. We now attach each of these classes to an entity. Access the Entity Registry component to create a parent and at least one child entity. Any entity structure for an application-specific shopping cart should include a parent class that extends the base ShoppingCart class. This parent class provides implementation for all of the service operations. The child class is

needed because it points to the actual application-specific cart item table. If the application-specific feature has multiple child item tables, then you should create entities for all children and also define the parent-child relationship in the Entity Registry component.

Create the parent entity with the following configuration:

- Specify the entity name as *XXXShoppingCart*.

This is similar to how you named the application class in the previous subsection. XXX refers to the feature for which you are creating a shopping cart.

- Select a value of *Shopping Cart* in the Entity Type field.
- For the AppClass field, select the application class you created in the previous subsection for *XXXShoppingCart*.
- For the Prod Record field, select the work record *SCC_SHOPCRT_WRK* because the entity has nothing to save.

This example shows the parent entity, named *CourseShoppingCart*, which we created for the enrollment shopping cart:

This example illustrates the fields and controls on the Configuration example of a parent entity (*CourseShoppingCart*). You can find definitions for the fields and controls later on this page.

Entity Registry

Entity Configuration

Entity ID:	SCC_ENTITY_20110324000733
Name:	<input type="text" value="CourseShoppingCart"/>
Status:	<input type="text" value="Active"/>
Entity Type:	<input type="text" value="Shopping Cart"/>
Description:	<input style="height: 60px;" type="text" value="The Course Shopping Cart"/>
*AppClass:	<input type="text" value="SSR_COURSE:Accessors:SHOPCART:CourseShoppingC"/> <input type="button" value="Q"/>
Prod Record:	<input type="text" value="SCC_SHOPCRT_WRK"/> <input type="button" value="Q"/>
Element (XML):	<input type="text" value="COURSE_SHOP_CART"/>
	<input type="checkbox"/> Apply Data Update Rule

Children							
Order	*Entity Name	Status	Embed	*Min	*Max	Element Wrapper (XML)	View
1	CourseShoppingCart <input type="button" value="Q"/>	Active	<input type="checkbox"/>	0	0	ITEMS <input type="text" value=""/>	View <input type="button" value="+"/> <input type="button" value="-"/>

Create the child entity with the following configuration:

- Specify the entity name as *XXXShoppingCartItem*.

This is similar to how you named the application class in the previous subsection. XXX refers to the feature for which you are creating a shopping cart.

- Select a value of *Shopping Cart Item* in the Entity Type field.
- For the AppClass field, select the application class you created in the previous subsection for *XXXShoppingCartItem*.
- For the Prod Record field, select the application-specific item table that holds the cart items.

This example shows the child entity, named *CourseShoppingCartItem*, which we created for the enrollment shopping cart:

This example illustrates the fields and controls on the Configuration example of a child entity (*CourseShoppingCartItem*). You can find definitions for the fields and controls later on this page.

Entity Registry

Entity Configuration

Entity ID: SCC_ENTITY_20110323235139

Name:

Status: Active ▼

Entity Type: Shopping Cart Item ▼

Description:

An Item in the Course Shopping Cart

*AppClass: 🔍

Prod Record: 🔍

Element (XML):

Apply Data Update Rule

Properties
Generate XSD
Generate Code
View Unit Tests
View Hierarchy

Children

Order	Entity Name	Status	Embed	*Min	*Max	Element Wrapper (XML)	View
	<input type="text" value=""/> 🔍		<input type="checkbox"/>	0	0	<input type="text" value=""/>	View + -

Parents

[CourseShoppingCart](#)

Note: The record you enter in the Prod Record field for the child entity must contain the SCC_SHOPCRT_SBR (*CommonSubRecord*) sub record. That is, you must include SCC_SHOPCRT_SBR in the application-specific item table. This enables the common system data to be tracked by the Shopping Cart framework without any effort from the adopting feature. The SCC_SHOPCRT_SBR sub record contains the Shopping Cart framework's common fields that an adopting feature should include.

The following example shows how you should create the production record for the child entity:

This example illustrates the fields and controls on the Example of a production record for a child entity. You can find definitions for the fields and controls later on this page.

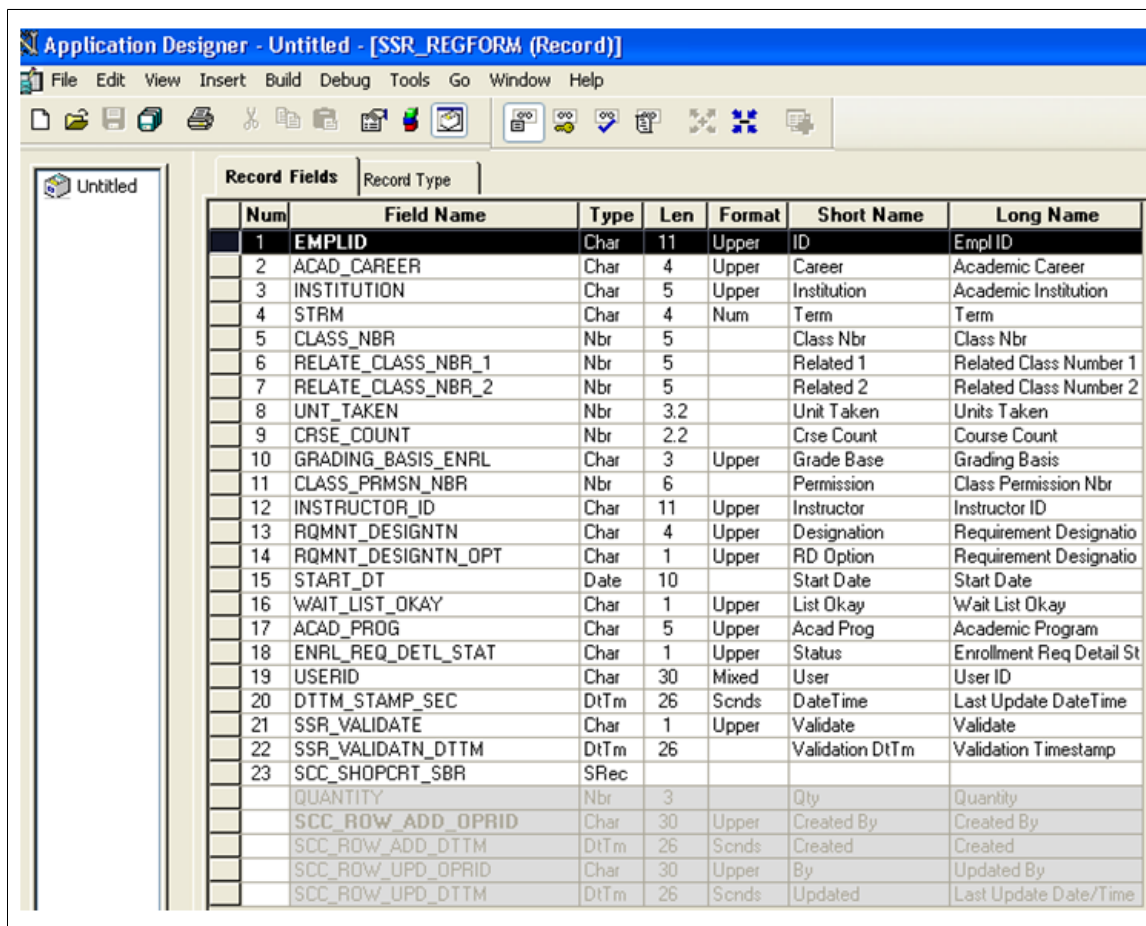

Num	Field Name	Type	Len	Format	Short Name	Long Name
1	EMPLID	Char	11	Upper	ID	Empl ID
2	ACAD_CAREER	Char	4	Upper	Career	Academic Career
3	INSTITUTION	Char	5	Upper	Institution	Academic Institution
4	STRM	Char	4	Num	Term	Term
5	CLASS_NBR	Nbr	5		Class Nbr	Class Nbr
6	RELATE_CLASS_NBR_1	Nbr	5		Related 1	Related Class Number 1
7	RELATE_CLASS_NBR_2	Nbr	5		Related 2	Related Class Number 2
8	UNT_TAKEN	Nbr	3.2		Unit Taken	Units Taken
9	CRSE_COUNT	Nbr	2.2		Crse Count	Course Count
10	GRADING_BASIS_ENRL	Char	3	Upper	Grade Base	Grading Basis
11	CLASS_PRMSN_NBR	Nbr	6		Permission	Class Permission Nbr
12	INSTRUCTOR_ID	Char	11	Upper	Instructor	Instructor ID
13	RQMNT_DESIGNTN	Char	4	Upper	Designation	Requirement Designatio
14	RQMNT_DESIGNTN_OPT	Char	1	Upper	RD Option	Requirement Designatio
15	START_DT	Date	10		Start Date	Start Date
16	WAIT_LIST_OKAY	Char	1	Upper	List Okay	Wait List Okay
17	ACAD_PROG	Char	5	Upper	Acad Prog	Academic Program
18	ENRL_REQ_DETL_STAT	Char	1	Upper	Status	Enrollment Req Detail St
19	USERID	Char	30	Mixed	User	User ID
20	DTM_STAMP_SEC	DtTm	26	Scnds	DateTime	Last Update DateTime
21	SSR_VALIDATE	Char	1	Upper	Validate	Validate
22	SSR_VALIDATN_DTTM	DtTm	26		Validation DtTm	Validation Timestamp
23	SCC_SHOPCRT_SBR	SRec				
	QUANTITY	Nbr	3		Qty	Quantity
	SCC_ROW_ADD_OPRID	Char	30	Upper	Created By	Created By
	SCC_ROW_ADD_DTTM	DtTm	26	Scnds	Created	Created
	SCC_ROW_UPD_OPRID	Char	30	Upper	By	Updated By
	SCC_ROW_UPD_DTTM	DtTm	26	Scnds	Updated	Last Update Date/Time

Generating Code for Application Classes

In the previous subsection (Setting Up Entity Registry), we created two entities and assigned the application classes to the entities. We now click the Generate Code button on the Entity Registry page to generate the code that can be pasted inside the PeopleCode of the application class.

To generate the code:

1. Access the Entity Registry page for the XXXShoppingCart and the XXXShoppingCartItem entities.
2. Click the Generate Code button.

3. Select the desired options and generate the code.

You can paste the generated code directly inside the application classes. You can also use the generated code as a template to add more logic as needed.

Configuring Shopping Cart

To register the application-specific shopping cart, access the Shopping Cart Configuration page (Set Up SACR, System Administration, Utilities, Shopping Carts, Shopping Cart).

This example illustrates the fields and controls on the Shopping Cart Configuration page. You can find definitions for the fields and controls later on this page.

Shopping Cart Configuration

*Shopping Cart Type

Description

Owner ID

*Entity ID CourseShoppingCart

<i>Field or Control</i>	<i>Description</i>
Owner ID	Because the Shopping Cart framework can be used by any Campus Solutions application, select the Campus Solutions application that owns the shopping cart you are creating.
Entity ID	Select the Entity ID of the parent entity that you created on the Entity Registry page.

On the Shopping Cart Configuration page, you attach the entity ID of an application-specific shopping cart to an application-specific shopping cart type. The shopping cart type represents the type of the application-specific shopping cart, and the entity ID represents the application-specific entity defined on the Entity Registry page.

Purpose of this configuration:

Because the Shopping Cart framework is generic, the service operation must know which application-specific shopping cart sent the request so that it can proceed with first building the appropriate entities that are specified on the Shopping Cart Configuration page and then start processing the request.

Each shopping cart request must contain a <SCC_SHOP_CART_TYPE> tag. The value of the tag indicates the shopping cart type that you have defined on the Shopping Cart Configuration page. Any shopping cart service operation upon receiving a request first reads the shopping cart type from the request. Once the service operation identifies the cart type, it then identifies the appropriate entities

attached to this cart type from the Shopping Cart Configuration page to perform the application-specific shopping cart processing.

Example for how the framework uses SCC_SHOP_CART_TYPE:

The enrollment shopping cart involves two entities: CourseShoppingCart and CourseShoppingCartItem. We have defined these entities on the Entity Registry page with CourseShoppingCart as the parent entity and CourseShoppingCartItem as the child entity. The shopping cart configuration for the enrollment shopping cart would therefore look as shown in the preceding screen shot titled *Shopping Cart Configuration page*.

Note that the shopping cart is *Course* in the screen shot for the enrollment shopping cart. Therefore, for example, when the enrollment shopping cart sends a request to add an item (academic class) to the enrollment shopping cart, the request must include the shopping cart type *Course*. The following is an example of a request XML code to add an item to the enrollment shopping cart:

This example illustrates the fields and controls on the Sample SCC_SC_ADDITEM_REQ.xml from the Enrollment shopping cart. You can find definitions for the fields and controls later on this page.

```
<?xml version="1.0"?>
<SCC_SC_ADDITEM_REQ xmlns="http://xmlns.oracle.com/Enterprise/HCM/services">
  <SHOPPING_CART>
    <COURSE_SHOP_CART>
      <SCC_SHOP_CART_TYPE>COURSE</SCC_SHOP_CART_TYPE>
    </COURSE_SHOP_CART>
  </SHOPPING_CART>
  <ITEMS>
    <ITEM>
      <SCC_ENTITY_INST_ID>ITEM ROW :1</SCC_ENTITY_INST_ID>
      <EMPLID>SR12030</EMPLID>
      <INSTITUTION>PSUNV</INSTITUTION>
      <ACAD_CAREER>UGRD</ACAD_CAREER>
      <STRM>0665</STRM>
      <CLASS_NBR>1014</CLASS_NBR>
      <WAIT_LIST_OKAY>N</WAIT_LIST_OKAY>
      <CLASS_PRMSN_NBR>0</CLASS_PRMSN_NBR>
      <GRADING_BASIS_ENRL></GRADING_BASIS_ENRL>
      <UNT_TAKEN>0</UNT_TAKEN>
      <INSTRUCTOR_ID></INSTRUCTOR_ID>
      <QMNT_DESIGNTN_OPT></QMNT_DESIGNTN_OPT>
      <START_DT></START_DT>
      <CRSE_COUNT>0</CRSE_COUNT>
      <ACAD_PROG></ACAD_PROG>
      <RELATE_CLASS_NBR_1>0</RELATE_CLASS_NBR_1>
      <RELATE_CLASS_NBR_2>0</RELATE_CLASS_NBR_2>
    </ITEM>
  </ITEMS>
</SCC_SC_ADDITEM_REQ>
```

Note that in the code example, the SCC_SHOP_CART_TYPE tag contains the *COURSE* value. The SCC_SC_ADDITEM service operation reads the cart type value of Course from the request. The operation then queries the Shopping Cart Configuration page to identify the entity appropriate for this cart

type (which is CourseShoppingCart for this example) and then proceeds with building the entity hierarchy for processing the enrollment shopping cart request.

Suppose if the <SCC_SHOP_CART_TYPE> had a value of StudentFinance. In such a case, the service operation builds the StudentFinanceShopCart entity and uses this entity for processing the Student Financials shopping cart request to add an item.

Therefore, depending on the <SCC_SHOP_CART_TYPE> value (for example, Course or StudentFinance) with which you have registered the application-specific entities on the Shopping Cart Configuration page, the service operation handler code builds the appropriate entities and uses these entities for further processing.

Generating a Common XSD for the Shopping Carts

The Shopping Cart framework uses a common schema that includes elements of all the entities that are defined in the shopping cart configuration table. The name of the common schema is SCC_ENTITY_SHOP_CART.xsd.

To generate the common schema for all the shopping carts:

1. Access the Entity Registry page for any parent entity of a shopping cart (**Set Up SACR > System Administration > Entity > Entity Registry**).
2. Click the Generate XSD button to generate the XSD.
3. Use the PeopleTools Schema page to access SCC_ENTITY_SHOP_CART.xsd (**PeopleTools > Integration Broker > Integration Setup > Messages > Schema**).
4. Paste the generated XSD into SCC_ENTITY_SHOP_CART.xsd.

For example, the enrollment shopping cart has two entities: CourseShoppingCart (parent) and CourseShoppingCartItem (child). Click the Generate XSD button on the Entity Registry page for the CourseShoppingCart entity. When you click this button, the system generates an XSD that contains elements of all the available shopping cart entities that you have defined on the Shopping Cart Configuration page.

Any shopping cart parent entity (for example, CourseShoppingCart) extends the ShoppingCart framework class. The ShoppingCart class overrides the base class generateXSD() method to generate a common XSD for all the available carts. You then need to replace the XSD in SCC_ENTITY_SHOP_CART.xsd with the XSD generated by clicking the Generate XSD button. Note that it is this common XSD that the system references in all the generic XSDs of the messages that are attached to the service operations.

Another example: We will use the message SCC_SC_ADDITEM_REQ.xsd that is attached to SCC_SC_ADDITEM service operation. Suppose you have used the Shopping Cart Configuration page to define two shopping carts. One is an enrollment shopping cart and another is Student Financials shopping cart.

You defined the entity registry setups for the enrollment and Student Financials shopping carts. The following is an example of the Entity Hierarchy Display page for the CourseShoppingCart entity:

This example illustrates the fields and controls on the Entity hierarchy for Enrollment shopping cart . You can find definitions for the fields and controls later on this page.

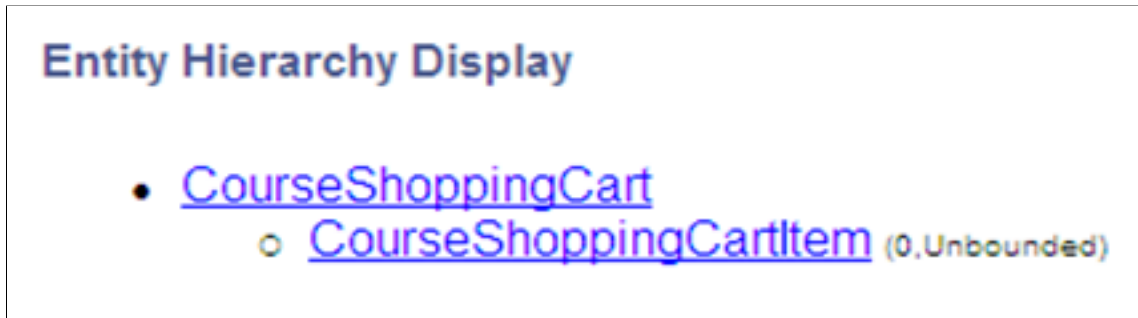

Note: We have registered CourseShoppingCart on the Shopping Cart Configuration page with Shopping Cart Type as *COURSE*.

The following is an example of the Entity Hierarchy Display page for the StudentFinanceShopCart entity:

This example illustrates the fields and controls on the Entity hierarchy for Student Finance shopping cart. You can find definitions for the fields and controls later on this page.

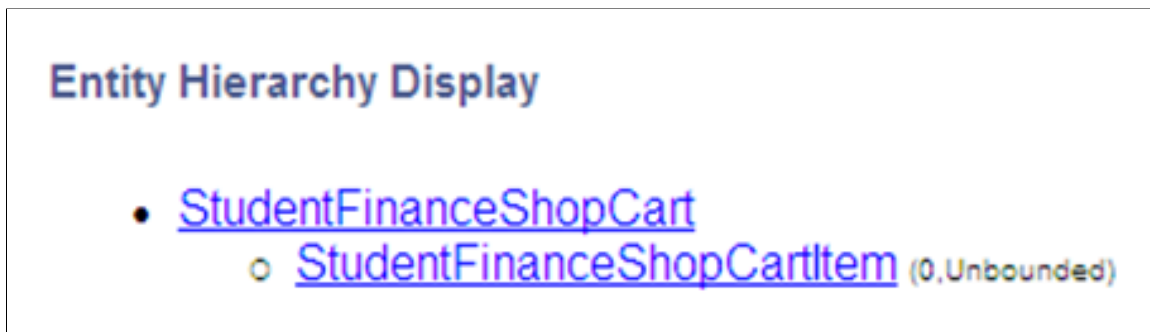

Note: Assume that you have registered StudentFinanceShopCart on the Shopping Cart Configuration page with Shopping Cart Type as *StudentFinance*.

Click the Generate XSD button for one of the parent entities, for example, CourseShoppingCart. Doing so generates an XSD that contains the elements from CourseShoppingCart entity hierarchy as well as from StudentFinanceShopCart entity hierarchy.

Replace the content of SCC_ENTITY_SHOP_CART.xsd with the generated XSD. To do so, select **PeopleTools > Integration Broker > Integration Setup > Messages > Schema** to access the SCC_ENTITY_SHOP_CART message. On the Schema page, paste the newly-generated XSD.

The following is a graphical representation of the SCC_ENTITY_SHOP_CART.xsd:

This example illustrates the fields and controls on the Example of a common schema for Enrollment and Student Financials shopping carts. You can find definitions for the fields and controls later on this page.

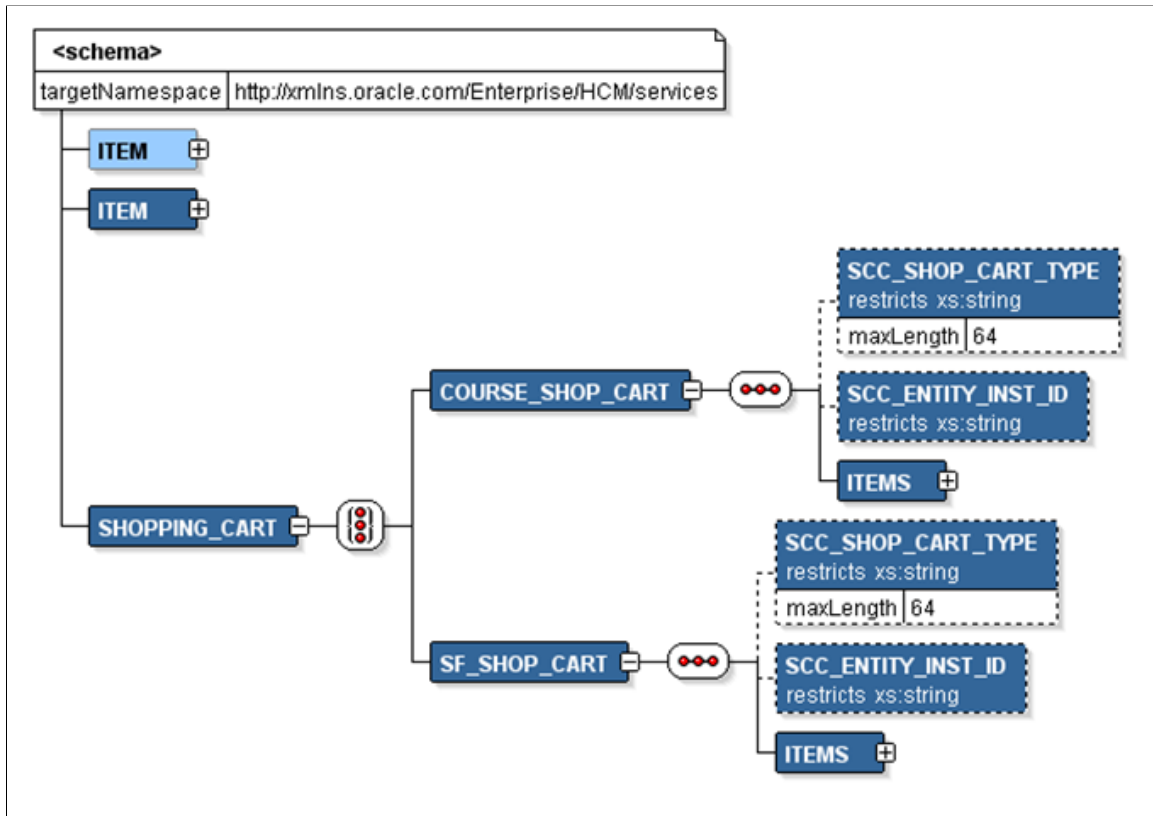

Note that the XSD contains the Course Shopping Cart (COURSE_SHOP_CART) entity as well as the Student Financials Shopping Cart (SF_SHOP_CART) entity, each entity pointing to its appropriate items.

Note: When creating a new shopping cart, generating the XSD for the newly-created parent entity and then updating the SCC_ENTITY_SHOP_CART.xsd with this newly-created XSD has no impact on the existing shopping carts.

The following is the request XSD of generic SCC_SC_ADDITEM_REQ.xsd.

This example illustrates the fields and controls on the Example of a Schema page for SCC_SC_ADDITEM_REQ.xsd. You can find definitions for the fields and controls later on this page.

Message Definition | **Schema**

Message: SCC_SC_ADDITEM_REQ **Updated:** 08/30/2011 12:38:43AM

Version: V1

[Edit Schema](#) [Delete Schema](#)

Schema:

```
<?xml version="1.0"?>
<xs:schema elementFormDefault="qualified"
targetNamespace="http://xmlns.oracle.com/Enterprise/HCM/services"
xmlns="http://xmlns.oracle.com/Enterprise/HCM/services"
xmlns:xs="http://www.w3.org/2001/XMLSchema">
  <xs:include schemaLocation="SCC_ENTITY_SHOP_CART.V1.xsd"/>
  <xs:element name="SCC_SC_ADDITEM_REQ">
    <xs:complexType>
      <xs:sequence>
        <xs:element maxOccurs="1" minOccurs="1" ref="SHOPPING_CART"/>
      </xs:sequence>
    </xs:complexType>
  </xs:element>
</xs:schema>
```

[Message Definition](#) | [Schema](#)

Note that this SCC_SC_ADDITEM_REQ.xsd schema includes the SCC_ENTITY_SHOP_CART.xsd schema that you generated for the CourseShoppingCart entity.

Working with Student Activity Guides

Understanding Student Activity Guides

The PeopleTools Activity Guides feature is the basis of the Activity Guides feature in Campus Solutions. The Student Activity Guides feature enables you to define guided tasks for students to complete. Students are presented with a list of action items that need to be completed to finish a task.

The Student Activity Guides provide sample activity guide templates that incorporate existing student self-service pages and some configurable pages. This enables institutions to assign templates to students as tasks, which students can complete using the *Student Task WorkCenter* in classic self service or the **Tasks** tile in Fluid self service. In addition to the delivered templates and the Student Task WorkCenter page, Campus Solutions provides components to enable the configuration and assignment of these tasks. You can access these configuration and assignment components from the *Task Management WorkCenter*.

For information about activity guide template, activity guide instance, action item, activity guide pagelets, and context data as well as an overview of how to develop and deploy activity guides, see “Understanding the Activity Guide Composer” (Enterprise Components) and the product documentation for *PeopleTools: Portal Technology*, “Developing and Deploying Activity Guides.”

The PeopleTools Activity Guide feature enables you to create a multi-step guided task. You create this task by defining an *activity guide template* and plugging-in existing pages (either delivered or customized) as *action items* in a specified sequence.

Each action item can have a start date/time and due date/time and has a status value (for example, *Assigned*, *In Progress*, and *Completed*). You can define:

- The dependencies between action items, for example, action item A must be completed before a student starts action item B.
- Whether an action item is required or optional, that is, whether the action item must be completed in order to complete the task.
- The processing that the system should perform when a student completes an action item.

For more information on action items, see “AG Composer Categories - Actions Page” (Enterprise Components) and the product documentation for *PeopleTools: Applications User's Guide*, Using PeopleSoft Application Pages, “Using Activity Guides.”

You can define the *context data* for a template. The *context data key fields* are the unique key fields used to identify an activity guide instance (task). This can be as simple as just an EMPLID and Institution, or can include multiple fields (for example, Institution, EMPLID, Career, Career Number, Term and so on). Context data key fields must always include the two fields: Institution and EMPLID. The system populates the context data key fields when the template is assigned – manually or through the Assign Tasks process – to the student as an activity guide instance. In other words, an activity guide instance is the task that the student should complete.

Important! Throughout this documentation, the terms *activity guide instance*, *instance* and *task* are synonymous and are used interchangeably.

Each task has an overall status (*In Progress*, *Completed* or *Cancelled*), a Start and Due Date, and an Active flag. If the Start and Due Date are not defined for the task then, the start date of the first action item is the task start date and the due date of the last action item is the task due date.

Scenarios

Student Activity Guides can be useful in a number of procedural scenarios, for example, registration requirements for new and continuing students, international students and research students.

Here is a scenario:

An institution wants students to check and update their address and emergency contact information at the beginning of each term. The students are required to complete this task before they are allowed to enroll. Service indicators are assigned to students to prevent them from enrolling.

Jane, who is a student at this institution, signs into self service. She clicks the Verify Contact Details link in the To Do List to complete the task:

1. A page appears with the details of her current home and mailing addresses. She has the option to edit both addresses. She saves the changes and clicks Next.
2. A page appears with the details of her emergency contacts. She can edit the contacts. She saves the changes and clicks Next. When she clicks Next, a completion page appears and she clicks the Finish or Submit button. Once she has completed the task, the service indicator assigned to Jane is automatically removed and she is allowed to complete her class enrollments for the term.

Here is another scenario:

An institution wants its students to complete a Registration task. The institution has provided a pagelet on a student dashboard page to display a registration link and information about this task and its deadline.

Emma, who is a student at this institution, clicks the registration link to complete this four-step task:

1. A page appears where Emma can review her career details such as program, plan and campus. The page informs her that if any of the details are incorrect, she must contact the administrator. She clicks the Next button after reviewing this data.
2. A page appears with the details of her current home and mailing addresses. She has the option to edit both addresses. She saves the changes and clicks Next.
3. A page appears with the details of her emergency contacts. She can edit the contacts. She saves the changes and clicks Next.
4. A page displays the data protection statement. She confirms that she has read the the statement, and clicks Next.

You can use the Student Activity Guides feature to create such tasks. For example, for the scenario of Registration task, create a *Registration* activity guide template and configure each step as an action item. With each action item, associate a self-service page that the student needs to complete.

Understanding How Students Access Tasks in Classic Self Service

Campus Solutions delivers pagelets to give students access to tasks through a dashboard.

Note: For the Current Tasks and Completed Tasks pagelets, Activity guides optimized for the Fluid interface are not displayed.

This example illustrates the delivered Current Tasks and Completed Tasks pagelets.

Current Tasks			
Personalize Find View All [Grid Icon] [Refresh Icon]			
First 1-2 of 2 Last			
Title	Last Updated	Due Date	Days to Due Date
Financial Agreement	23/09/2013 01:29	31/12/2014	464
Program Registration	23/09/2013 01:41	31/12/2014	464

Completed Tasks		
Personalize Find View All [Grid Icon] [Refresh Icon]		
First 1 of 1 Last		
Title	Last Updated	Due Date
Emergency Contacts Verification	23/09/2013 06:04	

Current Tasks: The student can view and access their open active tasks (based on matching EMPLID in context data) in the Current Tasks pagelet. The pagelet defaults to expanded and displays the following values for each task:

- Title (displayed as a link to access the task in the Student Task WorkCenter).
- Last Updated.
- Due Date (if defined for the final action item).
- Days to Due Date (only displayed if Due Date is defined).

The student can click the Title link to access the Student Task WorkCenter, where he or she can complete the task.

The pagelet displays only those tasks that satisfy all of the following conditions:

- Status = *In Progress*
- Active = *Y*
- The Start Date of the first action item is not after the current date

The pagelet does not display tasks with status of *Completed* or *Cancelled*, or with Active = *N*, or with Start Date in the future.

Tasks are ordered by due date ascending, that is earliest Due Date first, and if due date is same then the ordering is done alphabetically by title. Tasks without a due date are displayed last in alphabetical title order.

If there are no pending tasks, the pagelet displays a message: “No current tasks”. Use the PeopleTools Message Catalog component, if you want to change this message (Message Set = 14175, Nbr = 5).

Completed Tasks: The student can view but cannot access their completed tasks in the Completed Tasks pagelet. The pagelet displays only those tasks that have an instance status = *Complete*. Tasks with status of *In Progress* or *Cancelled* are not displayed.

Note: This pagelet does not consider the Active flag. Completed tasks are displayed whether or not the Active flag is set.

Accessing Student Task WorkCenter from the Student Center page and the Personal Data Summary page:

Note that students can also access the Student Task WorkCenter from the To Do List section in the Student Center (required setup must be done in the Student Center Options page).

See:

- “Using Student Task WorkCenter” (Campus Self Service)
- “Using Self-Service Student Center” (Campus Self Service)
- “Setting Up a Self-Service Student Center” (Campus Self Service)

This image illustrates an example of a To Do List in Student Center.

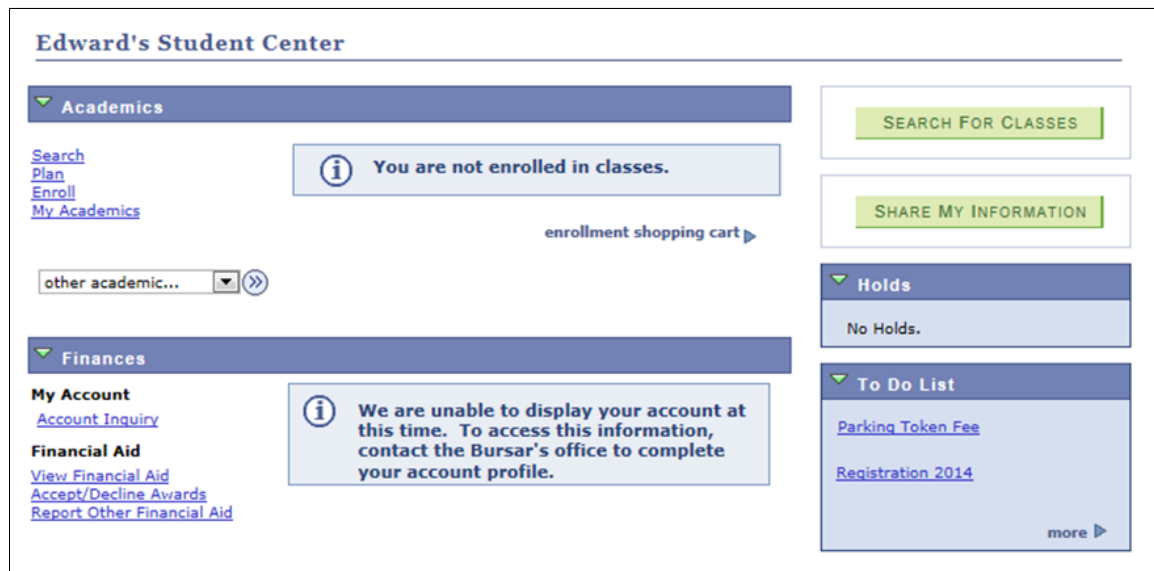

For example, a student can click the Registration 2014 link in the To Do List section of Student Center to access the Student Task WorkCenter. The student can click the More link in the To Do List section to access the To Do List page where the student can view more information about all the pending tasks and access the Student Task WorkCenter for completing a pending task.

This image illustrates an example of a To Do List page.

Edward Nolan go to ...

To Do List

Item List				
To Do Item	Due Date	Status	Institution	Administrative Function
Parking Token Fee	03/25/2014	Initiated	PeopleSoft University	General

Task List				
Task	Due Date	Status	Institution	Context Information
Registration 2014	04/04/2014	In Progress	PeopleSoft University	Career: UGRD Student ID: SR0431 Career Number: 0 Term: 0720

For more information on the To Do List page, see “Using Self-Service Checklists Data” (Campus Self Service).

The To Do List section is also available on the Personal Data Summary self-service page. For more information, see “Displaying and Accessing Self-Service Personal Data” (Campus Self Service).

Note that the Campus Community - Student Services Center component provides the ability for an administrator to see what a specific individual, such as a student, sees on Student Center self-service. For more information, see [Viewing an Individual's Student Center Information](#).

In addition to access through the Current Tasks pagelet and through the Student Center and Personal Data Summary page, a link to the Student Task WorkCenter for the task can be embedded in email notifications. The system can send these notifications to the student when the task is assigned.

For more information about notifications, see [Configuring Tasks](#).

For more information about administering dashboard pages, see “Understanding WorkCenters and Dashboards” (Enterprise Components).

Student Task WorkCenter

A student uses the Student Task WorkCenter to complete the task that the institution has assigned to the student:

This image illustrates an example of the delivered Student Task WorkCenter page.

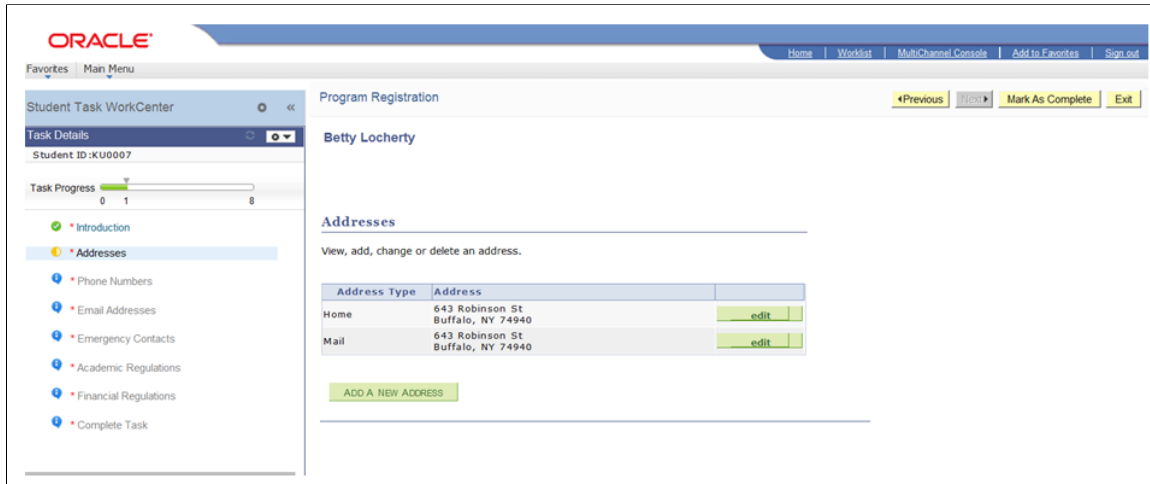

The left hand pane icons indicate the action items and their statuses. See “Understanding the Activity Guide Composer” (Enterprise Components).

As shown in the example, the activity guide instance is a task that the institution assigns to a student and each action item is a step that the student performs.

Campus Solutions delivers the launch (introduction) action item page, agreement (academic regulations and financial regulations) action item pages and the Complete (complete task) action item page.

To review the configuration of workcenter pages, see “Understanding WorkCenters and Dashboards” (Enterprise Components).

Understanding How Students Access Tasks in Fluid Self Service

Students can use the **Tasks** tile on their Homepage to view their To Do list and Holds if any; and complete their tasks with the help of Student Activity Guides. Using PeopleSoft Fluid User Interface, the To Do list allows students to view relevant information and complete tasks through their mobile devices.

See “Using the Student Homepage” (Campus Solutions Application Fundamentals) for more details.

Setting Up Activity Guide Templates

Use the Activity Guide Templates page (**Enterprise Components > Activity Guide Composer > Templates > Activity Guide Templates**) to create and update templates based on the delivered Registration category, or other categories you have defined. For information, see “Managing Activity Guide Templates” (Enterprise Components).

Alternatively, you can use the Manage Activity Guide Templates page (**PeopleTools > Activity Guide > Manage Templates**). For information, see the product documentation for *PeopleTools: Portal Technology*, Developing and Deploying Activity Guides, “Creating and Maintaining Activity Guide Templates.”

Campus Solutions delivers these templates:

- [Registration Category](#)
- [Fluid Registration Template](#)
- [Program Registration Template](#)
- [Emergency Contacts Verification Template](#)
- [Financial Agreement Template](#)

These templates and category illustrate the capabilities of activity guides to support guided tasks. The Registration category includes all the Campus Community action items. These templates are not optimized for Fluid and are for classic action items: Program Registration, Emergency Contacts Verification, and Financial Agreement.

Note: You can manage the delivered templates *only* through the Manage Activity Guide Templates page.

Registration Category

The Registration category is delivered for use only with Activity Guide Composer. It's the equivalent of the Fluid Registration Template. You can use this category or clone it to create templates.

Security

These security access options are delivered for these roles:

Security Access	Role
Administer Category	AG Composer Administrator
Add Templates	AG Composer User CS – Administrator. This is an example of an administrative user role for managing activity templates.

Context

This category is associated with the following context data fields:

- Institution
- ID
- Career
- Career Number
- Term

Images

Images aren't defined for this category. But you can include images for categories your institution defines, or an external URL in the activity guide sub-banner

Assignees

This isn't required for the CS – Student (or equivalent) role because the student's user ID is assigned as a Contributor at instance level, and for each Action Item Assignment as part of instance creation.

Steps

This category contains all the Campus Community action items.

- Introduction
- Contact Details
- Addresses
- Emergency Contacts
- Agreement 1 to 9
- Biographic Details
- Campus Preferences
- Ethnic Background
- IPEDS Ethnicity
- Personal Details
- Privacy Restrictions
- Complete Task with a Submit button

Setting up these regions isn't required:

- AWE Integration
- Additional Step Context
- Default Step Assignments (not required for single-user activity guides)

Notifications

Notifications aren't delivered for Activity Guide Composer. They're handled using the Notifications Framework.

Related Links

“Setting Up Activity Guide Categories” (Enterprise Components)

Fluid Registration Template

This delivered template includes the existing Launch, Agreement and Complete Task pages with the additional setup features required for the PeopleSoft Fluid User Interface. The defined tasks can be completed using both mobile and desktop devices.

This template is associated with the following context data fields:

- Institution
- ID
- Career
- Career Number
- Term

And consists of these action items:

- Launch (this is an optional item)
- Contact Details
- Addresses
- Emergency Contacts
- Agreement 1
- Agreement 2
- Complete Task with a Submit button

These are the personal data pages that aren't included in the Fluid Registration template, but are available for use as action items in activity guides on the Fluid User Interface:

- Personal Details
- Biographic Details
- Privacy Restrictions
- IPEDS Ethnicity
- Ethnic Background
- Campus Preferences

For more details, see [Configuring Tasks](#).

Related Links

“Managing Emergency Contacts Using PeopleSoft Fluid User Interface” (Campus Self Service)

Program Registration Template

This delivered template is associated with the following context data fields:

- EMPLID (student)
- Institution
- Career
- Career number
- Term

You may decide that the student can enroll for the term only after he or she completes the program registration task.

The template consists of the following action items:

- Introduction (launch) page: Configurable using the Task Configuration component.
- Addresses self-service page: Existing self-service page.
- Email Addresses page: Existing self-service updatable page.
- Phone Numbers page: Existing self-service updatable page.
- Emergency Contacts page: Existing self-service updatable page.
- Academic Regulations (Agreement page 1): Configurable using the Task Configuration and Page Definitions components.
- Financial Regulations (Agreement page 2): Configurable using the Task Configuration and Page Definitions components.
- Complete Task page: Configurable using the Task Configuration component.

Note: When defining a new non-optimized template, you must include a Complete Task page as the final action item in the template to allow the associated processing to be undertaken (including the sending of notifications) when a student completes a task.

Important! The terms *action item* and *step* in a task are synonymous and are used interchangeably in this documentation.

For more information on the Task Configuration and Page Definitions components, see [Configuring Tasks](#).

The Student Task WorkCenter displays these pages to students as part of a task.

Activity Guide Template Properties

Click the Properties link for the Program Registration template on the Manage Activity Guide Templates page to access the activity guide template properties.

This image illustrates an example of the PeopleTools Activity Guide Template - Properties page.

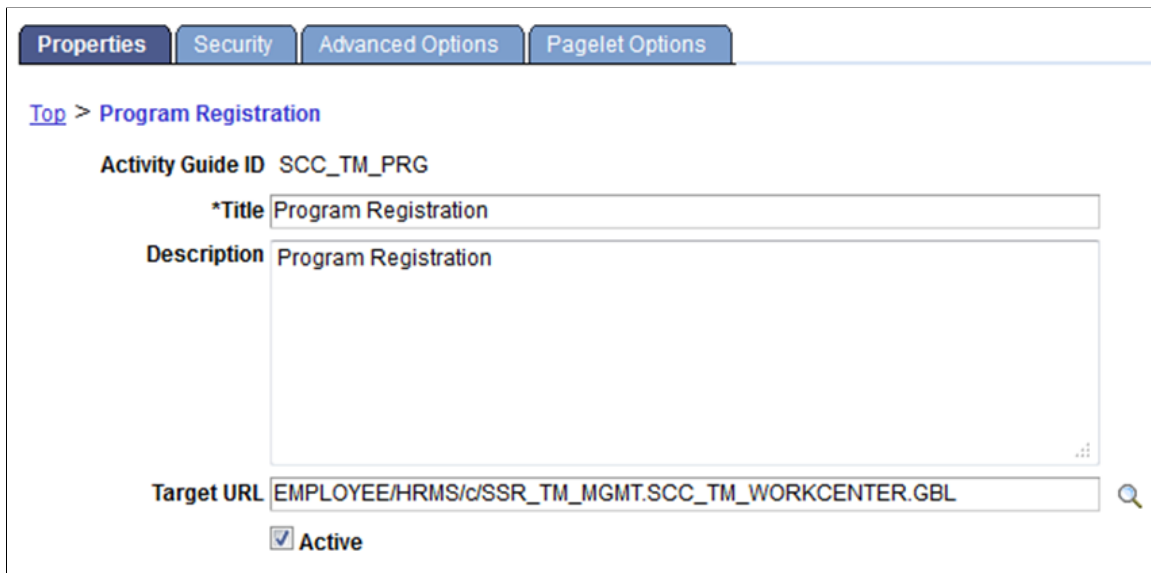

Use this page to review or modify the template properties, security privileges, advanced options (such as modifying context data fields) and pagelet options.

Note: On this page, the Title and Description fields can be edited as required. However, the Target URL should be set to *EMPLOYEE/HRMS/c/SSR_TM_MGMT.SCC_TM_WORKCENTER.GBL* (as shown on the screenshot) to ensure that the task is available in the Student Task WorkCenter. The system displays the Title value to the student in the Student Task WorkCenter. The Description field can be used for a more detailed description of the task. This description is used for internal processes only and is not displayed to the student.

See “Managing Activity Guide Templates” (Enterprise Components).

This image illustrates an example of the PeopleTools Activity Guide Template – Security page.

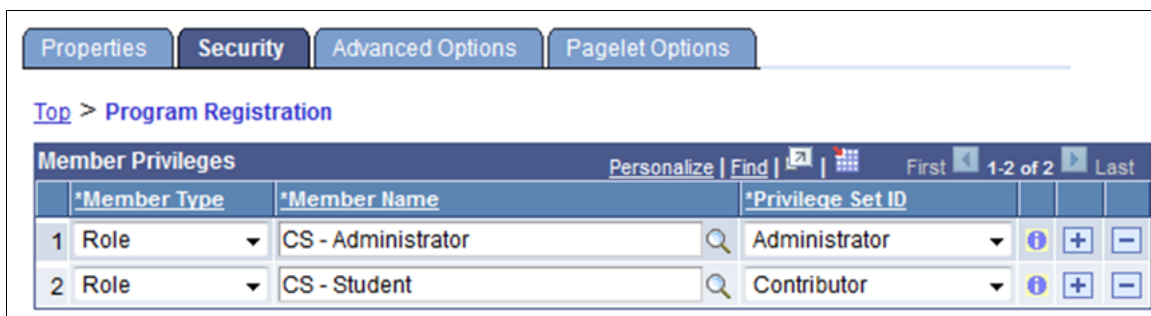

From the Activity Guide Template - Security page, at least one row is required with Privilege Set ID = *Administrator* if you want to add or modify the roles in the delivered template. In addition, the role of the students who complete the task should be defined with Privilege Set ID = *Contributor*.

This image illustrates an example of the PeopleTools Activity Guide Template – Advanced Options page.

Properties Security **Advanced Options** Pagelet Options

[Top](#) > Program Registration

Context Data Personalize | Find | 1-5 of 5 | Last

	*Record Name	*Field Name	Label	Key Field	Context Visible		
1	ACAD_PROG	ACAD_CAREER	Career	<input checked="" type="checkbox"/>	<input type="checkbox"/>		+ -
2	ACAD_PROG	EMPLID	Student ID	<input checked="" type="checkbox"/>	<input checked="" type="checkbox"/>		+ -
3	ACAD_PROG	INSTITUTION	Institution	<input checked="" type="checkbox"/>	<input type="checkbox"/>		+ -
4	ACAD_PROG	STDNT_CAR_NBR	Career Number	<input checked="" type="checkbox"/>	<input type="checkbox"/>		+ -
5	STDNT_CAR_TERM	STRM	Term	<input checked="" type="checkbox"/>	<input type="checkbox"/>		+ -

Instance Creation

Enter the Activity Guide Instance creation application class

Package:

Path:

Class ID:

Method Name:

Configurable Fields

Text Fields	Yes/No Fields
Field Label 1: <input type="text" value="Region"/>	Field Label 1: <input type="text"/>
Field Label 2: <input type="text"/>	Field Label 2: <input type="text"/>
Field Label 3: <input type="text"/>	Field Label 3: <input type="text"/>
Field Label 4: <input type="text"/>	Field Label 4: <input type="text"/>
Field Label 5: <input type="text"/>	Field Label 5: <input type="text"/>

From the Activity Guide Template - Advanced Options page, you'll find the regions Context Data, Instance Creation, and Configurable Fields.

For Context Data, INSTITUTION and EMPLID must always be included as Key Fields.

The Context Visible check box determines whether the data is visible to the student in the Student Task WorkCenter and in the Task List region of the To Do List page. The Label value is used when displaying context data fields to students.

For more information on the To Do List page, see “Using Self-Service Checklists Data” (Campus Self Service).

Note that InstanceCreation is the delivered method that is used by all of the delivered templates. If you are creating your own template, you can reuse the details shown in the Instance Creation region of the delivered template. To ensure that all the delivered processing is triggered when an instance is created, the delivered application class SCC_TM_ACTIVITYGUIDE_FW should be used or a new application class should be created that extends this class and contains any required additional custom logic

Note: On the Configurable Fields section (Text Fields column) of the Activity Guide Template - Advanced Options page, ensure that you do not modify the value *Region* in the Field Label 1 field. If you choose to add values to other field labels, use Field Label 2 onwards. The system uses the *Region* value when the delivered Agreement pages are defined as action items. The Region value must be entered for templates that are using Agreement pages.

This image illustrates an example of the PeopleTools Activity Guide Template – Pagelet Options page.

Button Label	Method Name	Message Set	Message Number
1 Mark As Complete	MarkComplete	0	0
2 Exit	XExitAG	14175	25

Use the Activity Guide Template - Pagelet Options page to add custom navigation frame buttons to the Student Task WorkCenter page (refer to the Mark As Complete and Exit buttons on the graphic of the Student Task WorkCenter page in the preceding "Student Task WorkCenter" subsection of the "Understanding Student Activity Guides" section). The Class ID is the application class containing the methods to be invoked to create custom navigation frame buttons.

See [Understanding Student Activity Guides](#).

Activity Guide Template - Pagelet Options page: The Mark As Complete and Exit buttons are delivered in each of the example templates.

The Mark As Complete button enables a student to set the action item (step) as *completed* for pages where none of the data is being updated. For example, on the address page if all the displayed data is accurate, the student can click Mark As Complete to indicate that no updates are required. The button is labeled as *Mark as Read* on launch pages that are read-only. For agreement pages, the button label is not displayed and does not update the action item status; when the student clicks the button, the system displays a message to indicate that Save must be clicked on the page to save the Accept or Decline decision.

Note: Mark As Complete is a special custom navigation button and the method must be named MarkComplete.

The Exit button enables a student to leave the task at any step and return later to complete it. If the student clicks this button a warning message is displayed: *Updates will only be saved for sections that are marked as Complete. Do you still want to exit?* When the OK button is clicked:

- If access was from one of the following pages the student returns to that page:
 - Student Center
 - Personal Data Summary
 - To Do List
- If access was from the Current Tasks pagelet, the student returns there.

- If access was from a notification link (either embedded in an email or from the Notifications Center), and a Default Exit navigation page has been defined in Task Configuration component, the student navigates to that page.
- If access was from an email link and no Default Exit navigation page is defined, the student is logged out.
- If access was from the Notification Center and no Default Exit navigation page is defined, the student stays on the completed page and can close the browser tab or window and return to the Notification Center in the previous tab or window.

Activity Guide Template – Action Items

Click the title link for Program Registration on the Manage Activity Guide Templates page to access the Action Items page.

This image illustrates an example of the Activity Guide Template – Action Items page.

Sequence	Title	Priority	Status	Category	Parent Action	Last Updated Date	Due Date	
10	Introduction		Assigned		ROOT	12/08/2013		Delete
20	Addresses		Assigned		ROOT	14/08/2013		Delete
30	Phone Numbers		Assigned		ROOT	12/08/2013		Delete
40	Email Addresses		Assigned		ROOT	12/08/2013		Delete
50	Emergency Contacts		Assigned		ROOT	12/08/2013		Delete
60	Academic Regulations		Assigned		ROOT	12/08/2013		Delete
70	Financial Regulations		Assigned		ROOT	12/08/2013		Delete
80	Complete Task		Assigned		ROOT	12/08/2013	31/12/2014	Delete

Use this page to view or configure the action items for the template. See “Activity Guide Composer - Organize and Configure Steps Page” (Enterprise Components)

Click a title link to access the Action Item Details page for a particular action item.

This image illustrates an example of the Action Item - Action Item Details page.

The screenshot shows the 'Action Item Details' page with the following fields and sections:

- Item ID:** SCC_TM_ADD2
- *Title:** Addresses
- Description:** Addresses
- Required:**
- Summary:**
- *Sequence:** 20
- Priority:** (dropdown menu)
- Status:** Assigned
- Category:** (text input with search icon)
- Percent Complete:** (text input)
- *Assign Type:** Role
- *Assigned To:** CS - Student
- Action Item Link:**
 - Type:** App Class URL
 - Service ID:** SCC_TM_ADDRESS
 - Address:** Address
 - [Test Service](#)
- Schedule Information:**
 - Start Date/Time:** 01/08/2013 00:00 PDT
 - Due Date/Time:** (empty fields)

On the Action Item Details page, each of the action items is delivered with the following settings:

- Required = Y
- Dependencies are set up so that the student must complete each action item before moving on to the next one.
- The system uses the start date of the Introduction action item as the *task start date* and uses the due date of the Complete Task action item as the *task due date*.

The action item link determines which page is opened in the Student Task WorkCenter for the action item. In the preceding graphic of Action Item Details page, this is set to App Class URL with Service ID of the Related Content Service for the Addresses page.

The related content services are delivered for the four self-service pages: Addresses, Phone Numbers, Email Addresses and Emergency Contacts, as well as Launch, Agreement, and Complete. These related content services enable the system to display the pages as action items (without displaying the navigation path, for example, *Self Service, Campus Personal Information, Addresses, Addresses*) when the student accesses these pages from the Student Task WorkCenter.

The Start Date/Time field is required and defaults to system date. The field must be set to a date when the action item is to be accessible to the student. For example, if Start Date/Time = August 2, 2013, then the student can access this action item only on or after August 2, 2013. The student cannot access the action item on August 1, 2013. The start date for each action item is typically set to the same value as the launch page in the template.

Access the Related Data page.

This image illustrates an example of the Action Item - Related Data page.

Related Data

[Top](#) > [Program Registration](#) > [Academic Regulations](#)

Progress Remarks

Attachments

Title	Attachment Type	
1	File Attachment	Add Attachment

Action Item Post Process

Package Name:

Path:

Class Name:

Post Process Method:

Related Data

Region:

Dependencies

Controller Action	Title	*Rule	Start Date	Due Date	Status
1 SCC_TM_EME9	Emergency Contacts	Finish To Start	01/08/2013		Assigned

Note: Action Item - Related Data page: In the Region field of the Related Data section, the value - *AGR1* (for the first agreement action item) or *AGR2* (for a second agreement action item) - must exist for the agreement action items (for example, Academic Regulations and Financial Regulations).

The delivered `ItemPostProcess` method executes when the student completes the action item (for example, in the preceding graphic of Related Data page, the `ItemPostProcess` method executes when the student completes the *Academic Regulations* step). To ensure that all the delivered processing is triggered when an instance is completed, the delivered application class `SCC_TM_ACTIVITYGUIDE_FW:AgreementPostProcessingAdapter` should be used for agreement pages and the delivered application class `SCC_TM_ACTIVITYGUIDE_FW:ActionItemPostProcAdapter` for other pages or a new application class should be created that extends the `SCC_TM_ACTIVITYGUIDE_FW` package and contains any required additional custom logic.

On the Related Data page, dependencies are set up between the action items. For example, the preceding graphic of Related Data page shows that the student must complete the Emergency Contacts action item before he or she can access the Academic Regulations action item.

Related Content Services

In order to add other system or custom pages to the template as action items, a related content service must be defined that can then be used as the Action Item Link Service ID.

To define a related content service, access the Define Related Content Service page (**Peopletools > Portal > Related Content Services > Define Related Content Service**).

Individual application classes are provided for the delivered related content service definitions. These individual application classes contain the pre-processing logic that is followed before the page is opened. These classes can be customized to add further pre-processing logic.

See the product documentation for *PeopleTools: Portal Technology*, Developing and configuring related content services

Emergency Contacts Verification Template

This delivered template is associated with the following context data fields:

- EMPLID (student)
- Institution
- Term

The template consists of the following action items:

- Introduction (launch) page: Configurable using the Task Configuration component.
- Emergency Contacts page: Existing self-service page.
- Complete Task page: Configurable using the Task Configuration component.

Access the Advanced Options page to review this template's context data.

This example illustrates the context data for the Emergency Contacts Verification template.

	*Record Name	*Field Name	Label	Key Field	Context Visible		
1	ACAD_PROG	EMPLID	Student ID	<input checked="" type="checkbox"/>	<input checked="" type="checkbox"/>	<input type="checkbox"/>	<input type="checkbox"/>
2	ACAD_PROG	INSTITUTION	Institution	<input checked="" type="checkbox"/>	<input type="checkbox"/>	<input type="checkbox"/>	<input type="checkbox"/>
3	STDNT_CAR_TERM	STRM	Term	<input checked="" type="checkbox"/>	<input type="checkbox"/>	<input type="checkbox"/>	<input type="checkbox"/>

The rest of the settings and rules of this template are similar to the Program Registration template.

Financial Agreement Template

This delivered template is associated with the following context data fields:

- EMPLID (student)
- Institution
- Career

- Career number

You may decide that the student can enroll only after he or she agrees to the financial agreement.

The template consists of the following action items:

- Agreement page: Configurable using the Task Configuration component.
- Complete Task page: Configurable using the Task Configuration component.

This template is an example of a task without the optional Launch page.

Access the Advanced Options page to review this template's context data.

This example illustrates the context data for the Financial Agreement template.

The screenshot shows the 'Advanced Options' tab selected in a web interface. Below the navigation tabs, there is a breadcrumb trail: 'Top > Financial Agreement'. The main content area is titled 'Context Data' and contains a table with the following data:

	*Record Name	*Field Name	Label	Key Field	Context Visible		
1	ACAD_PROG	ACAD_CAREER	Career	<input checked="" type="checkbox"/>	<input type="checkbox"/>	<input type="checkbox"/>	<input type="checkbox"/>
2	ACAD_PROG	EMPLID	Student ID	<input checked="" type="checkbox"/>	<input checked="" type="checkbox"/>	<input type="checkbox"/>	<input type="checkbox"/>
3	ACAD_PROG	INSTITUTION	Institution	<input checked="" type="checkbox"/>	<input type="checkbox"/>	<input type="checkbox"/>	<input type="checkbox"/>
4	ACAD_PROG	STDNT_CAR_NBR	Career Number	<input checked="" type="checkbox"/>	<input type="checkbox"/>	<input type="checkbox"/>	<input type="checkbox"/>

The rest of the settings and rules of this template are similar to the Program Registration template.

Configuring Tasks

Use the Task Configuration component (SCC_TM_CONFIG) to define additional properties for a template other than those defined in the PeopleTools Manage Activity Guide Templates component. This component is applicable to both the Classic User Interface and the Fluid User Interface.

Note: A configuration record is required in the Task Configuration component before a task can be assigned to students.

This section discusses how to:

- Define task properties.
- Define launch page properties.
- Define agreement pages.
- Define agreement page properties.
- Defining complete page properties.

Pages Used to Configure Tasks

<i>Page Name</i>	<i>Definition Name</i>	<i>Navigation</i>	<i>Usage</i>
Task Configuration	SCC_TM_CONFIG	Campus Community > Task Management WorkCenter > Task Configuration	Required. Define properties of the task including optional prerequisite and subsequent tasks and Notification framework parameters.
Launch	SCC_TM_CONF_LAUNCH	Campus Community > Task Management WorkCenter > Task Configuration > Launch	Optional. Define the properties of the optional launch page that can be displayed to the student as the first step (first action item) in a task. Properties that you can define include instruction text and the optional display of selected contact and career information.
Agreements	SCC_TM_CONF_AGRMNT	Campus Community > Task Management WorkCenter > Task Configuration > Agreements	Optional. Define which page definitions to use for agreement pages displayed as interim steps (interim action items) in a task.
Complete	SCC_TM_CONF_SUBMIT	Campus Community > Task Management WorkCenter > Task Configuration > Complete	Optional. Define the content and format of the final action item page of the task.
Field Setup	SCC_FIELD_SETUP	Campus Community > Task Management WorkCenter > Field Setup	View the delivered career information fields that you can display on the launch action item page. To choose which of these delivered fields the launch page should display, use the Task Configuration component's Launch page.
Page Definitions	SCC_TM_PG_DEFN	Campus Community > Task Management WorkCenter > Page Definitions	Define agreement pages for use in the Task Configuration component's Agreement page.

Defining Template Properties

Access the Task Configuration page (**Campus Community > Task Management WorkCenter > Task Configuration**).

This example illustrates the fields and controls on the Task Configuration page (1 of 2). You can find definitions for the fields and controls later on this page.

This example illustrates the fields and controls on the Task Configuration page (2 of 2). You can find definitions for the fields and controls later on this page.

On this page, you can create a configuration record for an institution for any active activity guide template. The page displays the context data fields that are defined for the template on the PeopleTools Activity Guide Template - Advanced Options page.

For new configuration records, use the **Copy From** button to copy all the details from an existing configuration record.

The system refers to the most current effective dated record on this page when the task is displayed to students.

Field or Control	Description
Display Due Date	Select to display the due date on the Launch page and the Complete page. If defined for the instance, that Due Date value is displayed; otherwise the Due Date of the final action item is displayed.

Prerequisite Task

Optionally, use this region to define any prerequisite tasks that the student needs to complete before you assign this task. The system will make this check when you either manually assign this task using the Create Instance button on the Activity Guide Template - Properties page or when you use the Assign Tasks process.

Subsequent Task

Optionally, use this region to define any related tasks that the system automatically assigns when the student completes this task. For example, the preceding graphic of Task Configuration page illustrates that the Emergency Contacts Verification task is automatically assigned to the student when he or she completes the Program Registration task. Note that the current task must have the required key Context Data fields to create the subsequent task.

The Task Configuration page checks whether all the context data fields for the subsequent task exist for the current task. If any values are missing, the page displays a warning message. You can ignore the warning; however, the system does not create the subsequent task when the student completes the current task.

Notifications

Optionally, use this region to define the notifications that the system triggers when the task is assigned to a student or when the student completes a task. The system uses the Notification Framework for handling notifications.

When notifications are not sent through the Notifications Framework but instead through Push Notifications, you can optionally select a **Notification Template ID** to create alerts for new tasks.

<i>Field or Control</i>	<i>Description</i>
Push Notification	<p>This check box is enabled if the Trigger is set to <i>Assigned</i>.</p> <p>By default, Push Notifications is not selected. If selected, for optimized templates, the Assign Tasks process generates an alert when an instance is created.</p>

Delivered with the system are the Notification Consumer ID *Task Management Notifications* (*SCC_NTF_CON_20130619110938*) for use with Student Activity Guides and the notification setup for example templates SCC_TM_ASSIGNED and SCC_TM_COMPLETED.

Note: The system triggers the assign notification parameter at the point when the task is assigned to the student, which can be before the start date of the task. The notification would need to include an explanation for the student that the task is not available until the start date.

See [Understanding the Notifications Framework](#)

Note

These features (Prerequisite Task, Subsequent Task and Notifications) are dependent on the delivered application class

SCC_TM_ACTIVITYGUIDE_FW:TaskProcessingAdapter:PrerequisiteProcessingAdapter having been defined for Instance Creation in the Activity Guide Template definition and SCC_TM_ACTIVITYGUIDE_FW>ActionItemProcessingAdapter>ActionItemPostProcAdapter having been defined for Action Item Post Process for the final complete action item in the Activity Guide Template definition.

Release Service Indicators

This region enables you to define one or more service indicators/reasons. When the student completes the task, the system releases this defined service indicator(s) for the student.

The fields in this region are similar to the fields of Mass Release page. For information on the Mass Release page:

See [Mass Assigning or Mass Releasing Service Indicators](#)

For information on service indicator security:

See “Setting Up Service Indicator Security” (Campus Solutions Application Fundamentals)

The system applies in this region the same security to the selection of service indicator and reason as it applies to the Mass Release page. For the service indicator that the system should release when a student completes the task, you - as an administrative user - setting up the task must have the Release option enabled for the combination of Service Indicator Code and Reason in the Service Indicator Security page (this setup is not required for the student who triggers this release). The system automatically triggers this release when the student clicks the Finish button on the Complete page (that is, the system releases the service indicator when the student completes the task).

If any of the Start Date, End Date, Start Term or End Term values are defined, then at the point the student clicks Finish, the processing that releases service indicators considers those values when matching to records that need to be released for the student.

To view audit records, use the Audit Service Indicators page (**Campus Community > Service Indicators > Person > Audit Service Indicators**). For more information:

See [Auditing Service Indicators](#)

Note: You can use the Mass Assign page to assign one or more service indicators to each student who has a particular task. To run the Mass Assign process, using PS Query, the query must include the bind record SCC_BND_SRCIND. An example PS Query is delivered (SCC_TM_SI_TASK_LIST) that can be used with the Mass Assign process.

Alternatively, you can assign a service indicator to each student using the Mass Assign process and then run the Assign Tasks process to create a task for every student with that service indicator using a PS Query to identify the population of students.

Navigation

Use this region to specify the page that should appear for:

- *Default Exit:* When the student clicks the Exit button and then the OK button for confirming the exit from the task and the student accessed the task from an email link.
- *Complete Task:* When the student completes a task.

For example, you can define that the My Planner page should appear when a student completes a task.

Further details on the navigation when a student clicks Exit are given under Pagelet Options in [Program Registration Template](#).

Defining Launch Page Properties

Access the Launch page (**Campus Community > Task Management WorkCenter > Task Configuration > Launch**).

This example illustrates the fields and controls on the Launch page (1 of 2). You can find definitions for the fields and controls later on this page.

Task Configuration | **Launch** | Agreements | Complete

Academic Institution PSUNV PeopleSoft University

Template ID SCC_TM_FLD Fluid Registration

Context Data
Career
Student ID
Institution
Career Number
Term

Details

Effective Date 06/06/2016 Effective Status Active

Display Title

Instruction Text

Welcome to Registration. You are are required to complete this task before you are able to enrol on classes. Please complete each section of the task by reviewing the details and then selecting **Submit** on the final page. Once a step has been marked as complete you can navigate to the next page using the

Confirm Button

Confirm Label Confirm

Field or Control	Description
Display Title	<p>Enter the page title that is displayed to the student.</p> <p>This is an optional field for Fluid tasks because the Display Title appears as a secondary title below the action item title. For Classic tasks however, the Display Title is displayed as the page title.</p>
Instruction Text	<p>Enter the text that appears after the page title to describe the actions that the student needs to perform. This is an optional field.</p> <hr/> <p>Note: You can enter text to indicate to the student that clicking the Next button on a page signifies that the student has reviewed the data on an action item page and is satisfied to proceed.</p> <hr/>
Confirm Button	<p>For Fluid interfaces only. Include an action button on the launch page. The user can review read-only details on the page such as career information, and then click the action button to complete the required action item. By default, the Confirm button is not selected.</p> <p>Selecting the Confirm button has the following impact:</p> <ul style="list-style-type: none"> • <i>Campus Preferences page:</i> Changes are saved and the action item is set to complete irrespective of changes made. The Confirm button is then disabled and greyed out. Any subsequent changes re-enable the Confirm button to allow the saving of changes. Subsequent changes are lost unless the user selects Confirm again before moving to the next step. • <i>Privacy Restrictions page:</i> Changes are saved and the action item is set to complete irrespective of changes made. The Confirm button is then disabled and greyed out. Any subsequent changes re-enable the Confirm button to allow the saving of changes. Subsequent changes are lost unless the user selects Confirm again before moving to the next step. • <i>Ethnicity pages:</i> Changes are saved and the action item is set to complete irrespective of changes made. The Confirm button is then disabled and greyed out. The action item continues to be set to complete if a new background record is added or an existing record is edited. • <i>Biographic Details page:</i> Changes are saved and the action item is set to complete irrespective of changes made. The Confirm button is then disabled and greyed out. Selecting Save after editing individual fields does not affect the action item’s status.

Field or Control	Description
Confirm Label	For Fluid interfaces only. Use this field to override the default Confirm label for the button. You can use a maximum of 40 characters in mixed case format. The field is enabled only if the Confirm Button is selected.

You can format the text for both Display Title and Instruction Text fields using the formatting options including the ability to add URL and email links particularly for the Instruction Text field.

This example illustrates the fields and controls on the Launch page (2 of 2). You can find definitions for the fields and controls later on this page.

*Field Name	Description	*Label	Display Type	Primary / All
1 ACAD_CAREER	Career	Career	<input type="checkbox"/>	
2 ACAD_LOAD_APPR	Load	Load	<input type="checkbox"/>	
3 ACAD_PLAN	Plan	Plan	<input checked="" type="checkbox"/>	Primary
4 ACAD_PROG	Program	Program	<input type="checkbox"/>	
5 CAMPUS	Campus	Campus	<input type="checkbox"/>	
6 SSR_YR_OF_PROG	Year	Year	<input type="checkbox"/>	

Display-Only Page Regions

Optional. Use this group box to define one or more read-only data regions that the system displays on the launch action item page after the page title and instruction text. The information that the data region displays is based on the context data. You can choose to display career information and contact information (addresses, email addresses, phone numbers and emergency contacts), with instructions on how the student can notify the institution of any incorrect information.

Field or Control	Description
Region	<p>Select which data regions the launch action item page should display. You can add rows to select the following data regions:</p> <ul style="list-style-type: none"> • Addresses • Career information • Email • Emergency contacts • Phone numbers <p>The fields that appear in the Display-Only Page Regions group box depend on the value that you select for the Region field.</p> <p>The launch action item page displays these regions in a fixed order depending on which regions are included. You cannot modify this order. The fixed order is:</p> <p>(1) Addresses (2) Phone (3) Email (4) Emergency Contacts (5) Career information.</p> <hr/> <p>Note: The launch action item page can display career information only if the context data for the task includes the key values: EMPLID, ACAD_CAREER and STDNT_CAR_NBR.</p> <hr/>
Display Title	<p>Enter the title that is displayed for the data region. For example, if the region you select is <i>Addresses</i>, you can enter here <i>Your Address Information</i>.</p>
Instruction Text	<p>Enter additional information that follows after the display title. For example, if the region is <i>Career</i>, you can enter here <i>Review your program information. If the information is incorrect, please contact the department head.</i></p>
Address 1 Type, Address 1 Label, Address 2 Type, and Address 2 Label	<p>These fields become available for entry when you select <i>Addresses</i> in the Region field.</p> <p>You can select one or two address types to display and configure the label field to display the address type with a description rather than the default description of the selected address type.</p>

<i>Field or Control</i>	<i>Description</i>
Phone 1 Type, Phone 1 Label, Phone 2 Type and Phone 2 Label	<p>These fields become available for entry when you select <i>Phone</i> in the Region field.</p> <p>You can select one or two phone types to display and configure the label field to display the phone type with a description rather than the default description of the selected phone type.</p>
Preferred Phone	<p>This option becomes available for edit when you select <i>Phone</i> in the Region field. Select this option if you want the data region to not consider the Phone Type 1 and 2 values and display only phone records with Preferred flag.</p>
Email 1 Type, Email 1 Label, Email 2 Type, and Email 2 Label	<p>These fields become available for entry when you select <i>Email</i> in the Region field. You can select one or two email types to display and configure the label field to display the email type with a description rather than the default description of the selected email type.</p>
Preferred Email	<p>This option becomes available for edit when you select <i>Email</i> in the Region field. Select this option if you want the data region to not consider the Email Type 1 and 2 values and display only email records with Preferred flag.</p>
Primary Contact Only	<p>This option becomes available for edit when you select <i>Emergency</i> in the Region field. Select this option if you want the data region to display only primary emergency contact.</p> <p>If you do not select this option, all emergency contacts are displayed.</p>

Field options for career information

This example shows the grid that contains some of the field options for career information:

This example illustrates the grid that contains some of the field options for career information.

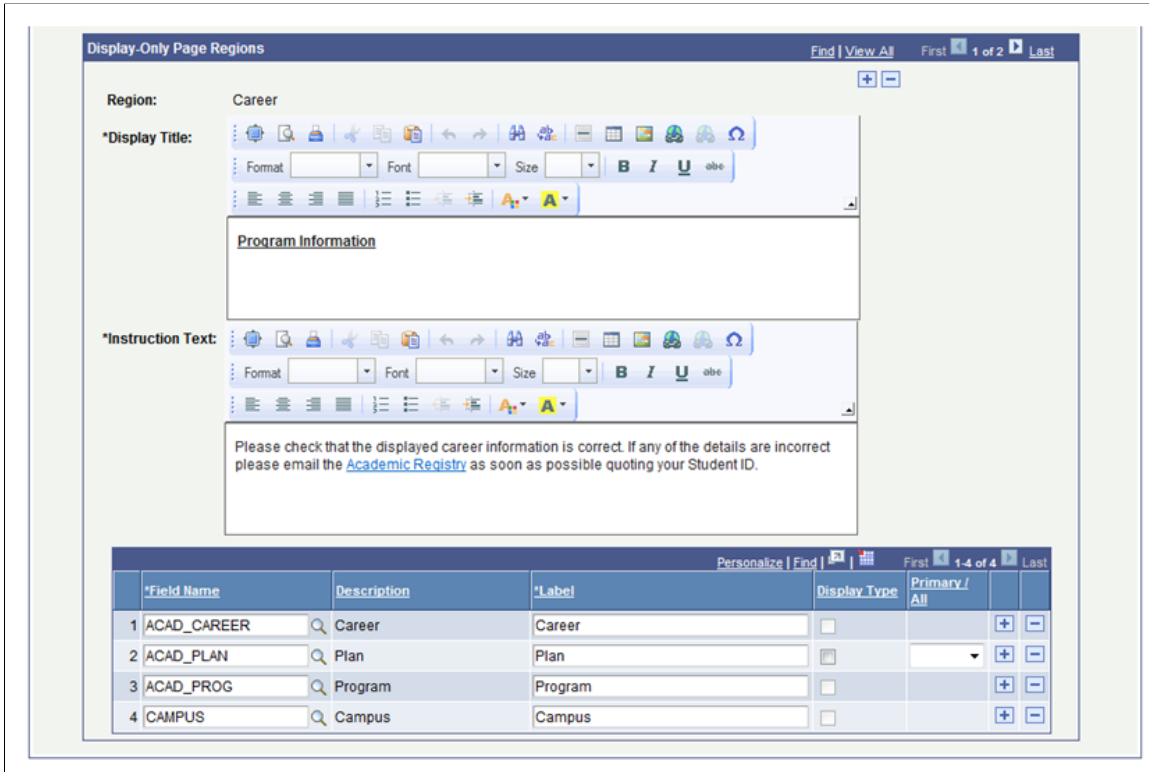

This grid is available for edit only when you select Career in the Region field. Use this grid to add the fields that you want to display in the Career data region of the launch action item page. If you do not include a field in this grid, then that field is not displayed on the launch page.

Field or Control	Description
Field Name and Description	The prompt values are from the Field Setup page.
Label	The value defaults from the Description field. You can override this value if you want to display a different label for the field on the Career data region.

Field or Control	Description
Display Type	<p>Available for edit only if you select <i>ACAD_PLAN</i> or <i>ACAD_SUB_PLAN</i> in Field Name.</p> <p>If you select this option, the Career data region displays the plan or subplan type description in addition to any defined label.</p> <p>The format is <i><label>: <type> <field value description></i>. For example, if there is a label for <i>ACAD_PLAN</i> and you have selected Display Type, then this is displayed:</p> <p><i>Plan: Major Music</i></p> <p>Where <i>Plan</i> is the label, <i>Major</i> is the academic plan type, and <i>Music</i> is the field value description.</p>
Primary/All	<p>Available for edit only if you select <i>ACAD_PLAN</i> in Field Name.</p> <p>If you select <i>Primary</i>, the Career data region displays only the description of the academic plan with the lowest plan sequence (<i>PLAN_SEQUENCE</i>). If you select <i>All</i> or do not select a value, all the plan descriptions for the Student Program are displayed in plan sequence order.</p>

The following table describes the source of the value for each Field Name. The system displays this value in the Career Data region.

Field Name	Notes
INSTITUTION	Displays the description for the INSTITUTION value from context data. This can be excluded if required; the institution value can also be included in the context data displayed for the task in the Student Task WorkCenter.
ACAD_CAREER	Displays the description for the ACAD_CAREER value from context data.
ACAD_PROG	Displays the description for the ACAD_PROG value from Student Program for the combination of ACAD_CAREER and STDNT_CAR_NBR from context data.

Field Name	Notes
ACAD_PLAN	<p>Displays the description for the ACAD_PLAN value from Student Plan.</p> <p>If <i>Primary</i> is selected only the description of the academic plan with the lowest plan sequence (PLAN_SEQUENCE) is displayed (PLAN_SEQUENCE from ACAD_PLAN), otherwise (either <i>All</i> is selected or no value is selected in the Primary/All field) all the plan descriptions for the Student Program are displayed in plan sequence order.</p> <p>If the Display Type option is selected, the plan type as well as the label and field value description is displayed.</p>
ACAD_SUB_PLAN	<p>Displays the descriptions of all the academic subplans (ACAD_SUB_PLAN from ACAD_SUBPLAN) for each of the displayed academic plans in alphabetical order by subplan code.</p> <p>If the Display Type option is selected, the subplan type as well as the label and field value description is displayed.</p>
CAMPUS	<p>Displays the description for the CAMPUS value from Student Program (ACAD_PROG).</p>
ACAD_LOAD_APPR	<p>Displays the long translate name for the ACAD_LOAD_APPR value from Student Program (ACAD_PROG).</p>
SSR_YR_OF_PROG	<p>Displays the long translate name for the SSR_YR_OF_PROG value from Student Program (ACAD_PROG).</p>

Note: The launch action item page displays values from the most recent effective dated row on or before the current date in the Student Program record, excluding any future rows. Careers are displayed only if the program status is active (AC).

Note: The sequence of the fields displayed on the launch action item page is determined by a tree structure that relates to the underlying record structure. This is fixed as follows and is not related to the row numbers in the grid:

- Institution
- Career
- Program
- Plan
- Sub-plan

- Academic Load
- Campus
- Year of Program

Defining Agreement Pages

Access the Page Definitions page (**Campus Community > Task Management WorkCenter > Page Definitions**).

This example illustrates the fields and controls on the Page Definitions page (1 of 2). You can find definitions for the fields and controls later on this page.

The screenshot shows the 'Page Definitions' interface for a 'Financial Agreement'. At the top, it displays 'Academic Institution: PSUNV PeopleSoft University', 'Type: Agreement', and 'Code: FIN_AGREE1'. A 'Copy From' button is visible. The main section is titled 'Page Details' and includes a checked 'Active' checkbox, a '*Description' field with the value 'Financial Agreement', and a 'Display Title' field with a rich text editor toolbar. Below the editor is an '*Instruction Text' field containing the text: 'Once you have reviewed the details please either select **Accept** to confirm your agreement or select **Decline** and then print and return a signed paper copy to the Registry.'

This example illustrates the fields and controls on the Page Definitions page (2 of 2). You can find definitions for the fields and controls later on this page.

The screenshot shows a web form titled "Agreement Details". It contains three main sections:

- *Agreement Text:** A text area containing the text: "I, understand that by enrolling in a class, unless I drop the class prior the dates shown on the Academic Calendar, that: * I am responsible for all fees assessed, whether I attend classes or not,".
- Agreement Options:** A section with two columns of radio buttons and checkboxes. The first column has "Accept / Decline" (selected) and "Accept Only". The second column has "Complete on Decline" and "Print". Below these are two text input fields labeled "Accept" and "Decline".
- Save Options:** A section with three checked checkboxes: "Save Agreement", "Save IP Address", and "Save Agreement Text".

This page enables definition of multiple different agreement action item pages that can be associated with one or more tasks in the Task Configuration component's Agreements page. Define and format the agreement text and other instructions that are to be displayed on the agreement action item page.

Note: When you add a new page definition for an agreement page, the page code must begin with either a letter or a number and be a minimum of two characters.

You can configure whether or not the agreement details (such as text, user ID, IP address, date/time signed and so on) needs to be saved as a separate record for audit purposes.

Field or Control	Description
Copy From	This button is available only when you add a new page definition. Click this button to copy any existing page definition details to the new page definition that you are creating.
Description	Enter a description to be used for internal purposes only. This is not displayed to the student.
Display Title	Enter the page title that is displayed to the student. This is an optional field for Fluid tasks because the Display Title appears as a secondary title below the action item title. For Classic tasks however, the Display Title is displayed as the page title.
Instruction Text	Enter the text that appears after the page title to describe the actions that the student needs to perform.

Field or Control	Description
Agreement Text	<p>Enter the text that is displayed to the student after the page title and instruction text. This is a long char field and the maximum characters is determined by the database depending on how the text is formatted.</p> <p>You can use this field to include the full text of the institution's terms and conditions or regulations, or include a link with instructions for the student to navigate to the details and then come back to accept the terms and conditions.</p>

Agreement Options

Field or Control	Description
Accept/Decline	<p>If selected the student is presented with radio button options to either Accept or Decline the agreement in classic tasks. For Fluid tasks, both Accept and Decline buttons are provided.</p> <p>This is provided for cases where the student has the option of declining and then printing, signing and returning a paper copy of the agreement. Instructions can be included in the instruction text.</p> <p>For the Accept/Decline Buttons to be displayed on mobile devices without the need for horizontal scrolling, ensure that label values have a maximum of 20 characters each (40 totally) where both Accept and Decline are included.</p>
Accept Only	<p>If selected, the student is presented with a single check box option or button to confirm they have read and accepted the agreement.</p>
Accept Label	<p>Enter the text to be displayed for the accept option in a classic interface. For example, you can enter <i>I agree to abide by the rules and regulations specified above.</i></p> <p>For Fluid tasks, for the Accept Button to be displayed on mobile devices, without the need for horizontal scrolling, ensure that the label value has a maximum of 40 characters. For classic tasks, for display on laptops and desktops, the label value can contain a maximum of 100 characters.</p>

Field or Control	Description
Decline label	<p>Available for edit only if you select the Accept/Decline option. Enter the text to be displayed for the decline option.</p> <p>For Fluid tasks, for the Decline Button to be displayed on mobile devices without the need for horizontal scrolling, ensure that the label value has a maximum of 40 characters. For classic tasks, for display on laptops and desktops, the label value can contain a maximum of 100 characters.</p>
Complete on Decline	<p>This check box is enabled only if the Accept/Decline option is selected. By default, it is not selected.</p> <p>If this option is selected, then the action item status is set to Complete when the student selects either Accept or Decline. If this option is not selected, and the student selects Decline, the action item status remains <i>In Progress</i>.</p>
Print	<p>If selected the student is presented with the Printable Page option that enables the student to print the agreement. This option is not available for Fluid tasks on small mobile devices, such as smart phones.</p>

Save Options

Field or Control	Description
Save Agreement	<p>If selected, the system saves the agreement record (related but separate from the task record) with:</p> <ul style="list-style-type: none"> • User ID • Agreement Date/Time • Agreement Status: <i>Accepted</i> or <i>Declined</i> <p>If you do not select this option, then a separate agreement record is not saved. However, when the student selects the agree option, the action item in the task is still marked as <i>Completed</i>. The action item remains <i>In progress</i> if the student selects the decline option.</p> <hr/> <p>Note: You should select the Save Agreement option, if the Accept/Decline option has been selected in the Agreement Options group box. This ensures that the system records the accept/decline decision of the student.</p> <hr/>

Field or Control	Description
Save IP Address	Available for edit only if you have selected the Save Agreement option. If selected, the system also saves the student’s IP address in the agreement record.
Save Agreement Text	Available for edit only if you have selected the Save Agreement option. If selected, the system also saves the full agreement text in the agreement record.

Defining Agreement Page Properties

Access the Agreements page (**Campus Community > Task Management WorkCenter > Task Configuration > Agreements**).

This example illustrates the fields and controls on the Agreements page. You can find definitions for the fields and controls later on this page.

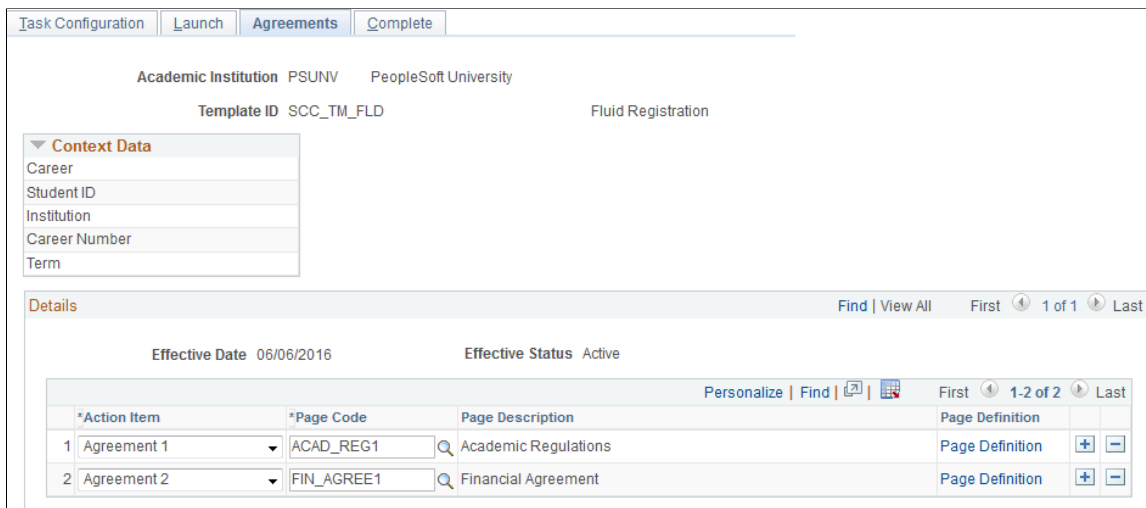

Field or Control	Description
Action Item	Select the agreement page for the activity guide template. Values for this field are delivered with your system as translate values. The nine delivered values that appear here are: <i>Agreement 1 to Agreement 9</i> .
Page Code	Select the page code for the action item. The page codes are created in the Page Definitions page. See the previous subsection “Defining Agreement Pages”.

Field or Control	Description
Page Definition	Click to access the Page Definition page, where you can review or edit the page code details.

Defining Complete Page Properties

Access the Complete page (**Campus Community > Task Management WorkCenter > Task Configuration > Complete**).

This example illustrates the fields and controls on the Complete page. You can find definitions for the fields and controls later on this page.

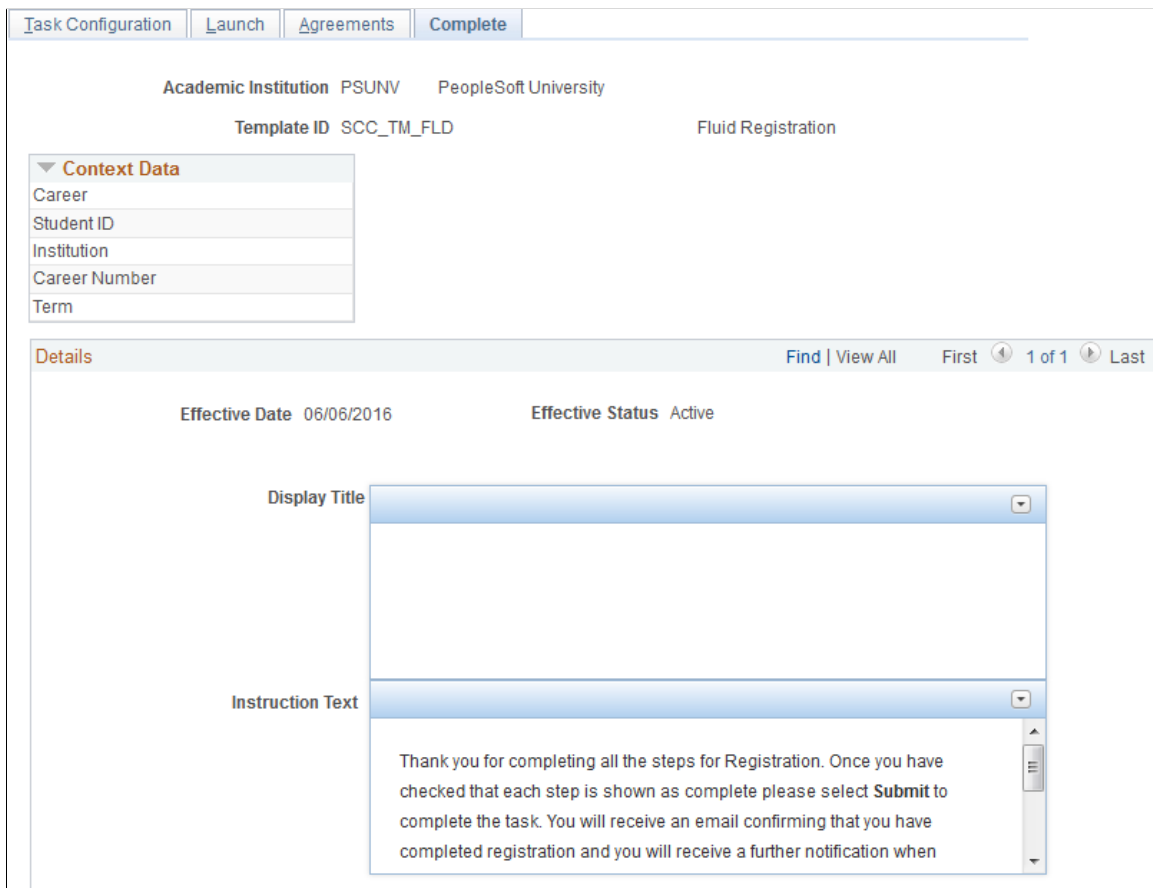

Field or Control	Description
Display Title	Enter the page title that is displayed to the student. This is an optional field for Fluid tasks because the Display Title appears as a secondary title below the action item title. For Classic tasks however, the Display Title is displayed as the page title.

Field or Control	Description
Instruction Text	Enter the text that appears after the page title to describe the actions that the student needs to perform.

When the student clicks the Finish or Submit button on the Complete page, the task status is set to *Completed*. If subsequent tasks are configured, then new tasks are assigned. If a notification is configured, then a notification is generated for the student.

Managing Tasks

This section discusses:

- Task Management WorkCenter.
- Assigning tasks to students in batch.
- Managing tasks using the Task List component.
- Managing tasks using the PeopleTools components.
- Viewing or updating a student agreement.
- Viewing task activity.
- Using Batch Notifications process for sending reminders.
- Updating tasks in batch.
- Deleting tasks in batch.

Pages Used to Manage Tasks

Page Name	Definition Name	Navigation	Usage
Task Management WorkCenter	SCC_TM_ADMN_WRKCTR	Campus Community > Task Management WorkCenter	Configure and manage tasks.
Assign Tasks	SCC_TM_BAT_CREATE	Campus Community > Task Management WorkCenter > Assign Tasks	Run the process to assign tasks to students in batch based on Population Selection or Student Groups. You can also run this process for individual students.

Page Name	Definition Name	Navigation	Usage
Task List	SCC_TM_ADM_LIST	Campus Community > Task Management WorkCenter > Task List	Search for tasks assigned to students. Manage tasks assigned to students, for example, adding action items and changing the status to <i>In Progress</i> or <i>Complete</i> .
View Agreements	SCC_TM_AGRMNT	Campus Community > Task Management WorkCenter > View Agreements	Search for agreement records of students. View and update agreement records of students.
View Task Activity	SCC_TM_TASK_LOG	Campus Community > Task Management WorkCenter > View Task Activity	View updates to tasks that students have made via the Student Task WorkCenter.
Batch Notifications	SCC_BAT_NTF	Campus Community > Task Management WorkCenter > Batch Notifications	Run the process to generate reminder notifications in batch for <i>In Progress</i> tasks based on Population Selection.
Update Tasks	SCC_TM_BAT_UPDATE	Campus Community > Task Management WorkCenter > Manage Tasks > Update Tasks	Update Activity Guide instances based on Population Selection. You can update tasks for an individual or a group.
Delete Tasks	SCC_TM_BAT_DELETE	Campus Community > Task Management WorkCenter > Manage Tasks > Delete Tasks	Delete Activity Guide instances based on Population Selection. You can delete tasks for an individual or a group.

Task Management WorkCenter

Task Management WorkCenter offers you access to task transactions from one central location. You can use this WorkCenter to configure and manage tasks for Campus Solutions. Access the Task Management WorkCenter (**Campus Community > Task Management WorkCenter**).

This example illustrates the fields and controls on the Task Management WorkCenter.

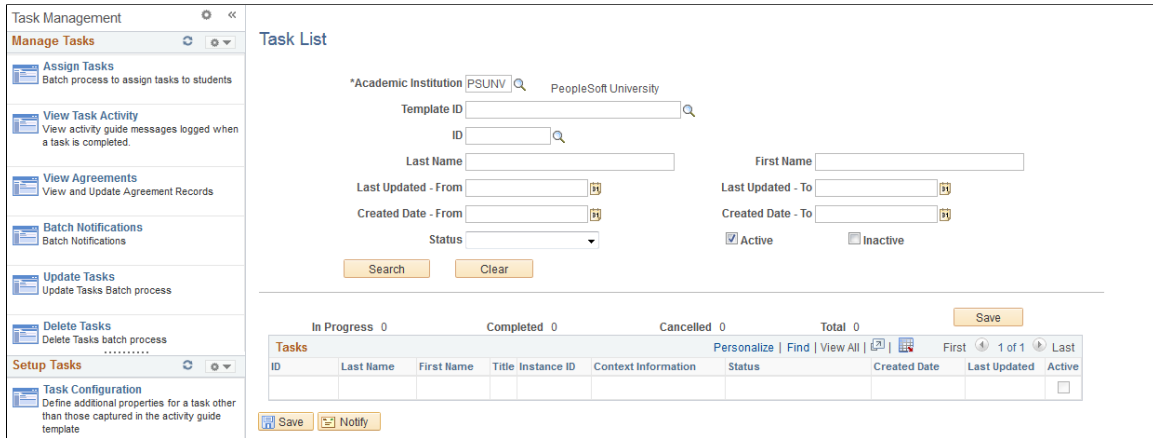

For information about using the links on this page, see:

- [Configuring Tasks](#)
- [Managing Tasks Using the Task List Page](#)

Task Management WorkCenter is a PeopleTools Portal – WorkCenter page. For information about the WorkCenter, see “Understanding WorkCenters and Dashboards” (Enterprise Components).

Assigning Tasks to Students in Batch

Access the Assign Tasks page (**Campus Community > Task Management WorkCenter > Assign Tasks**).

This example illustrates the fields and controls on the Assign Tasks page. You can find definitions for the fields and controls later on this page.

Assign Tasks

Run Control ID: AssignTasks Report Manager Process Monitor Run

*Academic Institution PeopleSoft University

*Template ID Registration 2020

Start Date Due Date

Context Data

Career	<input type="text"/>
Display Name	<input type="text"/>
Career Number	<input type="text"/>
Term	<input type="text"/>
Term Begin Date	<input type="text"/>
Term End Date	<input type="text"/>

Request Options

Assign Review

Population Selection

Population Selection

Selection Tool [Edit Prompts](#)

Query Name [Launch Query Manager](#) [Preview Selection Results](#)

Student Group

Student Group

Student Override

Student Override

Field or Control	Description
Start Date	<p>(Optional) Enter the task’s start date.</p> <p>If the instance is created by the Assign Tasks process, the start or due date value at the instance level is derived from the value you define here or in Due Date. Otherwise, the value is derived from the dates you defined on the template.</p>
Due Date	<p>(Optional) Enter the task’s due date.</p> <p>In the To Do List, this date appears as the instance due date.</p>
Assign	<p>Select to run the Assign Tasks process based on the chosen request options (Population Selection, Student Group or Student Override).</p>

Field or Control	Description
Review	<p>Select to run the process in review mode.</p> <p>This option can be used to review the current task records against the population selection criteria originally used to create the tasks and identify students who no longer meet the criteria for the task or whose context data has changed and needs to be updated.</p> <p>If you select this option, only Population Selection is available (Student Group and Student Override become unavailable).</p> <p>When you select this option, the process compares the population and the assigned <i>In Progress</i> tasks to determine:</p> <ul style="list-style-type: none"> • Students in the population who are not assigned tasks. The process can then be run with Assign selected to add the tasks for these students. • Students who have an assigned task with matching context data compared with the values in the population selection but the task status is <i>Cancelled</i>. You can then update the task status via the Task List page. • Students who have an assigned <i>In Progress</i> task with different context data as compared to the values in the population selection. You can then update the task via the Task List page. • Students with an assigned <i>In Progress</i> task who are not in the population. The task can then be set to <i>Cancelled</i> via the Task List page or deleted via the Activity Guide Instances page. <p>The process adds the results of this comparison in a log file that you can review.</p>

In Assign mode, the Assign Tasks process creates the tasks and populates the context data. The process also handles the checking of prerequisite tasks and triggering of assignment notifications.

For each instance, the Administrator roles defined for the template are copied to the instance. A security record with the Privilege Set ID of Contributor is created for the User ID related to the EMPLID, rather than a Role defined for the template (for example, CS - Student for the delivered templates).

If there is no User ID associated with the EMPLID, the instance is created without a defined Contributor and a message is logged. If the EMPLID is associated with multiple User IDs, Contributor records are created for each User ID and a message is logged.

For each record, the process performs the following:

- If any prerequisite task defined in the Task Configuration component is not complete, the process does not create the task for that student, logs a message and skips to the next student record.
- If there is an existing task for the student (that is, activity guide instance with all context data is matching), the process does not create a task for that student, logs a message indicating that the task already exists and skips to the next student record.

- If the process passes all the above validations, it creates a new activity guide instance for the student and populates the context data, logs a message with the student details confirming that the task has been created.
- For each new activity guide instance created, if a notification has been defined with Trigger = *Assigned* in the Task Configuration component, the process triggers a new notification for the student.

For Fluid tasks, if the Push Notifications check box is selected, an Alert is generated in the Fluid Notifications flag with a link to access the task.

In review mode, the Assign Tasks process performs the following:

For the purposes of matching the population and In Progress tasks, the context data values for the population are taken either from the PS Query results or from the Context Data parameter fields.

Step 1. Review population against tasks

For each record in the population:

- If there is a matching activity guide instance for the Template ID, Institution, EMPLID and all the context data and:
 - If the instance status is *Cancelled*, the process logs a message stating that the task is cancelled for the ID.
 - If the instance is *In Progress* or *Complete*, the process does not log a message.
- If there is a matching activity guide instance for the Template ID, EMPLID and Institution but not all the context data matches, then the process logs a message stating that the context information of the task does not match.
- If there is no matching activity guide instance for the Template ID, Institution and EMPLID, then the process logs a message stating that the task is not assigned to the student.

Step 2. Review tasks against population

For each current task (that is, activity guide instance with status *In Progress*) for the Template ID and institution (note: the process does not consider cancelled and completed tasks):

If the student is not in the population, the process logs a message stating that the ID, status and task context is not included in the population.

Context Data

Use this group box to specify the context data parameters.

The system dynamically displays the context data fields in this group box for the template that you have selected.

If you are using Population Selection, then the context data values can come from the query results. In such a case, you need not populate the context data fields. If you are using either Student Group or Student Override or Population Selection with a query that only returns EMPLIDs, then you must specify all the context data values (except Student ID and Institution) that the process uses to create the tasks.

Field or Control	Description
Student ID	This is not displayed in Context Data. The value is derived from the Population Selection, Student Group or Student Override parameters you specify on this page.
Institution	This is not displayed in Context Data. The value is derived from the value you enter in the Academic Institution field of this page.

Population Selection

Population selection is a method for selecting the IDs to process for a specific transaction. Currently, the Assign Tasks process supports only PS Query for selecting the IDs.

See [Understanding the Population Selection Group Box](#)

Select the Population Selection check box.

The Assign Tasks process can be run for a group of students returned by a query. The minimum a query needs to return are the EMPLID values for students. If the query also returns context data values, then those override any context data parameters specified in the Context Data group box. In addition to EMPLID, context data values can be populated from a query for Career (ACAD_CAREER), Career Number (STDNT_CAR_NBR), Term (STRM), Academic Plan (ACAD_PLAN), Class Number (CLASS_NBR), and Session (SESSION_CODE).

Field or Control	Description
Query Name	Select an existing query in the system. The SCC_TM_PPL_SRCH_QRY predefined query is delivered. This sample query returns all the context data required for use with the Program Registration template.

Student Group

Use this group box if you want to run the process for a select group of students.

See [Understanding Student Groups](#)

Note: You must specify the context data parameters in the Context Data group box if you are running the process for a student group.

Student Override

<i>Field or Control</i>	<i>Description</i>
Student Override	Select if you want to run the process for the IDs selected in the EmplID field.
ID (employee ID)	Enter the IDs of one or more students to whom the process should assign the task.

Note: You must specify the context data parameters in the Context Data group box if you are using the Student Override group box.

Translated Tasks

When an instance is created, instance language records are created as follows:

- *Full Translation* is done when one of the following conditions is true:
 - The template has been created using Activity Guide Composer and the **Translation Option** is *Full Translation*.
 - The template has been created using PeopleTools Manage Templates and the Generate instance data for all languages check box is selected.
 - The PeopleTools level is lower than 8.58.

All the language records defined for the template and its action items are created at instance level. This applies whatever user profile language is defined and whatever language is used to log in.

- *Partial Translation* is done when the user running the Assign Tasks process has a user profile language other than the base language and one of the following conditions is true:
 - The template has been created using Activity Guide Composer and the **Translation Option** is *Partial Translation*.
 - The template has been created using PeopleTools Manage Templates and the Generate instance data for all languages check box is not selected.

All language records defined for the template and its action items for the user profile language are created at instance level.

Note: *Partial Translation* for instances created via the PeopleTools Create Instance page are based on the logged-in language of the user rather than the user profile language that is used by the Assign Tasks process.

Managing Tasks Using the Task List Page

The Task List page has an enhanced functionality when compared with the PeopleTools - Manage Activity Guide Instances page. For example, the Task List page provides more search options and enables you to identify the EMPLID of the student to whom the task is assigned.

Access the Task List page (**Campus Community > Task Management WorkCenter > Task List**).

This example illustrates the fields and controls on the Task List page. You can find definitions for the fields and controls later on this page.

The screenshot shows the 'Task List' interface. At the top, there are search filters for 'Academic Institution' (PSUNV), 'Template ID' (SCC_TM_ECL), and 'Emergency Contacts Verification'. Below these are fields for 'ID', 'Last Name', 'First Name', 'Last Updated - From', 'Last Updated - To', 'Created Date - From', and 'Created Date - To'. There are also checkboxes for 'Active' and 'Inactive' status, and 'Search' and 'Clear' buttons. A summary bar shows 'In Progress 0', 'Completed 1', 'Cancelled 1', and 'Total 2'. Below the summary is a table of tasks with columns for ID, Last Name, First Name, Title, Instance ID, Context Information, Status, Created Date, Last Updated, and Active.

ID	Last Name	First Name	Title	Instance ID	Context Information	*Status	Created Date	Last Updated	Active
AA0008	Hoffman	Donna	Emergency Contacts Verification	SCC_TM_ECL44760	Term: 0750	Cancelled	11/14/2016	11/14/2016	<input checked="" type="checkbox"/>
SR0430	No	Chong	Emergency Contacts Verification	SCC_TM_ECL2022	Term: 0710	Completed	09/30/2016	09/30/2016	<input checked="" type="checkbox"/>

Field or Control	Description
Template ID	The prompt values are based on the institution that you select. The system also restricts these prompt values based on security settings (member privileges) of the template. That is, you can select a template in this field only if you have the security access for the template.
Last Updated – From and Last Updated – To	Use these fields to narrow the search to only those tasks that have been updated by the institution or students within this range.
Created Date – From and Created Date – To	Use these fields to narrow the search to only those tasks that have been created by the institution within this range.

Tasks

Field or Control	Description
Title	Click to access a PeopleTools - activity guide component where you can view the action items of the instance.
Instance ID	Click to access a PeopleTools - activity guide component where you can view the properties of the instance.

Field or Control	Description
Context Information	Displays the context data (except Institution and EMPLID) for the task.
Status	If needed, change the task status. Available statuses include <i>Cancelled</i> , <i>In Progress</i> and <i>Completed</i> .

If you do not have security access to the instance, the search results displays the instance with the Title and Instance ID links disabled.

See the product documentation for *PeopleTools: Portal Technology*, Managing activity guide instances.

Managing Instances Using the PeopleTools Components

You can use the PeopleTools Activity Guide components to manually create an instance (task for a student), based on a template. For example, to create an instance based on a template, you can use the Create Instance button on the Activity Guide Template - Properties page. In other words, you can use the button to manually assign a task to a student that the student needs to complete.

Note that the same Instance Creation method is used by the PeopleTools Activity Guide components when you manually create an instance and the Assign Tasks process.

Use the PeopleTools - Manage Activity Guide Instances page to manage instances, for example, adding action items to an instance or deleting instances. You can access this page from the PeopleTools menu or from the Task Management WorkCenter.

Refer to the *PeopleTools: Portal Technology* documentation for information on creating instances and for fields on the PeopleTools - Manage Activity Guide Instances page.

See the product documentation for *PeopleTools: Portal Technology*, Managing activity guide instances.

Viewing or Updating a Student Agreement

To search for agreement records, access the View Agreements page (**Campus Community > Task Management WorkCenter > View Agreements**).

This example illustrates the fields and controls on the View Agreements page. You can find definitions for the fields and controls later on this page.

View Agreements

*Academic Institution PeopleSoft University

Template ID

Agreement Financial Agreement

ID

Last Name First Name

Acceptance Date - From Acceptance Date - To

Acceptance Status

Agreements									Personalize Find View All
ID	Last Name	First Name	Task Title	Context Information	Task Status	Agreement	Acceptance Date	Acceptance Status	
AA0001	Adams	Kimberly	Fluid Registration	Career: UGRD Career Number: 0 Term: 0750	Completed	Financial Agreement	17/08/2016	Y	
CC0002	Hanks	Ted	Fluid Registration	Career: UGRD Career Number: 0 Term: 0750	In Progress	Financial Agreement	16/08/2016	Y	
CC0003	Dam	Jan Willem	Fluid Registration	Career: UGRD Career Number: 0 Term: 0750	In Progress	Financial Agreement	25/08/2016	Y	
SR0430	No	Chong	Fluid Registration	Career: UGRD Career Number: 0 Term: 0770	Completed	Financial Agreement	25/08/2016	Y	

Field or Control	Description
Template ID	The prompt values are based on the institution that you select. The system also restricts these prompt values based on security settings (member privileges) of the template. That is, you can select a template in this field only if you have the security access for the template.

Click the Agreement link in a search record to access the View Agreement Detail page.

This example illustrates the fields and controls on the View Agreement Detail page. You can find definitions for the fields and controls later on this page.

View Agreement Detail

Details

Institution	PSUNV	PeopleSoft University	Attachments (0)
ID	AA0004		
Last Name	Carter	First Name	Scott
Task Title	Fluid Registration		
Task Status	Deleted		
Instance ID	SCC_TM_FLD6160		
Item ID	SCC_TM_AG26_SCC_TM_FLD6160		
Agreement	Financial Agreement		
Acceptance Date	08/11/2016	<input checked="" type="checkbox"/> Acceptance Status	
Agreement Text	<p>I, understand that by enrolling in a class, unless I drop the class prior the dates shown on the Academic Calendar, that:</p> <p>* I am responsible for all fees assessed, whether I attend classes or not, and/or whether or not I participate in distance learning classes.</p> <p>* I will receive a grade of F which shall not be reversed or adjusted, even if I do not attend classes, even if I do not participate in a distance learning classes, and even if I have not paid for classes.</p> <p>* I am responsible for repayment of Financial Aid monies if I withdraw or fail to attend classes or participate in distance learning classes. The amount to be repaid shall be all of the Financial Aid disbursed, or a portion thereof, as determined by the institution.</p>		
IP Address	10.176.136.137		
Last Updated By	SSS_AA0004	Scott Carter	
Last Updated	08/11/2016 02:08		
Comment	<div style="border: 1px solid #ccc; height: 40px; width: 100%;"></div> <p style="font-size: small; margin-top: 5px;">255 characters remaining</p>		

This page enables you to view an agreement for audit purposes and as an administrator complete an agreement on behalf of a student (for example, after a student has declined an agreement, printed and signed the agreement and returned a paper copy).

Field or Control	Description
Attachments	<p>Click to access the Agreement Attachments page where you can view, add or delete attachments related to the agreement.</p> <p>You can add an attachment of a scanned signed paper agreement.</p>

Field or Control	Description
Acceptance Status	Use this check box if student has submitted a paper agreement. Select the check box to indicate that the student has accepted the agreement. Clear the check box to indicate that the student has not accepted the agreement.
Comment	Enter any comments if you have changed the acceptance status.
Last Updated and Last Updated By	The date and time at which the page was last updated and the name of the user who updated the page.

When you click the Save button and if the Acceptance Status check box has been selected, then the system updates the status of the associated action item to *Completed*. If all the required action items (that is, action items with the Required check box selected on the Action Item Details page) for the task are now set to *Completed*, the system performs the following processing (which is the same processing the system performs when the student clicks the Finish button on the Complete Task page):

- Updates instance status to *Complete*.
- Triggers the complete notification.
- Creates subsequent tasks.
- Releases service indicators.

The View Agreements page is updated to also display those agreements where the related instance has been deleted either through the Manage Instances page or by the Delete Tasks process. In such cases, the Task Title is displayed from the related template and Context Information is blank. The Task Title is derived from the first 10 characters of the Instance ID held in the agreement record matched to the Template ID. The Task Status column displays *Deleted* in place of the instance status.

Note: You cannot search by Template ID to find agreements for a deleted instance.

Note: The **Acceptance Status** and **Comment fields** can still be updated for agreements associated with deleted instances.

Viewing Task Activity

Access the View Task Activity page (**Campus Community > Task Management WorkCenter > View Task Activity**).

This example illustrates the fields and controls on the View Task Activity page. You can find definitions for the fields and controls later on this page.

The screenshot shows the 'View Task Activity' interface. At the top, there are search filters for 'Academic Institution' (set to 'PSUNV' and 'PeopleSoft University') and 'Template ID' (set to 'SCC_TM_PRG'). Below these are fields for 'ID', 'Last Name', 'First Name', 'Updated - From', and 'Updated - To'. There are 'Search' and 'Clear' buttons. A 'Context Data' dropdown is also visible. Below the filters is a table titled 'Task Activity' with columns: ID, Last Name, First Name, Title, Instance ID, Context Information, Updated, and Message. The table contains five rows of data, all with 'Program Registration' as the title and 'Task completed' as the message.

ID	Last Name	First Name	Title	Instance ID	Context Information	Updated	Message
SR12202	Lancet	Amit	Program Registration	SCC_TM_PRG48672	Career: UGRD Career Number: 0 Term: 0690	11/16/2016 2:37AM	Task completed
SR0430	No	Chong	Program Registration	SCC_TM_PRG2027	Career: UGRD Career Number: 0 Term: 0710	10/28/2016 5:58AM	Subsequent task Emergency Contacts Verification already exists with Instance ID: SCC_TM_ECL2022
SR0430	No	Chong	Program Registration	SCC_TM_PRG2027	Career: UGRD Career Number: 0 Term: 0710	10/28/2016 5:58AM	Task completed
SR0430	No	Chong	Program Registration	SCC_TM_PRG2027	Career: UGRD Career Number: 0 Term: 0710	10/28/2016 5:56AM	Task completed
SR0430	No	Chong	Program Registration	SCC_TM_PRG2027	Career: UGRD Career Number: 0 Term: 0710	10/28/2016 5:54AM	Task completed

This page displays records based on the activity guide messages that the system logs when a task is completed.

Messages are logged for the following actions when a student completes a task:

- The task status is updated to *Complete*.
- A new subsequent task is created for the student.
- A subsequent task cannot be created because the current task does not have all the required context data.
- A subsequent task is not created because it already exists for the student.

Field or Control	Description
Template ID	The prompt values are based on the institution that you select. The system also restricts these prompt values based on security settings (member privileges) of the template. That is, you can select a template in this field only if you have the security access for the template.

Task Activity

Field or Control	Description
Title	Click to access a PeopleTools- activity guide component where you can view the action items of the instance.

Field or Control	Description
Instance ID	Click to access a PeopleTools- activity guide component where you can view the properties of the instance.

If you do not have security access to the instance, the search results displays the instance with the Title and Instance ID links disabled.

Using Batch Notifications Process for Sending Reminders

Access the Batch Notifications run control page (**Campus Community > Task Management WorkCenter > Batch Notifications**).

This example illustrates the fields and controls on the Batch Notifications page (1 of 2)

Batch Notifications

Run Control ID: TN01 [Report Manager](#) [Process Monitor](#) Run

Academic Institution:

Population Selection

Population Selection
 Selection Tool: [Edit Prompts](#)
 Query Name: [Launch Query Manager](#) [Preview Selection Results](#)

Event Setup

Enable Event Tracking

This example illustrates the fields and controls on the Batch Notifications page (2 of 2)

The screenshot displays the 'Batch Notifications' configuration page. It is divided into two main sections: 'Notification Consumers' and 'Notification Templates'.

Notification Consumers: Shows a dropdown for '*Notification Consumer ID:' set to 'Task Management Notifications'. There is a 'View Consumer' link and a checked 'Enable For Batch' checkbox.

Notification Templates: Shows a dropdown for '*Template Name:' set to 'SCC_TM_REMINDER'. It includes a 'View Template' link, a checked 'Enable For Batch' checkbox, and a 'Notification Item Tag' field. The 'Notification Importance:' is set to 'High'. The 'Message Text:' field contains the text: '<PRE>Dear %1' followed by a paragraph: 'The following task assigned to you has not been completed.'

Below the message text is a table defining the variables used in the message text:

Data Key	Description	Field Name	Value
1 %1	Recipient Name	Recipient Name	
2 %2	Task Title	Task Title	
3 %3	Template ID		
4 %4	Instance ID		
5 %5	Emplid	Recipient ID	
6 %6	Context Data		
7 %7	URL		
8 %8	Due Date	Due Date	

At the bottom of the template section, there is a 'Template Details' link.

You can use the Notifications Framework's Batch Notification process for sending reminder notifications to students with incomplete tasks.

Delivered with the system are the Notification Consumer ID *Task Management Notifications* (SCC_NTF_CON_20130619110938) and the notification setup for an example generic template SCC_TM_REMINDER.

An example PS Query is delivered (SCC_TM_POP_TASK_REMINDER) that you can use for this process. This query returns all the *In Progress* tasks with the data required to populate the example generic template.

Note: If you are creating your own query, then the query needs to include PEOPLE_SRCH.

In the Batch Notification page, after selecting the Query Name, click Edit Prompts to add the Academic Institution and Template ID values for the task. After selecting the Notification Consumer ID and Template Name, define the Field Name value for each of the variables used in the Message Text region.

A PS Query cannot provide the student/task specific URL to open the Student Task WorkCenter. Therefore, if you want to include a URL in the email, then define the URL in the Value field. The URL can point to the Student Center or to the Current Tasks pagelet and the student can then click the task link to complete the task. Note that the URL cannot be defined to directly open the Student Task WorkCenter for the task because the batch process is generating notifications for multiple students.

See [Understanding the Notifications Framework](#)

Updating Tasks in Batch

Use this batch process to update Activity Guide instances. You can select instances for updating based on Institution, Template ID, Existing Status, and Context Data values (such as, the STRM value for Fluid Registration). You can refine your search by selecting either Population Selection or Student Override methods.

A user with HCCPCSSA1000 CS Administration – All Pages permissions can use the Update Tasks process.

Access the Update Tasks page (**Campus Community > Task Management WorkCenter > Manage Tasks > Update Tasks**).

This example illustrates the fields and controls on the Update Tasks page. You can find definitions for the fields and controls later on this page.

Field or Control	Description
Template ID	Select a value prompted by the user’s administrator access.
Existing Status	<p>Select a value based on translate values for SCC_TM_EX_STATUS: <i>All (AL)</i>, <i>In Progress (IP)</i>, <i>Cancelled (CA)</i> and <i>Completed (CP)</i>. The default is <i>In Progress (IP)</i>.</p> <p>The process only updates instances with the selected Status. To update instances irrespective of Status, select <i>All</i>.</p> <hr/> <p>Note: An institution can deactivate codes according to need. For example, removing <i>All</i> and <i>Completed</i>, would restrict updates to <i>In Progress</i> and <i>Cancelled</i> instances.</p>

Field or Control	Description
Context Data	<p>Enter values by which to filter the updated instances.</p> <p>You cannot use <i>Institution</i> as that is filtered using Academic Institution, or <i>Student ID</i> as that is filtered using either Population Selection or Student Override.</p>
Population Selection	<p>Select <i>PS Query</i> as the Selection Tool.</p> <p>Select a Query Name based on the SCC_TM_PTAILIST record. The query should return the records for the selected Institution and Template ID that are to be updated. An example query SCC_TM_BAT_UPD, is delivered with prompts for Institution and Template ID that should be set to match the process parameters.</p> <p>You must select either Population Selection or Student Override to run the process.</p>
Student Override	<p>Select the check box to view a Students grid, in which you can search for specific EMPLIDs. You must populate the grid with at least one ID.</p>
Update Options	<p>Select a new, updated status for the selected instances: <i>In Progress (IP)</i>, <i>Cancelled (CA)</i> or <i>Completed (CP)</i>.</p> <p>Update the existing Due Date of the selected instances. You must select either or both, the New Status and Due Date, to run the process.</p>

The Update Tasks process comprises the selection of the instances and their update:

Task selection: You can run the Update Tasks process only on instances that meet all of the following conditions:

- The *Institution* parameter matches the value in the Context Data for the instance.
- The *Template ID* parameter matches the parent template of the instance.
- The Existing Status parameter is *All* or matches the instance status.
- Any other provided Context Data parameters match the equivalent values for the instance.
- If a PS Query is defined under Population Selection, the Instance ID appears in the query results.
- If Student Override is selected, the EMPLID in the Context Data for the instance matches one of the defined IDs.

Note: The instance Active flag is not considered unless added as one of the criteria in the PS Query.

Note: Even if you use a PS Query to determine the Instance IDs for the records to be updated, the process also matches the *Institution*, *Template* and *Existing Status* parameters before execution.

Task update: The process performs the following on each selected instance:

- If the user does not have security access to the instance, the instance is not updated and an error message is logged.
- If a **New Status** value is provided, the existing status value is updated and a confirmation message is logged. If the status is being updated to *Completed*, the following processing based on Task Configuration is performed.
 - Remove service indicators.
 - Create any subsequent tasks.
 - Remove any push notifications for the instance (Fluid instances only).

Note: A *Task completed* message is not saved in the task activity log.

Complete task notifications are not triggered.

The statuses of individual action items are not updated and agreements are not completed or saved on behalf of the student.

- If a new **Due Date** value is provided:
 - If the new Due Date is earlier than the existing Start Date of the instance, the Due Date of the instance is not updated and a message is logged.
 - If the new Due Date is on or after the existing Start Date, or the existing Start Date is blank, the Due Date of the instance is updated and a confirmation message is logged.
- For each updated instance, the last update date/time is updated to current date/time and the last update Operator ID is updated to the user running the process.

Related Links

[Assigning Tasks to Students in Batch](#)

Deleting Tasks in Batch

Use this batch process to delete incomplete or cancelled Activity Guide instances. You can select instances for deleting based on Institution, Template ID, Existing Status, and Context Data values. You can refine your search by selecting either Population Selection or Student Override methods.

A user with HCCPCSSA1000 CS Administration – All Pages permissions can use the Delete Tasks process.

Access the Delete Tasks page (**Campus Community > Task Management WorkCenter > Manage Tasks > Delete Tasks**).

This example illustrates the fields and controls on the Delete Tasks page.

Delete Tasks

Run Control ID: DT01 Report Manager Process Monitor [Run](#)

*Academic Institution PeopleSoft University

*Template ID Fluid Registration

*Existing Status ▾

Context Data

Career	<input type="text"/>
Career Number	<input type="text"/>
Term	<input type="text" value="0710"/>

Population Selection

Population Selection

Selection Tool [Edit Prompts](#)

Query Name [Launch Query Manager](#) [Preview Selection Results](#)

Student Override

Student Override

The fields and controls on the Delete Tasks page are the same as those on the Update Tasks page. For details, see [Updating Tasks in Batch](#).

The Delete Tasks process comprises the selection of the instances and their deletion:

Task selection: You can run the Delete Tasks process only on instances that meet all the required conditions described in the Update Task instance selection process.

Task delete: If the user running the process has security access, the process deletes the instance record and associated action items for every selected instance, and a confirmation message is logged.

Note: The Delete Tasks process does not delete the Agreement records associated with the instances being deleted.

Related Links

[Viewing or Updating a Student Agreement](#)

Searching for Records and Using Search/Match

Understanding the Difference Between Search Box Search and Search/Match

The difference between record search from search dialog pages and using Search/Match is this: You use search box pages to retrieve existing records using limited search criteria to view or update data, and you use Search/Match to use a larger set of search criteria that detect duplicate or multiple records in your database or to identify different records that contain duplicate data that should uniquely identify only one ID.

Maintaining the integrity of IDs and their associated data is important toward maximizing system features and functionality. Search/Match helps you to prevent the entry of duplicate or multiple records by determining whether a person (EMPLID) or an organization (EXT_ORG_ID) already exists in your database before creating (or recreating) the record.

You use Search/Match to define rules and search parameters that determine if duplicate or multiple records exist with the uniquely identifying data relevant to your business processes. You can configure which results fields to display with the returned matching IDs. You can also choose to fully display, mask, or partially mask result field values based on business processes and the level of security that your users need.

You can reinforce the evaluation of possible duplicates by setting up Search/Match to run automatically at save time when a user creates a new ID.

Related Links

[Understanding Automatic Search](#)

Understanding Search Box Searches

To view or update data on an existing record, select the menu item for the type of data to view and enter key criteria on the related search box page. Person ID (or just ID) is often the default key criteria. If you enter nothing and click **OK**, the system searches for all records with IDs. However, because all records have IDs, the list is much too large for the system to display at one time. You must enter some of the characters of the ID, or any of the other key criteria.

For example, you might want to determine which languages Bernice Smith speaks proficiently enough to translate. You would select **Campus Community > Personal Information > Biographical > Personal Attributes > Languages**. A search box page appears with a list of the search options for people, including: ID, campus ID, national ID, first name and last name. (Different or additional search

criteria might appear depending on the type of data associated with the menu item that you select, or if you are searching for records for organizations.)

To narrow your search and minimize the system's record retrieval time, enter either the individual's unique ID or the national ID. If you do not know either of these, enter any of the criteria that you know. For example, you could select the **Last Name** option and enter *Smith*.

The system searches for and retrieves all records containing the data that you enter. It lists the resulting records in rows at the bottom of the page. Select the row with the specific data that you require. For example, if you enter only *Smith* in the **Last Name** field, rows for all individuals with the last name of *Smith* are listed in the search results. You would select the row with the first name *Bernice*.

If you want to search on more fields or want to search on all of the data that you know about an individual to control the search, you can click **Advanced Search** and enter that data.

Entering criteria on a search box page in Basic Search mode

Languages
Enter any information you have and click Search. Leave fields blank for a list of all values.

Find an Existing Value

Search by: Last Name ▼ begins with GARRETT

Entering criteria on a search box page in Advanced Search mode

Languages
Enter any information you have and click Search. Leave fields blank for a list of all values.

Find an Existing Value

ID: begins with ▼

Campus ID: begins with ▼

National ID: begins with ▼

Last Name: begins with ▼ GARRETT

First Name: begins with ▼

Case Sensitive

Viewing search box search results from Basic Search or Advanced Search modes

Search Results									
View All									First ◀ 1-5 of 5 ▶ Last
ID	Name	Gender	Date of Birth	Campus ID	National ID	National ID Country	NID Short Description	Last Name	First Name
FADLCD0020	Garrett,Linda A	Female	***j****	(blank)	*****	USA	SSN	GARRETT	LINDA
FAPK0140	Garrett,Angel P	Female	***j****	(blank)	*****	USA	SSN	GARRETT	ANGEL
HXSHPM14	Garrett,Suzanne	Female	***j****	(blank)	*****	USA	SSN	GARRETT	SUZANNE
SF0003	Garrett,Andrew	Male	***j****	(blank)	*****	USA	SSN	GARRETT	ANDREW
SFTC00303	Garrett,Linda	Female	***j****	(blank)	*****	USA	SSN	GARRETT	LINDA

The values for the **Date of Birth** and **National ID** fields in the sample page are masked. You can choose to mask, partially mask, or fully display result field values using demographic data access (DDA) security.

See “Applying Demographic Data Access Security” (Campus Solutions Application Fundamentals).

Using Search/Match

Search/Match enables you to define search parameters that administrative users can use to determine whether a potential duplicate ID exists in the database.

See [Understanding Search/Match](#)

This section provides an overview of Search/Match, lists prerequisites, and discusses how to:

- Select criteria for a search.
- View search results.
- Determine relations with an institution.

Prerequisites

Before you can use Search/Match, you must set up Search/Match.

Pages Used for Search/Match

<i>Page Name</i>	<i>Definition Name</i>	<i>Navigation</i>	<i>Usage</i>
Search Criteria	HCR_SM_SEARCH	<ul style="list-style-type: none"> • Campus Community > Personal Information > Search/Match > Search Criteria • Campus Community > SEVIS > Search Tools > Search/Match > Search Criteria • Campus Community > Organization > Search for Organization > Search Criteria • Set Up SACR > System Administration > Utilities > Search/Match > Search/Match > Search Criteria • Student Admissions > Application Entry > Search/Match > Search Criteria 	Enter criteria to search for duplicate or multiple records.

Page Name	Definition Name	Navigation	Usage
Search Criteria (continued)	HCR_SM_SEARCH	<ul style="list-style-type: none"> • Student Admissions > Application/Transcript Loads > Search/Match > Search Criteria • Student Admissions > External Test Score Processing > Search/Match > Search Criteria • Student Recruiting > Maintain Prospects > Search/Match > Search Criteria • Student Recruiting > Student Recruiters > Search/Match > Search Criteria • Student Recruiting > External Test Score Processing > Search/Match > Search Criteria 	Enter criteria to search for duplicate or multiple records.
Search Criteria (continued)	HCR_SM_SEARCH	<ul style="list-style-type: none"> • Contributor Relations > Constituent Information > Organizations > Search for Organization > Search Criteria • Contributor Relations > Constituent Information > People > Search/Match > Search Criteria 	Enter criteria to search for duplicate or multiple records.
Default Search Result	HCR_SM_USERDFLT	Click the User Default link on the Search Criteria page	Assign a search result code for the user ID to use as a default value for a specific search type.

Page Name	Definition Name	Navigation	Usage
Search Results	HCR_SM_RESULTS	Enter criteria on the Search Criteria page and click Search or click one of the search by order number Selective Search buttons to launch a manual search.	View Search/Match results of a manual search and investigate potential duplicate IDs. Note: Do not confuse this page with the Search Results setup page that has a similar object name (HCR_SM_RESULT) and on which you define search result fields.
Relations With Institution Detail	SEARCH_MATCH_SEC	Click the Relations With Institution link on the Search Results page.	Determine the type of relations that the individual has with your institution and further clarify whether this is the individual for whom you are searching.

Selecting Criteria for a Search

Access the Search Criteria page (**Campus Community > Personal Information > Search/Match > Search Criteria**).

This example illustrates the fields and controls on the Search Criteria page (1 of 2). You can find definitions for the fields and controls later on this page.

Search Criteria

Search Type: Person Ad Hoc Search

Search Parameter: PSCS_TRADITIONAL CS_Person_Traditional

Search Result Rule

Search Result Code: PSCS_TRAD_MASI CS_Pers Traditional Result Mask
[User Default](#)

Search Criteria	
Search Fields	Value
Address Line 1	<input type="text"/>
City	<input type="text"/>
First Name Search	JOHN
Last Name Search	SMITH
Date of Birth	<input type="text"/> <input type="button" value="B"/>
Gender	<input type="text"/>
National Id	<input type="text"/>

This example illustrates the fields and controls on the Search Criteria page (2 of 2). You can find definitions for the fields and controls later on this page.

Search by Order Number		
Search Order	Description	
10	Name,Addr,City,Bday,Gender,SSN	<input type="button" value="Selective Search"/>
20	SSN Only	<input type="button" value="Selective Search"/>
30	Name,Bday,Gender	<input type="button" value="Selective Search"/>
40	Name,Gender	<input type="button" value="Selective Search"/>
50	Name Only	<input type="button" value="Selective Search"/>

Field or Control	Description
Search Type	The system displays the search type (<i>Person or Organization</i>) selected to access the page.
Search Parameter	<p>Displays the parameter code selected to access the page. The search parameter prompt on the search dialog page allows you to select only the search parameters to which your security roles permit you access.</p> <p>Depending on your responsibilities, you might need to access the Search/Match page several times a day. If you use the same search parameter frequently, you can save it prior to accessing the Search/Match page by clicking the Save Search Criteria link on the search dialog page. Then, in the future, you can select it from the Use Saved Search prompt.</p>
Ad Hoc Search	<p>The system selects this to indicate that the Search Parameter code is set to perform a custom ad hoc search.</p> <p>An ad hoc search enables you to bypass the institution's predefined search standards to perform a custom search without predefined operands and without limiting the characters to evaluate. For example, an ad hoc search might be <i>first name equals John</i>, whereas, a non-ad hoc search might be set to search only on the first three characters of the first name (in this case, <i>Joh</i>).</p> <p>For an ad hoc search, the Search Criteria page displays the Search fields set up inside the search parameter code that you selected; and an Operand field appears for each search field. The Operand field enables you to perform a search that begins with, contains, or equals the search value that you enter.</p> <p>Also, for ad hoc searches, the Search by Order Number area of the page does not apply and therefore does not appear.</p> <p>See Defining Search Parameters.</p>

Search Result Rule

Field or Control	Description
Search Result Code	Select the search result code to use for displaying the results of this search. The search result code contains all of the information regarding how to display the IDs retrieved by Search/Match and what data to return to help you quickly determine whether an ID already exists for the constituent for which you are looking.

Field or Control	Description
User Default	<p>Click to access the Default Search Result page where you can select a search result code to use as a default value for this search type.</p> <p>The system permits one default search result code per search type for each user ID.</p>
Carry ID Reset	<p>Click to reset a carried ID to <i>New</i>.</p> <p>On the Search Results page, you can select to carry an ID as you access pages to further investigate a potential duplicate. When you click Carry ID Reset, the system stops carrying the selected ID and uses an ID of <i>New</i> instead. This is especially useful when you need to access pages that create new IDs.</p>

Search Criteria

Field or Control	Description
Search Fields	The system displays each of the search fields associated with the search parameter that you selected.
Operand	<p>These fields appear only when the search parameter permits ad hoc searches. When the parameter permits ad hoc searches, the system selects the Ad Hoc Search check box and hides the Search by Order Number area of the page.</p> <p>Select the operand to perform the search. The valid values are <i>Begins With</i>, <i>Contains</i>, and <i>Equals</i>. These values are delivered as translate values and should not be changed.</p>
Value	For each search field that you specify, enter the value to search for. If predefined values are available (such as for gender), you can select from them from the prompt. If no predefined values exist, you can type the data directly into the value field.
Clear All	Click this button to clear all entries in the Value fields.

Field or Control	Description
Search	<p>Click this button to launch a search on all of the values that you entered and to retrieve results for the most restrictive search order number defined in the Search Parameter that you selected. When the search is complete, the system transfers you to the Search/Match Results page.</p> <hr/> <p>Note: When you click Search, the system searches only for the data specified. It filters the search orders that are defined for the Search Parameter that you selected. For example, if Search/Match finds at least one potential matching ID at search order number 10, it will stop the search and display the results obtained at search order number 10. If no potential matching IDs are found, the search continues to the next search order number, and so on. If you want to search using a specific Search Order number, use the Selective Search button for that order number.</p> <hr/>

Search by Order Number

This area of the page appears only if the Ad Hoc Search box is not selected.

When you enter criteria in the **Value** fields, the **Selective Search** button for the search order defined with the fields becomes available.

Click the **Selective Search** button to conduct specific searches.

When the search is complete, the system transfers you to the Search Results page.

Viewing Search Results

Access the Search Results page (enter criteria on the Search Criteria page and click **Search** or click one of the search by order number **Selective Search** buttons to launch a manual search).

This example illustrates the fields and controls on the Search Results page for a manual search. You can find definitions for the fields and controls later on this page.

Search Results

Search Type: Person **Ad Hoc Search**

Search Parameter: PSCS_TRADITIONAL CS_Person_Traditional

Result Code: PSCS_TRAD_MASK CS_Pers Traditional Result Mask

▼ **Search Results Summary** [Return to Search Criteria](#)

Number of ID's Found: 19

Search Order Number: 50 Name Only

Search Results								
Customize Find View All First 1-20 of 28 Last								
Results	Results2	Additional Information						
		EmpID	Name Type	Name Effective Date	First Name	Middle Name	Last Name	
1	Carry ID Detail	0027	PRF	10/15/2004	John		Smith	
2	Carry ID Detail	0027	PRI	10/15/2004	John		Smith	
3	Carry ID Detail	AD5024	PRF	03/23/2001	John		Smith	
4	Carry ID Detail	AD5024	PRI	03/23/2001	John		Smith	
5	Carry ID Detail	AD6000	PRI	01/21/2002	Joanne		Smith	
6	Carry ID Detail	AD6000	PRF	01/21/2002	Joanne		Smith	
7	Carry ID Detail	AD6000	PRI	01/22/2002	Joanne		Smith	
8	Carry ID Detail	CC0066	PRF	07/13/2004	Johnat		Smith	
9	Carry ID Detail	CC0066	PRI	07/13/2004	Johnattan	William	Smith	
10	Carry ID Detail	CC0067	PRI	06/24/2004	Johnattaniel	Louis	Smithzierburgh	
11	Carry ID Detail	E504	PRI	01/01/1993	Joan		Smith	
12	Carry ID Detail	FA0080	PRI	06/26/1998	Johanna		Smith	
13	Carry ID Detail	FA0080	PRF	07/09/1998	Johanna		Smith	
14	Carry ID Detail	FA0080	PRI	07/09/1998	Johanna		Smith	

This example illustrates the fields and controls on the Search Results page, Additional Information tab (for an automatic search). You can find definitions for the fields and controls later on this page.

Search Results					
Customize Find View All First 1-7 of 7 Last					
Results	Results2	Additional Information			
		EmpID			
1	Carry ID Detail	0027	Person Organizational Summary	Relations With Institution	
2	Carry ID Detail	MUTA084	Person Organizational Summary	Relations With Institution	
3	Carry ID Detail	MUIF025	Person Organizational Summary	Relations With Institution	
4	Carry ID Detail	FA0080	Person Organizational Summary	Relations With Institution	
5	Carry ID Detail	FA0080	Person Organizational Summary	Relations With Institution	
6	Carry ID Detail	FA0080	Person Organizational Summary	Relations With Institution	
7	Carry ID Detail	0027	Person Organizational Summary	Relations With Institution	

When you enter criteria on the Search Criteria page and click **Search** or any of the search by order number **Selective Search** buttons, the system launches the search and transfers you to the Search Results page with the results displayed as shown in the sample page above.

For an automatic search, the Search Results page is displayed as shown in the sample page below. That is, if Search/Match is set to launch automatically with both the search parameter permission and search result permission configured with a component name that allows the creation of IDs. When you try to add an ID on a component that is set up that way and at save time, Search/Match detects potential duplicates, the Search Results page displays a warning message indicating that at least one potential ID in the database matched the data that was entered to create the ID.

This example illustrates the fields and controls on the Search Results page, Results tab (automatic search). You can find definitions for the fields and controls later on this page.

Search Results

WARNING: Potential duplicates were found - this person may already exist in the database.
Refer to the list below for possible matches to the person you are adding.
After you click the return button at the bottom of the page, you'll be asked whether you want to continue adding this new person, or cancel this operation.

▼ Match Criteria

Required	Description	Usage	Search Value
<input checked="" type="checkbox"/>	First Name Search	Begins With	JO
<input checked="" type="checkbox"/>	Last Name Search	Begins With	SMIT
<input checked="" type="checkbox"/>	Gender	Equals	U

▼ Search Results Summary

Number of ID's Found: 4

Search Order Number: 40

Search Results
Customize | Find | View All | First 1-7 of 7 Last

Results

Results2

Additional Information

[EE]

			EmpID	Name Type	Name Effective Date	First Name	Middle Name	Last Name
1	Carry ID	Detail	0027	PRF	10/15/2004	John		Smith
2	Carry ID	Detail	MUTA084	PRI	01/01/1996	Joe		Smith
3	Carry ID	Detail	MUIF025	PRI	01/01/1996	Jose		Smits
4	Carry ID	Detail	FA0080	PRI	07/09/1998	Johanna		Smith
5	Carry ID	Detail	FA0080	PRI	06/26/1998	Johanna		Smith
6	Carry ID	Detail	FA0080	PRF	07/09/1998	Johanna		Smith
7	Carry ID	Detail	0027	PRI	10/15/2004	John		Smith

See [Understanding Automatic Search](#).

On either version of the Search Results page, you can view the list of results returned by the search, view the details of any record returned in the search, and click **Carry ID** to have the system carry the ID forward as you subsequently access pages for further investigation.

Search Results Summary

Field or Control	Description
Number of ID's Found	<p>Displays the number of IDs that met the search criteria.</p> <p>This number may be smaller than the number of rows returned in the Search Results grid because the grid might include the same ID multiple times. If the name field is included in the search result code selected, the search returns rows for each name type and effective date that match the search criteria entered. If the national ID field is included in the search result code, the search returns rows for each national ID entered for the record matching the search criteria.</p>
Search Order Number	<p>Indicates the search order number at which results were found and indicates how precise the search was—the lower the number, the more restrictive the search and the greater the chance of having found duplicate IDs. This number can be used as an indicator of how close the returned IDs match the criteria entered.</p>

Search Results

Columns appear on the Results and Results 2 tabbed pages based on the search result code selected. Depending on the user's role security, some values in the columns might be masked, partially masked, or fully displayed.

Field or Control	Description
Carry ID	<p>Click this button for the system to capture and carry the ID to the ID field of the search box on the pages that you subsequently access so that you do not need to remember the ID.</p>
Detail	<p>The Detail link appears if the selected search result code was configured to provide the user with a link to a page for more information about an ID.</p>

Search Results, Additional Information Tab

This tab appears only when the search type is *Person*.

Field or Control	Description
Person Organizational Summary	Click to access the Person Organizational Summary page, on which you can review the status of this person of interest record.
Relations With Institution	<p>Click to access the Relations with Institution Detail page, on which you can determine the type of relations that the individual has with your institution and further clarify whether this is the individual for whom you are searching.</p> <hr/> <p>Note: The Relations With Institution link appears only if <i>Student Administration</i> or <i>Contributor Relations</i> is selected on the Installation Table (INSTALLATION_TB1) page.</p> <hr/>

Determining Relations with an Institution

Access the Relations with Institution Detail page (click the **Relations With Institution** link on the Search Results page).

Field or Control	Description
Currently Is A(n)	<p>When selected, indicates that the individual currently has the associated relation to your institution.</p> <hr/> <p>Note: PeopleSoft Contributor Relations uses the abbreviations on this page in its CR search.</p> <hr/>

Working with Constituent Transaction Management

Understanding CTM

The CTM framework is used for performing Campus Solutions transactions that require staging of the data prior to posting to production tables.

Staging of the data is done with the use of temporary records (staging records) that mimic the production records. Because transactions normally include constituent data, CTM standardizes the handling of that data and offers a framework to process the data that is specific to the transactions. Constituent data includes data related to the person available in the Campus Solutions data models. Examples of constituent data include Name, Gender, Address, Email and Driving Licenses.

The following diagram shows that a CTM transaction contains constituent data and transaction-specific data.

CTM and transaction data

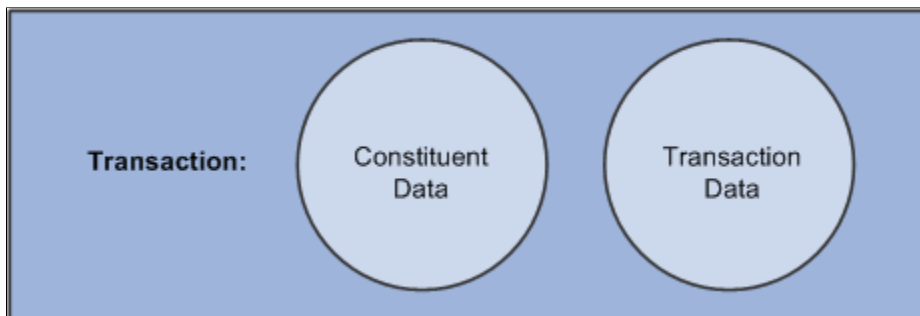

By staging data into temporary records prior to saving into the appropriate production records, CTM assures consistency for handling and processing the data and offers configurability to adjust to all transactions specificities.

A transaction defined with CTM can be *online* (web-based transactions performed by a self-service user) or *offline* (through batch loads). In the case of transactions performed online, temporarily saving the data entered by a self-service user allows for data retrieval when the user returns to complete the transaction. Temporarily saving the data also allows for full completion of a transaction even when the system has not assigned an EMPLID to a person. For example, if an online transaction takes too long to complete, the self-service user can save the data and come back later. The data entered is saved into the staging tables and can be retrieved when the user comes back to complete the transaction. When finally submitting the transaction, all data stays saved inside the staging tables until Search/Match is called to identify an EMPLID. CTM keeps the data in temporary tables, thereby allowing full completion of a transaction.

An external user interface can use CTM with the New User Registration functionality to create a user profile for a guest user or to authenticate a returning user.

See [Understanding New User Registration](#)

When a transaction is generated, the system uses Search/Match or External Search/Match to look for constituent data in your production environment (based on the Search/Match parameters) that matches the constituent data in the transaction. Each defined CTM transaction can have its own Search/Match setup. You can therefore determine the rules for creating a new ID, updating an existing ID, suspending or ignoring a record. CTM validates the constituent data entered as well as the data entered for the transaction itself. The system stores the constituent and the transaction-specific data in staging tables. If there are validation errors or if Search/Match determines that the incoming constituent record should be suspended or ignored, use the Constituent Staging and the transaction staging components to correct the data. When the staged data passes all validations, CTM posts both the constituent and the transaction-specific staged data to the predefined production tables. The posting is done based on rules that you define through the Data Update Rule functionality. You can post transactions individually or by batch to the Campus Solutions database.

See [Processing Staged CTM Transactions](#).

CTM offers three ways for processing the staged data and posting to production records:

- *Realtime*: At the time the self-service user saves or submits an online transaction.
- *Manual*: At the time an administrative user individually reviews the staged data using the Constituent Staging component or using the transaction staging component and manually posts the constituent and/or the transaction-specific data to the production table.
- *Batch*: Using the Transaction Management process to post multiple staged rows at the same time. The Transaction Management process can be used for online transactions for which you do not want to do real-time processing or for data loaded through a batch utility such as the File Parser.

CTM uses web services and a number of application classes to facilitate the staging and posting of constituent and related transaction data into appropriate production tables. To do this, CTM takes full advantage of the Entity Registry framework. All constituent and transaction staging records are tied to an Entity Name.

See [Setting Up Entity Registry](#).

The CTM framework can be seen as a provider of processing services and the CTM transactions as consumers. At the time of delivering the CTM framework, the following consumers of CTM are delivered with the system:

- Admission Applications Web Service (AAWS) admission transaction.
- New User Registration framework.
- UCAS batch process transaction used by the United Kingdom customers.
- Delegated Access (DA)
- Prospect Data Loads (PDL)

Note: The delivered consumers of CTM are fully implemented and with some required setup, they are ready for you to use. They are also referred as CTM transactions. The delivered consumers are documented in their respective sections. To create new consumers of CTM, see [Developer Reference for Creating a New CTM Consumer](#).

CTM Framework

CTM framework enables you to set up your own transactions or create your own consumers, whether they are to be performed online by a guest, a self-service user or an administrative user, or performed by batch. This section explains how to set up CTM, how to create your own transactions by taking full advantage of CTM framework, and how the constituent and the transaction-specific data are processed from staging to production tables.

Examples of transactions that CTM can process:

- Batch transactions (*offline* transactions): Transactions that come from an external file that needs to be staged to first allow data processing specific to Campus Solutions and to trigger Search/Match to avoid entering duplicates into the system. Because you do not necessarily know the quality of the data contained in the file and want to make sure to avoid creating duplicates, keep the file data in the temporary tables, and when ready post to the appropriate production tables.
- Self-service transactions (*online* transactions) that can take too long to complete and therefore should allow the self-service user to *Save* and come back later to continue and *Submit*. The saved data, because incomplete and potentially contains erroneous information should be staged and not be posted until the transaction is submitted and free of validation errors. Saving the data into temporary records allows you to display the previously entered information when the self-service user comes back to complete the transaction.
- Self-service transactions (*online* transactions): You created your own web-based online transaction that can be accessed and performed by anybody in the world. Your institution may or may not know these users and they may never complete their transaction. Using CTM, the system stores the entered information into temporary tables and performs Search/Match or External Search/Match to identify an EMPLID. The data is only posted to the production records when the self-service user is serious and confirms the data entered.

Note: For the online transactions, the biggest advantage to use CTM and therefore save data into staging tables is that it allows a self-service user to fully complete an online transaction even though an EMPLID is not yet assigned. Only once the data is saved or submitted (depending on how you configure your CTM transaction) Search/Match or External Search/Match is used to create or identify an ID. The process behind the scenes to assign an EMPLID is completely transparent to the online user.

Warning! Setting up a CTM transaction requires technical knowledge of the record structure used by the transaction.

Using Staging Tables

There are two types of staging tables:

- Constituent staging records.
- Transaction-specific staging records.

The constituent staging records are reusable across all transactions and therefore delivered with your system as part of CTM. The transaction-specific staging records must be created based on the transaction you want to perform.

A staging record is modeled after the corresponding production record, but its structure varies slightly:

- It is keyed by Temporary ID (SCC_TEMP_ID) instead of ID (EMPLID).
- It is never effective-dated (even if the matching production record is effective-dated). This is because the data entered in staging records can be updated, modified many times prior to be posted to production. Only at that time, the data is current and therefore the production record gets set with the date the data is posted.

The constituent data is saved in the delivered constituent staging records (see the following list of delivered constituent staging records). The transaction-specific data is stored in the transaction staging records. These staging records are either delivered with your system in the case of fully implemented delivered CTM consumers transactions (such as the AAWS admission transaction) or created by you for the transaction of your choice.

See [Developer Reference for Creating a New CTM Consumer](#), “Step 1: Creating or Extending Staging Tables.”

Constituent Staging Records

The following constituent staging records are delivered for the matching production records:

Staging Record Definitions	Staging Record Names	Production Record Names
Academic History *	SCC_STG_ACADHST	ACAD_HISTORY
Academic Interests Header *	SCC_STG_ADMIHD	ADM_INTRST_HDR
Address	SCC_STG_ADDR	HCR_PER_ADDR_I
CHESSN (AUS)	SCC_CHSNAUS_STG	SCC_CHESSN_AUS
CHESSN Prior HEP (AUS)	SCC_PRHEPAU_STG	SCC_PRV_HEP_AUS
CHESSN Year 12 (AUS)	SCC_YR12_AU_STG	SCC_YEAR12_AUS
Citizenship	SCC_STG_CITZN	SCC_CITIZSHIP_I
Citizenship History (AUS)	SCC_CITZHST_STG	SCC_CITIZ_HIST
Disability	SCC_STG_DISBLTY	HCR_DISABL_I
Diversity	SCC_STG_DIVRSTY	SCC_DIVERS_I
Drivers License	SCC_STG_DRV_LIC	SCC_DRVR_LIC_I
Email Address	SCC_STG_EMAIL	HCR_PER_EMAIL_I

Staging Record Definitions	Staging Record Names	Production Record Names
Emergency Contact	SCC_STG_EMG_CNT	SCC_EMERG_CNT_2
External System Key	SCC_STG_EXT_SKY	EXTERNAL_SYSKEY
Extracurricular Activity	SCC_STG_EXTRACU	EXTRACUR_ACTVTY
General Materials *	SAD_STG_GEN_MAT	GENL_MATERIALS
HESA Person (UK)	SCC_HE_PERS_STG	SCC_HE_PERSON
Higher Ed Student Data (NLD)	SSR_STD_NLD_STG	SSR_STUDENT_NLD
Honors and Awards	SCC_STG_HON_AWD	HONOR_AWARD_CS
Language	SCC_STG_LANG	SCC_LANGUAG_TBL
Licenses and Certificates	SCC_STG_LICCERT	SCC_LICCERT_TBL
Memberships	SCC_STG_MBRSHIP	SCC_MBERSHIP_TBL
Names	SCC_STG_NAMES	SCC_PER_NAME_I2
National ID	SCC_STG_NID	HCR_PER_NID_I
Person Data (CAN)	SCC_PDECAN_STG	HCR_PER_CAN_I
Person Data (NZL)	SCC_PER_NZL_STG	SCC_PERSONL_NZL
Person Data (USA)	SCC_STG_PRSDATU	HCR_PER_USA_I
Person Data Effdt	SCC_STG_PDE	SCC_PER_EFF_H
Person Relationship	SCC_STG_RLSHIPS	RELATIONSHIPS
Person SA	SCC_STG_PERSA	PERSON_SA
Personal Details	SCC_STG_PERSBIO	SCC_PERS_BIOG
Phone	SCC_STG_PHONE	HCR_PER_PHONE_I

Staging Record Definitions	Staging Record Names	Production Record Names
Port of Entry Data	SCC_STG_SEVPOED	SEV_POE_DATA
Publications	SCC_STG_PUBLIC	SCC_PUBL_I
Religious Preference	SCC_STG_RELPREF	RELIGIOUS_PREF
Residency Official	SCC_STG_RES_OFF	RESIDENCY_OFF
Residency Self	SCC_STG_RES_SLF	RESIDENCY_SELF
Scholarship Data (NLD)	SSR_SCL_NLD_STG	SSR_SCHOLAR_NLD
Staged User Preference	SCC_STG_ENT_WRK	SCC_PRD_ENT_WRK
Student Bank Account (NLD)	SSF_BNK_NLD_STG	SSF_BANKACC_NLD
Student Career (Constituent)	SCC_STG_STD_CAR	STDNT_CAREER
Student Correspondence (NLD)	SSR_COR_NLD_STG	SSR_CORRSPN_NLD
Student Data (AUS)	SSR_STD_DAT_STG	SSR_STDNT_DATA
Student Information (NLD)	SSR_INF_NLD_STG	SSR_STD_INF_NLD
Student Names (NLD)	SSR_NME_NLD_STG	SSR_NAMES_NLD
Student Nationalities (NLD)	SSR_NAT_NLD_STG	SSR_EMP_NAT_NLD
Student Prior Education (NLD)	SSR_EDU_NLD_STG	SSR_STD_EDU_NLD
Student Report (CAN)	SSR_STG_CNRP_ST	CAN_RPT_STDNT
Test Score *	SCC_STG_TEST	STDNT_TEST
Tribal Affiliation (NZL)	SCC_IWI_TBL_STG	SCC_IWI_TBL
Visa Permit Data	SCC_STG_VISPMTD	SCC_VISA_PMT_I
Visa Permit Data (NLD)	SCC_STG_VP_NLD	SCC_VISAPMT_NLD

Staging Record Definitions	Staging Record Names	Production Record Names
Visa Permit Support	SCC_STG_SUP_NLD	SCC_VISA_SUP_I
Visa Permit Support (NLD)	SCC_STG_VIS_SUP	SCC_VISAPMT_NLD
Work Experience	SCC_STG_WORKEXP	SCC_PRIORWORK

* For coding purposes, this Recruiting and Admissions record is a child of the Constituent entity. The record is not displayed in the Constituent Staging component and cannot be configured for data update rule.

Note: You can extend this list or modify an existing staging record.

The following table is a comparison of the structure of the address staging record with the structure of its matching production record.

Production Record (HCR_PER_ADDR_I)	Staging Record (SCC_STG_ADDR)
EMPLID - <i>Key</i>	SCC_TEMP_ID - <i>Key</i>
ADDRESS_TYPE - <i>Key</i>	ADDRESS_TYPE - <i>Key</i>
EFFDT - <i>Key</i>	SCC_ADDRESSAREA
EFF_STATUS	ADDR_TYPE_DESCR
ADDRESS_NPC_SBR	ADDRESS_SBR
COUNTRY	COUNTRY
ADDRESS1	ADDRESS1
ADDRESS2	ADDRESS2
ADDRESS3	ADDRESS3
ADDRESS4	ADDRESS4
CITY	CITY
NUM1	NUM1

<i>Production Record (HCR_PER_ADDR_I)</i>	<i>Staging Record (SCC_STG_ADDR)</i>
NUM2	NUM2
HOUSE_TYPE	HOUSE_TYPE
ADDR_FIELD1	ADDR_FIELD1
ADDR_FIELD2	ADDR_FIELD2
ADDR_FIELD3	ADDR_FIELD3
COUNTY	COUNTY
STATE	STATE
POSTAL	POSTAL
GEO_CODE	GEO_CODE
IN_CITY_LIMIT	IN_CITY_LIMIT
ADDRESS1_AC	ADDRESS1_AC
ADDRESS2_AC	ADDRESS2_AC
ADDRESS3_AC	ADDRESS3_AC
CITY_AC	CITY_AC
REG_REGION	REG_REGION
	SCC_AUDIT_SBR
	SCC_ROW_ADD_OPRID
	SCC_ROW_ADD_DTTM
	SCC_ROW_UPD_OPRID
	SCC_ROW_UPD_DTTM

Transaction Staging Records

Campus Solutions provides transaction staging tables only for out-of-the-box transactions like AAWS admissions, Delegated Access (DA), and so on. So if you create a transaction related to admissions data, you could use those staging tables. However, If you create a new consumer of CTM, you need to create your own transaction staging tables based on the production records used by the transaction you want to integrate with CTM. For example, if you want to create an Online Donation transaction, you will need to create staging tables for the production tables used when entering a donation.

The following table is a comparison of the structure of the admissions academic interest staging record with the structure of its matching production record.

<i>Production Record (ADM_INTERESTS)</i>	<i>Staging Record (SCC_STG_ADMINT)</i>
EMPLID - <i>Key</i>	SCC_TEMP_ID - <i>Key</i>
ACAD_CAREER - <i>Key</i>	ACAD_CAREER - <i>Key</i>
EFFDT - <i>Key</i>	
SEQNUM - <i>Key</i>	SEQNUM - <i>Key</i>
EXT_SUBJECT_AREA	EXT_SUBJECT_AREA
DESCR	DESCR
LS_DATA_SOURCE	LS_DATA_SOURCE
PRIORITY	PRIORITY
	SCC_AUDIT_SBR
	SCC_ROW_ADD_OPRID
	SCC_ROW_ADD_DTTM
	SCC_ROW_UPD_OPRID
	SCC_ROW_UPD_DTTM

Using Self-Service and Administrator Modes for Online CTM Transactions

When you create a CTM online user interface, you may want to create a self-service version (for example for your students to use) as well as an administrative version. The user interface for the latter can be designed for localized data entry requirements. The administrative version would allow an administrator to login and perform the transaction on behalf of a self-service user. In this case there will be no need to create a new User ID (performed through New User Registration) since the administrator will perform the transaction just as if a standard PeopleSoft Campus Solutions administrative component was used. However, you would take full advantage of the CTM utilities such as storing the data into staging tables, reviewing the staged data, and when ready promote the staged data to the production tables in accordance with the data update rule selected for the transaction. If the administrator did not know the ID for the self-service user, Search/Match could be automatically triggered to find a potential matching candidate.

There is no specific CTM setup to indicate if the transaction is being performed in self-service or in administrator mode. Instead, the logic is done directly from inside a user interface and in the web service request messages you create for a transaction. When administrator mode is used, the request message sent should include the <SCC_ADMIN_MODE> tag as well as any additional input parameters an administrator should populate, if any. When self-service mode is used, the tag should not be present. It is the user interface that dictates if the self-service or the administrator mode is used.

For examples of how this is done, see the request messages delivered with the following AAWS admission transaction service operations:

- SAD_CREATEAPPL
- SAD_GETAPPL
- SAD_GETAPPLS
- SAD_GETATTACH
- SAD_SAVEAPPL
- SAD_SUBMITAPPL

For example, the request message for SAD_CREATEAPPL service operation when administrator mode is used includes:

```
<?xml version="1.0"?>
<SAD_CREATEAPPL_REQ xmlns="http://xmlns.oracle.com/Enterprise/services"
  <SCC_ADMIN_MODE>
    <INSTITUTION>PSUNV</INSTITUTION>
    <ADM_APPL_CTR>BUSN</ADM_APPL_CTR>
    <EMPLID>CCCM0001</EMPLID>
  </SCC_ADMIN_MODE>
```

In this case, INSTITUTION, ADM_APPL_CTR and EMPLID are input parameters passed when administrator mode is used.

Note: Specifying an EMPLID as part of the input parameters is optional when administrator mode is used. This is to cover the scenarios where the administrator may not know the ID for the person he or she is performing a transaction for. When no ID is passed, Search/Match attempts to identify or create an ID once the transaction is saved or submitted. If the administrator does specify the ID, Search/Match is not invoked and the ID is used to process the transaction.

Note: As part of the List of Values framework, the List of Values Setup page offers a way to set specific value when self-service mode is used and same for when administrator mode is used. The request message for the List of Values operation (SCC_LOV_REQ message) includes or does not include the <SCC_ADMIN_MODE> to differentiate the requests.

See [Setting Up List of Values](#).

Note: The new user registration service operations (SCC_USERREG_CREATEACCT and SCC_USERREG_AUTHENTICATE) do not support the Administrator mode because only the self-service users can authenticate or create a user account for themselves.

New User Registration and CTM

This section discusses integrating New User Registration with a CTM online transaction.

The New User Registration framework consumes CTM. Delivered with your system is the New User Registration CTM transaction called NEW_USER_REGISTRATION. Only one CTM transaction can be set up for New User Registration transaction in your system. You can modify its configuration, but do not change its name.

The New User Registration online transaction can be combined with any other CTM online transactions. In fact, performing an online transaction might be done by anybody in the world, therefore unknown by your system (unknown user or guest user), or by somebody that already has a User ID and a password (returning user).

When a user profile is created for a guest through New User Registration, an EMPLID is not associated. Once authenticated to your system, CTM allows the guest to complete a subsequent online transaction without having an ID (EMPLID) assigned. This is because the CTM transactions are keyed by Temporary ID (SCC_TEMP_ID) and not EMPLID. After the guest saves or submits the CTM online transaction, Search/Match is triggered and creates or identifies an EMPLID. When New User Registration is combined with a CTM online transaction, CTM also updates the user's user profile with the EMPLID retrieved or created by Search/Match.

See [Understanding New User Registration](#).

Integrating New User Registration with a CTM Online Transaction

Delivered with the New User Registration framework is a sample login page that can be customized for your institution security needs to allow a guest or a returning user to sign into your system. The sample login page allows the guest to create a new user ID and password and a returning user to use an existing user ID. This page is fully implemented with the CTM Transaction Code NEW_USER_REGISTRATION. Also delivered with the New User Registration framework is the concept of a New User Registration Context. In the New User Registration Context setup page,

you define what should be the target page the user should be transferred to after being successfully authenticated. The target page can be the self-service online page used by your CTM online transaction. For example, if your CTM online transaction is created for *Online Admission Applications*, the target page defined in the context of using the New User Registration login page should be defined as your self-service online application page. That way a future applicant will not need to navigate to a specific page. He or she will be automatically transferred to the proper page.

Note: The New User Registration framework knows nothing about the subsequent online transaction (whether it is a CTM online transaction or not). They share the same constituent staging tables (if constituent information is requested at registration time) and the target page defined in the New User Registration Context ID is optional. New User Registration only facilitates the navigation orchestration of your guests or returning users wanting to perform an online transaction that requires signing into your system.

See [Understanding New User Registration](#).

Note: Once the system has authenticated the user, it is also an appropriate time for your CTM online transaction user interface to perform any initialization or setup to prepare the user for data entry into the online transaction. Such setup may include requesting for a bulk list of values data that the user interface can subsequently display to the user. Performing this activity up front may result in a general performance improvement and improved user experience. In order to do that, formulate a bulk *List-Of-Values* request message by submitting the request message to the SCC_GET_LOV service operation. Store the List-Of-Values results in a temporary storage area for use throughout the online transaction functioning.

See [Setting Up List of Values](#).

CTM generates a New User Registration transaction when the self-service user registers to your system (guest users only).

Note: When CTM generates a New User Registration transaction, Search/Match is not triggered. It is assumed that at this time, the constituent data is not sufficient and might be invalid. Only at the time of performing a subsequent true transaction (CTM transaction not marked as New User Registration), Search/Match gets triggered.

Warning! The New User Registration process needs to occur at the initial point of entry for accessing your online user interface. Doing so allows for giving the self-service users appropriate access to the web services that will later be used. In other words, the user cannot be authenticated to your system after performing the online transaction.

See [Developer Reference to Deploy New User Registration](#).

Entity Registry and CTM

The CTM framework uses the Entity Registry feature for processing the staged information. Each staging record used by a CTM transaction requires an entity defined in the Entity Registry component.

The entities associated with the core constituent staging records are delivered with your system. If you created new constituent staging records or created transaction staging records, for each of them you need to create an entity. Review the delivered entities and modify their default setup according to your requirements.

The Entity Registry feature also enables you to easily create application classes and message schemas for the web services a CTM transaction uses.

Delivered Entities Related to Constituent Data

The following table lists the available constituent entities:

Entity ID	Entity Name
SCC_ENTITY_20090521043203 *	Academic History
SCC_ENTITY_20090520153253 *	Academic Interests Header
SCC_ENTITY_20090520155755	Address
SCC_ENTITY_20091125152646	CHESSN (AUS)
SCC_ENTITY_20091126103906	CHESSN Prior HEP (AUS)
SCC_ENTITY_20091126111803	CHESSN Year 12 (AUS)
SCC_ENTITY_20090519160928	Citizenship
SCC_ENTITY_20091126094410	Citizenship History (AUS)
SCC_ENTITY_20090727142755	Disability
SCC_ENTITY_20090521053232	Diversity
SCC_ENTITY_20090727122912	Drivers License
SCC_ENTITY_20090521044252	Email Address
SCC_ENTITY_20090723101739	Emergency Contact
SCC_ENTITY_20090520151536	External System Key
SCC_ENTITY_20090520152753	Extracurricular Activity
SCC_ENTITY_20090520034905 *	General Materials

Entity ID	Entity Name
SCC_ENTITY_20100120113706	HESA Person (UK)
SCC_ENTITY_20091201160101	Higher Ed Student Data (NLD)
SCC_ENTITY_20090520153127	Honors and Awards
SCC_ENTITY_20090520034508	Language
SCC_ENTITY_20090520034153	Licenses and Certificates
SCC_ENTITY_20090519141839	Memberships
SCC_ENTITY_20090521053330	Names
SCC_ENTITY_20090520155342	National ID
SCC_ENTITY_20091126154843	Person Data (CAN)
SCC_ENTITY_20091202124323	Person Data (NZL)
SCC_ENTITY_20090520035051	Person Data (USA)
SCC_ENTITY_20090520155540	Person Data Effdt
SCC_ENTITY_20090520144339	Person Relationship
SCC_ENTITY_20090520154002	Person SA
SCC_ENTITY_20170530114728	Personal Details
SCC_ENTITY_20090520155634	Phone
SCC_ENTITY_20090520035753	Port of Entry Data
SCC_ENTITY_20090917022051	Publications
SCC_ENTITY_20090520153904	Religious Preference

Entity ID	Entity Name
SCC_ENTITY_20090520152610	Residency Official
SCC_ENTITY_20090520152928	Residency Self
SCC_ENTITY_20091201145851	Scholarship Data (NLD)
SCC_ENTITY_20131205005834	Search/Match Results
SCC_ENTITY_20130511221917	Staged User Preference
SCC_ENTITY_20091130122625	Student Bank Account (NLD)
SCC_ENTITY_20090520153020	Student Career (Constituent)
SCC_ENTITY_20091130134055	Student Correspondence (NLD)
SCC_ENTITY_20091126120241	Student Data (AUS)
SCC_ENTITY_20091201162844	Student Information (NLD)
SCC_ENTITY_20091201143403	Student Names (NLD)
SCC_ENTITY_20091201135712	Student Nationalities (NLD)
SCC_ENTITY_20091130160704	Student Prior Education (NLD)
SCC_ENTITY_20091126132815	Student Report (CAN)
SCC_ENTITY_20090520152126 *	Test Score
SCC_ENTITY_20091202113740	Tribal Affiliation (NZL)
SCC_ENTITY_20090520035455	Visa Permit Data
SCC_ENTITY_20130422035544	Visa Permit Data (NLD)
SCC_ENTITY_20130805001014	Visa Permit Support

Entity ID	Entity Name
SCC_ENTITY_20130805001810	Visa Permit Support (NLD)
SCC_ENTITY_20090520154055	Work Experience

* For coding purposes, this Recruiting and Admissions record is a child of the Constituent entity. The record is not displayed in the Constituent Staging component and cannot be configured for data update rule.

For information on how to create new entities, see [Developer Reference for Creating a New CTM Consumer](#), “Step 3: Creating Entities.”

Related Links

[Setting Up Entity Registry](#)

External Search/Match and CTM

CTM is integrated with External Search/Match. External Search/Match can only be run for one person at a time. Therefore, CTM triggers the External Search/Match services in the following scenarios:

- *Realtime*: Occurs through an online transaction, when a guest user is unknown to the Campus Solutions system (that is, no EMPLID is passed for the user). At Save or Submit time, when Search/Match is set to be processed *Realtime*, the Search/Match/Post process triggers. If External Search/Match is enabled, CTM calls the External Search/Match services. The search results are interpreted exactly like what the Campus Solutions system does for the internal Search/Match. For processing the realtime transaction, the Campus Solutions system uses the Search/Match configuration that is set up in the Transaction Setup component for the transaction that is being processed. Note that if the Search/Match configuration for 1 Match Found = Update, and the one matching candidate comes from the external system, then the Campus Solutions system first automatically imports the constituent data for the matching candidate and creates an EMPLID. Then, the Campus Solutions system updates the EMPLID with the data that was entered by the guest user.
- *Manually*: Occurs when an administrator analyzes the data that appears in the Constituent Staging component for a specific Temporary ID and clicks the Search/Match Results link. Because this is also performed for a single person, External Search/Match is triggered and the search results page shows matching candidates from internal Search/Match and/or External Search/Match depending on the results. This is exactly the same behavior if you use the Search/Match Integrated component to perform the search.

Note: External Search/Match does not support searches in batch, therefore, the CTM Transaction Management batch process does not trigger External Search/Match.

Related Links

[Setting Up Search/Match](#)

[Setting Up External Search/Match Functionality](#)

List of Values Framework and CTM

Self-service user interfaces (such as an online CTM transaction) constructed outside of your PeopleSoft Campus Solutions database may contain data fields that have predefined or *prompt* values used to control and streamline data entry for the user. If you want to display these values that are set up inside your PeopleSoft Campus Solutions database, whether it is for a prompt field or a field that contains translate values, the List of Values web service operation (SCC_GET_LOV) can be used. The web service recognizes and provides the values that are used to populate drop-down list boxes on a user interface and for validating selections.

Related Links

[Setting Up List of Values](#)

Setting Up CTM

This section discusses:

- Setting up counter.
- Setting up a transaction.
- Defining the search/match criteria.
- File Parser and CTM.
- Defining data updates rules.
- Setting up affiliation overrides for a data update rule.
- Setting up CTM transaction security.

Pages Used to Set Up CTM

<i>Page Name</i>	<i>Definition Name</i>	<i>Navigation</i>	<i>Usage</i>
Counter Setup	SCC_AWS_FIX_CTRS	Set Up SACR > System Administration > Utilities > Constituent Transaction Mgmt > Counter Setup	Set up the max ID number for the Temporary Constituent ID.

Page Name	Definition Name	Navigation	Usage
Transaction Setup	SCC_TRANSAC_DTLS	<ul style="list-style-type: none"> • Set Up SACR > System Administration > Utilities > Constituent Transaction Mgmt > Transaction Setup • Student Admissions > UCAS Processing > Search/Match Processing > Transaction Setup 	Define the transaction for an online transaction or an offline transaction.
Search/Match Setup	SCC_SEARCH_PARMS	<ul style="list-style-type: none"> • Set Up SACR > System Administration > Utilities > Constituent Transaction Mgmt > Transaction Setup > Search/Match Setup • Student Admissions > UCAS Processing > Search/Match Processing > Transaction Setup > Search/Match Setup 	<p>Define the Search/Match criteria for an online transaction or for running Search/Match manually from the Constituent Staging component.</p> <p>Not applicable for the user registration transaction.</p>
Data Update Rule Entry	SCC_DUR_ENTRY	Set Up SACR > System Administration > Utilities > Constituent Transaction Mgmt > Data Update Rule Entry	<p>Define the rules to update specific constituent data stored in the production tables, with incoming data from the staging records.</p> <p>Not applicable for the user registration transaction.</p>
Affiliation Overrides	SCC_DUR_AFL_OVRD	Set Up SACR > System Administration > Utilities > Constituent Transaction Mgmt > Data Update Rule Entry > Affiliation Overrides	<p>Override a data update rule based on the affiliation the constituent has with the academic institution.</p> <p>Not applicable for the user registration transaction.</p>

Setting Up Counter

Access the Counter Setup page (**Set Up SACR > System Administration > Utilities > Constituent Transaction Mgmt > Counter Setup**).

Constituent Transaction Management

The system automatically increments the Temp Constituent ID field by one when CTM generates a transaction. Set the last used number so that automatic numbering does not create numbers that already exist in the data.

Field or Control	Description
Temp Constituent ID	Displays the last Temporary Constituent ID assigned. The system assigns a Temp Constituent ID when CTM generates a transaction. The value assigned is the value for the SCC_TEMP_ID key field. See Setting Up a Transaction .
Fix Counter	Clicking this button resets the Temp Constituent ID based on the highest value of that field in the database. The field is dynamically found based on the PeopleTools metadata for the record field relationships, and the maximum possible value for that field across all possible records is set as the counter. This avoids the possibility of the system trying to reuse an ID and being polluted by pre-existing data.

Delegate Access

The system automatically increments the Proxy ID field by one when a delegator creates a new proxy. Set the last used number so that automatic numbering does not create numbers that already exist in the data.

Field or Control	Description
Proxy ID	Displays the last Proxy ID assigned. The system assigns a Proxy ID when a delegator creates a new proxy (new contact) in the Share My Information component. The value created is used programmatically and not displayed on pages.
Fix Counter	Clicking this button resets the Proxy ID based on the highest value of that field in the database. The field is dynamically found based on the PeopleTools metadata for the record field relationships, and the maximum possible value for that field across all possible records is set as the counter. This avoids the possibility of the system trying to reuse an ID and being polluted by pre-existing data.

Note

After you begin using the CTM functionality, you can access this page to determine the last number that was incremented for the Proxy ID or the Temporary Constituent ID. Manually changing this number is

practical for the initial setup, but not recommended for further changes. If the ID entered is changed to an existing number, the system will attempt to re-use the ID. Instead use the Fix Counter button.

Setting Up a Transaction

Access the Transaction Setup page (**Set Up SACR > System Administration > Utilities > Constituent Transaction Mgmt > Transaction Setup**).







The following is an example of how a delivered CTM transaction involving both constituent and transaction-specific data can be set up (note that the Transaction Handler section contains an application class specific to the created admissions transaction):

This example illustrates the fields and controls on the Transaction Setup page (1 of 2). You can find definitions for the fields and controls later on this page.

The screenshot displays the 'Transaction Setup' page with the following fields and controls:

- Transaction:** ADMISSIONS_APPLICATION
- *Transaction Name:** Application Data
- Transaction Description:** Admissions Online Application
- *Transaction Status:** Active
- *Data Update Rule:** DEFAULT_UPDATE_RULE
- Transaction Options:**
 - Online Transaction
 - Process Search/Match: Batch, Realtime
 - Run on Save
- Transaction Handler:**
 - *Root Package ID:** SCC_OLA
 - *Path:** TRANSACTION
 - *Application Class ID:** AdmissionTransaction
- Transaction Status and Date:**
 - *Staged Record Name:** SAD_APL_DAT_STG Application Data

This example illustrates the fields and controls on the Transaction Setup page (2 of 2). You can find definitions for the fields and controls later on this page.



Constituent Handler	
*Root Package ID:	SCC_SL_TRANSACTION 
*Path:	INTFC 
*Application Class ID:	DefaultConstituent 
Partition Data	
<input type="radio"/> By Constituent	<input checked="" type="radio"/> By Transaction
Transaction Data Launch View	
Menu Name:	PROCESS_APPLICATIONS 
Menu Bar Name:	USE  &Use
Menu Item Name:	SAD_APPL_STG  Application Transactions
Menu Page Name:	SAD_APPL_STG  Application Transaction Stagin

The following is an example of how a delivered CTM transaction involving only constituent data can be set up. Note that the Transaction Handler section contains the delivered application class handling only the constituent data and the data is partitioned *By Constituent* (because no transaction-specific data exists, selecting *By Transaction* is not logical):





This example illustrates the fields and controls on the Transaction setup involving only constituent data (1 of 2). You can find definitions for the fields and controls later on this page.

Transaction Setup		Search/Match Setup	
Transaction:	DELEGATE_ACCESS		
*Transaction Name:	<input type="text" value="Delegated Access"/>		
Transaction Description:	<input type="text" value="Generic CTM transaction used by Delegated Access framework to assign an EEMPLID to the proxies."/>		
*Transaction Status:	<input type="text" value="Active"/> ▼		
*Data Update Rule:	<input type="text" value="DEFAULT_UPDATE_RULE"/> 🔍		
Transaction Options			
<input checked="" type="checkbox"/> Online Transaction	Process Search/Match:	<input checked="" type="radio"/> Batch	<input type="radio"/> Realtime
Transaction Handler			
*Root Package ID:	<input type="text" value="SCC_CTM"/> 🔍		
*Path:	<input type="text" value="TRANSACTION"/> 🔍		
*Application Class ID:	<input type="text" value="DefaultTransaction"/> 🔍		
Transaction Status and Date			
*Staged Record Name:	<input type="text" value="SCC_DFLT_TRANS"/> 🔍 Default Transaction Status rec		

This example illustrates the fields and controls on the Transaction setup involving only constituent data (2 of 2) . You can find definitions for the fields and controls later on this page.

Constituent Handler	
*Root Package ID:	<input type="text" value="SCC_SL_TRANSACTION"/> 
*Path:	<input type="text" value="INTFC"/> 
*Application Class ID:	<input type="text" value="DefaultConstituent"/> 

Partition Data	
<input checked="" type="radio"/> By Constituent	<input type="radio"/> By Transaction

Transaction Data Launch View	
Menu Name:	<input type="text"/> 
Menu Bar Name:	<input type="text"/> 
Menu Item Name:	<input type="text"/> 
Menu Page Name:	<input type="text"/> 

The following is how the delivered New User Registration transaction is set up:

This example illustrates the fields and controls on the Transaction Setup page: New User Registration transaction. You can find definitions for the fields and controls later on this page.

Transaction Setup

Transaction: NEW_USER_REGISTRATION

***Transaction Name:**

Transaction Description:

***Transaction Status:** ▼

Transaction Options

Online Transaction New User Registration

Transaction Handler

***Root Package ID:** 🔍

***Path:** 🔍

***Application Class ID:** 🔍

Transaction Status and Date

***Staged Record Name:** Constituent

Constituent Handler

***Root Package ID:** 🔍

***Path:** 🔍

***Application Class ID:** 🔍

Field or Control	Description
Transaction	Indicates the transaction code. You specify the transaction code when you add a transaction.
Transaction Status	Activate or inactivate the transaction. The field is used for informational purpose only. No coded logic is delivered with this field.
Data Update Rule	Select the data update rule that you want the system to apply to the constituent data managed by this transaction. You define a data update rule in the Data Update Rule Entry page.

Transaction Options

Field or Control	Description
Online Transaction	<p>Select to indicate that the transaction is performed online by a user. For example, an online transaction occurs when an applicant saves or submits an admission application through AAWS.</p> <p>Clear this check box to indicate that the transaction is performed offline by a user. For example, an offline transaction occurs when you use File Parser to load applications from a text file.</p>
New User Registration	<p>Select to indicate that the transaction is used to perform registration and authentication of a new user.</p> <p>If you select this check box, the system hides the Search/Match Setup tab, the Partition Data group box, and the Transaction Data Launch View group box, because they are not applicable for a new user registration transaction.</p> <hr/> <p>Note: Your system allows for only one transaction to be set as new user registration at a time. The NEW_USER_REGISTRATION transaction is delivered with your system. Because of this restriction, the system hides the New User Registration check box for all other transactions. Do not modify the NEW_USER_REGISTRATION transaction name because the system uses the name to register a user account.</p> <hr/>
Batch	<p>Select if you do not want the system to immediately process Search/Match when the data is individually submitted. If you select this option, the system stores the submitted data in staging tables and you will need to run the Transaction Management process to run Search/Match and post the submitted data to Campus Solutions.</p> <p>When you deselect the Online Transaction check box, the system automatically selects and disables the Batch option. In other words, because the transaction will be processed offline, Search/Match can only be processed by Batch.</p>
Realtime	<p>Select to have the system immediately process Search/Match when the data is saved or submitted from an online transaction.</p>

Field or Control	Description
Run on Save	<p>This check box appears if the Realtime check box is selected.</p> <p>Select this check box if you want the system to immediately run Search/Match when a user <i>saves</i> a transaction. Clear this check box if you want the system to immediately run Search/Match when a user <i>submits</i> a transaction.</p> <hr/> <p>Warning! Selecting Run on Save will trigger Search/Match immediately after user saves the transaction. Make sure your user interface requires sufficient personal information to be entered so that there is enough data to populate the search criteria used by Search/Match. Otherwise, Search/Match could create a new ID or update an existing record with erroneous or missing information. Any subsequent saves prior to submit will update production constituent data if an EMPLID is assigned dependent on your data update rule settings.</p> <hr/>

Transaction Handler

A transaction can contain generic information about a constituent (such as names, addresses, and date of birth), as well as data specific to the transaction. For example, an admission online application transaction will include personal information (constituent data) and application data (transaction data). You can use the Transaction Handler group box to define how the system should handle all the transaction data. You can create your own PeopleCode application class handler for the transaction data and then associate that application class with the transaction in this group box.

For information on creating an application class, see [Developer Reference for Creating a New CTM Consumer](#), “Step 7: Setting Up a Transaction.”

The following table lists the delivered transaction handler values and Staged Record Name value for the New User Registration transaction (NEW_USER_REGISTRATION) or for transactions that only involve constituent data. Do not change these values for New User Registration.

Root Package ID	Path	Application Class ID	Staged Record Name
SCC_CTM	TRANSACTION	DefaultTransaction	SCC_STG_CONSTIT

The following table lists the delivered transaction handler values and Staged Record Name value for transactions that only involve constituent data.

Root Package ID	Path	Application Class ID	Staged Record Name
SCC_CTM	TRANSACTION	DefaultTransaction	SCC_DFLT_TRANS

Transaction Status and Date

The system needs a record in transaction staging tables where it can store the status of the transaction (SCC_TRANS_STS) as well as the transaction status date (SCC_TRANS_STS_DT). These two fields keep track of the status of the transaction code and time stamp of any changes in staging records. The Staged Record Name field indicates the record where the transaction status and the transaction status date are stored.

The transaction staging record you select here must include the following fields:

- SCC_TEMP_ID (key field)
- SCC_TRANSAC_CD
- SCC_TRANS_STS
- SCC_TRANS_STS_DT
- SCC_AUDIT_SBR record for audit tracking
- Any other fields related to your transaction

Note: The NEW_USER_REGISTRATION transaction is an exception to the above rule. The transaction is set up with the Staged Record Name SCC_STG_CONSTIT that does not contain the SCC_TRANS_STS and the SCC_TRANS_STS_DT fields. The reason is that a New User Registration transaction can either be posted or not. Therefore, its transaction status gets automatically set to *Posted*. The record stores the constituent staging status field value (SCC_STG_STATUS) and the constituent staging status date field value (SCC_STG_STS_DT) for the New User Registration transaction. SCC_STG_CONSTIT is also used across all CTM transactions as it holds basic constituent data used inside the Constituent Staging component.

SCC_DFLT_TRANS is another delivered staged record name that can be used for transactions that only involves constituent data (the data manipulated inside the transaction is only applicable to constituent information, not to any transaction-specific data).

For an example of how a staging record name is created and used for CTM transactions involving both constituent and transaction-specific data, review the delivered AAWS admissions transaction staging record SAD_APL_DAT_STG.

Note: The staged record must include the transaction status and date so that the transaction is available for the Transaction Management Process

Constituent Handler

Use the Constituent Handler group box to define how the system should handle the constituent data in a transaction. You can create your own PeopleCode application class handler for the constituent data and then associate that application class with the transaction in this group box.

The default application class that handles the constituent data is delivered with the system. You can modify this application class or create a new application class.

The following table lists the default constituent handler values. You should always use these values when defining the constituent handler values for an online transaction or batch load transaction.

Root Package ID	Path	Application Class ID
SCC_SL_TRANSACTION	INTFC	DefaultConstituent

Partition Data



Use the following options to indicate how the system should maintain the data in the staging tables.

Field or Control	Description
By Constituent	Select this option to have the system maintain only one instance of the constituent data for all transactions of the constituent (that is, One Constituent : Multiple Transactions ratio). This means that constituent data updates performed within a single transaction are visible across all other subsequent transactions. An example of the By Constituent impact: An applicant (user ID: Gina) has used an online application to register for a user account and then, later on, saved or submitted four admission applications. The system creates a total of five transactions for Gina, one transaction for user registration and four transactions for the four applications. For all the five transaction records, the system maintains a single constituent record. Gina updates her email address when saving or submitting the fourth application. The system updates Gina's constituent record with the new email address.
By Transaction	Select this option to have the system maintain a separate instance of constituent data for every transaction of the constituent (that is, One Constituent : One Transaction ratio). This means that constituent data updates performed within a single transaction are not visible across all other transactions. An example of the By Transaction impact: An applicant (user ID: Jason) has used an online application to register for a user account and then, later on, saved or submitted four admission applications. The system creates a total of five transactions for Jason. For all the five transaction records, the system maintains five constituent records of Jason. Jason updates his email address when saving or submitting the fourth application. The system updates Jason's constituent record related to the fifth transaction with the new email address but does not update his other four constituent records.

If you have selected By Constituent, the Summary Information page of the Constituent Staging component displays multiple transaction rows in the Related Transactions region (if multiple transactions exist for the constituent). When you search for transactions of a user who has multiple By Constituent transactions, the Constituent Staging component automatically displays the Summary Information page of the user with the related transactions. In the following example, the partition data by constituent option has been selected for the GLAKE_GRAD_TEST and PSUNV_BUSN_APPLICATION transactions

and, therefore, the Summary Information page displays for the constituent Paul, the two application transactions he applied to, on a single page.

This example illustrates the fields and controls on the Partition Data By Constituent (Summary Information page). You can find definitions for the fields and controls later on this page.

Summary Information		Constituent Details	Participation Details	Additional Personal Info	Regional
Temporary ID:	3793	Name:	Briggs, Paul		
User ID:	JSMITH2011	Constituent Status:	ID Updated		
Created Datetime:	2011/07/04 8:19AM	ID:	3978		
Created By:	JSMITH2011	Post Transaction Data			
Related Transactions					
Customize Find View All   First 1-3 of 3 Last					
Status	Transaction Code	Transaction Name	Status Date	Online	Search/Match Results
Posted	ADMISSIONS_REGISTRATION	ADMISSIONS_REGISTRATION	2011/07/04	<input checked="" type="checkbox"/>	Search/Match Results
Posted	GLAKE_GRAD_TEST	GLAKE_GRAD_TEST	2011/07/04	<input checked="" type="checkbox"/>	Search/Match Results
Saved	PSUNV_BUSN_APPLICATION	PSUNV BUSN APPLICATION	2011/07/04	<input checked="" type="checkbox"/>	Search/Match Results

If you have selected By Transaction, the Summary Information page of the Constituent Staging component always displays only one transaction row in the Related Transaction region (even if multiple transactions exist for the constituent). When you search for transactions of a user who has multiple By Transaction transactions, the Constituent Staging component displays multiple search results. In the following example, the partition data by transaction option has been selected for the PSUNV_UENG_APPLICATION and ADMISSIONS_APPLICATION transactions and, therefore, the system displays multiple search results for the constituent Sarah Dominguez.

This example illustrates the fields and controls on the Partition Data By Transaction (search results). You can find definitions for the fields and controls later on this page.

Constituent Staging

Enter any information you have and click Search. Leave fields blank for a list of all values.

Find an Existing Value

Limit the number of results to (up to 300):

Temporary ID: =

Transaction: begins with

Created Date: =

Constituent Status: =

Last Name: begins with

First Name: begins with

Empl ID: begins with

User ID: begins with

Case Sensitive

[Basic Search](#)

[Save Search Criteria](#)

Search Results

View All								First	1-3 of 3	Last
Temporary ID	Transaction	Created Date	Staging Status	Last Name	First Name	Empl ID	User ID			
3795	ADMISSIONS REGISTRATION	2011/07/04	Loaded	DOMINGUEZ	SARAH	(blank)	SARAH2011			
3796	PSUNV UENG APPLICATION	2011/07/04	ID Updated	DOMINGUEZ	SARAH	CC0010	SARAH2011			
3797	ADMISSIONS APPLICATION	2011/07/04	ID Updated	DOMINGUEZ	SARAH	CC0010	SARAH2011			

In the following example, you can see that the Summary Information page displays only one application transaction for the constituent because the partition data by transaction option has been selected for the ADMISSION_APPLICATION transaction:

This example illustrates the fields and controls on the Partition Data By Transaction (Summary Information page). You can find definitions for the fields and controls later on this page.

Summary Information
Constituent Details
Participation Details
Additional Personal Info
Regional

Temporary ID: 3797	Name: Dominguez, Sarah
User ID: SARAH2011	Constituent Status: ID Updated <input type="button" value="Set to Update ID"/>
Created Datetime: 2011/07/04 8:37AM	ID: CC0010
Created By: SARAH2011	<input type="button" value="Post Transaction Data"/>

Related Transactions

Status	Transaction Code	Transaction Name	Status Date	Online	Search/Match Results
Saved	ADMISSIONS_APPLICATION	Application Data	2011/07/04	<input checked="" type="checkbox"/>	Search/Match Results

If you have selected the partition by transaction option, the system assigns a unique temporary ID to each transaction that the system generates for the constituent. If you have selected the partition by constituent option, the system assigns a unique temporary ID to all the transactions that the system generates for the constituent.

For information about the Constituent Staging component, see [Processing Staged CTM Transactions](#).

For the New User Registration transaction, partitioning is not applicable.

Note: When using the administrator mode, the system always generates a temporary ID for each application that an administrator creates, regardless of whether you have selected the By Transaction or By Constituent option. In other words, the system does not support partition by constituent for the administrator mode.

Note: When creating multiple transactions that use the same transaction staging records, we recommend setting those transactions with the same partitioning option. For instance if you choose to partition by Transaction, do so for all of those transactions. If your choice is partition by constituent, the same applies. You create multiple transactions if you want to use different Data Update Rule values, different Search/Match configuration, or if you added your own logic based on transaction name.

Transaction Data Launch View

This group box indicates the location of the staging component created for the transaction. The information given here allows users to access the transaction staging component by clicking a link on the Constituent Staging component. This link that transfers the user to the transaction staging component is labeled with the Transaction Name. The link is displayed on the Related Transactions grid of the Summary Information page of the Constituent Staging component.

The Transaction Data Launch View group box is not available for user registration. Therefore, by default, the Summary Information page does not display a link for the user registration transaction.

For information about the transfer link, see [Processing Staged CTM Transactions](#), “Reviewing Constituent Information.”

Defining the Search/Match Criteria

Access the Search/Match Setup page (**Set Up SACR > System Administration > Utilities > Constituent Transaction Mgmt > Transaction Setup > Search/Match Setup**).

This example illustrates the fields and controls on the Search/Match Setup page. You can find definitions for the fields and controls later on this page.

Each transaction has its own Search/Match configuration. This allows for flexibility.

Note: The words “Parameters Refreshed” appear if this is the first time you have entered this page, or if the setup of any of the parameters on this page changed since the last time you accessed this page.

<i>Field or Control</i>	<i>Description</i>
Batch, Realtime, and Run on Save	Indicates the Search/Match options you have selected on the Transaction Setup page. For more information, see Setting Up a Transaction .

Select a Search Type, Search Parameter, Search Result Code, and other search fields as appropriate. The values selected on this page are used behind the scenes when Search/Match or External Search/Match is processed *Realtime* at the time the user saves or submits an online transaction and *manually* from the Summary Information page when an administrator triggers Search/Match by clicking the Search/Match Results link for a specific transaction.

To set up Search/Match when set to process by *Batch*, the information given here is defaulted inside the Transaction Manager run control component and can be modified from there. For more information, see “Specifying Search/Match Parameters for Batch Processing.”

Regardless of how Search/Match is initiated, the SCC_SL_SM_RSLT table is created. This table stores the Search/Match results: Temporary ID, Transaction Code, number of matches found, Constituent Status, and the last matched EMPLID. If Search/Match results match multiple EMPLIDs, EMPLID is not stored. If the results match only one EMPLID *and* the Constituent Status is ‘Update ID’, then the EMPLID is

updated with the EMPLID that was matched. To view the Search/Match results, you must query the SCC_SL_SM_RSLT table. The record SCC_SL_SM_RSLT has been added to QUERY_TREE_CC.

Note: Transaction Manager supports only person searches at this time. Therefore, the Search Type field defaults to *Person* and only Search Parameter and Search Result Code values set up for *Person* are valid.

For information about setting up Search/Match rules, order, parameters, and results, see [Setting Up Search/Match](#).

Match(es) Found

This group box contains one row for each search rule defined in the Search Parameter selected. Define Search/Match orders and Search/Match rules on the Search/Match Rule page.

Field or Control	Description
Search Order Nbr (search order number)	For each order number, select what you want to do with the incoming record if the search/match/post process discovers one or more matching records.
One Match and Multiple Matches	<p>Select whether you want to add, update, suspend, or ignore matching records:</p> <ul style="list-style-type: none"> • <i>Add:</i> Add a new record to your database using the data from the staging table record. • <i>Update:</i> Update the existing record in your database using the data from the staging table record. <hr/> <p>Note: Updates are dependent on what has been defined as update rules on the Data Update Rule Entry component. The Data Update Rule component is discussed in Setting Up CTM, “Defining Data Update Rules.”</p> <hr/> <ul style="list-style-type: none"> • <i>Suspend:</i> Suspend any processing of the staging table record. Use the Constituent Staging component to determine manually whether or not this staged record matches a record in your database. The Constituent Staging component is discussed in Processing Staged CTM Transactions. • <i>Ignore:</i> Ignore the staging table record that matched a record in your database. No changes are made to the Constituent Status. It will remain as ‘Loaded’.

No Match Found

Select one of the following options to specify what Search/Match should do when it does not find a matching record in your database or the external system if you use External Search/Match:

- *Add*: Add the unmatched record, including personal data, to your database.
- *Suspend*: Keep the unmatched record in the staging tables to be looked at manually. Use the Constituent Staging component to review the record.
- *Ignore*: Ignore the unmatched record completely. Use the Constituent Staging component to review the record. . No changes are made to the Constituent Status. It will remain as 'Loaded'.

Note: You cannot define a Search/Match setting for the user registration transaction. The new user registration feature does not ask the user enough personal information for creating a new ID. Also, a new user may create a user ID and password without ever coming back to fill out an online application. The information entered as part of the new user registration process is therefore kept in the constituent data staging table until the user actually performs a transaction.

File Parser and CTM

When creating an *offline* transaction (you did not select the Online Transaction check box on the Transaction Setup page), you can take advantage of the PeopleSoft File Parser utility to load data from an external file into Campus Solutions. The external file can be a delimited file or a flat file.

To load data from an external file perform the following steps:

1. Set up the CTM transaction (you will need the transaction code in the next step).
2. Set up File Parser definitions.
3. Run the File Parser process to load the data into staging tables.
4. Review the staged data.
5. Run the Transaction Management Process to post the staged data into the production records.

When setting up the offline CTM transaction on the Transaction Setup page (Set Up SACR, System Administration, Utilities, Constituent Transaction Mgmt), you must deselect the Online Transaction check box. The Batch option for processing Search/Match gets automatically selected.

This is an example of a CTM transaction set up for loading data in batch into the staging tables:

This example illustrates the fields and controls on the Transaction Setup page: File Parser batch load transaction (1 of 2). You can find definitions for the fields and controls later on this page.

Transaction Setup		Search/Match Setup	
Transaction:	BATCH_APPLICANTS		
*Transaction Name:	<input type="text" value="Sample File Parser Batch Load"/>		
Transaction Description:	<input type="text" value="Batch Load Sample"/>		
*Transaction Status:	<input type="button" value="Active"/> ▼		
*Data Update Rule:	<input type="text" value="DEFAULT_UPDATE_RULE"/> 🔍		
Transaction Options			
<input type="checkbox"/> Online Transaction	Process Search/Match:	<input checked="" type="radio"/> Batch	<input type="radio"/> Realtime
Transaction Handler			
*Root Package ID:	<input type="text" value="SCC_OLA"/>	🔍	
*Path:	<input type="text" value="TRANSACTION"/>	🔍	
*Application Class ID:	<input type="text" value="AdmissionTransaction"/>	🔍	
Transaction Status and Date			
*Staged Record Name:	<input type="text" value="SAD_APL_DAT_STG"/>	🔍	Application Data

This example illustrates the fields and controls on the Transaction Setup page: File Parser batch load transaction (2 of 2). You can find definitions for the fields and controls later on this page.

Constituent Handler	
*Root Package ID:	SCC_SL_TRANSACTION <input type="text"/>
*Path:	INTFC <input type="text"/>
*Application Class ID:	DefaultConstituent <input type="text"/>
Partition Data	
<input type="radio"/> By Constituent <input checked="" type="radio"/> By Transaction	
Transaction Data Launch View	
Menu Name:	PROCESS_APPLICATIONS <input type="text"/>
Menu Bar Name:	USE <input type="text"/> &Use
Menu Item Name:	SAD_APPL_STG <input type="text"/> Application Transactions
Menu Page Name:	SAD_APPL_STG <input type="text"/> Application Transaction Stagin

When setting up File Parser, set up the desired transaction code for the batch load on the Mapping page of the File Mapping Definition component. You can set this code as a default value (by default, the SCC_TRANSAC_CD field in the SCC_STG_CONSTIT record stores the transaction code). The File Parser process can also retrieve the transaction code directly from the load file (in such a case, set the mapping action to Direct from file).

Also, it is required to at least include the following constituent staging records on the Context Definition page (Set Up SACR, System Administration, Utilities, File Parser, Context Definition):

- SCC_STG_CONSTIT. It is required to set the following fields, even though they are not necessarily required in the record:
 - SUBMITTED – Default to *N*
 - SCC_TRANSAC_CD – Set according to Transaction Setup
 - SCC_STG_STATUS – Default to *LD* (Loaded)
 - SCC_STG_STATUS_DT – Default to *%Date*
- SCC_SL_TRNMAP (Force Insert)
- SCC_STG_NAMES
- SCC_STG_PERSSA (should be set with *Force Insert* if no incoming fields are mapped)

Note: There might be transaction staging records that are also required to be defined on the Context Definition page. Review the related transaction entities using the Entity Registry component to determine the additional records.

Warning! When using a file to upload data into the staging records, do not populate the EMPLID field with a value that the system has not yet created in the production database. If you provide an EMPLID value that does not exist in the production database, the post process to production tables will fail (the EMPLID value passed will not be used to create a new EMPLID). The same is also true for the User ID (USERID field). The process will not create a User ID using the value entered in the file.

Related Links

[Running the File Parser Process](#)

Defining Data Update Rules

Data update rules allow you to define the conditions when the constituent staging data should update the constituent data in production records. Prior to promoting the staged data to production, CTM evaluates the data update rules specified for the transaction that is being processed.

A data update rule defines whether or how transactions can update constituent staging data in the constituent production tables. It is not used for the transaction-specific data. Also, the data update rule functionality is applicable only for actions performed through CTM and not for the actions that an administrative user performs using the Campus Solutions pages or components.

The following data update rule values are delivered with your system:

Data Update Rule	Rule Name
ADD_IF_BLANK_RULE	Add If Blank Rule
DEFAULT_UPDATE_RULE	Default Update Rule
DO_NOT_UPDATE_RULE	Do Not Update Rule

Those are samples and can be modified to accommodate your needs. When creating a new rule, you can use one of the delivered rules as a basis to create your desired update rule(s) by clicking the *Copy* button. To use the new rule, associate it with a transaction code on Transaction Setup page.

Data update rules are set at the entity level, not at the staging record level. Only the entities where Apply Data Update Rule is selected can be defined as part of a Data Update Rule. Therefore, when adding a new data update rule, the Data Update Rule Entry page displays all those entities for which the Apply Data Update Rule check box is selected. This check box is available on the Entity Registry page (Set Up SACR, System Administration, Entity, Entity Registry). For those entities that you are not using as part of your transaction, set the Update Action to *Do Not Update* so you do not unintentionally blank or zero out data that may be populated by other business processes.

In the case of effective-dated entity data such as Biographical History, if data update rules allow the data in the Campus Solutions system to be updated but the incoming data is the same as the data already in the system, then a new EFFDT (effective-dated) row is *not* created (no data update occurs). Suppose you set up a rule that gender can be updated by an online transaction. The system has the latest biographical history record, effective-dated April 26, 2009, with information such as Gender as Female and Marital Status as Single. Then on April 27, 2009, the applicant submits the same biographical history information such as Gender as Female and Marital Status as Single. In this case, because the information is the same,

the system does not enter a new effective-dated row. The latest effective-dated row remains the same in the PeopleSoft system, which is April 26, 2009.

Warning! You must define the data update rules for any new entity that has been added through the Entity Registry page where the Apply Data Update Rule check box is selected. Additional coding is also necessary to incorporate a new entity into the data update rules.

The following entity names are child entities of the Constituent entity. They are not applicable for data update rules due to their key structures.

Entity	Keys	Notes
Person Relationship (and its child records)	EMPLID, RELATIONSHIP_NBR and EFFDT	<p>A new record row is always inserted.</p> <p>Exception: Relationship Type = <i>Spouse</i></p> <ul style="list-style-type: none"> • Only one spouse record row is allowed. • A new effective-dated row is inserted for the spouse relationship type. <p>Creation of reciprocal relationships is not included as part of CTM.</p>
Publications	EMPLID and PUBLICATION_NBR	A new record row is always inserted.
Work Experience	EMPLID and SEQUENCE_NBR	A new record row is always inserted.
Honors and Awards	EMPLID and DT_RECVD	A new record row is always inserted.

Note: Data Update Rule is not applicable for New User Registration transaction (NEW_USER_REGISTRATION). At this time, data update rule cannot accommodate Common Attribute Framework (CAF) field attributes that may be associated with the record context and entity. While the Personal Details entity is delivered with a CAF record context (SCC_PERS_BIOG), these fields are not extended to CTM staging nor Data Update Rule setup.

Warning! Data Update Rule is only applicable for updating constituent production records with the constituent staging data. It is not applicable to update the transaction production records.

Access the Data Update Rule Entry page (**Set Up SACR > System Administration > Utilities > Constituent Transaction Mgmt > Data Update Rule Entry**).

This example illustrates the fields and controls on the Data Update Rule Entry page (1 of 4). You can find definitions for the fields and controls later on this page.

Data Update Rule Entry
Affiliation Overrides

Rule ID: UGRD_APPLICATION

Rule Name: [Copy](#)

Description: [Refresh](#)

Updated on: 06/13/2010 12:37:12PM by PS **Set All Actions To:**

Entity Information				
Entity Name	Staging Record	Entity Type	Entity Field	Update Action
Address	SCC_STG_ADDR	Billing	* All *	Update/Insert
Address	SCC_STG_ADDR	Business	* All *	Update/Insert
Address	SCC_STG_ADDR	Campus	* All *	Do Not Update
Address	SCC_STG_ADDR	Check	* All *	Update/Insert
Address	SCC_STG_ADDR	Dormitory	* All *	Do Not Update
Address	SCC_STG_ADDR	Home	* All *	Update/Insert
Address	SCC_STG_ADDR	Legal	* All *	Add If Blank
Address	SCC_STG_ADDR	Mailing	* All *	Update/Insert
Address	SCC_STG_ADDR	Other	* All *	Do Not Update
Address	SCC_STG_ADDR	Other 2	* All *	Do Not Update
Address	SCC_STG_ADDR	Permanent	* All *	Update/Insert
Address	SCC_STG_ADDR	Preferred	* All *	Update/Insert
Address	SCC_STG_ADDR	Veteran	* All *	Do Not Update
CHESSN (AUS)	SCC_CHSNAUS_STG		* All *	Update/Insert
CHESSN Prior HEP (AUS)	SCC_PRHEPAU_STG		* All *	Update/Insert
CHESSN Year 12 (AUS)	SCC_YR12_AU_STG		* All *	Update/Insert

This example illustrates the fields and controls on the Data Update Rule Entry page (2 of 4). You can find definitions for the fields and controls later on this page.

Citizenship	SCC_STG_CITZN		* All *	Safe Update
Citizenship History (AUS)	SCC_CITZHST_STG		* All *	Safe Update
Citizenship Passport	SCC_STG_CITZNPP		* All *	Do Not Update
Constituent	SCC_STG_CONSTIT		Date of Birth	Add If Blank
Constituent	SCC_STG_CONSTIT		Birth Location	Safe Update
Constituent	SCC_STG_CONSTIT		Birth Country	Safe Update
Constituent	SCC_STG_CONSTIT		Birth State	Safe Update
Constituent	SCC_STG_CONSTIT		Date of Death	Do Not Update
Disability	SCC_STG_DISBLTY		* All *	Safe Update
Diversity	SCC_STG_DIVRSTY		* All *	Safe Update
Drivers License	SCC_STG_DRV_LIC		* All *	Safe Update
Drivers License Type	SCC_STG_DRV_LTP		* All *	Safe Update
Education Subject (NLD)	SSR_SUB_NLD_STG		* All *	Safe Update
Email Address	SCC_STG_EMAIL	* All *	* All *	Update/insert
Emergency Contact	SCC_STG_EMG_CNT		* All *	Safe Update
Emergency Phone	SCC_STG_EMG_PHN		* All *	Safe Update
Ethnic Diversity	SCC_STG_DIV_ETH		* All *	Update/insert
Ethnicity Detail	SCC_STG_ETH_DTL		* All *	Update/insert
External System	SCC_STG_EXT_SYS		* All *	Safe Update
External System Key	SCC_STG_EXT_SKY	* All *	* All *	Update/insert
Extracurricular Activity	SCC_STG_EXTRACU		* All *	Safe Update
HESA Person (UK)	SCC_HE_PERS_STG		* All *	Safe Update
HESA Person Data (UK)	SCC_HE_PER_STG		* All *	Safe Update
Higher Ed Student Data (NLD)	SSR_STD_NLD_STG		* All *	Safe Update
Language	SCC_STG_LANG		* All *	Safe Update
Licenses and Certificates	SCC_STG_LICCERT		* All *	Safe Update
Memberships	SCC_STG_MBRSHP		* All *	Safe Update

This example illustrates the fields and controls on the Data Update Rule Entry page (3 of 4). You can find definitions for the fields and controls later on this page.

Names	SCC_STG_NAMES	Degree	* All *	Do Not Update
Names	SCC_STG_NAMES	Father	* All *	Do Not Update
Names	SCC_STG_NAMES	Former1	* All *	Update/Insert
Names	SCC_STG_NAMES	Former2	* All *	Update/Insert
Names	SCC_STG_NAMES	Legal	* All *	Add If Blank
Names	SCC_STG_NAMES	Maiden	* All *	Update/Insert
Names	SCC_STG_NAMES	Mother	* All *	Do Not Update
Names	SCC_STG_NAMES	Other	* All *	Update/Insert
Names	SCC_STG_NAMES	Preferred	* All *	Update/Insert
Names	SCC_STG_NAMES	Primary	* All *	Do Not Update
National ID	SCC_STG_NID		* All *	Add If Blank
Person Data (CAN)	SCC_PDECAN_STG		* All *	Safe Update
Person Data (NZL)	SCC_PER_NZL_STG		* All *	Safe Update
Person Data (USA)	SCC_STG_PRSDATU		* All *	Update/Insert
Person Data Effdt	SCC_STG_PDE	Marital Status		Safe Update
Person Data Effdt	SCC_STG_PDE	Marital Status Date		Safe Update
Person Data Effdt	SCC_STG_PDE	Gender		Update/Insert
Person Data Effdt	SCC_STG_PDE	Highest Education Level		Safe Update
Person Data Effdt	SCC_STG_PDE	Full-Time Student		Safe Update
Person Data Effdt	SCC_STG_PDE	Language Code		Safe Update
Person Data Effdt	SCC_STG_PDE	Alternate Employee ID		Safe Update
Person Data Effdt	SCC_STG_PDE	Last Update Date/Time		Safe Update
Person Data Effdt	SCC_STG_PDE	by		Safe Update
Person SA	SCC_STG_PERSSA		* All *	Do Not Update
Phone	SCC_STG_PHONE	* All *	* All *	Update/Insert
Port of Entry Data	SCC_STG_SEVPOED		* All *	Safe Update
Religious Preference	SCC_STG_RELPREF		* All *	Update/Insert
Scholarship Data (NLD)	SSR_SCL_NLD_STG		* All *	Safe Update
Student Bank Account (NLD)	SSF_BNK_NLD_STG		* All *	Safe Update
Student Brincode (NLD)	SSR_SBR_NLD_STG		* All *	Safe Update

This example illustrates the fields and controls on the Data Update Rule Entry page (4 of 4). You can find definitions for the fields and controls later on this page.

Student Correspondence (NLD)	SSR_COR_NLD_STG		* All *	Safe Update
Student Data (AUS)	SSR_STD_DAT_STG		* All *	Safe Update
Student Information (NLD)	SSR_INF_NLD_STG		* All *	Safe Update
Student Names (NLD)	SSR_NME_NLD_STG		* All *	Safe Update
Student Nationalities (NLD)	SSR_NAT_NLD_STG		* All *	Safe Update
Student Prior Education (NLD)	SSR_EDU_NLD_STG		* All *	Safe Update
Student Report (CAN)	SSR_STG_CNRP_ST		* All *	Safe Update
Tribal Affiliation (NZL)	SCC_IWI_TBL_STG		* All *	Safe Update
Visa Permit Data	SCC_STG_VISPMTD		* All *	Do Not Update

Field or Control	Description
Copy	Click to access the Copy Data Update Rule page and copy an existing rule's settings to the new rule.
Refresh	<p>Click to refresh the entities populated on the Data Update Rule Entry page. When you click the button, a message appears indicating which entities have been added or removed from the page.</p> <p>For example, suppose you added a new entity and selected the Apply Data Update Rule check box on the Entity Registry page. In such a case, you must click the Refresh button to populate the Data Update Rule Entry page with this new entity. Conversely, you cleared the Apply Data Update Rule check box on the Entity Registry page for an entity. In such a case, you must click the Refresh button to remove the entity from the Data Update Rule Entry page.</p>
Set All Actions To	Select an update action that you want to apply for all the entities. The update actions you can select are <i>Add If Blank</i> , <i>Do Not Update</i> , <i>Safe Update</i> (applicable for only non-type entities) and <i>Update/Insert</i> .
Entity Name	Displays the name of the entity as defined on the Entity Registry page.
Staging Record	Displays the staging record where the system stores the incoming entity data from a transaction. You define a staging record for an entity on the Entity Registry page.
Entity Type	<p>This field is only available for entities with multiple types, such as Address (Address Types) and Name (Name Types) entities. The default value is <i>All</i>. Select <i>Show All Types</i> to display all the types for an entity. Select this value if you want to specify a different update action for one or more types of an entity. For example, suppose you want to enter <i>Update/Insert</i> update action for campus address and <i>Add If Blank</i> update action for all the other address types (such as home or billing). In such a case, select <i>Show All Types</i> for the Address entity and specify the update action for each address type.</p> <p>Select <i>All</i> if you do not want to display all the types for an entity. Select this value if you want to specify the same update action for all the types of an entity. For example, select <i>All</i> if you want to enter <i>Update/Insert</i> update action for all the address types (such as campus, home and billing).</p> <hr/> <p>Warning! Do not confuse the meaning of entity type described here with the Entity Type defined in the Entity Registry component. In the context of Data Update Rule, entity type refers to the types included inside certain data fields. For example Names has different types, so do Addresses, Phone, and Email Address.</p> <hr/>

Field or Control	Description
Entity Field	<p>This field is only available for entities that do not have any types, such as Constituent and Diversity entities.</p> <p>Select <i>Show All Fields</i> to display all the non-key fields of an entity. Select this value if you want to specify a different update action rule for one or more fields of an entity. For example, suppose you want to enter <i>Do Not Update</i> as the update action for Date of Birth field and enter <i>Add If Blank</i> update action for rest of the Constituent fields (such as Birth Location or Birth Country). In such a case, select <i>Show All Fields</i> for the Constituent entity and specify the update action for each Constituent field.</p> <p>When you select <i>Show All Fields</i>, Entity Field displays the long description for each of the non-key fields contained in the production record listed for the Entity Name in the Entity Registry component.</p> <hr/> <p>Note: The <i>Show All Fields</i> option does not display the key fields because key fields cannot be overridden or updated.</p> <hr/>

For information about defining an entity name (entity), see [Setting Up Entity Registry](#).

Update Action

Identify what the system should do when it posts the entity data to the production records of an existing constituent:

Select *Add If Blank* to add the entity data only if the constituent does not have the entity data. For example, suppose you have assigned *Add If Blank* to the Home Email Address entity type for the graduate application transaction. The email address staging record contains a Home email address for a particular Temporary ID. In the case where that constituent does not have a home email address on the email address production record of the database, the system adds the constituent's home email address to the database. If the constituent already had a Home email address, the staged value will not update the production record since it is not blank (a value already exists).

Note: For the Update Action *Add if Blank*, an existing Gender of *Unknown* is considered to be blank and will be updated. As well, if the National ID is populated with the Country Default (XXX-XX-XXXX for example), it is considered to be blank and will be updated.

Select *Do Not Update* to prevent the constituent's entity data from being updated. For example, suppose you have assigned *Do Not Update* to the National ID entity for the graduate application transaction. The National ID staging record contains a National ID for a particular Temporary ID. In the case where that constituent already has a National ID on the National ID production record of the database, the system does not update the applicant's existing National ID.

Note: *Do Not Update* is the default value for all the entity names.

Note: Keep in mind the relationship of a field to another field when defining your update actions for individual fields in an entity. For example, do not set State/Province to *Update/Insert* if you have Country set to *Do Not Update*. If the system already has a Country value of *Canada* and a Province value of *Alberta*, but the incoming data has a Country value of *Australia* and a Province value of *Tasmania*, you will get an error when posting the data as *Tasmania* is not a valid Province for *Canada*.

Warning! Note that if the *Do Not Update* action is selected for an entity or an entity field, the data will not be posted even if data does not exist on the production record.

Select *Safe Update* to update or insert the constituent's entity data only if the incoming data is populated. This action is available only for entities without a type. If the entity data has an effective date, then the system inserts new effective-dated rows but does not overwrite existing fields with blank or zero. If the entity data does not have an effective date, then the system updates the existing record only for the fields where incoming data is populated. For example, suppose you have assigned *Safe Update* to the Constituent entity for the graduate application transaction. The system receives a graduate application with only Date of Birth and Birth Country populated for the Constituent entity. Birth State and Birth Location are not populated as part of the incoming data. The applicant already has Date of Birth, Birth Country, Birth State and Birth Location on the production record of the database. In such a case, the system updates Date of Birth and Birth Country with the incoming data but will not update Birth State and Birth Location as these fields are not populated as part of the incoming data.

For *Safe Update* specifically, handling of *blanks* or zero values in incoming data is as follows:

- For *TYPED* data, being entities with a built in Type (such as Names and Addresses), the blanking out of fields during update is allowed as these entities are atomic in nature and must be updated as a single unit. For this reason, *Safe Update* is not shown as an option for entities with a Type.
- For *EFFDT* and *non-EFFDT* entities (which are not typed), we will not blank out or set an existing field to blank or zero if *Safe Update* is selected as the update action. For example, on your transaction, you require Birth Date and Birth Country to be completed but you do not have Birth Location or Birth State/Province on your transaction. The existing record has values populated for Birth Location and Birth State/Province. By selecting *Safe Update*, the values for Birth Location and Birth State/Province will not be updated to blank when the transaction data is posted.

Select *Update/Insert* to update or insert the constituent's entity data, even if the incoming and existing values are the same. If the entity data has an effective date, then the system inserts a new effective-dated row if the incoming data differs from the current effective-dated row. If the entity data does not have an effective date, then the system updates the existing record.

For *Update/Insert* specifically, handling of *blanks* or zero values in incoming data is as follows:

- For *TYPED* data, being entities with a built in Type (such as Names and Addresses), the blanking out of fields during update is allowed as these entities are atomic in nature and must be updated as a single unit.
- For *EFFDT* and *non-EFFDT* entities (which are not typed), we allow the blanking or zero set of entity fields for the *Update/Insert Data Update Action*. For this reason, care should be taken for each entity or field when selecting this option. There may be circumstances where it is appropriate that incoming data blank out or set a field to zero and other cases where this is not appropriate.

Warning! Note that the *Update/Insert* action will update character-based fields to blank or null and numeric fields to zero if the field is not populated on the incoming entity. For example, suppose you have assigned *Update/Insert* to the Constituent entity for the graduate application transaction. The system receives a graduate application with only Date of Birth and Birth Country populated for the Constituent entity. Birth State and Birth Location are not populated as part of the incoming data. The applicant already has Date of Birth, Birth Country, Birth State and Birth Location on the production record of the database. In such a case, the system updates the applicant’s existing Date of Birth and Birth Country with the incoming data but will also update Birth State and Birth Location to blank. For this reason, use caution when selecting the *Update/Insert* action to prevent existing data from being updated to blank or zero. In the example above, if you do not want the Birth State and Birth Location to become blank, you should select the Update Action of *Safe Update*.

Setting Up Affiliation Overrides for a Data Update Rule

Access the Affiliation Overrides page (**Set Up SACR > System Administration > Utilities > Constituent Transaction Mgmt > Data Update Rule Entry > Affiliation Overrides**).

This example illustrates the fields and controls on the Affiliation Overrides page. You can find definitions for the fields and controls later on this page.

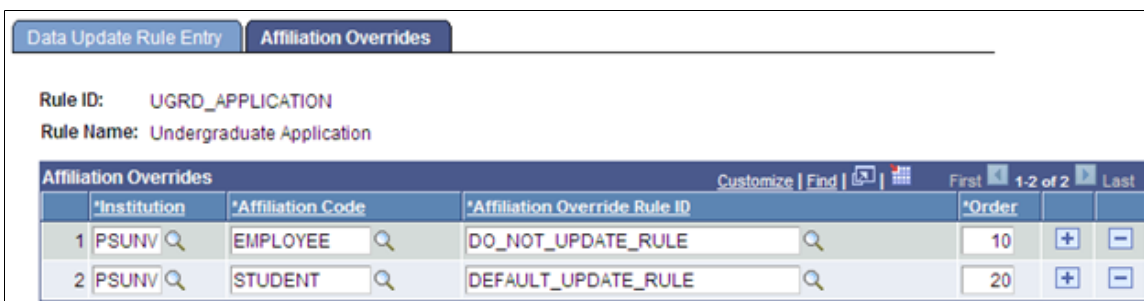

Use the Affiliation Overrides page to have the system update constituent data based on the affiliation the institution has with the constituent.

Warning! To use Affiliation Overrides, Transaction Setup must be set to Partition by Transaction, Institution must be a field for the Staged Record Name entered in the Transaction Status and Date section of Transaction Setup, and the Affiliation Overrides page must be set up.

Field or Control	Description
Rule Name	Displays the name of the rule given in the Data Update Rule Entry tab.

Field or Control	Description
Institution and Affiliation Code	<p>Enter the academic institution and affiliation for which you want to override the rule defined on the Data Update Rule Entry page.</p> <p>For example, suppose for a rule name <i>UGRD_APPLICATION</i> you have defined an <i>Update/Insert</i> update action for the Home Address entity type. For the same rule, <i>UGRD_APPLICATION</i>, you can specify that if the system receives a CTM transaction set with this rule name and the constituent has an affiliation of Employee for the PSUNV institution, apply a different rule that has an update action of <i>Do Not Update</i> for the Home Address entity type.</p>
Affiliation Override Rule ID	Enter the overriding rule for the academic institution and affiliation combination.
Order	<p>Indicate the order in which you want the system to check the override rule. The system applies the Affiliation Override Rule ID for the affiliation assigned to the constituent using the following criteria:</p> <ul style="list-style-type: none"> • The highest order where the affiliation status is <i>Active</i>. • The affiliation start date is less than or equal to the date when the transaction is submitted. • The affiliation end date is either blank or greater than or equal to the date when the transaction is submitted. <p>For example, if you have defined an override rule for PSUNV and <i>Employee</i> with order number 10 and another rule for PSUNV and <i>Student</i> with order number 20, the system evaluates the Employee rule before the Student rule. If the constituent has active affiliations for both Employee and Student, the system applies the override rule for Employee. If the constituent has an active affiliation for only Student, the system applies the override rule for Student. If the constituent does not have an affiliation for either Employee or Student, the system applies the base update rule.</p>

Setting Up CTM Transaction Security

Access the CTM Transaction Security page (**Set Up SACR > Security > Secure Student Administration > User ID > CTM Transaction Security**).

This example illustrates the fields and controls on the CTM Transaction Security page. You can find definitions for the fields and controls later on this page.

The CTM Transaction Security page controls access to the transactions and associated constituents in the pages and processes in these components: Constituent Transaction Mgmt, Prospect/Admissions Data Mgmt, and Application Transaction Management menus.

To control access to components and processes, this page uses CTM transaction codes.

Field or Control	Description
Transaction	Select the transaction codes to which this user should have access.
Access Code	The access code is set to <i>Read/Write</i> . You cannot change this.
All Access	Click to assign this ID access to all transaction codes.

Processing Staged CTM Transactions

CTM is a framework that manages staged data for a transaction and how this data gets validated and moved to the proper production tables. The staged data must be reviewed in two separate components:

- The Constituent Staging component (delivered with your system).
- The transaction staging component (delivered with your system for fully implemented transaction, for instance, the Application Transactions staging component delivered with AAWS, or created by you if you create your own CTM consumer).

Use the Constituent Staging component to review or edit the constituent data stored in the constituent staging tables. The component includes a link that enables you to access the transaction staging component. The transaction staging component shows the data from the staging records used for the transaction. You either create this component (if you created a CTM consumer that has not been delivered with the system) or you use the transaction components delivered with the system. For example, with AAWS we delivered the Application Transactions component (SAD_APPL_STG) to allow viewing and editing the application transaction staged data prior to posting it to the appropriate production tables.

See [Developer Reference for Creating a New CTM Consumer](#) , “Step 5: Creating a Transaction Staging Component – Optional.”

The staging tables are holding tables and are separate from the core production records. Any data changes you make in the staging components gets posted to the core production records when the posting process is executed (real time, manually, or by batch) depending on data update rules. You can use these components to review the information stored in the staging tables at any time. For example, you might prefer to look at the transaction data immediately after the system loads it into the staging tables or after posting. This data is no longer editable once all transactions related to the constituent record have a transaction status of *Posted* or *Cancelled*.

This section discusses:

- Reviewing constituent error messages.
- Constituent statuses.
- Transaction statuses.
- Reviewing constituent details.
- Running the Transaction Management process.

Note: The search record for the Constituent Staging component is not restrictive. If your administrators have access to the component, they will see all of the transactions performed. If you want to restrict the information a user can see, you can create your own search record and add the Constituent Staging component to a menu name specific to the transactions. For example, for AAWS admission transactions, we delivered the Constituent Staging component inside an admissions menu name and the search record has been cloned to include application center security.

Pages Used to Process Staged CTM Transactions

<i>Page Name</i>	<i>Definition Name</i>	<i>Navigation</i>	<i>Usage</i>
Summary Information	SCC_STG_CONST_STG	<ul style="list-style-type: none"> • Campus Community > Constituent Transaction Mgmt > Constituent Staging > Summary Information • Student Admissions > Application Transaction Mgmt > Constituent Staging > Summary Information • Student Recruiting > Prospect/ Admissions Data Mgt > Constituent Staging > Summary Information 	<p>Review the constituent status for a specific Temporary ID, the constituent error messages, and the transactions performed for or by the user.</p> <p>Run the search/match/post process or post the transaction data.</p> <p>Manually trigger Search/Match to review the list of potentially matching candidates.</p>

Page Name	Definition Name	Navigation	Usage
Constituent Details	SCC_STG_CONST_DTLS	<ul style="list-style-type: none"> • Campus Community > Constituent Transaction Mgmt > Constituent Staging > Constituent Details • Student Admissions > Application Transaction Mgmt > Constituent Staging > Constituent Details • Student Recruiting > Prospect/ Admissions Data Mgt > Constituent Staging > Constituent Details 	Review and edit the personal information loaded in the constituent staging records for a specific Temporary ID. Personal information includes data such as names, date of birth, national ID, and address.
Personal Details	SCC_STG_PERSBIOG	<ul style="list-style-type: none"> • Campus Community > Constituent Transaction Mgmt > Constituent Staging > Personal Details • Student Admissions > Application Transaction Mgmt > Constituent Staging > Personal Details • Student Recruiting > Prospect/ Admissions Data Mgt > Constituent Staging > Personal Details 	Review and edit information such as gender identity and sexual orientation.

Page Name	Definition Name	Navigation	Usage
Participation Details	SCC_STG_PARTICIP	<ul style="list-style-type: none"> • Campus Community > Constituent Transaction Mgmt > Constituent Staging > Participation Details • Student Admissions > Application Transaction Mgmt > Constituent Staging > Participation Details • Student Recruiting > Prospect/ Admissions Data Mgt > Constituent Staging > Participation Details 	Review and edit the participation details loaded in the constituent staging records for a specific Temporary ID. Participation details may include information such as work experience and honors and awards.
Additional Personal Info	SCC_STG_ADDITION	<ul style="list-style-type: none"> • Campus Community > Constituent Transaction Mgmt > Constituent Staging > Additional Personal Info • Student Admissions > Application Transaction Mgmt > Constituent Staging > Additional Personal Info • Student Recruiting > Prospect/ Admissions Data Mgt > Constituent Staging > Additional Personal Info 	Review and edit the additional personal information loaded in the constituent staging records for a specific Temporary ID. Additional personal information may include citizenship details and emergency contacts.
Regional	SCC_STG_REGIONAL	<ul style="list-style-type: none"> • Campus Community > Constituent Transaction Mgmt > Constituent Staging > Regional • Student Admissions > Application Transaction Mgmt > Constituent Staging > Regional • Student Recruiting > Prospect/ Admissions Data Mgt > Constituent Staging > Regional 	Review and edit the regional information loaded in the constituent staging records for a specific Temporary ID.

Page Name	Definition Name	Navigation	Usage
Selection Parameters	SCC_SL_SMP	<ul style="list-style-type: none"> • Campus Community > Constituent Transaction Mgmt > Transaction Management Process > Selection Parameters • Student Admissions > Application Transaction Mgmt > Transaction Management Process > Selection Parameters • Student Recruiting > Prospect/ Admissions Data Mgt > Transaction Management Process > Selection Parameters 	<p>Enter selection parameters for running the Transaction Management process. You can run search, match, and post for saved and submitted transactions in the staging records. Also, you can process a transaction for a single person, all persons, or use Population Selection to select a subset of Temporary IDs in the staging records.</p> <p>Before you post the data, set up the Search/Match parameters on the Search/Match Parameters page.</p>
Search/Match Parameters	SCC_SL_SMP_PARM	<ul style="list-style-type: none"> • Campus Community > Constituent Transaction Mgmt > Transaction Management Process > Search/Match Parameters • Student Admissions > Application Transaction Mgmt > Transaction Management Process > Search/Match Parameters • Student Recruiting > Prospect/ Admissions Data Mgt > Transaction Management Process > Search/Match Parameters 	<p>Set up the Search/Match parameters for the Transaction Management process. These are the rules that determine what the post process should do with the staging record after the Search/Match process is complete. The page defaults the Search/Match parameters entered in the Transaction Setup component for the Transaction Code selected.</p>

Reviewing Constituent Information

Access the Summary Information page (**Campus Community > Constituent Transaction Mgmt > Constituent Staging > Summary Information**).

This example illustrates the fields and controls on the Summary Information page. You can find definitions for the fields and controls later on this page.

Summary Information		Constituent Details	Personal Details	Participation Details	Additional Personal Info	Regional
Temporary ID 3	Name Jamison, Susan		Constituent Status Ignore			
User ID	Created Datetime 06/20/2011 9:14AM		ID			
Created By	Run Search/Match/Post					
Related Transactions		Personalize Find View All [Print] [Refresh]		First 1 of 1 Last		
Status	Transaction Code	Transaction Name	Status Date	Online	Search/Match Results	
Submitted	ADMISSIONS_APPLICATION	Application Data	06/20/2011	<input checked="" type="checkbox"/>	Search/Match Results	

When a Search/Match is initiated, the SCC_SL_SM_RSLT table is created. This table stores the Search/Match results: Temporary ID, Transaction Code, number of matches found, Constituent Status, and the last matched EMPLID. If Search/Match results match multiple EMPLIDs, EMPLID is not stored. If the results match only one EMPLID *and* the Constituent Status is ‘Update ID’, then the EMPLID is updated with the EMPLID that was matched. To view the Search/Match results, you must query the SCC_SL_SM_RSLT table. The record SCC_SL_SM_RSLT has been added to QUERY_TREE_CC.

Field or Control	Description
Temporary ID	<p>Displays the auto-generated number.</p> <p>The system assigns this number depending on whether you partitioned the transaction either by constituent or by transaction on the Transaction Setup page. If you have selected the partition <i>by constituent</i> option, a single Temporary ID is associated to all the transactions of the individual. If you have selected the partition <i>by transaction</i> option, the system assigns a new Temporary ID to each transaction of the individual.</p> <hr/> <p>Note: Temporary ID is also known as Constituent Temporary ID. It is the main key to the constituent and the transaction staging tables.</p> <hr/> <p>Note: The auto-generated number is initially set up in the Counter Setup component. See Setting Up CTM, “Setting Up Counter.”</p> <hr/> <p>Note: The Temporary ID field is only used by CTM transactions whether it is in the staging records defined for CTM transactions or in the CTM logic. Its value is not reused anywhere else. For instance, the post process does not use this value to create an EMPLID. EMPLID is auto-generated and uses the Last Employee ID Assigned value.</p>
Constituent Status	<p>Indicates the status of the constituent data in the staging table. This status controls when a transaction can be posted. See Processing Staged CTM Transactions, “Constituent Statuses.”</p> <hr/> <p>Note: Do not modify the delivered values in any way. Any modifications to these values require a substantial programming effort.</p>

Field or Control	Description
ID	<p>Indicates the ID that will be used to post a transaction. ID value is determined either by the User ID that performs the transaction (in the case of returning users, the system retrieves the EMPLID value assigned to the user profile), the Search/Match process, or manually by an administrator if the search for duplicates was performed individually.</p> <p>Note that a returning user is a user that already has a User ID.</p>
Run Search/Match/Post	<p>Click to run Search/Match and if an ID is identified, post the constituent data to the appropriate production records. The transaction data also gets posted for the transaction listed in the Related Transactions grid that are set with a Transaction Status of <i>Submitted</i> (indicates the transaction is ready to be posted).</p> <p>If Search/Match has already been run, an ID is identified and the transaction status is <i>Submitted</i>, the system displays the Post Transaction Data button instead of the Run Search/Match/Post button. Clicking the Post Transaction Data button posts the transactions listed in the Related Transactions grid that are set with a Transaction Status of <i>Submitted</i>.</p> <p>If all the transactions in the Related Transactions have a status of <i>Posted</i>, the system disables the Post Transaction Data button.</p>

Related Transactions

Field or Control	Description
Status	<p>Indicates the status of the related transactions performed for or by the Temporary ID. This status, along with the Constituent Status, controls when a transaction can be posted. Refer to the "Processing Staged CTM Transactions," Transaction Statuses section for details.</p> <hr/> <p>Note: Do not modify the delivered values in any way. Any modifications to these values require a substantial programming effort.</p> <hr/>

Field or Control	Description
<Transaction Name>	<p>Click to access the transaction staging component created for the transaction you clicked the link for. You can access the component only if you have security access to it. The system disables the link if the user does not have access to the target page.</p> <hr/> <p>Note: The link name, by default, matches the name given to the transaction on the Transaction Setup component. In the preceding exhibit example — Summary Information page — you can see that the link is Application Data because for the ADMISSIONS_APPLICATION transaction the Transaction Name is set to <i>Application Data</i> on the Transaction Setup component.</p> <hr/>
Online (Online Transaction)	<p>Indicates whether this transaction was performed online or offline. For example, if the transaction is generated because a self-service user saved or submitted a transaction, the system selects this check box. If the transaction is generated because you have loaded staged data for multiple constituents using the File Parser utility (that is, offline transaction), the system does not select this check box.</p> <hr/> <p>Note: A transaction is set up to be performed online or offline in the Transaction Setup page.</p> <hr/>

Field or Control	Description
Search/Match Results	<p>Click to run Search/Match and manually review the matching candidates. Using this link, you do not need to enter any search data. Instead, the Search Parameter value defined in the Transaction Setup component for the transaction for which you clicked the link is used to identify the search fields and the data for these fields is retrieved directly from the staging records. The search results are displayed using the Search Results Code defined for that same transaction in the Transaction Setup component.</p> <p>If matches are found, the system displays the Integrated Search Results page. Else, a message saying that no result was found is shown.</p> <hr/> <p>Note: The system does not display the Search/Match Results link for a New User Registration transaction.</p> <hr/> <p>Note: The Search/Match function validates if External Search/Match is enabled or disabled. If enabled, the Search/Match function triggers External Search/Match.</p> <hr/> <p>See:</p> <ul style="list-style-type: none"> • Setting Up Search/Match • Setting Up External Search/Match Functionality
Set To Update ID	<p>Click this button if inadvertently you or the system has created or updated the constituent data to a wrong ID and you want to repost the data with the correct ID. The button appears only when Constituent Status = <i>New ID Created</i> or <i>ID Updated</i> and none of the transactions listed in the Related Transactions grid have a status = <i>Posted</i> (other than the New User Registration transaction called NEW_USER_REGISTRATION).</p> <hr/> <p>Note: If a transaction was posted with the wrong ID (transaction status = <i>Posted</i>), you need to first unpost the transaction, delete the created transaction and then you will be able to see the Set to Update ID button and change the ID. You unpost a transaction from the transaction staging component.</p>

Constituent Errors

The Summary Information page displays the Constituent Errors section if the constituent status is *Error*.

Reviewing Constituent Error Messages

Access the Summary Information page (**Campus Community > Constituent Transaction Mgmt > Constituent Staging > Summary Information**).

When constituent data is loaded into the staging records, validation is in place to make sure valid data is entered. Errors can occur when a user saves or submits an online transaction, when an administrator enters data directly inside the Constituent Staging component, or when the data is loaded through batch (for example, using File Parser). When data is entered into the staging records, the system creates a transaction. A transaction might have an error status for the constituent (person) or the transaction-specific data record. For error indicators, look through both the components to find the erroneous field values and manually correct it. When an error is detected, components display an error grid with the proper error message.

For example, suppose an administrative user updates a Temporary ID's information with an invalid email address and an invalid National ID value. At component save time, data validation is performed. If an error is found, the Constituent Status is set to *Error* and the Constituent Staging component displays the appropriate error messages inside the Constituent Errors grid in the Summary Information page.

Note: The Constituent Staging component only validates and displays the errors related to the constituent data. The errors related to the transaction-specific data are displayed on their respective staging component. For an example, see “Understanding Staged Admission Transactions Processing” (Recruiting and Admissions).

This example illustrates the fields and controls on the Example of constituent errors displayed in the Constituent Staging component. You can find definitions for the fields and controls later on this page.

Summary Information		Constituent Details	Personal Details	Participation Details	Additional Personal Info	Regional
Temporary ID	80	Name	Earnhardt, Jill			
User ID		Constituent Status	Error			
Created Datetime	10/22/2013 10:44AM	ID	0107			
Created By		Run Search/Match/Post				
Constituent Errors						
						Personalize Find View All First 1-2 of 3 Last
Message Sequence	Message Set Number	Message Number	Error Description	Message Severity	Process Instance	
1	1	14100	895 The e-mail address must contain @ and . characters	Error	12638	
2	2	14100	894 Length of Local part of e-mail address before the @ sign must be >=1 and <= 64.	Error	12638	
Related Transactions						
						Personalize Find View All First 1 of 1 Last
Status	Transaction Code	Transaction Name	Status Date	Online	Search/Match Results	
Saved	AAWS_FP_ADMAPPLS	AAWS File Parser	10/22/2013	<input checked="" type="checkbox"/>	Search/Match Results	

The Temporary IDs that are assigned a Constituent Status of *Error* need to be manually reconciled. You correct the errors directly in the component and save. If the validation process does not find further errors, the system changes the Constituent Status to *Loaded*, ready to go through the posting process. You can run the posting process manually by clicking the Run Search/Match/Post button (enabled when data is eligible for posting), or by running the Transaction Management process.

Note: To easily retrieve the Temporary IDs that need manual reconciliation, use the component search record and select Constituent Status of *Error*. The search record returns all the Temporary IDs with that status.

This example illustrates the fields and controls on the Example of how to search for the Temporary IDs that have a Constituent Status of Error. You can find definitions for the fields and controls later on this page.

Constituent Staging

Enter any information you have and click Search. Leave fields blank for a list of all values.

Find an Existing Value

Limit the number of results to (up to 300):

Temporary ID: =

Transaction: begins with

Created Date: =

Constituent Status: = Error

Last Name: begins with

First Name: begins with

Empl ID: begins with

User ID: begins with

Case Sensitive

Search
Clear
[Basic Search](#)
 [Save Search Criteria](#)

Search Results

View All
First 1-2 of 2 Last

Temporary ID	Transaction	Created Date	Constituent Status	Last Name	First Name	Empl ID	User ID
3777	PSUNV_BUSN_APPLICATION	08/24/2011	Error	RUFY	GILLES	3002	TESTMF40
3786	PSUNV_UENG_APPLICATION	08/29/2011	Error	DOCKETT	DARNELL	(blank)	PS

Constituent Statuses

The following table describes the various constituent statuses:

<i>Constituent Status</i>	<i>Description</i>	<i>How Status is Set</i>
Loaded	This status indicates that the system has loaded the data into the staging records and has not run Search/Match.	Set by the system if Search/Match has not run or after an administrator corrects an error.

Constituent Status	Description	How Status is Set
New ID Created	<p>This status indicates that the system has run Search/Match and has created a new Employee ID for the staging record.</p> <p>The system assigns this status to a record when it adds a new Employee ID. It adds a new Employee ID when the Search/Match settings for the transaction determine that the record is new. The system also assigns this status to a record when you manually set the constituent status to <i>Add New ID</i> and then click the Run Search/Match/Post button or run the Transaction Management process.</p> <p>The system can assign this status at any time during the process depending on how the transactions are set up. If you have selected the real time option on the Transaction Setup page, the status assigns this status when the user saves or submits their transaction.</p>	Set by the system.
ID Updated	<p>This status indicates that the system has run Search/Match and has found an existing Employee ID for the staging record or the transaction has been processed for a returning user where the Employee ID is known for the user.</p> <p>The system assigns this status to a record when it updates constituent data for an existing Employee ID. It updates an existing Employee ID when the Search/Match settings for the transaction determine that a matching record exists or if a returning user saves or submits a subsequent transaction. This can be done at any time during the process depending on how the transactions are set up. If the process is real time, it will be done at the point the user either saves or submits their transaction.</p>	Set by the system.

Constituent Status	Description	How Status is Set
Suspended	<p>This status indicates that the system has run Search/Match and has suspended the staging record for your review.</p> <p>The system suspends a record from further processing because possible matches have been found based on the Search/Match settings for the transaction.</p> <p>If previously you had changed the status from <i>Suspended</i> to any other status, you can manually change the status back to <i>Suspended</i> (depending on whether the constituent data has been posted to the production record).</p>	<p>Set by the system.</p> <p>Set manually.</p>
Ignore	<p>This status indicates that you have determined this record should be passed over for further processing. This status can only be assigned manually.</p> <p>Processing of the record will not continue while this status is set.</p>	Set manually.
Error	<p>This status indicates that the system has encountered a problem when processing the record.</p> <p>The system can assign this status to a staging record when it encounters a problem during data validation, when running Search/Match, or when the data is being posted.</p> <p>The system displays the error message on the Summary Information page. You must resolve the error and save the record. The system does not allow you to manually change from <i>Error</i> status to another status. When you resolve an error and save the record, the status automatically changes to <i>Loaded</i>, which indicates that you need to start the processing again by running the post process again (whether it is done by clicking the Run Search/Match/Post button or the Post Transaction Data button or by running the Transaction Management process). Notice that if an ID was already identified, the post process will use it to revalidate and to post the data.</p>	Set by the system.

Constituent Status	Description	How Status is Set
Add New ID	<p>This status indicates that you have determined that the constituent should be added as a new person.</p> <p>You can assign this status when you have determined that the staging record should be added with a new Employee ID.</p>	Set manually.
Update ID	<p>This status indicates that you have determined that an existing constituent record should be updated with the staging data.</p> <p>You can use the Search/Match results or the ID field to choose the Employee ID whose record you want to update. After assigning this status and choosing an Employee ID, you can click the Run Search/Match/Post button or run the Transaction Management process to update the existing record.</p>	Set manually.
Cancelled	<p>This status indicates that you have determined the transaction is incomplete, duplicate or should not be processed further. You cannot delete a transaction but you can cancel a constituent transaction. No further data updates by the user or the administrative user can be performed on a cancelled row. The Transaction Management process ignores the cancelled rows.</p> <hr/> <p>Note: Cancelling a constituent implies that none of the transactions tied to it can be updated or processed further.</p> <hr/> <p>Also if your user interface for the online transaction is configured appropriately, this status can be used when an end user has manually cancelled the transaction (for instance, closed the browser window) before saving or submitting an online transaction.</p>	<p>Set by the system.</p> <p>Set manually.</p>

Transaction Statuses

The following table describes the various transaction statuses:

Transaction Status	Description
Saved	<p>This status indicates that the system has saved the transaction to the staging records and the transaction is not ready to be processed.</p> <p>There are three ways to set a transaction status to <i>Saved</i>:</p> <ol style="list-style-type: none"> 1. Automatically by the system when an online transaction is saved (the user interface calls a <i>Save</i> service operation). <p>See Developer Reference for Creating a New CTM Consumer, “Step 4: Creating or Maintaining Web Services.”</p> <ol style="list-style-type: none"> 2. Manually by an administrative user from the transaction staging component if for any reasons the transactions is not ready for processing. 3. When setting up the File Mapping Definition, you can define the default value that File Parser should assign as the Transaction Status. <p>For more information about how to set up File Parser, see “Setup for Loading Applications Using File Parser” (Recruiting and Admissions).</p>
Submitted	<p>This status indicates that system has submitted the transaction to the staging records and the transaction is ready to be processed.</p> <p>There are three ways to set a transaction status to <i>Submitted</i>:</p> <ol style="list-style-type: none"> 1. Automatically by the system when an online transaction is submitted (the user interface calls a <i>Submit</i> service operation). <p>For information about the Submit service operation, see Developer Reference for Creating a New CTM Consumer, “Step 4: Creating or maintaining Web Services.”</p> <ol style="list-style-type: none"> 2. Manually by an administrative user from the transaction staging component to indicate the transaction is ready to be processed. You cannot post <i>Saved</i> transactions; only transactions with <i>Submitted</i> status can be posted.
Saved Error	<p>This status indicates that the system encountered problems when saving a transaction. You must resolve these errors before the transaction can be posted.</p> <p>You cannot manually change this status. When you resolve the error and save the staging record (from the appropriate transaction staging component), the system automatically sets the status back to <i>Saved</i>.</p>

Transaction Status	Description
Submit Error	<p>This status indicates that the system encountered problems when submitting a transaction. You must resolve these errors before the transaction can be posted.</p> <p>You cannot manually change this status. When you resolve the error and save the staging record (from the appropriate transaction staging component), the system automatically sets the status back to <i>Submitted</i>.</p>
Pending	<p>This status indicates that manual reconciliation is required for some data element which is not necessarily an error.</p> <p>For example, as part of AAWS, when manual reconciliation is required for application fee waiver requests, the status is set to Pending and the application fee status is set to <i>Waiver</i>. You can manually change this status.</p> <hr/> <p>Note: Your transaction needs to include code to determine the conditions where this status should be assigned.</p> <hr/>
Posted	<p>This status indicates that the system has successfully posted the transaction. The staged data got inserted inside the appropriate production records.</p> <p>The system runs the posting process when you click the Post Transaction Data button or the Run Search/Match/Post button, or when you run the Transaction Management process.</p>

Running Transaction Management Process

Access the Selection Parameters page (**Campus Community > Constituent Transaction Mgmt > Transaction Management Process > Selection Parameters**).

This example illustrates the fields and controls on the Selection Parameters page. You can find definitions for the fields and controls later on this page.

The screenshot shows the 'Selection Parameters' page. At the top, there are two tabs: 'Selection Parameters' and 'Search/Match Parameters'. Below the tabs, there are fields for 'Run Control ID' (TEST), 'Report Manager' (Report Manager), and 'Process Monitor' (Process Monitor), with a 'Run' button. The '*Transaction Name' field contains 'ADMISSIONS_APPLICATION' and 'Application Data'. The 'ID Selection' section includes a dropdown for '*ID Selection' (One Person Temporary ID), a 'Temporary ID' field (12), and search results for 'Elsa' and 'Thomas'. There are checkboxes for 'Process Submitted Transactions' and 'Process Saved Transactions'. Below are two panels: 'Submitted Transactions' and 'Saved Transactions', each with checkboxes for 'Run Search Match', 'Post Constituent', and 'Post Transaction Data'.

Use this functionality to process temporary constituent IDs stored inside the constituent and the transaction staging tables. You can process all IDs, just one at a time, or use Population Selection to select staged IDs meeting custom criteria. You can decide to only process the submitted transactions, the saved transactions, or a combination of both. The process allows you to change the transaction status from *Saved* to *Submitted*, run Search/Match and once an EMPLID is identified, post the constituent and transaction data to production tables. The Transaction Management process does not process IDs with a Constituent Status set to *Cancelled* or for which their transaction is already *Posted*. It also does not run the Search/Match process when an EMPLID is already identified or the Constituent Status is set to *Ignored*, *Suspended*, or *Error*.

When a Search/Match is initiated, the SCC_SL_SM_RSLT table is created. This table stores the Search/Match results: Temporary ID, Transaction Code, number of matches found, Constituent Status, and the last matched EMPLID. If Search/Match results match multiple EMPLIDs, EMPLID is not stored. If the results match only one EMPLID *and* the Constituent Status is 'Update ID', then the EMPLID is updated with the EMPLID that was matched. To view the Search/Match results, you must query the SCC_SL_SM_RSLT table. The record SCC_SL_SM_RSLT has been added to QUERY_TREE_CC.

When an ID is set to be suspended, you can only manually reset the status after evaluation using the Constituent Staging component. For instance, a self-service user submits an online transaction. Search/Match found one exact match and the transaction was set up to suspend the constituent if this condition is encountered. The suspended record requires manual intervention by the administrative user to validate whether the matching candidate found should be updated or not.

Regardless of how the post process is run, if it encounters any problems during processing, it will assign the record a constituent status of *Error* for constituent-related data, or a transaction status of *Saved Error* or *Submitted Error* for transaction-related data. Use the Constituent Staging and the transaction staging components to review these errors.

Field or Control	Description
Transaction Name	Select the transaction for which you want to process the constituent and their transactions.

ID Selection

Field or Control	Description
ID Selection	<p>Select one of these values:</p> <p><i>All Person Temporary IDs</i>: Select to run the process for all the persons in the staging record who are associated with the selected transaction name.</p> <p><i>One Person Temporary ID</i>: Select to run the process for a single person (constituent) in the staging record who is associated with the selected transaction name.</p> <p><i>Population Selection</i>: Select if you want to use the population selection process for selecting the temporary IDs who are associated with the selected transaction name.</p>
Temporary ID	<p>Available only when the ID Selection is <i>One Person Temporary ID</i>. You must enter the specific constituent temporary ID to process here.</p> <hr/> <p>Note: The field prompt does not display the Temporary IDs that have a Constituent Status set to <i>Cancelled</i>, <i>Ignore</i>, or <i>Suspended</i> or a Transaction Status set to <i>Posted</i>, <i>Saved Error</i>, <i>Submitted Error</i>, or <i>Pending</i>.</p> <hr/>
Process Submitted Transactions	Select if you want the system to process transactions that have a transaction status of <i>Submitted</i> . When you select this option, the Submitted Transactions box appears.
Process Saved Transactions	<p>Select if you want the system to process transactions that have a transaction status of <i>Saved</i>. When you select this option, the Saved Transactions box appears.</p> <p>The system posts only <i>submitted</i> transactions to the database.</p>

Submitted Transactions

This group box appears only when the Process Submitted Transactions option is selected.

Field or Control	Description
Run Search Match	Select to run Search/Match for the <i>Submitted</i> transactions. This process sets the Constituent Status to Add New ID, Update ID, Suspend, or Ignore based on your Search/Match settings.
Post Constituent	Select to post the <i>Submitted</i> constituent data based on the Constituent Status. Note: You must select Run Search Match in order to select Post Constituent . This ensures that you are not introducing duplicates into your database.
Post Transaction Data	Select to post the <i>Submitted</i> transactions.

Note: When processing submitted transactions, the component forces you to select all check boxes.

Saved Transactions

This group box appears only when the Process Saved Transactions option is selected.

Field or Control	Description
Run Search Match	Select to run Search/Match for the <i>Saved</i> transactions. When the EMPLID already exists in the system, Search/Match is not invoked by the process.
Update Status to Submitted	Select to change the transaction status from <i>Saved</i> to <i>Submitted</i> . Note: This option is particularly useful when loading data in batch (for example when using File Parser) and setting the File Mapping Definition to assign the value <i>Saved</i> as the Transaction Status. Doing so allows you to review the staged data before it is processed (Constituent Status is set to <i>Loaded</i> and Transaction Status is set to <i>Saved</i>). When ready to post the transactions, you can use the Transaction Management process to update the Transaction Status from <i>Saved</i> to <i>Submitted</i> .

Field or Control	Description
Post Constituent	<p>Select this process to post the <i>Saved</i> constituent data based on the Constituent Status.</p> <hr/> <p>Note: You must select Run Search Match in order to select Post Constituent. This ensures that you are not introducing duplicates into your database.</p> <hr/>
Post Transaction Data	<p>Select to post the transactions. Only submitted transactions can be posted. Therefore, to be able to select this check box, you must select all four check boxes. If you select all four check boxes, the Transaction Management process will first change the status to <i>Submitted</i>, then it runs Search/Match and finally depending on the Search/Match parameters it posts the constituent and transaction data.</p>

Population Selection

This group box appears only when the ID Selection of *Population Selection* is selected.

Population selection is a method for selecting the IDs to process for a specific transaction. Selection tools are available based on the selection tools that your institution selected in the setup of the Population Selection process for the Transaction Management process and on your user security. Fields in the group box appear based on the selection tool that you select. If your institution uses a specific delivered selection tool (PS Query, Equation Engine equation, or external file) to identify IDs for a specific transaction, you must use it.

See [Using the Population Selection Process](#).

Specifying Search/Match Parameters for Batch Processing

Access the Search/Match Parameters page (**Campus Community > Constituent Transaction Mgmt > Transaction Management Process > Search/Match Parameters**).

This example illustrates the fields and controls on the Search/Match Parameters page. You can find definitions for the fields and controls later on this page.

Use this page to set up your Search/Match parameters. These are the rules that determine what the post process should do with the staging record after the Search/Match process is complete. The fields on this page are similar to the Search/Match Setup page (Set Up SACR, System Administration, Utilities, Constituent Transaction Mgmt, Transaction Setup, Search/Match Setup). The Search/Match parameters that you define for the Transaction Management process overrides the Search/Match parameters set up on the Transaction Setup component.

Field or Control	Description
Suspend Duplicates	<p>When you choose All Person Temporary IDs or Population Selection in ID Selection, select this check box to let the process scan the input staging tables for duplicates using the duplicate rule you specified.</p> <p>If duplicates are found, the first record is ignored and the subsequent records for the same constituent are suspended. For example, if there are two or more staging rows with the same National ID that has a Loaded status <i>and</i> the duplicate rule you use is set up to match on National ID, then the first constituent retains the Loaded status, while the rest are set to Suspended status.</p> <p>Messages are logged for each duplicate that's suspended. Once the initial check is completed, the Transaction Management process continues to work on the non-suspended records. Once the processing is completed, you can review the Suspended duplicates and resolve issues using the Constituent Staging component.</p>

<i>Field or Control</i>	<i>Description</i>
Duplication Rule	<p>This field is used with the Suspend Duplicates check box.</p> <p>You must select the rule you want to use to check for duplicates. This rule should use only the Equals operator to ensure that only exact matches are considered as duplicates.</p>

Related Links

[Defining the Search/Match Criteria](#)

Purging Constituent and Transaction Records

This section provides an overview of the Transaction Purge process and how it is used to delete staging records from Constituent Transaction Management (CTM), Application Transaction Management, UCAS, and Prospect/Admissions Data Management. This section discusses:

- Defining the transaction purge process criteria.
- Viewing the purge log table.

Related Links

[“Understanding Admission Transactions” \(Recruiting and Admissions\)](#)

[Setting Up Entity Registry](#)

[Using the Population Selection Process](#)

Understanding the Transaction Purge Process

The Transaction Purge process is comprised of a single application engine (SCC_SL_PURGE) that is associated with a PeopleTools application package (SCC_SL_PURGE). The application package manages the behavior of the run control component as well as the functionality related to the purge process. The logic and scope of the deletion process is managed by the Entity Registry.

The functionality of the purge process is comprised of:

- Running the purge process in test mode. This allows the end user to review the scope of how many temporary IDs will be deleted based on their criteria prior to actually deleting the temp ID's from staging.

See [Viewing the Purge Log Table](#).

- Specifying a commit level during processing which reflects your system requirements.
- Deleting by Constituent.
 - Delete a specific constituent along with any/all transactions associated to that constituent.
 - Via Population Selection; delete a list of constituents that you specify, including any/all transactions associated.

- Via Population Selection; delete a set of constituents as defined by a user query, including any/all transactions associated.
- Deleting by transaction codes.
 - Delete staged data for a transaction code with a specific transaction status. You can also specify that constituent data be deleted as long as no other transactions are associated with the constituent.
 - Delete staged data for a transaction code based on a specific status and date criteria.
- Deleting constituents and transaction codes in a single execution of the Transaction Purge process.

Locating the Transaction Purge Process Component

You can access the Transaction Purge Process page through:

<i>Menu</i>	<i>Navigation</i>
Constituent Transaction Mgmt	Campus Community > Constituent Transaction Mgmt
Prospect/Admissions Data Mgmt	Student Recruiting > Prospect/Admissions Data Mgmt
UCAS Processing	Student Admissions > UCAS Processing > Import Applicant Data
Application Transaction Mgmt	Student Admissions > Application Transaction Mgmt

Defining Transaction Purge Process Criteria

Access the Transaction Purge Process page.

This example illustrates the fields and controls on the Transaction Purge Process page. You can find definitions for the fields and controls later on this page.

Transaction Purge Process

Run Control ID: PURGE [Report Manager](#) [Process Monitor](#) Run

Purge By Constituent Run in Test Mode?
 Purge By Transaction Commit Counter:

Purge Constituent Data

Related Transaction Data

ID Selection:

*Temporary ID: Susan Samuelson

Purge Transaction Data View All | First | 1-5 of 5 | Last

*Transaction Code	Transaction Description	*Transaction Status	Staging Status	Related Constituent Data	Date Selection	*From Date	To Date		
1 NEW_USER_REGISTRAT	New User Registration Transaction			<input checked="" type="checkbox"/>	Less Than	12/01/2013		<input type="button" value="+"/>	<input type="button" value="-"/>
2 UCAS	UCAS Applicant Import		Cancelled	<input checked="" type="checkbox"/>				<input type="button" value="+"/>	<input type="button" value="-"/>
3 SAD_CFA	CFA Prospect Load	Posted		<input checked="" type="checkbox"/>	Date Range	11/01/2013	12/01/2013	<input type="button" value="+"/>	<input type="button" value="-"/>
4 PSUNV_UENG_APPLICA	PSUNV Undergrad Engineering Application	Saved		<input type="checkbox"/>	Equal To	12/01/2013		<input type="button" value="+"/>	<input type="button" value="-"/>
5 PSUNV_UENG_APPLICA	PSUNV Undergrad Engineering Application	Saved Error		<input type="checkbox"/>	Equal To	12/01/2013		<input type="button" value="+"/>	<input type="button" value="-"/>

After you define the Transaction Purge Process criteria, click Save to save the scope of the run control component, and then click Run to invoke the application engine process SCC_SL_PURGE.

Field or Control	Description
Purge By Constituent	Select to toggle the Purge By Constituent group box, which enables you to purge a single constituent, or use Population Selection to process a set of constituents.
Purge By Transaction	Select to toggle the Purge Transaction Data group box, which enables you to select multiple transactions along with their associated criteria, or purge specific transactions.
Run in Test Mode	<p>Select to run the purge process and see the results (that is, the number of temporary staging IDs to be processed) in the Purge log table without updating or deleting any of the data from the staging tables.</p> <p>If you do not select this check box, tables are updated.</p> <hr/> <p>Note: The Commit Counter is available only when Run in Test Mode is not selected.</p> <hr/>

<i>Field or Control</i>	<i>Description</i>
Commit Counter	<p>When the transaction purge process is not run in Test Mode, this value denotes the number of temporary IDs that are processed, which when surpassed, will invoke a SQL COMMIT command. Once the COMMIT has been processed, the counter is reset and processing will continue with the remaining IDs.</p> <p>The default value is set to 100 temporary IDs. You can override this value to reflect your site's system requirements. If you are unsure what this value should be, contact your database administrator (DBA) who can then advise what the commit level should be.</p>

Purge Constituent Data

<i>Field or Control</i>	<i>Description</i>
Related Transaction Data	By default, this check box is always disabled to ensure referential integrity. This means that when any constituent is deleted, all transaction codes associated with the constituent are also deleted.
ID Selection	<p>Select:</p> <ul style="list-style-type: none"> • One Person Temporary ID. When you select this value, the Temporary ID field appears. You must select a specific temporary ID to be deleted along with associated transaction codes. • Population Selection. Select a user-defined query to drive the constituent purge process, or a user-defined list of temporary IDs to be uploaded.

Population Selection

Population selection is a method for selecting the IDs to process for a specific transaction. The Population Selection group box is a standard group box that appears on run control pages when the Population Selection process is available or required for the transaction. Selection tools are available based on the selection tools that your institution selected in the setup of the Population Selection process for the application process and on your user security. Fields in the group box appear based on the selection tool that you select. The fields act the same from within the group box no matter what run control page you are on or what transaction you are processing. If your institution uses a specific selection tool (PS Query or external file) to identify IDs for a specific transaction, you must use it.

When you create your own queries, make sure the first record is the bind record SCC_SL_PURG_BND. This record has been added to the QUERY_TREE_CC Access Group of CTM PURGE. The required fields are:

- SCC_TEMP_ID - Temp Constituent ID

- SCC_TRANSAC_CD - Transaction Code
- SCC_STG_STATUS - Staging Status
- SCC_STG_STS_DT - Staging Status Date

Purge Transaction Data

Field or Control	Description
Transaction Code	<p>The values that are available are comprised of the list of Transaction Codes to which you have access via the Transaction Security component.</p> <p>See Setting Up CTM, Setting Up CTM Transaction Security.</p>
Transaction Status	<p>Select a status. The status serves as another criterion by which transactions are selected.</p> <p>This field does not appear for transactions such as NEW_USER_REGISTRATION where the transaction is set up as a <i>New User Registration</i> transaction.</p>
Staging Status	<p>This field appears only for transactions that are defined as using only constituent data, such as the United Kingdom's University and Colleges Admissions Service (UCAS). This field serves as another criterion by which transactions are selected.</p>
Related Constituent Data	<p>Select to delete the constituent data associated with the temporary ID. The associated constituent data is deleted only if no other transaction codes are tied to the temporary ID. Otherwise, the request to delete constituent data is ignored and a diagnostic message does not appear.</p> <p>For transactions that are defined to store only constituent data, the Related Constituent Data check box is automatically selected and grayed out. This lets you know that the transaction consists of only constituent data and for the transaction to be purged the related constituent data must be deleted.</p>

Field or Control	Description
Date Selection	<p>This field provides logical operators with which to evaluate dates. When you select a logical operator and specify dates, it acts as another criterion by which transactions are selected.</p> <p>Select:</p> <ul style="list-style-type: none"> • Date Range to specify a From and To date. Make sure the From date is before the To date. • Equal to, Greater Than, Greater Than or Equal To, Less than, Less Than or Equal to, Not Equal to to specify a single date.

Viewing the Purge Log Table

During execution, the Transaction Purge process writes to a log table called SCC_SL_PURG_LOG regardless of the value set for SCC_UPDATE_SW. The log table enables you to see the purge results based on the criteria you define before and after tables are updated. This record is added to the QUERY_TREE_CC access group of CTM PURGE.

SCC_SL_PURG_LOG has the following fields:

Field	Description
PROCESS_INSTANCE	Contains the system-generated process instance
OPRID	Operator who ran the purge process
RUN_CNTL_ID	Specifies the run control ID
SEQNBR	An incremental number to allow multiple transaction codes
SCC_TRANSAC_CD	<p>Contains 1 to n transaction codes as defined within the run control ID</p> <p>When processing constituents either by a single temporary ID, or as a set as defined using Population Section, this field will contain the literal value [By Constituent]. Otherwise, it will contain the actual transaction code you specified.</p>
SCC_TRANS_STS	Contains the related Transaction Status code you specified
SCC_STG_STATUS	<p>Contains the related Staging Status code you specified</p> <p>When processing transactions that are defined as New User Registration, this field will contain the value '--'.</p>

Field	Description
SCC_DATE_TIME	Date and time the Transaction Purge process was run.
SCC_UPDATE_SW	Specifies whether the data remained in the tables after execution of the Transaction Purge process. <ul style="list-style-type: none"> (Y)es = Yes, the data remained. No data was purged because the process ran in Test Mode. (N)o = No, the data was deleted. The tables were updated to purge the data based on the criteria you defined.
SCC_SL_REL_CONST	Specifies whether you requested that constituent data be deleted along with the transaction
SCC_TOT_ROW_COUNT	Specifies the total number of selected temporary IDs to be deleted. This number is generated whether or not the Transaction Purge process runs in Test Mode.
SCC_ELAPSED_TIME	Specifies the time it took to delete all the temporary IDs that comprise a specific transaction code. This number is generated whether or not the Transaction Purge process runs in Test Mode.
RECNAME	Specifies the record name that is related to the Transaction Code
SAD_WHERE_MSG254	Specifies the derived 'WHERE' clause for a specific Transaction Code as defined in the Transaction Purge criteria. When processing constituents, this field contains either a single temporary ID, the Population Selection query name, or file name.

Developer Reference for Creating a New CTM Consumer

Take advantage of the CTM framework to create your own consumers of CTM. The CTM transactions created for a consumer can be performed online or offline by your users. Use the steps discussed in this section as guidelines to do so.

Warning! Creating a CTM consumer is a technical effort and requires knowledge of Application Designer, web services, Integration Broker, and Entity Registry,

The below diagram shows all the steps in the appropriate order that need to be performed to create your own CTM consumers using the CTM framework:

Creating a new consumer of CTM

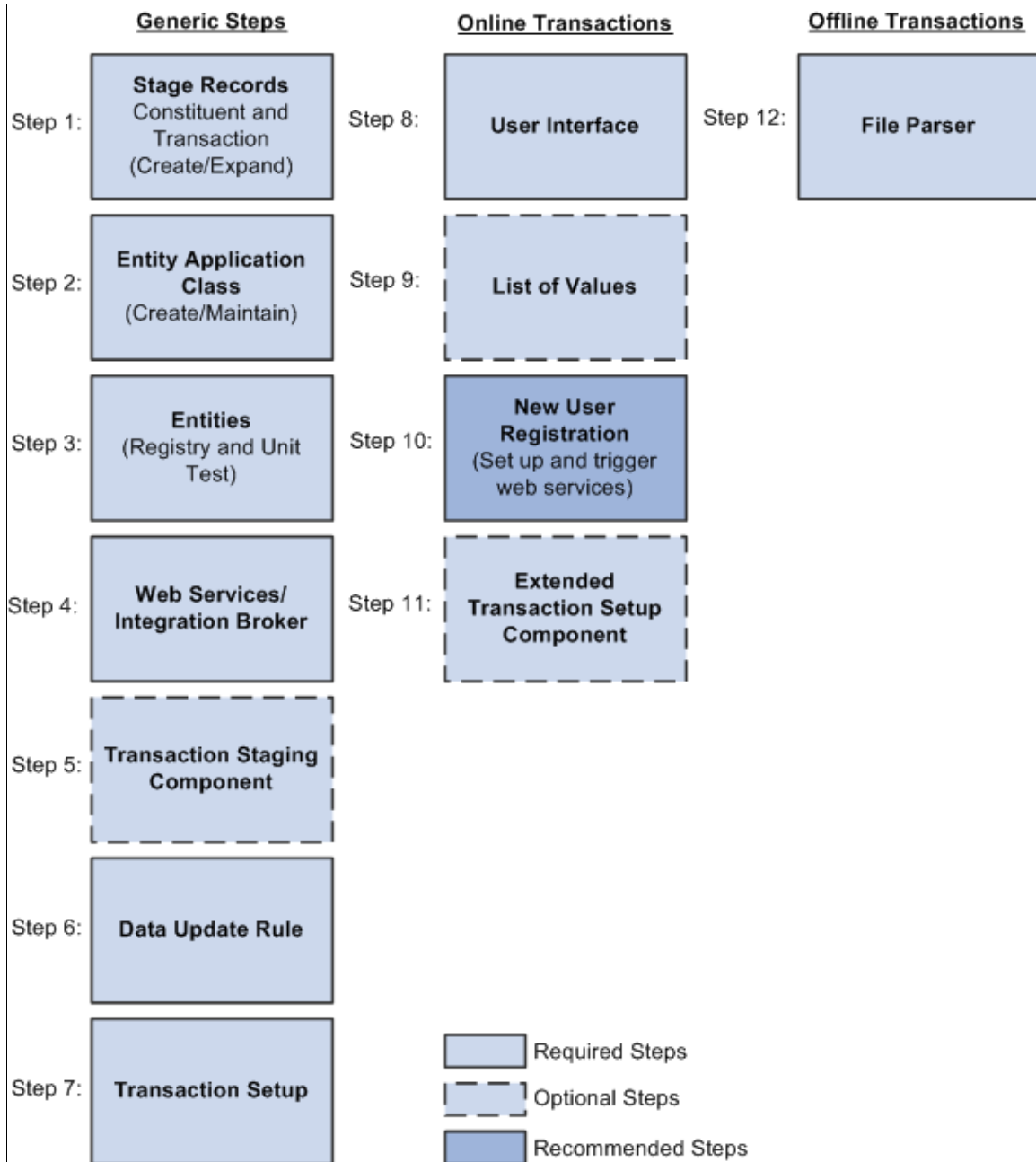

This section discusses:

- Step 1: Creating or extending staging tables.
- Step 2: Creating or maintaining an entity application class.
- Step 3: Creating or maintaining entities.
- Step 4: Creating or maintaining web services.
- (Optional) Step 5: Creating a transaction staging component.
- Step 6: Setting up data update rules.

- Step 7: Setting up a transaction.
- (Only for online transactions) Step 8: Creating a user interface.
- (Optional — only for online transactions) Step 9: Setting up list of values.
- (Optional — only for online transactions) Step 10: Setting up New User Registration.
- (Optional — only for online transactions) Step 11: Creating a setup component for a transaction.
- (Only for offline or batch transactions) Step 12: Setting up File Parser.
- (Optional) Step 13. Setting up an entity profile for an online transaction.

Step 1: Creating or Extending Staging Tables

A staging record used with CTM must be keyed by Temporary ID (SCC_TEMP_ID field) (high level key). This field is a unique identifier that helps keeping track of staged transactions. The rest of the keys for a staging record are similar to the equivalent production record. It is never effective-dated (even if the matching production record is effective-dated). This is because the data entered in staging records can be updated, modified many times prior to be posted to production. Only at that time, the data is current and therefore the production record gets set with the date the data is posted.

Example: Suppose your CTM transaction captures admissions data and you also want to ask specific questions for which the user can select from answers that are displayed on the user interface. Assume the production record to store the answers to the questions is named SCC_EXTN and its definition is as follows:

This example illustrates the fields and controls on the Production record definition (SCC_EXTN). You can find definitions for the fields and controls later on this page.

Record Fields		Record Type											
Num	Field Name	Type	Key	Ord	Dir	Cur	Srch	List	Sys	Audt	InAu	EnAuto	Default
1	EMPLID	Char	Key	1	Asc		No	No	No		No	No	
2	ADM_APPL_NBR	Char	Key	2	Asc		No	No	No		No	No	
3	SEQNO	Nbr	Key	3	Asc		No	No	No		No	No	
4	DESCR100	Char					No	No	No		No	No	
5	QUESTION_ANSWER	Char					No	No	No		No	No	

Its equivalent staging record definition (for example, call it SCC_EXTN_STG record) should be defined as follows:

This example illustrates the fields and controls on the Matching Staging record definition (SCC_EXTN_STG). You can find definitions for the fields and controls later on this page.

Record Fields		Record Type											
Num	Field Name	Type	Key	Ordr	Dir	CurC	Srch	List	Sys	Audt	InAu	EnAuto	Default
1	SCC_TEMP_ID	Nbr	Key	1	Asc		No	No	No		No	No	
2	ADM_APPL_NBR	Char	Key	2	Asc		No	No	No		No	No	
3	SEQNO	Nbr	Key	3	Asc		No	No	No		No	No	
4	DESCR100	Char					No	No	No		No	No	
5	QUESTION_ANSWER	Char					No	No	No		No	No	
6	SCC_AUDIT_SBR	SRec					No	No	No		No	No	
	SCC_ROW_ADD_OPRID	Char					No	No	No		No	No	
	SCC_ROW_ADD_DTTM	DtTm					No	No	No		No	No	
	SCC_ROW_UPD_OPRID	Char					No	No	No		No	No	
	SCC_ROW_UPD_DTTM	DtTm					No	No	No		No	No	

The *Staging* table holds the staged data before it gets promoted to its matching production table.

Later, you will link the newly created staging record with its matching production record through an entity defined in the Entity Registry component. See [Developer Reference for Creating a New CTM Consumer](#), “Step 3: Creating Entities.”

For CTM, the staging record that you select in the Entity Registry component for the parent entity is referred as the parent staging record. Other than including the SCC_TEMP_ID field as a key like the other staging records, ensure that the parent staging record also includes the following additional fields:

- SCC_TRANSAC_CD (Transaction Code)
- SCC_TRANS_STS (Transaction Status)
- SCC_TRANS_STS_DT (Transaction Status Date)
- SCC_AUDIT_SBR record for audit tracking
- Any other fields related to your transaction.

Later, you will also enter the parent staging record for the Transaction Code in the Transaction Setup component. See [Developer Reference for Creating a New CTM Consumer](#), “Step 7: Setting Up Transaction.”

The following is an example of how the parent staging record SAD_APL_DAT_STG, contained in the *Application* parent entity (delivered with the AAWS admission transaction), is defined in the Entity Registry component:

This example illustrates the fields and controls on the Example of Entity Registry component with the parent staging record for the parent entity Application. You can find definitions for the fields and controls later on this page.

Entity Registry

Entity Configuration

Entity ID: SCC_ENTITY_20090521094345

Name:

Status:

Entity Type:

Description:

Application

AppClass:

Prod Record:

Stage Record:

Element (XML):

Apply Data Update Rule

Children Customize | Find | | First 1-7 of 7 Last

Order	Entity Name	Status	Embed	*Min	*Max	Element Wrapper (XML)	View	
1	<input type="text" value="Career Sequence"/> <input type="button" value="🔍"/>	Active	<input type="checkbox"/>	0	0		View	<input type="button" value="+"/> <input type="button" value="-"/>
2	<input type="text" value="Recruitment Category"/> <input type="button" value="🔍"/>	Active	<input type="checkbox"/>	0	0		View	<input type="button" value="+"/> <input type="button" value="-"/>
4	<input type="text" value="Student Response"/> <input type="button" value="🔍"/>	Active	<input type="checkbox"/>	0	0	STDNT_RESPONSES	View	<input type="button" value="+"/> <input type="button" value="-"/>
6	<input type="text" value="Application Fee Tender"/> <input type="button" value="🔍"/>	Active	<input type="checkbox"/>	0	0		View	<input type="button" value="+"/> <input type="button" value="-"/>
7	<input type="text" value="Application Attachment"/> <input type="button" value="🔍"/>	Active	<input type="checkbox"/>	0	0		View	<input type="button" value="+"/> <input type="button" value="-"/>
8	<input type="text" value="Q&A Application Extens"/> <input type="button" value="🔍"/>	Active	<input type="checkbox"/>	0	0	EXTENSION_DATA	View	<input type="button" value="+"/> <input type="button" value="-"/>
9	<input type="text" value="Application (NLD)"/> <input type="button" value="🔍"/>	Active	<input type="checkbox"/>	0	0	APPLICATIONS_NLD	View	<input type="button" value="+"/> <input type="button" value="-"/>

The following is an example of how the SAD_APL_DAT_STG parent staging record (delivered with the AAWS admission transaction) is defined in the Transaction Setup component for the transaction code ADMISSIONS_APPLICATION:

This example illustrates the fields and controls on the Example of Transaction Setup component with the SAD_APL_DAT_STG parent staging record for AAWS transaction. You can find definitions for the fields and controls later on this page.

Transaction Setup		Search/Match Setup	
Transaction:	ADMISSIONS_APPLICATION		
*Transaction Name:	<input type="text" value="Application Data"/>		
Transaction Description:	<input type="text" value="Admissions Online Application"/>		
*Transaction Status:	<input type="button" value="Active"/> ▼		
*Data Update Rule:	<input type="text" value="DEFAULT_UPDATE_RULE"/> 🔍		
Transaction Options			
<input checked="" type="checkbox"/> Online Transaction	Process Search/Match:	<input checked="" type="radio"/> Batch	<input type="radio"/> Realtime
Transaction Handler			
*Root Package ID:	<input type="text" value="SCC_OLA"/> 🔍		
*Path:	<input type="text" value="TRANSACTION"/> 🔍		
*Application Class ID:	<input type="text" value="AdmissionTransaction"/> 🔍		
Transaction Status and Date			
*Staged Record Name:	<input type="text" value="SAD_APL_DAT_STG"/> 🔍	Application Data	
Constituent Handler			
*Root Package ID:	<input type="text" value="SCC SL TRANSACTION"/> 🔍		

See [Setting Up Entity Registry](#).

Step 2: Creating an Entity Application Class

Along with the staging records you created for your CTM transaction (whether they are constituent staging records or transaction-specific staging records), you can create a supporting application class for each combination of staging and matching production records. Generally, this application class provides the properties, and adds any custom validation, pre-save, or *setDefault* logic. However, because it is an application class, anything can be overridden. To see all the methods refer to the Entity Registry section. The created application class needs to be entered in the Entity Registry component for the corresponding entity name.

Note: The application class can be created blank. Entity Registry can help generate the needed base code, which can then simply be copied and pasted into application designer.

The following is an example of the SCC_SL_TRANSACTION:INTFC application package that comprises the delivered application classes used by CTM:

This example illustrates the fields and controls on the Example of application classes used by CTM. You can find definitions for the fields and controls later on this page.

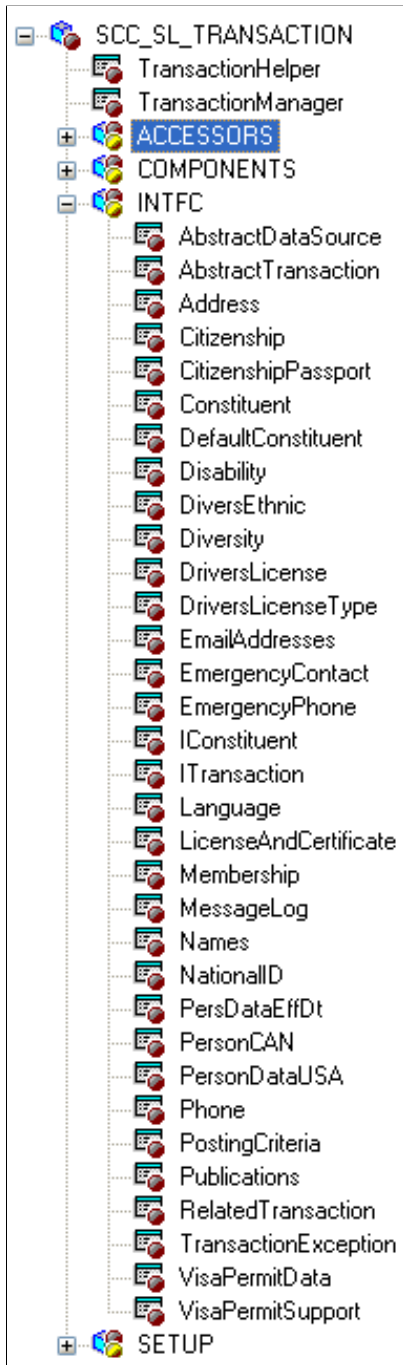

Note: If you created a new constituent entity, we recommend to not create the corresponding application class under the SCC_SL_TRANSACTION:INTFC application package. Instead, create a separate application package. This is because any modifications made to the delivered application package is considered a customization and might be overridden when a software update is delivered.

Note that this step is only to create a *shell* application class. You create a name for it using Application Designer, but the PeopleCode logic is created through Entity Registry.

For information on creating application classes using the Entity Registry component, see [Setting Up Entity Registry](#), “Creating a New Entity.”

Step 3: Creating Entities

As mentioned in the previous subsection, the CTM framework takes full advantage of the Entity Registry feature. Each combination of staging record and production record along with their application class need its own entity. The new entity can be a parent entity or a child of an existing parent. For instance, the *Constituent* and the *Application* entities, delivered with your system, are parent entities of many children.

Register a new entity in the Entity Registry page (**Set Up SACR > System Administration > Entity > Entity Registry**).

When creating an entity that will be used as part of a CTM transaction, select an Entity Type that is defined to use both production and staging records. Two delivered Entity Types are set up that way:

- Staged HR Entity (use it if the production record is owned by HR).
- Staged Entity.

See [Setting Up Entity Registry](#), “Configuring Entity Types, Setting Up Entity Types.”

Step 4: Creating or Maintaining Web Services

CTM uses web services to move data to the production tables. If the CTM consumer you are creating involves transactions to be performed *online*, you can allow the self-service users to *Save* the transaction so that they can come back later to *Submit* when ready. If you choose to do so, you will need to create web services for the following actions:

- One service for the *Save* action.
- One service to retrieve a specific saved transaction.
- One service to retrieve multiple saved transactions.
- One service for the *Submit* action.

Use PeopleTools Integration Broker to create the web services.

Delivered with your system are the following AAWS web service operations constructed for the delivered CTM admission transaction. You can use them as samples to create your own web services.

Service	Service Operation	Operation Type	Messages	Action
SAD_ADMISSIONS	SAD_CREATEAPPL	Synchronous	SAD_CREATEAPPL_REQ SAD_CREATEAPPL_RESP SAD_FAULT_RESP	Creates the application.
SAD_ADMISSIONS	SAD_GETAPPL	Synchronous	SAD_GETAPPL_REQ SAD_GETAPPL_RESP SAD_FAULT_RESP	Retrieves one specific application.
SAD_ADMISSIONS	SAD_GETAPPLS	Synchronous	SAD_GETAPPLS_REQ SAD_GETAPPLS_RESP SAD_FAULT_RESP	Retrieves all applications for a defined individual.
SAD_ADMISSIONS	SAD_GETATTACH	Synchronous	SAD_GETATTACH_REQ SAD_GETATTACH_RESP SAD_FAULT_RESP	Retrieves attachments.
SAD_ADMISSIONS	SAD_SAVEAPPL	Synchronous	SAD_SAVEAPPL_REQ SAD_SAVEAPPL_RESP SAD_FAULT_RESP	Saves an application.
SAD_ADMISSIONS	SAD_SUBMITAPPL	Synchronous	SAD_SUBMITAPPL_REQ SAD_SUBMITAPPL_RESP SAD_FAULT_RESP	Submits an application.

Creation or update considerations for CTM:

- Service operations should be *synchronous* so request and response messages should be created.

- The Entity Registry component provides a utility called Generate XSD that creates a schema that can be used to create web service messages (through Integration Broker). Use it to update or create the schema for either the delivered messages or the messages you create.

(Optional) Step 5: Creating a Transaction Staging Component

Delivered with CTM is the Constituent Staging component. The component enables an administrative user to review, update, and correct errors related to the staged *constituent* data entered for a CTM transaction. The component also enables the administrative user to process the transaction for which the constituent data was entered. But different consumers of CTM will probably also have *transaction-specific* data in addition to constituent data in a CTM transaction. In such a scenario, you can optionally create a component, similar to the Constituent Staging component, which an administrative user can use to review, update, and correct errors related to the staged *transaction-specific* data. The transaction staging component will complement the Constituent Staging component. Both must use the Temporary ID field (SCC_TEMP_ID) as high level key. The transaction staging component name you create and the menu navigation where you place it can be entered in the Transaction Setup component (in the Transaction Data Launch View group box). This will set a hyperlink on the Constituent Staging component allowing the user to easily navigate to the appropriate transaction staging component for the selected Temporary ID. To create your own transaction staging component and connect it with the delivered Constituent Staging component, we have delivered three subpages that can be inserted directly into the component you create in Application Designer.

Note: Each functionality that consumes CTM will probably require its own transaction staging component to display the transaction data specific to the functionality. Creation considerations:

1. At the top of the first page of your transaction staging component, add the following three delivered subpages:
 - a. SCC_STG_HEADER_SBP: Used inside any transaction staging components (that is, this subpage can be used for all transactions). Contains all the generic fields pertinent to a CTM transaction, for instance, Temporary ID, User ID, Name, Constituent Status, and so on. The subpage also contains the fields for manually processing the transaction. For instance, the Run Search/Match/Post, Post Transaction Data, and Set to Update ID buttons. Finally, it contains the logic to assure proper component behavior based on the Constituent Status and the Transaction Status. The following is an example of the SCC_STG_HEADER_SBP subpage when used in a transaction staging component:

This example illustrates the fields and controls on the Example of the SCC_STG_HEADER_SBP subpage. You can find definitions for the fields and controls later on this page.

The screenshot shows a web interface with four tabs: Application Data, Education History, Additional Academic Info, and Supplemental Information. The 'Application Data' tab is active. The main content area displays the following information:

Temporary ID:	3874	Name:	Black, Jil
User ID:	TESTMF85	Constituent Status:	ID Updated
Created Datetime:	10/25/2011 11:12AM	ID:	3928
Created By:	TESTMF85	Post Transaction Data	

There is a 'Set to Update ID' button highlighted in yellow and a 'Constituent Staging' link at the bottom left.

- b. SCC_MESSAGELOG_SBP: Contains the grid for the errors that are found when CTM processes the transaction. The following is an example of the SCC_MESSAGELOG_SBP subpage when used in a transaction staging component:

This example illustrates the fields and controls on the Example of the SCC_MESSAGELOG_SBP subpage. You can find definitions for the fields and controls later on this page.

Application Data		Education History		Additional Academic Info		Supplemental Information			
Temporary ID:	1616	Name:	Bonnet, Pierre						
User ID:	SSADM370	Constituent Status:	Error						
Created Datetime:	05/19/2010 5:51AM	ID:							
Constituent Staging		<input type="button" value="Run Search/MatchPost"/>							
Institution:	PeopleSoft University	Academic Career:	Undergraduate Engineering						
Application Nbr:	00025743	Application Status Date:	05/19/2010						
Application Status:	Submitted Error	<input type="button" value="Expand All"/>		<input type="button" value="Collapse All"/>					
Application Errors							Customize Find View All		
							First 1-2 of 2 Last		
Message Sequence	Message Set Number	Message Number	Error Description				Translate Long Name	Process Instance	
1	1	14098	151	Reconcile error: Select a value for EXT_ORG_ID				Reconcile Error	3456
2	2	14098	151	Reconcile error: Select a value for EXT_ORG_ID				Reconcile Error	3456

- c. SCC_TRANSAC_SBP: Contains the transaction generic information and offers the possibility to unpost a posted transaction. The following is an example of the SCC_TRANSAC_SBP subpage when used in a transaction staging component:

This example illustrates the fields and controls on the Example of the SCC_TRANSAC_SBP subpage . You can find definitions for the fields and controls later on this page.

Transaction Code:	REQUEST_INFO	Transaction Name:	REQUEST_INFO
Transaction Status:	Posted	Status Date:	11/10/2011 1:32AM
<input type="button" value="Unpost Transaction"/>			

2. Below the subpages, add the fields that you had included in the transaction staging records. Based on the quantity of data to display, use as many tabs as you need. Each tab should include the SCC_STG_HEADER_SBP subpage as header.
3. Create the component search record to include the desired access security. Consider using a view that will return the Temporary IDs of only the transactions for which the component is built. For instance, your institution might be using CTM for AAWS admissions transaction as well as for a new CTM consumer. Because these two CTM consumers use different transaction staging records, you will be using two different transaction staging components. The search record for your new transaction staging component could limit the Temporary IDs that have rows in one or more staging records (staging records that you created for your new CTM consumer). This way, your users will not see the Temporary IDs that performed the AAWS transactions. Also, consider securing the search record. For instance, the delivered search record to access the Constituent Staging component does not restrict the returned Temporary IDs. However, the delivered search record to access the Application Transactions staging component (SAD_APPL_STG) limits the returned Temporary IDs based on Application

Center security tied to the User ID that accesses the staging component. The Application Transactions staging component is delivered with AAWS.

4. Once you create the component, component PeopleCode must be added to have the logic contained in the three subpages working properly. To do so, a generic application class (SCC_SL_TRANSACTION:UTIL:StageReviewBase) is delivered. It contains properties and methods that process data, change user interface details of fields residing in the three sub-pages. The application class must be extended and methods in it should be overridden according to functional requirement.

For example, to construct its transaction staging component (Application Transactions component), AAWS admission transaction uses the application class SAD_ADM_APPL:Components:SAD_APPL_STG. This application class extends the SCC_SL_TRANSACTION:UTIL:StageReviewBase application class. The StageReviewBase class contains Recruiting and Admissions specific logic.

Note: SCC_SL_TRANSACTION:UTIL:StageReviewBase contains a method called *constituentStatusChangeEvent()*. This method is invoked every time the SCC_STG_STATUS property is changed. This method is intended to be overridden by the subclass to add transaction specific logic.

Note: The SCC_SL_TRANSACTION:UTIL:StageReviewBase contains the *SCC_RERUN_PUSH_BTN_FieldChange()*; and *SCC_CONST_STS_UPD_FieldChange()*; methods. These two methods should be defined in the subclass and invoked from component record field PeopleCode events of the records fields `<component>.SCC_SL_DERIVED.SCC_RERUN_PUSH_BTN.FieldChange` and `<component>.SCC_SL_DERIVED.SCC_CONST_STS_UPD.FieldChange`. This is necessary to ensure that the push buttons on the header subpage works. Explanation to various other methods and properties of StageReviewBase class is given inside the application class itself. These methods/properties may or may not be overridden based on functional requirements.

Note: The SCC_SL_TRANSACTION:UTIL:StageReviewBase contains a method called *method processtrandtls* to populate the subpage SCC_TRANSAC_SBP. This method populates the fields of the subpage related to the transaction from the transaction staging record. This method should be called during the time of building transaction staging component and also every time the transaction staging record undergoes data changes during transaction processing.

Note: The SCC_SL_TRANSACTION:UTIL:StageReviewBase contains a method called *SCC_TRANSTG_WRK_SCC_STS_UNPOST_Fieldchange*. If you wish to provide the ability to unpost a transaction, extend this method in your Transaction App class with the required business logic/ business process to unpost a transaction. The delivered method *SCC_TRANSTG_WRK_SCC_STS_UNPOST_Fieldchange* would flip the transaction status field *SCC_TRANS_STS* of the staging record and set the value to "Submit". It would also appropriately change the values in UI as the status changes. To enable this, the method has to be invoked from the Fieldchange event of the *SCC_STS_UNPOST* field of your Transaction staging component PeopleCode.

5. Register the new component under the menu you choose and grant administrative users access to it.

Note: For an example of how this is done, use the Application Transactions staging component (Student Admissions, Application Transaction Mgmt, Application Transactions) delivered with AAWS and admission transactions functionality. This is the Application Transactions staging component:

This example illustrates the fields and controls on the Example of a transaction staging component integrated with CTM. You can find definitions for the fields and controls later on this page.

Application Data	Education History	Additional Academic Info	Supplemental Information
Temporary ID: 3779	Name: Roy, Lucile	Constituent Status: Suspended	ID: 3002
User ID: TESTMF41	Created Datetime: 08/24/2011 12:05PM	Created By: TESTMF41	Run Search/Match/Post
Constituent Staging			
*Institution: PeopleSoft University	Academic Career: Graduate Business	Application Nbr: 00027233	Application Status Date: 08/24/2011
Application Status: Saved	Expand All	Collapse All	
Program Data Find View All First 1 of 1 Last			
Program Number: <input type="text" value="0"/>	Exp. Graduation Term: <input type="text"/>	*Admit Term: <input type="text" value="0630"/> 2009 Fall	*Academic Load: Full-Time
*Academic Program: <input type="text" value="GRFIN"/> Finance	*Campus: <input type="text" value="MAIN"/> Main	Last Updated On: 08/24/2011 12:05:30PM	Last Updated By: TESTMF41
Plan Data Find View All First 1 of 1 Last			
*Academic Plan: <input type="text" value="FINANC-MBA"/> Finance (MBA)	*Plan Sequence: <input type="text" value="1"/>	Last Updated On: 08/24/2011 12:05:30PM	Last Updated By: TESTMF41
Sub-Plan Data Find View All First 1 of 1 Last			
*Sub-Plan: <input type="text"/>	Last Updated On:	Last Updated By:	
Application Data			
Application Fees			
Recruiting Categories			
Student Response			

Note: In the above example, AAWS Application Transactions component only uses the described first two subpages. It does not use SCC_TRANSAC_SBP. Instead the transaction uses its own logic.

See “Reviewing and Editing Staged Admission Application Transactions” (Recruiting and Admissions).

Step 6: Setting Up Data Update Rules

See [Setting Up CTM](#), “Defining Data Update Rules.”

Step 7: Setting Up a Transaction

See [Setting Up CTM](#), “Setting Up a Transaction.”

Setup considerations:

1. The Transaction Handler application class handles the activities specific to the posting of the data for your new CTM transaction, for instance, data validation, posting, save, purge, to get related transactions and so on. The application class you specify here must extend the `SCC_SL_TRANSACTION:INTFC:AbstractTransaction`. Any method of this class can be overridden by the Transaction Handler class as per business requirements. The following is an example of a Transaction Handler application class code:

```
import SCC_SL_TRANSACTION:INTFC:AbstractTransaction;
class TransactionClass extends SCC_SL_TRANSACTION:INTFC:AbstractTransaction =>

    method TransactionClass ();



    /* May override these methods as per business requirement */
    method validate(&p_tempConstituentID As number, &p_log As
SCC_SL_TRANSACTION:INTFC:MessageLog out) Returns boolean;
    method post(&p_tempConstituentID As number, &p_EMPLID As string);
    method save(&p_tempConstituentID As number, &p_EMPLID As string);
        method getRelatedTransactions(&p_tempID As number, &p_transacCode As strin=>
g)
Returns array of SCC_SL_TRANSACTION:INTFC:RelatedTransaction;
    method purge(&p_arrTempConstituentID As array of number);

end-class;
method TransactionClass
    %Super = create SCC_SL_TRANSACTION:INTFC:AbstractTransaction();
end-method;
```

Note: For an example of a delivered Transaction Handler application class that extends the `SCC_SL_TRANSACTION:INTFC:AbstractTransaction`, look at the AAWS admission transaction delivered application class `SCC_OLA.TRANSACTION.AdmissionTransaction`.

2. The Staging Record Name is the staging record you created in *Step 1: Creating or Extending Staging Tables*. It is the parent staging record for your transaction.
3. While you can use different values, we recommend to set the Constituent Handler information as follows:
 - Root Package ID: `SCC_SL_TRANSACTION`
 - Path: `INTFC`
 - Application Class ID: `DefaultConstituent`
4. The Transaction Data Launch View should contain the location of where you applied the transaction staging component you created in step 5. Leave the values as blank if you decided not to provide a component to review the staged transaction-specific data.
5. When creating a CTM transaction that only involves constituent data (no transaction-specific data), consider setting up your transaction with the following Transaction Handler information:

This example illustrates the fields and controls on the Example of Transaction Handler section on Transaction Setup page. You can find definitions for the fields and controls later on this page.

Transaction Handler	
*Root Package ID:	<input type="text" value="SCC_CTM"/> 
*Path:	<input type="text" value="TRANSACTION"/> 
*Application Class ID:	<input type="text" value="DefaultTransaction"/> 
Transaction Status and Date	
*Staged Record Name:	<input type="text" value="SCC_DFLT_TRANS"/>  Default Transaction Status rec

A delivered example of a CTM transaction that does not involve any transaction data is *DELEGATED_ACCESS*. This CTM transaction can be used to gather constituent information about the third party (the proxy) who has been delegated access to a student data. In this case the transaction will only process constituent data, leaving all the transaction-specific data logic unused.

Note: For examples on how the Transaction Setup component is configured for the delivered AAWS admission transaction, see [Setting Up CTM](#).

(Only for online transactions) Step 8: Creating a User Interface

The user interface for your CTM online transaction can be created using PeopleTools language, or others. While we recommend using Oracle Application Development Framework (Oracle ADF) to develop an online transaction user interface, you can use any technology or tool that complies with PeopleTools Integration Broker.

Creation considerations:

1. Start by defining the data collection flow for your online user interface. This exercise will help you identify where the web services you created in one of the previous subsections gets invoked. For example, an online application user interface, may have the following data collection flow:

Example of a data collection flow for an Online Application

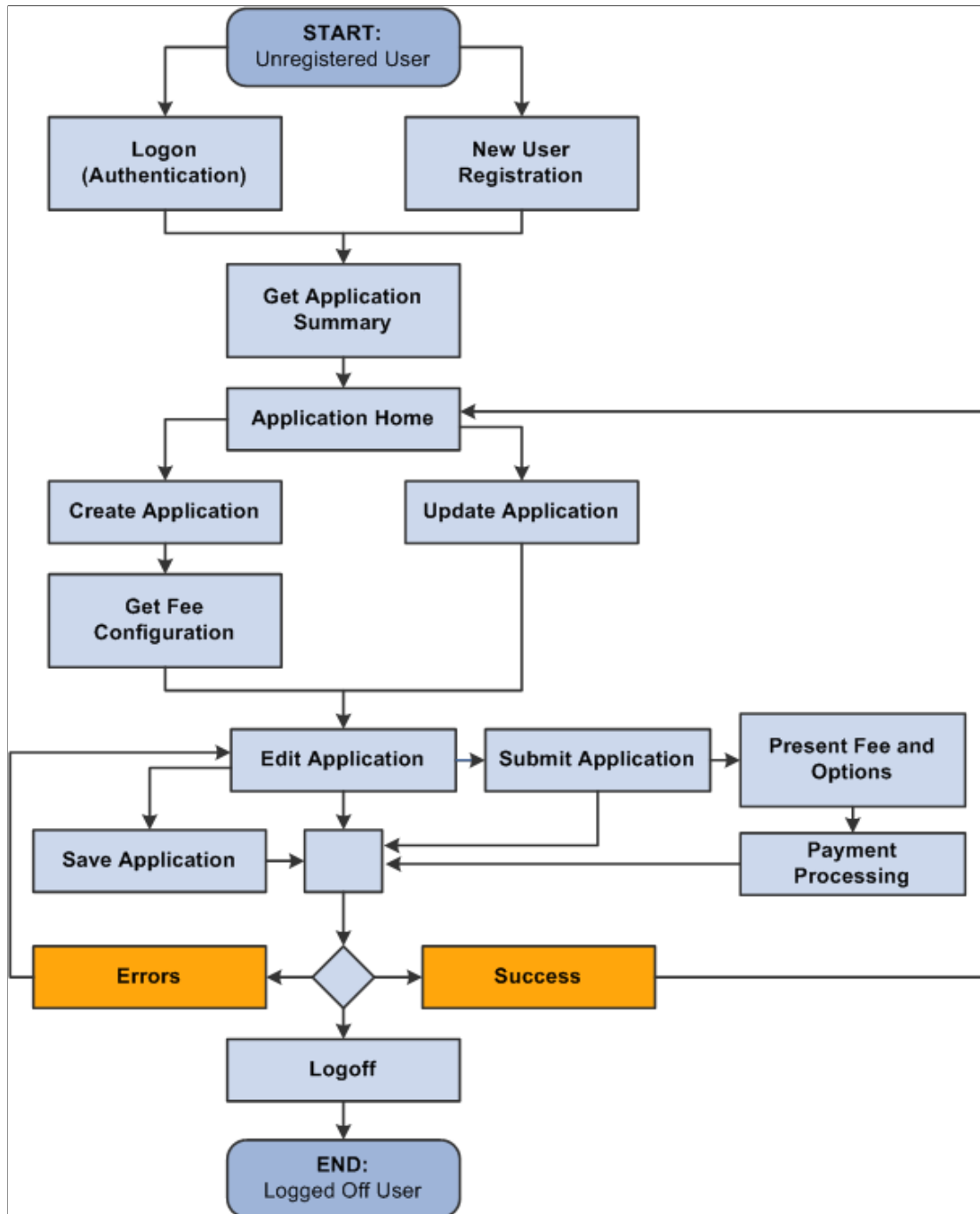

- Because an online transaction requires authenticating the user, consider using the New User Registration framework to take advantage of all the Campus Solutions security objects delivered with the framework. Some self-service users may already have a username and a password to access your system (returning users) some don't (guest users). The New User Registration framework allows both users to authenticate to your system and once successfully authenticated, be transferred to the online self-service page used by your CTM transaction.

See [Developer Reference to Deploy New User Registration](#).

3. Once the system has authenticated the user, it is also an appropriate time for the user interface to perform any initialization or setup to prepare the user for entry into the online transaction. Such setup may include requesting for a bulk list of values data that the user interface can subsequently display to the user. Performing this activity up front may result in a general performance improvement and improved user experience.

See [Setting Up List of Values](#).

A typical self service online transaction user interface might perform the following actions:

To allow a new user to register and a returning user to login, see [Setting Up CTM for New User Registration](#).

To initialize retrieval of list of values for specific fields:

- After authenticating the user, optionally formulate a bulk *List-Of-Values* request message.
- Submit the request message to the SCC_GET_LOV service operation.
- Store the *List-Of-Value* results in a temporary storage area for use throughout the online transaction functioning.

Refer to the third step related to list of values discussed in the Creation considerations topic of this subsection.

To retrieve saved transactions:

If the online transaction allows the self-service user to save an incomplete transaction in order to come back later, create a page where you can display the incomplete transaction names so a user can select the proper transaction to complete. A get service will retrieve the saved data.

(Optional—only for online transactions) Step 9: Setting Up List of Values

Self-service user interfaces constructed using tools external to your PeopleSoft Campus Solutions database may contain data fields that have predefined or prompt values used to control and streamline data entry for a user. If you want to display these values that are set up inside your PeopleSoft Campus Solutions database, whether it is for a *prompt* field or a field that contains translate values, you can take advantage of the *List of Values* web service to do so. This delivered web service recognizes and provides the values that are used to populate drop-down list boxes on a user interface and for validating selections.

(Optional—for online transactions only) Step 10: Setting Up New User Registration

See [Developer Reference to Deploy New User Registration](#).

(Optional—only for online transactions) Step 11: Creating a Setup Component for a CTM Consumer

In the Transaction Setup component you create a Transaction Code and associate the data update rule value and the Search/Match parameters you want to use when the transaction is performed. Now, for your CTM consumer, depending on the values entered by a self-service user while performing the transaction, you may want to use different data update rules and Search/Match settings. For instance, the AAWS

Online Application may allow online users to apply to an institution *PSUNV* and to an academic career *UGRD*. Now a different online user may apply to institution *ORACL* and to an academic career *GRAD*. Because the different institutions or the different academic careers business processes may differ, you may need to use different data update rule codes or different Search/Match parameters to process these two transactions. This is achieved by setting two different transaction codes and using a setup component that will interpret, based on the data entered by the self-service user, which transaction code to use. Notice that this is possible because the same staging records, production records, application classes and user interface are used to perform the two transactions. Only the values entered vary.

Therefore, depending on the nature of the CTM consumer you are creating, you may, like for AAWS Online Application, need to create multiple transaction codes for the same transaction. You do so if you want to use a specific data update rule code or Search/Match parameters based on the values entered by the self-service user while performing the transaction. A setup component for the CTM consumer will therefore need to be created to identify what fields and values should define which Transaction Code to use. The transaction codes will use the same staging and production records, the same application classes, the same entities, and the same staging component. Only the data update rule or the Search/Match parameters (defined for the Transaction Code) could be different based on the data entered by the self-service user.

An example of a setup component for a CTM consumer is delivered with the AAWS admission transaction: *Application Configuration* component (SAD_ADM_APL_CONFIG). Typical to admissions, their business processes function differently from one institution to another and from one academic career to another. While the staging and the production tables are the same, the behavior to update them and to process the transaction varies depending on the institution and the academic career values entered by the self-service user.

The following shows the extended transaction setup component delivered with the AAWS admissions online application transaction. To access this component, select **Set Up SACR > Product Related > Recruiting and Admissions > Application Configuration > Application Configuration**.

This example illustrates the fields and controls on the Example of an extended transaction setup component – Application Configuration component. You can find definitions for the fields and controls later on this page.

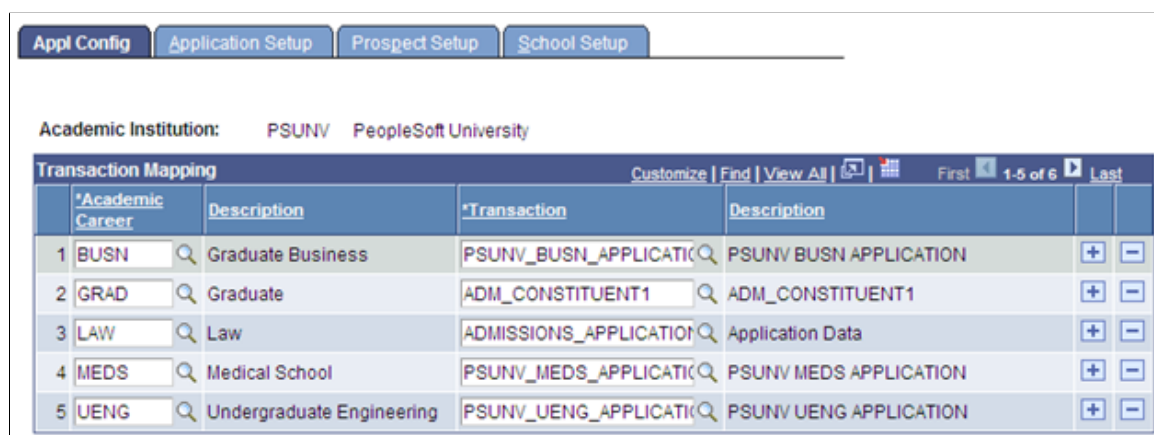

The screenshot shows a web interface with tabs for 'Appl Config', 'Application Setup', 'Prospect Setup', and 'School Setup'. Below the tabs, the 'Academic Institution' is set to 'PSUNV PeopleSoft University'. The main area displays a 'Transaction Mapping' table with columns for *Academic Career, Description, *Transaction, and Description. The table contains five rows of mappings, each with a search icon and plus/minus buttons.

*Academic Career	Description	*Transaction	Description
1 BUSN	Graduate Business	PSUNV_BUSN_APPLICATION	PSUNV BUSN APPLICATION
2 GRAD	Graduate	ADM_CONSTITUENT1	ADM_CONSTITUENT1
3 LAW	Law	ADMISSIONS_APPLICATION	Application Data
4 MEDS	Medical School	PSUNV_MEDS_APPLICATION	PSUNV MEDS APPLICATION
5 UENG	Undergraduate Engineering	PSUNV_UENG_APPLICATION	PSUNV UENG APPLICATION

When a self-service user or an administrator uses the institution-created user interface to perform an online transaction, logic should be in place inside the user interface to interrogate the extended transaction setup component to determine which Transaction Code to use based on the values entered by the user.

For example, a transaction code *PSUNV_UGRD_EXAMPLE* is created with a data update rule value *DO_NOT_UPDATE_RULE* and a second transaction code *ORACL_GRAD_EXAMPLE* with a different data update rule value *DEFAULT_UPDATE_RULE*. The extended transaction setup component should specify that for institution *PSUNV* and academic career *UGRD*, the transaction code to use is *PSUNV_UGRD_EXAMPLE*. And for institution *ORACL* and academic career *GRAD* to use transaction code *ORACL_GRAD_EXAMPLE*.

Note: The Application Configuration component supports only AAWS.

(Only for offline or batch transactions) Step 12: Setting Up File Parser

You must set up File Parser for offline transactions.

See:

- [Running the File Parser Process](#)
- [Setting Up CTM, “File Parser and CTM”](#)

(Optional) Step 13: Setting Up an Entity Profile for an Online Transaction

When you use an entity profile, CTM will identify the entity profile ID and prepare a response message based on the profile setting. Using an entity profile improves web service performance because you can set the payload size of the response message. Currently, only service requests whose response message contains the Constituent entity can take advantage of CTM entity profiling.

To set up an entity profile for an online transaction:

1. Go to **Set Up SACR > System Administration > Entity > Entity Registry**.
2. Search for *Constituent*. The Entity Configuration page appears.
3. From the Action drop-down field, select **Edit Entity View**.

This example illustrates the fields and controls on the Edit Constituent Entity View (example).

Entity Registry

Entity Configuration

Entity ID: SCC_ENTITY_20090521054417

Name: Constituent

Status: Active

Entity Type: Staged HR Entity

Description: Constituent

*AppClass: SCC_SL_TRANSACTION:INTFC:Constituent

Prod Record: HCR_PERSON_I

Stage Record: SCC_STG_CONSTIT

Element (XML): CONSTITUENT

Apply Data Update Rule

Action:

Children	Entity Name	Action
		Edit Entity View
		Edit Properties
		Generate Code

Element Wrapper (XML) Hide View

4. To add an entity view, click the + button to add a row.
5. In **Entity View Name**, enter a name for the view. For example, *PROFILE_TESTER*.
6. Scroll down to the Entity Children region, then select the entities you *do not* want to appear in the response message. For example, if you select all entities in the list and leave the child entity 'Name' deselected, only Name will appear in the response message.
7. Save your changes.
8. Associate the entity view you created to an entity profile:
 - a. Go to **Set Up SACR, System Administration, Entity, Entity Profile**.
 - b. Click **Add a New Value** to set up an entity profile.
 - c. In Entity Profile Name, provide a name for the profile.
 - d. In Profile Type, select *Web Service*.
 - e. Click Save and an Entity Profile ID is generated.

This example illustrates the fields and controls on the CTM — Entity Profile Example page.

Entity Profile ID:	SCC_EPRFL_20140129154742
Entity Profile Name:	<input type="text" value="Profile Tester"/>
Profile Description	<input type="text"/>
*Profile Type	<input type="text" value="Web Service"/>
Parent Profile	<input type="text"/>

Personalize Find		First	1 of 1	Last
Entity Name	*Entity View	View	Hierarchy	
Constituent	<input type="text" value="PROFILE_TESTER"/>	View	Hierarchy	

- To test the entity profile, submit a service request for SCC_USERREG using any service tester. In the request message, make sure you include the attribute SCC_PROFILE_ID, and use the value that was generated for Entity Profile ID.

The response message should return only the entity or entities you selected when you created the entity view.

This example illustrates the fields and controls on the Service Request for SCC_USERREG - Response Message example.

*Service Name	<input type="text" value="SCC_USERREG"/>	
*Service Operation	<input type="text" value="SCC_USERREG_CREATEACCT"/>	
Applicant Sign-On		
*User ID	<input type="text" value="VD_TST_O"/>	
*Password	<input type="text" value="VD_TST_O"/>	
User Registration		
Empl ID	<input type="text" value="CCCM0001"/>	
		Refresh
REQUEST MESSAGE		
<pre> <?xml version="1.0"?> <SCC_UR_CREATEACCT_REQ SCC_PROFILE_ID="SCC_EPRFL_20140120011144" xmlns="http://xmlns.oracle.com/Enterprise/HCM/services"> <SCC_USERNAME>VD_TST_O</SCC_USERNAME> <SCC_PASSWORD>VD_TST_O</SCC_PASSWORD> <SCC_CONFIRMPWD>VD_TST_O</SCC_CONFIRMPWD> <CONSTITUENT> <SCC_TEMP_ID>121</SCC_TEMP_ID> <EMPLID></EMPLID> </CONSTITUENT> </SCC_UR_CREATEACCT_REQ> </pre>		
		Submit
RESPONSE MESSAGE		
<pre> AME_SRCH><FIRST_NAME_SRCH>JOHN</FIRST_NAME_SRCH><LAST_NAME>SMITH</LAST_NA ME><FIRST_NAME>John</FIRST_NAME><MIDDLE_NAME>W.</MIDDLE_NAME><SECOND_LAST_ NAME></SECOND_LAST_NAME><SECOND_LAST_SRCH></SECOND_LAST_SRCH><NAME_AC> </NAME_AC><PREF_FIRST_NAME></PREF_FIRST_NAME><PARTNER_LAST_NAME></PARTNER_ LAST_NAME><PARTNER_ROY_PREFIX></PARTNER_ROY_PREFIX><LAST_NAME_PREF_NLD>1< /LAST_NAME_PREF_NLD><NAME_DISPLAY>John Smith</NAME_DISPLAY><NAME_FORMAL>Mr John Smith</NAME_FORMAL><NAME_DISPLAY_SRCH></NAME_DISPLAY_SRCH><LASTUPDDTTM>01/ 21/2014 08:30:33.000000</LASTUPDDTTM><LASTUPDOPRID></LASTUPDOPRID><EffectiveDate>2014-01- </pre>		

Related Links

[Creating Entity Views](#)

Using External Search/Match

Understanding Using External Search Match

As is the case for Internal Search/Match, there are two options to perform searches in an external system:

- Online search: Manually navigate to the Search/Match Integrated component and enter search options.

Note: When your institution configures External Search/Match functionality and integrates with an external system, Oracle recommends that you revoke your users' security access to the Search/Match component and replace it with the Search/Match Integrated component so that users will use the same tool for searching existing IDs.

- Automatic search: From a Campus Solutions component where an ID can be created, the External Search/Match triggers behind the scenes after user clicks **Save**.

Related Links

“Understanding CS-to-HCM Integration” (Campus Solutions Application Fundamentals)

[Setting Up External Search/Match Functionality](#)

Selecting Criteria for an Integrated Search

This section discusses how to perform an integrated search.

Page Used to Select Criteria for an Integrated Search

<i>Page Name</i>	<i>Definition Name</i>	<i>Navigation</i>	<i>Usage</i>
Search Criteria	HCR_SM_SEARCH	<ul style="list-style-type: none"> • Campus Community, Personal Information, Search/Match Integrated, Search Criteria • Campus Community, SEVIS, Search Tools, Search/Match Integrated, Search Criteria • Set Up SACR, System Administration, Utilities, Search/Match, Search/Match Integrated, Search Criteria • Student Admissions, Application Entry, Search/Match Integrated, Search Criteria • Student Admissions, Application/Transcript Loads, Search/Match Integrated, Search Criteria • Student Admissions, External Test Score Processing, Search/Match Integrated, Search Criteria • Student Recruiting, Maintain Prospects, Search/Match Integrated, Search Criteria • Student Recruiting, Student Recruiters, Search/Match Integrated, Search Criteria • Student Recruiting, External Test Score Processing, Search/Match Integrated, Search Criteria • Contributor Relations, Constituent Information, People, Search/Match Integrated, Search Criteria 	<p>Enter criteria to search for duplicate person or multiple person records contained inside an external system.</p> <p>When the page is accessed through the SCC_SM_SEARCH component, then the system performs the External Search/Match evaluation.</p>

Entering Search Criteria

Access the Search Criteria page (**Campus Community > Personal Information > Search/Match Integrated**).

This example illustrates the fields and controls on the Search Criteria page (1 of 2). You can find definitions for the fields and controls later on this page.

Search Criteria

Search Type: Person Ad Hoc Search

Search Parameter: PSCS_TRADITIONAL CS_Person_Traditional

Search Result Rule

Search Result Code: PSCS_TRAD_RES CS_Person Traditional Results

[User Default](#)

Search Criteria	
Search Fields	Value
Address Line 1	<input type="text"/>
City	<input type="text"/>
First Name Search	JOHN <input type="text"/>
Last Name Search	SMITH <input type="text"/>
Date of Birth	<input type="text"/>

This example illustrates the fields and controls on the Search Criteria page (2 of 2). You can find definitions for the fields and controls later on this page.

Gender	<input type="text"/>	
National Id	<input type="text"/>	
Search by Order Number		
Search Order	Description	
10	Name,Addr,City,Bday,Gender,SSN	<input type="button" value="Selective Search"/>
20	SSN Only	<input type="button" value="Selective Search"/>
30	Name,Bday,Gender	<input type="button" value="Selective Search"/>
40	Name,Gender	<input type="button" value="Selective Search"/>
50	Name Only	<input type="button" value="Selective Search"/>

The fields on this page are the same as those on the Search/Match page. However, the SCC_SM_SEARCH component includes logic that evaluates the external system data settings when you click the **Search** or **Selective Search** button. Note that this is only true when the **Search Type** is *Person*. For a **Search Type** of *Applicant* or *Organization*, the system triggers Search/Match.

Viewing Integrated Search Results

This section discusses how to:

- View search results.
- View biographic details.
- View regional details.

Pages Used to View Integrated Search Results

Page Name	Definition Name	Navigation	Usage
Integrated Search Results	SCC_SM_RESULTS	Enter criteria on the Search Criteria page and click Search or click one of the search by order number Selective Search buttons to launch a manual search.	View Search/Match results of an external system search and investigate potential duplicate IDs.

Page Name	Definition Name	Navigation	Usage
Biographic Details	SCC_SM_RESP_DTL	Click the Detail link on the Search Results page for a matching candidate that does not have an EmplID.	View personal data stored inside the external system.
Regional	SCC_BIO_DEMO_REG	Click the Detail link on the Integrated Search Results page > then Regional tab.	View regional data stored inside the external system.

Viewing Search Results

Access the Integrated Search Results page (Click the **Search** button or one of the available **Selective Search** buttons on the Search Criteria page). If the External Search/Match is triggered and the system has found matching candidates on a search rule number lower or equal to the Search/Match, the Integrated Search Results page appears.

This example illustrates the fields and controls on the Integrated Search Results page.

Search Results

Search Type: Person Ad Hoc Search
Search Parameter: PSCS_TRADITIONAL CS_Person_Traditional
Result Code: PSCS_TRAD_RESUL CS_Person Traditional Results

▼ Search Results Summary [Return to Search Criteria](#)

Number of ID's Found: 34
Search Order Number: 50 Name Only

Search Results							
Results		Results2		Additional Information		[Feedback]	
		Empl ID	Name Type	Name Effective Date	First Name	Middle Name	Last Name
1	Carry It Detail	AD5024	PRF	23/03/2001	John		Smith
2	Carry It Detail	AD5024	PRI	23/03/2001	John		Smith
3	Carry It Detail	AD6000	PRI	21/01/2002	Joanne		Smith
4	Carry It Detail	AD6000	PRI	22/01/2002	Joanne		Smith
5	Carry It Detail	AD6000	PRF	21/01/2002	Joanne		Smith
6	Carry It Detail	CC0066	PRF	13/07/2004	Johnat		Smith
7	Carry It Detail	CC0066	PRI	13/07/2004	Johnattan	William	Smith
8	Carry It Detail	CC0067	PRI	24/06/2004	Johnattaniel	Louis	Smithzierburgh
9	Carry It Detail	CCCM0000	PRF	22/10/2008	John		Smith
10	Carry It Detail	CCCM0000	PRI	22/10/2008	John		Smith
11	Carry It Detail	CCCM0001	PRI	01/01/2006	John	W.	Smith
12	Carry It Detail	CCCM0001	PRF	01/01/2006	JohnPRF	W.	SmithPRF
13	Carry It Detail	CCCM0002	PRF	01/01/2007	Johnattan	Middle	Smitzerland
14	Carry It Detail	CCCM0002	PRI	01/01/2007	Johnattan	Middle	Smitzerland
15	Carry It Detail	CCCM0002	PRF	01/01/2007	Johnattan	Middle	Smitzerland
16	Carry It Detail	CCCM0002	PRI	01/01/2007	Johnattan	Middle	Smitzerland
17	Carry It Detail	CCCM0003	PRF	23/10/2008	JoJo	B.	Smit
18	Carry It Detail	CCCM0003	PRF	03/01/2006	Johna	B.	Smit
19	Carry It Detail	CCCM0003	PRI	03/01/2006	Johna	B.	Smit
20	Carry It Detail	CCCM0003	MDN	05/02/2007	Johna		Smit-Maiden

Many fields on this page are the same as those on the Search Results page. However, there are some important distinctions:

- Records with no EmplIDs appear first in the Search Results group box.
- Records with no EmplIDs are assigned an **External Sys ID**.
- Records with no EmplIDs, that are importing EmplIDs from an external system, are assigned an **External Sys ID** and display the **External Employee ID**.
- Where an EmplID exists, the **Detail** link leads to a page where you can view details of the ID record from the CS system.

- Where no EmplID exists, the **Detail** link leads to a page where you can view details of the data from the external system.
- The **Import** button appears when a person meets the criteria in the external system.
- The **Score %** and **Universal ID** columns appear based on settings defined on the External System Search Match Options page.
- Masking configuration is in effect for all matching constituents, even those with no EmplID.
- For matching constituent records found by External Search/Match, this page displays information that is not necessarily stored inside the external system (for example, **Aid Year**).

<i>Field or Control</i>	<i>Description</i>
Number of ID's Found	The system displays the total number of distinct IDs returned by both Search/Match and External Search/Match, just Search/Match, or just External Search/Match.
Search Order Number	<p>The system shows the Search Order Number where results were found.</p> <p>When the internal and external searches find results under different search rules, the Results Engine evaluates the Search Order Number returned by both searches and displays the results for the search that found results under the smallest search order number (the most restrictive search).</p> <p>When the internal and external searches find results under the same search rule, the Results Engine displays them both.</p>

Search Results

The fields in this group box are similar to those on the Search Results page. The system displays the results returned from both the CS database and the external system, along with additional data to describe the IDs returned. However, the columns are dynamic and they can refer to personal data info or transaction data info. Define static columns to appear here on the External System Search Match Options page.

<i>Field or Control</i>	<i>Description</i>
Score %	The system displays a percentage or a number to weight the matching candidate. If the external system calculates a score and sends it with the matching candidates, the score value is returned from the external system with each ID, to indicate the relevance of the ID found. (You can customize the column label on the External System Search Match Options page.)

Field or Control	Description
Carry ID and Import	<p>The Carry ID button appears when an EmplID exists; otherwise the system displays the Import button. Security access to the Add/Update Person component controls whether users can use the Import button.</p> <p>Click the Import button to import external system data when the person does not exist in the CS system (there is no CS EmplID associated with the person). When you click the button, the system displays a message asking if you want to create the new ID in the system.</p> <p>If you click <i>Yes</i>, the system performs a Fetch Request to request the complete constituent record from the external system. When the system receives the Fetch Response from the external system, it uses the personal data in it to create a new EmplID.</p> <p>After successfully importing the data, the Search Results group box refreshes and the newly created EmplID appears; the Import button for the person row changes to Carry ID. Notice that no other import can be performed (all the Import buttons are then grayed out). This is to prevent the user from importing multiple matching candidates.</p> <p>If you click <i>No</i>, the system does not import any data and returns to the Integrated Search Results page.</p> <p>After successfully importing the data, the Search Results group box refreshes and the Imported EmplID appears; the Import button for the person row changes to Carry ID. Notice that no other import can be performed (all the Import buttons are then grayed out). This is to prevent the user from importing multiple matching candidates.</p>

Field or Control	Description
Detail	<p>If no EmplID exists for the person, click this link to invoke a Fetch Request to retrieve the complete constituent record from the external system. When the system receives the Fetch Response from the external system, it displays the personal data in the response on the Biographical Details page.</p> <hr/> <p>Note: Both the Import button and the Detail link (when no EmplID exists) trigger the same Fetch Request. The data received inside the Fetch Response will only be saved to your database when the Fetch request is triggered from the Import button. It is therefore good practice to always review the detailed information prior to import.</p> <hr/> <p>If an EmplID exists, click this link to access the page set up inside the Search Results Code used to view more information about the person.</p> <p>If a user has access to the page set up inside the Search Results Code used, he also has access to the Integrated Details page. Else, user cannot preview the information.</p>

Additional Information

The Universal ID column appears here, when selected as a static field on the External System Search Match Options page.

Viewing Biographical Details

Access the Biographic Details page (click the **Detail** link on the Integrated Search Results page).

This example illustrates the fields and controls on the Biographical Details page (1 of 2). You can find definitions for the fields and controls later on this page.

Biographical Details
Regional

Universal ID: UID_CCCM0014 **Score:** 80

This component only lists the information known about the individual. The data is stored outside of your database. To create an ID using this data, press the import button. Import

Current Names
Customize | Find | View All | First 1-2 of 2 Last

Name Type	Name	Effective Date	Status	History
Primary	Johnny Current PRI Smit Current PRI	05/05/2005	Active	History
Preferred	Johnny Past Smit Past	04/05/2004	Active	History

Personal Information

Date of Birth: 01/03/1970

Biographical Information

Effective Date: 03/03/2003

Marital Status: Civil P. **As of:** 03/03/2003

Gender: Female

Highest Education Level: A-Not Indicated

Full-Time Student [History](#)

National ID
Customize | Find | View All | First 1-2 of 2 Last

Country	National ID Type	National ID	Primary ID
USA	Social Security Number	xxxxxxxx	Y
USA	Social Security Number	xxxxxxxx	Y

This example illustrates the fields and controls on the Biographical Details page (2 of 2). You can find definitions for the fields and controls later on this page.

Email Addresses
Customize | Find | View All | First 1-2 of 2 Last

Email Type	Email Address	Preferred
Home	JohnnySmit@home.com	N
Business	JohnnySmit@busn.com	Y

Phone Numbers
Customize | Find | View All | First 1-2 of 2 Last

Phone Type	Telephone	Phone Extension	Country Code	Preferred
Campus	777/555-1111			N
Home	666/555-4444			Y

Current Addresses
Customize | Find | View All | First 1-2 of 2 Last

Address Type	Address	Effective Date	Status	History
Home	456 HOME Street Current Apt#CCCM0014 Current Past Address3 Current Chicago, MT 55555	06/06/2006	Active	History
Campus	123 Camp Street 03032003 Apt#CCCM0014 Past Camp Address3 Richelieu, AZ 65432	03/03/2003	Active	

Return

This page displays sections of data that are not actually stored in the CS database until you click the **Import** button.

The system displays messages on this page based on the following conditions:

Note: Where no data exists, the system hides the fields and displays a message in the Missing Information group box.

Data Region	Condition	Message
Current Names	No name information exists	No Current Name Information
Personal Information	No personal information exists	No Personal Information
Biographical Information	No biographical information exists	No Biographical Information
National ID	No national ID information exists	No National ID Information
Email Addresses	No email address information exists	No Email Addresses Information
Phone Numbers	No phone information exists	No Phone Number Information
Current Addresses	No address information exists	No Address Information
Regional	No regional data exists	No Regional Information

Field or Control	Description
Import	Click this button to import the Universal ID and all the information displayed into the CS system and create an EmplID.

Current Names

Field or Control	Description
History	This link appears only if the Universal ID contains a past or future date in addition to the current row. Click the link to access the Name Type History page.

Current Addresses

Field or Control	Description
History	This link appears only if the Universal ID contains a past or future date in addition to the current row. Click the link to access Address Type History page.

View Regional Details

Access the Regional page (click the **Detail** link on the Integrated Search Results page, then Regional tab).

This example illustrates the fields and controls on the Regional page. You can find definitions for the fields and controls later on this page.

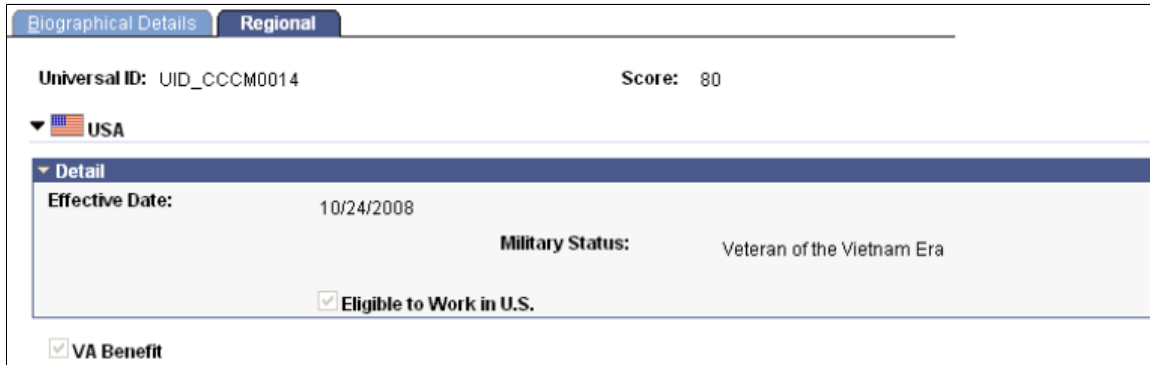

This page is available only if it contains data. If the Fetch Response contains no Regional information, this message appears on the Missing Information group box on the Biographical Details page.

<i>Data Region</i>	<i>Condition</i>	<i>Message</i>
Regional	No regional data exists	No Regional Information

Conducting an Automatic Search

The same XML messaging that is triggered when you use External Search/Match is integrated with other pages within Campus Solutions. On any page where you can add a new person, you trigger an automatic search to the external system when you click the Save button, if an external system is configured.

Understanding External Search/Match Web Services

This section discusses the delivered constituent web services that are triggered and used by External Search/Match functionality. Specifically, this section discusses these web services:

- Match service (SCC_SM_SERVICE).
- Fetch request and fetch response (SCC_SM_FETCH).

The *PeopleSoft Campus Solutions Constituent Web Services Developer's Guide* contains more technical details of these web services including examples of the XML message code.

Match Service

When you click the **Search** or **Selective Search** buttons on the Integrated Search Criteria page, the system conducts an Internal Search/Match, External Search/Match, or both. External Search/Match sends a Match Request to the external system. This is an XML message that contains all of the fields included in the search request. The external system returns a Match Response, also an XML message.

The Match Request XML message (SCC_SM_SERVICE_REQ.V1) to the external system exposes all information that the system has:

- All of the search order numbers that can potentially return matching candidates.
- Search fields.
- Search data.
- Search/Match configuration information.

The Match Response XML message (SCC_SM_SERVICE_RESP.V1) from the external system contains:

- Search order number/rule that found results.
- Matching candidates.
- Score.
- Universal ID/cross reference.
- Person data.
- External Employee ID when importing EmplIDs from external spoke system.

Fetch Request and Fetch Response

When you click the **Detail** or **Import** buttons on the Integrated Search Results page for a constituent without a CS EmplID, the system sends a Fetch Request to the external system. This is an XML message that requests the full constituent record from an external system. The external system returns a Fetch Response, also an XML message.

The Fetch Request XML message (SCC_SM_FETCH_REQ.V1) to the external system contains the universal ID for which the **Import** or **Detail** buttons were selected.

The Fetch Response XML message (SCC_SM_FETCH_RESP.V1) from the external system contains the full constituent record.

When you import a new person record fetched from an external system:

1. The CS system creates an EmplID.
2. The CS system populates the SCC_HUB_MAP table with the EmplID and its Universal ID.
3. The CS system publishes the PERSON_BASIC_SYNC message.
4. The CS system publishes an outbound constituent message (which includes the Universal ID).

5. Using the Universal ID, the external system updates the constituent's reference table with a new EmplID.

Related Links

[Understanding Constituent Web Services](#)

[Setting Up External Search/Match Functionality](#)

Adding a Person to Your Campus Solutions Database

Understanding System ID Assignment

When you open the Add a Person component, the system requests a person ID. You can assign IDs two ways:

- Automatically

If you use automatic ID assignment, the system adds IDs sequentially as you add new people.

The system maintains the last assigned ID on the Installation Table - Settings and Defaults page.

See “Selecting General Installation Options” (Campus Solutions Application Fundamentals)

- Manually

You enter the IDs, using any system that you choose for the organization. With manual entry, you don't need to assign IDs sequentially.

Assigning IDs manually is the only way that you can include alphabetical characters in the IDs.

Note: To avoid maintaining two different sets of IDs, you should either always assign them manually or always let the system assign them.

Related Links

[Establishing ID Delete Control](#)

Adding an Individual to Your Database

To create records in your PeopleSoft Campus Solutions database, you add a person record or an organization record. This section discusses how to add person records for students and other nonpaid individuals.

To add an individual to your system, you must create a personal information record for that individual. If you use automatic ID assignment, when you enter data and save the record, the system assigns the next available sequential ID to that individual and adds the record to your database. Before adding an individual, however, you should run the Search/Match process to determine if a record already exists for that individual.

Important! When you add an individual to your database and save the new value, the system performs an automatic search to determine if a duplicate record already exists. This automatic search uses the search/match criteria established by your institution. It notifies you that a duplicate is detected, but it does not give you the opportunity to identify the duplicates. Use the Search/Match feature to help detect and identify duplicates.

See:

[Setting Up Search/Match](#)

[Using Search/Match](#)

[Creating Organization Records](#)

Warning! Before adding organizations or entering and updating data about them, you must be familiar with PeopleSoft applications, including the Add, Update/Display, Include History, and Correct History modes and the PeopleSoft method of applying effective dates with active or inactive status. See *PeopleTools: Applications User's Guide*, "Understanding Effective Dates."

If you implement PeopleSoft Human Capital Management, you should read the HCM Administer Workforce documentation for adding a person and become familiar with the difference and implications of adding records for employees, contingent workers, and persons of interest. See *PeopleSoft HCM: Human Resources Administer Workforce*, "Adding a Person."

Note: If you implement Campus Solutions *and* a separate instance of PeopleSoft Human Capital Management, read the relevant documentation about CS-HCM Integration to understand the setup, functional, and technical implementation considerations. Certain items and business processes that are detailed in this documentation may vary depending on how you configure Campus Solutions and HCM. See:

“Integrating Person Data” (Campus Solutions Application Fundamentals)

“Integrating Setup Data” (Campus Solutions Application Fundamentals)

“Monitoring Integrations Using the Integrity Utility” (Campus Solutions Application Fundamentals)

See *Information Center: CS-HCM Integration for PeopleSoft Enterprise Campus Solutions* in My Oracle Support (ID 2091799.2).

You can update personal information for an individual on the same Biographical Details page, but in update/display mode after adding the individual.

To add an individual to your database using automatic ID assignment:

1. Select **Campus Community > Personal Information > Add/Update a Person.**
2. Click **Add a New Value.**

The Add a New Value search page appears with *New* in the **ID** field.

Warning! If you overwrite the word *NEW* and manually enter an ID for the new person, you will disrupt the autonumbering sequence included with your system. Your system administrator might need to correct the situation.

3. Click the **Add** button.

The Biographical Details page appears with an **ID** value of *NEW*.

4. Enter at least the required data, which includes the individual's first and last name and all of the data in the **Biographical History** group box (effective date, marital status, and gender).

5. Click **Save**.

If you click **Save** before you enter the required data, an error message appears, reminding you that required data is missing.

If all required data is entered, the system runs an automatic search based on the entered data and the specified search/match criteria. The search determines if a record for this individual already exists. If a record with this data does not already exist, the system assigns the next available unique ID to the record and adds it to your database.

If the system finds an existing record with the data, it displays the *Potential Duplicate Found* warning message.

You can click **OK** to add the individual or click **Cancel** to investigate further.

Warning! If you click **OK**, the system adds the new person even though potential duplicates exist. If this is not what you want, click **Cancel**.

In most cases, you should identify the potential duplicate individuals first to determine if you should add the new one. Then click **Cancel** to exit the message and return to the Biographical Details page; from there, access the Search/Match page to run a search and identify the duplicate.

This example illustrates the fields and controls on the Example of the Add/Update a Person, Add a New Value page where you enter "NEW" to add a person. You can find definitions for the fields and controls later on this page.

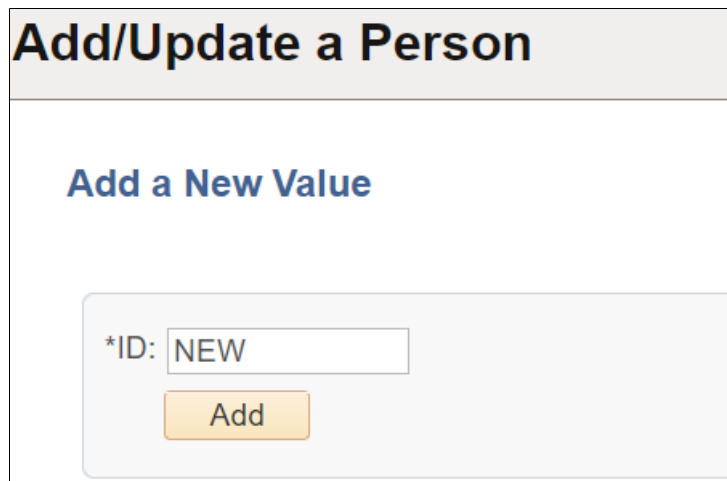

The screenshot shows a web interface titled "Add/Update a Person". Below the title is a section labeled "Add a New Value". Inside this section, there is a form with a label "*ID:" followed by a text input field containing the text "NEW". Below the input field is a yellow button labeled "Add".

This example illustrates the fields and controls on the Example of the top of the Biographical Details page where the system displays the ID of "NEW" when you add a person. You can find definitions for the fields and controls later on this page.

Add/Update a Person

Biographical Details
Regional
Personal
HESA Student Data
HESA Restricted Data

NEW

Person Information

Effective Date

Format Using English [Change Format](#)

Prefix

*First Name

Middle Name

*Last Name

Suffix

Preferred First Name

Preferred Middle Name

Preferred Last Name

Preferred Prefix

Preferred Suffix

Date of Birth

[Birth Information](#)

Campus ID

Biographical History

[Find](#) | [View All](#) | First Last

*Effective Date

*Marital Status

*Gender

As of

If the system detects a record with duplicate information, such as another record with the same National ID number, a *Potential Duplicate Found* warning message appears, providing you the opportunity to continue adding the person or to cancel and investigate the duplicate further.

This example illustrates the fields and controls on the Example of a "Potential Duplicate Found" warning message that appears when the system detects duplicate data. You can find definitions for the fields and controls later on this page.

Warning -- Potential duplicate found at Search Order Number 20 - "SSN Only" (14000,407)

Based upon the data entered and the search/match criteria, a potential match exists between the data being saved and at least one constituent already in your database.

Use Search/Match to further investigate the potential matches. This should help you decide whether the ID you are trying to add is truly new to your database or if this constituent already exists.

Click OK to ignore the warning and continue saving the transaction, click CANCEL to review the results.

OK
Cancel

Adding or Updating Biographical Details Data

To create a personal information record, you must enter biographical data about that individual on the Biographical Details page. To update biographical data, you can return to the Biographical Details page or you can access pages described in the *Managing Biographical Data* section to edit or update specific information. When you save information on either the Biographical Details page or the specific information pages, the system writes it to the relevant maintenance tables and updates that information both places.

This section lists prerequisites and discusses how to:

- Enter biographical details.
- Enter regional specific data.

Related Links

[Understanding Biographical Information](#)

Prerequisites

Before entering or updating basic biographical data, you must design and set up names, addresses, and other foundational elements of Campus Community. You must also set up basic elements for personal data management.

Related Links

[Designing Campus Community](#)

[Setting Up Emergency Contacts Data](#)

Pages Used to Add or Update Biographical Details Data

<i>Page Name</i>	<i>Definition Name</i>	<i>Navigation</i>	<i>Usage</i>
Biographical Details	SCC_BIO_DEMO_PERS	Campus Community > Personal Information > Add/Update a Person > Biographical Details	Enter or update an individual's name and other basic biographical data.
Birth Information	SA_BIRTH_DETAIL	Click the Birth Information link on the Biographical Details page.	Enter or review an individual's birth location data.
Edit Address	EO_ADDR_USA_SEC	Click the Edit Address link on the Biographical Details page.	Edit an individual's address data. If you have enabled address validation on the Address Format page, the system validates the address that you enter when you click OK. The system validates the address by comparing it to the county, state, and city as defined on the Valid Address page. If your address does not contain a valid county, state, and city for the selected country you will receive an error.

Page Name	Definition Name	Navigation	Usage
Address Search	EO_ADDRESS_SRCH	Click the Address Search link on the Edit Address page.	Search for cities within the selected country. This link appears when you change the country by clicking the Change Address link. Enable address search on the Address Format page.
Visa/Permit Data	VISA_PERMIT_DETAIL	Click the Visa/Permit link on the Biographical Details page.	Enter or review an individual's visa and permit data, including country type, date of issue, duration, issuing authority, and other visa and permit information.
Citizenship	SA_CITIZENSHIP_DTL	Click the Citizenship link on the Biographical Details page.	Enter or review an individual's citizenship and passport detail data, including country, citizenship status, passport number, issue date, expiration date, and other relevant information.
Regional	SCC_BIO_DEMO_REG	Campus Community > Personal Information > Add/Update a Person > Regional	Enter regional specific information for an individual.
Personal	SCC_BIO_DEMO	Campus Community > Personal Information > Add/Update a Person > Personal	Enter biographic details separately from the rest of the person's data. This tab becomes available if a field is selected for inclusion on the Biographic Fields page.

Entering Biographical Details

Access the Biographical Details page (**Campus Community > Personal Information > Add/Update a Person > Biographical Details**).

This example illustrates the fields and controls on the Biographical Details page. You can find definitions for the fields and controls later on this page.

When you add a new person and are using system-generated IDs, the field at the top of the page displays the value *NEW* until you save the record. When you access the record after having saved it, the field displays the ID that the system assigned to this individual.

Person Information

<i>Field or Control</i>	<i>Description</i>
Format Using	Click Names to see this field if you're editing an existing user. This field considers the default value defined in the user's primary permission list. If a default value isn't defined in Org Defaults by Permission List, this field is set to English . It also controls which name fields are available.
Date of Birth	Enter the individual's date of birth.
Birth Information	Click this link to access the Birth Information Detail page, on which you can enter or edit the individual's birth location, country, and state.
Campus ID	Enter the campus ID with which this person is most closely associated.

Biographical History

Field or Control	Description
Effective Date (Required)	<p>Enter the date when the marital status and gender should be effective in your system.</p> <p>Note that:</p> <ul style="list-style-type: none"> If you are changing the individual's marital status, you <i>must</i> enter an effective date. If you change the individual's name prefix, first, middle, or last name, suffix, or marital status, you <i>must</i> enter an effective date.
Marital Status (Required) and As of	<p>Specify the individual's marital status (such as single, married, or divorced) and the date (if known) on which the associated marriage or divorce took place.</p> <p>Values for the Marital Status field are delivered with your system as translate values. Do not modify these values in any way. Any modifications to these values could require substantial programming effort.</p>
Gender (Required)	<p>Values for the Gender (Sex) field are delivered with your system as translate values.</p>

National ID

Field or Control	Description
Country	<p>Enter or confirm the country of this individual's national ID.</p> <p>If the individual has more than one national ID, you can add them here.</p>
National ID Type (national ID type)	<p>The system enters the value that you establish for this country on the National ID Type Table page. You can override this default value.</p>
National ID	<p>Enter the individual's national ID number.</p> <p>Enter the number (with or without spaces and dashes). When you exit the field, the system formats the number based on the country and NID type selected.</p>

Field or Control	Description
Primary	Select this check box to indicate the primary national ID number to use for this individual. You must indicate a primary national ID.

(CAN) Verifying Social Insurance Numbers for Canadian Employees

Invoke a modulus 10-check digit formula to verify an individual's Social Insurance Number (SIN), if needed. The formula follows federal standards for using the ninth digit in an employee SIN to verify the number.

If you enter an SIN that doesn't match the check digit that is calculated by the formula, an error message appears.

Note: To use the check digit routine for Canada NID, you must modify the national ID format within the National ID Table to 999-999-998. This is the true default for the check digit routine for Canada and will enable the routine to pass and the page to be saved.

See [Defining National ID Types](#).

(NLD) Verifying Social Security IDs for Dutch Employees

The Dutch National ID is commonly called the SoFi (Social/Fiscal) number. You can invoke the 11-check digit formula to verify a Dutch employee's SoFi number. The 11-check formula is a mathematical formula that evaluates the entry for the employee's Social Security ID and verifies that the result of the calculation is 11, to determine whether the national insurance/social security ID has a valid format.

(USA) When the Social Security Number is Unknown

When the Social Security number is missing, the system enters the default number that is defined on the National ID Type table, which is usually all nines (9s).

Contact Information

Field or Control	Description
Address Type	Select the type of address to enter, view, or update. The system displays <i>Home</i> as the default address type and displays the data, if any, for that address type.
Edit Address	Click this link to access the Edit Address page, on which you can enter or edit address data for the address type selected. When you click OK on the Edit Address page, the data that you entered appears on the Biographical Details page when you return to the page.

Field or Control	Description
Phone	Select a phone type and enter the individual's phone number for that type.
Email	Select an email type and the individual's email address for that type.
Visa/Permit Data	Click this link to access the Visa/Permit Data page, on which you can enter or update the individual's visa and permit data.
Citizenship	Click this link to access the Citizenship page, on which you can enter or update the individual's citizenship and passport data.

Entering Regional Specific Data

Use this page to set up specific information for a region.

Access the Regional page (**Campus Community > Personal Information > Add/Update a Person > Regional**) and the area of the page that is specific to your region.

This example illustrates the fields and controls on the Regional page (with areas collapsed; 1 of 7). You can find definitions for the fields and controls later on this page.



(NZL) New Zealand

The following information is specific to users with an installed country of New Zealand.

This example illustrates the fields and controls on the Regional page (2 of 7), New Zealand. You can find definitions for the fields and controls later on this page.

NEW

▼ New Zealand

Ethnicity

Customize | Find | First 1 of 1 Last

*Regulatory Region	*Ethnic Group	Description	Percentage	
AUS <input type="text"/>	ABRGL <input type="text"/>	Aboriginal	50	-

Add

New Zealand Student

Find | View All | First 1 of 1 Last

National Student Index Data

National Student Number:	NSI Record Status:
Residential Status: <input type="text" value="Citizen"/>	NZQA Paid:
Residential Stat Verification: <input type="text" value="Birth Certificate"/>	Name/DOB Verification: <input type="text" value="Birth Certificate"/>
Residential Status Verified By:	Name/DOB Verified By:
<input type="checkbox"/> NSI Processing Enabled	

First year of formal Ed:

Prior Activity:

Highest Secondary Qual:

Iwi Affiliation

Find | View All | First 1 of 1 Last

***Effective Date:**

Customize | Find | First 1 of 1 Last

*Iwi Code	Description		
0106 <input type="text"/>		+	-

<i>Field or Control</i>	<i>Description</i>
Ethnic Group	This field allows you to select multiple ethnic backgrounds. Click the Add button to add more than one ethnic group.
National Student Number	Displays the individual's unique number if received from the NSI database.

Field or Control	Description
Residential Status	<p>Enter the individual's residential status.</p> <p>Values include:</p> <p><i>Au citizen</i> (Australian citizen)</p> <p><i>Citizen</i></p> <p><i>Overseas</i></p> <p><i>Perm Resid</i> (permanent resident)</p> <p><i>Unknown</i></p> <p>These translate values should not be modified.</p>
Residential Stat Verification (residential status verification)	<p>Indicates the method used to verify the student's residential status.</p> <p>Values include:</p> <p><i>BDM</i> – Used only by the Ministry of Education</p> <p><i>Other Primary ID</i></p> <p><i>Birth certificate</i></p> <p><i>Passport</i></p> <p><i>Unverified</i></p> <p>These translate values should not be modified.</p>
Residential Status Verified By	<p>The Post NSI Data process displays the provider code of the institution that verified the residential status data.</p>

Field or Control	Description
<p>NSI Record Status</p>	<p>The Post NSI Data process displays and updates the status of the record in the NSI database.</p> <p>Values include:</p> <p><i>Inactive:</i> The record is made inactive following the receipt of notification from a provider or Department of Internal Affairs (DIA) of a student's death or as an update from a provider that a record was created for a nonexistent student.</p> <p><i>Active:</i> The record contains all of the required fields and both verifiable fields (name/date of birth pair and residential status) as <i>Verified</i>.</p> <p><i>Partial:</i> The record is missing one or more of the required fields or one or both of the verified indicators set to <i>Unverified</i>.</p> <p>These translate values should not be modified.</p>
<p>NZQA Paid</p>	<p>The Post NSI Data process indicates whether the student's NZQA fee is paid.</p> <p>Values include:</p> <p><i>Yes</i></p> <p><i>No</i></p> <p><i>Unknown</i> – not applicable or unknown</p> <hr/> <p>Note: When set to <i>Yes</i>, the NSN is cloned to the external system ID table for the NZQA ID Upload process to load as a external system value of NZQA. When the NZQA exists, it indicates that NZQA fees are paid.</p> <hr/>

Field or Control	Description
<p>Name/DOB Verification (name/date of birth verification)</p>	<p>Enter the method used to verify the name and date of birth.</p> <p>Values include:</p> <p><i>BDM</i> – Used only by the Ministry of Education</p> <p><i>Birth certificate</i></p> <p><i>Other Primary ID</i></p> <p><i>Passport</i></p> <p><i>Unverified</i></p> <p>These translate values should not be modified.</p>
<p>Name/DOB Verification By (name/date of birth verification by)</p>	<p>The Post NSI Data process displays and updates the provider code of the institution that verified the name and date of birth data.</p>
<p>NSI Processing Enabled</p>	<p>Select to automatically update NSI data when changes are made to NSI fields. When selected, the system updates the data if the individual has a National Student Number (NSN) in your database or if the individual does not have an NSN but has been selected by mass change (NSN App Engine process CCNSIRQN) to request an NSN from the National Student Index (NSI) and appears on the Outgoing Page of the NSI Suspense Table waiting to request an NSN from NSI.</p> <p>NSI fields include: First Name, Last Name, Middle Names, Gender, Date of Birth, and Residential Status fields, the verification fields for Name/DOB, and residential status fields</p> <p>The system automatically clears the check box when the Purge Mass Change Results process runs and the record has not yet been extracted by the Extract NSI Data process (the record is still in <i>Ready for Extraction</i> status).</p> <hr/> <p>Note: If you manually select the check box and save the page, the check box becomes permanently unavailable. Manually select it only if you decide that an individual record that does not meet the criteria in your mass change definitions should be sent to NSI.</p> <hr/>

See:

[Understanding PeopleSoft NSI Processing](#)

(AUS) Australia

The following information is specific to users with an installed country of Australia.

This example illustrates the fields and controls on the Regional page (3 of 7), Australia. You can find definitions for the fields and controls later on this page.

▼ Australia

Ethnicity

[Personalize](#) | [Find](#) | [Print](#) | [Grid](#) | First 1 of 1 Last

*Regulatory Region	*Ethnic Group	Description	Percentage	
USA <input type="text"/>	<input type="text"/>		<input type="text"/>	-
+				

Citizenship History

[Find](#) | [View All](#) | First 1 of 1 Last

Effective Date
Citizenship Status

+ -

Tax File Number

Enter Tax File Number
 TFN Verified

TFN Certificate of Application
TFN Certificate Issue Date

Unique Student Identifier

USI
 USI Verified

USI Exemption Granted

Note: The Australian Tax File Number (TFN) is a number that is issued to a person by the Commissioner of Taxation. It is used to verify client identity and establish income levels. The number is an eight or nine digit number without any embedded meaning, and is based on a check digit algorithm set by the Commissioner of Taxation. You cannot view a TFN once it has been entered and saved in your PeopleSoft database.

Field or Control	Description
Ethnic Group	This field allows you to select multiple ethnic backgrounds. Click the Add button to add more than one ethnic group.

Field or Control	Description
Enter TFN (enter tax file number) or Re-enter TFN (re-enter tax file number)	<p>The Enter TFN check box appears only if no tax file number exists in the database for the individual. Select to display the Tax File Number field where you can enter the TFN.</p> <p>The Re-enter TFN check box appears only if a tax file number has been previously saved in the database for the individual. Select to re-enter and overwrite the individual's TFN.</p>
TFN Verified	Select the check box to indicate whether the TFN has been verified by HEIMS and the ATO. If a TFN is updated or re-entered, this check box is reset to unverified.
TFN Certificate of Application	Select to indicate that students have applied for a tax file number (TFN), but have not received one. Instead, students are using a Certificate of Application until they receive a TFN.
TFN Certificate Issue Date	Select the date when the student received the TFN Certificate of Application.
Comment	Enter additional information related to the TFN Certificate of Application.
USI (Unique Student Identifier)	<p>Enter the student's unique ID.</p> <p>This value is verified to ensure that it meets the check digit algorithm and only has valid characters.</p>
USI Verified	Only for information. Reserved for future functionality.
USI Exemption Granted	Select to indicate that a USI exemption has been granted to the student. When you select this check box, the Comments field is enabled.
Comments	This field is enabled when you select <i>USI Exemption Granted</i> .

(CAN) Canada

The following information is specific to users with an installed country of Canada.

This example illustrates the fields and controls on the Regional page (4 of 7), Canada. You can find definitions for the fields and controls later on this page.

Canada

History Find | View All First 1 of 1 Last

*Effective Date: 07/12/2004 Health Care Number:

Bilingualism Code: Health Care Province:

*Visible Minority: Not a Visible Minority Aboriginal Person

Sensitive Record: No (A) Student Funding Approval

National Student No.:

Prov Funding Class:

<i>Field or Control</i>	<i>Description</i>
Bilingualism Code	Enter the appropriate code for the person. If the Official Languages Act applies to the organization, use the bilingualism code as part of the Official Languages reports (PER102CN and PER108CAN) that you submit to the government.
Health Care Number and Health Care Province	Enter a number and select the health care province.
Visible Minority	Select a code to indicate whether the person's ethnic background is apparent based on physical appearance.
Aboriginal Person	Select this check box to indicate that the person is a Canadian aboriginal person.
Sensitive Record	Indicate whether the individual's record is sensitive, and for which the system should exclude from Statistics Canada's mail or telephone surveys.
National Student No. (national student number)	Enter the Canadian national student number for the student.
Prov Funding Class (provincial funding classification)	Enter the funding classification by citizenship for grant purposes. This field prompts against the CAN_PROV_FUN record defined for the business unit.
Student Funding Approval	Select this check box to indicate that the student is approved for funding.

(NLD) Netherlands

The following information is specific to users with an installed country of the Netherlands.

This example illustrates the fields and controls on the Regional page (5 of 7), Netherlands. You can find definitions for the fields and controls later on this page.

▼ Netherlands

Find | View All | First 1 of 1 | Last

***GBA Nationality Code:** Dutch

Status:

Start Date:

Estimated Start Date:

Find | View All | First 1 of 1 | Last

***Effective Date:** **Correspond Nbr:**

Find | View All | First 1 of 1 | Last

Effective Date: **Studielink Nbr:**

Find | View All | First 1 of 1 | Last

***Prior Education:** HAVO N+T

Program Status:

External Org ID: Brighton High School

Ext Org Location: 1 School Office

End Date:

Diploma Year:

20QC Highest form of Education

Mutation Datetime Stamp: 10/12/12 12:05PM **Mutation By:** SIS

Personalize | Find | View All | First 1 of 1 | Last

Subject Area	Description	External GPA	
1	ACCT <input type="button" value="🔍"/> Accounting	<input type="text"/>	<input type="button" value="+"/> <input type="button" value="-"/>

This example illustrates the fields and controls on the Regional page (6 of 7), Netherlands. You can find definitions for the fields and controls later on this page.

▼ Netherlands

Find | View All | First 1 of 1 | Last

Effective Date: **Status:** **Mandatory Type:** Exempt

Find | View All | First 1 of 1 | Last

Effective Date: **Status:** Right to Scholarship

[GBA Reporting Names](#)

Find | View All | First 1 of 1 | Last

***Destination Country:** ***Start Date:** **Estimated Start Date:**

Last Updated On: 10/12/2012 11:48:10AM **Updated By:** PS

Dutch schools receive funding from the Dutch Government for each student who complies with a predefined set of rules. To qualify for these funding schemes, schools must adhere to strict rules about the way that students are allowed to enter the admissions and registration process and about what information is registered and in what way. The Dutch Government requests that specific information about a student's prior curriculum and test results, language skills, and personal data are stored in the student administration application that is used.

GBA (Gemeentelijke Basis Administratie), the register of all Dutch citizen data, requires the registration of a student's nationality as kept by the different city councils.

Field or Control	Description
GBA Nationality Code (Gemeentelijke Basis Administratie nationality code), Start Date , and Status	Enter the GBA nationality code, start date, and status. If a person's nationality changes, add a new row. Enter the new GBA nationality code and start date, with a status of <i>Active</i> . The new nationality becomes active and the old nationality row is set to status of <i>Inactive</i> . This enables you to maintain GBA code history.
Correspond Nbr (correspondence number)	In specific cases a correspondence number of a student may change. Add a new row and enter the new number with a status of <i>Active</i> . To track the data exchanged, you must store both the old and the new numbers.
Prior Education	Enter data for all known prior education for the student. When all prior education is entered, the administrator can combine relevant schools (external organization IDs) and all subjects with relevant grade point averages.
Program Status	Enter the status of the prior education specified. Values are: <i>Completed</i> <i>Completed</i> <i>Running</i>
External Org ID (external organization ID)	Enter the ID of the education institution where the prior education took place.
Ext Org Location (external organization location)	Select a Sub BRINcode.
End Date	Enter the date on which the prior education was completed.
Diploma Year	Enter a Diploma Year in place of diploma end date if exact date is unknown.
Highest form of Education	Select this check box if this is the highest level of education attained by the student.

Field or Control	Description
External Subject Area and External GPA (external grade point average)	Enter the specific course subject and corresponding grade.
GBA Reporting Names (Gemeentelijke Basis Administratie reporting names)	Click this link to access the Names page.
Mandatory Type or Exempt	<p>Enter a value to indicate the degree to which the type of education that your institution provides is, by Dutch law, mandatory for the student.</p> <p>Mandatory Type field values are:</p> <p><i>Complete Exempt</i></p> <p><i>Fully Mandatory</i></p> <p><i>Not Mandatory</i></p> <p><i>Partial Exempt</i></p> <p><i>Partial Mandatory</i></p> <p>If no level of education is mandatory for the student, select the Exempt check box.</p>
Right to Scholarship	Select this check box if the student is eligible for a government scholarship.
Destination Country	Enter a Country code if the student has taken up residency outside of the Netherlands.

Note: **Mandatory Type** and **Right to Scholarship** values are used for the registration of Base Register Education, Basis Register Onderwijs (or BRON) related data.

(USA) United States

The following information is specific to users with an installed country of *USA* (United States of America).

This example illustrates the fields and controls on the Regional page (7 of 7), USA. You can find definitions for the fields and controls later on this page.

The screenshot shows the 'Ethnicity' section of a web application. At the top, there is a checkbox labeled 'Person is Hispanic or Latino' and a dropdown menu labeled 'If Yes, Select Ethnic Group'. Below this is a table with the following columns: '*Regulatory Region', '*Ethnic Group', 'Description', 'Ethnic Category', 'Primary', 'IPEDS', and 'Percentage'. A single row is visible with the values: USA, HAWAIIA, Hawaiian, Asian, checked, unchecked, and empty. An 'Add' button is located at the bottom right of the table. Below the table is a 'History' section with a date field 'Effective Date' (12/11/2009) and a dropdown 'Military Status'. At the bottom of the history section are three checkboxes: 'Disabled', 'Disabled Veteran', and 'VA Benefit'.

Field or Control	Description
<p>Person is Hispanic or Latino</p>	<p>Select this check box to indicate whether the person is of Hispanic or Latino origin.</p> <p>For further information on guidelines for defining if person is Hispanic or Latino, see http://nces.ed.gov/statprog/2002/std1_5.asp.</p> <hr/> <p>Note: You must select this check box if a row exists in the grid that indicates Hispanic origin.</p> <hr/>
<p>If yes, Select Ethnic Group</p>	<p>If you selected the Person is Hispanic or Latino check box, then select an ethnic group code to further refine the person's ethnicity.</p> <p>When you select a value, row changes occur as follows:</p> <ul style="list-style-type: none"> • If no value exists in the drop-down list and you select a value that does not currently exist on the record, the system inserts a new row into the grid. • If a value exists in the drop-down and that value exists in the grid, when you select a new value from the drop-down, the system updates the existing row. • If a value exists in the drop-down and blank is selected from the drop-down, nothing affects existing rows. • If the drop-down value is blank and you select a value that already exists in the grid, nothing happens to the existing rows.

Field or Control	Description
Ethnic Group	This field allows you to select multiple ethnic backgrounds. Click the Add button to add more than one ethnic group.
Ethnic Category	The system populates this field based on the value in the EEO Ethnic Group field for U.S. regulatory region ethnic groups or the Ethnic Category for ethnic groups tracked for other regulatory regions. For any ethnic group codes with a regulatory region of USA, this field should always map to one of these five races: <ul style="list-style-type: none"> • American Indian or Alaska Native. • Asian. • Black or African American. • Native Hawaiian or Other Pacific Islander. • White. For more information on the guidelines for mapping ethnic group codes to the five races, visit the National Center for Education Statistics website . See Defining Ethnic Groups .
Primary	Select this check box to indicate with which ethnic group the person most directly identifies.
IPEDS	Select this check box to indicate that the data has been submitted by a reliable source, such as application data or self service, in response to the IPEDS questions.
Percentage	Indicate the share of 100 of which this person derives his or her ethnicity. The system displays a warning if you enter an amount over 100.
Military Status	Select the value that describes this person's current military status.
Disabled	Select this check box to indicate that the individual is disabled and might be covered by the Americans with Disabilities Act (ADA).

Field or Control	Description
Disabled Veteran	Select this check box to indicate that the individual is a veteran who was disabled in the line of duty and might be entitled to certain U.S. Veteran's benefits as well as being covered by the ADA.
VA Benefit (Veterans Administration benefit)	Select this check box to indicate that the individual currently receives veteran benefits from your institution. Navigate to Veterans Benefit Reporting (Records and Enrollment > Enrollment Reporting > Veterans Benefit Reporting) to complete enrollment certifications and tuition calculations. See "Setting Up Veterans Benefit Reporting" (Student Records).

Note: When you save the page, the system records the operator ID and the last updated date and time, although the fields do not appear here.

Entering Personal Information

The Personal page appears if at least one field is selected for inclusion on the Biographic Fields page in the Campus Community installation settings. The page is secured by permission list security (HCCPCSSA1000). If configured as Display Only in the installation settings, a field is read-only on the Personal page for all users irrespective of their permissions. For more information, see [Reviewing or Defining Installation Settings For Biographic Fields](#).

Access the Personal page (**Campus Community** > **Personal Information** > **Add/Update a Person** > **Personal**).

Field or Control	Description
Birth Gender	Select a birth gender from the list of values, if permitted. The field label is defined as message text on the Biographic Fields page.
Gender Identity	Select a gender identity from the list of values, if permitted. The field label is defined as message text on the Biographic Fields page. If you select <i>Other</i> , and the Other Identity field is included, the Other Identity field appears.

Field or Control	Description
Other Identity	<p>Enter a description with a maximum of 120 characters. The field label is defined as message text on the Biographic Fields page.</p> <p>This field appears if Gender Identity is included on the page and is set to <i>Other</i>, or if Other Identity is included but Gender Identity is not. However, if an Other Identity value is saved and Gender Identity is not included on the page, the Gender Identity value in the underlying record is set to <i>Other</i> (OT).</p>
Sexual Orientation	<p>Select a sexual orientation from the list of values, if permitted. The field label is defined as message text on the Biographic Fields page. If you select <i>Other</i>, and the Other Orientation field is included, the Other Orientation field appears.</p>
Other Orientation	<p>Enter a description with a maximum of 120 characters. The field label is defined as message text on the Biographic Fields page.</p> <p>This field appears if Sexual Orientation is included on the page and is set to <i>Other</i> or if Other Orientation is included but Sexual Orientation is not. However, if an Other Orientation value is saved and Sexual Orientation is not included on the page, the Sexual Orientation value in the underlying record is set to <i>Other</i> (OT).</p>
Preferred Pronouns	<p>Select preferred pronouns from the list of values, if permitted. The field label is defined as message text on the Biographic Fields page. If you select <i>Other</i>, and the Other Pronouns field is included, the Other Pronouns field appears.</p>
Other Pronouns	<p>Enter a description with a maximum of 120 characters. The field label is defined as message text on the Biographic Fields page.</p> <p>This field appears if Preferred Pronouns is included on the page and is set to <i>Other</i> or if Other Pronouns is included but Preferred Pronouns is not. However, if an Other Pronouns value is saved and Preferred Pronouns is not included on the page, the Preferred Pronouns value in the underlying record is set to <i>Other</i> (OT).</p>
Attribute Label 1 through 9	<p>Select a value from the list of values, if defined. Field labels are defined on the Biographic Fields page.</p>

You can set up an Attributes sub-page on the Personal page using the Common Attribute Framework, by defining at least one attribute in the Record Context (SCC_PERS_BIOG).

Assigning and Managing Affiliations

Understanding Affiliations

Institutions often need to know what relationships a person has with them. They need to be aware of any current or past relationships, as well as any simultaneous relationships. To track these relationships, known as affiliations with an institution, it's important to be able to define affiliations within an affiliation framework. Within this extensible framework, institutions can define hierarchies (such as Student > Undergrad > Engineering) as well as rules for activating or inactivating affiliations.

Affiliations are keyed by institution and are effective-dated; they begin and end, and a person can have multiple, simultaneous affiliations assigned at one time or throughout time. The system notes the user ID and date and time any affiliation is assigned or updated.

Note: The Affiliation feature is a more robust method of tracking a person relationship with the Institution. However, the existing Relations with Institutions functionality in Campus Community is not replaced.

There are three ways in which affiliations are created and updated:

- Manually by an administrator, for individual IDs, on the Add/Update Affiliations page.
- Automatically by batch processing, for groups of IDs, on the Affiliation Batch Processing page.
- Triggered by specific affiliations events, through Integration Broker and XML messaging.

A change in a person's relationship, or affiliation, with the institution (for example, when a prospect becomes an applicant, applicant becomes a student, student becomes an employee, or when a student graduates) can automatically generate an update to that person's affiliations record.

Affiliations uses constituent web services to communicate changes to a person record. The *PeopleSoft Campus Solutions Affiliations Developer's Guide* contains detailed information about web services in general, the Affiliation Engine, as well as examples of XML messages for affiliations.

See:

- *PeopleSoft Campus Solutions Constituent Web Services Developer's Guide* in My Oracle Support (ID 1982192.1).
- [Understanding Constituent Web Services](#)

This example illustrates the fields and controls on the Affiliation icon. You can find definitions for the fields and controls later on this page.



The Affiliation icon appears on all pages that contain bio/demo data in the system, which enables you to review the details about a person's affiliations with an institution.

Related Links

- [Understanding Biographical Information](#)
- “Defining Constituent Types” (Contributor Relations)

Adding and Updating Affiliations

This section discusses how to:

- Assign and review affiliations.
- View affiliation details.

Pages Used to Add and Update Affiliations

Page Name	Definition Name	Navigation	Usage
Add/Update Affiliations	SCC_AFL_ADDUPD	Campus Community > Affiliations > Add/Update Affiliations	Assign or update affiliation codes for a person.
View Affiliations Details	SCC_AFL_VWHIST_SEC	Click the View Details button on the Add/Update Affiliations page.	View affiliations details and history for a person, and update status and descriptors here.
Context Fields	SCC_AFL_CONTXT_FLD	Click the Context Fields button on the Add/Update Affiliations page.	View the values of the Context Fields associated with Affiliation Code

Assigning and Reviewing Affiliations

Access the Add/Update Affiliations page (**Campus Community** > **Affiliations** > **Add/Update Affiliations**).

This example illustrates the fields and controls on the Add/Update Affiliations page. You can find definitions for the fields and controls later on this page.

Add/Update Affiliations

Marianne Lanctin CC0007

Institution: PeopleSoft University

Relations to Institutions											
*Affiliation Code	Description	*Start Date	End Date	*Affiliation Status	Descriptor	Affiliation Ranking	System Maintained	Primary Affiliation	Hierarchy level	View Details	Context Fields
ALUMN_TMPL	PSUNV Alumni	06/06/2013		Active	Applied	01000	<input checked="" type="checkbox"/>	<input type="checkbox"/>	1	View Details	Context Fields
Add											

Field or Control	Description
Affiliation Code	Displays the name of the code assigned to the person. If adding a manual affiliation for a person, choose a code from the list of all available affiliation codes established for the institution.
Description	Displays the description of the affiliation code. Click the link to view information for a specific affiliation code on the Affiliation Definition View page.
Descriptor	Displays the supporting description associated with the Status . Statuses and their descriptions are set up on the Affiliation Status Setup page and are assigned and updated on the page invoked by the View Details button.
Affiliation Ranking	Displays the five-digit rank assigned to the affiliation code. Rankings are set up on the Affiliation Ranking page.
System Maintained	If you select this check box, the system will make all affiliation updates going forward. If you clear this check box, all affiliation updates must be done manually. You can select the option to have the system maintain an affiliation at any time. This selection is accomplished on the page invoked by the View Details button.
Hierarchy Level	Displays the hierarchy level of the specified affiliation code. Click the link to access the Parent Affiliation Details page.
View Details	Click this button to access the View Affiliations Details page, which displays the history of the affiliation code assignment and enables setting the affiliation end date, affiliation status, affiliation status descriptor, and System Maintained check box.
Context Fields	Click this button to display the values of the of the Context Fields associated with this Affiliation Code .

When you click the **Save** button, the system generates and sends the Constituent Outbound message to any external system that subscribes to it.

See *PeopleSoft Campus Solutions Affiliations Developer's Guide* in My Oracle Support (ID 1982190.1).

Viewing Affiliation Details

Access the View Affiliations Details page (Click the **View Details** button on the Add/Update Affiliations page).

This example illustrates the fields and controls on the View Affiliations Details page. You can find definitions for the fields and controls later on this page.

View Affiliations Details

Affiliation History	
EmpID:	CC0006 Albert Gerhling
Institution:	PSUNV PeopleSoft University

Affiliation Details		Find View All	First	1 of 1	Last
Affiliation Code:	ALUMNI	PSUNV Alumni			
Start Date:	02/24/2009	End Date:	<input type="text"/>		
Affiliation Status:	Active	Status Description:	Applied		
Sponsoring Dept:					
Placed Method:	Manual				
Last Update User ID:	PS				
Last Update Date/Time:	02/25/2009 2:41:52PM				

<i>Field or Control</i>	<i>Description</i>
Affiliation Status	Select the status of the affiliation.
Status Description	Select the supporting description associated with the Affiliation Status . Status Descriptions are set up on the Affiliation Status Setup page.
System Maintained	If you select this check box, the system will make all affiliation updates going forward. If you clear this check box, all affiliation updates must be done manually.
Placed Method	The system displays how the affiliation code was assigned to the person. Options are <i>Manually</i> , <i>Event</i> , or <i>Batch</i> .

The values that appear for the **Sponsoring Department** and **Affiliation Ranking** fields are assigned during affiliation setup.

Viewing Context Fields

Access the Context Fields page (Click the **Context Fields** button on the Add/Update Affiliations page).

Note: To view **Context Fields**, you must activate Constituent Web Services Version 2 in your Integration Broker configuration.

This example illustrates the fields and controls on the Context Fields page. You can find definitions for the fields and controls later on this page.

Context Fields

Empl ID CC0007 Marianne Lanctin

Institution PSUNV PeopleSoft University ALUMN_TMPL

Context Data Find First 1-2 of 2 Last

Record (Table) Name AV_CLASS_YR

Field Name AV_CLASS_YR

Context Values Find | [2] | [grid] First 1 of 1 Last

	Value
1	2011

Record (Table) Name AV_CLASS_YR

Field Name ALUMNUS_TYPE

Context Values Find | [2] | [grid] First 1 of 1 Last

	Value
1	G

Processing Affiliations in Batch

This section discusses how to use batch processing to assign or update affiliations to groups of IDs.

Page Used to Process Affiliations in Batch

Page Name	Definition Name	Navigation	Usage
Affiliation Batch Processing	SCC_AFL_RUN_CNTL	Campus Community > Affiliations > Affiliation Batch Processing	Choose processing parameters and run the Batch Affiliations process.

Running the Affiliations Batch Process

Access the Affiliation Batch Processing page (**Campus Community > Affiliations > Affiliation Batch Processing**).

This example illustrates the fields and controls on the Affiliation Batch Processing page. You can find definitions for the fields and controls later on this page.

Run Control ID: sunita [Report Manager](#) [Process Monitor](#) [Run](#)

Affiliation History

Institution: PSUNV PeopleSoft University

ID Selection

ID Selection: Population Selection

Population Selection

Selection Tool: PS Query

Query Name: SCC_BND_AFL_CC [Launch Query Manager](#) [Preview Selection Results](#)

Select Affiliation Code

Affiliation Code Selection: All Codes

Affiliation Codes		Customize Find First 1-6 of 6 Last
Affiliation Code	Description	
ALUMNI	PSUNV Alumni	
APP-GRAD	Graduate Applicant	
APP-UGRD	Undergrad Applicant	
RECRUITER	PSUNV Recruiter	
STU-FAU	FineArts Undergrad Student	
STU-GFAU	FineArts Grad Student	

ID Selection

Field or Control	Description
ID Selection	<p>Select <i>Person ID</i> or <i>Population Selection</i>.</p> <p>If you select <i>Person ID</i>, the Person ID field appears. Enter a single ID to assign affiliation code(s).</p> <p>If you select <i>Population Selection</i>, the Population Selection group box appears. Enter a Selection Tool (either External File or PS Query) and the corresponding values for the fields associated with that selection tool.</p> <p>See Setting Up Selection Tools.</p>
Person ID	<p>Enter the ID for the person you want to evaluate and assign the affiliation(s) specified in the Affiliation Codes group box.</p>

Select Affiliation Code

Field or Control	Description
Affiliation Code Selection	Select <i>One or More Codes</i> , or <i>All Codes</i> . If you select <i>All Codes</i> , the system evaluates all affiliation codes currently available within an institution for the person. Select <i>One or More Codes</i> to specify the exact affiliation code or codes to be evaluated for the person.
Clear Codes	Click this button to remove all codes listed on the page. You can use this button regardless of whether you assign a code to one person or you use Population Selection.
Affiliation Code	Specify the affiliation code(s) to be assigned to the person. If you selected <i>One or More Codes</i> in the Affiliation Code Selection field, enter the specific affiliation codes that you want the system to evaluate to determine if the necessary criteria is met to assign the affiliation code. If you selected <i>All Codes</i> in the Affiliation Code Selection field, then all affiliation codes available for the institution appear and are evaluated to determine if the criteria is met for each separate affiliation code.

When you click the **Run** button, the system creates the group of people and runs the SCC_AFL_RUN Application Engine process. The process evaluates the criteria for each affiliation code specified and determines whether an affiliation in the **Affiliation Codes** group box can be assigned to the specified person IDs or to the group of people created by the Population Selection criteria.

For each ID, the system evaluates whether the person meets the criteria for an affiliation code; if so, the process then applies the affiliation code to that person's record based on the criteria specified for the affiliation. This criteria is specified as part of the affiliation definition in the Application Class field on the Definition page. If the person does not meet the criteria, the process does not assign the affiliation and moves on to evaluate the next potential affiliation for that person or moves to the next person in the group, depending on how you defined the process criteria. For example, if the affiliation criteria expects a person to be a graduate student but the person does not have an assigned academic career of *Graduate*, then the criteria is not met for that affiliation and the process does not assign the affiliation to the person ID.

For groups created through the Population Selection process, the system evaluates each group member and assigns affiliation codes only to those members who meet the criteria and skips the affiliation codes for which the members do not qualify. The process does not remove expired or invalid codes, but does end date the affiliation. The process ignores manually created affiliation codes, and also ignores manually assigned codes if the System Maintained check box is not selected for that code.

During this process, as each affiliation is assigned to a person, the system publishes a Constituent Outbound message.

When the process is complete, view results on the View Person Affiliations component.

Note: This batch process differs from manual assignment functionality on the Add/Update Affiliations page; the manual process does not require the person to meet any criteria before an affiliation can be created.

See *PeopleSoft Campus Solutions Affiliations Developer's Guide* in My Oracle Support (ID 1982190.1).

Deleting Affiliations

This section provides an overview of affiliation delete functionality and discusses how to:

- Select and delete affiliation codes.
- Delete affiliations associated with a person.

Understanding Affiliation Delete Functionality

Affiliation delete functionality enables you to select and completely delete affiliations associated with a person or group of people. Administrators have the ability to completely delete an affiliation or multiple affiliations for a specific ID as well as the ability to delete an affiliation or multiple affiliations for a specific population as defined through Population Selection. This functionality is used when there is no need to keep any history associated with the affiliation code and when the decision to simply designate an affiliation code as *inactive* or *deleted* is not a viable option.

Note: Instead of deleting an affiliation code, the administrator can assign the affiliation code the status of *inactive*, which would prevent the relationship (affiliation code) from being used in the future while still maintaining the history that it existed at one time.

Pages Used to Delete Affiliations

<i>Page Name</i>	<i>Definition Name</i>	<i>Navigation</i>	<i>Usage</i>
Affiliation Select Delete Processing	SCC_AFL_PRG_RUNCTL	Campus Community > Affiliations > Affiliations Select Delete	Choose processing parameters and run the process to select and then delete affiliation codes.
Delete Affiliations	SCC_AFL_FILTER	This page becomes available after you run the SCC_AFL_PRDL Application Engine process on the Affiliation Select Delete Processing page.	Delete ID/Affiliation code pairs that met the filter criteria specified on the Affiliation Select Delete Processing page.

Selecting and Deleting Affiliation Codes

Access the Affiliation Select Delete Processing page (**Campus Community** > **Affiliations** > **Affiliations Select Delete**).

This example illustrates the fields and controls on the Affiliation Select Delete Processing page. You can find definitions for the fields and controls later on this page.

ID Selection

<i>Field or Control</i>	<i>Description</i>
ID Selection	Select either <i>Person ID</i> or <i>Population Selection</i> . If you select <i>Person ID</i> , enter a single ID to list affiliation code (s) associated with this ID. If you select <i>Population Selection</i> , the Population Selection group box appears. Enter a Selection Tool (either <i>External File</i> or <i>PS Query</i>) and the corresponding values for the fields associated with that selection tool.
Empl ID	Enter the ID for the person for whom you want to delete affiliation code(s).

Additional Filter Criteria

<i>Field or Control</i>	<i>Description</i>
Affiliation Code Selection	Select <i>All Codes</i> or <i>One or More Codes</i> . If you select <i>All Codes</i> , the system evaluates all affiliation codes currently available within an institution for the person. Select <i>One or More Codes</i> to specify the exact affiliation code or codes to be evaluated for the person.

Field or Control	Description
Affiliation Status	Select the status of the affiliation code you are considering deleting. System-defined affiliation status values are <i>Active</i> , <i>Inactive</i> , or <i>Error</i> .
Clear All Codes	Click this button to remove all affiliation codes listed to be processed as listed in the group box. You can use this button regardless of whether you are referring to a code for one person or you use Population Selection.
Preview Data	This button appears after you click the Run button to run the SCC_AFL_PRDL process that creates the people/affiliation code pairs that meet the criteria specified by the filter. This is the group that can be acted upon to delete affiliations. The <i>Preview Data</i> button is unavailable for selection until the process has been run.

Click the **Run** button after selecting IDs and applying the additional filter criteria for affiliation codes and affiliation status. When you click the **Run** button, the system creates the group of people and runs the SCC_AFL_PRDL Application Engine process. The process evaluates each affiliation code specified in the **Affiliation Codes to be processed** group box with the affiliation status for each ID from the person ID field or from the group of people created by the Population Selection process.

For each ID, the system evaluates whether the person has the affiliation code assigned with the affiliation status as indicated. If the person does not have the affiliation code assigned with the associated status, the process does not include this affiliation code for this person in the list and moves on to evaluate the next potential affiliation code for that person.

For groups created through the Population Selection process, the system evaluates each group member and determines if the ID has the affiliation code assigned with the associated status.

All IDs and affiliation codes that match the criteria appear on the Delete Affiliation page, where the actual ID/Affiliation code pair can be selected for deletion.

Deleting Affiliations Associated With a Person

Access the Delete Affiliations page (Run the SCC_AFL_PRDL Application Engine process on the Affiliation Select Delete Processing page).

All IDs marked for deletion upon clicking the **Save** button will be saved to a temporary list and the **Delete** button will appear. Click the **Delete** button to actually delete the IDs marked for deletion.

Reviewing Affiliations

This section discusses how to:

- Review affiliation data in a tabular view.

- Review affiliation data in a tree view.
- Review affiliation data in a chart view.
- Review affiliation data throughout the system.

Pages Used to Review Affiliations

Page Name	Definition Name	Navigation	Usage
Tabular View	SCC_AFL_VIEW	Campus Community > Affiliations > View Person Affiliations > Tabular View	View information for all current and past person affiliations in the system.
Parent Affiliation Details	SCC_AFL_PARENT_SEC	Click a Hierarchy level link on the Tabular View page, Affiliations tab.	View details about the others levels of the selected affiliation hierarchy.
View Affiliation History	SCC_AFL_HIST_SEC	Click the View History button on the Tabular View page, Affiliations tab.	View historical details of the selected affiliation code.
Hierarchical View	SCC_AFL_HIR_PERSON	Campus Community > Affiliations > View Person Affiliations > Hierarchical View	View information for all current and past affiliations for a person in the system, in a tree structure.

Reviewing Affiliation Data in a Tabular View

Access the Tabular View page (**Campus Community > Affiliations > View Person Affiliations > Tabular View**).

The fields on this page are similar to those on the Add/Update Affiliation page.

Field or Control	Description
Affiliation Code	Click this link to view affiliation setup details on the Affiliation Definition View page.
Hierarchy Level	Click this link to view information about the higher levels of the hierarchy on the Parent Affiliation Details page.
View Details	Click this button to view historical details of the affiliation code on the View Affiliation Details page.
Context Fields	Click this button to display the values of the of the Context Fields associated with this Affiliation Code .

As on the Affiliations tab, click the **Affiliation Code** link to access the Affiliation Definition View page.

Reviewing Affiliation Data in a Hierarchical View

Access the Hierarchical View page (**Campus Community > Affiliations > View Person Affiliations > Hierarchical View**).

This example illustrates the fields and controls on the Hierarchical View page. You can find definitions for the fields and controls later on this page.

The screenshot displays the Hierarchical View interface. At the top, there are three tabs: 'Tabular View', 'Hierarchical View' (selected), and 'Chart View'. Below the tabs, the user's name 'Ralph Crowe' and affiliation code 'CC0001' are shown, along with icons for a refresh, star, and print. The institution is listed as 'PSUNV PeopleSoft University'. A tree view shows a single leaf node: 'ALUMN_TMPL - (2008-09-15) - (In Progress)'. To the right, an 'Affiliation Details' panel is open, displaying the following information:

Affiliation Details	
Description	PSUNV Alumni
Start Date	09/15/2008
End Date	
Affiliation Status	ACT
Descriptor	Applied
Sponsoring Department	ADVANCEMNT

The leaf icons indicate the lowest level of an affiliation hierarchy (in the example above, *ALUMNI* is a single-level hierarchy). Branch icons indicate that the hierarchy level has children; those children have leaf icons. Click any hyperlink to view the associated affiliation details in a pop-up window on the page.

Reviewing Affiliation Data in a Chart View

Access the Chart View page (**Campus Community > Affiliations > View Person Affiliations > Chart View**).

This example illustrates the fields and controls on the Chart View page. You can find definitions for the fields and controls later on this page.

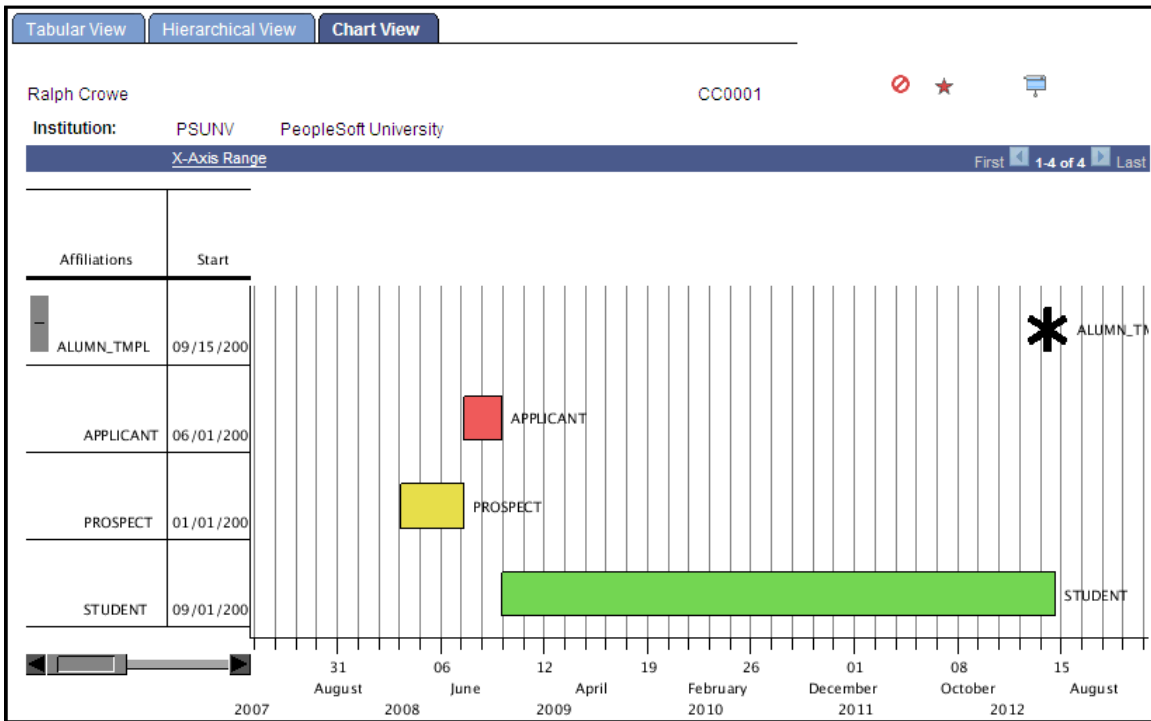

The Chart View is another way to view Person Affiliations in the system. Using a Gantt chart, you can graphically see overlaps in time for a person's affiliations with the institution.

Field or Control	Description
X-Axis Range	Click this link to change the date range displayed on the chart.

You may change how much of the table (left side of the page) and chart (right side of the page) are displayed by moving the vertical line separator between the table area and the chart area.

You may use the horizontal scroll bar at the bottom left of the page to scroll along the chart area horizontally.

Related Links

[Setting Up the Affiliations Gantt Chart](#)

Reviewing Affiliation Data Throughout the System

The Affiliation icon appears on all Campus Solutions biographic and demographic data pages. You can access it wherever you find service indicator icons.

This example illustrates the fields and controls on the Affiliation icon. You can find definitions for the fields and controls later on this page.



Click the icon to access the View Person Affiliation page, which displays all of the active affiliations assigned to that person. The icon appears on pages and subpages throughout Campus Community, as well as pages in other Campus Solutions features where you create and update person records (such as Admissions and Campus Self Service).

Viewing Affiliation Codes

This section discusses how to review affiliation code details.

Page Used to View Affiliation Codes

Page Name	Definition Name	Navigation	Usage
Affiliation Codes	SCC_VIEW_AFFL_CODE	Campus Community > Affiliations > View Affiliation Codes	Review all affiliation codes defined for an institution, in a tree view and interactive format.

Reviewing Affiliation Code Details











Access the Affiliation Codes page (**Campus Community > Affiliations > View Affiliation Codes**).

This example illustrates the fields and controls on the Affiliation Codes page. You can find definitions for the fields and controls later on this page.

Affiliation Codes

Institution: PeopleSoft University

Left | Right

<ul style="list-style-type: none">  RECRUITER  ALUMNI  ALUMNI  APPLICANT <ul style="list-style-type: none">  APP-GRAD  APP-UGRD  STUDENT <ul style="list-style-type: none">  STU-GRAD <ul style="list-style-type: none">  STU-GFAU  STU-UGRD <ul style="list-style-type: none">  STU-FAU 	<p>Description Fine Arts Undergraduate Student of PSUNV</p> <p>Effective Date 09/26/2007 Status Active</p> <p>Application Class SCC_AFFILIATIONS:IMPLEMENTATION:Student</p> <p>Sponsoring Department</p>
--	--

The leaf icons indicate the lowest level of an affiliation hierarchy (in the example above, *RECRUITER* is a single-level hierarchy). Branch icons indicate that the hierarchy has children; those children have leaf icons.

When you select an affiliation code leaf or branch at any level of the tree, the system expands the tree and displays a pop-up message that provides additional details about the code.

Viewing Affiliation Exceptions

This section discusses how to review and purge affiliation exception messages.

Page Used to View Affiliation Exceptions

<i>Page Name</i>	<i>Definition Name</i>	<i>Navigation</i>	<i>Usage</i>
View Affiliation Exception Messages	SCC_AFL_PRSN_MSGS	Campus Community > Affiliations > View Affiliation Exceptions	Review and purge affiliation exception message for constituents, based on a constituent ID or date range.

Viewing and Purging Affiliation Exception Messages

Access the View Affiliation Exception Messages page (**Campus Community > Affiliations > View Affiliation Exceptions**).

This example illustrates the fields and controls on the View Affiliation Exception Messages: Message Information tab. You can find definitions for the fields and controls later on this page.

View Affiliation Exception Messages

Search Criteria

Enter at least one search field to filter the Affiliation Exception Messages and click Search.

Institution PeopleSoft University

Affiliation Code

Emplid

From Date **To Date**

Personalize | Find | View All | First 1-5 of 5 Last
Affiliation Exception Messages

Message Information
Message Detail

Empl ID	Name	Affiliation Code	Description	Delete	
1	FA0800	Julia Wrench	PROF_TMPL	Start Date precedes date for existing affiliation - code PROF_TMPL, start date 2011-12-01, transaction date 2011-01-01. (14020,168)	<input type="button" value="Delete"/>
2	FA0802	Joel Kabahit	PROF_TMPL	Start Date precedes date for existing affiliation - code PROF_TMPL, start date 2011-12-01, transaction date 2011-01-01. (14020,168)	<input type="button" value="Delete"/>
3	FA0806	James Marcus	PROF_TMPL	Start Date precedes date for existing affiliation - code PROF_TMPL, start date 2011-12-01, transaction date 2011-11-19. (14020,168)	<input type="button" value="Delete"/>

The search functionality on this page enables you to view Affiliation framework exception messages from the SOA log within Campus Community. The *PeopleSoft Campus Solutions Affiliations Developer's Guide* provides details about the "As of Date" rules that the system follows when applying or ending an affiliation.

The following affiliation exception messages can appear on this page:

Message Catalog Text	Description
(14020, 158) Unable to create an affiliation for [constituent] as no data exists in context record.	An attempt is made to assign an affiliation with context data to a person, when no context values are available.
(14020,159) Constituent doesn't qualify for [affiliation code] and affiliation is not currently active, no action taken	Person does not meet the criteria for the affiliation code, and the affiliation code is not currently active, so no additional action will be taken.
(14020,160) Constituent doesn't qualify for [affiliation code], but it is currently set as active, end dating [affiliation code].	The constituent does not meet the criteria for the affiliation code, but the affiliation code is current set as active. The Affiliation framework will end date the affiliation code.

Message Catalog Text	Description
(14020,161) Constituent qualifies for [affiliation code] and has no active affiliation entry, assign [affiliation code].	The constituent meets the criteria for the affiliation code, and currently does not have the affiliation code set as active. The Affiliation framework will assign the affiliation code.
(14020,162) Constituent qualifies for [affiliation code] and has the affiliation assigned and status set to active, no action.	The constituent meets the criteria for the affiliation code and currently has the affiliation code set as active. The Affiliation framework will take no additional action.
(14020, 163) The [affiliation code] affiliation has been set manually and cannot be ended.	An attempt is made to end-date a manually assigned affiliation through an event trigger.

Click the **Delete** button to erase the message.

Select the **Message Detail** tab to see further information about the exception message.

Related Links

[Adding and Updating Affiliations](#)

Managing Biographical Information

Understanding Biographical Information

Personal information is personal data that distinguishes one individual from another. The most basic of this information is a person's biographical data, which includes name, address, gender, marital status, and date of birth.

When you manage many individuals in a database, you want to know and quickly access more than the basic information about them. With the personal information data pages, you can also enter and track an individual's various telephone numbers and addresses (street, email, and uniform resource locator [URL]), and you can maintain data about the individual's ethnicity, visa and permits, citizenship and passports, languages, relationships, religious preference, emergency contacts, and work experience.

You can enter and maintain different name types for an individual. With effective dating, you can also maintain and review the history of name changes for each type. For example, when the divorced Mrs. Edith Jones advises your institution that she has remarried and changed her last name to Bramowitz, you can maintain her preferred name, Edith Bramowitz; her former name, Edith Jones; and her maiden name, Edith Brown. Departments that need to know when these name changes occurred can determine that by reviewing the history of each name type.

You can also enter and maintain different address types for an individual. For example, you might want to enter an individual's home, business, mailing, and permanent address. You can update these addresses as needed and maintain the address change history. In addition to traditional addresses, many individuals have at least one email or web address and several telephone numbers. You can enter and review electronic addresses and phone numbers in your system. After you enter addresses data, you can run processes to apply or remove seasonal addresses, update linked addresses, and search for a specific address for an individual.

Use the pages described in this documentation to report personal attributes, including the ethnicity of students, staff, and constituents in your campus community. The United States government requires that students must be placed in at least one of a limited number of ethnic groups.

You can identify the reciprocal individual relationships that your institution wants to track. Reciprocal relationships include spouses, mother and daughter or mother and son, brother and brother or brother and sister, employer and employee, and so on.

You can use reciprocal relationships to associate an individual in your database with another individual inside or outside of your database. When you associate two individuals, you can set up joint communications for them and maintain one joint address to which to send the joint communication. For example, you can set up a joint communication addressed to Mr. and Mrs. Smith.

You can set the system to automatically verify the marital status that you enter on the Biographical Details Data page against the relationship that you select on the Relationships page. To set automatic marital status verification, select the marital status and associated relationship on the Relationship/Marital Status page that you want the system to verify. If the verification determines that the marital status of either individual is not the specified status for that relationship, a warning message appears, suggesting

that you update the marital status on the Biographical Details page. For example, if you set the marital status of *Married* and the relationship of *Spouse* on the Relationships/Marital Status page, when you select the relationship of *Spouse* on the Relationships page, the system verifies that the marital status of each individual on the Biographical Details page is *Married*. If the marital status of either individual is different from *Married*, the system displays the warning message.

Note: Some default values for relationships are set on the Installation Defaults - Campus Community page including reciprocal relationships. When the Create Reciprocal Relationship check box is selected on the Installation Default - CC page, the system automatically updates the relationship record for both IDs when you enter and save information on pages in the Relationship component.

You can track which languages an individual can read, speak, or write and to what degree of proficiency. You can also identify the religious preference, if any, reported by an individual and track the religious preferences of your overall campus community. You can also set preferences for the language and method by which an individual wants to receive communications from your institution.

You can enter the names, addresses, and telephone numbers of people to contact when an individual has an emergency situation. You can enter as many contacts and as many phone numbers for each contact as the individual provides or as your institution requires.

You can use U.S. Standard Industry Classification (SIC) and Standard Occupational Classification (SOC) codes to identify and track data about an individual's work experience, including the name of the individual's former employer, employment begin and end dates, and the most current rate of pay.

You can enter or update most basic biographical data about an individual on the Biographical Details page when you create the personal record, or you can access pages described in this section to edit or update specific information. When you save information on the pages described in this section, the system writes it to the relevant maintenance tables and updates the same information on other pages where it appears, including the Biographical Details page.

When you license PeopleSoft Campus Self Service, you can also present basic biographical information to students and faculty so that they can view and update their own information, which minimizes the need for your staff to enter and maintain the data.

Related Links

[Adding an Individual to Your Database](#)

“Displaying and Accessing Self-Service Personal Data” (Campus Self Service)

Prerequisites for Managing Biographical Information

Before entering or updating basic biographical data, you must design and set up names, addresses, and other foundational elements of Campus Community. You must also set up basic elements for personal data management.

Related Links

[Designing Campus Community](#)

[Setting Up Emergency Contacts Data](#)

Managing Names Data

This section discusses how to:

- Enter name types for an individual.
- Add long names.
- View name history.
- (NLD) Enter the name to report for GBA.

Pages Used to Manage Names Data

<i>Page Name</i>	<i>Definition Name</i>	<i>Navigation</i>	<i>Usage</i>
Names	SCC_NAMES_89	<ul style="list-style-type: none"> • Campus Community > Personal Information > Biographical > Names • Campus Community > Personal Information (Student) > Biographical (Student) > Names • Student Recruiting > Student Recruiters > Personal Information > Names • Student Admissions > Application Entry > Personal Information > Names • Student Recruiting > Maintain Prospects > Personal Information > Names 	View or create name types and data for an individual.
Manage Long Name	SCC_LONG_NAMES	Click the Manage Long Name link on the Names page.	Add name parts that are longer than the standard name fields.
Name Type History	SCC_NAME_HIST_SEC	Click the Name History link for a name type on an individual's Names page.	View the history of an individual's name type and update or add a new effective date for that name type.

Page Name	Definition Name	Navigation	Usage
Names (NLD)	SSR_NAMES_NLD	<ul style="list-style-type: none"> • Personal Information NLD > Student GBA Names NLD • Click GBA Reporting Names in the Netherlands section of the Regional page in the Biographical Details component. 	Enter an individual's name to report for GBA.

Entering Name Types for an Individual

Access the Names page (**Campus Community > Personal Information > Biographical > Names**).

This example illustrates the fields and controls on the Names page. You can find definitions for the fields and controls later on this page.

Names
Toby S GAETP009

Current Names Personalize | Find | View All | | First 1 of 1 Last

Name Type	Name	Effective Date	Status	Updated By	Updated	Name History
Primary	Toby S	01/01/2000	Active	Betty Locherty	05/09/2013 5:49:00AM	Name History

Add/change a name

Type of Name

Effective Date Status

*Format Using English [Change Format](#)

Prefix

*First Name

Middle Name

*Last Name

Suffix

Preferred First Name

Display Name

Formal Name

Name

Warning! You must click **Submit** to submit data that you enter on the Names page *before* you save the page. Saving the page without first submitting the data will clear the fields for which you entered values and data will be lost.

Current Names

<i>Field or Control</i>	<i>Description</i>
Name Type	<p>Displays the individual's current name types as links.</p> <p>Click the link to view or update data for an existing name type. The system displays the associated data in the relevant fields.</p> <p>The system displays the name format with the name fields previously entered for this name type and the Display Name, Formal Name, and Name fields at the bottom of the page, where you can add a new past or future effective-dated row for the name type.</p>
Name	Displays the individual's name as it appears in the default display name format for the selected name type.
Name History	<p>Click to access the Name Type History page, on which you can view the history of the name type.</p> <p>To update the current name type for the individual, click the Name History link, add a new name row, specify the effective date and name format, and edit the related name fields.</p>

Add/change a name

Use this area of the page to add or edit name information for the **Name Type** link that you selected at the top of the page.

<i>Field or Control</i>	<i>Description</i>
Type of Name	<p>Select the type of name, such as <i>Primary</i>, <i>Preferred</i>, <i>Legal</i>, or <i>Maiden</i>, to add or update for this individual.</p> <p>Values for this field are set up on the Name Type Table page.</p>
Manage Long Name	<p>After you select a Type of Name, this link becomes available. Click to add additional long name fields on the Long Names page.</p>
Format Using	<p>Displays the name format currently used for this name type.</p> <p>For new names, this field considers the default value defined in the user's primary permission list. If a default value isn't defined in Org Defaults by Permission Lst, this field is set to English.</p>

Field or Control	Description
Change Format	Click to select a different name format to use. Editable fields appear based on the format that you select.
Display Name, Formal Name, and Name	Displays the name formats to use throughout the system. Display Name is the format to use in the heading of person pages. Formal Name can be used for correspondence and reporting. Name is the name displayed in search results and typically includes last name before first name.
	Click to update the display name formats to reflect any changes made in any of the name fields.
Submit	Click to submit data <i>before</i> saving the page. Submitting the data changes the data in the Current Names area so that you can view the changes, and clears all fields in the Add/change a name area . To save the changes to the database, you must click Save .
Reset	Click to clear all fields in the Add/change a Name area, which enables you to re-enter field values.

Adding Long Names

Access the Manage Long Name page (click the **Manage Long Name** link on the Names page).

The fields on this page are not considered in searches. They are available for reporting and inclusion in queries by selecting from the SCC_LONG_NAMES record.

Viewing Name History

Access the Name Type History page (click the **Name History** link for a name type on an individual's Names page).

The system displays the history of the selected name type. You can view or add data as permitted by the mode (add, update/display, include history, or correct history) that you select.

(NLD) Entering the Name to Report for GBA

Access the Names page (**Personal Information NLD > Student GBA Names NLD**).

Enter the individual's name to report for GBA.

Managing Addresses and Phone Data

This section provides an overview of managing addresses, lists prerequisites, and discusses how to:

- Enter addresses for an individual.
- Link addresses.
- Enter electronic address data.
- Enter seasonal addresses.
- Process seasonal addresses.
- Update linked addresses.
- Search for addresses.
- Enter phone data.

Understanding Address Management

Some of your faculty or constituents might routinely relocate and work from a different address. For example, a student might go to his family's ski lodge every winter break or a staff member might volunteer out of state each summer. Using the Seasonal Addresses feature, you can track temporary addresses to stay in contact with individuals while they are away. You enter the individual's seasonal address data with the appropriate begin and end dates. Then you run the seasonal addresses process to apply or remove the address, based on the begin and end dates. You can run the process to apply the seasonal address for a specific individual or you can run it to apply or remove all seasonal addresses between certain start and end dates.

When you update an address for a campus location or organization, the campus location or organization address for individuals linked to that location or organization are not changed in your database until you run the Update Linked Addresses process. When you run the process, the system locates all the individuals with whom that campus location or organization is linked and updates the changed address there as well. For example, when you change an organization's address and run the Update Linked Addresses process, the system locates each of the individuals who are linked to that organization and changes the organization's address.

You can search for addresses for individuals. You can search on address usage, email type, or address type. For example, if you want to send an email message to an individual at his dorm, you can search on the email type of *Dormitory*. If you need to send a billing notice, you can search on the address type of *Billing* or search on the address usage of *Billing*. However, if no address type of *Billing* exists for the individual, you will get no results. If your institution has assigned address usages, use one of the address usage search orders (in this case, Billing, Mailing, Home, Permanent) to have the system search for and find the first appropriate address.

Note: The system searches only on active addresses.

You can view a list of all addresses in your system for an individual, which includes all address types that have been entered for the individual. It also includes the individual's current addresses, any previous addresses that are now inactive, and any addresses that are set to become active in the future.

Prerequisites

Before managing seasonal or linked addresses or before searching for addresses in your system, enter addresses and address types for the individual.

Related Links

[Entering Addresses for an Individual](#)

[Entering Electronic Address Data](#)

Pages Used to Manage Addresses

<i>Page Name</i>	<i>Definition Name</i>	<i>Navigation</i>	<i>Usage</i>
Addresses	SCC_BIO_DEMO_ADDR	<ul style="list-style-type: none"> • Campus Community > Personal Information > Biographical > Addresses/Phones > Addresses • Contributor Relations > Constituent Information > People > Biographic Information > Addresses 	Enter or review an individual's address types and data.
Address History	SCC_ADDR_HIST_SEC	Click the Edit/View Address Detail link for an address type in the Current Addresses area of the Addresses page.	View the history of a specific address type for an individual.
Edit Address	EO_ADDR_XXX_SEC (where XXX = the country code)	<ul style="list-style-type: none"> • Click the Edit Address link on the Addresses page or the Seasonal Addresses page. • Click the Update Addresses link on the Address History page. 	<p>If you access the Edit Address page by clicking Edit Address, enter address data for the specified address type.</p> <p>If you access the Edit Address page by clicking Update Addresses, edit or update any address data associated with the individual.</p>

Page Name	Definition Name	Navigation	Usage
Electronic Addresses	E_ADDR_PERS	<ul style="list-style-type: none"> • Campus Community > Personal Information > Biographical > Addresses > Electronic Addresses • Contributor Relations > Constituent Information > People > Biographic Information > Electronic Addresses • Student Recruiting > Student Recruiters > Personal Information > Electronic Addresses • Student Admissions > Application Entry > Personal Information > Electronic Addresses 	Enter or review an individual's email address and URL data.
Seasonal Address	CC_ADDR_SEASONAL	Campus Community > Personal Information > Biographical > Addresses > Seasonal Address	Enter a seasonal address for an individual.
Process Seasonal Addresses	RUNCTL_SEASNL_ADDR	Campus Community > Personal Information > Biodemo Processes > Apply Seasonal Addresses	Run the process to apply or remove the designation of <i>Seasonal Address</i> to specified addresses in the Current Addresses area of the Addresses and Address History pages.
Address Linkage	SCC_ADDRSA_LNK_SEC	Click the Address Linkage link in the Edit Address area of the Addresses page or the Address History page.	Link an address type to the location of a campus or an organization.
Update Linked Addresses	RUNCTL_CCADDLINK	Campus Community > Biodemo Processes > Update Linked Addresses	Run the process to update linked addresses throughout your system.

<i>Page Name</i>	<i>Definition Name</i>	<i>Navigation</i>	<i>Usage</i>
Address Search	ADDRESS_SRCH	<ul style="list-style-type: none"> • Campus Community > Personal Information > Address Search • Contributor Relation, Constituent Information, People, Biographic Information, View Addresses 	Search for a specific address for an individual.
Phone Numbers	PHONE_PERS	Campus Community > Personal Information > Biographical > Addresses > Phones	Enter or review an individual's telephone numbers.

Entering Addresses for an Individual

Access the Addresses page (**Campus Community** > **Personal Information** > **Biographical** > **Addresses/Phones** > **Addresses**).

This example illustrates the fields and controls on the Addresses page. You can find definitions for the fields and controls later on this page.

Addresses

Ralph Crowe CC0001

Current Addresses				
Address Type	Address	Effective Date	Status	Edit/View Address Detail
Home	123 Campus Street Los Angeles, CA 94588	10/29/2004	Active	Edit/View Address Detail
Dormitory	123 Campus Street Los Angeles, CA 94588	10/29/2004	Active	Edit/View Address Detail

Add Address	Add Address Types
Effective Date: <input type="text" value="10/29/2004"/> Status: <input type="text" value="Active"/>	<input type="checkbox"/> * Home <input type="checkbox"/> Mailing <input type="checkbox"/> Business <input type="checkbox"/> Check <input type="checkbox"/> * Dormitory <input type="checkbox"/> Legal <input type="checkbox"/> * Campus <input type="checkbox"/> Other <input type="checkbox"/> Billing <input type="checkbox"/> Other 2 <input type="checkbox"/> Permanent <input type="checkbox"/> Preferred <input type="checkbox"/> Veteran
Country: <input type="text" value="USA"/> United States	
Address: Edit Address Address Linkage	
<input type="button" value="Submit"/> <input type="button" value="Reset"/>	<p style="color: blue; font-weight: bold;">* Active address exists</p> <p style="color: blue;">Explain</p>

Information that you enter here is the same as the address data that you enter on the Biographical Details page when you create a personal record. When you save the data (either there or here), the system updates the address data in both places.

See [Adding or Updating Biographical Details Data](#).

Current Addresses

If the individual has current addresses in the database, this area of the page shows the current address types and the associated data. If the individual does not have a current address, the text *No current addresses exist* appears instead.

Field or Control	Description
Address Type	<p>Displays the individual's current address types as links.</p> <p>Click the link to view or update data for the address type. The system displays values for the current address in the relevant fields. Displaying the address data enables you to copy it from one address type to another.</p>
Edit/View Address Detail	<p>Click to access the Address History page, on which you can view the history of the address type.</p> <p>To update the current address type for the individual, click the Edit/View Address Detail link, add a new address row, specify the effective date and address format, and edit the related fields.</p>

Add Address

Field or Control	Description
Effective Date	<p>Enter the date on which the address is active.</p> <p>Enter addresses in the chronological order of their effective dates. Enter the earliest dated address first and the future-most dated address last.</p> <p>See “Understanding Installation Setup and System Defaults” (Campus Solutions Application Fundamentals).</p>
Country	<p>Enter the country code for the address format to use for the individual. The system displays the fields required for that country as defined on the Country Table - Address Format page.</p>
Edit Address	<p>Click to access the Edit Address page, on which you can enter new address data in the specified format.</p>
Address Linkage	<p>Click to access the Address Linkage page, on which you can link an address type to a campus location or organization location.</p>

Add Address Types

A particular address often applies to more than one address type for an individual. For example, an individual's dormitory, campus, and billing addresses might be the same.

To copy the address, effective date, and status from one address type to other address types, select the address types to which to assign the data, click **Submit**, and then click **Save**.

Field or Control	Description
Address Type	<p>Click the current address type such as <i>Dormitory</i>, <i>Campus</i> or <i>Billing</i>, to copy. The system displays the associated address data beneath the Edit Address link in the Add Address area of the page.</p> <p>To make changes to the data, click Edit address and make the changes.</p> <p>A blue asterisk to the left of an address type indicates that the address type exists and that it has a current or future-dated address with a status of <i>Active</i>. Be sure that you want to add a new effective-dated row to the existing data before selecting the address type.</p>
Explain	<p>Click to display an explanation of the marks that indicate the successful or unsuccessful creation of an address type.</p> <hr/> <p>Note: A green check mark indicates the successful creation of an address type. A red X appears if you try to create an address type that causes effective dates to become out of sync for a specific address type. For example, a red X appears if the address type that you are adding already has an existing duplicate effective date, or when an earlier effective-dated address currently exists for the address type.</p> <hr/>
Submit	<p>To copy the address data to each of the selected address types, click Submit.</p> <p>A green check mark appears next to each address type to which the data is successfully copied and the new or updated addresses appear in the Current Address area of the page. The addresses are not written to the Addresses Table until you click Save.</p> <hr/> <p>Note: When you create multiple address types from one source address, you can have a mixture of successful and unsuccessful outcomes (green check mark or red X respectively). The data only from successful outcomes appear in the Current Address area.</p> <hr/>
Edit/View Address Detail	<p>Click to access the Address History page, on which you can change the effective date and status for any newly submitted address and address type before you save it. You can also add a new effective-dated row for the selected address type.</p>

<i>Field or Control</i>	<i>Description</i>
Reset	Click to clear address information in the Add Address and Add Address Type areas. Doing so enables you to enter different data, either manually or by clicking the Address Type link to copy address data from a current address.

Linking Addresses

Access the Address Linkage page (click the **Edit/View Address Detail** link for an address type in the Current Addresses area of the Addresses page).

This example illustrates the fields and controls on the Address Linkage page. You can find definitions for the fields and controls later on this page.

Address Linkage

Organization

Org ID: Jordan High School
Location: School Office
Contact:
Org Name:
Org Location:
Contact Name: [Reset Organization Link](#)

Location

Location Address:
Type:
Data:
Print Line: [Reset Location Link](#)

Maintain Manually

Maintain Address Manually **Maintain Other Data Manually**

This page enables you to specify the addresses to link. It also enables you to set linked data to manual maintenance so that the Update Linked Addresses process (or any other automatic update process) will bypass the information.

Organization

Enter information to identify the organization address to which you want to link.

Location

Enter information to identify the location address to which you want to link.

Field or Control	Description
Location Address and Type	Enter the location address and specify the address type to which to link.
Data and Print Line	Enter address data to print for this location and specify on which address line to print it.

Maintain Manually

Field or Control	Description
Maintain Address Manually	Select to maintain the address manually and have the system bypass it in the update linked addresses process or other automatic update processes.
Maintain Other Data Manually	Select to maintain other data (from Location or Organization page areas) manually and have the system bypass it in the update linked addresses process or other automatic update processes.

Entering Electronic Address Data

Access the Electronic Addresses page (**Campus Community > Personal Information > Biographical > Addresses > Electronic Addresses**).

Information that you enter here is the same as the email address data that you enter from the Biographical Details page when you create a personal record. When you save data here, the system updates the same email address data on the Biographical Details page.

See [Adding an Individual to Your Database](#).

Email Information

Field or Control	Description
Email Type	Select the type, such as <i>Home</i> , <i>Business</i> , or <i>Mailing</i> , that describes this email address. Values for this field are delivered with your system as translate values. You can modify these translate values.
Email Address	Enter the individual's email address.

<i>Field or Control</i>	<i>Description</i>
Preferred	<p>Select to indicate the individual's preferred email address, which is the one to use first when contacting this individual. You may select only one preferred email address for an individual.</p> <p>For information about preferred email for Notifications, see Managing Personal Attributes Information, "Entering Notification Preferences."</p>

URL Information

<i>Field or Control</i>	<i>Description</i>
Type	Select the type (such as <i>Home</i> , <i>Business</i> , or <i>Mailing</i>) that describes this electronic address or URL.
URL Address	Enter the individual's URL or home page address.

Entering Seasonal Addresses

Access the Seasonal Addresses page (**Campus Community > Personal Information > Biographical > Addresses > Seasonal Address**).

<i>Field or Control</i>	<i>Description</i>
Address Type	<p>Select the type of address that is seasonal for this individual. Only the address types for which the individual has data are available.</p> <hr/> <p>Note: If the main address data for the address type of this seasonal address is removed, an error message is shown similar to "Business Seasonal Address is invalid - no Active Business Address on file. Seasonal Addresses may only be added for active address types." You can recreate the main address information for this address type, select a different address type for the seasonal address, or remove it.</p> <hr/>
Start Date	Indicate the date when the seasonal address begins to apply.
End Date	<p>Indicate the date when the seasonal address ceases to apply. When the end date occurs, the system automatically increases the start and end dates by one year and resets the address for the next year.</p>

<i>Field or Control</i>	<i>Description</i>
Country	Enter the country formatting to use for this address. When you exit the Country field, the address fields appear in the format for the selected country as defined on the country Address Format page.

Processing Seasonal Addresses

Access the Process Seasonal Addresses page (**Campus Community > Personal Information > Biodemo Processes > Apply Seasonal Addresses**).

<i>Field or Control</i>	<i>Description</i>
Select One ID	Select this check box to apply or remove seasonal addresses for one individual only. You must specify the individual's ID in the ID field. If you do not choose <i>Select One ID</i> , the system applies or removes seasonal addresses for all IDs for which seasonal address data exists.
Use Start Date Range	Select this check box to indicate that all seasonal addresses beginning within the specified date range should be applied or removed.
Use End Date Range	Select this check box to indicate that all seasonal addresses ending within the specified date range should be applied or removed.

Note: You must enter either a start date range, an end date range, or both. If the individual has multiple seasonal addresses, consider specifying a date range long enough to include all of them in the search. If you specify only one date in a range, the system limits the search to seasonal addresses that begin or end, respectively, on that specific date.

Updating Linked Addresses

Access the Update Linked Addresses page (**Campus Community > Biodemo Processes > Update Linked Addresses**).

<i>Field or Control</i>	<i>Description</i>
Location Link	Select this check box to indicate that the process should update all addresses linked to locations.

Field or Control	Description
Organization Link	Select this check box to indicate that the process should update all addresses linked to organizations.

Searching for Addresses

Access the Address Search page (**Campus Community > Personal Information > Address Search**).

Selection Criteria

Field or Control	Description
ID	Enter the ID of the individual whose address you want to find.
Usage	Enter the type of address usage or search order for the system to use in the search. All address usages on the Address Usage page are available.
Email Type	Enter the type of email address, if any, for which the system should search, such as <i>Home</i> , <i>Dorm</i> , or <i>Business</i> . Only the existing email types for this individual are available. If no email data exists for the individual, no email types are available.
Address Type	Enter the type of street address for which the system should search, such as <i>Home</i> , <i>Dorm</i> , or <i>Business</i> . All address types are available. If no data of that type exists for the individual, no results are returned.
Search	Click to launch the search.

Address Data

The system displays the search results in this area.

Field or Control	Description
Update Addresses	Click this link to access the Addresses page on which you can edit or update any address data associated with the individual.

Entering Phone Data

Access the Phone Numbers page (**Campus Community > Personal Information > Biographical > Addresses > Phones**).

Note: Information that you enter here is the same as the phone number data you enter on the Phone Detail page. When you save data here, the system updates the same phone number data on the Phone Detail page.

<i>Field or Control</i>	<i>Description</i>
Phone Type	Select the type, such as <i>Home</i> , <i>Business</i> , or <i>Mailing</i>) that describes this telephone number. Values for this field are delivered with your system as translate values. You can modify these translate values.
Phone Number	Enter the telephone number, including area code, for this individual.
Extension	Enter the individual's direct extension, if any.
Country Code	Enter the country code, if required to complete the call.
Preferred	Select to indicate that this is the individual's preferred phone number, and the one to use first when contacting this individual. You can select only one preferred phone number for an individual. For information about preferred phone for Notifications, see Managing Personal Attributes Information , "Entering Notification Preferences."

Managing Personal Attributes Information

Important! Letter Generation (Letter Gen) is a deprecated product. It is strongly recommended that you use Communication Generation (Comm Gen) instead. For more information on Comm Gen, see [Understanding the Communication Generation Process](#)

This section provides an overview of the personal attribute deceased label, lists prerequisites, and discusses how to:

- Enter ethnicity information.
- Process ethnicity information updates.
- Enter languages information.
- Enter communication preferences.

- Enter notification preferences.
- Enter religious preferences.
- Enter date of death and other decedent data.
- (AUS) Enter student data.

Understanding the Personal Attribute Deceased Label

When an individual dies, you should apply the deceased label to all pages about that individual. Then, when users encounter a page with the word *DECEASED* at the top, they can determine whether to continue or suspend their transactions for that individual.

You can apply the label using either of the following methods. In both methods, when you save the individual's page, the system displays the word *DECEASED* at the top of the pages.

- To display the deceased label and not enter any other decedent data (for example, place of death and death certificate number), assign your institution's deceased service indicator to the decedent.

The service indicator sets the deceased label to display. You can use this method regardless of whether you know the individual's date of death.

- If you know the individual's date of death, you can enter that date on the Decedent Data page along with other decedent data, and then save the page.

You can use this method to apply the deceased label *only* if you know the date of death.

For example, you might receive confirmation that Gloria is deceased. You want to apply the deceased label to all pages about her as soon as possible to alert users. However, you have not received a copy of the death certificate or official confirmation of her date of death. Because you do not know when she died, you could assign her your institution's deceased service indicator, which is the one that is set to display the deceased label.

You can verify that the label is applied by accessing any page about the decedent. The word *DECEASED* appears at the top right of the page.

All of the decedent's data remains in your database until your system administrator deletes the decedent's ID.

Related Links

[Setting Up Service Impacts](#)

[Deleting Individual IDs](#)

Prerequisites

Before you can enter personal attributes data, you must define language codes, and religious preferences codes in your system. Before you can apply and manage FERPA privacy control, you must establish FERPA privacy control fields. Before you can allow students to identify publications for which they release FERPA privacy restrictions, you must set up your institution's publications.

Related Links

[Setting Up Personal Attributes](#)

Pages Used to Manage Personal Attributes Information

<i>Page Name</i>	<i>Definition Name</i>	<i>Navigation</i>	<i>Usage</i>
Ethnicity	ETHNICITY_DETAIL	Campus Community > Personal Information > Biographical > Personal Attributes > Ethnicity	Enter or review an individual's ethnicity data.
Ethnicity Detail Update	SCC_ETH_UPDATE	Campus Community > Personal Information > Biodemo Processes > Ethnicity Detail Update	Process ethnicity-related updates to person records in batch.
Languages	SCC_LANGUAGES	<ul style="list-style-type: none"> • Campus Community > Personal Information > Biographical > Personal Attributes > Languages • Student Recruiting > Student Recruiters > Personal Information > Languages • Student Recruiting > Maintain Prospects > Personal Information > Languages • Student Admissions > Application Entry > Personal Information > Languages 	Enter and track an individual's language abilities.
Communication Preferences	SCC_COMM_PREF	Campus Community > Personal Information > Biographical > Personal Attributes > Communication Preferences	Enter an individual's preferred language and method for receiving communications (applies to communication generated by Comm Gen only).

Page Name	Definition Name	Navigation	Usage
Notification Preferences	SCC_NTF_PREF	<ul style="list-style-type: none"> • Campus Community > Personal Information > Biographical > Personal Attributes > Notification Preferences • Campus Community > Personal Information (Student) > Biographical (Student) > Personal Attributes > Notification Preferences 	Enter an individual's notification preferences.
Religious Preferences	RELIGIOUS_PREF	<ul style="list-style-type: none"> • Campus Community > Personal Information > Biographical > Personal Attributes > Religious Preferences • Contributor Relations > Constituent Information > People > Personal Attributes > Religious Preference 	Enter data to identify an individual's religious preference.
Decedent Data	SA_DECEASED_DATA	<ul style="list-style-type: none"> • Campus Community > Personal Information > Biographical > Personal Attributes > Decedent Data • Contributor Relations > Constituent Information > People > Personal Attributes > Decedent Data 	Enter the date of death and other data about the decedent.
Student Data AUS	SSR_STDN_DATA_DEST	Campus Community > Personal Information (Student) > Biographical (Student) > Personal Attributes > Student Data AUS > Student Data AUS	Enter DEST information regarding a student's prior programs, including values related to TAFE, secondary school, and postgraduate programs.

Entering Ethnicity Information

Access the Ethnicity page (**Campus Community > Personal Information > Biographical > Personal Attributes > Ethnicity**).

This example illustrates the fields and controls on the Ethnicity page. You can find definitions for the fields and controls later on this page.

Ethnicity

Ralph Crowe CC0001

Person is Hispanic or Latino If Yes, select Ethnic Group

Ethnicity								
Customize Find First ◀ 1-2 of 2 ▶ Last								
*Regulatory Region	*Ethnic Group	Description	Ethnic Category	Primary	IPEDS	Percentage	Updated on	Updated By
USA	ESKIMO	Eskimo	Am. Indian	<input checked="" type="checkbox"/>	<input type="checkbox"/>	50		
USA	WHITE	White	White	<input type="checkbox"/>	<input type="checkbox"/>	50		

Add

Record Last Updated **Record Last Updated By**

For institutions with *USA* as an installed country, the following fields appear for editing:

Field or Control	Description
Person is Hispanic or Latino	<p>Select this check box to indicate whether the person is of Hispanic or Latino origin.</p> <p>For further information on guidelines for defining if person is Hispanic or Latino, see http://nces.ed.gov/statprog/2002/std1_5.asp.</p> <hr/> <p>Note: You must select this check box if a row exists in the grid that indicates Hispanic origin.</p> <hr/>

Field or Control	Description
If yes, Select Ethnic Group	<p>If you selected the Person is Hispanic or Latino check box, then select an ethnic group code to further refine the person's ethnicity. When you select a value, row changes occur as follows:</p> <ul style="list-style-type: none"> • If no value exists in the drop-down list and you select a value that does not currently exist on the record, the system inserts a new row into the grid. • If a value exists in the drop-down and that value exists in the grid, when you select a new value from the drop-down, the system updates the existing row. • If a value exists in the drop-down and blank is selected from the drop-down, nothing affects existing rows. • If the drop-down value is blank and you select a value that already exists in the grid, nothing happens to the existing rows.
Primary	Select this check box to indicate with which ethnic group the person most directly identifies.
IPEDS	Select this check box to indicate that the data has been submitted by a reliable source, such as application data or self service, in response to the IPEDS questions.

The following fields appear for all customers:

Field or Control	Description
Ethnic Group	<p>This field allows you to select multiple ethnic backgrounds.</p> <p>Click the Add button to add more than one ethnic group.</p>

Field or Control	Description
Ethnic Category	<p>The system populates this field based on the value in the EEO Ethnic Group field for U.S. regulatory region ethnic groups or the Ethnic Category for ethnic groups tracked for other regulatory regions.</p> <p>For any ethnic group codes with a regulatory region of USA, this field should always map to one of these five races:</p> <ul style="list-style-type: none"> • American Indian or Alaska Native. • Asian. • Black or African American. • Native Hawaiian or Other Pacific Islander. • White. <p>For further information on guidelines for mapping ethnic group codes to the five races, see http://nces.ed.gov/statprog/2002/std1_5.asp.</p> <p>See Defining Ethnic Groups.</p>
Percentage	<p>Indicate the share of 100 of which this person derives his or her ethnicity. The system displays a warning if you enter an amount over 100.</p> <hr/> <p>Note: Collecting this information is optional.</p> <hr/>
Last Updated, Updated By	<p>Indicates when the ethnicity data was last created or changed, and by whom. The system updates these fields when you save the page. The system stores the OPRID of the user and displays the name of the user.</p>
Record Last Updated	<p>This field displays the date and time of the most recently added row in the grid.</p>
Record Last Updated By	<p>This field displays the name of the last user to update any row of the grid.</p>

Processing Ethnicity Information Updates

Access the Ethnicity Detail update page (**Campus Community > Personal Information > Biodemo Processes > Ethnicity Detail Update**).

If your institution chooses not to resurvey your population, you can use the check boxes on this page to update ethnicity record attributes in batch. Select any combination of the four check boxes.

Field or Control	Description
Sync Ethnic Details	<p>Select this check box to instruct the system to search for all rows in the DIVERS_ETHNIC table without a corresponding row in ETHNICITY_DTL and add a row, if one does not exist.</p> <p>Select this check box to instruct the system to search for all rows in ETHNICITY_DTL without a corresponding row in DIVERS_ETHNIC and delete them.</p>
Set IPEDS Flag	Select this check box to instruct the system to set the ETHNICITY_DTL.ETH_VALIDATED flag on ethnicity records to "Y", meaning that your institution considers the records valid for IPEDS requirements. The system also updates corresponding audit fields on the record.
Set Hispanic/Latino Flag	Select this check box to instruct the system to search for all DIVERS_ETHNIC rows with an EEO Ethnic Category = 3 'Hispanic' that are not set to "HISP_LATINO = Y", and set them to "Y." The system also updates corresponding audit fields on the record.
Update Percentages	Select this check box to instruct the system to search ETHNICITY_DTL records for fractional ethnicity data (such as 2/5) and convert it to a percentage (such as 40%) or to convert zero percentages to a Numerator = 0 and a Denominator = 100. The system also updates corresponding audit fields on the record.

Click the **Run** button to initiate the process. Review the results log within Process Scheduler that identifies which option was run and how many records were updated.

Entering Languages Information

Access the Languages page (**Student Recruiting > Student Recruiters > Personal Information > Languages**).

Field or Control	Description
Language Code	Enter the language that this individual speaks, reads, or writes.
Native	Select this check box to indicate that this is the individual's native or primary language.
Translator	Select this check box to indicate that the individual can translate or interpret this language.
Teacher	Select this check box to indicate that the individual can teach or has taught this language.

Field or Control	Description
Speak	Select the level of proficiency, such as high, medium, or low, with which the individual can speak this language.
Read	Select the level of proficiency, such as high, medium, or low, with which the individual can read this language.
Write	Select the level of proficiency, such as high, medium, or low, with which the individual can write this language.
Evaluation Date	Enter the date on which the individual's levels of proficiency in this language were evaluated, reported, or entered.
Set Preferred Communication Language	<p>Appears only if the Support multiple languages check box is selected on the Installation Default - CC (installation default - Campus Community) page.</p> <p>Click to transfer to the Communication Preferences page where you can specify the language in which the student prefers to receive communications from you.</p> <p>See Reviewing or Defining Campus Community Installation Settings.</p>

Entering Communication Preferences

Access the Communication Preferences page (**Campus Community > Personal Information > Biographical > Personal Attributes > Communication Preferences**).

If your institution supports multiple languages and multiple methods, you can enter an individual's communication preferences so that the Communication Generation process will produce correspondences to that individual accordingly.

Note: Communication preferences apply to the Communication Generation process only. They do not apply to the Letter Generation process.

Field or Control	Description
Preferred Language	<p>Enter the language in which the individual prefers to receive communications from your institution.</p> <p>Only the languages that your institution supports and selects on the Installation Default - CC (installation default Campus Community) page are available.</p>

<i>Field or Control</i>	<i>Description</i>
Preferred Communication Method	<p>Enter the method by which the individual prefers to receive correspondence from your institution.</p> <p>Only the methods that your institution supports and selects on the Installation Default - CC (installation default Campus Community) page are available.</p> <hr/> <p>Note: Currently, the Communication Generation process supports only the methods of <i>Email</i> and <i>Letter</i>.</p>

Entering Notification Preferences

Access the Notification Preferences page (**Campus Community > Personal Information > Biographical > Personal Attributes > Notification Preferences**).

For information about the Notifications Framework, see [Understanding the Notifications Framework](#).

<i>Field or Control</i>	<i>Description</i>
Enable SMS Notification and Enable Email Notification	<p>Enable notifications and then select the preferred phone/email type.</p> <hr/> <p>Note: The specified phone number must be able to receive SMS or text messages.</p> <hr/> <p>If phone or email details do not exist for the person, use the links to access the Phone Numbers page or Electronic Addresses page and add them.</p>

If the preferences on this page differ from those on the Phone Numbers and Electronic Addresses pages, the preferences selected here are always used for notifications (except when overridden on Notification setup).

See [Configuring Notification Handlers](#)

Entering Religious Preferences

Access the Religious Preference page (**Campus Community > Personal Information > Biographical > Personal Attributes > Religious Preferences**).

<i>Field or Control</i>	<i>Description</i>
Religious Preference	Select the individual's stated religious preference.

Related Links

[Defining Religious Preference Codes](#)

Entering Date of Death and Other Decedent Data

Access the Decedent Data page (**Campus Community > Personal Information > Biographical > Personal Attributes > Decedent Data**).

Note: Only the date of death is required to display the deceased label for the individual throughout your system.

<i>Field or Control</i>	<i>Description</i>
Date of Death	<p>Enter the individual's date of death. You can enter either the official date of death or the date on which your institution was notified of the death, depending on your institution's requirements.</p> <p>When you enter a date and save the page, the system displays the word <i>DECEASED</i> at the top of pages about this individual throughout your system. If you do not enter a date, the deceased label does not appear.</p> <hr/> <p>Note: If you do not know the date of death, use the Service Indicator page to assign your institution's deceased indicator to this individual.</p> <hr/> <p>If, after you enter a date of death and save the Decedent Data page, you decide that you do not want the deceased label to appear on pages for this individual, return to the Decedent Data page, highlight and delete the date, and then save the page with an empty Date of Death field. The deceased label no longer appears.</p>
Place of Death	Enter the place (city, state, county, or country) where the individual died.
Death Certificate Number	<p>Enter the number from the official certificate of death.</p> <p>The death certificate number might be required for financial aid reconciliation if the individual is a student, for beneficiary pay out if the individual is an employee, or to receive funds if the individual donated a trust to your institution. Consult your institution's administration.</p>

(AUS) Entering Student Data

Access the Student Data AUS page (**Campus Community > Personal Information (Student) > Biographical (Student) > Personal Attributes > Student Data AUS**).

Department of Industry, Innovation, Science, Research and Tertiary Education (DIISRTE) was previously known as DEEWR and before that as DEST. DIISRTE reports require data on students at an institution. It is important that the data elements used in the DIISRTE reports be set up and entered properly.

See “Setting Up TCSI Reporting Codes” (Student Records).

DEEWR Data

<i>Field or Control</i>	<i>Description</i>
DEEWR Year Arrival Code	Enter the year that a student, who was not born in Australia, entered Australia. This value is reported in element 347.
Language Spoken at Home	<p>Enter the appropriate code to indicate the use of a language other than English at the student's permanent home residence.</p> <p>The drop-down list includes any PeopleSoft-defined language codes. The DIISRTE Enrollment Extract process maps your selection to the numeric DIISRTE language code. This value is reported in element 346.</p> <p>See "Setting Up TCSI Reporting Codes" (Student Records).</p>
DEEWR Permanent Resident Code	<p>Select the value for reporting in element 390 – Permanent Resident Eligibility for HELP Assistance.</p> <hr/> <p>Note: This element is reported as blank in files for the 2009 reporting year and later. It is required for pre-2009 reporting periods, including revisions to those reporting periods.</p> <hr/>

Refer to DIISRTE's Higher Education Collection Documentation for explanation of the permanent resident codes.

DEEWR Education Participation Details

Record the status and the last year applicable to each level of education the student has participated in. This data is used to determine the value for elements 493 and 572 if the student is deemed to be a domestic commencing student.

Values for **Post Graduate Program, Degree Program, Higher Ed Sub-Degree Program, VET Sub-Degree Program, and VET Award Program** are:

Commenced, not completed

Completed all requirements

Never commenced

No information

Not a commencing student

Values for **School Secondary Program** are:

Completed final year

Did not do final year

No information

Not a commencing student

Values for **TAFE Secondary Program** are:

Completed such a course

Didn't begin/complete

No information

Not a commencing student

Values for **Other Qualification** are:

No information

No other qualifications/certs (certifications)

Not a commencing student

Other qualifications/certs (certifications)

Field or Control	Description
Commencing Location	<p>Enter the Australian postcode of a student's permanent home residence in their last year of secondary school.</p> <p>This value is reported in element 476 if the student is deemed to be a domestic school leaver commencing an undergraduate course.</p>
Name of Suburb/Town/Locality	<p>Enter the name of the suburb, town, or locality applicable to the permanent residence of the student in their last year of secondary schooling.</p> <p>This value is reported in element 486 if the student is deemed to be a domestic school leaver commencing an undergraduate course.</p>
Gender Parent/Guardian 1	Select the gender for the first parent or guardian.
Highest Education Parent/Guardian 1	Specify the highest level of education attained by the parent or guardian. The values presented in this prompt are restricted to those applicable to the gender specified for parent/guardian 1.
Gender Parent/Guardian 2	Select the gender for the second parent or guardian.

<i>Field or Control</i>	<i>Description</i>
Highest Education Parent/Guardian 2	Specify the highest level of education attained by the parent or guardian. The values presented in this prompt are restricted to those applicable to the gender specified for parent/guardian 2.
Level Left School E612	Select the level student left school.

Managing Relationships Data

Important! Letter Generation (Letter Gen) is a deprecated product. It is strongly recommended that you use Communication Generation (Comm Gen) instead. For more information on Comm Gen, see [Understanding the Communication Generation Process](#)

This section lists prerequisites and discusses how to:

- Relate one individual to another.
- Specify communications for the communication recipient relationship.
- Create joint communications relationships.
- Enter relationship addresses.
- Enter relationship detail data.
- View a list of relationships.
- Identify an individual's relationship with the institution.

Related Links

[Understanding Joint Communications](#)

[Identifying an Individual's Relationship with the Institution](#)

Prerequisites

Before you can enter relationship data, you must define the relationship types for which you want to collect information. To use full relationship functionality, you must also define legacy affiliations, create institutions and academic programs, and create letter codes to identify communications to send to related individuals and set up salutation types to use.

Related Links

[Setting Up Individual Relationships](#)

[Setting Up Relations to the Institution](#)

“Understanding Academic Structure” (Campus Solutions Application Fundamentals)

[Defining Salutation Types for Joint Communications](#)

Reviewing or Defining Campus Community Installation Settings
Defining Letter Codes

Pages Used to Enter Relationships Data

<i>Page Name</i>	<i>Definition Name</i>	<i>Navigation</i>	<i>Usage</i>
Relationships	RELATIONSHIPS	<ul style="list-style-type: none"> • Campus Community > Personal Information > Biographical > Relationships > Relationships • Contributor Relations > Prospect Management > Relationships > Relationships • Contributor Relations > Constituent Information > People > Relationships > Relationships • Student Admissions > Application Entry > Relationships > Relationships • Student Recruiting > Maintain Prospects > Relationships > Relationships 	Enter data to associate one individual with another individual inside or outside of your database.
Legacy Information	LEGACY_SEC	Click the Legacy button on the Relationships page.	Identify a related person's legacy relation with your institution.
Communication Recipient	REL_MLT_RECPT_SEC	Click the Communication Recipients button on the Relationships page.	Specify the communications for which a copy should also be sent to the related person.
Joint Communication Management	RELATION_SALU_SEC	Click the Joint Communication Management button on the Relationships page.	Create joint communications between two related individuals and establish how their names should appear in the address and salutation. You can also use this page to dissolve joint communications for these individuals.

Page Name	Definition Name	Navigation	Usage
Relationship Address	REL_ADDR_DTL	<ul style="list-style-type: none"> • Campus Community > Personal Information > Biographical > Relationships > Relationship Address • Contributor Relations > Prospect Management > Relationships • Contributor Relations > Constituent Information > People > Relationships • Student Admissions > Application Entry > Relationship > Relationships • Student Recruiting > Maintain Prospects > Relationships 	<p>Review addresses for the primary individual and for the related individual. If the related person does not have an ID in your system, the Edit Address link is available for you to enter an address for this person. If you use the communication recipient feature, this is also where you select the related individual's address to send a copy letter. Also, if you use the joint communication feature, this is where you select which address (either from the primary or from the related ID's addresses) to which you want to send the joint communications.</p>
Relationship Detail	RELATIONSHIP_DTL	<ul style="list-style-type: none"> • Campus Community > Personal Information > Biographical > Relationships > Relationship Detail • Contributor Relations > Prospect Management > Relationships • Contributor Relations > Constituent Information > People > Relationships • Student Admissions > Application Entry > Relationships • Student Recruiting > Maintain Prospects > Relationships 	<p>Enter information about the related person that is of interest to your institution.</p>

Page Name	Definition Name	Navigation	Usage
Person-to-Person Summary	RELATIONSHIP_SUMRY	Campus Community > Personal Information > Biographical > Relationships > Person to Person - Summary	View a list of relationships for an individual.
Relations with Institution	PERS_INST_REL	<ul style="list-style-type: none"> • Campus Community > Personal Information > Biographical > Relationships > Relations with Institution • Student Admissions > Application Entry > Relationships > Relations with Institution • Student Recruiting > Maintain Prospects > Relationships > Relations with Institutions 	Specify or review an individual's relations to your institution.

Relating One Individual to Another

Access the Relationships page (**Campus Community > Personal Information > Biographical > Relationships > Relationships**).

This example illustrates the fields and controls on the Relationships page. You can find definitions for the fields and controls later on this page.

You can create the same relationship between the same two people on this page. The system validates the **Effective Date** and **Status** of the relationships. As long as the new relationship is not concurrent with the existing, the system does not return an error, allowing you to track remarriages, for example.

Relationship

<i>Field or Control</i>	<i>Description</i>
Related ID	<p>If the related person is in your database, select the related person's ID. When you select the ID, the system displays the related person's biographical data, including the person's name, prefix, suffix, sex, marital status, and primary NID information.</p> <p>If the related person is not in your database, the name and biographical data fields are available so that you can enter the related person's name and data.</p> <hr/> <p>Note: The Related ID field is available when you are creating the relationship between these individuals for the first time. After you create and save the relationship, when you return to the Relationships page, the system continues to display the related ID and biographical data, but you cannot edit or update it from here. If you need to edit or update the related person's biographical data, click the Biographical Details link at the bottom of the page. You then determine if you need to update information on the Biographical Details page or reconsider the relationship that you are creating.</p>

Field or Control	Description
Relationship	<p>Specify the related person's relationship, such as mother, neighbor, employer, or loan reference to this individual.</p> <p>Values for this field are delivered with your system as translate values. Do not modify these values in any way. Any modifications to these values could require substantial programming effort.</p> <hr/> <p>Note: If you set up marital status verification on the Relationship / Marital Status page, the system verifies the marital status on the Biographical Details page for each individual against the relationship that you select here. If the marital status of either individual is not the appropriate status for the specified relationship, the system displays a warning message suggesting that you update the marital status for the individuals on the Biographical Details page.</p> <hr/>
Guardian	<p>Select the legal guardianship that describes the status of the related person to the primary individual. Values are:</p> <p><i>Guardian</i></p> <p><i>N/A</i></p> <p><i>Other</i></p> <p><i>Parent</i></p> <p><i>Self</i></p> <p>Values for this field are delivered with your system as translate values. Do not modify these values in any way. Any modifications to these values could require substantial programming effort.</p>
Comment	<p>Enter comments to further identify or describe the related person or the relationship between the two individuals.</p>
Biographical Details	<p>Click to access the Biographical Details page, on which you can view or update the related person's biographical data.</p>
Legacy	<p>Click to access the Legacy Information page, on which you can identify the related person's legacy relation with your institution.</p>

Field or Control	Description
Communication Recipients	Click to access the Communication Recipient page, on which you can specify the communications for which a copy should also be sent to the related person.
Joint Communication Management	Click to access the Joint Communication Management page, on which you can create or dissolve joint communications for these two individuals.

Warning! Individuals can have several relationships in your database; however they can have joint communications with only one of those relationships. For example, you can create a relationship between Gloria Wilson and her husband, Mark Gonzalez, and you can create a relationship between Gloria Wilson and her mother, Maria Wilson. You can then create joint communications with either Gloria and her husband or Gloria and her mother, but you cannot create joint communications for both.

Specifying Communications for the Communication Recipient Relationship

Access the Communication Recipient page (click the **Communication Recipients** button on the Relationships page).

You can create letter copies to send to an individual's related IDs. You can create copies of all communications generated for the primary ID or select specific communications to copy. To create the copy letter, you must set up a template with the related ID's name and address. When the letter generation data extract process encounters a letter code that is set to include a copy to the individual's related ID, it extracts the related person's address data from the Relationship Address page.

Note: For confidentiality purposes, the communication recipients that you set here will not receive copies of communications set to allow joint communications for a relationship, even when you select *All Communications*. This preserves information communicated to Mr. and Mrs. Smith, for example.

Field or Control	Description
All Communications	Select to generate a copy for this related individual of all communications to the primary individual.
Letter Code	Enter the letter codes for the communication to copy. Available letter codes are from the Standard Letter Codes page.

Warning! When an individual has multiple relationships set up with communication recipients, the process extracts data for all of the related IDs. When merging the data into the template, the process lists a maximum of five recipients as receiving a copy. You can create and send copies to more than five recipients, but the letter can list only five, as shown in the following sample letter. The following graphic provides an example of the CCLTRREC.doc letter that is created for recipients set on the Communication Recipient page:

example of the CCLTRREC.doc letter that is created for recipients set on the Communication Recipient page

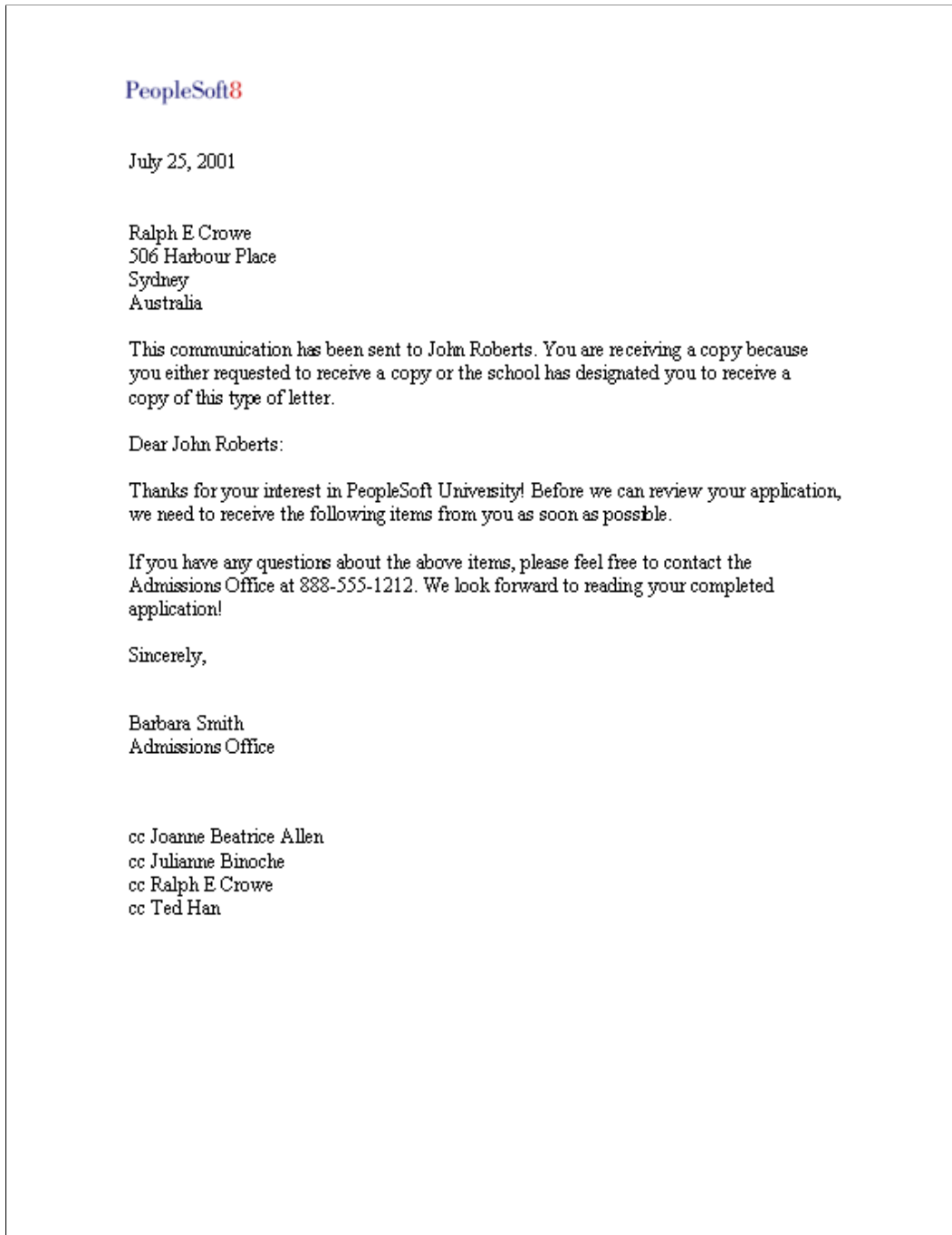

Creating Joint Communications Relationships

Access the Joint Communication Management page (click the **Joint Communication Management** button on the Relationships page).

This example illustrates the fields and controls on the Joint Communication Management page. You can find definitions for the fields and controls later on this page.

Relationship

Joint Communication Management

Create Joint Communication Dissolution Reason:

Joint Salutations Find | View All First 1 of 1 Last

*Salutation Type: Primary + -

*Salutation (Line 1)

Salutation (Line 2):

*Address Block Name (Line 1)

Address Block Name (Line 2):

<i>Field or Control</i>	<i>Description</i>
Create Joint Communication	Select to address joint communications to both the primary and related individuals, using the salutation that you specify on this page.
Dissolution Reason	<p>When you clear the Create Joint Communication check box, or when you inactivate the relationship to stop joint communications for these two individuals, the Dissolution Reason field becomes available, enabling you to enter the reason for dissolving the joint communications. Values include:</p> <p><i>Deceased Partner</i></p> <p><i>Divorce</i></p> <p><i>Per Request</i></p> <p>Values for this field are delivered with your system as translate values. You can modify these translate values.</p>

Joint Salutations

Field or Control	Description
Salutation Type	<p>Specify the type of salutation, from the Joint Salutation Type Table page, to use for joint communications to these IDs.</p> <p>When you enter a salutation type, the system displays the individual's names in the Salutation and Address Block Name fields, based on the default formats associated with that salutation type. The default formats are designed to reduce data entry; however always validate that the information is correct.</p> <hr/> <p>Note: When you select the Create Joint Communication check box, the system displays the default salutation type from the Installation Default – CC page, if you entered one. You can add salutation types, but do not delete the one that you defined as the default value. Use the default value as the lowest level joint usage on the Name Usage page so that when you run the letter generation process, it does not fail due to a lack of salutation type.</p> <hr/>
Salutation (Line 1), Salutation (Line 2)	<p>The system displays the names of the two individuals as they will appear in the greeting of the letter according to the default salutation format for the salutation type defined on the Joint Salutation Type Table page.</p> <p>Example values include:</p> <p><i>Mr. and Mrs. Smith</i></p> <p>or, using two lines:</p> <p><i>John Smith</i></p> <p><i>Mary Fletcher</i></p>

Field or Control	Description
Address Block Name (Line 1) Address Block Name (Line 2)	<p>The system displays the names of the two individuals as they will appear in the address of the letter (and envelope or label if applicable) according to the default address block format for the salutation type defined on the Joint Salutation Type Table page.</p> <p>Example values include:</p> <p><i>Mr. and Mrs. Smith</i></p> <p>or, using two lines:</p> <p><i>John Smith</i></p> <p><i>Mary Fletcher</i></p>

Entering Relationship Addresses

Access the Relationship Address page (**Campus Community > Personal Information > Biographical > Relationships > Relationship Address**).

This example illustrates the fields and controls on the Relationship Address page (1 of 2). You can find definitions for the fields and controls later on this page.

Relationships	Relationship Address	Relationship Detail
John Roberts		AD1000
Relationship Address Details Find View All First ◀ 1 of 1 ▶ Last		
Effective Date:	03/28/2001	Status: Active + -
Relationship:	Spouse	James,Heather
Related ID (or Name)		
James,Heather		<input checked="" type="checkbox"/> Joint Address
Related ID (or Name) Address		
Address Type:	HOME	Related ID's Addresses
Country:	United States	
Address:	4529 Monrovia Drive Hope, AK 78555	
Related ID (or Name) Email		
Email Type		Related ID's Electronic Addresses
Email Address		

This example illustrates the fields and controls on the Relationship Address page (2 of 2). You can find definitions for the fields and controls later on this page.

Primary ID

John Roberts **Joint Address**

Primary ID Address

Address Type: HOME [Primary ID's Addresses](#)

Country: United States

Address: 7729 Naylor Trail
Osh Kosh, WI 56998

Primary ID Email

Email Type: HOME [Primary ID's Electronic Addresses](#)

Email Address johnr@aol.com

Related ID (or Name)

<i>Field or Control</i>	<i>Description</i>
Joint Address	<p>Select to send joint communications for these two individuals to this address.</p> <p>If the related person does not have an ID in your database, this check box is unavailable. For the system to generate a joint communication, the address must be associated with an ID in your system.</p> <p>For joint communications, you must select either the related individual's address or the primary individual's address as the joint address to use. You cannot select both.</p>

Related ID (or Name) Address

<i>Field or Control</i>	<i>Description</i>
Address Type	<p>Select the address type to use for the related individual in association with this relationship.</p> <p>If the related person does not have an ID in your database, the Edit Address link becomes available. Click the link to enter the related person's address data.</p> <p>If the individual has an ID in your database, the system automatically displays the address data for the address type that you select. Only address types that contain data are available.</p> <p>If you do not select an address type, the default value is the address type selected in the Address For Related ID field on the Installation Default - CC page.</p>
Related ID's Addresses	<p>If the related person has an ID in your database, you can click this link to access the Addresses page where you can view or update the related person's address data.</p> <p>If the related person does not have an ID in your database, this link is not available.</p>

Related ID (or Name) Email

<i>Field or Control</i>	<i>Description</i>
Email Type	Select the related individual's email address type to associate with this relationship.
Email Address	<p>Enter the related individual's email address.</p> <p>If the related person has an ID in your database, the email address for the specified email type appears.</p> <p>If the related person does not have an ID in your database, the field is not available.</p>
Related ID's Electronic Addresses	<p>If the related person has an ID in your database, click this link to access the Electronic Addresses page where you can view or update the related person's email address data.</p> <p>If the related person does not have an ID in your database, this link is not available.</p>

Primary ID

<i>Field or Control</i>	<i>Description</i>
Joint Address	<p>Select to send joint communications for this relationship to this address.</p> <p>For joint communications, you must select either the related individual's address or the primary individual's address as the joint address to use. You cannot select both.</p>

Primary ID Address

<i>Field or Control</i>	<i>Description</i>
Address Type	<p>Select the primary individual's address type to associate with this relationship.</p> <p>Because the primary individual has an ID in your database, the system automatically displays the address data for the address type that you select. Only address types that contain data are available.</p> <p>If you do not select an address type, the default value is the address type selected in the Address For Primary ID field on the Installation Default - CC page.</p>
Joint Address	<p>Select to send joint communications for these two individuals to this address.</p> <p>If you are creating joint communications for this relationship, you can select either the related individual's address or the primary individual's address as the joint address, but you <i>must</i> select one of them. You cannot select both.</p>
Primary ID's Addresses	<p>Click this link to access the Addresses page, on which you can edit or update the primary person's address data.</p>

Primary ID Email

<i>Field or Control</i>	<i>Description</i>
Email Type	<p>Select the primary individual's email address type to associate with this relationship.</p>
Email Address	<p>Displays the email address for the email type selected.</p>

Field or Control	Description
Primary ID's Electronic Addresses	Click this link to access the Electronic Addresses page, on which you can view or update the primary person's email address data.

Note: The email addresses that you enter on the Relationship Addresses page are used by the Communication Generation process to send emails to the communication recipients. When no email address is entered, intended recipients will not receive a copy of the communication.

See [Entering Relationship Addresses](#).

Entering Relationship Detail Data

Access the Relationship Detail page (**Campus Community > Personal Information > Biographical > Relationships > Relationship Detail**).

This example illustrates the fields and controls on the Relationship Detail page. You can find definitions for the fields and controls later on this page.

The screenshot shows a web interface for 'Relationship Detail' for a person named John Roberts (AD1000). The page has three tabs: 'Relationships', 'Relationship Address', and 'Relationship Detail' (which is active). Below the tabs, the name 'John Roberts' and ID 'AD1000' are displayed. A 'Relationship' section shows 'Effective Date: 03/28/2001', 'Status: Active', and 'Relationship: Spouse' with the name 'James, Heather'. Below this is a 'Relation Demographics' section with fields for 'Income' (with a USD dropdown), 'Occupation', 'External Org ID', 'Employer', and 'Highest Education Level' (a dropdown menu). A 'Relation Residency' section includes 'Country' (USA, United States), 'State', and 'Date'. At the bottom, there are four navigation links: 'Phones', 'Email Address', 'Biographical Details', and 'Citizenship and Passport Data'.

Relation Demographics

For related individuals with or without an ID in your database, enter data in the fields in this area. For a related individual with an ID in your database, you can click the **Biographical Details** link at the bottom of the page, to review additional information.

Field or Control	Description
Income	Enter the amount of the related individual's income and the currency in which it is expressed. The amount is usually expressed annually, but it can be expressed hourly or monthly.
Occupation	Enter the related individual's occupation, from the Standard Occupation Classification Code page.
External Org ID	If the related person is associated with or employed by an organization that is in your database, identify that organization here.
Employer	The system automatically displays the name of the related person's employer if you selected an employer ID. If the employer does not have an organization ID in your database, you can manually enter the employer's name here.
Highest Education Level	Specify the highest level of education that the related person has achieved. Values for this field are delivered with your system as translate values. Do not modify these values in any way. Any modifications to these values could require substantial programming effort.

Relation Residency

Field or Control	Description
Country, State, and Date	For related individuals with or without an ID in your database, you must enter the related individual's country, state and date of residency information.

Daytime Telephone

When the related person does not have an ID in your database, the system displays this group box with fields available for you to enter the related person's daytime, evening, and fax telephone numbers.

Email ID

When the related person does not have an ID in your database, the system displays this group box with fields available for you to enter the related person's email ID and URL.

Country of Citizenship

When the related person does not have an ID in your database, the system displays this group box with fields available for you to enter the related person's country of citizenship and citizenship status based on the Citizen Status Table page.

Links

<i>Field or Control</i>	<i>Description</i>
Phones	<p>Click this link to access the Phone Numbers page, on which you can review or change telephone numbers for the related ID.</p> <p>For a related individual with no ID in your database, manually enter the individual's phone data in the Daytime Telephone section.</p>
Email Address	<p>Click this link to access the Electronic Addresses page, on which you can review or change URLs and email addresses for the related ID.</p> <p>For a related individual with no ID in your database, manually enter the individual's email data in the Email ID section.</p>
Biographical Details	<p>If this related individual has an ID in your database, click this link to access the Biographical Details page, on which you can review or change additional basic data for the related ID.</p>
Citizenship and Passport Date	<p>Click this link to access the Citizenship/Passport page, on which you can review or change additional citizenship and passport data for the related ID.</p> <p>For related individuals without an ID in your database, you must manually enter the related individual's Citizen Country and Citizenship Status.</p>

Viewing a List of Relationships

Access the Person-to-Person Summary page (**Campus Community > Personal Information > Biographical > Relationships > Person to Person - Summary**) to view a list of an individual's relationships.

The Person-to-Person Summary page is for viewing only. You cannot enter or edit data here. Data that appears here is entered on pages in the Relationships component.

Identifying an Individual's Relationship with the Institution

Important! Mass Change is a deprecated product. It is strongly recommended that you use Application Engine instead. For more information on PeopleSoft Application Engine, see *PeopleTools: Application Engine*.

Access the Relations with Institution page (**Campus Community > Personal Information > Biographical > Relationships > Relations with Institution**).

Note: PeopleSoft Contributor Relations Solutions uses the abbreviations on this page in the contributor relations search.

See [Using Search/Match](#).

<i>Field or Control</i>	<i>Description</i>
Currently Is A(n)	Select to indicate that the individual is currently related in this way to your institution.
Has Been A(n)	Select to indicate that the individual has previously been related in this way to your institution.
Manual Maintenance	Select to indicate that this relationship (current or past as appropriate) should be maintained manually and not used or changed by mass change or any other automatic process.

Entering Emergency Contact Data

This section discusses how to

- Enter emergency contact data.
- Enter additional phone numbers for the emergency contact.

Pages Used to Enter Emergency Contact Data

<i>Page Name</i>	<i>Definition Name</i>	<i>Navigation</i>	<i>Usage</i>
Emergency Contact Information	SCC_EMERG_CNTCT1	Campus Community > Personal Information > Biographical > Emergency Contacts	Enter an individual's emergency contact data, including the contact's name, addresses, and primary phone number.

Page Name	Definition Name	Navigation	Usage
Other Phone Numbers	SCC_EMERG_CNTCT2	Campus Community > Personal Information > Biographical > Emergency Contacts > Other Phone Numbers	Enter additional telephone numbers for an emergency contact.

Entering Emergency Contact Data

Access the Emergency Contact Information page (**Campus Community > Personal Information > Biographical > Emergency Contacts**).

This example illustrates the fields and controls on the Emergency Contact Information page. You can find definitions for the fields and controls later on this page.

Emergency Contacts

Emergency Contact Information
Other Phone Numbers

Madison Rose
PU311

Emergency Contact
Find | View All
First 1 of 1 Last

*Contact Name

*Relationship Parent Primary Contact

Email Address

Missing Person Contact

Comments/Notes

Same Address as Individual

Same Phone as Individual

Contact Address

Country USA

Address

Contact Phone

Phone Extension Country

Emergency Contact

Field or Control	Description
Contact Name	Enter the name of the emergency contact for this individual.

Field or Control	Description
Relationship	<p>Select the option that indicates the contact's relationship to the individual at your institution.</p> <p>Values for this field are delivered with your system as translate values. Do not modify these values in any way. Any modifications to these values could require substantial programming effort.</p>
Primary Contact	<p>Select to indicate that this is the first person to contact in an emergency. You can enter only one primary contact for an individual.</p>
Missing Person Contact	<p>By default, this checkbox isn't selected.</p> <p>When you select this checkbox, this designates the person as a missing person contact.</p>
Same Address as Individual and Address Type	<p>Select to indicate that the contact has the same address information as the individual in your database, and then select that individual's address type that is the same as this contact's address type. If it is selected, you do not need to complete any of the address fields. The system displays the correct address data.</p> <hr/> <p>Note: If Same Address as Individual is not selected, the address area of the page is titled <i>Contact Address</i>. When Same Address as Individual is selected, the title becomes <i>Individual's Current Address</i>.</p> <hr/>

<i>Field or Control</i>	<i>Description</i>
Same Phone as Individual and Phone Type	<p>Select to indicate that the contact has the same phone information as the individual in your database, and then select that individual's phone type that is the same as this contact's phone type. If it is selected, you do not need to complete any of the phone fields. The system displays the correct phone data.</p> <p>An emergency contact can have the same address as the primary individual, but have a different phone number.</p> <hr/> <p>Note: If Same Phone as Individual is not selected, the phone area of the page is titled <i>Contact Phone</i>. When Same Phone as Individual is selected, the title becomes <i>Individual's Phone</i>.</p> <hr/> <p>Note: When an Emergency Contact name is entered, a phone number is also required. You can provide the Emergency Contact phone number in these fields: the Emergency Contact Phone field and the Emergency Contact, Other Phone Types and Phone fields. You can also select the Same Phone as the Individual check box if a phone number exists for that corresponding individual.</p> <hr/>

Entering Additional Phone Numbers for the Emergency Contact

Access the Emergency Contact Other Phones page (**Campus Community > Personal Information > Biographical > Emergency Contacts > Other Phone Numbers**).

Other Phone Numbers

<i>Field or Control</i>	<i>Description</i>
Phone Type	Select the phone type that describes the additional phone number for this emergency contact.
Phone	Enter the additional phone number for this emergency contact.

Tracking Work Experience

This section discusses how to enter work experience data.

Pages Used to Track Work Experience

<i>Page Name</i>	<i>Definition Name</i>	<i>Navigation</i>	<i>Usage</i>
Work Experience	PRIOR_WORK_EXP_SA	<ul style="list-style-type: none"> • Campus Community > Personal Information > Biographical > Work Experience • Student Admissions > Application Entry > Relationships > Work Experience • Student Recruiting > Maintain Prospects > Relationships > Work Experience • Contributor Relations > Constituent Information > People > Relationships > Work Experience • Student Recruiting > Student Recruiters > Participation and Achievements > Work Experience 	Enter data to track an individual's work experience.

Entering Work Experience Data

Access the Work Experience page (**Student Recruiting > Student Recruiters > Participation and Achievements > Work Experience**).

Work Experience Details

<i>Field or Control</i>	<i>Description</i>
Employer	<p>If the employer is an organization in your database, enter the organization's ID. The system displays the organization name and address.</p> <p>If the employer is not an organization in your database, enter the employer's name and address.</p>
Retired and Retire Date	If the person retired from this employer, select this check box and enter the date on which the individual retired.

Field or Control	Description
Work Experience Address	Enter the work address details of the individual.
None	Select to indicate that the address of the organization where the individual worked is unknown. You can then select a country and state, and enter a city name.
Location	Select a location from the work locations listed for the organization.
Address Type	Select the address type. If an individual worked for an organization but from a home office; you can select an address from the person's list of addresses.

Field or Control	Description
Relevant Work Experience	Select to indicate that the former position is relevant to a current position within your institution or to the career that the individual is seeking.
Industry Code (SIC) (industry code [Standard Industrial Classification])	Enter the SIC for this position.
Start Date and End Date	Enter the dates on which the individual began and ended employment with this employer.
Job Title	Enter the title of the last position that the individual held with this employer.
Occupation Code (SOC) (occupation code [Standard Occupation Classification])	Select the SOC codes for this position.
Employment Fraction	The fractional amount of full time employment.
Hours Per Week	Enter the number of hours per week that the employee is scheduled to work. Hours per week are particularly important for the recording of the current work commitments in terms of potential impact on study.
Ending Pay Rate	Enter the pay rate and currency at which the individual ended employment.

<i>Field or Control</i>	<i>Description</i>
Pay Frequency	Select the frequency that describes the ending pay rate. The default value is <i>Month</i> .
Comments	Enter comments to further describe this work experience.

Attachments

<i>Field or Control</i>	<i>Description</i>
Add Attachment	Click this button to add a file attachment to the page.

(AUS) Managing CHESSN Data Storage

Understanding CHESSN Data

CHESSN is a number assigned by HEIMS that uniquely identifies each student who receives Commonwealth assistance. All Commonwealth supported students or students who receive any Higher Education Loan Programme (HELP) assistance (HELP loan, OS-HELP) *must* have a CHESSN. The government uses the unique identifier to manage and monitor the Commonwealth assistance entitlements of students as defined by Higher Education Support Act 2003. The CHESSN allocated to a student is a life long identifier, therefore, except for exceptional circumstances, once a student is allocated a CHESSN, it will remain with them for life. Equally, an individual (student) must have only one active CHESSN.

Higher Education Providers (HEPs) can provide to HEIMS the data required for CHESSN allocation in one of the following ways:

- In XML format sent to HEIMS through a web service channel (for allocation of one or many students).
- Typed directly into a HEIMS web browser screen available to HEPs.

This method is typically reserved for the request for allocation of a small number of CHESSNs.

The data sent through either of the above two methods provides information about students, such that HEIMS can provide a *provisional* CHESSN. The information provided by the HEP to HEIMS will also be used to identify, with high probability, a unique individual so as to prevent and minimize the probability of allocating multiple CHESSNs per student.

A CHESSN becomes *active* within HEIMS only when a record for the student is received in the Load-Liability file (LL file). The HEP informs students of their CHESSN through the Commonwealth Assistance Notice (CAN) service. The CAN service is a part of the HELP loans processing feature and is documented in the PeopleSoft Campus Solutions Student Financials documentation.

See “Creating Commonwealth Assistance Notices” (Student Financials).

Storing CHESSN Data

PeopleSoft provides the CHESSN Data component (SCC_CHESSN_AUS) through which you can record and store important CHESSN information for individual students. The component can be used preliminarily to store data for each student that you send to HEIMS for the CHESSN allocation process. Once HEIMS allocates provisional CHESSNs, you can record each student's CHESSN number with a *Provisional* status. Later, when students enroll, you send HEIMS the student's records in a Load-Liability (LL) file. Upon receiving the LL file, HEIMS updates the CHESSN status to *Active* for all reported students. You can then update the status in your system.

This section discusses how to:

- Enter CHESSN data.
- Enter CHESSN Year 12 data.
- Enter CHESSN previous HEP data.

Note: In addition to manually entering CHESSN data in the CHESSN Data component for students with newly assigned provisional or active CHESSNs, you can receive previously assigned CHESSN numbers for students by way of TAC (Tertiary Admissions Centre) loads. CHESSN values appear on the Personal Data page in the TAC suspense and TAC posting components.

See “Understanding TAC Data Load Processing” (Recruiting and Admissions).

Pages Used to Store CHESSN Data

<i>Page Name</i>	<i>Definition Name</i>	<i>Navigation</i>	<i>Usage</i>
CHESSN	SCC_CHESSN_AUS	Campus Community > Personal Information (Student) > Biographical (Student) > Personal Attributes > CHESSN Data > CHESSN	Record CHESSNs, SLE usage, and remaining FEE-HELP balance for a student.
CHESSN Year 12	SCC_YR12_AUS	Campus Community > Personal Information (Student) > Biographical (Student) > Personal Attributes > CHESSN Data > CHESSN Year 12	Record Year 12 information for a student.
CHESSN Previous HEP	SCC_HEP_AUS	Campus Community > Personal Information (Student) > Biographical (Student) > Personal Attributes > CHESSN Data > CHESSN Previous HEP	Record previous HEP attendance information for a student.
CLS and OS-HELP	SCC_CLS_AUS	Campus Community > Personal Information (Student) > Biographical (Student) > Personal Attributes > CHESSN Data > CLS and OS-HELP	Record entitlement information for CLS and OS-HELP.
Population Update Process	SCC_POP_UPD	Set Up SACR > System Administration > Utilities > Update > Population Update Process	Update the CHESSN Data - Stop Population consent value.

Entering CHESSN Data

Access the CHESSN page (**Campus Community > Personal Information (Student) > Biographical (Student) > Personal Attributes > CHESSN Data > CHESSN**).

CHESSN Data

<i>Field or Control</i>	<i>Description</i>
Student Consent	Enter a value regarding the student's consent for releasing his or her information to HEIMS for CHESSN allocation. Choices are: <i>Consent Denied</i> , <i>Consent Received</i> , and <i>Consent not yet sought</i> .

HEIMS Entitlement Data

<i>Field or Control</i>	<i>Description</i>
Entitlement Request	Select this check box if the data is the result of an HEIMS entitlement request.
CHESSN	Enter the student's assigned CHESSN. The system verifies the CHESSN number that you enter against the ISO 7064 Algorithm specified by the Department of Industry, Innovation, Science, Research and Tertiary Education (DIISRTE).
CHESSN Status	HEIMS assigns a status of <i>Active</i> , <i>Provisional</i> , or <i>Suspended</i> to each CHESSN. The CHESSN status is <i>Provisional</i> until a student is reported through the LL file as enrolled with their account settled, at which time HEIMS updates the status to <i>Active</i> . Enter the appropriate value in this field.
Comments	Enter any comments regarding this record.

Ordinary Student Learning Entitlement, FEE-HELP Entitlement, HELP LOAN Entitlement, Commonwealth Scholarships, and OS-HELP Entitlement

Note: From January 1, 2020, the HELP LOAN Entitlement region is used instead of FEE-HELP Entitlement.

For each of the applicable entitlement types, enter the following information:

Field or Control	Description
Usage	Enter the amount of this entitlement used by the student. For example, for SLE, enter the of EFTSL (equivalent full time student load) units used by the student. For FEE-HELP (Pre-2020) and HELP LOAN, enter the monetary amount used by the student. Express the amount in AUS currency or the default currency set for your institution.
Balance	Enter the amount of this entitlement unused by the student.
Limit	Enter the maximum amount of this entitlement allowed for the student.
As At Date	Enter the date when this entitlement data was received from HEIMS. Data is considered confirmed by HEIMS as accurate on the date when your institution receives it.

Entering CHESSN Year 12 Data

Access the CHESSN Year 12 page (**Campus Community > Personal Information (Student) > Biographical (Student) > Personal Attributes > CHESSN Data > CHESSN Year 12**).

Field or Control	Description
Attended Year 12	Enter a value regarding the student's year 12. Choices are: <i>Attended Year 12</i> , <i>Did Not Attend Year 12</i> , and <i>Unknown</i> . If you select <i>Attended Year 12</i> , additional fields appear on the page.
Year 12 Year	Enter the academic year in which the student was enrolled as year 12.
Effective Sequence	If the student attended more than one year 12 organization in the same year, use a unique effective sequence to identify each instance. The system populates this field to 1 by default, and then increments the value each time a new row is added with the same year as an existing row.
Year 12 Student Number	Enter the student's identification number from their year 12 organization.
State	Enter the state in which the student attended year 12.

Use Ext Org ID or School Name

<i>Field or Control</i>	<i>Description</i>
External Org ID	If you have defined schools as organizations, you can select the school using the prompt in this field.
School Name	If you have not defined the school as an organization in your system, enter the school name.

Entering CHESSN Previous HEP Data

Access the CHESSN Previous HEP page (**Campus Community > Personal Information (Student) > Biographical (Student) > Personal Attributes > CHESSN Data > CHESSN Previous HEP**).

<i>Field or Control</i>	<i>Description</i>
Attended Previous HEP	Enter a value regarding the student's previous HEP attendance. Choices are: <i>Attended Previous HEP</i> , <i>Did Not Attend Previous HEP</i> , and <i>Unknown</i> . If you select <i>Attended Previous HEP</i> , additional fields appear on the page.
HEP Year	Enter the most recent academic year in which the student was enrolled at the HEP.
Effective Sequence	If the student attended more than one HEP in the same year, use a unique effective sequence to identify each instance. The system populates this field to 1 by default, and then increments the value each time a new row is added with the same year as an existing row.
HEP Student Number	Enter the student's identification number from their HEP.
HEP Code	Enter the HEP code for the organization. The HEP Code value is the DIISRTE institution code used for Element 306.

Entering Commonwealth Scholarships and OS-HELP Entitlement Data

Access the CLS and OS-HELP page (**Campus Community > Personal Information (Student) > Biographical (Student) > Personal Attributes > CHESSN Data > CLS and OS-HELP**).

Commonwealth Scholarships

Enter the usage, balance, and limit amounts for the each of the applicable scholarship categories.

<i>Field or Control</i>	<i>Description</i>
As At Data	Enter the date when the scholarship data was received from HEIMS. Data is considered confirmed by HEIMS as accurate on the date when your institution receives it.
Usage	Enter the number of payments that have been issued to the student.
Balance	Enter the number of payments remaining for the student.
Limit	Enter the maximum number of payments to which the student is entitled.

OS-HELP Entitlement

Enter the student's OS-HELP entitlement usage, balance, limit, and as at date.

Chapter 49

(NZL) Managing NSI Data

Understanding PeopleSoft NSI Processing

Important! Mass Change is a deprecated product. It is strongly recommended that you use Application Engine instead. For more information on PeopleSoft Application Engine, see *PeopleTools: Application Engine*.

The NSI for New Zealand is a database system maintained by the Ministry of Education. The system allocates a unique identifier, an NSN, to every tertiary student and every National Certificate of Education Achievement (NCEA) candidate. The NSN must be included for every student reported to the Ministry of Education in a Single Data Return (SDR) as of April 2003. Including this number in a database allows information about each student to be linked together even if different institutions report the information in different years. The NSI database is a repository of verified student details. You can use verified NSI records as evidence of students' identities rather than having to ask all students to provide documentary evidence such as birth certificates.

Interaction with the NSI is a two-way flow of information. PeopleSoft provides several processes that enable you to collect and pass data back and forth between your PeopleSoft database and the NSI as data is changed, updated, or added.

Note: It is important that you request an NSI website login ID and password from the New Zealand Ministry of Education to access the NSI database, and that you clearly understand the Ministry of Education NSI process before you begin using PeopleSoft NSI functionality. Consult the Guide to Integrating with National Student Index (GINS) on the Ministry of Education website www.minedu.govt.nz. You must manually log onto the NSI website to upload and download NSI files. Your institution must monitor the Ministry of Education website and determine when files are ready to load. PeopleSoft does not offer an automated process. The PeopleSoft solution is based on Version 2.0 – May 2002 of the GINS document. See www.minedu.govt.nz.

PeopleSoft processes, described in this section, enable you to prepare and exchange data between your PeopleSoft database and the Ministry of Education database. The processes are:

1. Request NSN process (CCNSIRQN), which executes a mass change to identify students, prospects, or applicants who do not have assigned NSNs.
2. Extract NSI process (CCNSIEXT), which extracts data into a file to send to the Ministry of Education.
3. Load NSI Data process (CCNSILOD), which loads data from that extract file into the NSI Suspense Table so you can review it.
4. Post NSI Data process (CCNSIPST), which posts data from the NSI Suspense Table to your PeopleSoft database.

5. Purge NSI Suspense Table process (CCNSIPRG), which purges posted and corrected rows from the NSI Suspense Table.
6. NSI Change Notification process (CCNSICHG), which posts the Ministry of Education changes to NSI records for individuals who are active at your school.

PeopleSoft temporarily stores NSI data in the NSI Suspense Table. Use the suspense table as a central point to monitor data to send to NSI and the results data that NSI sends back to you. Outgoing Data and Incoming Data pages in the suspense table enable you to view data according to direction and to compare the data to make sure that the correct data is loaded for the right person.

A status assigned to each record in the suspense table enables you to determine where the record is in the process. For outgoing data, the status indicates if the data is ready to extract and send to the Ministry of Education or if it has been posted and is ready to purge from the suspense table. For incoming data, the status indicates if the data has been posted to your database or if an error occurred during processing.

The Outgoing Data page is populated with data from the Biographical Details and Regional pages when the Request NSN process (CCNSIRQN) runs or when a change is made to an NSI field for any individual who is NSI processing enabled (the **NSI Processing Enabled** check box is selected on the Regional page). If the individual record already exists on the Outgoing Data page awaiting assignment of an NSN, the existing data is updated. If the individual already has an NSN, the updated record is added to the Outgoing data page so that the changes can be reported to NSI. The Incoming Data page is populated when you run the Load NSI Data process to load data from the result files that you receive from NSI.

See [Viewing Outgoing Suspense Data](#).

See [Reviewing Incoming Suspense Data](#).

The first step in the overall process is to identify students, prospects, or applicants who do not have an assigned NSN and for which, based on certain criteria, you want to request an NSN from the Ministry of Education. Run the Request NSN process (CCNSIRQN) to execute a mass change to identify these individuals according to criteria that you specify. Modify the sample mass change definitions to reflect the criteria that your institution uses to define prospects, applicants, and students. Do not attempt to rename the mass change definitions. Then, run the process to execute the mass change.

When the request process runs, it copies data for the individuals identified in the mass change from the Add/Update a Person component (specifically from the Biographical Details and Regional pages) to the Outgoing Data page of the suspense table. The process inserts records with the most current file numbers on the Campus Community Installation component, and displays a status of *Ready for Extraction*. You can view the Outgoing Data page to see the results of the request process.

See [\(NZL\) Reviewing or Defining Default Installation Settings for National Student Index Processing](#).

Also, as the request process adds the record to the Outgoing Data page of the suspense table, it sets that record to NSI processing enabled (by selecting the NSI Processing Enabled check box on the Regional page of the Add/Update a Person component). As long the record remains NSI processing enabled, the system will update the outgoing suspense data whenever a change is made to any NSI field. This automatic update ensures that the extract process captures the most up-to-date data to send to the Ministry of Education.

Note: The Ministry of Education requires that you notify them if changes are made to any NSI field. If you make a change to an NSI field when the **NSI Processing Enabled** check box is not selected, you will need to send the NSI an Update Insert Request to notify the NSI database that the data was changed and verified.

See [Understanding NSI Fields](#).

See [Identifying Individuals Without NSNs](#).

To extract outgoing data from the suspense table into a delimited file to send to the Ministry of Education, run the NSI Extraction process (CCNSIEXT). The process extracts data for IDs with a status of *Ready for Extraction* on the Outgoing Data page and changes the status to *Extracted* when the extract file is created. You must manually upload this file to the NSI website. The Ministry of Education then processes the IDs and posts the results on their website in a similar format, ready for you to download manually.

See [Extracting Data to Send to NSI](#).

To receive data from the Ministry of Education, you must download the appropriate NSI Result file from the Ministry of Education website and then run the Load NSI Data process (CCNSILOAD) to load data from that file. You can view results of the upload process on the Incoming Data page of the suspense table. The upload process displays a status of *Ready to Post* if it finds a perfect match between the Ministry of Education data and the record sent from your PeopleSoft database, or displays a status of *Select a Match* if it finds one or multiple possible matches between the Ministry of Education data and records in your database. In the latter case, it is your responsibility to evaluate the potential match and determine if one matches your data or if a new NSN should be created. If an error occurred (for example, the date of birth and gender information was not sent), the *Error* status appears.

See [Loading Results Data](#).

To post incoming data from the suspense table to your PeopleSoft database, run the Post NSI Data process (CCNSIPST). The process posts only the rows on the NSI Suspense component with a status of *Ready to Post* and changes the status to *Posted*.

See [Posting NSI Data](#).

To purge processed rows from the suspense table, run the Purge NSI Suspense Table process (CCNSIPRG). The purge process deletes rows with a status of *Posted* from the NSI Suspense component and deletes rows with a status of *Error Corrected*.

Note: You can run the purge process at any time. However, you must run the extract, load, and post processes in just that order for each file number that you upload from NSI.

See [Purging Suspense Data](#).

To receive the Ministry of Education changes to NSI records for individuals who are active at your school, run the NSI Change Notification process (CCNSICHG).

See [Uploading and Posting NSI Change Notifications](#).

Here is an example of NSI data management:

On Monday, you run the request NSN process (CCNSIRQN). The process executes the mass change for students and retrieves a record for ID 1234, Mary Smith, birthdate 01/01/1980. The request NSN process adds Mary's information to the NSI Suspense table Outgoing Data page with a file number of 0007.

Mary's record is NSI processing enabled. The extract process runs at the end of the day, extracting all IDs associated with file number 0007 to send to NSI. You have requested an NSN for Mary and are waiting for the results from NSI.

On Tuesday, you realize that Mary's birthdate is actually 01/01/1982. You access the Biographical Details page and change Mary's birthdate from 01/01/1980 to 01/01/1982. Because Mary's record is NSI processing enabled and birthdate is a field included in NSI records, the system automatically adds a new row to the NSI Suspense table for Mary with a file number 0008. The extract process runs at the end of the day, extracting file number 0008 to send to NSI.

On Wednesday, you download the NSI Result file for file number 0007 (REU0007a.txt) and upload data from that result file into your database. Mary now has an NSN but her birthdate is 01/01/1980.

On Thursday, you download the NSI Result file for file number 0008 and upload data from that result file into your database. Mary now has an NSN and her correct birthdate of 01/01/1982. The upload process overrode the data with the latest change to the birthdate field. The suspense table helps you maintain the most current data while you wait for data to be processed by the NSI database.

This diagram provides an overview of the flow of the NSI processes. It shows the cause and effect of the status of a change in the NSI Suspense Table and the appropriate SQR action.

Overview of PeopleSoft NSI business process diagrams NSI business process

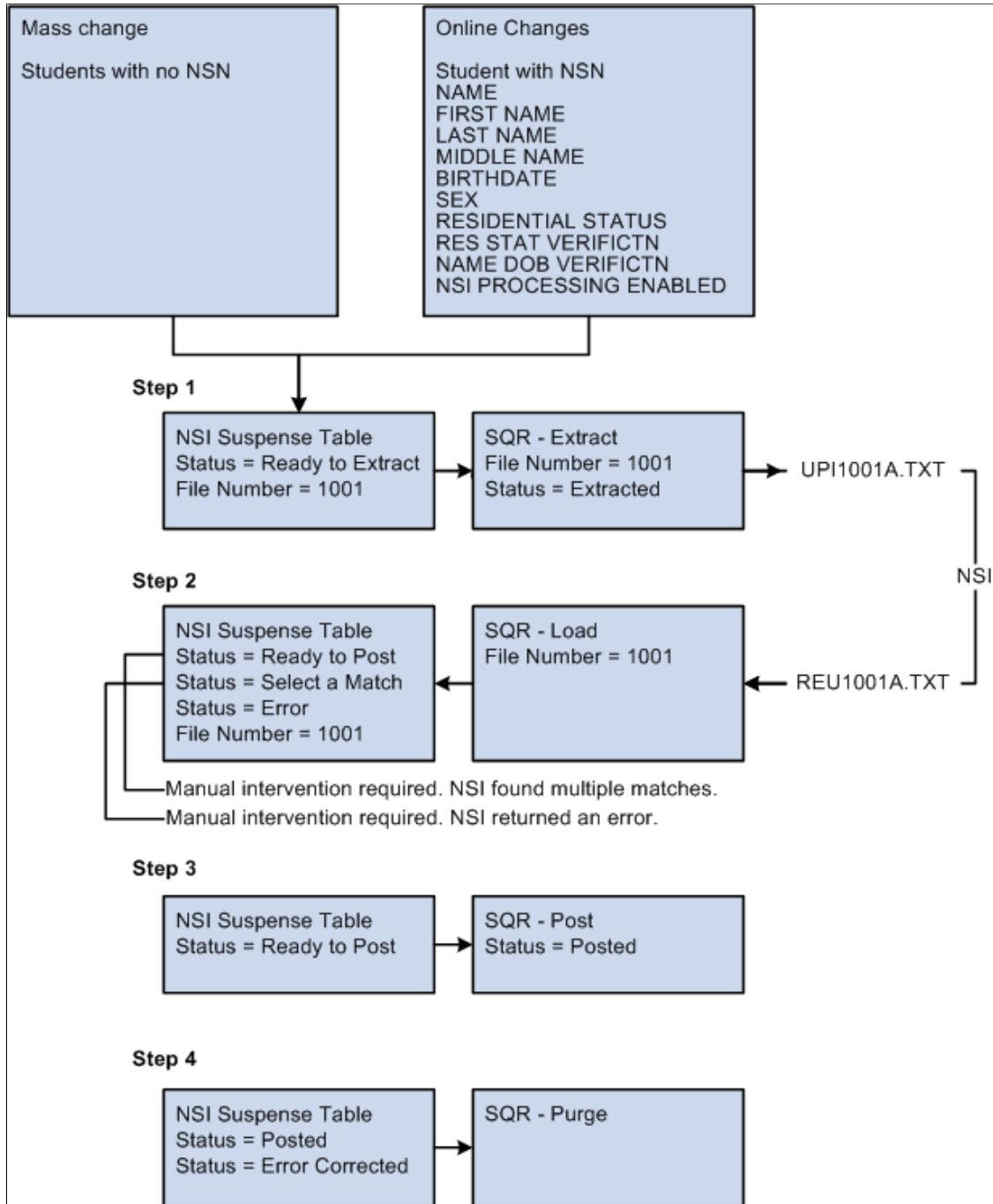

Related Links

[Understanding NSI Processing Setup](#)

Understanding NSI Fields

An NSI record includes the following fields. Fields marked as required are necessary to create an active NSI record for students. Name and date of birth are necessary to create a partial record.

NSI Field Name	PeopleSoft Field Name	Status/Description
NSN	SCC_NSN	Required.
Surname	LAST_NAME	Required. Name Type: Primary
Forename1	FIRST_NAME	Required. Name Type: Primary
Forename2	MIDDLE_NAME	Required. Name Type: Primary, first middle name.
Forename3	N/A	N/A
Preferred name indicator	SCC_PREF_NAME_IND	N/A
DoB (date of birth)	BIRTHDATE	Required.
Gender	SEX	N/A
NZQA paid (New Zealand Qualifications Authority paid)	SSR_NZQA_PAID	N/A
Residential Status	SCC_RESIDENTL_STAT	Required.
Record Status	SCC_STDNT_STAT_NSI	N/A
DoD (date of death)	DT_OF_DEATH	N/A
Alternate Surname	N/A	N/A
Alternate forename1	N/A	N/A
Alternate forename2	N/A	N/A
Alternate forename3	N/A	N/A
Alternate preferred name indicator	N/A	N/A
Name dob verification	SCC_NM_DOB_VERFCTN	N/A

<i>NSI Field Name</i>	<i>PeopleSoft Field Name</i>	<i>Status/Description</i>
Residential status verification	SCC_RES_ST_VERFCTN	N/A

Requesting NSNs

This section discusses how to:

- Identify individuals without NSNs.
- View outgoing suspense data.
- Extract data to send to NSI.
- Send the extract file.

Pages Used to Request NSNs

<i>Page Name</i>	<i>Definition Name</i>	<i>Navigation</i>	<i>Usage</i>
Request NSN	SCC_REQUEST_NSN	Campus Community > National Student Index NZL > Process NSI > Request NSN	Run the Request NSN process (CCNSIRQN) to identify prospects, applicants, and students who need an NSN or to purge results from a previous run.
Outgoing Data	SCC_SUSPENSE_NSI	Campus Community > National Student Index NZL > NSI Suspense	Review outgoing data before extracting it to send to the Ministry of Education.
Extract NSI Data	SCC_RUN_EXTRCT_NSI	Campus Community > National Student Index NZL > Process NSI > Extract NSI Data	Run the NSI Extraction process (CCNSIEXT) process to extract outgoing data to send to NSI.

Identifying Individuals Without NSNs

Important! Mass Change is a deprecated product. It is strongly recommended that you use Application Engine instead. For more information on PeopleSoft Application Engine, see *PeopleTools: Application Engine*.

Access the Request NSN page (**Campus Community** > **National Student Index NZL** > **Process NSI** > **Request NSN**).

The Request NSN process (CCNSIRQN) executes a mass change to identify individuals in your database that need NSNs or to purge results of a previous run of the process. The process writes (or in the case

of a purge, deletes) data for the resulting individuals on the Outgoing Data page of the NSI Suspense Table, giving them a status of *Ready for Extraction*. The process inserts records with the most current file number into the suspense table and selects the **Inserted by Mass Change** check box.

As the process copies the information from your database, it also selects (or in the case of a purge, clears) the **NSI Processing Enabled** check box on the individual's Regional page of the Add/Update a Person component. The **NSI Processing Enabled** check box sets the system to automatically report online changes made to an individual's NSI fields so that you can extract the most up-to-date data to send to the Ministry of Education.

Note: The **NSI Processing Enabled** check box on the Regional page of the Add/Update a Person component becomes unavailable once it is selected. The only time that a selected, unavailable check box becomes cleared and available is when the Request NSN process is run with the **Purge Mass Change Results** option selected to purge results of a mass change.

See [Adding or Updating Biographical Details Data](#).

Field or Control	Description
Applicant, Prospect, and Student	<p>Select the types of individuals for which you want to request NSNs from the NSI database. You can select one or more check boxes at the same time.</p> <p>When you run the process, the system copies appropriate biographical and regional data for each individual onto the Outgoing Data page of the Suspense NSI component in preparation for extracting and sending the data to NSI.</p> <p>See Adding an Individual to Your Database.</p>
Purge Mass Change Results	<p>Select to purge results of the Request NSN process (CCNSIRQN). When the process runs with the check box selected, the system removes all of the records added to the suspense table for the most current file number where Insert by Mass Change is selected and the suspense status is still <i>Ready for Extraction</i>. It also clears the NSI Processing Enabled check box on the Regional page for those records.</p> <p>If you ran mass change by mistake or with the wrong criteria set, you can use this to purge those records.</p> <hr/> <p>Note: To purge processed records from the suspense table, run the NSI Purge process (CCNSIPRG).</p> <hr/> <p>See Purging Suspense Data.</p>
Edit	<p>Click to modify the mass change criteria and regenerate the mass change.</p> <hr/> <p>Warning! We recommend that you generate mass changes prior to running the request process to ensure that the mass change process uses data as of the current date.</p> <hr/>

Viewing Outgoing Suspense Data

Important! Mass Change is a deprecated product. It is strongly recommended that you use Application Engine instead. For more information on PeopleSoft Application Engine, see *PeopleTools: Application Engine*.

Access the Outgoing Data page (**Campus Community > National Student Index NZL > NSI Suspense**).

This page is for viewing purposes only. You cannot enter data here.

The Outgoing Data page is populated with data from the Biographical Details and Regional pages when the Request NSN process (CCNSIRQN) runs.

When the **NSI Processing Enabled** check box is selected on the Regional page of the Add/Update a Person component and online changes are made to any NSI field for an individual, the system also automatically updates the Outgoing Data page. If the individual record is already included in the Outgoing Data page awaiting assignment of an NSN and a change to an NSI field is made, the system automatically updates the record with the changed data. If not, the system adds the record to the Outgoing Data page.

See [Entering Regional Specific Data](#).

Field or Control	Description
File Number	Displays the file number that was current when the student, applicant, or prospect's ID was added to the suspense table. See (NZL) Reviewing or Defining Default Installation Settings for National Student Index Processing .

Field or Control	Description
Status	<p>Indicates where the record is in the process.</p> <p>The status of <i>Ready for Extraction</i> is the initial status, and it is given when an ID is added to the NSI Suspense Table. The subsequent extract, load, post, and purge processes display the current status to indicate where the record is in the process.</p> <p>Values include:</p> <p><i>Ready for Extraction:</i> File is ready for extraction process. The Extract NSI Data process (CCNSIEXT) only extracts these records and data is included in the extract file to send to the Ministry of Education as part of the Update Insert Request (UPI Request).</p> <p><i>Extracted:</i> The extraction process has run and the UPI Request file is ready to send to the NSI or your institution is waiting to receive the result file</p> <p><i>Ready to Post:</i> The Result file is received from NSI and data is loaded in the suspense table by the Load NSI Data process (CCNSILOAD). Only one match is found in the NSI database and the individual record is now ready to post in the school database.</p> <p><i>Select a Match:</i> The Result file is received from NSI and data is loaded in the suspense table by the Load NSI Data process (CCNSILOAD). NSI returned multiple matches for the record sent in the UPI Request. You must manually select which match to use.</p> <p><i>Error:</i> The Result file is received from NSI and data is loaded in the suspense table by the Load NSI Data process (CCNSILOAD). An error occurred while NSI was processing the individual record. You must find the error and correct it.</p> <p><i>Error Corrected:</i> The Load NSI Data process (CCNSILOAD) returned an error, you corrected it, and selected the Error Corrected check box on the Incoming Data tab.</p> <hr/> <p>Note: The rows with the status <i>Error Corrected</i> are deleted from the suspense table the next time the Purge NSI Suspense Table process (CCNSIPRG) runs.</p> <p><i>Posted:</i> The Post NSI Data process (CCNSIPST) ran and the row is now ready to be purged from the suspense table. These are translate values and must not be changed.</p> <hr/>
Inserted by Mass Change	<p>The process selects this if the record was added to the suspense table through the mass change executed in the Request NSN process.</p>

Related Links

[Reviewing Incoming Suspense Data](#)

Extracting Data to Send to NSI

Access the Extract NSI Data page (**Campus Community > National Student Index NZL > Process NSI > Extract NSI Data**).

The NSI Extraction process (CCNSIEXT) extracts data with a status of *Ready for Extraction* from the Outgoing Data page of the NSI Suspense Table into a file ready to send to NSI. When the process completes, extracted records have a status of *Extracted*.

Field or Control	Description
Extract To	Enter the path to the directory where you want the process to place the extract file.
Generate New File	<p>Select to generate an extract file for the first time. The process extracts the data in the NSI suspense table with the most current file number assigned on the Extensions page of the Campus Community Installation component. The Extract NSI Data process (CCNSIEXT) uses the file number to create the file name.</p> <p>When the Extract NSI Data process (CCNSIEXT) finishes running, it increments by one, the file number on the Extensions page.</p> <p>See Page Used to Review or Define Campus Community Installation Settings.</p>
Regenerate Old File	<p>Select to regenerate a file. Once selected, the File Number field appears. Select the file number that you want to regenerate.</p> <p>You can only regenerate the files for which the data in the suspense table is in <i>Extracted</i> status. Files with data that has loaded or posted cannot be regenerated.</p>

Example: How the Extract NSI Data Process Works

If the current file number in the Extension page of the Installation Default CC component is 0001, the NSI Extraction process (CCNSIEXT) creates a file name of UPI0001a.txt where UPI is the code for the NSI process Update Insert Request. 0001 is the unique file number, "a" represents an alphabetic character used to split a file into more than one part if it includes more than 2,000 rows. The maximum number of rows per file recommended by the Ministry of Education is 2,000. A file with 5,500 rows is identified as follows:

- UPI0001a.txt – 2,000 rows
- UPI0001b.txt – 2,000 rows
- UPI0001c.txt – 1,500 rows

Note: If your file includes more than 52,000 characters rows (26 alphabetic letters times 2000 rows), you must manually give the remaining files a different name. The NSI Extraction process (CCNSIEXT) will create 26 files and will save the rest of the data into a file call UPIEXTRa.txt. Manually split this file to have no more than 2,000 rows in each of them. You can name the files using the same concept as the NSI Extraction process (CCNSIEXT) used. For example, UPIEXTRa.txt, UPIEXTRb.txt, etc. You will need to make sure you add the proper header and footer to the files you create.

Also, each time you must send a student's record to the Ministry of Education, the current file number is assigned to it. The next time the extract process runs, it extracts all the data for the students tied to the current file number. In the example above, the NSI Extraction process (CCNSIEXT) process creates a file named UPI0001a.txt and extracts data for all records with the assigned file number of 0001.

Every time the NSI Extraction process (CCNSIEXT) runs, the file number in the Installation CC Table increases by an increments of one. The next changes made to student, applicant, or prospect's record is associated with the next file number (0002) and the next extract file to run will create the UPI0002a.txt file.

Once the data is extracted, you can login to the Ministry of Education website and upload the extract file(s). Make sure you upload all the extract files created for a same file number. For example, if the NSI Extraction process (CCNSIEXT) created UP1000a.txt, UP1000b.txt and UP1000c.txt, it is your responsibility to verify if more than one file got created and to upload all of them to the NSI website. You must then monitor the site for the results file(s) that NSI will provide for you. Based on NSI requirements, if you sent a file called UPI0001a.txt, NSI will send the results file with a corresponding name: In this case it will be REU0001a.txt. REU means Result for UPI request, 0001a is the file identifier you used in your extract file, and txt is the delimited file format. In the case mentioned above, NSI will return the files called REU0001a.txt, REU0001b.txt and REU0001c.txt. It is again your responsibility to download all the result files for a same file number.

When you download result files from the NSI website, download them into one of your directories, for example c:\temp\.

If the extract process created only one file, for example UPI0001a.txt, after you download the results file for it (REU0001a.txt), you are able to load the results file (REU0001a.txt) directly into the NSI Suspense table by using the NSI UPI Load Process (CCNSILOAD).

If the extract process created more than one file, for example UPI1000a.txt, UP1000b.txt and UP1000c.txt, then you must merge the files before you can load them to the NSI Suspense table.

Warning! You should merge the files only if they have the same file number. For example UP1000a.txt, UP1000b.txt and UP1000c.txt have all the same file number, which is 1000. Merging files with different file numbers causes errors when you run the NSI UPI Load process (CCNSILOAD).

This example illustrates the fields and controls on the Example of multiple extracted files (same file number, but with alphabetical designator). You can find definitions for the fields and controls later on this page.

```

C:\TEMP>dir REU1000*.*
Volume in drive C is PS
Volume Serial Number is 70F6-1CFB

Directory of C:\TEMP

08/01/2002  12:03p           4,305 REU1000a.txt
08/01/2002  12:03p           3,886 REU1000b.txt
08/01/2002  12:03p           3,947 REU1000c.txt
08/01/2002  12:04p           3,690 REU1000d.txt
08/01/2002  12:04p           3,643 REU1000e.txt
08/01/2002  12:04p           4,459 REU1000f.txt
08/01/2002  12:05p           2,923 REU1000g.txt
08/01/2002  12:05p           3,062 REU1000h.txt
08/01/2002  12:05p           1,487 REU1000i.txt
          9 File(s)          31,402 bytes
          0 Dir(s)         30,434,816 bytes free

C:\TEMP>TYPE REU1000*.* > REU1000.txt
  
```

Once you process the command, you can review that the new file has been created.

This example illustrates the fields and controls on the Example of the merged file added with no alphabetical designator. You can find definitions for the fields and controls later on this page.

```

C:\TEMP>dir REU1000*.txt
Volume in drive C is PS
Volume Serial Number is 70F6-1CFB

Directory of C:\TEMP

08/01/2002  12:47p          31,402 REU1000.txt
08/01/2002  12:03p           4,305 REU1000a.txt
08/01/2002  12:03p           3,886 REU1000b.txt
08/01/2002  12:03p           3,947 REU1000c.txt
08/01/2002  12:04p           3,690 REU1000d.txt
08/01/2002  12:04p           3,643 REU1000e.txt
08/01/2002  12:04p           4,459 REU1000f.txt
08/01/2002  12:05p           2,923 REU1000g.txt
08/01/2002  12:05p           3,062 REU1000h.txt
08/01/2002  12:05p           1,487 REU1000i.txt
          10 File(s)         62,804 bytes
          0 Dir(s)         30,394,880 bytes free

C:\TEMP>
  
```

Use the name of the merged file to load data onto the Incoming Data page of the NSI Suspense table.

Sending the Extract File

Upload the UPI extract file (for example: UPI0001a.txt) to NSI from your server.

Consult the Ministry of Education website for instructions on how to upload files to NSI.

See www.minedu.govt.nz.

Receiving NSI Data

This section discusses how to:

- Download data from the NSI database.
- Loading results data.
- Review incoming suspense data.
- Post NSI data.

Pages Used to Receive NSI Data

<i>Page Name</i>	<i>Definition Name</i>	<i>Navigation</i>	<i>Usage</i>
Load NSI Data	SCC_RUN_LOAD_NSI	Campus Community > National Student Index NZL > Process NSI > Load NSI Data	Run the Load NSI Data process (CCNSILOD) to upload data from the NSI database onto the Incoming Data page of the NSI Suspense Table to review before posting it to your Campus Solutions database.
Incoming Data	SCC_UPDATES_NSI	Campus Community > National Student Index NZL > NSI Suspense > Incoming Data	Review NSI data received and temporarily stored data in the NSI Suspense Table before posting it to your database.
NSI Returned Data Details	SCC_UPDTES_NSI_SEC	Click the Details button on the Incoming Data page.	View additional details of information received from NSI.
Post NSI Data	SCC_RUN_POST_NSI	Campus Community > National Student Index NZL > Process NSI > Post NSI Data	Run the Post NSI Data process (CCNSIPST) to post data received from NSI.

Downloading Data from the NSI Database

After the Ministry of Education has processed your extract file, download the REU result file (for example: REU1001a.txt) from the NSI to your server.

Consult the Ministry of Education website for NSI result file instructions.

See www.minedu.govt.nz.

Loading Results Data

Access the Load NSI Data page (**Campus Community > National Student Index NZL > Process NSI > Load NSI Data**).

The Load NSI Data process (CCNSILOD) loads data from an NSI result file to the NSI Suspense Table. The load process writes the data to the Incoming Data page, giving each impacted record a status of *Ready to Post*, *Select a Match*, or *Error*.

Field or Control	Description
Import From	Enter the path to the directory where you downloaded the file from the NSI website.
File Name	Enter the name of the file to load.

You can load a file only after all rows in of the previous files have a status of *Posted*, *Error Corrected*, or *Error*.

Warning! The load process will not run if it finds previous files with rows marked *Extracted*, *Ready to Post*, or *Select a Match*. In the latter case, you must select a match and run the Post NSI Data process (CCNSIPST) before you can run the Load NSI Data process (CCNSILOD). This protects the load data that has not yet been processed.

You cannot load a file with a number out of sequence. You can load NSI results only for the oldest file number in the NSI Suspense Table with the status of *Extracted*. This prevents you from loading data for extract files that you sent to NSI more recently. Files that you send to NSI must be processed in sequential order. Use the file number in the NSI Suspense Table to identify which result file to load first.

For example, if files numbered 0008 and 0009 have a status of *Extracted* in the NSI Suspense Table, and you try to load file 0009 before 0008, the Load NSI Data process returns an error. You can extract multiple files with different numbers, but you must load them in numerical order. You must complete the process of loading a file before you can load the next file. That file must have only rows with the status of *Extracted*, *Loaded*, or *Posted* before you can load the next file.

If a file number exists with status rows of *Extracted*, *Ready to Post*, or *Select a Match*, and you try to load a file with a higher number, the SQR aborts and displays the error "You are trying to load File Nbr XXXX, but you have older file(s) that have not been POSTED yet." This prevents you from posting data from the file with the higher number before posting the file with a lower number.

Reviewing Incoming Suspense Data

Access the Incoming Data page (**Campus Community > National Student Index NZL > NSI Suspense > Incoming Data**).

The Incoming Data page is populated with data from NSI when the Load NSI Data process (CCNSILOD) runs.

Field or Control	Description
Status	<p>Indicates where the record is in the process. Status values here are the same as status values on the Outgoing Data page of the NSI Suspense Table component.</p> <p>See Viewing Outgoing Suspense Data.</p>
Row Type	<p>Indicates the type of row returned by NSI.</p> <p>The system displays different fields based on the row types returned. Row types include:</p> <p><i>M</i> (match): When only an <i>M</i> row is returned, the NSI did not find a match in its database, so it created a record and assigned an NSN. In this case the system selects the Match check box and sets the status to <i>Ready to Post</i>.</p> <p><i>S</i> (select a match): When an <i>M</i> row and one or more <i>S</i> rows are returned, NSI found possible matches. The system calculates and displays Match Indicator and Score values to help you determine which match to use.</p> <p>Click the Details button to view details of each row.</p> <p>If you determine that one of the <i>S</i> rows data is a match, select the Match check box for that row. The system changes the status to <i>Ready to Post</i>. When the Post NSI Data process runs, the process copies the information from this row to the Biographical Data component for the ID.</p> <p>If you determine that none of the <i>S</i> rows is a match for the individual, select the Match check box for the <i>M</i> row to confirm that this is the student who needs an NSN. The system changes the status to <i>Ready to Post</i>. When the Post NSI Data process runs, the process reinserts the record in the NSI Suspense Table with a status of <i>Ready for Extraction</i>.</p> <p>The record is reinserted and sent to NSI the second time because an <i>M</i> row, when accompanied by one or multiple <i>S</i> rows, has no NSN is associated. Instead, the NSI assigned an override code. The override code "reserves" an NSN. When NSI receives the individual's record a second time, it uses the override code to create the NSN. The override code is among the details displayed on the NSI Returned Data Details page.</p> <p><i>E</i> (error): When an <i>M</i> row and an <i>E</i> row are returned, the NSI database encountered an error. Click Details for a description of the error. (A list of possible errors is provided at the end of this section.) You must correct the error and then select the Corrected check box to change the status to <i>Error Corrected</i>.</p>

Field or Control	Description
Match Indicator	<p>Appears only when NSI returns a record with an <i>M</i> row and one or more <i>S</i> rows.</p> <p>Displays the name type on which the NSI system found a match in the NSI database.</p> <p>The values are <i>Main</i>, <i>Alternate</i>, <i>Merged</i>, and <i>Alt Merged</i>. These values are translate values and should not be modified.</p> <p>Always select a row that has a <i>Main</i> name. If not, you will load into your database as the Primary name, a name that NSI considers an alternate name in their database.</p>
Surname, Forename1, Forename2, Forename3, and Birthdate	<p>Displays the name data and the date of birth with which NSI created the record.</p>
Score	<p>Appears only when NSI returns a record with an <i>M</i> row and one or more <i>S</i> rows.</p> <p>Indicates the accuracy of the returned record. The NSI search software determines this score and it is based on how close the returned record is to the original search criteria. The closer the files are, the closer the score is to 100. However, a score of 100 doesn't guarantee that the data you sent has been perfectly matched in the NSI database. In the sample page, the name Jim Taylor was found and shows a score of 100. The birthdate is different. Therefore, it might be two different individuals.</p>
Details	<p>Click to access the NSI Returned Data Details page where you can review more details about that row.</p>
Match	<p>The system automatically selects this if the record is a perfect match, or if among multiple possible matches, one and only one <i>S</i> row is returned with a score of 100.</p> <p>If multiple <i>S</i> rows are returned with a score of 100, you must select this check box for the row that you want to post.</p> <p>When selected, the status changes to <i>Ready to Post</i>.</p> <p>The Post NSI Data process (CCNSIPST) posts the rows in the suspense table that have a <i>Ready to Post</i> status.</p>

Field or Control	Description
Corrected	<p>Appears only when NSI returns a record with one or more <i>E</i> (error) rows. A description of the error appears on the NSI Returned Data Details page. After you correct an error, select this check box to change the status to <i>Error Corrected</i> so that you can identify which errors you have corrected and which still need to be corrected. The Purge NSI Suspense Table process (CCNSIPRG) deletes rows in the suspense table with a status of <i>Error Corrected</i>.</p> <p>Also, by correcting an error in an NSI field on a record with the NSI Processing Enabled check box selected on the Regional page of the Add/Update a Person component, the system automatically inserts a new row in the NSI Suspense Table with the correct data and a status of <i>Ready for Extraction</i> so that the corrected data will be extracted to send to NSI the next time the extract process runs.</p> <hr/> <p>Note: In the case of a corrected error, the individual record appears in the suspense table twice—once with the status of <i>Error Corrected</i> and once with the status of <i>Ready for Extraction</i>. The file numbers, however, are different.</p> <hr/>

This page is for viewing purposes only. You cannot enter data here.

Field or Control	Description
Override Code	<p>An override code is returned only when NSI returns an <i>M</i> row with one or more <i>S</i> rows.</p> <p>If you select the <i>M</i> row to use, the individual needs to be sent a second time to the NSI to request the NSN. When the row is submitted again, NSI uses the override code to create the NSN. When the information is sent back to you, NSI will not include any <i>S</i> rows because you already confirmed the row to use for the NSN assignment.</p>

Field or Control	Description
Record Type	<p>Indicates the type of row that was returned by NSI.</p> <p><i>M</i> row details include the data that you sent to NSI and additional data received from NSI for that record. If an <i>M</i> row does not include an NSN, it could be because NSI found more than one individual who may be the same as the one requested.</p> <p><i>S</i> row details include data for a person who the NSI system has determined could be a match for the original data that you sent.</p> <p><i>E</i> row details include the error code. For example, the error code might indicate that the date of birth was not supplied to the NSI database.</p> <p>A common error is "Cannot replace verified data with unverified data." To correct this error, you must manually access the NSI website and copy the student name to your database and ensure that the correct NSN is entered. All other NSI data can be overwritten in your database (gender, date of birth, residential data, and verification fields).</p> <hr/> <p>Note: If the NSI database contains verified data for an individual, update your database with the NSI data. Because NSI is a central place to store student information, rely on the validity of the NSI data.</p> <hr/>

NSI Error Codes

This table lists the NSI decimal error codes and their descriptions. Consult the Ministry of Education and the GINS document if further information is required:

Value (Decimal)	Description
256	%1 is invalid.
257	Mandatory field(s) %1 were not supplied. Please enter values for the following fields: %1
258	Please supply an NSN(s).
272	Invalid character in name field.
273	Verification flag set without corresponding data.
274	Cannot replace verified data with unverified data.

Value (Decimal)	Description
275	Invalid Verification Flag.
276	Verification Flag cannot be set to BDM.
277	Cannot update BDM data without changing Verification Flag.
278	Hyphen and Apostrophe cannot be used without another character.
279	Cannot replace verified flag with unverified.
288	Invalid gender.
304	Invalid date format.
305	Date of Death must be later than Date of Birth.
306	Residential status is invalid.
309	Preferred name indicator is invalid.
320	Preferred name indicator is invalid.
321	Preferred name indicator set for more than one name.
336	Invalid NSN.
337	NSN does not exist.
339	Invalid Provider Code.
369	BDM Verified fields cannot be changed.
370	Cannot update an inactive student record.
409	Unexpected validation Error.

Value (Decimal)	Description
416	Incorrect File Format.
417	Incorrect Format for file footer record.
418	Incorrect Record Format.
421	Records in footer don't match the records in file.
512	Security Error: %1.
515	Organization is not valid for user.
516	First time access, please go to website to change password.
529	Access Denied.
640	General Security Failure.
665	SIA Failure: %1.
768	Unexpected Error %1.
817	Manual intervention required.
822	NSN records %1 have got NZQA paid flag set to Y or N.
848	Rollback denied - no slaves exist.
849	Failed to rollback the master record.
865	Missing User ID and/or Provider Code.
1282	NSN record has not been modified.

Related Links

[Viewing Outgoing Suspense Data](#)

Posting NSI Data

Access the Post NSI Data page (**Campus Community > National Student Index NZL > Process NSI > Post NSI Data**).

The Post NSI Data process (CCNSIPST) posts data with the status of *Ready to Post*, from the NSI Suspend Table to your PeopleSoft database. The process posts data on the Biographical, Regional, and Additional NSI Data pages. The process also changes the status to *Posted* for each record it successfully posted.

Warning! Before posting, for each record with a status of *Select a Match*, you must select a match to use by checking the **Match** check box for that row on the Incoming Data page of the suspend table.

Purging Suspend Data

This section discusses how to purge data from the NSI Suspend Table.

Page Used to Purge Suspend Data

<i>Page Name</i>	<i>Definition Name</i>	<i>Navigation</i>	<i>Usage</i>
Purge NSI Data	SCC_RUN_PURGE_NSI	Campus Community > National Student Index NZL > Process NSI > Purge NSI Suspend Table	Run the Purge NSI Suspend Table process (CCNSIPRG) to purge data from NSI Suspend Table.

Purging Data from the NSI Suspend Table

Access the Purge NSI Suspend Table page (**Campus Community > National Student Index NZL > Process NSI > Purge NSI Suspend Table**).

The Purge NSI Suspend Table process (CCNSIPRG) purges NSI data from the NSI Suspend Table. The process purges rows with a status of *Posted* and *Error Corrected* on the NSI Suspend Table component.

Processing Change Notifications

This section discusses how to:

- Download change notifications from NSI.
- Upload and post NSI change notifications.

Page Used to Process Change Notifications

<i>Page Name</i>	<i>Definition Name</i>	<i>Navigation</i>	<i>Usage</i>
NSI Change Notification	SCC_RUN_CHANGE_NSI	Campus Community > National Student Index NZL > Process NSI > NSI Change Notification	Run the NSI Change Notification process (CCNSICHG) to receive changes from NSI.

Downloading Change Notifications from NSI

Download the NSI Change Notification file (for example: REC12345.txt) from NSI to your server. You can then upload the file and post the changes from the change file to your database.

Note: You can manually download the NSI Change Notification file from the NSI website or have the NSI system automatically send the file directly to your institution.

Warning! NSI can provide two different formats for change notification result files: delimited text file and XML. The PeopleSoft batch process accepts only delimited text files. Contact NSI to let them know that you use delimited text files – .txt. If you do not notify them, NSI might send you result files in XML format and you will not be able to load the data in your PeopleSoft database.

Consult the [Ministry of Education website](#) for NSI Change Notification instructions.

Every four months, the Ministry of Education performs an update of the *active at* links from data reported in Single Data Returns (SDRs) and produces an NSI Change Notification file.

The Ministry of Education reports changes made to the following fields: **First Name, Middle Name, Last Name, Date of Birth, Gender, Data of Death, NSI Record Status, Residential Status, Residential Status Verification, Name/DOB Verification, NZQA Paid, Preferred Name Indicator, Last Modified by Provider Code, Last Modified Date, or Changed Field Indicator.**

The NSI uses the Change Notification process to send your institution any changes made to NSI student records that are marked as *active at* your school. When a school adds or updates an NSI student record, that student becomes *active at* that school. The Change Notification process notifies any *active at* schools when changes are made to an NSI record. Change notifications applicable to your school are available for viewing on the NSI website. For example, if NZQA advises that a student has paid his ROL registration fee, all the schools at which the student is recorded as *active at* are notified.

If an individual dies, the change notification process is used to inform all schools that are recorded in the NSI system as having an association with that student.

Uploading and Posting NSI Change Notifications

Access the NSI Change Notification page (**Campus Community** > **National Student Index NZL** > **Process NSI** > **NSI Change Notification**).

The NSI Change Notification process (CCNSICHG) uploads data from an NSI Change Notification file and posts the changes directly to records and fields in your database. The data is not written to the suspense table.

Warning! If the NSI Change Notification process (CCNSICHG) encounters any problems loading the data, it will not abort. You must always review the process log to see what errors the process may have encountered.

Field or Control	Description
Import From	Enter the path to the directory where you downloaded the RECxxxx.txt file from the NSI website.
File Name	Enter the file name that contains the data to post. NSI uses the following naming convention for change notifications: REC12345.txt, where RE means results, C means change notification and 12345 are 5 numbers to differentiate the files sent to schools. The extension .txt indicates that the file is a delimited text file.

This table lists the PeopleSoft records and fields that can be updated from a delimited NSI Change Notification file.

Record Name	Field Name
NAMES	FIRST_NAME
NAMES	MIDDLE_NAME
NAMES	LAST_NAME
PERSON	BIRTHDATE
PERS_DATA_EFFDT	SEX
PERSON	DT_OF_DEATH
SCC_PERSONL_NZL	SCC_STDNT_STAT_NSI
SCC_PERSONL_NZL	SCC_RESIDENTL_STAT
SCC_PERSONL_NZL	SCC_RES_ST_VERFCTN
SCC_PERSONL_NZL	SCC_NM_DOB_VERFCTN
SCC_PERSONL_NZL	SSR_NZQA_PAID
SCC_NSI_ADLCHG	SCC_PREF_NAME_IND

Record Name	Field Name
SCC_NSI_ADLCHG	SCC_MODIFIED_DATE
SCC_NSI_ADLCHG	SCC_CHGD_FIELD_IND
SCC_NSI_ADLCHG	SCC_PROVIDER_CODE

Reviewing Additional NSI Data

This section discusses how to review additional NSI data.

Page Used to Review Additional NSI Data

Page Name	Definition Name	Navigation	Usage
NSI Additional Data	SCC_ADDL_DATA_NSI	Campus Community > National Student Index NZL > NSI Additional Data	View additional data sent by NSI.

Reviewing Additional NSI Data

Access the NSI Additional Data page (**Campus Community > National Student Index NZL > NSI Additional Data**).

Additional data received from NSI appears on the NSI Additional Data page. Different data appears depending on whether the Post NSI Data process or the NSI Change Notification process was run.

Field or Control	Description
Last Modified Date	Displays the date when another school (or provider) updated the NSI database for this individual. Because PeopleSoft does not maintain history of the changes made through the Change Notification process, the system displays only the last date on which a change was made.
Last Modified by Provider Code	Displays the name of the school (or provider) that made the changes.
Master NSN	Displays the main NSN for this individual. Because merges can be made in the NSI database, NSI always keeps track of the main NSN assigned to a student.

<i>Field or Control</i>	<i>Description</i>
Changed Field Indicator	Indicates what data has been changed.

Chapter 50

Managing Health Information

Understanding Health Information

You can track health and medical exam data for every individual in your database.

Prerequisites

Before you can enter health data, you must set up health data codes and tables.

For example, see:

[Setting Up Diagnosis Codes](#)

[Setting Up Physicians](#)

[Setting Up for Processing Accommodations](#)

Common Elements Used in Managing Health Information

<i>Field or Control</i>	<i>Description</i>
Baseline	Select this check box to indicate that the current examination is the baseline examination for tracking the individual's physical condition over time.
Country	The country of the physician's address. When the Physician ID field is entered, and you select the country and exit the Country field, the system displays the physician's address (from the Physician Table - Address page) based on the specified country. If the individual does not have a physician ID in your system, enter his or her address here.
Date Received	Enter the date that you received or are entering the information about the test or event.
Date Taken	Enter the date that the individual took the test or immunization or completed the event.
Does Not Apply	Select this option to indicate that the test or event is not relevant for this individual.

Field or Control	Description
Exam Date	The date on which the exam was administered. The default exam date is the system's current date. You can override this date.
Exam Type	Select the type of exam for this individual (for example, general health, annual, drug-screening, or fit for duty). Values for this field are delivered with your system as translate values. You can modify these translate values.
Expiration Date	Enter the date that the effectiveness of the test or immunization or event will expire.
Next Exam	The date on which this individual should be reevaluated. The system calculates and displays this date based on the examination type that you specify. You can override the calculated date. The system calculates the dates based on these values: <i>Annual:</i> One year later. <i>Exposure:</i> Six weeks later. <i>Periodic Surveillance:</i> Six months later.
Physician	The name of the physician or other specialist who administered the exam. When you enter the physician ID, the system displays the individual's name. If the individual does not have a physician ID in your system, you must enter his or her name here (or go to the Physician Table - Name page, add the name, and return to this page).
Physician ID	Enter the ID of the physician or other medical professional (from the Physician Table - Name page) who administered the exam.
Referral	Select the place or people to which this individual is referred for further examination or treatment. Values for this field are delivered with your system as translate values. You can modify these translate values.
Test Not Taken	Select this option to indicate that the individual has not taken the test or has not completed the event.
Test Taken	Select this option to indicate that the individual has taken the test or has completed the event.

Tracking Audiometric Exam Data

You can enter and track basic information about hearing tests for individuals in your database, including exam dates and results, exam administrator, and reevaluation date.

This section discusses how to:

- Enter audiometric exam address and phone data.
- Enter audiometric exam details.

Pages Used to Track Audiometric Exam Data

<i>Page Name</i>	<i>Definition Name</i>	<i>Navigation</i>	<i>Usage</i>
Audio Exam Addr/Phone (audiometric exam address/ phone)	SCC_HS_EXAM_AUDIO1	Campus Community > Personal Information > Health Information > Health Exams > Audiometric Exam > Audiometric Exam Addr/ Phone	Enter the examiner's address and phone data and the date and type of audiometric exam administered.
Exam Details (Audiometric)	SCC_HS_EXAM_AUDIO2	Campus Community > Personal Information > Health Information > Health Exams > Audiometric Exam > Exam Details	Enter audiometric exam details, including results, referrals, and comments.

Entering Audiometric Exam Address and Phone Data

Access the Audio Exam Addr/Phone page (**Campus Community** > **Personal Information** > **Health Information** > **Health Exams** > **Audiometric Exam** > **Audiometric Exam Addr/Phone**).

Enter information to describe the type of exam.

Entering Audiometric Exam Details

Access the Exam Details (Audiometric) page (**Campus Community** > **Personal Information** > **Health Information** > **Health Exams** > **Audiometric Exam** > **Exam Details**).

<i>Field or Control</i>	<i>Description</i>
Audiometer Serial #	The serial number of the audiometer that is used to administer this exam.

Field or Control	Description
Decibels	For each ear, enter the decibel level at which the individual hears the specified frequency.
Trouble Frequency	Select to indicate that the individual did not hear this frequency within the appropriate decibel range.
Hearing Classification	Select the classification that describes the results of this exam. Values are <i>Abnormal</i> , <i>Shift</i> , <i>Early Loss Indication</i> , and <i>Normal</i> . Values for this field are delivered with your system as translate values. You can modify these translate values.
Comment	Enter comments to further identify or describe the results of this individual's exam or the specialist to whom the individual is referred.

Tracking Eye Exam Data

You can enter and track basic information about visual acuity exams, including exam date, exam administrator, and whether the individual needs corrective lenses.

This section discusses how to enter eye exam details.

Pages Used to Track Eye Exam Data

Page Name	Definition Name	Navigation	Usage
Eye Exam Addr/Phone (eye exam address/phone)	SCC_HS_EXAM_EYE1	Campus Community > Personal Information > Health Information > Health Exams > Eye Exam > Eye Exam Addr/Phone	Enter the examiner's address and phone data, and the date and type of eye exam administered.
Exam Details	SCC_HS_EXAM_EYE2	Campus Community > Personal Information > Health Information > Health Exams > Eye Exam > Exam Details	Enter eye exam details, including results, referrals, and comments.

Entering Eye Exam Details

Access the Exam Details page for eye exams (**Campus Community** > **Personal Information** > **Health Information** > **Health Exams** > **Eye Exam** > **Exam Details**).

Far Sight or Near Sight

<i>Field or Control</i>	<i>Description</i>
Corrected and Uncorrected	For each eye, enter the visual acuity with and without corrective lenses.
Correction Required	Select to indicate that this individual needs lenses or other corrective treatment.

Color Vision

<i>Field or Control</i>	<i>Description</i>
Normal or Abnormal	Select one of these options to indicate whether the individual's color perception is normal or abnormal.

Tracking Physical Exam Data

You can enter and track basic information physical examinations for individuals in your database, including exam dates and types and who administered the exam. You can also enter an individual's donor information, blood type, referrals, and other comments.

This section discusses how to enter physical exam details.

Pages Used to Track Physical Exam Data

<i>Page Name</i>	<i>Definition Name</i>	<i>Navigation</i>	<i>Usage</i>
Physical Exam Addr/Phone (physical exam address/ phone)	SCC_HS_EXAM_PHYS1	Campus Community > Personal Information > Health Information > Health Exams > Physical Exam > Physical Exam Addr/Phone	Enter the examiner's address and phone data and the date and type of the physical exam.
Exam Details	SCC_HS_EXAM_PHYS2	Campus Community > Personal Information > Health Information > Health Exams > Physical Exam > Exam Details	Enter details about the exam, including results, donor information, blood type, referrals, and comments.

Entering Physical Exam Details

Access the Exam Details page for physical exams (**Campus Community > Personal Information > Health Information > Health Exams > Physical Exam > Exam Details**).

<i>Field or Control</i>	<i>Description</i>
Organ Donor and Blood Donor	Select to indicate whether this individual is or wants to be an organ donor or a blood donor.
Blood Type	Enter this individual's blood type. Values for this field are delivered with your system as translate values. You can modify these translate values.
Referral and Name	Enter the type of professional and name of the person to contact at the place of referral.
Comment	Enter comments to further identify or describe the results of this individual's exam or the specialist to whom the individual is referred.

Tracking Respiratory Exam Data

You can enter and track basic information about respiratory examinations for individuals in your database, including exam dates, types, and results; who administered the exam and when the individual should be reevaluated.

This section discusses how to enter respiratory exam details.

Pages Used to Track Respiratory Exam Data

<i>Page Name</i>	<i>Definition Name</i>	<i>Navigation</i>	<i>Usage</i>
Respiratory Exam Addr/ Phone (respiratory exam address/phone)	SCC_HS_EXAM_RESP1	Campus Community > Personal Information > Health Information > Health Exams > Respiratory Exam > Respiratory Exam Addr/ Phone	Enter the examiner's address and phone data, and the date and type of respiratory exam.
Exam Details	SCC_HS_EXAM_RESP2	Campus Community > Personal Information > Health Information > Health Exams > Respiratory Exam > Exam Details	Enter the respiratory exam details, including results, referrals, and comments.

Entering Respiratory Exam Details

Access the Exam Details page for respiratory exams (**Campus Community > Personal Information > Health Information > Health Exams > Respiratory Exam > Exam Details**).

Note: The Smoker check box is not used in Campus Solutions.

<i>Field or Control</i>	<i>Description</i>
Date of Exposure	The date when this individual was exposed to the contaminant, causing the need for this exam.
Exposure Type	Enter the type of exposure that the individual endured (for example, biohazard, chemicals, or dust). Values for this field are delivered with your system as translate values. You can modify these translate values.
Contaminant Agent	Enter the specific contaminant to which the individual was exposed (for example, asbestos, lead, or Mercury).
Business Unit	Select the business unit or department that was responsible at the time of the exposure or contamination
Location Code	Select the location where the contamination took place.
Name	Enter the name of the person to contact at the place of referral.
Comment	Enter comments to further identify or describe the results of this individual's exam or the specialist to whom the individual is referred.

Processing Accommodations

Use accommodation codes to track the types of accommodations that your institution is requested or required to make and to track the changes that your institution approves and who is responsible for making them. You can enter data to track the requests for special accommodations and enter diagnosis codes for the disabilities that require the accommodation request. You can also enter various options that your institution might have in response to a request.

This section lists prerequisites and discusses how to:

- Enter accommodation requests.
- Enter accommodation options.
- Enter accommodation job tasks.

Prerequisites

Before entering and tracking accommodation data, you must:

- Set up codes for types of accommodations.
- Define diagnosis codes to help identify reasons for the accommodation.
- Define regulatory regions.
- Set up business units, job codes, job locations, and job code tasks.

Related Links

[Setting Up for Processing Accommodations](#)

[Setting Up Diagnosis Codes](#)

[Setting Up and Reviewing Regulatory Regions](#)

Pages Used to Process Accommodations

<i>Page Name</i>	<i>Definition Name</i>	<i>Navigation</i>	<i>Usage</i>
Accommodation Request	SCC_ACCOMM_REQUEST	Campus Community > Personal Information > Health Information > Accommodation Data > Accommodation Request	Enter and track an individual's accommodation request.
Accommodation Option	SCC_ACCOMM_OPTION	Campus Community > Personal Information > Health Information > Accommodation Data > Accommodation Option	Enter and track options for an accommodations request.
Accommodation Job Task	SCC_ACCOMM_JOB_TSK	Campus Community > Personal Information > Health Information > Accommodation Data > Accommodation Job Task	Enter and track the employee location and job task that is accommodated by honoring the request.

Entering Accommodation Requests

Access the Accommodation Request page (**Campus Community > Personal Information > Health Information > Accommodation Data > Accommodation Request**).

Accommodation Request Details

<i>Field or Control</i>	<i>Description</i>
Accommodation ID	<p>The number of this request on the list of this individual's accommodation requests.</p> <p>The system displays the next sequential number for each accommodation request that you add. You can override the number to reorder the list of accommodation requests.</p>
Date of Request	The date of this accommodation request. The default date is the system's current date, which you can override.
Comment	Enter comments that further identify the accommodation request for this individual.
Responsible ID	Enter the ID of the individual at your institution who is managing this request.
Pending, Accepted, or Undue Hardship	Select one of these options to indicate whether the request is pending, evaluated and accepted, or evaluated and denied due to an undue hardship on the department or institution.
Request Status Date	Enter the date that the request was changed to a status of pending, accepted, or denied.

Disability

<i>Field or Control</i>	<i>Description</i>
Regulatory Region	Enter the code for the country whose regulations apply to this request.
Diagnosis Code	Enter the diagnosis code (from the Diagnosis Table page) that describes the illness or disability for which accommodations have been requested.
Description	Displays the description that is associated with the diagnosis code that you entered.

Entering Accommodation Options

Access the Accommodation Option page (**Campus Community > Personal Information > Health Information > Accommodation Data > Accommodation Option**).

Accommodations/Alternatives

<i>Field or Control</i>	<i>Description</i>
Option ID	The system displays the number of this option request in the list of options for this accommodation request. The system displays the next sequential number for each option that you add. You can override the number to reorder the list of options.
Employer Suggested Option	Select this check box to indicate that a staff person at your institution suggested this option.
Currency Code	Enter the currency in which the cost is expressed.
Type	Enter the type of accommodation (from the Accommodation Type Table page) that is recommended as part of this option.
Cost	Enter the cost of this type of accommodation.
Description	Enter comments to further describe or identify the item or service suggested in this option.
Accommodation Status and Status Date	Enter the status of this option (such as accepted, approved, consider, offered, or rejected), and the date of the status.

Entering Accommodation Job Tasks

Access the Accommodation Job Task page (**Campus Community > Personal Information > Health Information > Accommodation Data > Accommodation Job Task**).

Identifying Regional Impairment and Support Services

Identify an individual's disability and indicate if support services are requested.

Page Used to Identify Regional Impairment and Support Services

<i>Page Name</i>	<i>Definition Name</i>	<i>Navigation</i>	<i>Usage</i>
Impairment Regional	SCC_IMPAIR_DTL	Campus Community > Personal Information > Health Information > Impairment Regional > Impairment Regional Campus Community, Personal Information (Student), Health Information (Student), Impairment Regional, Impairment Regional	Identify an individual's disability and indicate if support services are requested.

Entering Impairment Data

Access the Impairment Regional page (**Campus Community > Personal Information (Student) > Health Information (Student) > Impairment Regional > Impairment Regional**).

Use this page to indicate information about an individual's disability, particularly about whether or not support services have been requested.

<i>Field or Control</i>	<i>Description</i>
(NZL) Disability Services NZL	Indicate whether a student has accessed disability services and the year in which the services were accessed. This group box is available only when the NSI and SDR Personal Data, SDR Degree check box is selected on the SA Features page (Student Admin Installation).

Tracking Immunizations and Health Tests Data

Use codes in your system to enter and track an individual's immunization and general health test data.

This section lists prerequisites and common elements and discusses how to:

- Enter immunization data.
- Enter health test data.

Prerequisites

Before you enter and track immunization and health data, define immunization codes, health test codes, and diagnosis codes.

Related Links

[Setting Up Immunization and Health Test Types](#)

[Setting Up Diagnosis Codes](#)

Common Elements Used in This Section

<i>Field or Control</i>	<i>Description</i>
Comments	Enter comments to further identify or describe the immunization or health test.
Criteria Number	The criteria number for the immunization or health test.

Pages Used to Track Immunization and Health Data

<i>Page Name</i>	<i>Definition Name</i>	<i>Navigation</i>	<i>Usage</i>
Immunization	IMMUNIZATION	Campus Community > Personal Information > Health Information > Immunizations and Health > Immunization	Enter immunization data for an individual.
Health Test	HEALTH_TEST	Campus Community > Personal Information > Health Information > Immunizations and Health > Health Test	Enter or review data from an individual's health test.

Entering Immunization Data

Access the Immunization page (**Campus Community > Personal Information > Health Information > Immunizations and Health > Immunization**).

Immunizations

<i>Field or Control</i>	<i>Description</i>
Immunization	Enter the immunization, from the Immunization Table page, that this individual has received.

<i>Field or Control</i>	<i>Description</i>
Immunization Number	<p>The number of this immunization on the list of immunizations for this individual.</p> <p>The system displays the next sequential number for each immunization that you add. You can override the number to reorder the list of immunizations.</p>
Immunization Status	<p>Select the status of this immunization, such as complete, not on file, or partial.</p> <p>Values for this field are delivered with your system as translate values. Do not modify these values in any way. Any modifications to these values could require substantial programming effort.</p>

Immunization Criteria

When criteria are associated with this immunization on the Immunization Table page, the system displays the criteria data in this group box.

Entering Health Test Data

Access the Health Test page (**Campus Community > Personal Information > Health Information > Immunizations and Health > Health Test**).

Health Test

<i>Field or Control</i>	<i>Description</i>
Health Test	Select the health test, from the Health Test Table page, that this individual has taken.
Health Test Number	<p>The number of this health test on the list of health tests for this individual.</p> <p>The system displays the next sequential number for each health test that you add. You can override the number to reorder the list of health tests.</p>
Test Value	Enter the test result value, in alphabetic, numeric, percentage, or other form, as expressed by the medical community (for example, AB or O for blood type; or 177 for cholesterol).

<i>Field or Control</i>	<i>Description</i>
Test Result	<p>Select the overall test result. Values are:</p> <p><i>Negative</i></p> <p><i>Neutral</i></p> <p><i>Positive</i></p> <p>Values for this field are delivered with your system as translate values. Do not modify these values in any way. Any modifications to these values could require substantial programming effort.</p>

Health Test Criteria

When criteria are associated with this health test on the Health Test Table page, the system displays the criteria data in this group box.

Chapter 51

Managing Personal Identification Data

Understanding Personal Identification Data

You can scan photos and enter driver's license data in your database to help you identify and recognize individuals at your institution.

Your institution might require an individual's driver's license number and the state from which the license was issued. Your institution might also want to know if the driver's license is valid and how many violations and points are on driver's record. Driver's license and driver's record information might be considered when issuing parking permits, granting the use of departmental vehicles, or maintaining carpools.

You can upload photos to your database to help identify individuals. Use your institution's image importing method to place the image in a file on your computer and save it in *JPEG* format. Then, using the Photo page, you can upload that image to the individual's record in your database.

You can track the official and self-reported residency of individuals at your institution. You can also enter data for residency appeals.

You can also enter and track IDs from external systems and correlate them to individuals or organizations in PeopleSoft Campus Solutions. For example, if your institution uses a separate housing database, you could identify the individual's housing ID.

Use the Personal Identification Number page to assign PINs to individuals as required at your institution. For example, if your institution uses a separate housing database and individuals need a PIN to access their own housing information, you can assign that here.

Using the Citizenship pages, you can enter multiple countries of citizenship and multiple passports for individuals, and track their visa and permits data.

Note: (USA) Use PeopleSoft Patriot Act SEVIS Solutions (PASS) visa processing functionality to track foreign students and exchange visitors and their dependents as required by the U.S. Department of Homeland Security (DHS).

See [Understanding SEVIS Visa Processing](#).

Entering Citizenship Data

This section provides overviews of citizenship and passport data and visa and permit data, and discusses how to:

- Enter citizenship and passport data.

- Enter visa and permit data.

Understanding Citizenship and Passport Data

An important component of the data that you must track for students or employees who travel internationally to or from your institution is passport and citizenship information. Using the Citizenship/Passport Data pages, you can enter multiple countries of citizenship and multiple passports for individuals.

Using the country codes and citizen status codes in your system, you can identify an individual's country of citizenship, the current status of that citizenship, when citizenship was issued, and when citizenship expires.

Understanding Visa and Permit Data

If your institution admits foreign students or hires individuals who are not citizens of the country where your institution is located, you should set up codes that classify the types of visas and permits required by the appropriate governments.

Using the Supporting Document Table page, you can set up document codes to identify birth certificates, letters of employment, immigration application letters, and other documents required to obtain I-9 verification for individuals attending your institution.

Each country has its own regulations for permitting foreign employees to work, visit, or reside there. To track information about the visas and permits required for individuals to work at, visit, or attend your institution, use the Visa/Permit Data page.

You can also use your system to prepare visa forms. You can enter data for DS-2019 forms for international applicants, students, professors, and visitors who need a J1 Visa. You can also prepare and print I-20 forms for international students who are admitted to or currently enrolled in your institution and who need an F1 Student Visa.

Prerequisites

Before entering citizenship data for an individual, you must define levels of citizenship status for each country and visa and permit types.

Related Links

[Defining Citizen Status Codes](#)

[Defining Visas and Permits](#)

Pages Used to Enter Citizenship Data

<i>Page Name</i>	<i>Definition Name</i>	<i>Navigation</i>	<i>Usage</i>
Citizenship/Passport	LS_CITIZEN_PASSPRT	Campus Community > Personal Information > Identification > Citizenship > Citizenship and Passport	Enter citizenship and passport data for an individual.
Visa/Permit Data	SCC_VISA_PERMIT	<ul style="list-style-type: none"> Campus Community > Personal Information > Identification > Citizenship > Visa/Permit Data Click the Visa/Permit link on the Biographical Details page. 	Enter and track an individual's visa and permit information.
Visa/Permit NLD	SCC_VISA_PMT_NLD	Campus Community, Personal Information, Identification, Citizenship, Visa/Permit Data NLD	
Port of Entry	SEV_POE_DATA	Campus Community > Personal Information > Identification > Citizenship > Visa Permit Data > Port of Entry Data	Enter information to identify the individual's entry point into the area.
DS-2019	DS2019_FORM1 DS2019_FORM2 DS2019_FORM3 DS2019_FORM4 DS2019_FORM5 DS2019_FORM6 DS2019_FORM7	Campus Community > SEVIS > DS-2019 Forms > DS-2019 Form	Enter data for preparing DS-2019 forms for an international applicant, student, professor, or visitor who needs a J1 visa.

Page Name	Definition Name	Navigation	Usage
I-20	I20_FORM1 I20_FORM2 I20_FORM3 I20_FORM4 I20_FORM5 I20_FORM6 I20_FORM7	Campus Community > SEVIS > I-20 Forms > I-20 Form	Enter data for preparing I-20 forms for an international student who is admitted to or currently enrolled in your institution and who needs an F1 visa.

Entering Citizenship and Passport Data

Access the Citizenship/Passport page (**Campus Community > Personal Information > Identification > Citizenship > Citizenship and Passport**).

Citizenship/Passport

Field or Control	Description
Country	Specify the country of the individual's citizenship.
Citizenship Status	Specify the status (for example, native, naturalized, or alien permanent) of this individual's citizenship in the specified country. These status values are from the Citizen Status Table page.

Passport Information

Field or Control	Description
Passport Number	Enter the number from the individual's official passport.
Issue Date	Enter the official issuance date that is stamped on the passport.
Expiration Date	Enter the official expiration date that is stamped on the passport.

Field or Control	Description
Country	Specify the country where the passport was issued. Additional location fields appear based on the country that you select, so that you can provide additional location details, such as city and state or province.
Authority	Enter the name of the agency or authority that issued the passport.
Comment	Enter comments to further describe the individual's citizenship, passport, or nature of the issuance of the passport.

Entering Visa and Permit Data

Use these pages to enter Visa and Permit data.

Visa/Permit Data

Access the Visa/Permit Data page (**Campus Community > Personal Information > Identification > Citizenship > Visa Permit Data**).

Note: This is the page to which you are transferred when you click **Visa/Permit Data** on the Biographical Details page.

Field or Control	Description
Country	Specify the issuing country for the individual's visa or permit.
Type	Select the type of visa or permit, from the Visa/Permit Table page. The available types are based on the country specified.
Classification	Displays the classification based on the type of visa or permit selected.
Effective Date	Enter the date on which the visa or permit is effective or the date on which the information should become effective in your database.
Number	Enter the issuance number from the individual's official visa or permit.

Field or Control	Description
Status	<p>The status of the official visa or permit (for example <i>Applied</i>, <i>Granted</i>, <i>Renewal</i>, or <i>Renewed</i>).</p> <p>Values for this field are delivered with your system as translate values. Do not modify these values in any way. Any modifications to these values could require substantial programming effort.</p>
Status Date	Enter the date of the status. The default status date is the system's current date. You can override this date.
Duration	<p>Specify the length of time during which the visa or permit is valid. Enter the number in the first field, and in the second field specify the period, such as days, months, terms, or years.</p> <p>Values for the second field are delivered with your system as translate values. You can modify these translate values.</p>
Issue Date	Enter the date of issuance from the individual's official visa or permit.
Date of Entry into Country	Enter the official date on which the individual entered your institution's country.
Expiration Date	Enter the date on which this individual's visa or permit expires. The system calculates the expiration date based on the specified duration and the date of entry into the country. You can override the system-calculated date.
Issuing Authority	Enter the name of the agency or authority that issued the official visa or permit.
Issue Place	Enter the name of the location where the official visa or permit was issued.
Supporting Document ID	Select the supporting documents that are required for this type of visa or permit.
Get Supporting Documents	Click this button to retrieve the supporting document IDs and descriptions from the Visa/Permit Table page for this visa or permit type.

<i>Field or Control</i>	<i>Description</i>
Request Date	Enter the date on which your institution requests the supporting document.
Date Received	Enter the date on which your institution receives the supporting document.

Visa/Payment Data NLD

Access the Visa/Permit Data page (**Campus Community > Personal Information > Identification > Citizenship > Visa Permit Data NLD**).

<i>Field or Control</i>	<i>Description</i>
Estimated Status Date	Enter an Estimated Status Date if the Status Date is unknown. Field format must be YYYY-MM-DD or YYYY-00-00 or YYYY-MM-00.
Estimated Expiration date	Enter an Estimated Expiration Date if the Expiration Date is unknown. Field format must be YYYY-MM-DD or YYYY-00-00 or YYYY-MM-00.
Document for Studielink	Select this check box to send this document to Studielink.
Unknown Date	Select this check box if the start date for this document is unknown.

Entering Driver's License Data

This section discusses how to enter driver's license data.

Page Used to Enter Driver's License Data

<i>Page Name</i>	<i>Definition Name</i>	<i>Navigation</i>	<i>Usage</i>
Driver's License Information	DRIVERS_LIC_SA	Campus Community > Personal Information > Identification > Driver's License Data	Enter license numbers and driving record information.

Entering Driver's License Data

Access the Driver's License Information page (**Campus Community** > **Personal Information** > **Identification** > **Driver's License Data**).

License Detail

<i>Field or Control</i>	<i>Description</i>
Driver's License # (driver's license number)	The number from the individual's driver's license.
Country	The country in which the license was issued.
State	The state in which the license was issued.
Issue Location	The location where the license was issued. For example, this can be the street address, the city, the county, or whatever your institution decides.
Issuing Authority	The authority or agency that issued the license. For example, this can be the name of the motor vehicle agency.
Valid from	The date that the license became effective, which is usually the issuing date.
Expiration Date	The date that the license expires.
Valid from/to	The dates for which the license is valid, which is usually the issuing date and the expiration date.
Number of Violations	The number of traffic violations on record for this individual.
Number of Points	The number of points on record for this individual.
License Suspended	Select this check box to indicate that this individual's driver's license is currently suspended.
Comment	Enter information to further identify or describe this individual's driver's license or driver's record.

<i>Field or Control</i>	<i>Description</i>
License Type	<p>The type of driver's license, such as car, chauffeur, class C, motorcycle, or truck, that is issued to this individual under the specified license number. Add a new license if the license number is different.</p> <p>Values for this field are delivered with your system as translate values. You can modify these translate values.</p>

Entering Residency Data

This section provides an overview of residency data and discusses how to:

- Enter official residency data.
- Entering official residency location details.
- Enter self-reported residency data.
- Enter residency appeal data.

Understanding Residency Data

Using the Resident Table page, set up codes to represent the residency rules of your institution. For example, your institution might require residency codes for residency that is in state, out of state, in district, out of district, and so on. On the Residency Exception Table page, set up exceptions to the residency rules. For example, some individuals might be exempt from nonresidency requirements because they are in the military. Exceptions are especially useful in tuition calculation.

After you set up residency codes and residency exception codes, use the Official Residency 1 and 2 pages to record residency information that your institution has verified, including the individual's state residency or out-of-state residency for a specific term. You can enter unofficial, self-reported residency information on the Residency Self-Report page.

When an individual appeals residency information, you can enter the information on the Residency Appeal page, including the date and status of the appeal and comments about the appeal.

Prerequisites

Before entering residency data, define residency rules.

Related Links

[Setting Up Residency Rules](#)

Pages Used to Enter Residency Data

<i>Page Name</i>	<i>Definition Name</i>	<i>Navigation</i>	<i>Usage</i>
Residency Official 1	RESID_OFFICIAL1	Campus Community > Personal Information > Identification > Residency Data > Residency Official 1	Enter official residency data for an individual.
Residency Official 2	RESID_OFFICIAL2	Campus Community > Personal Information > Identification > Residency Data > Residency Official 2	Enter additional official residency data for an individual.
Residency Appeal	RESIDENCY_APEAL	Campus Community > Personal Information > Identification > Residency Data > Residency Appeal	Record residency appeal information.
Residency Self-Report	RESIDENCY_SELF	Campus Community > Personal Information > Identification > Residency Data > Residency Self-Report	Enter unofficial, unverified residency information that an individual reports to your institution.

Entering Official Residency Data

Access the Residency Official 1 page (**Campus Community > Personal Information > Identification > Residency Data > Residency Official 1**).

This example illustrates the fields and controls on the Residency Official 1 page. You can find definitions for the fields and controls later on this page.

The screenshot shows a web interface for 'Residency Official 1'. At the top, there are tabs for 'Residency Official 1', 'Residency Official 2', 'Residency Appeal', and 'Residency Self-Report'. Below the tabs, the name 'Julianne Binoche' and ID 'CC0004' are displayed. The main section is titled 'Residency Data' and contains several sub-sections:

- Academic Career:** A section with a search icon and expand/collapse buttons.
- Official Residency Data:** A section with search and navigation controls. It includes:
 - Institution:** A search box containing 'PSUNV' and the text 'PeopleSoft University'.
 - *Effective Term:** A search box.
 - Residency:** A dropdown menu currently set to 'Out of State'.
 - Residency Date:** A date input field with a calendar icon.
- Additional Residency Data:** A section with multiple dropdown menus:
 - Admissions:** 'Out of State'
 - Admission Residency Exception:** 'Graduate Student'
 - Fin Aid Federal Residency:** 'Out of State'
 - Fin Aid Fed Residency Excpt:** (empty)
 - Fin Aid State Residency:** 'Out of State'
 - Fin Aid State Residency Excpt:** (empty)
 - Tuition:** 'Out of State'
 - Tuition Residency Exception:** (empty)

Official Residency Data

<i>Field or Control</i>	<i>Description</i>
Effective Term	Enter the term for which the residency data is effective for the individual.
Residency	Select the rule (from the Residency Table page) that describes the individual's residency status.
Residency Date	Enter the date that the individual established or reported the residency.

Additional Residency Data

<i>Field or Control</i>	<i>Description</i>
Admissions	Specify the type of residency that qualifies the individual for admission to the specified institution.
Fin Aid Federal Residency (financial aid federal residency)	Specify the type of residency that qualifies the individual to receive financial aid from the federal government.

Field or Control	Description
Fin Aid State Residency (financial aid state residency)	Specify the type of residency that qualifies the individual to receive financial aid from the state.
Tuition	Specify the type of residency that qualifies the individual for tuition assistance.
Admission Residency Exception	Specify the exception from your institution's residency rule for admissions (from the Residency Exception Table page) that applies to the individual.
Fin Aid Fed Residency Exception (financial aid federal residency exception)	Specify the exception from the federal residency rule for financial aid (from the Residency Exception Table page) that applies to the individual.
Fin Aid St Residency Exception (financial aid state residency exception)	Specify the exception from the state residency rule for financial aid (from the Residency Exception Table page) that applies to the individual.
Tuition Residency Exception	Specify the exception from your institution's residency rule for tuition (from the Residency Exception Table page) that applies to the individual.

Entering Official Residency Location Details

Access the Residency Official 2 page (**Campus Community > Personal Information > Identification > Residency Data > Residency Official 2**).

Enter location details of the residency data for this individual.

Entering Self-Reported Residency Data

Access the Residency Self-Report page (**Campus Community > Personal Information > Identification > Residency Data > Residency Self-Report**).

Self-Reported Residency Data

Field or Control	Description
Date Reported	Enter the date on which this residency information is reported to your institution. The default date is the system's current date. You can override the default date.

Field or Control	Description
Source	Enter a description of the source of this residency information. This can be an individual's name, the method of reporting (such as letter, email, telephone conversation, and so on), or the title of a document that you have chosen to use.
District, County, State, Country, and Postal	Enter location details for this residency.
Comment	Enter comments to further describe this residency information or further identify the source of the information.

Entering Residency Appeal Data

Access the Residency Appeal page (**Campus Community > Personal Information > Identification > Residency Data > Residency Appeal**).

Appeals

Field or Control	Description
Effective Date	Enter the effective date of the status of this appeal. The default effective date is the system's current date. You can override this date.
Appeal Status	Select the current status of this appeal (for example <i>Accepted</i> , <i>Denied</i> , <i>In Progress</i> , <i>None</i> , or <i>Suspended</i>). Values for this field are delivered with your system as translate values. You can modify these translate values.
Comment	Enter comments to further describe or identify the nature of this appeal.

Entering Photographs

This section lists prerequisites and discusses how to enter a photograph into your database.

Prerequisites

Before you can enter a photograph into your database, you must scan or digitally load the photo onto your computer and save it in *JPEG* format. Consult your platform manufacturer's documentation for information about imaging for the particular database platform that you are using.

Page Used to Enter Photographs

<i>Page Name</i>	<i>Definition Name</i>	<i>Navigation</i>	<i>Usage</i>
Photograph	PHOTO_PERS	Campus Community > Personal Information > Identification > Photo	Enter a photograph of an individual into your system.

Entering a Photograph

Access the Photograph page (**Campus Community** > **Personal Information** > **Identification** > **Photo**).

To insert an image, click the plus button to add a row on the Photo page.

Browse to, or enter the path to the .JPG image of the individual on your computer and click **Upload**. After the system uploads the photo, save the page.

Entering PINs

This section discusses how to enter a PIN into your database.

Page Used to Enter Personal Identification Numbers

<i>Page Name</i>	<i>Definition Name</i>	<i>Navigation</i>	<i>Usage</i>
Personal Identification Number	PIN	Campus Community > Personal Information > Identification > PIN	Maintain an individual's personal identification number in your system.

Entering a Personal Identification Number

Access the Personal Identification Number page (**Campus Community** > **Personal Information** > **Identification** > **PIN**).

<i>Field or Control</i>	<i>Description</i>
PIN	Enter the PIN for this individual. PINs can be up to nine alphanumeric characters. To ensure confidentiality, the characters appear as asterisks as you enter them.

Managing Participation Data

Understanding Participation Data

You can enter information in your database to indicate the types of accomplishments achieved by individuals at your institution, as well as their association memberships. You can enter data about their athletic participation, extracurricular activities, the licenses and certificates that they hold, the honors and awards that they receive, and the articles or books that they have published.

You can use the codes in your system to identify athletes at your institution and track their athletic participation and eligibility. Some codes for levels of involvement are delivered with your system. You can create additional codes to identify the levels of involvement in athletic teams and events at your institution.

You can also enter data about the books and articles that individuals at your institution have published.

Note: PeopleSoft Campus Self Service, which is licensed separately, provides self-service components for participation data.

See “Using Self-Service Participation Data” (Campus Self Service).

Prerequisites for Managing Participation Data

Before entering participation data, you must set up codes and tables to use.

See [Setting Up Extracurricular Activities](#).

Entering Honors and Awards Data

You can enter data about internal and external honors and awards received by individuals at your institution. You can track the external honors and awards of interest to your institution. You can include internal awards on transcripts and for setting up graduation.

See “Tracking Honors and Awards” (Student Records).

Page Used to Enter Honors and Awards Data

<i>Page Name</i>	<i>Definition Name</i>	<i>Navigation</i>	<i>Usage</i>
Honors and Awards	HONORS_AWARDS_CS	Campus Community > Personal Information > Accomplishments > Honors and Awards	Enter internal and external honors and awards received by individuals at your institution.

Entering an Honor or Award

Access the Honors and Awards page (**Campus Community** > **Personal Information** > **Accomplishments** > **Honors and Awards**).

Honors/Awards Detail

<i>Field or Control</i>	<i>Description</i>
Internal/External	Select the type of honor or award that the individual received. Values are: <i>Internal</i> <i>External</i>
Honor/Award	Select the honor or award that was received. The available honors and awards are from the Honors/Awards Table page.
Career, Academic Program, Academic Plan, Term, and Tran Level (transcript level)	These fields appear when you select <i>Internal</i> . The transcript level that was set on the Honors/Awards Table page for the selected honor or award appears as the default value in the Tran Level field. You can override it to select a different transcript level on which to include this honor or award. Enter values in the other fields as required by your institution for internal honors and awards. See “Setting Up Honors and Awards” (Student Records).

Entering Licenses and Certificates Data

You can enter data about the credentials and certifications earned by individuals at your institution. You can also indicate whether the license or certificate requires renewal, and if so, when.

This section discusses how to enter license and certificate data.

Page Used to Enter License and Certificates Data

<i>Page Name</i>	<i>Definition Name</i>	<i>Navigation</i>	<i>Usage</i>
Licenses and Certificates	SCC_LICENSE_CERT	Campus Community > Personal Information > Participation Data > Accomplishments > Licenses and Certificates	Enter license and certificate data to track the permits, licenses, and certifications held by an individual.

Entering Licenses and Certificates Data

Access the Licenses and Certificates page (**Campus Community** > **Personal Information** > **Participation Data** > **Accomplishments** > **Licenses and Certificates**).

License/Certificate Detail

<i>Field or Control</i>	<i>Description</i>
License/Certificate Code	Select the code for the license or certificate to track for the individual.
Issue Date	Enter the date on which the license or certificate was officially issued.
License #	Enter the license number or other unique identification number assigned to the specific license or certificate by the issuing agent.
Issued By	Enter the name of the agency or authority that issued the license or certificate.
Expiration Date	Enter the date on which the license or certificate is scheduled to expire.
License Verified	Select to indicate that your institution has verified that this individual holds this license or certificate.
Renewal in Progress	Select to indicate that the individual is in the process of renewing this license or certificate.

Issued In

<i>Field or Control</i>	<i>Description</i>
Country	Specify the country in which the license or certificate was issued.
State	Specify the state or province in which the license or certificate was issued.

Entering Memberships Data

You can select from the organizations in your database to indicate an individual's association with that organization. If the individual belongs to an organization that is not in your database, you might want to add the organization on the Membership Table page so that you can track the individuals at your institution who belong to it.

This section discusses how to enter memberships data.

Page Used to Enter Memberships Data

<i>Page Name</i>	<i>Definition Name</i>	<i>Navigation</i>	<i>Usage</i>
Memberships	SCC_MEMBERSHIPS	Campus Community > Personal Information > Participation Data > Accomplishments > Memberships	Enter memberships data to identify the organizations of which an individual is a member.

Entering Membership Data

Access the Memberships Page (**Campus Community** > **Personal Information** > **Participation Data** > **Accomplishments** > **Memberships**).

<i>Field or Control</i>	<i>Description</i>
Organization and Description	Select the code for the organization of which this individual is a member.
Membership Date	Enter the date on which the individual's membership began.
Mandate, Mandate Position, Mandate Begin Date, and Mandate End Date	Enter data to describe the organization's mandate or purpose of membership.

Entering Publications Data

This section discusses how to enter publications data.

Page Used to Enter Publications Data

<i>Page Name</i>	<i>Definition Name</i>	<i>Navigation</i>	<i>Usage</i>
Publications	LS_PUBLICATIONS	Campus Community > Personal Information > Participation Data > Accomplishments > Publications	Enter publications data for an individual.

Entering Publications Data

Access the Publications page (**Campus Community** > **Personal Information** > **Participation Data** > **Accomplishments** > **Publications**).

Publication Detail

<i>Field or Control</i>	<i>Description</i>
Publication Number	<p>The number of this publication in the list of publications for this individual.</p> <p>The system enters the next sequential number for each publication that you add. You can override the number to reorder the list of publications.</p>
Publication Type	<p>Specify the type of publication, such as article, book, presentation, record, thesis, or video.</p> <p>Values for this field are delivered with your system as translate values. You can modify these translate values.</p>
Author Type	<p>Specify the type of this individual's authorship participation in the publication, such as author, co-author, or editor.</p> <p>Values for this field are delivered with your system as translate values. You can modify these translate values.</p>
Publication Title	Enter the title of the publication.

Field or Control	Description
Publication Name	Enter the name of the magazine, journal, book, or other, in which the publication appeared.
Multiple Authors	Select this check box if the publication has multiple authors.
Full Author List	Enter the complete list of authors for the publication.
Publisher	Enter the name of the publisher of the magazine, journal, book, or other medium in which the publication appeared.
Date Format For PowerPlay	Select to indicate whether the value in the Date field must be selected from the calendar feature or entered in a valid date format. If you do not select this check box, the value in the Date field can be any value or format of up to 10 characters.
Date	Enter the date of the publication.
Volume	Enter the volume, if any, of the magazine, journal, book, or other medium in which the publication appeared.
Issue	Enter the issue, if any, of the magazine, journal, book, or other medium in which the publication appeared.
Page Number(s)	Enter the page numbers, if any, of the magazine, journal, book, or other medium in which the publication appeared.
Notes	Enter notes or comments to further identify or describe the publication by this individual.
Application Method	Select the method in which the publication was submitted. This field uses the same values as the Application Method field in the Admissions application components.
Data Verified	Select this check box if the student's involvement with the publication has been verified.
Date and Verifier	You can enter data in these fields only if the Data Verified check box is selected. Enter the date on which the data was verified and the name of the person who verified the data.

File Attachments

<i>Field or Control</i>	<i>Description</i>
Add Attachments	<p>Click this button to browse for any file that you want to attach to the page. After attaching the file, click the View link to open it in a separate browser window, or click Add to attach multiple files.</p> <p>Attachments become directly associated with the person's publication record.</p>

Entering Athletic Participation Data

This section discusses how to enter athletic participation data.

Page Used to Enter Athletic Participation Data

<i>Page Name</i>	<i>Definition Name</i>	<i>Navigation</i>	<i>Usage</i>
Athletic Participation	ATHLETES	Campus Community > Personal Information > Participation Data > Athletic Participation	Enter athletic participation data to help track an individual's participation at your institution.

Entering Athletic Participation Data

Access the Athletic Participation page (**Campus Community > Personal Information > Participation Data > Athletic Participation**).

Sport

<i>Field or Control</i>	<i>Description</i>
Sport	<p>Select the sport in which this individual participates.</p> <p>Values for this field are delivered with your system as translate values. You can modify these translate values.</p>

Athlete Information

<i>Field or Control</i>	<i>Description</i>
Athletic Participation	Indicate the level or status of the individual's participation in the specified sport, such as active participant, manager, not recruited, or recruited.
Current Participant	Select to indicate that this individual currently participates in this sport.
NCAA Eligible	Select to indicate that the individual is eligible to participate on an NCAA (National Collegiate Athletic Association) team for this sport.
Comments	Enter comments to further identify or describe the individual's level or status of participation in the specified sport.

Entering Extracurricular Activities Data

You can use the codes in your system to identify extracurricular activities and track participation in them. Some codes for levels of involvement are delivered with your system. You can create additional codes to identify the levels of involvement in athletic teams and events.

This section discusses how to enter extracurricular activities data.

Page Used to Enter Extracurricular Activities Data

<i>Page Name</i>	<i>Definition Name</i>	<i>Navigation</i>	<i>Usage</i>
Extracurricular Activities	LS_EXTRA_ACTVTY	Campus Community > Personal Information > Participation Data > Extracurricular Activities	Enter extracurricular activities data to track internal or external student activities for an individual.

Entering Extracurricular Activities Data

Access the Extracurricular Activities page (**Campus Community** > **Personal Information** > **Participation Data** > **Extracurricular Activities**).

Field or Control	Description
Internal/External	Specify whether the activity in which the individual participates, is within or outside of your institution.
Activity	Select the activity code, from the Extracurricular Activities Table page, which represents the activity in which the individual participates.
Description	<p>The system displays the description associated with the specific activity code on the Extracurricular Activities Table page.</p> <hr/> <p>Note: You can manually enter an activity description without selecting a code. However, to be sure that the activity will be included in FERPA and other processes that depend on the codes, you should consider setting up the activity on the Extracurricular Activities Table page.</p> <hr/>
Start Date	Enter the date on which the individual's participation in this activity is scheduled to begin. The default start date is the system's current date. You can override this date.
End Date	Enter the date on which the individual's participation in this activity is scheduled to end.
Interest	Select to indicate that the individual expresses an interest in participating in this activity while at your institution.
Years Involved	Select the appropriate check boxes to indicate the years during which the individual participated in this type of activity.
Academic Institution	The system displays the academic institution of the student, unless the student has more than one, in which case you must select the relevant institution.
Academic Career	The system displays the academic career of the student, unless the student has more than one, in which case you must select the relevant career.
Term	Specify the term during which this individual is scheduled to participate in this activity.
Activity Type	The system displays the activity type associated with the specified activity code on the Extracurricular Activities Table page.

Field or Control	Description
Office Held	<p>Specify the office, if any, that this individual holds in this activity, such as captain, EIC, president, treasurer, or vice president.</p> <p>Values for this field are delivered with your system as translate values. You can modify these translate values.</p>
Time Unit 1 and Time Unit 2	<p>Enter the amount of time that the individual devotes to this activity. Enter the number in the first field and select a time period in the second field. Values for the second field are:</p> <p><i>Days/Month</i></p> <p><i>Hrs/Week</i></p> <p><i>Wks/Year</i></p> <p>The default value is <i>Hrs/Week</i>.</p> <p>If you specify the number of hours per week in the Time Unit 1 field, you should also specify the number of weeks per year that the individual devotes to the activity in the Time Unit 2 field.</p>
Comments	<p>Enter comments to further identify or describe the individual's participation in this activity.</p>

Managing FERPA Privacy Control

Understanding FERPA

Under FERPA regulations, institutions can release directory information about a student, provided that the student has reasonable opportunity to prohibit, in writing, the disclosure of such information.

FERPA regulations define which items qualify as directory information; however, each institution must identify and make known which of those items it plans to publish or share as directory information. Campus Solutions provides examples of typical directory information in the FERPA_VW control tables. You must configure these examples to reflect your institution's directory information. Even though FERPA is named after a U.S. regulation, the feature is flexible and can be used to define privacy settings for any personal sensitive data.

Note: Not all information defined as potential FERPA directory information is controlled by the delivered FERPA functionality. You may need to expand or modify the delivered records and views if other information about students is subject to FERPA regulations or should be treated as confidential according to your institution's policy. For more information about your institution's or FERPA's definition of directory information, contact your institution's registrar's office. Other resources on FERPA directory information and other regulations include: The Family Policy Compliance Office, U.S. Department of Education, and the American Association of Collegiate Registrars and Admissions Officers (AACRAO).

Under FERPA, students can prohibit the release of directory data about themselves. With PeopleSoft FERPA functionality, students can restrict data, but they can also give you permission to release some or all of that restricted data for inclusion in specific internal publications.

<i>Term</i>	<i>Definition</i>
 (FERPA privacy shade)	When you apply FERPA control to restrict data for a student, the system attaches a FERPA window shade privacy button to that individual's records in your database.

Click the FERPA privacy button on a page about that individual to quickly determine the information that is legally releasable to others at your institution or to third-party vendors about that individual. You can also navigate directly to the FERPA Display inquiry pages for each type of information (biographical data, addresses, activities, and so on) to determine the same information.

Prerequisites for Managing FERPA Privacy Control

Before you can apply and manage FERPA control, you must establish FERPA control fields. Before you can enable students to identify publications for which they release FERPA restrictions, you must set up your institution's publications.

Related Links

[Making Data Available for FERPA Privacy Control](#)

Applying FERPA Control

When students exercise rights under FERPA, they identify information that they do not want your institution to release about themselves. You must apply FERPA control to identify this information and prohibit the release of restricted information across your institution. Students have the option of permitting your institution to release any of the restricted information to specific internal publications.

You can use the FERPA page or the FERPA Quick Entry page to apply FERPA control from the administrative side or, if your institution has purchased PeopleSoft Campus Self Service, you can make students responsible for applying their own FERPA control over the internet from the FERPA self-service page.

This section discusses how to:

- Apply or release FERPA restrictions.
- Use the FERPA Quick Entry page.
- Release FERPA data to publications.

Note: If your institution has licensed and implemented PeopleSoft Campus Self Service, students can use the FERPA self-service page to apply their own FERPA restrictions and to identify which restricted information your institution can include in specific internal publications.

See “Using Self-Service Addresses, Names, Phones, and Demographic Data” (Campus Self Service).

Pages Used to Apply FERPA Privacy Controls

<i>Page Name</i>	<i>Definition Name</i>	<i>Navigation</i>	<i>Usage</i>
FERPA	FERPA	Campus Community > Personal Information > Biographical > Person FERPA > FERPA	Apply or release FERPA restrictions to selected data for an individual.
FERPA Quick Entry	FERPA_ADMIN_QENTRY	Campus Community > Personal Information > Biographical > Person FERPA > FERPA Quick Entry	Apply or release FERPA restrictions to selected data for an individual.
Release To Publication	INST_PUB_CATG_SEC	Click the Release To Publication link that appears on the FERPA Quick Entry page when an item is selected on the FERPA Quick Entry page.	Specify or review publications to which restricted data may be released.

Applying or Releasing FERPA Restrictions

Access the FERPA page (**Campus Community > Personal Information > Biographical > Person FERPA > FERPA**) or the FERPA Quick Entry page (**Campus Community > Personal Information > Biographical > Person FERPA > FERPA Quick Entry**).

This example illustrates the fields and controls on the FERPA page. You can find definitions for the fields and controls later on this page.

FERPA

Ralph Crowe ID: CC0001

FERPA When selected, the following information will be restricted from release (with the noted exceptions for Release to Publications) according to FERPA guidelines and policies.

FERPA Restrictions

*Record (Table) Name: ADDR_FERPA_VW Addresses + -

*Field Name: BILL Billing + -

▼ Restriction Exceptions (by Publication Category)

-

Add

*Field Name: CAMP Campus + -

▼ Restriction Exceptions (by Publication Category)

All Community Directories -

Add

*Field Name: HOME Home + -

▼ Restriction Exceptions (by Publication Category)

Student Community Directories -

Add

<i>Field or Control</i>	<i>Description</i>
FERPA	Select this check box to indicate that the student has, in accordance with FERPA, instructed your institution not to release the information about them, and to display the FERPA Restrictions area at the bottom of the page, where you can select the record and field to restrict.

FERPA Restrictions

<i>Field or Control</i>	<i>Description</i>
Record (Table) Name	Enter the name of the FERPA_VW record, from the FERPA Control Page, that contains the type of information the student is restricting.

Field or Control	Description
Field Name	Enter the name of the controlled field on the FERPA_VW record that contains the specific information the student is restricting. The values displayed in the prompt are controlled by the FERPA Control setup page.
Restriction Exceptions (by Publication Category)	<p>Select each of the publications, from the Publications Categories page, to which the student gives you permission to release the otherwise restricted information.</p> <p><i>All Community Directories:</i> Indicates that the student gives permission to release the otherwise restricted information for inclusion in all of your institution's internal community directories.</p> <p><i>Student Community Directory:</i> Indicates that the student gives permission to release the otherwise restricted information for inclusion in your institution's internal student directory only.</p>

Note: Publication categories are used in PeopleSoft Campus Self Service. You can add new categories and add publications to the delivered categories, but do *not* delete the delivered categories.

Related Links

“Searching Community Directories” (Campus Self Service)

Using the FERPA Quick Entry

Access the FERPA Quick Entry page (**Campus Community > Personal Information > Biographical > Person FERPA > FERPA Quick Entry**).

Field or Control	Description
Restrict All Fields	Click this check box to select the Restrict option for all fields in all categories on the entire page.
Release All Restrictions	Click this button to clear the Restrict option for all fields in all categories on the entire page.

Restriction Categories

The fields that appear for each category are based on the controlled fields identified for each FERPA_VW record on the FERPA Control page.

Note: Extracurricular Activities field names do not appear because the PeopleSoft system does not deliver sample control fields on the ACTVTS_FERPA_VW record. To set control fields for activities, use the FERPA Control page.

See [Making Data Available for FERPA Privacy Control](#).

Field or Control	Description
Restrict	Select this check box to indicate that the student prohibits the institution from releasing this information.
Release To Publication	Select this link to access the Release To Publication page, where you can enter or review publications to which the restricted data may be released.
Restrict All	Click this button to select the Restrict option for all fields in the category.
Release All	Click this button to clear the Restrict option for all fields in this category.

Releasing FERPA Data to Publications

Access the Release To Publication page (click the **Release To Publication** link that appears on the FERPA Quick Entry page when an item is selected on the FERPA Quick Entry page).

This example illustrates the fields and controls on the Release To Publication page. You can find definitions for the fields and controls later on this page.

Release To Publication

Business

The following categories of publications will be exceptions to the restrictions that have been placed on the release of this information under FERPA. The restricted information WILL appear in publications in the following categories.

Publication Categories

Student Community Directories + -

Field or Control	Description
Publication Categories	<p>Select each publication, from the Publication Categories page, to which the student gives you permission to release this specific, otherwise restricted information.</p> <p><i>All Community Directories:</i> Indicates that the student gives permission to release the otherwise restricted information for inclusion in all of your institution's internal community directories.</p> <p><i>Student Community Directories:</i> Indicates that the student gives permission to release the otherwise restricted information for inclusion your institution's internal student directory only.</p>

Note: Publication categories are used in PeopleSoft Campus Self Service. You can add categories, and add publications to the delivered categories, but you should *not* delete the delivered categories.

Determining Releasable Information

This section provides an overview of how to determine releasable information and discusses how to determine releasable biographical data.

Understanding the Determination of Releasable Information

You can determine releasable information about an individual two ways:

- You can click the FERPA (privacy shade) button on a page about an individual to display the Releasable FERPA Directory Information page.
- You can navigate directly to the FERPA Display pages from the Inquiry menu to review all releasable information about an individual.

Note: Field names appear on the Releasable FERPA Directory Information page and on any of the Review FERPA Display pages only if that type of data is releasable. If a field is releasable but no data exists for it, the field name appears but with no field value. For example, if the individual's birth location is releasable but data for it is not in the system, the field name **Birth Location** appears on the page, but the field value box beside it is empty.

Pages Used to Determine Releasable Information

Page Name	Definition Name	Navigation	Usage
Releasable FERPA Directory Information	FERPA_DISPLAY1_SP	Click the FERPA (privacy shade) button from most pages for the individual.	Determine releasable data for an individual, including gender, marital status, and photo.

Page Name	Definition Name	Navigation	Usage
Releasable Names	FERPA_DSP_NAME_SEC	Click the Releasable Name link, when available, on the Releasable FERPA Directory Information page.	Determine the releasable names for an individual.
Releasable Addresses	FERPA_DSP_ADDR_SEC	Click the Releasable Address link, when available, on the Releasable FERPA Directory Information page.	Determine the releasable addresses for an individual.
Releasable Phone Numbers	FERPA_DSP_PHON_SEC	Click the Releasable Phone link, when available, on the Releasable FERPA Directory page.	Determine the releasable phone numbers for an individual.
Releasable Email Addresses	FERPA_DSP_EMAIL_SP	Click the Releasable Email link, when available, on the Releasable FERPA Directory Information page.	Determine the releasable phone numbers for an individual.
Releasable Activity Information	FERPA_DSP_ACT_SEC	Click the Releasable Activities link, when available, on the Releasable FERPA Directory Information page.	Determine the releasable extracurricular activity information for an individual.
FERPA Bio Demo	FERPA_DISPLAY1	<ul style="list-style-type: none"> • Campus Community > Personal Information > Biographical > Person FERPA > Review FERPA Display > Bio Demo • Contributor Relations > Constituent Information > People > FERPA Display > Bio Demo 	Determine releasable biographical data about an individual, including gender, marital status, and names.

Page Name	Definition Name	Navigation	Usage
FERPA Addresses	FERPA_DISPLAY2	<ul style="list-style-type: none"> • Campus Community > Personal Information > Biographical > Person FERPA > Review FERPA Display > FERPA Addresses • Contributor Relations > Constituent Information > People > FERPA Display > FERPA Addresses 	Determine releasable address data for an individual.
FERPA Phones	FERPA_DISP_PHONES	<ul style="list-style-type: none"> • Campus Community > Personal Information > Biographical > Person FERPA > Review FERPA Display > FERPA Phones • Contributor Relations > Constituent Information > People > FERPA Display > FERPA Phones 	Determine releasable phone data for an individual.
FERPA Email Address	FERPA_DISP_EMAIL	<ul style="list-style-type: none"> • Campus Community > Personal Information > Biographical > Person FERPA > Review FERPA Display > FERPA Email Addr • Contributor Relations > Constituent Information > People > FERPA Display > FERPA Email Addr 	Determine releasable email data for an individual.

<i>Page Name</i>	<i>Definition Name</i>	<i>Navigation</i>	<i>Usage</i>
FERPA Activities	FERPA_DISP_ACTVTS	<ul style="list-style-type: none"> • Campus Community > Personal Information > Biographical > Person FERPA > Review FERPA Display > FERPA Activities • Contributor Relations > Constituent Information > People > FERPA Display > FERPA Activities 	Determine releasable extracurricular activity data for an individual.
FERPA Photo	FERPA_DISP_PHOTO	<ul style="list-style-type: none"> • Campus. Community > Personal Information > Biographical > Person FERPA > Review FERPA Display > FERPA Photo • Contributor Relations > Constituent Information > People > FERPA Display > FERPA Photo 	Determine if a photo of the individual is releasable.

Determining Releasable Biographical Data

Access the Releasable FERPA Directory Information page (click the FERPA (privacy shade) button from most pages for the individual).

Information displayed on this page is entered on the FERPA page or FERPA Quick Entry page. The **Person of Interest** or other designation is identified when the individual's record is first created in the database.

Note: When releasable data for the individual exists, the appropriate links (Releasable Name, Releasable Address, Releasable Phone, and so on) are available. If none of the data in a data type is releasable, the link for that data type does not appear.

<i>Field or Control</i>	<i>Description</i>
Releasable Name	Click this link to access the Releasable Name page, where you can view releasable names for this individual.

<i>Field or Control</i>	<i>Description</i>
Releasable Address	Click this link to access the Releasable Addresses page, where you can view releasable addresses for this individual.
Releasable Phone	Click this link to access the Releasable Phone Numbers page, where you can view releasable phone numbers for this individual.
Releasable Email	Click this link to access the Releasable Email Addresses page, where you can view releasable email addresses for this individual.
Releasable Activities	Click this link to access the Releasable Activity Information page, where you can view releasable extracurricular activity information for this individual.

Managing Service Indicators

Understanding Service Indicators



Use service indicators to provide or limit access to services at your institution for an individual or organization. Service indicators can be holds that prevent an individual or organization from receiving certain services or positive indicators that designate special services to be provided. Service indicators consist of one or more impact values that identify the types of specific services that are restricted or provided.

Examples of negative service indicators include no check cashing privileges, enrollment verification or transcript holds, and denied registration for classes. Positive service indicators include check cashing privileges, front-of-line service, use of the gym, special services for disabled students, and so on.

You might define a positive service impact to permit specific students to receive their student identification cards earlier than the remainder of the student body. You might define a negative service impact that prevents specific students from receiving their student identification cards until, for example, they submit past-due enrollment deposits.

After you define service impacts, you can group them to define service indicators and create service indicator codes. Next, you identify reasons for applying service indicators, and you create codes for those reasons. When you create service indicators and reason codes, administrative users with the appropriate security can assign service indicators to individuals. They can also remove an active service indicator from an ID's record when that service or restriction no longer applies. Automated processes can also be used to assign or remove negative service indicators.

When a service indicator is assigned, the corresponding negative or positive service indicator button appears on most pages about that individual or organization. One button can represent one or several service indicators. You would click the buttons on any of those pages to navigate to the appropriate details page, where you can determine how many and which restrictions apply.

Term	Definition
 (negative service indicator)	<p>Appears on a page when a negative service indicator is assigned to the individual or organization.</p> <p>Click to access the Manage Service Indicators page, from which you can view details about the service restrictions associated with each negative service indicator for the ID.</p>
 (positive service indicator)	<p>Appears on a page when a positive service indicator is assigned to the individual or organization.</p> <p>Click to access the Manage Service Indicators page, from which you can view details about the service privileges associated with each positive service indicator for the ID.</p>

You can review service indicators in several ways. You can click the service indicator buttons or use menu navigation to access the Manage Service Indicators page, where you can review a list of service indicators currently assigned to an ID. You can also access the Service Indicator Audits page, where you can configure a search for any service indicator information that you want to review. For example, you can specify an ID whose service indicator details you want to review and search for that list; you can specify a service indicator and search for all IDs to whom the indicator is assigned; you can specify an ID and search for all service indicators assigned by that individual; and many other configurations. The search results provide data that identifies the date and time the service indicator was added or deleted and the ID of the user who added or deleted it.

If your institution has licensed PeopleSoft Campus Self Service, students can also view their own active service indicator information on the self-service Holds page.

Related Links

- “Setting Up Service Indicator Security” (Campus Solutions Application Fundamentals)
- “Using Self-Service Service Indicators Data” (Campus Self Service)

Viewing, Assigning, or Removing Service Indicators

This section discusses how to:

- View service indicators assigned to an ID.
- Assign a service indicator to an ID.
- Edit an assigned service indicator.

Pages Used to View, Assign, or Remove Service Indicators

<i>Page Name</i>	<i>Definition Name</i>	<i>Navigation</i>	<i>Usage</i>
Manage Service Indicators	SRVC_IND_SUMRY	<ul style="list-style-type: none"> • Campus Community > Service Indicators > Person > Manage Service Indicators • Contributor Relations > Constituent Information > People > Service Indicators > Manage Service Indicators 	View service indicators assigned to a person ID.

<i>Page Name</i>	<i>Definition Name</i>	<i>Navigation</i>	<i>Usage</i>
Manage Service Indicators Org	SCC_SI_ORG_SUMRY	<ul style="list-style-type: none"> • Campus Community > Service Indicators > Organization > Manage Service Indicators Org • Contributor Relations > Constituent Information > Organizations > Service Indicators > Manage Service Indicators Org 	View service indicators assigned to an organization ID.
Add Service Indicator Edit Service Indicator	SRVC_IND_DATA1	<p>For the Add Service Indicator page, click the Add Service Indicator link on the Manage Service Indicators page for individuals.</p> <p>For the Edit Service Indicator page, click the link for a service indicator in the code column on the Manage Service Indicators page for individuals.</p>	<p>Use the Add Service Indicator page to assign a new service indicator to the person ID.</p> <p>Use the Edit Service Indicator page to view and edit details of a service indicator currently assigned to the person ID.</p>
Add Service Indicator Org Edit Service Indicator Org	SCC_SI_ORG_DATA	<p>For the Add Service Indicator Org page, click the Add Service Indicator link on the Manage Service Indicators Org page.</p> <p>For the Edit Service Indicator Org page, click the link for a service indicator in the Code column on the Manage Service Indicators Org page.</p>	<p>Use the Add Service Indicator Org page to assign a new service indicator to the organization ID.</p> <p>Use the Edit Service Indicator Org page to view and edit details of a service indicator currently assigned to the organization ID.</p>

Viewing Service Indicators Assigned to an ID

Access the Manage Service Indicators page (**Campus Community > Service Indicators > Person > Manage Service Indicators**).

This example illustrates the fields and controls on the Manage Service Indicators page (for individuals). You can find definitions for the fields and controls later on this page.

Manage Service Indicators

Ralph Crowe Person ID: CC0001

Display: Effect All Institution PeopleSoft University [Refresh](#)

[+ Add Service Indicator](#)

Service Indicator Summary									
Code	Code Description	Reason Description	Institution	Start Term	Start Term Description	End Term	End Term Description	Start Date	End Date
L01	Library Fines	Overdue Library Fines	PSUNV	0000	Begin Term			08/31/2004	

[+ Add Service Indicator](#)

This example illustrates the fields and controls on the Manage Service Indicators Org page (for organizations). You can find definitions for the fields and controls later on this page.

Manage Service Indicators Org

Org ID: 0041044 Marlin Corporation

Display: Effect All Institution PeopleSoft University [Refresh](#)

[+ Add Service Indicator](#)

Service Indicator Summary									
Code	Code Description	Reason Description	Institution	Start Term	Start Term Description	End Term	End Term Description	Start Date	End Date
FAV	Favored Vendor	Long Term Relationship	PSUNV					07/24/2006	

[+ Add Service Indicator](#)

Note: Assigned service indicators use the current effective-dated service indicator definition on the Service Indicator Codes page. If a new effective-dated row is added to a service indicator definition, the changes to that row will affect existing assignments to IDs as well as new assignments to IDs.

<i>Field or Control</i>	<i>Description</i>
Effect, Institution, and Refresh	Select the effect of the service indicators from the available values: <i>All</i> , <i>Positive</i> , and <i>Negative</i> . Enter the institution whose service indicators you want to display for the ID. You must click Refresh to display data according to the effect and institution that you enter.

<i>Field or Control</i>	<i>Description</i>
Add Service Indicator	<p>Click to access the Add Service Indicator page, where you can assign a service indicator to this ID within the associated institution.</p> <p>This link appears at both the top and bottom of the page when the list of service indicators is long.</p>

Service Indicator Summary

<i>Field or Control</i>	<i>Description</i>
Code	<p>Click the service indicator code in the code column to access the Edit Service Indicator page, where you can view and edit details of the assigned service indicator.</p>

Assigning a Service Indicator to an ID

For individuals, access the Add Service Indicator page. (For the Add Service Indicator page, click the **Add Service Indicator** link on the Manage Service Indicators page for individuals. For the Edit Service Indicator page, click the link for a service indicator in the code column on the Manage Service Indicators page for individuals.)

This example illustrates the fields and controls on the Add Service Indicator page (1 of 2). You can find definitions for the fields and controls later on this page.

Add Service Indicator

Ralph Crowe CC0001

***Institution:** PeopleSoft University

***Service Indicator Code:** No Refunds

***Service Ind Reason Code:** Non Payment of Fees

Effect: Negative

Effective Period

Start Term: 2006 Spr **End Term:** 2006 Sum

Start Date: **End Date:**

Assignment Details

***Department:** Human Resources

Reference:

Amount: **Currency:**

Contact Information

Contact ID: **Contact Person:**

Placed Person ID: **Placed By:**

Comments

This example illustrates the fields and controls on the Add Service Indicator page (2 of 2). You can find definitions for the fields and controls later on this page.

Services Impacted				
Impact	Description	Basis - Date	Basis - Term	Term Category
1	REFND Student Refund Check	<input checked="" type="checkbox"/>	<input type="checkbox"/>	

Service Indicator Date Time: 05/30/2006 5:36:57PM

User ID: PS Locherty,Betty

For organizations, access the Add Service Indicator Org page. (For the Add Service Indicator Org page, click the **Add Service Indicator** link on the Manage Service Indicators Org page. For the Edit Service Indicator Org page, click the link for a service indicator in the Code column on the Manage Service Indicators Org page.)

Field or Control	Description
Institution	Enter the code for the institution that is responsible for this service indicator.
Service Indicator Code	Enter the code for the service indicator to assign to the individual.
Service Ind Reason Code (service indicator reason code)	<p>Enter the reason that you are assigning this service indicator to the individual.</p> <hr/> <p>Note: Only the reason codes that are associated with the specific service indicator on the Service Indicator Codes page are available.</p> <hr/>
Effect	The system displays the effect associated with the service indicator that you select. Values are <i>Positive</i> or <i>Negative</i> .

Effective Period

You can assign a service indicator with a beginning and an end to its validity for an ID. You can specify a date on which the date-based impacts for a service indicator will take effect, and a date on which they will cease to be in effect. Similarly, you can specify a term at the beginning of which to apply the term-based impacts associated with the service indicator, and specify a term at the end of which to cease to apply the impacts. You can further control the validity period of term-based and date-based impacts. If you do not want the indicator to be valid during the entire start-to-end term period, you can specify dates within either or both terms to use for starting and ending the validity.

Note: The service impacts associated with a service indicator can be term-based or date-based. They are applied or released based on the start and end information that you enter.

Field or Control	Description
Start Term and End Term	<p>Enter the term during which the service indicator should become valid for the ID, and enter the term during which it should cease to be valid for the ID.</p> <p>A Start Term value of <i>0000</i> means that term-based impacts will be in effect for all terms. A Start Term value of <i>9999</i> means that term-based impacts will never take effect.</p> <p>If no End Term value is entered, term-based impacts will be in effect until the service indicator is released.</p>

Field or Control	Description
Start Date and End Date	<p>Enter the date on which the service indicator should become valid for the ID, and enter the date on which it should cease to be valid for the ID.</p> <p>If no End Date value is entered, date-based impacts will be in effect until the service indicator is released.</p>

Assignment Details

Field or Control	Description
Department	Enter the department that is responsible for placing the service indicator (or requesting its placement) on the individual's record.
Reference	Enter a reference number or other data that may assist in tracking and identifying the service indicator and its resolution.
Amount	Enter the monetary amount, if any, that is required to satisfy the reason for this service indicator.
Currency	Specify the currency in which the monetary amount is expressed.

Contact Information

Field or Control	Description
Contact ID and Contact Person	Enter the ID and name of the person to contact with questions about this service indicator.
Placed Person ID and Placed By	<p>The system displays the current user's ID and name. You can override this value to enter whatever your institution requires.</p> <p>You can enter the ID or, if no ID exists, you can enter the name of the person who placed the service indicator on the individual's record. Enter the name in the lastname;firstname format. Alternatively, you can identify the person who requested that the service indicator be placed on the record.</p>

Comments

<i>Field or Control</i>	<i>Description</i>
Comments	Enter comments to further describe or identify the reason for the service indicator.

Services Impacted

<i>Field or Control</i>	<i>Description</i>
Impact	Click the code in the Impact column to access the Service Impact Description page, where you can view details about the impact.
Basis - Date or Basis - Term	<p>The system indicates whether the service impact is set to be considered or disregarded (both manually or in the automated process) based on the begin and end values that you specify for the service indicator. When the <i>Basis - Term</i> check box is selected, the impact will start and end for the terms that you specify. If the <i>Basis - Date</i> check box is selected, the impact will start and end on the dates that you specify.</p> <p>If either or both of the check boxes are selected but you enter no values for the End Term or End Date fields, then the impact will remain in effect until manually released.</p>

Field or Control	Description
Term Category	<p>Appears only if the impact is term-based.</p> <hr/> <p>Note: This value is provided for informational purposes for administrative users. Delivered processes do not consider the term category.</p> <hr/> <p>Displays the term of the service impact as it is associated with the service indicator on the Service Indicator Codes page. If the term falls within the Start Term and End Term period and a term category appears, you must determine whether the category of that term matches the category shown. If it does not, you should consider the impact not in effect.</p> <p>For example, a student applies for a parking permit for the Fall 2007 term, which has a term category of <i>Regular</i>. You assign the service indicator with a parking impact to the student, but the impact has an associated term category of <i>Summer</i>. Because the term begin and end dates of the service indicator do not fall within the dates of the summer term, the impact is not in effect.</p> <p>See “Defining Terms, Sessions, and Session Time Periods” (Campus Solutions Application Fundamentals).</p>
Service Indicator Date Time	<p>The system displays the current day and time when the service indicator was assigned.</p>
User ID and Name	<p>The system displays the ID of the user who is entering or changing information on the page.</p>

Editing an Assigned Service Indicator

Access the Edit Service Indicator page (click the link for a service indicator in the code column on the Manage Service Indicators page for individuals) or the Edit Service Indicator Org page (click the link for a service indicator in the Code column on the Manage Service Indicators Org page).

The following fields are specific to the Edit Service Indicator page and the Edit Service Indicator Org page. Otherwise, the fields and pages are the same as described for the Add Service Indicator page and Add Service Indicator Org page.

See [Assigning a Service Indicator to an ID](#).

Field or Control	Description
Release	<p>Available only if the user has release security for the institution, service indicator, and reason.</p> <p>Click to release this service indicator from assignment to the ID. The system releases the service indicator and redirects you to the Manage Service Indicators page, which displays a list of the ID's service indicators.</p> <p>See “Setting Up Service Indicator Security” (Campus Solutions Application Fundamentals).</p>
Placed Method	If an automated process is assigned this service indicator, <i>background</i> appears. If the service indicator was assigned manually, <i>manual</i> appears. If the Mass Assign feature was used to assign the service indicator, <i>Mass</i> appears.
Placed Process	The system displays the name of the automated process that placed this service indicator on the individual's record.
Release Process	The system displays the name of the automated process that can release or remove this service indicator from the individual's record.

Auditing Service Indicators

This section discusses how to configure a service indicator audit search.

Pages Used to Configure an Audit Service Indicator Search

Page Name	Definition Name	Navigation	Usage
Audit Service Indicators	SCC_SI_AUDIT_SRCH	<ul style="list-style-type: none"> • Campus Community > Service Indicators > Person > Audit Service Indicators • Contributor Relations > Constituent Information > People > Service Indicators > Audit Service Indicators 	View an individual's service indicator history, including the date and time when a service indicator was added or deleted and the ID that added or deleted it.

<i>Page Name</i>	<i>Definition Name</i>	<i>Navigation</i>	<i>Usage</i>
Audit Service Indicators Org	SCC_SIA DT_ORG_SRCH	<ul style="list-style-type: none"> Campus Community > Service Indicators > Organizations > Service Indicators > Service Indicator Audits Org Contributor Relations > Constituent Information > Organizations > Service Indicators > Audit Service Indicators Org 	View an organization's service indicator history, including the date and time when a service indicator was added or deleted and the ID that added or deleted it.
Service Indicator Audit	SCC_SIAUDIT_DATA	Click the ID or Name link on the Audit Service Indicators search results page, or click the Org ID or Organization link on the Audit Service Indicators Org search results page.	View details of the individual's or organization's assigned service indicator.

Configuring a Service Indicator Audit Search

For individuals, access the Audit Service Indicators page (**Campus Community > Service Indicators > Person > Audit Service Indicators**).

For organizations, access the Audit Service Indicators Org page (**Campus Community > Service Indicators > Organizations > Service Indicators > Audit Service Indicators Org**).

Service Indicator Audit Search

You can enter as much or as little data as required to define your search. For example, you can enter a service indicator and search for all IDs to whom that indicator is assigned. Alternatively, you can enter the service indicator code, institution, start term and start dates, and assigned by ID and then search for all IDs within that institution to whom the indicator was assigned by the Assigned By ID and will become valid in that term on that date.

<i>Field or Control</i>	<i>Description</i>
Search	<p>Enter criteria to define the search, and then click Search.</p> <p>When you click Search, the system redirects you to a different view of the page, the Service Indicator Audits search results list view, which lists service indicator information based on that search.</p>

<i>Field or Control</i>	<i>Description</i>
Reset	<p>Click to clear the data fields so you can enter data for a new search.</p> <p>The Institution field will automatically repopulate with the user's default institution if one is defined in Operator Defaults. You can clear or change it manually, if necessary.</p>

Search Results

When you click **Search**, the Search Results list appears. Click the expand button next to Service Indicator Audit Search to see the top part of the Service Indicator Audits page, which shows the search criteria used to produce these results.

Click any link in the results row to access the Service Indicator Audit page for that ID, where you can view details about the service indicator assignment.

Mass Assigning or Mass Releasing Service Indicators

This section discusses how to:

- Mass assign service indicators.
- Mass release service indicators.

Pages Used to Mass Assign or Mass Release Service Indicators

<i>Page Name</i>	<i>Definition Name</i>	<i>Navigation</i>	<i>Usage</i>
Mass Assign	SCC_SRVC_IND	<ul style="list-style-type: none"> • Campus Community > Service Indicators > Person > Mass Assign • Contributor Relations > Constituent Information > People > Service Indicators > Mass Assign 	Assign a specific service indicator to several or many person IDs at the same time.

Page Name	Definition Name	Navigation	Usage
Mass Assign Org	SCC_SRVC_ORG	<ul style="list-style-type: none"> • Campus Community > Service Indicators > Organization > Mass Assign Org • Contributor Relations > Constituent Information > Organizations > Service Indicators > Mass Assign Org 	Assign a specific service indicator to several or many organization IDs at the same time.
Mass Release	SCC_SI_RELEASE	<ul style="list-style-type: none"> • Campus Community > Service Indicators > Person > Mass Release • Contributor Relations > Constituent Information > People > Service Indicators > Mass Release 	Release a specific service indicator from several or many person IDs at the same time.
Mass Release Org	SCC_SI_RELS_ORG	<ul style="list-style-type: none"> • Campus Community > Service Indicators > Organization > Mass Release • Contributor Relations > Constituent Information > Organizations > Service Indicators > Mass Release Org 	Release a specific service indicator from several or many organization IDs at the same time.

Mass Assigning Service Indicators

For individuals, access the Mass Assign page (**Campus Community > Service Indicators > Person > Mass Assign**).

This example illustrates the fields and controls on the Mass Assign page. You can find definitions for the fields and controls later on this page.

Mass Assign	
Run Control ID: PS	Report Manager Process Monitor <input type="button" value="Run"/>
Population Selection	
Selection Tool	PS Query
Query Name	QA_CS_CC_PS_SRVCIND_PERS <input type="button" value="Launch Query Manager"/> <input type="button" value="Preview Selection Results"/>
Service Indicator Data	
*Institution	PeopleSoft University
*Service Indicator Code	CMP <input type="button" value="Campaign 2000"/>
Reason	PROSP <input type="button" value="Major Prospect"/>
Effective Period	
Start Term	End Term
Start Date	End Date
	07/24/2006 <input type="button" value="B1"/>
Assignment Details	
*Department:	10000 <input type="button" value="Human Resources"/>
Reference:	
Amount	0.000
Currency Code:	USD <input type="button" value="Dollar"/>
Contact Information	
Contact ID:	Contact Person:
Placed Person ID:	Placed By:
	KU0007 <input type="button" value="Locherty, Betty"/>
Comments	

For organizations, access the Mass Assign Org page (**Campus Community > Service Indicators > Organization > Mass Assign Org**).

Select the tool that you want to use to assign the service indicator. Values are *Equation Engine*, *External File*, or *PS Query*.

Enter data to identify the service indicator to assign, just as you would on the Add Service Indicator page or the Add Service Indicator Org page.

When the Assign Service Indicators process runs (either SCC_SI_ASSN for individuals or SCC_ORG_ASSN for organizations), it assigns the specified service indicator to each ID in the selected population.

Mass Releasing Service Indicators

For individuals, access the Mass Release page (**Campus Community > Service Indicators > Person > Mass Release**).

This example illustrates the fields and controls on the Mass Release page. You can find definitions for the fields and controls later on this page.

Mass Release

Run Control ID: PS [Report Manager](#) [Process Monitor](#) Run

Population Selection

Selection Tool:

Query Name: [Launch Query Manager](#) [Preview Selection Results](#)

Service Indicator Data

*Institution:

*Service Indicator Code: No Refunds

Reason: Non Payment of Fees

Effective Period

Start Term: End Term:

Start Date: End Date:

For organizations, access the Mass Release Org page (**Campus Community > Service Indicators > Organization > Mass Release**).

Select the tool that you want to use to identify the population from which to release the service indicator . Values are *Equation Engine*, *External File*, or *PS Query*.

Enter or edit data to identify the service indicator to release, just as you would on the Edit Service Indicator page.

When the Service Indicator Release process runs (either SCC_SI_RELS for individuals or SCC_ORG_RELS for organizations), it will stop the service indicator from further validity for each ID in the selected population, and it will release the indicator from each ID record in the selected population. However, the service indicator assignment and release will remain part of the service indicator audit history.

Related Links

- [Using the Population Selection Process](#)
- [Viewing, Assigning, or Removing Service Indicators](#)

(USA) Managing PeopleSoft SEVIS Solution Visa Processing for J and F/M Visas

Understanding SEVIS Visa Processing

Student and Exchange Visitor Information System (SEVIS) is an internet-based system that electronically monitors and reports on international students and exchange visitors and their dependents. The U.S. Department of Homeland Security (DHS) maintains SEVIS. It is an integral part of the DHS program to improve data collection and reporting, facilitate compliance with regulations, and automate monitoring of school and exchange programs. The PeopleSoft SEVIS Solution collects data, monitors changes, and reports student and exchange visitor changes.

The PeopleSoft system extracts information and sends it to SEVIS to be reported to the DHS. You can audit the information after it is extracted. Once you are satisfied that it is correct, you can produce an XML file for transmission to SEVIS. The system verifies that the transmission was received, and it reports any errors. When you send changes to DHS, you receive an XML file from SEVIS that you use to import the results of the processing. You also receive PDF files containing any new I-20 or DS-2019 forms that are requested.

Understanding the Business Process Flow for Visa Processing

In this business process flow, it is assumed that you have completed the SEVIS setup in the PeopleSoft Campus Solutions system. This section discusses the PeopleSoft Campus Solutions-to-SEVIS batch interface functionality business process for student (F/M) visas and for exchange visitor (J) visas.

This flowchart illustrates the SEVIS visa processing business process. It shows the flow of the SEVIS alerts through to the XML log and SEVIS processor to the PeopleSoft database and printed I-20 or DS-2019 form.

PeopleSoft business process flow for SEVIS visa processing

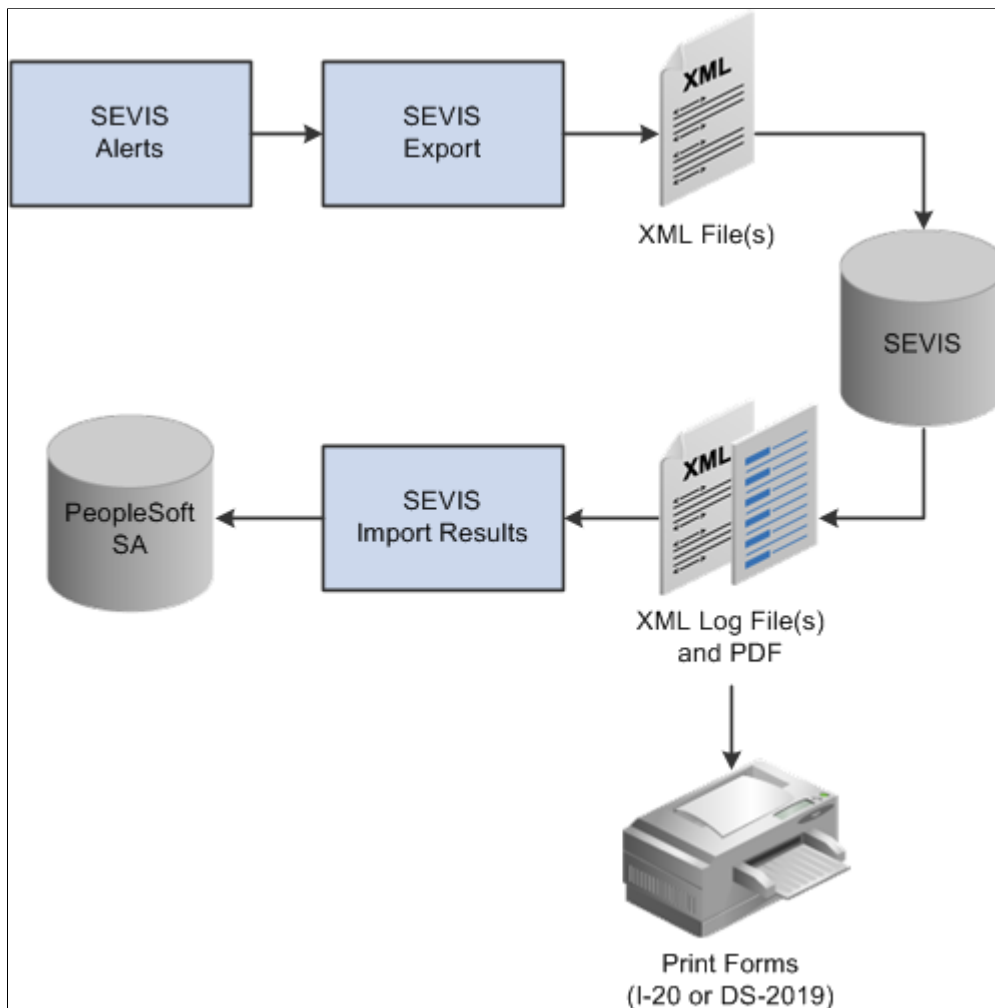

Identify New and Changed Data to Submit to SEVIS

Follow these steps for identifying new and changed data to submit to SEVIS.

1. Run the SEVIS Alerts process.

Run the appropriate SEVIS Alerts process (Process SEVIS Alerts - F/M or Process SEVIS Alerts - J). The process identifies information that should be submitted to SEVIS regarding new students (F/M visas) or exchange visitors (J visas) and data changes for existing students or exchange visitors. The process also verifies SEVIS business rules, required fields, and certain eligibility edits.

2. Use pages in the appropriate SEVIS Alerts component to evaluate the results of the SEVIS Alerts process.

Use the Select Alerts to Report - F/M component to evaluate results for all applicable school codes, and use the Select Alerts to Report - J component to evaluate results for all applicable program sponsors.

- a. Review all information with errors and take appropriate follow-up action.

Errors indicate transactional data that is missing or that needs to be changed before submission to SEVIS. You can update the SEVIS Master component if errors exist.

- b. Review all information requiring additional data.

Certain SEVIS events require you to enter additional data.

- c. Review all data set to send to SEVIS on the Alerts Header page.

The SEVIS Alerts process sets the **Send to** field to *SEVIS* based on the default value that is set on the SEVIS Event Types page, and includes the event in the XML file to send to SEVIS. If you do not want to include it in the XML file, change the **Send to** field to either *Master* or *None*.

- d. Select either *Master* or *None* for each remaining event.

Select *Master* (Master Sync) to directly update the SEVIS Master component with the data for the event without including it in the XML file. Select *None* to prevent an event from processing until you can review it.

- e. Save your changes to the Alerts Header page in the Select Alerts to Report component (Select Alerts to Report - F/M or Select Alerts to Report - J).

Export Data to SEVIS Master or to the XML File to Send to SEVIS

Run the SEVIS Export process for the appropriate visa type (Export SEVIS Events - F/M or Export SEVIS Events - J).

For events where the **Send To** field is set to *Master* on the Alerts Header page, the export process directly updates the active SEVIS Master row with the data from the event.

For events where the **Send To** field is set to *SEVIS*, the export process generates an XML file compliant with the SEVIS XML schema. The process creates multiple XML files if the number of records transmitted to SEVIS exceeds 100. The export process also populates the SEVIS Master component with an inactive row containing the data sent to SEVIS.

Upload XML Batch Documents to SEVIS

To upload the generated XML files to SEVIS, you must use a utility that supports secure sockets layer (SSL) and HTTPS. The XML batch document upload process is completed outside the PeopleSoft Campus Solutions system using the utility program of your choice. Consult the U.S. Immigrations and Customs Enforcement (ICE) web site for information regarding digital certificate registration and batch file transmission.

See [SEVIS: Technical Guidance and User Manuals](#).

Import the upload results transaction log using the SEVIS Import Results process.

Download XML Transaction Log and PDF Files from SEVIS

To download the XML transaction log files and any form PDF files (I-20 forms or DS-2019 forms) generated by SEVIS, you must use a utility that supports SSL and HTTPS. The XML transaction log and PDF files are compressed into a single file in zip format. You print the PDF files outside the PeopleSoft system.

Consult the U.S. Immigrations and Customs Enforcement (ICE) web site for information regarding retrieval and unzipping of the XML transaction log and PDF files.

Note: Carefully evaluate the *Application Program Interface (API)* to determine the period during which the batch process results remain available. The DHS SEVIS system automatically deletes files that are not downloaded within the specified period.

Import the XML Transaction Log Results

After the compressed batch result file is successfully downloaded and unzipped, import the XML transaction log result files into the PeopleSoft Campus Solutions system using the SEVIS Import Results process.

Run the SEVIS Import Results process for all applicable result files. Evaluate the transaction log results using the SEVIS Import Results pages. Review all transactions with errors and take appropriate follow-up action.

The import process also updates the SEVIS Master component to reflect the data successfully imported to SEVIS and populates the SEVIS ID Maintenance page with the SEVIS IDs for any new students or exchange students and their dependents.

Note: You must resolve eligibility errors returned by SEVIS before the next run of the SEVIS Alerts process. Allow enough time between reviewing the SEVIS XML transaction log results and running the process again so that you can modify student or exchange visitor and dependents transactional data to correct any errors.

Understanding the SEVIS Master Component

When you run the SEVIS Export process (Export SEVIS Events - F/M process or Export SEVIS Events - J process), all of the data that you export for submission to SEVIS is stored on pages in the SEVIS Master component (**Campus Community > SEVIS > SEVIS Maintenance > SEVIS Master**). The SEVIS Alerts process (Process SEVIS Alerts - F/M or Process SEVIS Alerts - J) compares the master data to the ongoing SEVIS data to detect updates to the student or exchange visitor and dependent data that should be subsequently submitted to SEVIS.

Warning! Do *not* manually update data on any of the SEVIS Master component pages unless you have made changes directly in the DHS SEVIS Real Time Interface (RTI) that cannot be processed using the Send to Master feature on the Alerts Header page. The data on the SEVIS Master component pages should always match the data on the RTI.

If the Education Level – Change event has been sent, two active rows are permitted on the Program and Financial tabs. Otherwise, each tab should have only one active status row. Update existing active rows. Do not manually add new rows.

Data in the SEVIS Master component is populated by either the SEVIS Extract Process (CCSEVEXT) or the SEVIS Master Sync Process (CCSEVSYF), both of which are part of the Export SEVIS Events process.

Send To SEVIS

If the **Send To** field on the Alerts Header page is set to *SEVIS* for an event, the system populates the SEVIS Master component when running the SEVIS Export process (Export SEVIS Events - F/M or

Export SEVIS Events - J). The data varies by event. The effective status of each record is set to *Inactive* until the SEVIS Import Results process runs.

When the Create event (Create Student or Create EV) event is successfully imported to SEVIS and the SEVIS Import process runs, the SEVIS Master component inactive rows are set to *Active*. If the Create event has errors, the system deletes the SEVIS Master component inactive rows. View the errors on the SEVIS Import Results inquiry page and determine how to correct them before running the SEVIS Alerts process for the relevant visa type again. The Create event appears on the Alerts Header page again when the SEVIS Alerts process runs for that visa type.

When the Update events are processed, an inactive effective status row is added to the appropriate record in the SEVIS Master component. If the event is successfully imported to SEVIS, the data sent to SEVIS is updated on the active effective status row in the SEVIS Master component and the inactive rows are deleted. If the Update event has errors, the inactive rows are deleted in the SEVIS Master component. View the errors on the SEVIS Import Results inquiry page and determine how to correct them before running the SEVIS Alerts process for the relevant visa type again. The Update event appears on the Alerts Header page again when the SEVIS Alerts process runs for that visa type.

The SEVIS Import process for F/M visas also updates the SEVIS status when the following events are successfully processed by SEVIS:

- Registration (Sets **SEVIS Status** to *Active*).
- Status – Cancel (Sets **SEVIS Status** to *Cancelled*).
- Status – Terminate (Sets **SEVIS Status** to *Terminated*).
- Status – Complete (Sets **SEVIS Status** to *Complete*).

The SEVIS Import process for J visas also updates the SEVIS status when the following events are successfully processed by SEVIS:

- Create EV (Sets **SEVIS Status** to *Initial*).
- Validate (Sets **SEVIS Status** to *Active*).
- Status – No Show (Sets **SEVIS Status** to *No Show*).
- Status – Terminate (Sets **SEVIS Status** to *Terminated*).
- Status – End (Sets **SEVIS Status** to *Inactive*).
- Status – Invalid (Sets **SEVIS Status** to *Invalid*).

Send To Master (Master Sync)

If the **Send To** field on the Alerts Header page is set to *Master*, the system populates the SEVIS Master component when the SEVIS Export process (SEVIS Master Sync – F/M or SEVIS Master Sync – J) runs. The data varies by event.

When the Create event (Create Student or Create EV) is processed using Master Sync, new active effective status rows are created for the Bio/Demo, Addresses, Program, Financial, Dependents (if any) and Employment/SOA (J Visa only) pages in the SEVIS Master component. **SEVIS Status** on the Program page is set to *Initial*.

Warning! You must, on the SEVIS ID Maintenance page, manually enter the IDs assigned by SEVIS to the student and their dependents for F/M visas or to the exchange visitor and their dependents for J visas. If the SEVIS IDs are not added, when you process the Update events, errors are detected and indicated in the Select Alerts to Report component (Select Alerts to Report - F/M or Select Alerts to Report - J).

When you process the Update events using Master Sync, data from the event is inserted into the appropriate effective status active row in the SEVIS Master component. The existing data on the active row is overwritten with the new data from the event. The data varies by event. In addition, **SEVIS Status** is updated if the event causes an update.

Creating and Updating Student or Exchange Visitor and Dependent Data

This section discusses how to:

- Create and update biographical data.
- Create and update addresses data.
- Create and update electronic addresses.
- Create and update phone numbers.
- Create and update visa and permit data.
- Create and update port of entry information for F and M visas.
- Create and update citizenship and passport data.
- Maintain SEVIS ID information.
- Create and update employment authorization information for F and M visas.

Pages Used to Create and Update Student or Exchange Visitor and Dependent Data

<i>Page Name</i>	<i>Definition Name</i>	<i>Navigation</i>	<i>Usage</i>
Biographical Details	SCC_BIO_DEMO_PERS	Campus Community > SEVIS > Personal Information > Add/Update a Person > Biographical Details	Enter or update basic biographical and demographic data for an individual.

Page Name	Definition Name	Navigation	Usage
Addresses	SCC_BIO_DEMO_ADDR	Campus Community > SEVIS > Personal Information > Add/Update a Person > Addresses	Update an individual's address information. <hr/> Note: This pages does not appear in the Add/Update a Person component when you add a new person. It appears only when you update an existing person. <hr/>
Addresses	ADDRESSES_89	Campus Community > Personal Information > Biographical > Addresses/Phones > Addresses	Enter or update an individual's address information.
Electronic Addresses	E_ADDR_PERS	Campus Community > Personal Information > Biographical > Addresses/Phones > Electronic Addresses	Enter or update an individual's email address data.
Phone Numbers	PHONE_PERS	Campus Community > Personal Information > Biographical > Addresses/Phones > Phones	Enter or update an individual's phone number.
Visa/Permit Data	SCC_VISA_PERMIT	Campus Community > SEVIS > Personal Information > Visa/Permit Data	Enter an individual's visa and permit information for SEVIS.
Visa/Permit Data Detail	VISA_PERMIT_DETAIL	Click the Visa/Permit link on the Biographical Details page.	Enter an individual's visa and permit information for SEVIS.
Citizenship/Passport Data	LS_CITIZEN_PASSPORT	Campus Community > SEVIS > Personal Information > Citizenship/Passport Data	Enter or update an individual's citizenship and passport data.
Citizenship Detail	SA_CITIZENSHIP_DTL	Click the Citizenship link on the Biographical Details page.	Enter or update an individual's citizenship and passport data.
SEVIS ID Maintenance	SEV_ID_MAINT	Campus Community > SEVIS > SEVIS Maintenance > SEVIS ID Maintenance	Enter or update an individual's SEVIS ID information.

Page Name	Definition Name	Navigation	Usage
Port of Entry Data	SEV_POE_DATA	Campus Community > SEVIS > Personal Information > Visa/Permit Data > Port of Entry Data	Track an individual's port of entry into the United States for F or M student visas.
Employment Authorizations	SEV_EMPL_AUTH	Campus Community > SEVIS > Employment Authorizations	Enter or update an individual's employment authorization information for F or M student visas.

Creating and Updating Biographical Data

Access the Biographical Details page (**Campus Community > SEVIS > Personal Information > Add/Update a Person > Biographical Details**).

The Biographical Details page in the SEVIS Add/Update component is the same as the Biographical Details page in the Personal Information, Add/Update component.

See [Adding or Updating Biographical Details Data](#).

SEVIS requires specific biographical data for each student and dependent. The SEVIS Export process pulls the required data from the Biographical Details page.

In addition to first and last names, the following fields must be completed for each student or exchange visitor and dependent:

Person Information

Field or Control	Description
Last Name	Enter the individual's last name.
Date of Birth	Enter the individual's date of birth.
Birth Information (link)	SEVIS requires that you enter the name of the individual's birth city (J Visa only) and country. Click the Birth Information link next to the Date of Birth field to enter the individual's birth city and country.

Biographical History

<i>Field or Control</i>	<i>Description</i>
Gender	Specify the individual's gender. Options are <i>Male</i> , <i>Female</i> , or <i>Unknown</i> .

(Links at Bottom)

<i>Field or Control</i>	<i>Description</i>
Visa/Permit Data	SEVIS requires that you identify the type of visa issued to the individual. Click the Visa/Permit Data link to enter the visa type.
Citizenship	SEVIS requires that you identify the individual's country of citizenship. Click the Citizenship link to the enter the country of citizenship.

Creating and Updating Addresses Data

Access the Addresses page (**Campus Community > SEVIS > Personal Information > Add/Update a Person > Addresses**).

Note: The Addresses page does not appear in the Add/Update a Person component (shown here) when you add a new person. It appears only when you update an existing person.

Note: The PeopleSoft system stores up to the ninth digit of the U.S. postal code in the SEVIS Master component to enable you to store bulk mail codes on the Addresses page as part of the postal code without affecting SEVIS processing. The alerts process compares up to the ninth digit of the postal code on the addresses record against the postal code stored in the SEVIS Master component. If the postal code for a U.S. address is too short (1-4 digits or 6-8 digits) when you run the export and alerts processes, an error appears on the Alerts page saying that the postal code is invalid. If the postal code is too long (greater than 9 digits), the process ignores everything after the ninth digit.

For F and M student visas, SEVIS requires a foreign address for each student with a creation reason of *Initial* or *Initial - Change of Status* on the I-20 form.

For exchange visitor J visas, SEVIS requires that each exchange visitor have a U.S. address when reporting the *Validate* event.

The address types reported to SEVIS are based on the types defined in the **US**, **Foreign** and **Mailing** fields on the SEVIS Setup page. You can view address data on the Biographical Details page, and edit the data on the Addresses page.

The following fields are required for the foreign address:

- Country
- Address 1

The following fields are required for the U.S. and Mailing addresses:

- Address 1
- City
- State
- Postal

Related Links

[Adding an Individual to Your Database](#)

[Adding or Updating Biographical Details Data](#)

Creating and Updating Electronic Addresses

Access the Electronic Addresses page (**Campus Community > Personal Information > Biographical > Addresses/Phones > Electronic Addresses**).

Email Information

Enter the individual's email address. The email address that you select as Preferred is reported to SEVIS as part of the Create Student, Personal Info, Dependent – Add and Dependent – Edit events for F and M visas, as well as the Create Exchange Visitor, Biographical and Validate events, Dependent – Add, and Dependent – Edit for J visas.

Email address is required for students for the Personal Info event. For other events, it is not required, but is reported when provided.

Note: The SEVIS Schema does not allow for sending a blank email address. If an alert is triggered due to an email address being removed, you will need to use SEVIS RTI to manually delete the email address.

Creating and Updating Phone Numbers

Access the Electronic Addresses page (**Campus Community > Personal Information > Biographical > Addresses/Phones > Phones**).

Enter the individual's phone numbers.

For J visas, provide a US phone number. The phone number you select as Preferred is reported to SEVIS as part of Biographical and Validate events.

For students, the US or international phone number you select as Preferred is reported to SEVIS as part of Personal Info events for F and M visas. If the student does not have a phone number, it is reported to SEVIS.

Creating and Updating Visa and Permit Data

Access the Visa/Permit Data page (**Campus Community > SEVIS > Personal Information > Visa/Permit Data**).

Visa/Permit Data

<i>Field or Control</i>	<i>Description</i>
Type	Enter the type of visa issued to the individual. For the PeopleSoft system to send the individual's information to SEVIS, the visa type that you enter must correspond to a visa type defined on the Visa Mapping page, which includes only <i>F</i> , <i>M</i> , or <i>J</i> visa types.
Number, Issue Date, and Expiration Date	Enter the visa number and appropriate dates. This information is not required or reported.

Related Links

[Entering Visa and Permit Data](#)

Creating and Updating Port of Entry Information for F and M Visas

Access the Port of Entry Data page (**Campus Community > SEVIS > Personal Information > Visa/Permit Data > Port of Entry Data**).

You can record data regarding a student's date and location of entry into the United States. The SEVIS system is the official record of this data, however, you might find it helpful to record this information in your PeopleSoft system.

Port of entry data is not required or reported.

Creating and Updating Citizenship and Passport Data

Access the Citizenship/Passport page (**Campus Community > SEVIS > Personal Information > Citizenship/Passport Data**).

Citizenship/Passport

<i>Field or Control</i>	<i>Description</i>
Country	Enter the country of citizenship to use on the I-20 form or the DS-2019 form. If you enter more than one non-U.S. country, you must indicate on the form which citizenship country to send to SEVIS.

Passport Information

<i>Field or Control</i>	<i>Description</i>
Passport Number, Issue Date, Expiration Date, and Country	Enter the passport number and associated information. This data is not required or reported.

Related Links

[Entering Citizenship and Passport Data](#)

Maintaining SEVIS ID Information

Access the SEVIS ID Maintenance page (**Campus Community > SEVIS > SEVIS Maintenance > SEVIS ID Maintenance**).

This example illustrates the fields and controls on the SEVIS ID Maintenance page. You can find definitions for the fields and controls later on this page.

SEVIS ID Maintenance

Ying Chu SEV1001

SEVIS Schools Find | View All First 1 of 1 Last

*SEVIS School Code: School: PeopleSoft University

SEVIS ID Find First 1 of 1 Last

*Effective Date: *SEVIS ID:

SEVIS Programs Find | View All First 1 of 1 Last

*SEVIS Program Number: Sponsored by:

SEVIS ID Find First 1 of 1 Last

*Effective Date: *SEVIS ID:

Note: When SEVIS processes the Create Student and Dependent - Add events for F/M visas or the Create EV and Dependent - Add events for J visas, it assigns SEVIS IDs to the new students or exchange visitors and dependents. You must manually enter the IDs assigned by SEVIS into your PeopleSoft system if you used the Send to Master option on the Alerts Header page to populate SEVIS Master for Create Student, Create EV or Dependent - Add events.

Use this page to store the SEVIS ID provided by the DHS for students or exchange visitors and their dependents. The SEVIS ID is an 11-character unique identifier that SEVIS uses for students and their dependents related to a specific school code and for exchange visitors and their dependents related to a specific program number. The system displays only the SEVIS IDs of the school codes or program numbers for which you have security clearance.

Running the SEVIS Import Results process for new students, exchange visitors, and dependents automatically populates the ID field. You may need to manually enter this value if you initially created the student or exchange visitor, or the dependent using the DHS SEVIS RTI.

SEVIS Schools for F and M Visas

<i>Field or Control</i>	<i>Description</i>
SEVIS School Code, Effective Date, and SEVIS ID	Enter each school code for which the student has an I-20 form or is listed as a dependent on an I-20 form. Enter the effective date of the SEVIS ID. Enter the unique 11-digit identifier for the student or dependent for the SEVIS school code.

SEVIS Programs for J visas

<i>Field or Control</i>	<i>Description</i>
SEVIS Program Number, Effective Date, and SEVIS ID	Enter each program number for which the exchange visitor has a DS-2019 form or is listed as a dependent on a DS-2019 form. Enter the effective date of the SEVIS ID. Enter the unique 11-digit identifier for the exchange student or dependent for the SEVIS school code.

Creating and Updating Employment Authorization Information for F and M Visas

Access the Employment Authorizations page (**Campus Community > SEVIS > Employment Authorizations**).

This example illustrates the fields and controls on the Employment Authorizations page. You can find definitions for the fields and controls later on this page.

Employment Type

Field or Control	Description
Employment Type	Select the employment type relevant to the authorization or endorsement for this student. Options are: <i>Curricular Practical Training (CPT)</i> <i>Optional Practical Training (OPT)</i> <i>Off-Campus</i> (to enter recommendation information for the student to obtain off-campus employment authorization) M-1 students are authorized for OPT only. The system does not enable you to enter CPT or off-campus employment for an M-1 student. F-1 students are eligible for all employment authorizations.

Note: The fields in the Employment Details group box remain the same for CPT and OPT. The system displays different fields when you enter the *Off-Campus* employment type.

Employment Details (for CPT and OPT employment types)

Field or Control	Description
Sequence Number	Displays the number that the system uses to track multiple rows.
Completion Type	<p>This field appears only for the Employment Type of <i>Optional Practical Training</i> for F-1 visas.</p> <p>Values are:</p> <p><i>Pre Completion</i></p> <p><i>Post Completion</i></p> <hr/> <p>Note: For <i>Pre Completion</i>, the OPT end date must be on or before the program end date. For <i>Post Completion</i>, the OPT start date must be on or after the program end date.</p> <hr/>

Field or Control	Description
Request Status	<p>This field appears for the Employment Types of <i>Optional Practical Training (OPT)</i> and <i>Off-Campus Employment</i>.</p> <p>For OPT, the Request Status field value is used in combination with other values on the Employment Authorizations page to trigger the OPT Employment – Extend and OPT Employment – Edit events. For example, if the Extension check box is selected and the Request Status is <i>Approved</i>, the Extend event is triggered.</p> <p>Values are:</p> <p><i>Requested</i></p> <p><i>Pending</i></p> <p><i>Approved</i></p> <p><i>Canceled</i></p> <p><i>Denied</i></p> <p><i>Unknown</i></p> <p><i>Withdrawn</i></p> <p>The default value is <i>Requested</i>.</p> <hr/> <p>Note: For rows existing prior to SEVIS 6.0, the Request Field value is set to <i>Unknown</i> in the system. You must change the value for all current OPT students to trigger the appropriate event.</p> <hr/> <p>Note: Automatic status change updates are not sent as part of the SEVIS Batch process. You must manually update this field when the status changes.</p> <hr/> <p>Warning! For OPT, SEVIS accepts changes to the Start Date, End Date, Employment Code, Completion Type or Academic Year Met fields only when the Request Status field is set to <i>Requested</i> or <i>Pending</i>.</p> <hr/>
Academic Year Met	<p>This check box appears for the Employment Type of <i>Optional Practical Training (OPT)</i>.</p> <p>Select to indicate that the student has met the full academic year requirement for OPT.</p>

Field or Control	Description
Cancel Employment	<p>Select this check box to trigger the CPT Employment - Cancel or the OPT Employment - Cancel event. If Request Status = Approved, Cancel Employment events do not appear in the Alerts record</p> <p>The start date must be later than the current system date for CPT Employment.</p> <p>Cancellation of OPT Employment may be performed only prior to determination of the OPT by the Service Center.</p> <p>Can</p>
Start Date	Enter the date when the employment is expected to begin.
End Date	<p>Enter the date when the employment is expected to end.</p> <hr/> <p>Note: Review DHS regulations to ensure that you comply with the most recent duration rules for the employment type before entering the authorization start and end date.</p> <hr/> <p>The Curricular Practical Training (CPT) employment type requires that the end date be not later than the end date for the student on the I-20 form.</p> <p>See the U.S. Immigration and Customs Enforcement website for regulations regarding employment duration.</p> <p>The authorization end date affects the Program – Complete event trigger.</p> <p>See Running the SEVIS Alerts Process.</p>
Employment Code	Select either <i>Part-time</i> or <i>Full-time</i> .

Field or Control	Description
<p>Extension</p>	<p>This check box appears only for the Employment Type of <i>Optional Practical Training</i> for F-1 visas. The Extension field value is used in combination with the Request Status value to trigger the OPT Employment – Extend event. For example, if the Extension check box is selected and the Request Status is <i>Approved</i>, the Extend event is triggered.</p> <p>If you select this check box:</p> <ul style="list-style-type: none"> • At least one employer should be selected as extension employer. • Extension Employer check box is enabled for each employer record where the Self-Employed check box is not selected. <hr/> <p>Note: The SEVIS Batch process accepts only requests where Request Status is <i>Approved</i> and Completion Type is <i>Post Completion</i>. Go to the U.S. Immigration and Customs Enforcement website for regulations regarding eligibility for extensions.</p> <hr/>
<p>Extension Start Date</p>	<p>This field appears only for the Employment Type of <i>Optional Practical Training</i> (OPT) when the Extension check box is selected.</p> <p>The system automatically enters an Extension Start Date of OPT end date plus one day. You cannot edit this date.</p> <p>The SEVIS Batch process does not send the Extension Start Date value to SEVIS.</p>
<p>Extension End Date</p>	<p>This field appears only for the Employment Type of <i>Optional Practical Training</i> (OPT) when the Extension is selected.</p> <p>The system automatically enters an extension end date of the OPT extension start date plus 24 months.</p> <p>You can edit this date, and may want to do so when a Cap-Gap extension is approved.</p> <p>The SEVIS Batch process does not send the Extension End Date value to SEVIS.</p>

Field or Control	Description
Course Relevance	If there is only one Employer record, or the same Course Relevance information is relevant for multiple employers, enter remarks identifying the relevance of the employment to the student's course of study. If different Course Relevance information is required for different employers or the information exceeds 250 characters, enter the information for each employer in the Employer Details region.
Student Remarks	This field appears only for the Employment Type of <i>Optional Practical Training</i> (OPT). Student remarks are optional, but are submitted to SEVIS when provided.
Employment Remarks	Remarks here are optional, but are submitted to SEVIS when provided.

Employer Details for OPT and CPT Employment Types

This region is available only for Optional Practical Training (OPT) and Curricular Practical Training (CPT) employment types, and displays records from the SEVIS Employer Address page of the parent record. Use this region to add additional employer records for users with OPT employment type.

This example illustrates the fields and controls on the Employer Details Grid for OPT Employment Type. Only some fields are shown for CPT and only one Employer Details record can be defined for CPT. You can find definitions for the fields and controls later on this page.

Field or Control	Description
Employer Number	This field is used to uniquely identify the employer within the alerts and master records, but is not sent to SEVIS.
Self Employed	If you select this check box, the Employer record cannot be defined as an extension employer.
External Org ID	Optional. If you select an External Org ID, the Employer Name and address fields are populated.

Field or Control	Description
Employer Name	<p>This field is required to save the employer details record. Records where Employer Number is 1 and an Employer Name is not defined are not considered by the alerts process.</p> <p>If you select Self Employed and this field is blank, then it is populated with the student's primary name. You can edit this field.</p>
Identification Number	Optional. Zero values are not displayed nor reported.
Address 1, Address 2, City, State, Postal Code	<p>If you select Self Employed and this field is blank, then it is populated with the student's address. The address type should match the US address type defined in SEVIS Setup.</p> <p>Address 1, City, State, and Postal Code are required to save an employer record.</p>
Employment Code	If you do not define a value, then it is derived from the parent employment record.
Extension Employer	<p>Select to indicate that this is the employer associated with the extension.</p> <p>This check box is enabled only if you selected the Extension check box in the OPT Extension region. When you select Extension, one or more existing employers can be selected as extension employers and the updated Employer Start Date and End Date reflect the extension dates. Alternatively, new employer records can be added specifically for the extension.</p>
Employer Start Date	<p>Optional. If you set a date, it must be on or after the Start Date of the parent employment record. Otherwise, the value is derived from the parent employment record.</p> <p>If you selected Extension Employer, the Employer Start Date must be on or after the Extension Start Date of the parent employment record.</p>
Employer End Date	<p>Optional. If you set a date, it must be greater than the Employer Start Date and on or before any End Date of the parent employment record.</p> <p>If you selected Extension Employer, the Employer End Date must be on or before any Extension End Date of the parent employment record.</p>

Field or Control	Description
Course Relevance	If you do not enter a value, then it is derived from the parent employment record. A value should be defined either for the employer or the parent employment record. This field allows 1000 characters.
Supervisor ID	If you select an ID, the Supervisor First and Last Name, Phone, and Email fields are populated based on the primary name and preferred phone and email records.

Note: Employer records that have been deleted in RTI at SEVIS can be deleted here, and should also be deleted from SEVIS Master.

Employment Details (for Off-Campus Employment Type)

When you enter the employment type of *Off Campus*, the fields in the **Employment Details** group box change.

This example illustrates the fields and controls on the Employment Authorizations (Off-Campus Employment Type) page. You can find definitions for the fields and controls later on this page.

Employment Authorizations

ID: SEVRT13 Jeffrey Harold
 SEVIS School Code: SEA214F00078000 SEVIS Batch Test School

Employment Type Find | View All First 2 of 3 Last
 *Employment Type: Off-Campus

Employment Details Find | View All First 1 of 1 Last
 Sequence number: 1 Request Status: Requested
 Cancel Employment
 Start Date: End Date:
 *Reason:
 Recommendation: Off-campus employment is recommended due to student's loss of funding support from his family. Parents no longer able to send monthly support due to economic collapse in home country.
 67 characters remaining

Field or Control	Description
Sequence Number	Displays the number that the system uses to track multiple rows.
Cancel Employment	Select to trigger the Off Campus Employment - Cancel event.

Field or Control	Description
Start Date	<p>Enter the date when the employment is expected to begin.</p> <hr/> <p>Note: To trigger the Off Campus Employment - Cancel event, the start date must be later than the current system date.</p> <hr/>
End Date	<p>Enter the date when the employment is expected to end.</p> <p>The date entered must be earlier than or equal to the I-20 Program To Date value.</p>
Reason	<p>The available options are <i>Economic Hardship</i>, <i>International Organization</i>, and <i>Special Student Relief</i>.</p> <p>The DHS defines the reasons in the Student Off-Campus Employment Codes section of the Lookup Tables in the <i>Application Program Interface</i> on the U.S. Immigrations and Customs Enforcement (ICE) web site.</p> <p>See Reference Manual for the Student and Exchange Visitor Information System Batch Interface, Application Program Interface (API).</p>
Request Status	<p>This field appears only for the Employment Types of <i>Optional Practical Training (OPT)</i> and <i>Off Campus Employment</i>.</p> <p>Values are:</p> <p><i>Requested</i></p> <p><i>Pending</i></p> <p><i>Approved</i></p> <p><i>Canceled</i></p> <p><i>Denied</i></p> <p><i>Unknown</i></p> <p><i>Withdrawn</i></p> <p>The default value is <i>Requested</i>.</p> <hr/> <p>Note: Automatic status change updates are not sent as part of the SEVIS Batch process. You must manually update this field when the status changes.</p> <hr/>

<i>Field or Control</i>	<i>Description</i>
Recommendation	Enter general remarks regarding the student's off-campus employment. Remarks are not required, but are submitted if provided.

Tracking Full Course Load Exceptions for F and M Visas

This section discusses how to:

- Track full course load exception rules.
- Track external full course load exceptions.
- Assign full course load exceptions in batch.

Pages Used to Track Full Course Load Exceptions for F and M Visas

<i>Page Name</i>	<i>Definition Name</i>	<i>Navigation</i>	<i>Usage</i>
Full Course Exceptions	SEV_FULCRS_EXCP	Campus Community > F/M Full Course Exceptions > Full Course Exceptions	Enter or update exceptions to the full course load for an individual with an F or M visa.
External Full Course Exception	SEV_FULCRS_EXCP2	Campus Community > SEVIS > F/M Full Course Exceptions > External Full Course Exception	Enter or update information for exceptions to the full course load for an individual with an F or M visa when using the External System Extract process.
Full Course Exception Load	RUNCTL_CCSEVFCE	Campus Community > SEVIS > F/M Full Course Exceptions > Full Course Exception Load	Process information for exceptions to the full course load by student group or job code for individuals with F or M visas.

Tracking Full Course Load Exception Rules

Access the Full Course Exceptions page (**Campus Community > F/M Full Course Exceptions > Full Course Exceptions**).

You can specify exception units for students who are not enrolled for a full course of study as defined by the academic level and load rules. You can then track students who have your institution's permission to enroll in less than a full course of study. You are not required to submit to SEVIS the Auth Drop Below Full Course - Add event for those students. For example, a graduate assistant who, by institutional

agreement and definition, enrolls for fewer units than typical graduate-level students, might not drop below full-time.

The SEVIS Alerts - F/M process evaluates data entered for students who are not enrolled full-time, but whose data is entered for the combination of institution, career, and term that the process uses.

The page displays the eligible institutions and careers in which the student is eligible to enroll. Enter multiple rows with the term and exception units for students who are granted exceptions that span multiple terms.

You can also use the Full Course Load Exception process to populate this page for large groups of students.

The system displays the student name, ID, school code, school, institution, and career.

Field or Control	Description
Term	Select the term value for which you are granting the student an exception. The only terms available are those in which the student has been term-activated and in which the student is eligible to enroll.
Exception Units	Enter the full-time exception units that the student is granted. The External System Extract process evaluates this value to determine the full course status populated in the extract XML file. You can enter <i>0.000</i> for the exception units.
Comments	Enter comments if appropriate.

Tracking External Full Course Load Exceptions

Access the External Full Course Exception page (**Campus Community > SEVIS > F/M Full Course Exceptions > External Full Course Exception**).

You can specify exception units for students who will not be enrolled for a full course of study as defined by the academic level and load rules. You can then track students who have your institution's permission to enroll in less than a full course of study. The exception entered here determines the full-time status populated in the External System Extract process.

The page displays the eligible institutions and careers in which the student is eligible to enroll. Enter multiple rows with the term and exception units for students granted exceptions that span multiple terms.

You can also use the Full Course Load Exception process to populate this page for large groups of students.

Field or Control	Description
Institution and Career	Select the institution and career for which the student is term-activated.
Term	Select the term value for which you are granting the student an exception. The only terms that appear are those in which the student is term-activated and in which the student is eligible to enroll.
Exception Units	Enter the exception units considered full-time that the student is granted. The External System Extract process evaluates this value to determine the full course status populated in the extract XML file. You can enter <i>0.000</i> for the exception units.
Comments	Enter comments if appropriate.

Assigning Full Course Load Exceptions in Batch

Access the Full Course Exception Load page (**Campus Community > SEVIS > F/M Full Course Exceptions > Full Course Exception Load**).

The Full Course Exception Load page enables you to assign a full course exception for a group of students in either a specific student group or with a specific job code rather than adding an exception one student at a time.

You can use this process to populate the Full Course Exceptions page or the External Full Course Exception page depending on the processing type that you select. You can add multiple rows if you have more than one student group or job code from which you want to select students. If a student meets the criteria for more than one group, the process assigns the lowest **Exception Units** to the student.

Field or Control	Description
SEVIS School Code	For the direct interface, select the school code from which to select the students. For the External Extract process, select the school code that you want to use for each student granted the full course exception.

Field or Control	Description
Processing Type	<p>Select the appropriate option based on the process that your institution uses to report data to SEVIS. The options for processing type are <i>Direct Interface</i> and <i>External Extract Process</i>.</p> <p>The <i>Direct Interface</i> option selects students with an F-1 or M-1 visa status who have an I-20 record for the selected school code and who are term-activated for the combination of institution, career, and term indicated, and who belong to either the student group or job code indicated.</p> <p>The <i>External Extract Process</i> option selects students with an F-1 or M-1 status who are term-activated for the combination of institution, career, and term indicated and who belong to either the student group or job code indicated.</p>
Report Only	<p>Select to run the process to obtain a listing of the students selected without inserting the data into the student's record. This enables you to check the student population selected before the data is populated.</p> <p>Clearing the Report Only field allows the data to populate on the Full Course Exceptions page for the students selected.</p>
Student Group	Select the appropriate student group.
SetID	Select the setID for the job code.
Job Code	Select the appropriate job code.
Term	Enter the term to appear on the Full Course Exceptions page or External Full Course Exception page.
Exception Units	Enter the exception units to appear on the Full Course Exceptions page or the External Full Course Exception page.
Comment	Enter a comment to appear on the Full Course Exceptions page or External Full Course Exception page.

When you run the External System Export process, the XML indicates the full-time status of the student by using the full course exception entered.

For example, suppose that a student is enrolled for nine hours and the level and load rules designated this a three-quarters time. A full course exception of nine hours is entered for the student, so the full-time status for the student is set to *Y* on the XML output, as shown in the following code sample. In addition, two fields are added to the XML output: the **Full Course Override** field and the **Full Course Exception Units** field.

```
<EducationalInfo>
  <FullTime>Y</FullTime>
  - <AcademicData>
```

```

<Institution>PSUNV</Institution>
<InstitutionDescr>PeopleSoft University</InstitutionDescr>
<Career>UGRD</Career>
<CareerDescr>Undergraduate</CareerDescr>
<SEVISSchoolCodeId>DAL214F12345123</SEVISSchoolCodeId>
<AdmitTerm>0487</AdmitTerm>
<AdmitTermDescr>2003 Spring</AdmitTermDescr>
<EnrollTerm>0487</EnrollTerm>
<EnrollTermDescr>2003 Spring</EnrollTermDescr>
<PrimaryMajorCIPCode>42.0101</PrimaryMajorCIPCode>
<PrimaryMajor>PSYCH</PrimaryMajor>
<PrimaryMajorDescr>Psychology</PrimaryMajorDescr>
<AcademicProgram>LAU</AcademicProgram>
<AcademicProgramDescr>Liberal Arts Undergraduate</AcademicProgramDescr>
<ProgramAction>ACTV</ProgramAction>
<ProgramActionDescr>Activate</ProgramActionDescr>
<ProgramStatus>AC</ProgramStatus>
<ProgramStatusDescr>Active in Program</ProgramStatusDescr>
<AcademicLoad>H</AcademicLoad>
<AcademicLoadDescr>Enrolled Half-time</AcademicLoadDescr>
<CourseUnits>9.000</CourseUnits>
<FullCourseOverride>Y</FullCourseOverride>
<FullCourseExceptionUnits>9.000</FullCourseExceptionUnits>
<CurrentSessionEndDate>2003-05-15</CurrentSessionEndDate>
<NextSessionStartDate>2003-08-27</NextSessionStartDate>
<ExpectedGradTerm>0505</ExpectedGradTerm>
<ExpectedGradTermDescr>2003 Fall</ExpectedGradTermDescr>
<PrgStartDate>2003-01-20</PrgStartDate>
</AcademicData>

```

Creating and Updating Student Data for I-20 Forms for F and M Visas

The I-20 form pages included in Campus Solutions display relevant I-20 form data in a sequence similar to the I-20 form document produced by SEVIS. The SEVIS system produces the actual I-20 form in PDF format using data provided by your institution.

Campus Solutions' I-20 Form pages are keyed by the student's ID and school code. Access to the form is controlled through SEVIS school code security.

To decrease data entry time, use the I-20 template to populate default values for many of the fields on the I-20 form.

Note: Campus Solutions requires that any student for whom you are entering I-20 form data must have an appropriate F-1 or M-1 visa type defined on the Visa/Permit Data page.

This section discusses how to create and update I-20 form data.

Pages Used to Create and Update Student Data for I-20 Forms for F and M Visas

Page Name	Definition Name	Navigation	Usage
I-20 Form	I20_FORM	Campus Community > SEVIS > I-20 Forms > I-20 Form	Create or update I-20 information.
Program Selection	SEV_I20_SEL_SEC	Click the Select Program Data link on the I-20 Form page.	Select an institution, career, and academic program combination.

Entering I-20 Form Data

Access the I-20 Form page (**Campus Community > SEVIS > I-20 Forms > I-20 Form**).

This example illustrates the fields and controls on the I-20 (Certificate of Eligibility for Non-immigrant Student Status) Form page (1 of 3). You can find definitions for the fields and controls later on this page.

I-20 Form
Corinne Farine
SEV0109

School Code BBB111F5555555 SEVIS 5.0 Various Tests
SEVIS Status Active

SEVIS ID N4444444444

I-20 Form Details
Find First 1 of 1 Last

*Effective Date 06/25/2008
*Status Active

Cancellation Reason

Cap Gap Status

Institution PSUNV PeopleSoft University
Career GRAD Graduate
Acad Prog GLAU Graduate Liberal Arts Programs
Admit Term 0504 Test - Current Term Sevis

[Select Program Data](#)

Student Information

Family Name Farine
First Name Corinne
Preferred Name
Passport Name
Email Address
Phone
Birth Country CHE Switzerland
*Citizenship Country CAN Canada

Middle Name
Date of Birth 06/17/1974

Admission Nbr
Birth Location Olten

[Addresses](#)

SEVIS Commuter

US Address

Address 1 123 Test
Address 2
City Mesa
State AZ Arizona

Postal 85207

Explanation Code

Explanation Text

This example illustrates the fields and controls on the I-20 (Certificate of Eligibility for Non-immigrant Student Status) Form page (2 of 3). You can find definitions for the fields and controls later on this page.

Foreign Address			
Address Line 1	1234 Test		
Address Line 2			
City	Calgary		
State	AB Alberta		
Country	CAN Canada		
Postal	W3E 4R5		
School Information			
School Official	Demitris Dorn	Title	School Official
Address 1	9900 N CENTRAL AVE		
City	MESA		
State	AZ	Postal	85207
Approval Date	01/01/2005		
Student Creation Reason			
<input checked="" type="radio"/> Initial Creation	<input type="radio"/> Initial - Change of Status		
<input type="radio"/> Continued Attendance	<input type="radio"/> Reinstatement Request		
<input type="radio"/> School Transfer	<input type="radio"/> Other		
*Level of Education	Masters	Comment	
The student has been accepted for a full course of study			
Primary Major	English (MA)	CIP Code	23.0401
Secondary Major		CIP Code	
Minor		CIP Code	
Length of Study	24 Months	From Date	05/25/2006
Initial Session Start Date		To Date	05/25/2008
<input checked="" type="checkbox"/> English Proficiency Required	<input checked="" type="radio"/> Student is proficient	<input type="radio"/> Student is not proficient yet	

This example illustrates the fields and controls on the I-20 (Certificate of Eligibility for Non-immigrant Student Status) Form page (3 of 3). You can find definitions for the fields and controls later on this page.

School estimates student average academic cost for

*Months in an Academic Term

Tuition and Fees Other Expenses Description

Living Expenses Dependent Expenses Total \$38500

Student means of support for the above length of time

Student's Personal Funds Funding Verified

Funds from this School Funding Remarks

Funds from Another Source

On-Campus Employment 500 characters remaining

Total \$39000

School Certification

*School Official Demitris Dorn

Title

Date Issued

City MESA

State AZ Arizona

Dependent Information Personalize | Find | | First 1 of 1 Last

Dependent Data Dependent Comments Dependent Names

ID	Name	Email Address	*Relationship Status	*Relationship
<input type="text"/>			Active	Child

Create Remarks

Remarks

500 characters remaining

This example illustrates the fields and controls on the I-20 (Certificate of Eligibility for Non-immigrant Student Status) Form page (4 of 4), Program Selection page. You can find definitions for the fields and controls later on this page.

Program Selection Customize | Find | View All | First 1 of 1 Last

Selected	Academic Institution	Academic Career	Academic Program	Admit Term	Status
<input checked="" type="checkbox"/>	PeopleSoft University	Undergraduate	Liberal Arts Undergraduate	Cur Sevis	Active

I-20 Form Details

Field or Control	Description
SEVIS Status	Displays the status of the student as reflected in the SEVIS Master component.

Field or Control	Description
Status as of Effective Date	<p>Enter the status as of the effective date. The default value is <i>Active</i>.</p> <p>Only active I-20 form rows are included in the SEVIS Alerts - F/M process.</p>
Cancellation Reason	<p>If canceling the visa request, enter the cancellation reason.</p> <p>Entering a Cancellation Reason will trigger the Status - Cancel event if the student has a SEVIS Status of <i>Initial</i>.</p> <p>Available reasons include:</p> <p><i>Arrived under different ID</i></p> <p><i>Offer withdrawn</i></p> <p><i>Record created in error</i></p> <p><i>Registered under different ID</i></p> <p><i>Student not attending</i></p> <p><i>Visa for different SEVIS ID</i></p>
Cap-Gap Status	<p>Enter a value if requesting a Cap-Gap extension.</p> <p>Values are:</p> <p><i>Cancelled</i></p> <p><i>Filed</i></p> <p><i>Waitlisted</i></p> <p>The value triggers the CapGapExtension event if the I-20 end date is less than or equal to the system current date.</p>
Institution, Career, Acad Program (academic program), and Admit Term	<p>The system displays the following:</p> <p>The institution entered for the student.</p> <p>The career entered for the institution.</p> <p>The academic program entered for the career.</p> <p>The admit term entered for the student in the specified program.</p>

Field or Control	Description
Select Program Data	<p>Click to access the Program Selection page where you can determine if more than one combination of institution, career, academic program, and admit term exists for the student.</p> <p>If more than one exists, select the check box on the Program Selection page for the line that contains the information that you want to print on the I-20 form.</p> <p>The valid institutions for the school code and the valid careers for the institution are based on the setup of the SEVIS School Code table.</p>

Student Information

Field or Control	Description
Family Name, First Name, and Middle Name	<p>Displays the student's last, first, and middle names according to the respective name type entered on the SEVIS Setup page.</p> <hr/> <p>Note: You must make any name changes on the Biographical Data page.</p> <hr/> <p>See Entering Biographical Details.</p>
Preferred Name	<p>Displays the first, middle, last names, and suffix according to the most recent, non-future effective-dated name record for the name type defined in the Preferred Name field on the SEVIS Setup page.</p> <p>This field is blank if the student does not have a name of the defined name type.</p> <p>This field appears <i>only</i> when a name type is defined in the Preferred Name field in the SEVIS Setup page.</p>
Passport Name	<p>Displays the last, first, and middle names, according to the most recent, non-future effective-dated name record for the name type defined in the Passport Name field on the SEVIS Setup page.</p> <p>This field is blank if the student does not have a name of the defined name type.</p> <p>This field appears <i>only</i> when a name type is defined in the Passport Name field in the SEVIS Setup page.</p>

<i>Field or Control</i>	<i>Description</i>
Date of Birth	Displays the birth date that is entered on the Biographical Details page.
Email Address	Displays the student's preferred email address.
Birth Country	Displays the country of birth that is entered on the Biographical Details page.
Citizenship Status	(Required) This field appears only when the birth country is USA or a U.S. territory.
Admission Number	Displays the I-94 admission number that is entered on the Port of Entry Data page.
Citizenship Country	Select the citizenship country to report to SEVIS. If the student has only one non-U.S. citizenship country, the system displays it by default. This field is required.
SEVIS Commuter	Select if the student is a commuter student. The commuter student indicator is valid only for students whose country of citizenship is Canada or Mexico. Commuter students are not required to provide U.S. address data.
Birth Location	Displays the location of birth that you entered through the Birth Information link on the Biographical Details page.

US Address

<i>Field or Control</i>	<i>Description</i>
Address 1, Address 2, City, and State	Displays the student's address based on the address type that is defined on the SEVIS Setup page for the U.S. address.
Explanation Code	Select the override reason for an address that does not pass SEVIS validation. This reason is included in the alert.

Field or Control	Description
Explanation Text	This field is enabled only when you select <i>Other override</i> in the Explanation Code field. Enter the reason for the override.

Foreign Address

Field or Control	Description
Address 1, Address 2, City, State, Postal, and Country	Displays the student's address based on the address type that is defined on the SEVIS Setup page for the Foreign address.

School Information

Displays the school official, title, address, and approval date information from the School Information section of the SEVIS School Code table.

Student Creation Reason

You can select only one reason. Options are:

Initial Creation

Initial - Change of Status

Continued Attendance

School Transfer Causes the **Transfer Date** field and text box to appear. You can enter the date, and in the text box, enter the name of the school from which the student transferred.

Reinstatement Request

Other Causes a text box to appear where you must also enter an explanation.

Note: SEVIS accepts the creation reasons of *Initial* and *Initial - Change of Status* in batch processing only.

Additionally, Release 6.33 requires a US address for Create Student events when the Issue Reason = S (*Initial-Change of Status*).

Field or Control	Description
Level of Education	<p>Enter the individual's level of education. The options are based on the visa type entered for the student on the Visa/Permit Data page.</p> <p>If a visa type is not entered for the student on the Visa/Permit Data page, no options are available here.</p> <p>This value may appear by default from the I-20 template.</p> <hr/> <p>Note: A student must have a visa type on the Visa/Permit Data page for the system to send the student's information to SEVIS.</p> <hr/> <p>Values for F-1 visa classification are <i>Primary, Secondary, Associate, Bachelor's, Master's, Doctorate, High School, Language Training, and Other</i>.</p> <p>Values for M-1 visa classifications are <i>High School, Flight Training, and Other Vocation School</i>.</p>
Comment	<p>Click to enter remarks related to the student's level of education.</p> <p>Comments are required when the Level of Education field value is set to <i>Other</i>. Otherwise comments are optional.</p> <p>All comments are sent to SEVIS when provided.</p>

The student has been accepted for a full course of study

<i>Field or Control</i>	<i>Description</i>
<p>Primary Major,Secondary Major, and CIP Code</p>	<p>Primary major and secondary major information comes from the academic plan in the PeopleSoft Student Records Student Program/Plan component. The primary major is from the academic plan with the minimum sequence number and the secondary major is from the academic plan with the second most minimum sequence number, both are where the plan type is one of the selected major plan types on the SEVIS Setup page.</p> <p>See “Maintaining Student Program Stacks” (Student Records).</p> <p>If no data exists for the academic plan, the information comes from the academic plan on the application in the PeopleSoft Student Admissions Maintain Applications component.</p> <p>See “Updating Applications” (Recruiting and Admissions).</p> <p>The CIP code is the code related to the academic plan as assigned on the Taxonomy page in the Academic Plan Table component (Set Up SACR > Foundation Tables > Academic Structure).</p> <p>The CIP code is reported to SEVIS.</p> <p>See “Defining Academic Plans” (Campus Solutions Application Fundamentals).</p>
<p>Minor and CIP Code</p>	<p>The minor is determined on the SEVIS Setup page.</p> <p>The system compares information from either the Student Records academic plan or academic subplan where the plan types are equal to those on the SEVIS Setup page.</p> <p>The minor selected is the minimum sequence number with the indicated plan type related to the primary major.</p> <p>If no data exists for the Student Records academic plan or subplan, the information comes from the PeopleSoft Admissions academic plan or subplan on the application in the Maintain Application component.</p> <p>The CIP code is the code related to the academic plan or academic subplan as assigned on the Taxonomy page in the Academic Plan component or the Academic Sub-Plan Taxonomy page in Academic SubPlan Table component (Set Up SACR > Foundation Tables > Academic Structure).</p> <p>The CIP Code is reported to SEVIS.</p>

Field or Control	Description
Length of Study	<p>Enter the number of months normally required for completing the program that the student undertakes.</p> <p>This value may also display by default from the I-20 template.</p> <p>From SEVIS release 6.27, this value is no longer reported to SEVIS.</p>
From Date	<p>By default, the system displays the start date of the student's Admit Term from the Student Records Student Program/Plan page or the Admissions Application Program Data page as the date when the student's program begins.</p> <p>You can modify this.</p> <p>If sending the Create Student event to SEVIS and the student creation reason is <i>Initial</i> or <i>Initial - Change of Status</i>, the from date must be later than or equal to the current system date.</p> <p>If the Student Creation Reason is <i>Continue</i> the from date must be prior to the current system date.</p>
To Date	<p>Displays the date when the student's program is to be completed.</p> <p>By default, the system adds the value from the Length of Study field to the from date and displays it here.</p> <p>You can modify this.</p>
Initial Start Date	<p>Set a date that is on or after the From Date, but should not be later than 30 days after the From Date.</p>
English Proficiency required	<p>Select this check box if the school requires English proficiency for this student.</p> <p>If selected, you must indicate whether or not the student is proficient by selecting the appropriate values. Options are <i>Student is proficient</i> or <i>Student is not proficient yet</i>.</p> <p>If this check box is not selected, you must provide an explanation in the text box of why English proficiency is not required at the school.</p>

School estimates student average academic cost for

<i>Field or Control</i>	<i>Description</i>
Months in an academic term	<p>Enter the number of months that the student is to attend courses during an academic term.</p> <p>This value may also appear by default from the I-20 template.</p>
Tuition and fees	<p>Enter the total amount of tuition expenses that the student must pay.</p> <p>This value may also appear by default from the I-20 template.</p>
Other expenses	<p>Enter other expenses that the student must pay.</p> <p>If you enter a value, you must click <i>Description</i> and provide an explanation of the other expense.</p> <p>This value may also appear by default from the I-20 template.</p>
Description	<p>Click to access the page where you must provide an explanation of the other expenses.</p>
Living Expenses	<p>Enter the total amount of living expenses that the student must pay.</p> <p>This value may also appear by default from the I-20 template.</p>
Dependent Expenses	<p>Enter the total amount of dependent expenses that the student must pay.</p> <p>Enter a value here only if the student is accompanied by dependents.</p> <p>This value may also appear by default from the I-20 template.</p>

Student means of support for the above length of time

<i>Field or Control</i>	<i>Description</i>
Student's personal funds	<p>Enter the total amount of personal funds available to the student for use in paying for expenses.</p>

Field or Control	Description
Funds from this school	Enter the total amount of funds being provided by the school. If you enter a value here, you must also click <i>Fund Type</i> and enter an explanation of the funds provided by the school.
Fund Type	Click to access the page where you enter an explanation of the type of funds provided by the school.
Funds from another source	Enter the total amount of funds provided from another source. If you enter a value here, you must also click <i>Description</i> and enter an explanation describing the source of the other funding.
Description	Click to access the page where you enter a description of the source of the other funding.
On-campus employment	Enter the total amount of funds available to the student through on-campus employment.
Funding Verified	Select this check box when the student's funding is verified and the student information is ready to send to SEVIS. You must select this check box for the student information to be processed for sending to SEVIS. Failure to select it results in the student's information not being selected for submission to SEVIS. The check box becomes unavailable and an error message appears, if: <ul style="list-style-type: none"> • The total means of support provided by the student is not equal to or greater than the total expenses. • No visa type is entered for the student. • A dependent is entered, but no dependent expenses are entered. • Dependent expenses are entered, but no dependent is entered.
Funding Remarks	Enter optional, general remarks associated with the funding information.

School Certification

Field or Control	Description
School Official	<p>Enter the designated school official (DSO) responsible for the student's record.</p> <p>This prompt list includes only the DSOs assigned to the school code on the SEVIS School Code table.</p> <p>This value may also appear by default from the I-20 template.</p>
Title	The system displays the title for the DSO from the SEVIS School Code table.
Date Issued	<p>Enter the date when the I-20 form was issued or entered.</p> <p>The default date is the system date. You can modify it.</p> <p>The date is for reference only. It is not sent to SEVIS. The DHS provides the issue date on the I-20 PDF returned from SEVIS.</p>
City and State	Displays the city and state for the DSO from the School Information section of the SEVIS School Code table.

Dependent Information

Enter dependent information.

Warning! Do not delete dependent rows unless you make an error in adding the dependent's ID. If you delete the dependent ID, the dependent events will not be reported to SEVIS. Change the status of the dependent to *Cancelled* or *Terminated* instead of deleting the row. If you try to delete the dependent, you receive a warning regarding the ramifications.

Field or Control	Description
ID	<p>Enter the ID of each person accompanying the student as a dependent. (Dependents and their IDs must appear on the Biographical Details page.)</p> <p>Consult the U.S. Immigrations and Customs Enforcement web site for required data for each dependent.</p>
Email Address	Displays the dependent's preferred email address.

Field or Control	Description
Relationship Status	<p>Enter the status of the dependent: <i>Active</i>, <i>Cancelled</i>, or <i>Terminated</i>.</p> <p>If the status is <i>Active</i>, the dependent is reported with the student during the Create Student event or the Dependent - Add event if a Create Student event was previously sent. The Dependent - Reactivate event also uses this value.</p> <p>If the status is changed to <i>Terminated</i>, and the student has a SEVIS Status of <i>Active</i>, the Dependent - Terminate event is triggered.</p> <p>If the status is changed to <i>Cancelled</i>, and the student has a SEVIS Status of <i>Initial</i>, the Dependent - Cancel event is triggered.</p> <p>This is a required field with a default value of <i>Active</i>.</p>
Relationship	<p>Enter the dependent's relationship to the student. Values include <i>Child</i> and <i>Spouse</i>.</p> <p>Regulations permit only one spouse to accompany the student during study in the U.S. If you enter more than one dependent as a spouse, you receive an error.</p> <p>This is a required field.</p>
Reason	<p>This field appears only when the Relationship Status field is set to <i>Terminated</i> or <i>Cancelled</i>.</p> <p>If Relationship Status is <i>Terminated</i>, you must provide the reason for that action. The termination reasons listed are the values provided by the DHS and sent as part of the Dependent - Terminate event.</p> <p>If the <i>Relationship Status</i> is <i>Cancelled</i>, you must provide the reason for that action. The cancellation reasons listed are the values provided by the DHS and sent as part of the Dependent - Cancel event.</p>
Other Reason	<p>This link appears only when the Relationship Status field is set to <i>Terminated</i> and the Termination Reason is <i>Other</i>.</p> <p>Select the link to enter a further explanation of the termination reason.</p> <p>This field is required if Termination Reason is <i>Other</i>.</p>

Field or Control	Description
Birth Country	Displays the country of birth that is entered on the Biographical Details page.
Citizenship Status	(Required) This field appears only when the birth country is USA or a U.S. territory.
Comments	Enter any additional remarks regarding the dependent. Remarks are optional, but if provided are reported to SEVIS with the following events: Create Student, Dependent - Add, Dependent - Edit, Dependent - Cancel and Dependent - Terminate.
Preferred Name and Passport Name	These fields appear in the Dependent Names tab, which appears only when one or both of the Preferred F/M Dependents and Passport F/M Dependents check boxes are selected on the SEVIS Setup page. These fields are blank if the dependent does not have a name of the defined type.
Create Remarks	Enter any additional remarks regarding the student. Remarks are optional, but if provided are reported to SEVIS with the Create Student event.

Creating and Updating Exchange Visitor Data for DS-2019 Forms for J Visas

The DS-2019 form pages included in the PeopleSoft system display relevant DS-2019 form data in a sequence similar to the actual DS-2019 form document produced by SEVIS. The SEVIS system produces the DS-2019 form in PDF format using data provided by your institution.

PeopleSoft DS-2019 Form pages are keyed by exchange visitor's ID and program number. Access to the form is controlled through SEVIS program sponsor security.

Note: The PeopleSoft system requires that any exchange visitor for whom you enter DS-2019 form data, must have the appropriate J-1 visa type defined on the Visa/Permit Data page.

This section discusses how to create and update DS-2019 form data.

Pages Used to Create and Update Exchange Visitor Data for DS-2019 Forms for J Visas

Page Name	Definition Name	Navigation	Usage
DS-2019 Form	DS2019_FORM	Campus Community > SEVIS > DS-2019 Forms > DS-2019 Form	Create or update DS-2019 information for exchange visitor J visas.
Program Selection	SEV_DS_SEL_SEC	Click the Select Program Data link on the DS-2019 Form page.	Select the program to submit for a student category exchange visitor.
Dependent Details	DS2019_DEP_SEC	Click the Details link in that appears in the Dependent Information section of the DS-2019 Form page when the Relationship Status is either <i>Terminated</i> or <i>Ended Status</i> .	Enter the reason for changing a dependent's Relationship Status to <i>Terminated</i> or <i>Ended Status</i> .

Entering DS-2019 Form Data

Access the DS-2019 Form page (**Campus Community > SEVIS > DS-2019 Forms > DS-2019 Form**).

This example illustrates the fields and controls on the DS-2019 (Certificate of Eligibility for Exchange Visitor (J-1) Status) Form page (1 of 4). You can find definitions for the fields and controls later on this page.

DS-2019 Form

Chris Robinson SEV15205

Program Number: G-2-10128 PeopleSoft Test School SEVIS Status: Initial

SEVIS ID: N0000147890

DS-2019 Form Details

*Effective Date: *Status:

*Visitor's Category:

Academic Institution: PSUNV PeopleSoft University [Select Program Data](#)

Academic Career: UGRD Undergraduate

Academic Program: LAU Liberal Arts Undergraduate

Admit Term: 0504 Test - Current Term Sevis

Exchange Visitor Information

Family Name:	Robinson	Middle Name:	
First Name:	Chris		
Preferred Name:	Chris Brian Robinson		
Passport Name:	ROBINSON CHRISTOPHER JAMES		
Email Address:	chrissier93@gmail.com		
Phone:	907/786-5432		
Gender:	M		
Date of Birth:	05/05/1993	City of Birth:	Sydney
Birth Country:	AUS Australia		
*Citizenship Country:	<input type="text" value="AUS"/> <input type="button" value="Q"/> Australia		
*Permanent Country:	<input type="text" value="AUS"/> <input type="button" value="Q"/> Australia		
*Position Code:	<input type="text" value="215"/> <input type="button" value="Q"/> University Undergraduate Students		

This example illustrates the fields and controls on the DS-2019 (Certificate of Eligibility for Exchange Visitor (J-1) Status) Form page (2 of 4). You can find definitions for the fields and controls later on this page.

US Address	
Address 1:	Slater Dorm
Address 2:	Room 601
City:	Santa Rosa
State:	CA California
Postal:	95405
Explanation Code:	Other override
Explanation Text:	Dorm address

Mailing Address	
Address 1:	Administration Office
Address 2:	
City:	Santa Rosa
State:	CA
Postal:	95405
Explanation Code:	Campus mailing address
Explanation Text:	

Creation Reason: New Continuing

*Start Date: 06/01/2015

*End Date: 06/01/2016

*Subj/Field Code: 26.0101 Biology/Biological Sciences, G

Subj/Field Remarks: Biology major

This example illustrates the fields and controls on the DS-2019 (Certificate of Eligibility for Exchange Visitor (J-1) Status) Form page (3 of 4). You can find definitions for the fields and controls later on this page.

Total Estimated Financial Support	
Current Program Sponsor Funds:	<input type="text"/>
<input type="checkbox"/> Received US Government Funds	
US Government Agency Code:	<input type="text"/>
Amount:	<input type="text"/>
US Government Agency Code 2:	<input type="text"/>
Amount:	<input type="text"/>
Intl Organization Code:	<input type="text"/>
Amount:	<input type="text"/>
Intl Organization Code 2:	<input type="text"/>
Amount:	<input type="text"/>
Other Organizations Support:	<input type="text"/>
Exchange Visitor's Government:	<input type="text" value="40000"/>
Binational Commission:	<input type="text"/>
Personal Funds:	<input type="text"/>
Total Financial Support:	\$40000
Name:	<input type="text"/>
<input checked="" type="checkbox"/> Funding Verified	
Remarks:	<div style="border: 1px solid black; height: 30px;"></div>

*Responsible Officer: Joan Avery

Address Line 1: 15821 VENTURA BLVD

Address Line 2: SUITE 220

City: ENCINO

State: CA California

Postal: 91436

Date Prepared:

Date Signed:

This example illustrates the fields and controls on the DS-2019 (Certificate of Eligibility for Exchange Visitor (J-1) Status) Form page (4 of 4). You can find definitions for the fields and controls later on this page.

The screenshot displays the 'Dependent Information' and 'Site of Activity' sections of the DS-2019 form. The 'Dependent Information' section includes a table with columns for *ID, Name, Email Address, Relationship Status, and *Relationship. The 'Site of Activity' section contains fields for Site of Activity (ENC, PeopleSoft University), *Status (Active), Address 1 (15821 N VENTURA BLVD), Address 2 (SUITE 200), City (ENCINO), State (CA, California), Postal (91436-4444), Explanation Code, Explanation Text, and Remarks.

DS-2019 Form Details

Field or Control	Description
SEVIS Status	Displays the status of the exchange visitor as reflected in the SEVIS Master.
Status	Enter the status as of the effective date. The default value is <i>Active</i> . Only active DS-2019 form rows are included in the SEVIS Alerts - J process.

Field or Control	Description
Visitor's Category	<p>Select the appropriate category for the exchange visitor.</p> <p>Values are:</p> <p><i>Alien Physician</i></p> <p><i>Aupair</i></p> <p><i>Camp Counselor</i></p> <p><i>Government Visitor</i></p> <p><i>Intern</i></p> <p><i>International Visitor</i></p> <p><i>Professor</i></p> <p><i>Research Scholar</i></p> <p><i>Short-term Scholar</i></p> <p><i>Specialist</i></p> <p><i>Student Associate</i></p> <p><i>Student Bachelors</i></p> <p><i>Student Doctorate</i></p> <p><i>Student Intern</i></p> <p><i>Student Masters</i></p> <p><i>Student Non-Degree</i></p> <p><i>Student Secondary</i></p> <p><i>Summer Work/Travel</i></p> <p><i>Teacher</i></p> <p><i>Trainee</i></p> <p><i>Trainee (Non-speciality)</i></p> <p><i>Trainee (Specialty)</i></p> <p>This field is required. The system uses this value to enforce minimum and maximum duration of stay rules when you save the page.</p>

Field or Control	Description
Academic Institution, Academic Career, Academic Program, and Admit Term	<p>If you select any of the student categories other than <i>Student Intern</i> in the Visitors Category field, the system displays the following:</p> <ul style="list-style-type: none"> • The institution entered for the student, • The career entered for the institution, • The academic program entered for the career, and • The admit term entered for the student exchange visitor in the specified program.
Select Program Data	<p>Click to access the Program Selection page, where you can determine if more than one combination of institution, career, academic program, and admit term exists for the student exchange visitor.</p> <p>If more than one exists, select the check box on the Program Selection page for the line that contains the appropriate information to print on the DS-2019 form.</p> <p>The valid institutions for the program number and the valid careers for the institution are based on the setup of the SEVIS Program Sponsor table.</p>

Exchange Visitor Information

Field or Control	Description
Family Name, First Name, and Middle Name	<p>Displays the exchange visitor's last, first, and middle names according to the name type entered on the SEVIS Setup page.</p> <hr/> <p>Note: You must make any name changes on the Biographical Details page</p> <hr/>
Preferred Name	<p>Displays the first, middle, last names, and suffix according to the most recent name record for the name type defined for the Preferred Name field on the SEVIS Setup page. This field is blank if the exchange visitor does not have a name of the defined type.</p> <p>This field appears only when a name type is defined in the Preferred Name field in the SEVIS Setup page.</p>

Field or Control	Description
Passport Name	<p>Displays the last, first, and middle names, according to the most recent name record for the name type defined for the Passport Name field on the SEVIS Setup page. This field is blank if the exchange visitor does not have a name of the defined type.</p> <p>This field appears only when a name type is defined in the Passport Name field in the SEVIS Setup page.</p>
Email Address	Displays the preferred email address of the exchange visitor.
Phone	Displays the preferred phone number of the exchange visitor.
Gender, Date of Birth, City of Birth, and Birth Country	Displays data entered on the Biographical Details page.
Birth Country Reason	<p>This field appears only if the birth country is USA or a U.S. territory.</p> <p>SEVIS requires that you enter the applicable reason, either <i>Born to Foreign Diplomat</i> or <i>Expatriated</i>.</p>
Country	<p>Select the citizenship country to report to SEVIS.</p> <p>If the exchange visitor has only one non-U.S. citizenship country, the system displays it by default.</p> <p>This field is required.</p>
Permanent Country	<p>Select the country of permanent residence to report to SEVIS.</p> <p>This field is required.</p>
Position Code	<p>Select the position to report to SEVIS that describes the exchange visitor in his or her home country.</p> <p>This field is required.</p>

US Address

Field or Control	Description
Address 1, Address 2, City, and State	Displays the exchange visitor's address based on the address type entered on the SEVIS Setup page for the U.S. address.

Field or Control	Description
Explanation Code	Select the override reason for an address that does not pass SEVIS validation. This reason is included in the alert.
Explanation Text	<p>This field is enabled only when you select <i>Other override</i> in the Explanation Code field.</p> <p>Enter the reason for the override.</p>
Creation Reason	<p>You can select only one reason, either <i>New</i> or <i>Continuing</i>.</p> <p>If you select <i>New</i>, the Start Date and End Date fields appear. You must enter the exchange program start and end dates.</p> <p>If you select <i>Continuing</i>, the Initial Start Date, Form Number, Start Date, and End Date fields appear. You must enter the exchange program's original start date and the number of the assigned IAP-66 or DS-2019 form in addition to the exchange program start and end dates.</p> <hr/> <p>Note: The creation reason is no longer reported to SEVIS in batch, therefore it is assumed that all exchange visitors have a creation reason of <i>New</i>. Use <i>Continuing</i> only for recording historical data. A warning appears when you save the DS-2019 Form with a creation reason of <i>Continuing</i>.</p> <hr/>
Start Date and End Date	<p>Enter the date that the exchange visitor's program begins and the date that the program is to be completed.</p> <p>A visitor cannot enter the U.S. more than 30 days prior to program start date. Exchange Program start date must be equal to or later than the current date. The system delivers an error if the start date is not equal to or later than the current system date.</p> <p>Also, the program duration cannot exceed the maximum duration of stay and cannot be less than the minimum duration of stay.</p> <p>These are required fields.</p>

Field or Control	Description
Initial Start Date and Form Number	<p>For a creation reason of <i>Continuing</i>, you must enter the original date when the exchange visitor's program began and the number of the IAP-66 or DS-2019 form assigned to the exchange visitor.</p> <p>The initial start date must predate the current date. The system delivers an error if the start date is not prior to the current date.</p> <p>The format for the form number is X-1-12345-1234567. The system delivers an error if the format is not correct.</p> <p>Both the Initial Start Date and Form Number fields are required for a creation reason of <i>Continuing</i>.</p>
Subj/Field Code (subject/field code)	<p>Enter the CIP code that represents the exchange visitor's subject or field of study.</p> <p>The field is available or unavailable based the Visitor's Category selected. For student categories (<i>Student Associate, Student Doctorate, Student Intern</i>, and so on), the subject and field of study information comes from the student program/plan academic plan with the minimum sequence number where the plan type is equal to the plan types defined for primary major on the SEVIS Setup page. If no data exists on the student program/plan academic plan, the information comes from the academic plan in the Maintain Applications component.</p> <p>For nonstudent categories (Alien Physician, Aupair, Camp Counselor, Intern, and so on), you must enter the subject or field of study.</p> <p>The CIP code is the code related to the academic plan as assigned on the Taxonomy page in the Academic Plan Table component (Set Up SACR > Foundation Tables > Academic Structure).</p> <p>This field is required. The CIP code is reported to SEVIS.</p> <p>See "Understanding Academic Structure" (Campus Solutions Application Fundamentals).</p> <p>If the exchange visitor code is a program category other than <i>Student</i>, the field is available and you must select the appropriate subject/field code.</p>
Subj/Field Remarks	<p>Enter remarks to further describe the subject and field of study.</p> <p>Remarks are required.</p>

Field or Control	Description
Degree Level and Field of Study	These fields appear only when Visitor's Category is set to <i>Student Intern</i> .

Mailing Address

Field or Control	Description
Address 1, Address 2, City, and State	Displays the student's address based on the address type that is defined on the SEVIS Setup page for the mailing address.
Explanation Code	Select the override reason for an address that does not pass SEVIS validation. This reason is included in the alert.
Explanation Text	This field is enabled only when you select <i>Other override</i> in the Explanation Code field. Enter the reason for the override.

Total Estimated Financial Support

You must enter at least one amount of monetary support in this section

Field or Control	Description
Current Program Sponsor Funds	Enter the U.S. dollar amount of financial support provided by the program sponsor.
Received US Government Funds	Select to report to SEVIS that the exchange visitor has received funding from the U.S. Government.
US Government Agency Code and Amount; US Government Agency Code 2 and Amount	Enter the U.S. Government organization that is providing funds to the exchange visitor, and the U.S. dollar amount of the funding they provide. For each agency that you enter, you must also enter the amount of funding. If you enter a value of <i>OTHER</i> in either the US Government Agency Code or US Government Agency Code 2 field, you must enter the name of the agency in the Name field. SEVIS requires that you enter the name of the US government agency providing funds.

Field or Control	Description
Intl Organization Code (international organization code) and Amount; Intl Organization Code 2 (international organization code 2) and Amount	<p>Enter the international organization that is providing funds to the exchange visitor, and the U.S. dollar amount of the funding they provide.</p> <p>For each organization that you enter, you must also enter the amount of funding.</p> <p>If you enter a value of <i>OTHER</i> in either the Intl Organization Code or Intl Organization Code 2 field, you must enter the name of the organization in the Name field. SEVIS requires that you enter the name of the international organization providing funds.</p>
Other Organizations Support and Name	Enter the total U.S. dollar amount of funding provided by any other organization, and enter the name of the organization.
Exchange Visitor's Government	Enter the U.S. dollar amount of funding provided by the government of the exchange visitor's country.
Binational Commission	Enter the U.S. dollar amount of funding provided by the binational commission of the exchange visitor's country.
Personal Funds	Enter the total amount of personal funds available to the exchange visitor for expenses.
Total Financial Support	The system calculates the total of funds entered on this page and displays the total here.

Field or Control	Description
Funding Verified and Remarks	<p>Select this when the exchange visitor's funding is verified and the exchange visitor information is ready to send to SEVIS.</p> <p>Enter optional, general remarks associated with the funding information.</p> <p>You must select the Funding Verified check box for the exchange visitor information to be processed for sending to SEVIS. Failure to select it results in the exchange visitor's information not being selected for submission to SEVIS.</p> <p>The check box becomes unavailable and an error message appears if:</p> <ul style="list-style-type: none"> • No visa type is entered for the exchange visitor. • The visa type is not mapped to 03 on the Visa Mapping page. • No amount of financial support is entered.
Responsible Officer	<p>Enter the RO/ARO responsible for the exchange visitor's record. This prompt displays only the RO/AROs assigned to the Program Sponsor on the SEVIS Program Sponsor table.</p> <p>This field is required.</p>
Address Line 1, Address Line 2, City, State, and Postal	<p>Displays the address data entered in the Program Sponsor Information section of the SEVIS Program Sponsor table for the selected responsible officer.</p>
Date Prepared	<p>Enter the date when the DS-2019 form was issued or entered.</p> <p>The default date is the current system date. You can modify it.</p> <p>This date is informational only and is not sent to SEVIS. The DHS provides the date prepared on the DS-2019 PDF returned from SEVIS.</p>
Date Signed	<p>Enter the date that the DS-2019 form was signed.</p> <p>This date is informational only. It is not sent to SEVIS.</p>

Dependent Information

Enter dependent information.

Warning! Do not delete dependent rows unless you make an error in adding the dependent's ID. If you delete the dependent ID, the dependent events are not reported to SEVIS. Change the status of the dependent to *Deleted*, *Ended Status*, or *Terminated* instead of deleting the row. If you try to delete the dependent row, you receive a warning regarding the ramifications.

Field or Control	Description
ID	<p>Enter the ID of each person accompanying the exchange visitor as a dependent. (Dependents and their IDs must appear on the Biographical Details page in the Add/Update a Person component.)</p> <p>See Reference Manual for the Student and Exchange Visitor Information System Batch Interface, Application Program Interface (API).</p>
Email Address	Displays the dependent's preferred email address.
Relationship Status	<p>Enter the status of the dependent: <i>Active</i>, <i>Deleted</i>, <i>Ended Status</i>, or <i>Terminated</i>.</p> <p>If the status is <i>Active</i>, the dependent is reported along with the exchange visitor on the Create EV event or the Dependent - Add event if a Create EV event was previously sent.</p> <p>If the status is changed to <i>Terminated</i>, the Dependent - Terminate event is triggered.</p> <p>If the status is changed to <i>Ended Status</i>, the Dependent - End Status event is triggered.</p> <p>If the status is changed to <i>Deleted</i>, the Dependent - Delete event is triggered.</p> <p>The Dependent - End Status and Dependent - Terminate events trigger only if the exchange visitor's SEVIS status is <i>Active</i>.</p> <p>The Dependent - Delete event triggers only if the exchange visitor's SEVIS status is <i>Initial</i>.</p> <p>This is a required field with a default value of <i>Active</i>.</p>

Field or Control	Description
Relationship	<p>Enter the dependent's relationship to the exchange visitor. Values are <i>Child</i> or <i>Spouse</i>.</p> <p>Regulations permit only one spouse to accompany the exchange visitor during study in the U.S. If you enter more than one dependent as a spouse, you receive an error.</p> <p>This is a required field.</p>
Permanent Country	<p>Select the country to report to SEVIS as dependent's country of permanent residence.</p> <p>This is a required field.</p>
Details	<p>Appears only if the Relationship Status field is set to <i>Ended Status</i> or <i>Terminated</i>.</p> <p>Click to access the Dependent Details page where you must enter the reason for the status – either an end of status reason or termination reason respectively.</p>
Remarks	<p>Enter any additional remarks regarding the dependent.</p> <p>Remarks are optional, but if provided are reported to SEVIS with the Create EV, Dependent - Add, Dependent - Edit, Dependent - Cancel, and Dependent - Terminate events.</p>
Birth Country Reason	<p>This field appears only if the birth country is USA or a US Territory. You must enter the applicable reason, either <i>Born to Foreign Diplomat</i> or <i>Expatriated</i>.</p>
Preferred Name and Passport Name	<p>These fields appear in the Dependent Names tab, which appears only when one or both of the Preferred J Dependents and Passport J Dependents check boxes are selected on the SEVIS Setup page.</p> <p>These fields are blank if the dependent does not have a name of the defined type.</p>

Site of Activity

Enter information about the site of the exchange visitor activity.

Warning! Do *not* delete site of activity rows unless you make an error in adding the site of activity. If you delete the site of activity, the site of activity events are not reported to SEVIS. Change the status of the site of activity to *Inactive* instead of deleting the row. If you try to delete the site of activity, the system displays a warning regarding the ramifications.

Field or Control	Description
Site of Activity	<p>Enter the site of activity to report to SEVIS.</p> <p>The default value is the site that is set up on the SEVIS Program Sponsor table. You can add multiple sites of activity when creating an exchange visitor.</p>
Primary	Select to indicate the site is the primary site to print on the DS-2019 Form.
Status	<p>Enter the status of the site of activity. The default value is <i>Active</i>.</p> <p>If you change the status to <i>Active</i>, the system reports a Site of Activity - Add event to SEVIS if a Create EV has already been sent.</p> <p>If you change the status to <i>Inactive</i>, the system reports a Site of Activity - Delete event to SEVIS.</p>
Address 1, Address 2, City, State, and Postal	<p>Enter address data for the site from the Site of Activity table.</p> <p>The system displays this information from the Site of Activity Table, but is editable. Changing this data after it is sent to SEVIS triggers a Site of Activity – Edit event.</p>
Explanation Code	<p>Displays the override reason for an address that does not pass SEVIS validation. This reason is included in the alert.</p> <p>The value in this field defaults from the Site Activity Table when a Site Activity code is added or updated.</p>
Explanation Text	<p>Displays the reason for the override.</p> <p>The value in this field defaults from the Site Activity Table when a Site Activity code is added or updated.</p>
Remarks	<p>Enter remarks to further describe the site of activity.</p> <p>The system sends these remarks to SEVIS with the Site of Activity - Add, Site of Activity - Edit, and Site of Activity - Delete events.</p>

Dependent Details page

Access the Dependent Details page (click the **Details** link in that appears in the Dependent Information section of the DS-2019 Form page when the **Relationship Status** is either *Terminated* or *Ended Status*).

Fields appear on this page based on the dependent's **Relationship Status**, either *Terminated* or *Ended Status*.

Field or Control	Description
Termination Reason or End Status Reason	<p>If you change a dependent's Relationship Status to <i>Terminated</i>, the Termination Reason field appears where you must enter a reason for terminating the dependent. Valid values are: <i>Conviction of a Crime</i>, <i>Unauthorized Employment</i>, and <i>Other</i>. The available reasons listed are the values provided by the DHS and sent as part of the Dependent - Terminate event.</p> <p>If you change a dependent's Relationship Status to <i>Ended Status</i> the <i>End Status Reason</i> field appears where you must enter a reason for ending the dependent's status. Valid values are: <i>Death</i>, <i>Divorce</i>, <i>Other</i>; or <i>Over 21</i>.</p> <p>For either <i>Terminated</i> or <i>Ended Status</i>, if you select a reason of <i>Other</i> you must also complete the Other Reason field.</p> <p>You can submit only one reason to SEVIS. The system displays an error if you attempt to enter both an termination and an end status reason.</p>
Effective Date	<p>Appears only if you enter a termination reason. Enter the termination date for the dependent.</p> <p>The field is required for a termination reason.</p>
Other Reason	<p>Appears if you enter an end status reason or termination reason of <i>Other</i>. Provide an explanation for the reason entered.</p> <p>This field is required for an end status reason or termination reason of <i>Other</i>.</p>
Remarks	<p>Enter any additional remarks about the end of status or termination.</p> <p>Remarks are optional, but if provided are reported to SEVIS with the Dependent - Terminate or Dependent - End Status events.</p>

Using Dependent Search

Using Dependent Search, you can search on a dependent's name to determine who the individual's primary document holder is and how the dependent and primary document holder are related. The system looks at I-20 and DS-2019 forms data to return the results of the search.

Page Used for Dependent Search

<i>Page Name</i>	<i>Definition Name</i>	<i>Navigation</i>	<i>Usage</i>
Dependent Search	SEV_DEP_SRCH	Campus Community > SEVIS > Search Tools > Dependent Search	Find the primary document holder for a dependent.

Using Dependent Search

Access the Dependent Search page (**Campus Community** > **SEVIS** > **Search Tools** > **Dependent Search**).

<i>Field or Control</i>	<i>Description</i>
Spouse of or Child of	<p>Displays the ID of the dependent's primary document holder, either Spouse of or Child.</p> <p>The field label change to reflect the dependent's relationship to the primary document holder. For example, suppose that Gabriel Fisher, the dependent on whom you search, is the son of the primary document holder. The field label would be <i>Child of</i>.</p>
School Code or Program Number	<p>Displays the SEVIS school code or program number from the primary document holder's I-20 or DS-2019 form if the form data contains the dependent's ID.</p> <p>The School Code field appears only if the system finds I-20 form data that contains the dependent's ID.</p> <p>The Program Number field appears only if the system finds DS-2019 form data that contains the dependent's ID.</p>
View Form	<p>This link appears only if you have security access to the school code or program number listed.</p> <p>Click to access the form, either the I-20 or DS-2019 form, on which the system found the dependent's ID. The form appears in a new browser window in update/display mode.</p> <p>If you do not have the security access to the school code or program number, this link does not appear and you are not able to view the forms.</p>

Running the SEVIS Alerts Process

The SEVIS Alerts process identifies data changes that are reportable to SEVIS, logs those changes, and copies all relevant data into the Select Alerts to Report component for review before you submit the data to SEVIS. You can set the process to run at scheduled intervals. Each time the SEVIS Alerts process (for F/M visas or for J visas) runs, the SEVIS alerts data is moved to SEVIS events history and the SEVIS Alerts process records are refreshed with data from the new run of the process.

Before running the process again, allow for the processing time required for SEVIS to return batch results and to run the SEVIS Import Results process. Refer to the process flow to better understand and determine when to run the SEVIS Alerts process.

This section discusses how to:

- Run the SEVIS Alerts process for F and M visas.
- Run the SEVIS Alerts process for J visas.

Understanding Name Population

This section describes the processing for events that include name fields for a student, exchange visitor, or dependent.

Note: Separate First and Middle Name fields are populated in the alerts records and in SEVIS Master. The concatenation of First and Middle Name values into a single Given Name element in the XML file is handled as part of the Export to SEVIS process.

Dummy First Name

If the First Name value in the name record that is reported matches the Dummy First Name defined in SEVIS Setup, then both the First and Middle Name values are set to blank in the alerts record for the main name record, and for any values that are reported for Preferred Name and Passport Name. This is done before the name values are converted or validated.

Character Conversion

During the population of names in the alerts record, where possible, non-standard Latin characters are converted to standard A-Z or a-z characters. Character conversion is applied to First Name, Middle Name, Last Name, Passport Name and Preferred Name. Because some non-standard Latin characters are allowed for Preferred Name, the list of converted characters is a subset of the characters converted for the other name fields. For information about character conversion, see [Understanding Name Character Conversion](#).

In some cases, a single non-standard character must be replaced with two characters and, in certain circumstances, this may cause the overall length of the name field to exceed the maximum 30 characters allowed in the alerts record. For each of the converted names fields, if the value exceeds the maximum characters allowed, then the value is truncated to 30 characters before being stored. An error for the alert is also logged.

Validation

Validation is applied for First Name, Middle Name, Last Name, Preferred Name, and Passport Name. Where only alphabet characters or spaces are allowed, in most cases invalid characters are converted to valid A-Z or a-z during character conversion. The validation gives errors when other non-standard characters exist. If the name value has been truncated to 30 characters as part of the name conversion, then an error is also logged for the alert.

Field	Error Conditions
Last Name	<ul style="list-style-type: none"> • If the field: <ul style="list-style-type: none"> • is blank • contains characters other than A-Z or a-z • contains multiple spaces in sequence • has any of the values (regardless of case): fnu, lnu, unknown, not application, none • If the value is truncated to 30 characters during conversion of non-standard characters
First Name	<ul style="list-style-type: none"> • If the field: <ul style="list-style-type: none"> • contains characters other than A-Z or a-z • contains multiple spaces in sequence • has any of the values (regardless of case): fnu, lnu, unknown, not application, none • If the value is truncated to 30 characters during conversion of non-standard characters
Middle Name	<ul style="list-style-type: none"> • If the field contains: <ul style="list-style-type: none"> • characters other than A-Z or a-z • multiple spaces in sequence • contains the following values (regardless of case): fnu, lnu, unknown, not application, none • If the value is truncated to 30 characters during conversion of non-standard characters

Field	Error Conditions
Preferred Name	<p>If the field contains:</p> <ul style="list-style-type: none"> • multiple spaces in sequence • other characters aside from the following allowed characters: <ul style="list-style-type: none"> • A-z • a-z • apostrophe • comma • hyphen • full stop or period • upper or lower case characters with grave, acute, circumflex, diaeresis, ring above
Passport Name	<p>If the field:</p> <ul style="list-style-type: none"> • exceeds the maximum 39 characters • contains characters other than A-z or a-z • contains multiple spaces in sequence

Understanding Name Comparison

The alerts process compares the Last Name, Middle Name, First Name, Preferred Name, and Passport Name values from SEVIS Master with the relevant name record to determine whether to generate update events Personal Info and Dependent – Edit for F/M visas, and Biographical and Dependent – Edit for J visas. The comparison for Preferred Name and Passport Name is done only if a name type is defined in SEVIS Setup.

If the First Name value in the name record matches the Dummy First Name value defined in setup, then the First Name and Middle Name are both considered blank when they are compared with the values in SEVIS Master.

Character conversion is applied to the name record fields and SEVIS Master name values prior to the comparison.

Understanding Name Character Conversion

The following sections describe the conversion of name characters for Full Name, Passport Name, and Preferred Name.

Full Name/Passport

For First Name, Middle Name, Last Name, and Passport Name, the conversions in the following table are performed to replace non-standard Latin characters prior the values being validated.

Note: The characters marked with an asterisk (*) denote characters that are allowed in the Preferred Name field.

This table illustrates the Character Conversion for Punctuation Marks; Capital and Small A.

Non-Standard Latin Character			Replace With		Notes
Unicode	Char	Description	Unicode	Char	
U+0027	'	Apostrophe*			Removed completely, e.g. O'Connor becomes <u>OConnor</u>
U+002C	,	Comma*	U+0020	(space)	
U+002D	-	Hyphen*	U+0020	(space)	Replaced with space, e.g. Smith-Jones becomes Smith Jones
U+00C0	À	Capital A – grave*	U+0041	A	
U+00C1	Á	Capital A – acute*			
U+00C2	Â	Capital A – circumflex*			
U+00C3	Ã	Capital A – tilde			
U+0100	Ā	Capital A – macron			
U+0102	Ă	Capital A – breve			
U+0104	Ą	Capital A – ogonek			
U+00E0	à	Small a – grave*	U+0061	a	
U+00E1	á	Small a – acute*			
U+00E2	â	Small a – circumflex*			
U+00E3	ã	Small a – tilde			
U+00E4	ä	Small a – diaeresis*			
U+00E5	å	Small a – ring above*			
U+0101	ā	Small a – macron			
U+0103	ă	Small a – breve			
U+0105	ą	Small a – ogonek			

This illustrates the Character Conversion for C and D.

Non-Standard Latin Character			Replace With		Notes
Unicode	Char	Description	Unicode	Char	
U+00C7	Ç	Capital C – cedilla	U+0043	C	
U+0106	Ĉ	Capital C – acute*			
U+0108	Ĉ	Capital C – circumflex*			
U+010A	Ĉ	Capital C – dot above			
U+010C	Č	Capital C – caron			
U+00E7	ç	Small c – cedilla	U+0063	c	
U+0107	ć	Small c – acute*			
U+0109	ĉ	Small c – circumflex*			
U+010B	ċ	Small c – dot above			
U+010D	č	Small c – caron			
U+00D0	Ð	Capital Eth	U+0044	D	
U+010E	Ď	Capital D – caron			
U+0110	Đ	Capital D – stroke			
U+00F0	ð	Small Eth	U+0064	d	
U+010F	ď	Small d – caron			
U+0111	đ	Small d – stroke			

This illustrates the Character Conversion for Capital and Small E.

Non-Standard Latin Character			Replace With		Notes
Unicode	Char	Description	Unicode	Char	
U+00C8	È	Capital E – grave*	U+0045	E	
U+00C9	É	Capital E – acute*			
U+00CA	Ê	Capital E – circumflex*			
U+00CB	Ë	Capital E – diaeresis*			
U+0112	Ē	Capital E – macron			
U+0114	Ĕ	Capital E – breve			
U+0116	Ė	Capital E – dot above			
U+0118	Ę	Capital E – ogonek			
U+011A	Ě	Capital E – caron			
U+00E8	è	Small e – grave*	U+0065	e	
U+00E9	é	Small e – acute*			
U+00EA	ê	Small e – circumflex*			
U+00EB	ë	Small e – diaeresis*			
U+0113	ē	Small e – macron			
U+0115	ĕ	Small e – breve			
U+0117	ė	Small e – dot above			
U+0119	ę	Small e – ogonek			
U+011B	ě	Small e – caron			

This illustrates the Character Conversion for Capital and Small G; Capital and Small H.

Non-Standard Latin Character			Replace With		Notes
Unicode	Char	Description	Unicode	Char	
U+011C	Ĝ	Capital G – circumflex*	U+0047	G	
U+011E	Ğ	Capital G – breve			
U+0120	Ġ	Capital G – dot above			
U+0122	Ģ	Capital G – cedilla			
U+011D	ĝ	Small g – circumflex*	U+0067	g	
U+011F	ğ	Small g – breve			
U+0121	ġ	Small g – dot above			
U+0123	ģ	Small g – cedilla			
U+0124	Ĥ	Capital H – circumflex*	U+0048	H	
U+0126	Ħ	Capital H - stroke			
U+0125	ĥ	Small h – circumflex	U+0068	h	
U+0127	ħ	Small h – stroke			

This illustrates the Character Conversion for Capital and Small I; Capital and Small J.

Non-Standard Latin Character			Replace With		Notes
Unicode	Char	Description	Unicode	Char	
U+00CC	Ì	Capital I – grave*	U+0049	I	
U+00CD	Í	Capital I – acute*			
U+00CE	Î	Capital I – circumflex*			
U+00CF	Ï	Capital I – diaeresis*			
U+0128	Ĩ	Capital I - tilde			
U+012A	Ī	Capital I – macron			
U+012C	İ	Capital I – breve			
U+012E	Į	Capital I – ogonek			
U+0130	Ĭ	Capital I – dot above			
U+00EC	i	Small i – grave*	U+0069	i	
U+00ED	í	Small i – acute*			
U+00EE	î	Small i – circumflex*			
U+00EF	ï	Small i – diaeresis*			
U+0129	ĩ	Small i – tilde			
U+012B	ī	Small i – macron			
U+012D	ï	Small i – breve			
U+012F	į	Small i – ogonek			
U+0131	ı	Small i – dotless			
U+0134	Ĵ	Capital J – circumflex*	U+004A	J	
U+0135	ĵ	Small j – circumflex*	U+006A	j	

This illustrates the Character Conversion for Capital and Small K; Capital and Small L.

Non-Standard Latin Character			Replace With		Notes
Unicode	Char	Description	Unicode	Char	
U+0136	Ƙ	Capital K – cedilla	U+004B	K	
U+0137	ƙ	Small k – cedilla	U+006B	k	
U+0139	Ĺ	Capital L – acute*	U+004C	L	
U+013B	Ľ	Capital L – cedilla			
U+013D	Ł	Capital L – caron			
U+013F	Ł	Capital L – middle dot			
U+0141	Ł	Capital L - stroke			
U+013A	ĺ	Small l – acute*			
U+013C	ļ	Small l – cedilla			
U+013E	ł	Small l – caron			
U+0140	ł	Small l – middle dot			
U+0142	ł	Small l – stroke			

This illustrates the Character Conversion for Capital and Small N; Capital O.

Non-Standard Latin Character			Replace With		Notes
Unicode	Char	Description	Unicode	Char	
U+00D1	Ñ	Capital N – tilde	U+004E	N	
U+0143	Ń	Capital N – acute*			
U+0145	Ṅ	Capital N – cedilla			
U+0147	Ñ̄	Capital N – caron			
U+014A	D	Capital Eng			
U+00F1	ñ	Small n – tilde	U+006E	n	
U+0144	ń	Small n – acute*			
U+0146	ṅ	Small n – cedilla			
U+0148	ñ̄	Small n – caron			
U+0149	ñ̇	Small n – apostrophe			
U+014B	ŋ	Small eng			
U+00D2	Ò	Capital O – grave*	U+004F	O	
U+00D3	Ó	Capital O – acute*			
U+00D4	Ô	Capital O – circumflex*			
U+00D5	Õ	Capital O - tilde			
U+00D8	Ø	Capital O – stroke			
U+014C	Ō	Capital O – macron			
U+014E	Ȫ	Capital O – breve			
U+0150	Ȭ	Capital O – double acute			

This illustrates the Character Conversion for Small O; Small Q; Capital and Small R.

Non-Standard Latin Character			Replace With		Notes
Unicode	Char	Description	Unicode	Char	
U+00F2	ò	Small o – grave*	U+006F	o	
U+00F3	ó	Small o – acute*			
U+00F4	ô	Small o – circumflex*			
U+00F5	õ	Small o – tilde			
U+00F6	ö	Small o – diaeresis*			
U+00F8	ø	Small o – stroke			
U+014D	ō	Small o – macron			
U+014F	ö	Small o – breve			
U+0151	õ	Small o – double acute			
U+0138	κ	Small Kra			
U+0154	Ŕ	Capital R – acute*	U+0052	R	
U+0156	Ŗ	Capital R – cedilla			
U+0158	Ř	Capital R – caron			
U+0155	ŕ	Small r – acute*	U+0072	r	
U+0157	ŗ	Small r – cedilla			
U+0159	ř	Small r – caron			

This illustrates the Character Conversion for Capital and Small S; Capital and Small T; Capital U.

Non-Standard Latin Character			Replace With		Notes
Unicode	Char	Description	Unicode	Char	
U+015A	Š	Capital S – acute*	U+0053	S	
U+015C	Ŝ	Capital S – circumflex*			
U+015E	Ș	Capital S – cedilla			
U+0160	Š	Capital S – caron			
U+015B	ś	Small s – acute*	U+0073	s	
U+015D	ŝ	Small s – circumflex*			
U+015F	ș	Small s – cedilla			
U+0161	š	Small s – caron			
U+0162	Ț	Capital T – cedilla	U+0054	T	
U+0164	Ț	Capital T – caron			
U+0166	Ƨ	Capital T - stroke			
U+0163	ț	Small t – cedilla	U+0074	t	
U+0165	ț	Small t – caron			
U+0167	Ƨ	Small t – stroke			
U+00D9	Ù	Capital U – grave*	U+0055	U	
U+00DA	Ú	Capital U – acute*			
U+00DB	Û	Capital U – circumflex*			
U+0168	Û	Capital U - tilde			
U+016A	Ū	Capital U – macron			
U+016C	Ů	Capital U – breve			
U+016E	Û	Capital U – ring above*			
U+0170	Ů	Capital U – double acute			
U+0172	Ų	Capital U – ogonek			

This illustrates the Character Conversion for Small U; Capital and Small W; Capital and Small Y; Capital and Small Z.

Non-Standard Latin Character			Replace With		Notes
Unicode	Char	Description	Unicode	Char	
U+00F9	ù	Small u – grave*	U+0075	u	
U+00FA	ú	Small u – acute*			
U+00FB	û	Small u – circumflex*			
U+0169	ü	Small u – tilde			
U+016B	ū	Small u – macron			
U+016D	Û	Small u – breve			
U+016F	ů	Small u – ring above*			
U+0171	ű	Small u – double acute			
U+0173	ų	Small u – ogonek			
U+0174	Ŵ	Capital W – circumflex*	U+0057	W	
U+0175	ŵ	Small w – circumflex*	U+0077	w	
U+00DD	Ÿ	Capital Y – acute*	U+0059	Y	
U+0176	ÿ	Capital Y – circumflex*			
U+0178	ÿ	Capital Y – diaeresis*			
U+00FD	ý	Small y – acute*	U+0079	y	
U+00FF	ÿ	Small y – diaeresis*			
U+0177	ÿ	Small y – circumflex*			
U+0179	Ż	Capital Z – acute*	U+005A	Z	
U+017B	Ź	Capital Z – dot above			
U+017D	Ž	Capital Z – caron			
U+017A	ż	Small z – acute*	U+007A	z	
U+017C	ź	Small z – dot above			
U+017E	ż	Small z – caron			

This illustrates the Character Conversion for Other Special Characters.

Non-Standard Latin Character			Replace With		Notes
Unicode	Char	Description	Unicode	Char	
U+00C4	Ä	Capital A – diaeresis*	U+0041	A	Single character replaced with 2 characters, AE
			U+0045	E	
U+00C5	Å	Capital A – ring above*	U+0041	A	Single character replaced with 2 characters, AA
			U+0041	A	
U+00C6	Æ	Capital AE	U+0041	A	Single character replaced with 2 characters, AE
			U+0045	E	
U+00E6	æ	Small ae	U+0061	a	Single character replaced with 2 characters, ae
			U+0065	e	
U+00D6	Ö	Capital O – diaeresis*	U+004F	O	Single character replaced with 2 characters, OE
			U+0045	E	
U+0152	Œ	Capital Ligature Oe	U+004F	O	Single character replaced with 2 characters, OE
			U+0045	E	
U+0153	œ	Small ligature oe	U+006F	o	Single character replaced with 2 characters, oe
			U+0065	e	
U+0132	IJ	Capital ligature IJ	U+0049	I	Single character replaced with 2 characters, IJ
			U+004A	J	
U+0133	ij	Small ligature ij	U+0069	i	Single character replaced with 2 characters, ij
			U+006A	j	
U+00DE	þ	Capital Thorn	U+0054	T	Single character replaced with 2 characters, TH
			U+0048	H	
U+00FE	þ	Small thorn	U+0074	t	Single character replaced with 2 characters, th
			U+0068	h	
U+00DC	Û	Capital U – diaeresis*	U+0055	U	Single character replaced with 2 characters, UE
			U+0045	E	
U+00FC	ü	Small u – diaeresis*	U+0075	u	Single character replaced with 2 characters, ue
			U+0065	e	
U+00DF	ß	Small sharp s	U+0073	s	Single character replaced with 2 characters, ss
			U+0073	s	

Preferred Name

The Preferred Name field can include some non-standard Latin characters that are allowed by SEVP. For example, characters with diaeresis, circumflex, grave, acute and ring above are allowed. This means that some of the conversions for the Full Name and Passport Name are not performed for Preferred Name. Also, punctuation marks such as, apostrophes, commas, and hyphens are allowed in Preferred Name.

Refer to the tables in the Full Name/Passport Name section for the character conversion.

Pages Used to Run the SEVIS Alerts Process

<i>Page Name</i>	<i>Definition Name</i>	<i>Navigation</i>	<i>Usage</i>
Process SEVIS Alerts - F/M, Process SEVIS Alerts - J	RUNCTL_CCSEVCOMP	<ul style="list-style-type: none"> • Campus Community > SEVIS > F/M Alerts > Process SEVIS Alerts - F/M • Campus Community > SEVIS > J Alerts > Process SEVIS Alerts - J 	Determine the events sent to the SEVIS Alerts table and extract the data to be sent to SEVIS for the respective visa type (F/M or J).

Running the SEVIS Alerts Process for F and M Visas

Access the Process SEVIS Alerts - F/M page (**Campus Community > SEVIS > F/M Alerts > Process SEVIS Alerts - F/M**).

The SEVIS Alerts process detects changes to your international student population that should be reported to SEVIS. A unique batch ID is generated each time the process runs. The naming scheme for this batch ID is YYYYMMDD-NNNNN, where YYYYMMDD represents the date on which the process runs and NNNNN represents the unique counter number. For example, the batch ID 20021219-00001 indicates that the process was run on December 19, 2002 and 00001 is the unique counter number. This batch ID and the SEVIS school code are keys to the records that you review on the Alerts Header page in the Select Alerts to Report - F/M component.

Note: All reportable institutions and careers for the SEVIS school code must appear on this page or the data will not be reported to SEVIS.

See [Setting Up SEVIS School Codes](#).

<i>Field or Control</i>	<i>Description</i>
SEVIS School Code	Enter the SEVIS school code for the process that you want to run.

Field or Control	Description
Validate SEVIS CIP Code	<p>Select <i>Yes</i> for the alerts process to compare CIP codes against the corresponding CIP Code Table page (Set Up SACR > Foundation Tables > Reporting Codes > CIP Code Table). When the Valid SEVIS CIP Code field on the CIP Code Table page is set to <i>Yes</i>, the process compares the code in the event against the valid code on the table. If the codes do not match, or if no valid code is available for comparing (the Valid SEVIS CIP Code on the CIP Code Table page is set to <i>No</i>), the process generates an error message that appears in the alerts.</p> <p>The validation process checks for valid CIP codes for these F/M events:</p> <ul style="list-style-type: none"> • Create Student, Education Level – Add. • Education Level – Cancel. • Program – Edit. <p>Select <i>No</i> to disable the automatic CIP code validation process. When the validation process is disabled, no validation notices appear in the alerts.</p> <p>See “Modifying CIP and HEGIS Codes” (Campus Solutions Application Fundamentals).</p>
Refresh	Click to refresh the page with data retrieved for the specified school code.

Trigger Complete Program After

If you enter a 0 or no number in the **F Students** or **M Students** fields, the Program - Complete event will trigger and appear on alerts for a complete program, but not based on the I-20 or OPT end date.

Field or Control	Description
F students	<p>Enter the number of days after either the I-20 end date or the OPT end date has passed for a complete program event to appear on the Alerts page for an F-1 student.</p> <p>The number can be between 0 and 60.</p>
M students	<p>Enter the number of days after either the I-20 end date or the OPT end date has passed for a complete program event to appear on the Alerts page for an M-1 student.</p> <p>The number can be between 0 and 30.</p>

Academic Information Selection

As of November 15, 2003, DHS regulations changed for reporting a registration event. The regulations changed from having to report the event within 90 days from the current term start date to having to report it within 30 days from the current term start date. The **As of Date** on the SEVIS Alerts process reflects this 30-day requirement.

Field or Control	Description
Institution and Career	<p>The system displays values for these when you click Refresh. You cannot edit values for these on this page. You must make valid changes for the SEVIS school code on the SEVIS School Code Table page.</p> <p>The Institution field appears only if more than one institution is mapped to the SEVIS school code.</p>
Current Term	<p>Enter the current term for each institution and career listed.</p> <p>The current term appears by default if the system date is between the term begin and end dates and only one term is defined for the institution and career within those dates.</p> <p>The current term value is used to determine the current session end date that is reported to SEVIS, and it is also used for the Registration and Auth Drop Below FC events.</p>
Next Term	<p>Enter the term that follows the current term for each institution and career listed.</p> <p>The prompt displays all terms for which the start date is greater than the system date.</p> <p>This term is used to determine the next session start date that is reported to SEVIS.</p>
As of Date	<p>Enter the date for each institution and career listed.</p> <p>The Registration and Auth Drop Below FC events are triggered based on this date.</p> <p>DHS regulations require that you report the Registration event within 30 days of the current term start date. You receive an error if the date that you enter does not meet the criteria. You can set this date prior to the start date of the current term entered if you want to report the Registration event prior to the current term begin date.</p> <p>You should update this field each time the Current Term and Next Term fields are refreshed.</p>

When you have entered the data, click **Run** to run the process.

Note: A warning message appears if the SEVIS Alerts process has been run in the past 12 hours. If any of the process's work was in progress when the SEVIS Alerts process for F/M visas runs again within that time period, you might lose the results of that work.

This table lists, by event, what must happen for an event to appear in the Alerts Header page for a student.

Event	Trigger Logic
Create Student	<p>The student has an immigration status on the Port of Entry Data page that equals the SEVIS visa type 01 (F-1) or 02 (M-1).</p> <p><i>OR</i></p> <p>If the Immigration Status field is blank on the Port of Entry Data page, the student has a visa type on the Visa/Permit Data page that equals SEVIS visa type 01 (F-1) or 02 (M-1) where the country is USA.</p> <p><i>AND</i></p> <p>The most recent effective-dated I-20 form has a status equal to <i>Active</i>.</p> <p><i>AND</i></p> <p>The most recent effective-dated I-20 form has the Funding Verified field set to <i>Y</i>.</p> <p><i>AND</i></p> <p>No rows exist in the SEVIS Master component for the user ID and school code on the I-20 form.</p> <hr/> <p>Note: For F-1 students, if the Secondary Major CIP and Minor CIP fields are not populated from the academic record of the student during the alerts process, then the process enters a CIP code of 00.0000 for those fields.</p>

Event	Trigger Logic
Selection Criteria for All Events Listed Below	<p>The student has an immigration status on the Port of Entry Data page that equals the SEVIS visa type 01 (F-1) or 02 (M-1).</p> <p><i>OR</i></p> <p>If the Immigration Status field is blank on the Port of Entry Data page, the student has a visa type on the Visa/Permit Data page that equals SEVIS visa type 01 (F-1) or 02 (M-1).</p> <p><i>AND</i></p> <p>The most recent effective-dated I-20 form has an Effective Status of <i>Active</i>.</p> <p><i>AND</i></p> <p>The most recent effective-dated I-20 form has Funding Verified set to <i>Y</i>.</p> <p><i>AND</i></p> <p>The SEVIS Status field in the SEVIS Master component is <i>Initial</i> or <i>Active</i>.</p>

Event	Trigger Logic
Auth Drop Below FC – Add	<p>The student has a SEVIS Status of <i>Active</i>.</p> <p>The As of Date field on the Process SEVIS Alerts – F/M page is earlier than or equal to the date when the process is run.</p> <p><i>AND</i></p> <p>The Registration event has been previously sent for the current term on the run control page.</p> <p><i>AND</i></p> <p>The Auth Reason field is either blank on the Registration page of the SEVIS Master component or the end date of the specified Auth Reason has passed.</p> <p><i>AND</i></p> <p>The total number of currently enrolled units for all institutions, careers, and current terms on the Process SEVIS Alerts - F/M page is less than the minimum full time level/load rules units for the academic program on the most recent effective-dated I-20 form.</p> <p>If Instruction Mode values are entered on the SEVIS Setup table, compare to Instruction Mode on Class table. If equal, use only the one class where STDNT_ENRL.UNT_TAKEN is greatest toward calculating full time. If no Instruction Mode values are entered on the SEVIS Setup table, apply all classes toward calculating full time.</p> <p><i>AND</i></p> <p>No Full Course Exception value exists for the run control term or the units do not meet those required for the exception.</p> <hr/> <p>Note: You can also manually enter this event on the Select Alerts to Report – F/M component.</p> <hr/>

Event	Trigger Logic
Auth Drop Below FC – Cancel	<p>This event is manually entered on Alerts – F/M. No logic exists to trigger the event.</p> <p>To manually enter the event, the following conditions must be met:</p> <p>SEVIS Status is <i>Active</i>.</p> <p><i>AND</i></p> <p>No inactive effective status rows exist on the SEVIS Master component, Registration page.</p> <p><i>AND</i></p> <p>A Drop Below Full Course Auth Reason value exists,</p> <p><i>AND</i></p> <p>The Drop Below Full Course Start Date value on the SEVIS Master component is later than the current system date.</p>
Auth Drop Below FC – Edit	<p>This event is manually entered on Alerts – F/M page. No logic exists to trigger the event.</p> <p>To manually enter the event, the following conditions must be met:</p> <p>The student has a SEVIS Status of <i>Active</i>,</p> <p><i>AND</i></p> <p>No inactive effective status rows exist on the SEVIS Master component, Registration page.</p> <p><i>AND</i></p> <p>A Drop Below Full Course Auth Reason value exists.</p> <p>If the date when the event is added is earlier than the Drop Below Full Course Start Date, then New Start Date, New End Date, Reason, and Remarks fields may be edited.</p> <p>The New Start Date cannot be less than the student's Program Start Date on the SEVIS Master component and must be later than or equal to the date on which the SEVIS Batch request is processed.</p> <p>The New End Date cannot be earlier than the current date, and it cannot be later than the student's Program End Date on the SEVIS Master component.</p>

Event	Trigger Logic
CPT Employment – Add	<p>The student has a SEVIS Status of <i>Active</i>.</p> <p>Employment type is <i>Curricular Practical Training</i> on the Employment Authorizations page and no employment type exists in the SEVIS Master component.</p> <p>Each new Curricular Practical Training sequence number added to the Employment Authorizations page that does not exist in the SEVIS Master component results in the event being triggered.</p>
CPT Employment – Cancel	<p>The student has a SEVIS Status of <i>Active</i>.</p> <p>Employment type on the Employment Authorizations page is <i>Curricular Practical Training (02)</i> and Cancel Employment is <i>Y</i> .</p> <p><i>AND</i></p> <p>The Cancel Employment value is <i>N</i> on the SEVIS Master component.</p> <p><i>AND</i></p> <p>Employment Start Date on the SEVIS Master component is later than the current system date.</p>
Dependent – Add	<p>The student has a SEVIS Status of <i>Initial</i> or <i>Active</i>.</p> <p>A dependent ID exists on the most recent effective-dated I-20 form where the Relationship Status value is <i>Active</i>.</p> <p><i>AND</i></p> <p>The dependent ID does not exist in the SEVIS Master component.</p>
Dependent – Cancel	<p>The student has a SEVIS Status of <i>Initial</i>.</p> <p>The Dependent Relationship Status value on the most recent effective-dated I-20 form is <i>Cancelled</i>.</p> <p><i>AND</i></p> <p>No Termination Reason or Cancel Reason appears on the SEVIS Master Dependents page for the dependent.</p>

Event	Trigger Logic
Dependent – Edit	<p>The student has a SEVIS Status of <i>Initial</i> or <i>Active</i>.</p> <p>A difference exists between the data in the SEVIS Master component and the following dependent data:</p> <ul style="list-style-type: none"> • Last Name • First Name • Middle Name • Name Suffix • Preferred Name • Passport Name • Birthdate • Sex • Birth Country • Citizenship Status • Citizenship Country • Preferred Email Address • Relationship on I-20 Dependents page
Dependent – Reactivate	<p>The student has a SEVIS Status of <i>Active</i>.</p> <p>The Relationship Status value in the SEVIS Master component is <i>Terminated</i>.</p> <p><i>AND</i></p> <p>The Relationship Status value on the most recent effective-dated I-20 form is <i>Active</i>.</p>

Event	Trigger Logic
Dependent – Reprint	<p>This event must be manually entered on the Alerts Header page. No logic exists to trigger the event.</p> <p>To enter this event manually, the following conditions must be met:</p> <p>The student has a SEVIS Status of <i>Initial</i> or <i>Active</i>.</p> <p>No inactive status rows exist on the Dependents page in the SEVIS Master component.</p> <p>The Additional Data prompt displays initial or active status dependents from which to select. You must select the dependent ID to send the event to SEVIS.</p>
Dependent – Terminate	<p>The student has a SEVIS Status of <i>Initial</i> or <i>Active</i>.</p> <p>The Relationship Status value in the SEVIS Master component is <i>Active</i>.</p> <p><i>AND</i></p> <p>The Relationship Status value on the most recent effective-dated I-20 form is <i>Terminated</i>.</p>
Disciplinary Action	<p>This event must be manually entered on the Alerts - F/M page. No logic exists to trigger the event.</p> <p>To enter the event manually, the following conditions must be met:</p> <p>The student has a SEVIS Status of <i>Active</i>.</p> <p>No inactive rows exist on the Bio/Demo page of the SEVIS Master component.</p>

Event	Trigger Logic
Education Level – Cancel	<p>The student has a SEVIS Status of <i>Active</i>.</p> <p><i>AND</i></p> <p>Two effective status active rows exist on the SEVIS Master component, Program tab.</p> <p><i>AND</i></p> <p>The Level of Education value on the most recent effective-dated I-20 form does not match the Level of Education value on the Initial Status SEVIS Master Program row.</p> <p><i>OR</i></p> <p>The From Date value on the most recent effective-dated I-20 form is different from the From Date value on the Initial Status SEVIS Master Program row.</p>
Education Level – Change	<p>The student has a SEVIS Status of <i>Active</i>.</p> <p><i>AND</i></p> <p>The most recent effective-dated I-20 Level of Education value is different from the Level of Education value on the SEVIS Master component.</p> <p><i>OR</i></p> <p>The From Date on the most recent effective-dated I-20 form is different from the From Date value on the SEVIS Master component, and the From Date value on the current I-20 form is later than the current system date.</p> <p><i>OR</i></p> <p>The the Initial Session Start Date on the most recent effective-dated I-20 form is different from the value on the SEVIS Master component.</p> <hr/> <p>Note: For F-1 students, if the Secondary Major CIP and Minor CIP fields are not populated from the academic record of the student during the alerts process, then the process enters a CIP code of <i>00.0000</i> for those fields.</p> <hr/>

Event	Trigger Logic
Financial Info	<p>The student has a SEVIS Status of <i>Initial</i> or <i>Active</i>.</p> <p>A difference exists between the data in the SEVIS Master component and the following data on the most recent effective-dated row on the I-20 form:</p> <ul style="list-style-type: none"> • Months in an Academic Term • Tuition and Fees • Living Expenses • Dependent Expenses • Other Expenses • Student's Personal Funds • Funds from this School • Funds from Another Source • On Campus Employment
Off Campus Employment – Add	<p>The student has a SEVIS Status of <i>Active</i>.</p> <p>Employment type is <i>Off-Campus</i> on the Employment Authorizations page and no employment type exists in the SEVIS Master component.</p> <p>Each new Off-Campus sequence number added to the Employment Authorizations page that does not exist in the SEVIS Master component, triggers the event.</p>
Off Campus Employment – Cancel	<p>The student has a SEVIS Status of <i>Active</i>.</p> <p>Employment type is <i>Off-Campus (03)</i> and Cancel Employment is <i>Y</i> on the Employment Authorizations page.</p> <p><i>OR</i></p> <p>The Rescind Recommendation value is <i>Y</i> on the Employment Authorizations page for Off-Campus employment.</p> <p><i>AND</i></p> <p>Employment type is <i>Off-Campus</i> where Recommend Employment is <i>Y</i> and Rescind Recommendation is not <i>Y</i> in the SEVIS Master component.</p>

Event	Trigger Logic
Off Campus Employment – Edit	<p>The student has a SEVIS Status of <i>Active</i>.</p> <p><i>AND</i></p> <p>Any of the following field values on the Employment Authorizations page where the employment type is <i>Off-Campus</i>, is different from the same values on the SEVIS Master component:</p> <ul style="list-style-type: none"> • Start Date (greater than or equal to the day that the process runs) • End Date • Reason
OPT Employment – Add	<p>The student has a SEVIS Status of <i>Active</i>.</p> <p>Employment type is <i>Optional Practical Training</i> on the Employment Authorizations page and no employment type exists in the SEVIS Master component.</p> <p>Request Status on the Employment Authorizations page is not Approved.</p> <p>Each new Optional Practical Training sequence number added to the Employment Authorizations page that does not exist in the SEVIS Master component triggers the event.</p> <p>Also, multiple employer records can now be included.</p>
OPT Employment – Cancel	<p>The student has a SEVIS Status of <i>Active</i>.</p> <p><i>AND</i></p> <p>Employment type is <i>Optional Practical Training (01)</i>, and Cancel Employment is <i>Y</i> on the Employment Authorizations page.</p> <p><i>AND</i></p> <p>Cancel Employment is <i>N</i> on the SEVIS Master component</p> <p><i>AND</i></p> <p>Employment start date on the SEVIS Master is greater than the current system date</p> <p><i>AND</i></p> <p>Request Status on the Employment Authorizations page is not Approved.</p>

Event	Trigger Logic
OPT Employment – Extend	<p>The student has a SEVIS Status of <i>Active</i>.</p> <p><i>AND</i></p> <p>Employment Type on the Employment Authorizations page and on the SEVIS Master component is <i>Optional Practical Training (01)</i>.</p> <p><i>AND</i></p> <p>Cancel Employment is <i>N</i> on the SEVIS Master component.</p> <p><i>AND</i></p> <p>Request Status on the Employment Authorizations page is <i>Approved</i>.</p> <p><i>AND</i></p> <p>Completion Type on the Employment Authorizations page is <i>Post Completion</i>.</p> <p><i>AND</i></p> <p>Extension is <i>N</i> on the SEVIS Master component.</p> <p><i>AND</i></p> <p>Extension is <i>Y</i> on the Employment Authorizations page.</p> <p>Multiple employer records can now be included. Each employer whose Extension Employer check box is selected is included. An error is reported if an employer is not included.</p>

Event	Trigger Logic
OPT Employment – Edit	<p>The student has a SEVIS Status of <i>Active</i>.</p> <p><i>AND</i></p> <p>Employment Type on the Employment Authorizations page and on the SEVIS Master component is <i>Optional Practical Training (01)</i>.</p> <p><i>AND</i></p> <p>Cancel Employment is <i>N</i> on the SEVIS Master component.</p> <p><i>AND</i></p> <p>The End Date or Extension End Date on the Employment Authorizations page is greater than or equal to the system current date.</p> <p><i>AND</i></p> <p>Request Status on the Employment Authorizations page is either <i>Requested</i> or <i>Pending</i>, and any of the following field values on the Employment Authorizations page are different from the same values on the SEVIS Master component:</p> <ul style="list-style-type: none">• Employment Code• Academic Year Met <hr/> <p>Note: The system also validates Edit events for Employer records associated with the original OPT segment, and not associated with the extension (where Extension Employer is not selected).</p> <hr/>

Event	Trigger Logic
OPT Report Participation	<p>The student has a SEVIS Status of <i>Active</i>.</p> <p><i>AND</i></p> <p>Employment Type on the Employment Authorizations page and on the SEVIS Master component is <i>Optional Practical Training (01)</i>.</p> <p><i>AND</i></p> <p>Cancel Employment is <i>N</i> on the SEVIS Master component.</p> <p><i>AND</i></p> <p>Request Status on the Employment Authorizations page is <i>Approved</i>.</p> <p><i>AND</i></p> <p>Last Participation Reported is <i>Not Reported</i> on the SEVIS Master component and the current date is less than or equal to the 6 month report date which is the OPT Extension Start Date plus (6 months minus 15 days). The event continues to trigger until the event is sent to SEVIS or to the SEVIS Master component and the Last Participation Reported field on the SEVIS Master is <i>6 Month Reported</i>.</p> <p><i>OR</i></p> <p>Last participation Reported is <i>6 Month Reported</i> on the SEVIS Master component and the current date is less than or equal to the 12 month report date which is the OPT Extension Start Date plus (12 months minus 15 days). The event continues to trigger until the event is sent to SEVIS or to the SEVIS Master component and the Last Participation Reported field on the SEVIS Master component is <i>12 Month Reported</i>.</p> <p><i>OR</i></p> <p>Last participation Reported is <i>12 Month Reported</i> on the SEVIS Master component and the current date is less than or equal to the 18 month report date which is the OPT Extension Start Date plus (18 months minus 15 days). The event continues to trigger until the Last Participation Reported field on the SEVIS Master component is <i>18 Month Reported</i>.</p>

Event	Trigger Logic
OPT Employer – Add	<p>This event is triggered for each new Employer Details record that is added to an existing OPT Employment record.</p> <p>The student has a SEVIS Status of <i>Active</i></p> <p><i>AND</i></p> <p>On the Employment Authorizations page, the Employment type is <i>Optional Practical Training (01)</i></p> <p><i>AND</i></p> <p>In SEVIS Master, Cancel Employment is <i>N</i></p> <p><i>AND</i></p> <p>End Date or Extension End Date on the Employment Authorizations page is greater than or equal to the system current date</p> <p><i>AND</i></p> <p>An OPT Employment event (Cancel, Edit, Report Participation, or Extend) has not already been generated for the same Employment Authorizations record</p> <p><i>AND</i></p> <p>The Employer Number on the Employment Authorizations page does not exist in the SEVIS Master Employer Details record</p> <p><i>AND</i></p> <p>If the Employer Number is '1', the Employer Name is not populated in SEVIS Master Employment. This condition is included to prevent Add events being generated where the employer has already been reported under the old schema.</p>

Event	Trigger Logic
OPT Employer – Edit	<p>This event is triggered for each Employer Details record that is updated for an existing OPT Employment record.</p> <p>The student has a SEVIS Status of <i>Active</i></p> <p><i>AND</i></p> <p>On the Employment Authorizations page, the Employment type is <i>Optional Practical Training (01)</i></p> <p><i>AND</i></p> <p>In SEVIS Master, Cancel Employment is <i>N</i></p> <p><i>AND</i></p> <p>End Date or Extension End Date on the Employment Authorizations page is greater than or equal to the system current date</p> <p><i>AND</i></p> <p>An OPT Employment event (Cancel, Edit, Report Participation, or Extend) has not already been generated for the same Employment Authorizations record</p> <p><i>AND</i></p> <p>The Employer Number on the Employment Authorizations page exists in SEVIS Master Employer Details record and one of the following values has changed: Employer Address 1, Employer Address 2, Employer City, Employer State, Employer Postal, Employer Start Date, Employer End Date <i>OR</i> the Employer Number is '1' and does not exist in SEVIS Master Employer Details and one of the following values has changed: Employer Address 1, Employer Address 2, Employer City, Employer State, Employer Postal.</p>

Event	Trigger Logic
Personal Info	<p>The student has a SEVIS Status of <i>Initial</i> or <i>Active</i>.</p> <p>A difference exists between any of the following field values on the SEVIS Master component and the same field values on their originating records:</p> <p>Name Type (The name type to compare against is based on the name type entered as the passport name on SEVIS Setup page. That name type is used to compare the name parts in the SEVIS Master component to the Name Type on the Bio/Demo page.)</p> <ul style="list-style-type: none">• Last Name• First Name• Middle Name• Name Suffix• Preferred Name• Passport Name <p>On the Bio/Demo page:</p> <ul style="list-style-type: none">• Birthdate• Gender• Birth Country• Citizenship Status• Citizenship Country• Preferred Phone Number• Preferred Email Address <p>On the Visa Permit Data/Port of Entry page, the Port of Entry Admission Number.</p> <p>On the I-20 form, the Commuter check box.</p> <p>The address type for the U.S. address is based on SEVIS Setup Address Mapping page. That address type is used to compare the U.S. address in the SEVIS master component to the Address Type on the Addresses page:</p> <ul style="list-style-type: none">• Address1• Address2• City• State

Event	Trigger Logic
	<ul style="list-style-type: none"> • Postal <p>The U.S. address Explanation Code and Text in the SEVIS Master component are compared to the values on the I-20 form.</p> <p>The address type for the foreign address is based on the SEVIS Setup Address Mapping page of the SEVIS Master component. That address type is used to compare the foreign address in the SEVIS master component to the Address Type on the Addresses page:</p> <ul style="list-style-type: none"> • Address1 • Address2 • City • State • Postal • Country
<p>Program - Cancel Extension</p>	<p>The student has a SEVIS Status of <i>Active</i>.</p> <p>The student's visa type is <i>M-1</i>.</p> <p><i>AND</i></p> <p>The To Date on the most recent effective-dated I-20 form is the same as the original To Date on the SEVIS Master component.</p>
<p>Program - Manage Session</p>	<p>The student has a SEVIS Status of <i>Initial</i>.</p> <p>The From Date on the SEVIS Master component is not the same as the From Date on the most recent effective-dated I-20 form.</p> <p><i>OR</i></p> <p>The To Date on the SEVIS Master component is not the same as the To Date on the most recent effective-dated I-20 form.</p> <p><i>OR</i></p> <p>The Initial Session Start Date on the SEVIS Master component is not the same as the Initial Session Start Date on the most recent effective-dated I-20 form.</p>

Event	Trigger Logic
<p>Program - Edit</p>	<p>The student has a SEVIS Status of <i>Initial</i> or <i>Active</i>.</p> <p><i>AND</i></p> <p>A difference exists between English Proficiency Required or English Proficiency on the most recent effective dated row of the I-20 Form and SEVIS Master component.</p> <p><i>OR</i></p> <p>A difference exists between primary major CIP, secondary major CIP, or minor CIP in the SEVIS Master component and the following data on either the Student Plan/Subplan page or the Application Program Data page:</p> <p>Primary major, secondary major, and minor are determined by first checking the student plan or subplan, and if no data exists, taking the data from the application plan or subplan.</p> <p>Primary major, secondary major, and minor are determined from the SEVIS Setup page. Primary major is from the active academic plan with the minimum student career number and minimum sequence number where the plan type is equal to any of the major academic plan types on the SEVIS Setup page.</p> <p>Secondary major comes from the active academic plan with the second most minimum sequence number where the plan type is equal to any of the listed major academic plan types on the SEVIS Setup page.</p> <p>Minor uses either the academic plan or academic subplan where the plan types are equal to those entered on the SEVIS Setup page. The minor selected from the academic subplan is the minimum sequence number with the plan type indicated related to the primary major. The minor selected from academic plan is the minimum sequence number where the plan type is equal to any of the minor plan types on the SEVIS Setup page.</p> <hr/> <p>Note: For F-1 students, if the Secondary Major CIP and Minor CIP field are not populated from the academic record of the students during the alerts process, then the process enters a CIP code of 00.0000 for those fields.</p> <hr/>
<p>Program - Extension</p>	<p>The student has a SEVIS Status of <i>Active</i>.</p> <p>The To Date on the SEVIS Master component is earlier than the To Date on the most recent effective-dated I-20 form.</p>
<p>Program - Shorten</p>	<p>The student has a SEVIS Status of <i>Active</i>.</p> <p>The To Date on the SEVIS Master component is later than the To Date on the most recent effective-dated I-20 form.</p>

Event	Trigger Logic
Registration	<p>The student has a SEVIS Status of <i>Initial</i> or <i>Active</i>.</p> <p><i>AND</i></p> <p>The As of date on the Process SEVIS Alerts – F/M component is earlier than or equal to the date when the process runs.</p> <p><i>AND</i></p> <p>The term in the SEVIS Master component Registration page is not equal to the current term on the Process SEVIS Alerts – F/M component, or the term on the SEVIS Master Registration page is blank.</p> <p><i>AND</i></p> <p>The student is currently enrolled in any institution, career, or term from the Process SEVIS Alerts – F/M component.</p> <p><i>OR</i></p> <p>The student has a full course exception for the current term on the Process SEVIS Alerts - F/M page for the institution and career on the I-20 form.</p> <hr/> <p>Note: If the Next Term (Process SEVIS Alerts – F/M page) has a start date that is later than the student's length of study To Date (I-20 Form page), then the system selects the Last Session check box on the Addl Data page (Select Alerts to Report – F/M component). This identifies the registration event as registration for the last session available within the student's allowed length of study.</p> <hr/>
Reprint	<p>You must manually enter this event on the Alerts F/M page. There is no logic to trigger the event.</p> <p>The following conditions must be met to manually enter this event:</p> <ul style="list-style-type: none"> • The student has a SEVIS Status of <i>Initial</i> or <i>Active</i>. • Reprint Reason is <i>Required</i> on the Additional Data page.

Event	Trigger Logic
Request Cap – Gap Extension	<p>The student has a SEVIS Status of <i>Active</i>.</p> <p><i>AND</i></p> <p>The Program End Date on the SEVIS Master component is less than or equal to the system current date.</p> <p><i>AND</i></p> <p>The SEVIS Master component Cap-Gap Status field is blank and the I-20 Form Cap-Gap Status field is populated.</p> <p><i>OR</i></p> <p>The SEVIS Master component Cap-Gap Status field is different than the Cap-Gap Status value on the current effective-dated I-20 Form row.</p>
Status - Cancel	<p>The student has a SEVIS Status of <i>Initial</i>.</p> <p><i>AND</i></p> <p>A cancel reason exists on the most recent effective-dated I-20 form.</p> <p><i>AND</i></p> <p>No cancel reason exists on the SEVIS Master component.</p>

Event	Trigger Logic
<p>Status - Complete</p>	<p>The student has a SEVIS Status of <i>Active</i>.</p> <p><i>AND</i></p> <p>The Program Action is <i>COMP</i> (complete program) on Student Program/Plan for the program on the I-20 form, and the student degree term end date for Completion Term is earlier than or equal to current date and no OPT employment exists where the OPT end date is later than the current date.</p> <p><i>OR</i></p> <p>The I-20 To date plus the number of days in the M Students or F Students field (as appropriate) on the Process SEVIS Alerts – F/M Run Control page is earlier than or equal to the current date and no OPT employment exists where the OPT end date is later than the I-20 to date.</p> <p><i>OR</i></p> <p>If the OPT end date is later than the I-20 to date and the OPT end date plus the number of days in the M Students or F Students field, as appropriate, on the Alerts – F/M Run Control page is earlier than or equal to the current date.</p> <p><i>OR</i></p> <p>If the OPT extension end date is later than the I-20 to date or the OPT end date and the OPT extension end date plus the number of days in the M Students or F Students field, as appropriate, on the Alerts – F/M Run Control page is earlier than or equal to the current date.</p> <hr/> <p>Note: The event will not trigger based on the I-20 to date, the OPT end date, or the OPT extension end date if the M Students or F Students field is blank on the Process SEVIS Alerts— F/M Run Control page. However, the event will trigger if Program Action is <i>COMP</i> and the M Students or F Students field is blank.</p> <hr/> <p>You can manually trigger this event.</p>

Event	Trigger Logic
<p>Status - Terminate</p>	<p>The student has a SEVIS Status of <i>Initial</i> or <i>Active</i>.</p> <p>Program Action is <i>DISC, DISM, WADM, SPND, LEAV, or ADRV</i> on the Student Program page for the institution, career, and program in the SEVIS Master component.</p> <p><i>AND</i></p> <p>None of the program actions exist in the SEVIS Master component.</p> <p><i>AND</i></p> <p>The student has no OPT employment, or the end date of the OPT employment is earlier than or equal to the effective date of the program action.</p> <p><i>OR</i></p> <p>Program Action is <i>WADM, WAPP, or ADRV</i> on the Application Program Data page for the institution, career, and program in the SEVIS Master component.</p> <p><i>AND</i></p> <p>None of the program actions exist in the SEVIS Master component.</p> <p><i>AND</i></p> <p>The student has no OPT employment or the end date or extension end date of the OPT employment is earlier than or equal to the effective date of the program action.</p> <p>You can manually enter this event on Alerts - F/M.</p> <hr/> <p>Note: Entering both a Cancellation Reason on the I-20 Form and a Program Action of <i>WADM, WAPP, or ADRV</i> on the Application Program Data page triggers the Status - Cancel event, but it does not trigger the Status - Termination event.</p> <hr/>
<p>Status - Verify</p>	<p>The student has a SEVIS Status of <i>Active</i>.</p> <p><i>AND</i></p> <p>The most recent effective-dated row from the SEVIS Master component is 180 days (6 months) less than the current system date.</p>

Running the SEVIS Alerts Process for J Visas

Access the Process SEVIS Alerts - J page (**Campus Community > SEVIS > J Alerts > Process SEVIS Alerts - J**).

The SEVIS Alerts process detects changes to your international exchange visitor population that should be reported to SEVIS. A unique batch ID is generated each time the process runs. The naming scheme for this batch ID is YYYYMMDD-NNNNN, where YYYYMMDD represents the date on which the process runs and NNNNN represents the unique counter number. For example, the batch ID 20041219-00001 indicates that the process was run on December 19, 2002 and 00001 is the unique counter number. This batch ID and the SEVIS program number are keys to the records that you review on the Alerts Header page in the Select Alerts to Report - J component.

Warning! All reportable institutions and careers for the SEVIS program number must appear on this page or the data will not be reported to SEVIS.

See [Setting Up Program Sponsors](#).

Field or Control	Description
SEVIS Program Number	Enter the SEVIS program number for the process you want to run.
Validate SEVIS CIP Code	<p>Select <i>Yes</i> for the alerts process to compare CIP codes against the corresponding CIP Code Table page (Set Up SACR > Foundation Tables > Reporting Codes > CIP Code Table). When the Valid SEVIS CIP Code field on the CIP Code Table page is set to <i>Yes</i>, the process compares the code in the event against the valid code on the table. If the codes do not match, or if no valid code is available for comparing (the Valid SEVIS CIP Code on the CIP Code Table page is set to <i>No</i>), the process generates an error message that appears in the alerts.</p> <p>The validation process checks for valid CIP codes for these J events:</p> <ul style="list-style-type: none"> • Create Exchange Visitor • Program – Edit Subject <p>Select <i>No</i> to disable the automatic CIP code validation process. When the validation process is disabled, no validation notices appear in the alerts.</p> <p>See “Modifying CIP and HEGIS Codes” (Campus Solutions Application Fundamentals).</p>
Refresh	Click to refresh the page with data retrieved for the specified program number.

Academic Information Selection

Field or Control	Description
Institution	<p>The Institution field appears only if more than one institution is mapped to the SEVIS program number.</p> <p>You cannot edit the institution on this page. You must make valid changes for the SEVIS program number on the SEVIS Program Sponsor Table page.</p>
Career	<p>The system displays the career when you click Refresh.</p> <p>You cannot edit the career on this page. You must make valid changes for the SEVIS program number on the SEVIS Program Sponsor Table page.</p>
Current Term	<p>Enter the current term for each institution and career listed.</p> <p>The current term appears by default if the system date is between the term begin and end dates, and only one term is defined for the institution and career within those dates.</p> <p>The current term value is used for the Validate event for student category exchange visitors.</p>
As of Date	<p>Enter the date for each institution and career listed.</p> <p>The Validate event is triggered for student category exchange visitors based on this date.</p> <p>Update this field each time the <i>Current Term</i> field is refreshed.</p>

When you have entered the data, click *Run* to run the process.

Note: A warning message appears if the process has been run in the past 12 hours. If any of the process's work was in progress when the SEVIS Alerts process for J visas runs again within that time period, you might lose the results of that work.

This table lists, by event, what must happen for an event to appear on the Alerts Headers page for an exchange visitor. Unless otherwise noted, all update events in the table are for active status exchange visitors.

Events	Trigger Logic
<p>Create Exchange Visitor</p>	<p>The exchange visitor has a Visa Type on the Visa Permit Data page is <i>SEVIS Visa Type 03 (J-1)</i> where the Country is <i>USA</i>.</p> <p><i>AND</i></p> <p>Status is <i>Active</i> on the most recent effective-dated DS-2019 form.</p> <p><i>AND</i></p> <p>Funding Verified is <i>Y</i> on the most recent effective-dated DS-2019 form.</p> <p><i>AND</i></p> <p>The reason code is provided if Country of Birth is <i>US</i> or <i>US Territory</i>.</p> <p><i>AND</i></p> <p>No rows exist for ID and Program Sponsor on the DS-2019 form in the SEVIS Master component.</p>
<p>Selection Criteria for All Events Listed Below</p>	<p>The exchange visitor's immigration status in port of entry data is <i>SEVIS Visa Type 03 (J-1)</i>.</p> <p><i>OR</i></p> <p>If the Immigration Status field is blank on the Port of Entry Data page, the exchange visitor's visa type on the Visa Permit Data page is <i>SEVIS Visa Type 03 (J-1)</i> where the Country is <i>USA</i>.</p> <p><i>AND</i></p> <p>Effective Status is <i>Active</i>. on the most recent effective-dated DS-2019 form.</p> <p><i>AND</i></p> <p>Funding Verified is <i>Y</i> on the most recent effective-dated DS-2019 form.</p> <p><i>AND</i></p> <p>SEVIS Status on the SEVIS Master component is <i>Initial, Inactive</i> or <i>Active</i>.</p>

Events	Trigger Logic
Biographical	<p>The exchange visitor has a SEVIS Status of <i>Initial</i> or <i>Active</i>.</p> <p>A difference exists between any of the following fields on SEVIS Master component and the same fields on their originating records:</p> <p>The Name Type to compare against is based on the Name Type entered as the Passport Name on SEVIS Setup page. Name Type is used to compare the name parts in the SEVIS Master component to the Name Type on the Bio/Demo page.</p> <ul style="list-style-type: none">• Last Name• First Name• Middle Name• Name Suffix• Preferred Name• Passport Name <p>On the Bio/Demo page:</p> <ul style="list-style-type: none">• Birthdate• Sex• Birth Country• Birth Location• Preferred Phone Number• Preferred Email Address <p>Address Type for the U.S. address is based on the SEVIS Setup Address Mapping page. Address Type is used to compare the U.S. address in the SEVIS Master component to the Address Type on the Addresses page:</p> <ul style="list-style-type: none">• Address1• Address2• City• State• Postal <p>The U.S. address Explanation Code and Text in the SEVIS Master component are compared to the values on the I-20 form.</p>

Events	Trigger Logic
	<p>Address Type for the mailing address is based on the SEVIS Setup Address Mapping page. Address Type is used to compare the mailing address in the SEVIS Master component to the Address Type on the Addresses page:</p> <ul style="list-style-type: none"> • Address1 • Address2 • City • State • Postal <p>The mailing address Explanation Code and Text in the SEVIS Master component are compared to the values on the DS-2019 form.</p> <p>Most recent effective-dated row on the DS-2019 for:</p> <ul style="list-style-type: none"> • Permanent Residence Country • Position Code • Citizenship Country • Birth Country Reason
<p>Dependent – Add</p>	<p>The exchange visitor has a SEVIS Status of <i>Initial</i> or <i>Active</i>.</p> <p>A dependent ID exists on the most recent effective-dated DS-2019 form where the relationship status is <i>Active</i></p> <p><i>AND</i></p> <p>The dependent ID does not exist in the SEVIS Master component.</p>
<p>Dependent – Delete</p>	<p>The exchange visitor has a SEVIS Status of <i>Initial</i>.</p> <p>The relationship status in the SEVIS Master component is <i>Active</i>.</p> <p><i>AND</i></p> <p>The relationship status on the most recent effective-dated DS-2019 form is <i>Deleted</i>.</p>

Events	Trigger Logic
Dependent – Edit	<p>The exchange visitor has a SEVIS Status of <i>Initial</i> or <i>Active</i>.</p> <p>For each dependent listed in the SEVIS Master component, a difference exists between the data on SEVIS Master component and the following data:</p> <ul style="list-style-type: none"> • Last Name • First Name • Middle Name • Name Suffix • Preferred Name • Passport Name • Birthdate • Birth Location • Sex • Birth Country • Citizenship Country • Preferred Email Address • Relationship (on DS-2019 form) • Permanent Residence Country (on DS-2019 form) • Birth Country Reason (on DS-2019 form)
Dependent – End Status	<p>The exchange visitor has a SEVIS Status of <i>Active</i>.</p> <p>The relationship status on the most recent effective-dated DS-2019 Form is <i>Ended Status</i> and an end status reason is provided.</p> <p><i>AND</i></p> <p>The relationship status for the dependent ID on SEVIS Master component is <i>Active</i>.</p>

Events	Trigger Logic
Dependent – Reprint	<p>This event must be manually entered on the Alerts Header page. No logic exists to trigger the event.</p> <p>The following conditions must be met to manually enter this event:</p> <ul style="list-style-type: none"> • The exchange visitor has a SEVIS Status of <i>Active</i>. • No inactive status rows exist on the SEVIS Master Dependents page. • Dependents with <i>Initial</i> or <i>Active</i> status are available from the Additional Data prompt list. <p>You must select the dependent ID to send the event to SEVIS.</p>
Dependent – Terminate	<p>The exchange visitor has a SEVIS Status of <i>Active</i>.</p> <p>The relationship status in the SEVIS Master component, Dependents page is <i>Active</i>.</p> <p><i>AND</i></p> <p>The relationship status on the most recent effective-dated DS-2019 form is <i>Terminated</i> and a termination reason is provided.</p>

Events	Trigger Logic
Financial Info	<p>The exchange visitor has a SEVIS Status of <i>Initial</i> or <i>Active</i>.</p> <p>A difference exists between the data on the SEVIS Master component and the following data on the most recent effective-dated row on the DS-2019 form:</p> <ul style="list-style-type: none"> • Received U.S. Gov Funds • Current Program Sponsor • GovtOrg1 • GovtOrg1Amount • GovtOrg2 • GovtOrg2Amount • InternatOrg1 • InternatOrg1Amount • InternatOrg2 • InternatOrg2Amount • EV Govt • Binational Commission • Other Org • Personal Funds
Program – Amend	<p>The exchange visitor has a SEVIS Status of <i>Initial</i>.</p> <p>The Start Date on the SEVIS Master component is different from the Start Date on the most recent effective-dated DS-2019 form.</p> <p><i>OR</i></p> <p>The End Date on SEVIS Master is different from the End Date on the most recent effective-dated DS-2019 form.</p>

Events	Trigger Logic
<p>Program – Edit Subject</p>	<p>The exchange visitor has a SEVIS Status of <i>Initial</i> or <i>Active</i>.</p> <p><i>AND</i></p> <p>If the Program Category on most recent dated DS-2019 row is <i>1a, 1b, 1c, 1d, 1e, or 1f</i>.</p> <p><i>AND</i></p> <p>A difference exists between the Subject Field code on the SEVIS Master component and the minimum sequence number on Student Plan where the Plan Type equals any of the plan types defined on the SEVIS Setup for the Institution and Career page of the student exchange visitor.</p> <p><i>OR</i></p> <p>If the Program Category is not <i>1a, 1b, 1c, 1d, 1e, or 1f</i>.</p> <p><i>AND</i></p> <p>A difference exists between the Subject Field code on the SEVIS Master component and the Subject Field code on the most recent effective-dated DS-2019 form.</p> <p><i>OR</i></p> <p>If Visitor's Category on the DS-2019 Form is <i>Student Intern (1G)</i>, and a difference exists between the Foreign Degree Level on the SEVIS Master component and the Foreign Degree Level on the most recent DS-2019 row.</p> <p><i>OR</i></p> <p>If Visitor's Category on the DS-2019 Form is <i>Student Intern (1G)</i>, and a difference exists between the Foreign Field of Study on the SEVIS Master component and the Foreign Field of Study on the most recent DS-2019 row.</p> <hr/> <p>Note: For compare processing, the alerts process strips out all blanks and spaces from the Foreign Degree Level and Foreign Field of Study fields and converts the data to all upper case.</p> <hr/>
<p>Program – Extension</p>	<p>The exchange visitor has a SEVIS Status of <i>Active</i>.</p> <p>The End Date on SEVIS Master is less than the End Date on the most recent effective-dated DS-2019 form.</p>

Events	Trigger Logic
Program - Matriculate	<p>The exchange visitor has a SEVIS Status of <i>Active</i>.</p> <p>The Visitor Category on the SEVIS Master component is different from the Visitor Category on the most recent effective dated DS-2019 Form when any of the following scenarios occur:</p> <ul style="list-style-type: none"> • Student Associate to Student Bachelors • Student Associate to Student Masters • Student Associate to Student Doctorate • Student Bachelors to Student Master • Student Bachelors to Student Doctorate • Student Master to Student Doctorate
Program – Shorten	<p>The exchange visitor has a SEVIS Status of <i>Active</i>.</p> <p>The End Date on the most recent effective-dated DS-2019 form is earlier than the End Date on the SEVIS Master component.</p>
Reprint	<p>The exchange visitor has a SEVIS Status of <i>Active</i>.</p> <p>This event must be manually entered on the Alerts Header page. No logic exists to trigger the event.</p>
Site of Activity – Add	<p>The exchange visitor has a SEVIS Status of <i>Initial</i> or <i>Active</i>.</p> <p>A Site of Activity with a status of <i>Active</i> exists on the most recent effective-dated DS-2019 form that does not exist on SEVIS Master component.</p>
Site of Activity – Delete	<p>The exchange visitor has a SEVIS Status of <i>Initial</i>.</p> <p>A Site of Activity with a status of <i>Inactive</i> exists on the most recent effective-dated DS-2019 form and the same Site of Activity has a status of <i>Active</i> on the SEVIS Master component.</p>

Events	Trigger Logic
Site of Activity – Edit	<p>The exchange visitor has a SEVIS Status of <i>Initial</i> or <i>Active</i>.</p> <p>Address 1, Address 2, City, State,Postal, Explanation Code, and Explanation Text fields for each active Site of Activity on the most recent effective-dated DS-2019 form are different from any of the same fields on the SEVIS Master component.</p> <p><i>OR</i></p> <p>The name on the most recent effective-dated row on the Site of Activity table is not equal to the name on the SEVIS Master.</p>
Status – Correct Infraction	<p>The exchange visitor has a SEVIS Status of <i>Active</i> or <i>Inactive</i>.</p> <p>This event must be manually entered on the Alerts Header page. No logic exists to trigger the event.</p>
Status – End	<hr/> <p>Note: This event is not supported in release 6.23 and is no longer generated.</p> <hr/> <p>The exchange visitor has a SEVIS Status of <i>Active</i>.</p> <p>If Program Category on the most recent effective-dated DS-2019 row equals <i>1a, 1b, 1c, 1d, 1e, or 1f</i>.</p> <p>Student Program program action is <i>Complete Program (COMP)</i> for the institution, career, and student career number on the SEVIS Master component, and the program action on the SEVIS Master component is not equal to <i>Complete Program</i>.</p>
Status - Invalid	<p>This event must be manually entered on the Alerts Header page. No logic exists to trigger the event.</p> <p>The following conditions must be met to manually enter this event:</p> <ul style="list-style-type: none"> • The exchange visitor has a SEVIS Status of <i>Initial</i>. • No inactive status rows exist on the SEVIS Master Bio/Demo and Employment/SOA pages.
Status - No Show	<p>This event must be manually entered on the Alerts Header page. No logic exists to trigger the event.</p> <p>The following conditions must be met to manually enter this event:</p> <ul style="list-style-type: none"> • The exchange visitor has a SEVIS Status of <i>Initial</i>. • No inactive status rows exist on the SEVIS Master Bio/Demo and Employment/SOA pages.

Events	Trigger Logic
Status - Terminate	<p>This event must be manually entered on the Alerts Header page. No logic exists to trigger the event.</p> <p>The following conditions must be met to manually enter this event:</p> <ul style="list-style-type: none"> • The exchange visitor has a SEVIS Status of <i>Inactive</i> or <i>Active</i>. • No inactive status rows exist on the SEVIS Master Bio/Demo and Employment/SOA pages.
Validate	<p>The exchange visitor has a SEVIS Status of <i>Initial</i>.</p> <p>The As of Date on the Process SEVIS Alerts - J run control page is the same as or earlier than the current date.</p> <p><i>AND</i></p> <p>The exchange visitor has a term activation row for the current term on the Process SEVIS Alerts - J page where the institution and career equals the data on Term Activation.</p> <hr/> <p>Note: Manually enter this event on the Alerts Header page of the Select Events to Report - J component if the exchange visitor is in a nonstudent program category. For manual validate events, an error is not reported for phone numbers that exceed 10 digits.</p> <hr/>

Related Links

[Understanding Name Population](#)

Viewing SEVIS Alerts Process Data

Use pages in the Select Alerts to Report - F/M or Select Alerts to Report - J component to review the events triggered for each student or exchange visitor after running the SEVIS Alerts process for the specific visa type.

The SEVIS school code for F/M visas or the SEVIS program code for J visas and batch ID information are keyed to the data on the Alerts Header page in the component. The batch ID is a unique number generated by the SEVIS Alerts process. Access to the component is controlled through program code or school code security respectively. By using the SEVIS program code or school code and batch ID, you are able to review errors, enter additional data, and indicate if the event should be submitted to SEVIS or to the SEVIS Master component. You can also indicate if a new I-20 is needed for the student or a new DS-2019 form is needed for the exchange visitor.

On the Alerts Headers page, default values appear for the **New Form** and **Send To** fields according to the values defined on the SEVIS Event Types page. The system displays these default values only if the event has no errors.

Set the **Send To** field on the Alerts Header page to *Master* to update the event in the SEVIS Master component, or set the field to *None* to prevent processing the event until you can evaluate errors and determine whether to send it to SEVIS or update the SEVIS Master component.

Note: The system automatically sets the **Send To** field on the Alerts Header page to *SEVIS* when the **Send to SEVIS** check box is selected for the event type on the SEVIS Event Types page and when no errors are detected during processing and no additional data is required. Only rows set to send to *SEVIS* on the Alerts Header page are extracted to the XML file to send to SEVIS.

Clicking **Set All "Send To" to SEVIS** sets the **Send To** field to *SEVIS* for all events where no errors exist and additional data is required.

After reviewing and correcting events data in the Select Alerts to Report component, run the Export SEVIS Events process to create the XML file to send to SEVIS or to update the SEVIS Master component before running the SEVIS Alerts process for that visa type again. Refer to the process flow at the beginning of this document to better understand when to run this process.

Note: Data entered on the Additional Data page in the Select Alerts to Report component is lost if the Export SEVIS Events process is not run before the SEVIS Alerts process is run again for that visa type.

This section discusses how to:

- Select data to review.
- Review alerts data.
- Enter additional data for an event.
- View event errors data.

Pages Used to View SEVIS Alerts Process Data

<i>Page Name</i>	<i>Definition Name</i>	<i>Navigation</i>	<i>Usage</i>
Selection	SEV_REV_U_FILTER	<ul style="list-style-type: none"> • Campus Community > SEVIS > F/M Alerts > Select Alerts to Report - F/M > Selection • Campus Community > SEVIS > J Alerts > Select Alerts to Report - J > Selection 	Select data to review.

Page Name	Definition Name	Navigation	Usage
Alerts Header	SEV_ALERT_HEADER	<ul style="list-style-type: none"> • Campus Community > SEVIS > F/M Alerts > Select Alerts to Report - F/M > Alerts Header • Campus Community > SEVIS > J Alerts > Select Alerts to Report - J > Alerts Header 	Review data on alerts page.
Addl Data (additional data)	SEV_REV_FMUPD	<ul style="list-style-type: none"> • Campus Community > SEVIS > F/M Alerts > Select Alerts to Report - F/M > Addl Data • Campus Community > SEVIS > J Alerts > Select Alerts to Report - J > Addl Data 	Enter any additional data required for this event.
Errors	SEV_REV_U_ERRORS	<ul style="list-style-type: none"> • Campus Community > SEVIS > F/M Alerts > Select Alerts to Report - F/M > Errors • Campus Community > SEVIS > J Alerts > Select Alerts to Report - J > Errors 	View event errors.
Message Explanation	SEV_REV_ERR_EXPL	Click More on the Errors page.	Review the error message information.

Selecting Data to Review

Access the Selection page (**Campus Community > SEVIS > F/M Alerts > Select Alerts to Report - F/M > Selection**).

Field or Control	Description
SEVIS School Code or SEVIS Program Number	The system displays either the SEVIS School Code and associated fields for F and M visas, or the SEVIS Program Number and associated fields for J visas.

Filter Options

If you have a large number of events to view, you can filter the data based on options in this area.

Field or Control	Description
School Official or Responsible Officer	For the F and M visas school official, enter the DSO assigned to the students who appear on the Alerts Header page. The prompt displays all DSOs defined on the SEVIS School Code Table page for the SEVIS school code listed. For the J visas responsible officer, enter the RO/ARO assigned to the exchange visitors who appear on the Alerts Header page.
Student ID or Exchange Visitor	For the F and M visas student ID, enter the student's ID (EmplID) whose events you want to review. For the J visas exchange visitor, enter the exchange visitor's ID (EmplID) whose events you want to review. The prompt displays all IDs that have events.
Event Type	Select a specific event to review.
Errors	Select to review events that have errors or events that have no errors.
Additional Data	Select to review events requiring additional data or events that require no further editing.
Send to SEVIS	Select to review events that have no additional data, or that have optional or required additional data.
Alert Nbr Range (alert number range) From and Through	The system assigns a unique alert number to each event row for each Batch ID. Select an alert number range to review only the events within the range.
Clear	Click to clear the data in the Filter Options group box.

Field or Control	Description
Apply	Click to filter the alerts results based on the data entered in the Filter Options group box.
Show All	Click to show all of the events on the Alerts Header page.

Reviewing Alerts Data

Access the Alerts Header page. (For F/M alerts, **Campus Community > SEVIS > F/M Alerts > Select Alerts to Report - F/M > Alerts Header**. For J alerts, **Campus Community > SEVIS > J Alerts > Select Alerts to Report - J > Alerts Header**.)

This example illustrates the fields and controls on the Alerts Header page. You can find definitions for the fields and controls later on this page.

SEVIS Alert Events									
Alert #	ID	Name	*Event Type				New Form	*Send To	RO Name
1	SEV0611	Woolfsberg III, Thomas Ivan	CreateEV	Form	Errors			Master	Floren Webb
2	SEV0612	Smith, Maureen Michelle	FinancialInfo	Details	Form		<input checked="" type="checkbox"/>	SEVIS	Floren Webb
3	SEV0612	Smith, Maureen Michelle	Dependent - Edit	Details	Form	Addl Data	<input checked="" type="checkbox"/>	SEVIS	Floren Webb
4	SEV0613	Silverstein, Jacob John	Program - EditSubject	Details	Form	Reqd Data	<input checked="" type="checkbox"/>	None	Jan Peck
5	SEV0613	Silverstein, Jacob John	Program - Extension	Details	Form	Addl Data	<input checked="" type="checkbox"/>	SEVIS	Jan Peck
6	SEV0613	Silverstein, Jacob John	SiteOfActivity - Edit	Details	Form	Addl Data	<input checked="" type="checkbox"/>	SEVIS	Jan Peck
7	SEV0614	Howard, Sheila Anne	Dependent - Edit	Details	Form	Addl Data	<input checked="" type="checkbox"/>	SEVIS	Floren Webb
8	SEV0614	Howard, Sheila Anne	Dependent - Terminate	Form				SEVIS	Floren Webb
9	SEV0615	Mason, Macia Marie	Program - Shorten	Details	Form	Reqd Data	<input checked="" type="checkbox"/>	None	Floren Webb
10	SEV0615	Sorensen, Elizabeth Jane	Reprint	Form	Reqd Data		<input checked="" type="checkbox"/>	None	Floren Webb

The Alerts Header page lists the events that will trigger when the Process SEVIS Alerts process runs for the specific visa type.

If the **Send To SEVIS** check box on the SEVIS Event Types page is selected for the event type, and the event has no errors, the system sets the **Send To** value to *SEVIS*, and the Extract SEVIS process includes the event in the XML file to send to SEVIS. If the **Form Request Available** check box on the SEVIS Event Types page is selected, the system also displays the **New Form** check box already selected on the Alerts Header page to request a new I-20 for F and M visas or a new DS-2019 form for J visas. You can change the default **Send To** value for each event.

The Extract SEVIS process does not include events set to *Master* or *None* in the XML file to send to SEVIS.

When the **Send To** field is set to *Master* (for Master Sync), the Alerts process synchronizes the event data by directly uploading it to the appropriate fields on the active effective status row in the SEVIS Master component, and the Extract SEVIS process updates the **SEVIS Status** value if needed.

For Create Student for F and M visas or Create EV events for J visas set to *Master*, the Alerts process inserts new active status rows in the SEVIS Master component, and the Extract SEVIS process sets the **SEVIS Status** to *Initial*. This enables you to update the SEVIS Master component with data entered manually in SEVIS RTI.

Note: If you set the **Send To** field to *Master* for a Create Student, Create EV, or Dependent - Add event types, you must manually enter the SEVIS ID for the student or exchange visitor and their dependents on the SEVIS ID Maintenance page.

When errors occur, the SEVIS Alerts process sets the **Send To** field to *None*. You can change it to *Master* to send the event without clearing the errors. Review the errors before changing it. Correct errors as necessary, and run the Alerts process for that visa type again to trigger the events with no errors before updating the SEVIS Master directly.

An example of when you might want to change *None* to *Master* for F and M visas without correcting the data is when the error occurs because the **From** date is not later than or equal to the current system date for an initial creation Create Student event. The student might have been created in RTI in the past and you need to reflect the dates as they appear in RTI, and therefore the error is acceptable.

An example of when you might want to change *None* to *Master* for J visas without correcting the data is when the error occurs because the **Start** date is not later than or equal to the current system date for Create EV event. The exchange visitor might have been created in RTI in the past and you need to reflect the dates as they appear in RTI, and therefore the error is acceptable.

You can add a row to manually enter an event for a student or exchange visitor if the **Allow Manual Addition** check box is selected for the event type on the SEVIS Event Types page and the student has a SEVIS ID for the specified school code or the exchange visitor has a SEVIS ID for the specified program code.

When the SEVIS Alerts process for the visa type runs, it moves all events with no errors to the View SEVIS Events History component.

Field or Control	Description
SEVIS School Code or SEVIS Program Number	The page displays either the SEVIS School Code and associated fields for F and M visas or the SEVIS Program Number and associated fields for J visas.
Send All Rows to SEVIS	Click to set all the Send To fields to <i>SEVIS</i> for all events with no errors and for which no additional data is required. Only events that have no errors and need no additional data can be changed.
Set All Rows to None	Click to set all of the Send To fields to <i>None</i> , preventing them from being submitted to SEVIS during the Extract process.

Field or Control	Description
Send All Rows to Master	Click to set all the Send To fields to <i>Master</i> for all events for which no additional data is required.

SEVIS Alert Events

Field or Control	Description
Name	<p>Click the name to access the individual's Bio/Demo Data page in update/display mode.</p> <p>The page opens in a new window.</p>
Details	<p>This link is available only when the Compare Detail check box on the SEVIS Event Types page, Event Defaults tab, is selected for the event type</p> <p>Click to access the Compare Detail page where you can view the changes in data that triggered the event.</p>
Form	<p>Click the link to open the I-20 form for F and M visas or the DS-2019 form for J visas in update/display mode.</p> <p>The form opens in a new window.</p>
Errors	<p>Appears only if errors are detected.</p> <p>Click the link to access the Errors page.</p> <p>You must correct errors and run the Alerts Process for that visa type again to be able to set the Send to field to <i>SEVIS</i>. You can select <i>Master</i> without clearing the errors.</p>
Addl Data (additional data) or Reqd Data (required additional data)	<p>If the Addl Data link appears, additional data is optional. Select the link to access the Additional Data page where you can enter the data.</p> <p>If the Reqd Data link appears, additional data is required. Select the link to access the Additional Data page where you must enter values in the required fields before you can set the Send To field to either <i>Master</i> or <i>SEVIS</i>.</p> <p>No link appears if no additional data is permitted or required.</p> <p>For a list of the event types that have required or optional additional data, refer to the description of the Addl Data field on the SEVIS Event Types page.</p>

Field or Control	Description
New Form	<p>The system requests a new I-20 form for F and M visas or a new DS-2019 form for J visas if the event has no errors and if the New Form check box for the event type is selected on the SEVIS Event Types page.</p> <p>You can override the default value.</p>
Send to	<p>Select:</p> <ul style="list-style-type: none"> • <i>Master</i> to update the SEVIS Master component directly with data already entered in the SEVIS RTI. The SEVIS Extract process for the visa type does not include events set to <i>Master</i> in the XML file to send to SEVIS. • <i>SEVIS</i> to include the event in the XML file to send to SEVIS. The system automatically displays <i>SEVIS</i> if the event has no errors and the Send To SEVIS check box for the event type is selected on the SEVIS Event Types page. • <i>None</i> to prevent the process from updating the SEVIS Master component with the event data or from including the event in the XML file.
DSO Name or RO Name	<p>For F and M visas, the system displays the name of the DSO listed on the most recent I-20 form, and for J visas the system displays the name of the RO listed on the most recent DS-2019 form. Select the name to view a list of DSOs or ROs. If a different DSO or RO is responsible for this event, select the correct one to include in the XML file to send to SEVIS.</p>

Entering Additional Data for an Event

Access the Addl Data page. (For F/M visas, **Campus Community > SEVIS > F/M Alerts > Select Alerts to Report - F/M > Addl Data**. For J visas, **Campus Community > SEVIS > J Alerts > Select Alerts to Report - J > Addl Data**.)

Fields and data on this page change based on the event type.

Field or Control	Description
None, Send to SEVIS, Master Synch	<p>These options appear based on the value set in the Send To field on the Alerts Header page. If additional data is required data, then you must enter it before you can select Send to SEVIS or Master Synch and save the page.</p>

Field or Control	Description
End Program Reason	<p>For Program - Shorten, select the reason for shortening the program:</p> <ul style="list-style-type: none"> • APED – Adjusted program end date • CSHS – Cultural shock/homesickness • DOE – Death of EV • IFS – Inadequate financial support • MEHE – Medical emergency/health • MEHF – Medical/health of family • OTHR – Other • POCE – Program objectives completed early • WFP – Withdrawal from program

The US Address region appears below Email Address and is read-only. This follows the format of the I-20 form. Also, the fields **Explanation Code** and **Explanation Text** are available. These fields allow you to view any values that have been populated from the I-20 or DS-2019 form, as well as enter or update the values as required.

Note: If you update the values in **Explanation Code** and **Explanation Text** on this page, you must also update the corresponding fields on the I-20 or DS-2019 form. This ensures that the values are in sync with the information reported to SEVIS and what is stored in SEVIS Master.

If you do not update the fields on the I-20 or DS-2019 form, a PersonalInfo or Biographical event is generated for the difference in values between SEVIS Master and the I-20 form or DS-2019 form. This applies to the events CreateStudent, PersonalInfo and Registration for F/M, and Create EV, Biographical, and Validate for J.

For a list of the event types that have required or optional additional data, refer to the SEVIS Event Types page, Addl Data field description.

Viewing Event Errors Data

Access the Errors page. (For F/M visas, **Campus Community > SEVIS > F/M Alerts > Select Alerts to Report - F/M > Errors**. For J visas, **Campus Community > SEVIS > J Alerts > Select Alerts to Report - J > Errors**.)

The Errors page lists data errors detected by the Alerts process for the event. You must correct the data error before the event can be included in the XML file to send to SEVIS. However, you can choose to ignore the error for Master Sync and set the **Send To** field on the Alerts Header page to *Master*. Most errors indicate that required data is missing for the student or exchange visitor, or the dependent. If data is missing for a dependent, the ID of the dependent is listed in the error. Consult the U.S. Immigrations and Customs Enforcement web site for a listing of required fields by event.

See [Reference Manual for the Student and Exchange Visitor Information System Batch Interface, Application Program Interface \(API\)](#).

Select the **More** link to view additional detail regarding the error.

Viewing Event History Information

The system provides a listing by ID of each event from the Select Alerts to Report components that did not contain errors. This provides a historical tracking of the events triggered by the Process SEVIS Alerts process for the visa type and the events submitted to SEVIS. You can view the data sent to SEVIS and the results of the processing by SEVIS.

This section discusses how to:

- View the event history summary.
- View event history detail information.
- View event process details.

Pages Used to View Event History Information

<i>Page Name</i>	<i>Definition Name</i>	<i>Navigation</i>	<i>Usage</i>
History Summary	SEV_HIST_SUMMARY	Campus Community > SEVIS > View SEVIS Events History > History Summary	View a listing of events without errors that have triggered for a student or exchange visitor.
History Detail - F/M	SEV_HIST_DETAIL	Campus Community > SEVIS > View SEVIS Events History > History Detail - F/M	View the data for each event for F and M visa holders.
History Detail - J	SEV_HIST_DETAIL_EV	Campus Community > SEVIS > View SEVIS Events History > History Detail - J	View the data for each event for J visa holders.
Details	SEV_HST_I_CRE_SEC	Click the More link on the History Detail - F/M or the History Detail - J page.	View additional data from the event.
SEVIS Alerts Addresses	SEV_REV_U_ADD_SEC	Click the Addr Info link on the History Detail - F/M or the History Detail - J page.	View address data related to the event.
Process Detail	SEV_HIST_DWN_RSLT	Campus Community > SEVIS > View SEVIS Events History > Process Detail	View the results of the processing by SEVIS.

Viewing the Event History Summary

Access the History Summary page (**Campus Community > SEVIS > View SEVIS Events History > History Summary**).

All events on the SEVIS Alerts page that do not have errors are listed here. The history summary data is populated each time the Process SEVIS Alerts process for the visa type is run. The date when the event is triggered, the batch ID, and the DSO assigned to the student on the I-20 form for F and M visas or the RO/ARO assigned to the exchange visitor on the DS-2019 for J visas, appear along with the additional information listed here.

Field or Control	Description
SEVIS School Code or SEVIS Program Number	The system displays either the SEVIS School Code and associated fields for F and M visas or the SEVIS Program Number and associated fields for J visas.
Addl Data (additional data)	<p>You can click this link to access the History Detail page where you can view the data extracted for the event.</p> <p>From the History Summary page for F and M visas, the link takes you to the History Detail - F/M page.</p> <p>From the History Summary page for J visas, the link takes you to the History Detail - J page.</p>
File Error	<p>Appears only if an error is received from SEVIS.</p> <p>Click this link to view the error information generated during processing the event and received from SEVIS.</p>
Sent to	Displays the destination where the data was sent: <i>SEVIS</i> , <i>Master</i> , or <i>None</i> .
New Form	The system selects this check box if a new form was requested for the event

Viewing Event History Detail Information

If you ran the Process SEVIS Alerts - F/M process, access the History Detail - F/M page (**Campus Community > SEVIS > View SEVIS Events History > History Detail - F/M**).

If you ran the Process SEVIS Alerts - J process, access the History Detail - J page (**Campus Community > SEVIS > View SEVIS Events History > History Detail - J**).

You can view the data that was submitted for the event listed. The data varies depending on the event.

Consult the U.S. Immigrations and Customs Enforcement web site for a listing of data elements sent for each event.

See Reference Manual for the Student and Exchange Visitor Information System Batch Interface, Application Program Interface (API).

Field or Control	Description
More	<p>This link appears only for the F and M visas Create Student event.</p> <p>Click this link to access the Details page where you can view additional data extracted for the event.</p>
Addr Info (address information)	<p>This link appears for F and M visas for the Create Student, Edit Personal, and Student Registration events.</p> <p>This link appears for J visas Create EV, Personal Info and Validate events.</p> <p>Click this link to access the SEVIS Alerts Addresses page where you can view address data extracted for the event. For F and M visas, the data should include the foreign and U.S. addresses. For J visas, it should include only U.S. addresses.</p>

Viewing Event Process Details

Access the Process Detail page (**Campus Community > SEVIS > View SEVIS Events History > Process Detail**).

If the **Sent To** value on the History Summary page is *SEVIS*, and the SEVIS transaction log is processed for the event through the SEVIS Import Results process, you can view the results of the import on the Process Detail page.

Field or Control	Description
SEVIS School Code or SEVIS Program Number	The system displays either the SEVIS School Code and associated fields for F and M visas or the SEVIS Program Number and associated fields for J visas.
Extract Batch ID	<p>Displays the ID number provided in the upload extract file.</p> <p>This is a unique number for each extract created by the SEVIS Export process.</p>
Request ID	<p>Displays the identifier used by your school to define the specific record in the upload extract file.</p> <p>This is a unique number for each event created by the SEVIS Export process.</p>
SEVIS Process Date Time	Displays the date and time that the record was processed by SEVIS.
File Process Result/Error Code	If the event does not load to SEVIS successfully, this field shows the error code returned during the processing of the individual record.

Field or Control	Description
File Upload Status	<p>If the event loads to SEVIS successfully, this field value is <i>Successful</i>.</p> <p>If the event does not load to SEVIS successfully, this field value is <i>Unsuccessful</i>. You must correct the error and resubmit it to SEVIS. When you run the Process SEVIS Alerts process for that visa type, the system triggers the event again and sends it to the Select Alerts to Report component for review.</p>

Note: You must correct the data before the Process SEVIS Alerts process for that visa type runs again or you will send the event to SEVIS with the error.

Field or Control	Description
Remarks	If the event does not load to SEVIS successfully, this field provides a text description of the error code returned during the processing of the individual record.

Generating an XML File to Send to SEVIS

You must run an XML extract process to create the data files in the format that SEVIS requires.

Pages Used to Generate an XML File to Send to SEVIS

Page Name	Definition Name	Navigation	Usage
Export SEVIS Events - F/M	RUNCTL_SEV_EXTRACT	Campus Community > SEVIS > F/M Alerts > Export SEVIS Events - F/M	Generate the XML file of F and M visas data for transmission to SEVIS.
Export SEVIS Events - J	RUNCTL_SEV_EXT_J	Campus Community > SEVIS > J Alerts > Export SEVIS Events - J	Generate the XML file of J visas data for transmission to SEVIS.

Generating the XML File

Access the Export SEVIS Events - F/M page for F/M visas processing (**Campus Community** > **SEVIS** > **F/M Alerts** > **Export SEVIS Events - F/M**) or access the Export SEVIS Events - J page for J visas processing (**Campus Community** > **SEVIS** > **J Alerts** > **Export SEVIS Events - J**).

The SEVIS Export process includes two processes, the SEVIS Extract Process (CCSEVEXT for F and M visas or CCSEVEXJ for J visas) which creates the XML file to send to SEVIS, and the SEVIS Master

Sync Process (CCSEVSYF for F and M visas or CCSEVSYJ for J visas) which updates the SEVIS Master directly. Which process runs depends on the:

- visa type
- value in the **Send To** field on the Alerts Header page for that visa type
- selection that you make on the Process Scheduler Request page

To force the extract and Master Sync processes to run at the same time, select the **Export and Master Synch** option on the Process Scheduler Request page.

This example illustrates the fields and controls on the Example of the Process Scheduler Request page for the SEVIS Export process for F and M visas. You can find definitions for the fields and controls later on this page.

Process Scheduler Request

User ID: PS Run Control ID: PS

Server Name: PSNT Run Date: 07/29/2005 [BT]

Recurrence: Run Time: 4:56:55PM [Reset to Current Date/Time](#)

Time Zone: [Search Icon]

Select	Description	Process Name	Process Type	*Type	*Format	Distribution
<input checked="" type="checkbox"/>	Export and Master Synch - FM	CCSEVEMF	PSJob	(None)	(None)	Distribution
<input type="checkbox"/>	SEVIS Extract Process - FM	CCSEVEXT	SQR Report	Web	PDF	Distribution
<input type="checkbox"/>	SEVIS Master Synch - FM	CCSEVSYF	SQR Report	Web	PDF	Distribution

When the **Send To** field on the Alerts Header page is set to *Master* and you select the **SEVIS Master Synch** option for the visa type in PeopleSoft Process Scheduler, the process updates the SEVIS Master component directly. Events set to *Master* are not included in the XML file produced by the Master Sync process.

When the **Send To** field on the Alerts Header page is set to *SEVIS* and you select the **SEVIS Extract Process** option for the visa type, the process extracts data into an XML file that is compliant with the SEVIS Create - Update Student or Create EV schema and therefore ready to send to SEVIS. Only events set to *SEVIS* are included in the XML file produced by the extract process.

The extract process creates an XML file using a 30-character file name with the SEVIS extract batch ID and the SEVIS school code for F and M visas or the program code for J visas. For example, the XML filename for F and M visas might be 0000000005DAL21400078230.xml where the 0000000005 is the SEVIS extract batch ID and DAL21400078230 is the SEVIS school code. The XML filename for J visas might be 0000000005G-2-10128.xml where the 0000000005 is the SEVIS extract batch ID and G-2-10128 is the SEVIS program number.

Note: The SEVIS system currently accepts XML files with names no longer than 30 characters, including the .xml file extension. The XML file produced by the PeopleSoft SEVIS Export process does not display the first three characters of the extract batch ID.

The SEVIS extract batch ID value is recorded on the Installation Defaults - CC page. The extract process controls and sequentially numbers the extract batch ID value with each new run.

The PeopleSoft application delivers the SEVIS extract batch ID value set to 00000000000000 and the field is set to display-only on the Installation Defaults - CC page.

Warning! Exercise extreme care if you update the SEVIS extract batch ID value. The batch ID value is an important key to SEVIS batch XML documents. PeopleSoft Campus Solutions controls the SEVIS extract batch ID value. The SEVIS system no longer requires sequential batch ID numbering. However, the Batch ID submitted with each file must be unique.

Field or Control	Description
SEVIS School Code or SEVIS Program Number	<p>For F and M visas, enter the SEVIS school code for the data to be exported.</p> <p>For J visas, enter the SEVIS program number for the data to be exported.</p>
DSO EmplID (designated school official employee ID) or Responsible Officer	<p>For F and M visas, enter the ID of the assigned DSO for the data to export.</p> <p>For J visas, enter the ID of the assigned responsible officer (RO) or assistant responsible officer (ARO) of the data to export.</p> <p>This field is optional for either visa type and is used to limit the export file to only those individuals whose current form (I-20 or DS-2019) is associated with the specified responsible ID (DSO or RO/ARO). Depending on business processes, if your institution has multiple responsible IDs, you might find it useful to limit the XML data files to a specific ID. This can assist with the organization and review of transaction log results and forms received from SEVIS.</p>
File Path	Enter the path to the destination where you want the system to store the created export file.

Downloading and Viewing SEVIS Results

Before you can view results from SEVIS, you must complete the upload of the XML file to SEVIS, the download of the XML transaction log, and the download of PDF form files from SEVIS (I-20 PDF for F and M visas or DS-2019 PDF for J visas) using the utility program of your choice that supports SSL and HTTPS. Many utility programs (freeware, shareware, and licensed) support SSL and HTTPS data transmissions.

Consult the U.S. Immigrations and Customs Enforcement web site for digital certificate and batch file transmission instructions.

See [Reference Manual for the Student and Exchange Visitor Information System Batch Interface, Application Program Interface \(API\)](#).

After you send the XML file to SEVIS, you receive the upload results from SEVIS to verify that the information was received. You also receive the processed results of the data file and PDF format files for printing the forms.

Warning! The upload command must include an output statement for receiving the transaction log containing the upload results. If the upload is unsuccessful, the file needs to be loaded using SEVIS Import Results process for the visa type so that the SEVIS Master rows are deleted and the error can be corrected. The events appear on the Alerts Header page in the Select Alerts to Report component again after the Alerts process for the visa type runs.

The following is a sample of a cURL command asking for the upload results for F and M visas: `cURL -E seviscert2.pem:sevistest -F orgid=SEA214F00078000 -F batchid=12340000091540 -F userid=tpdso-4140 -F xml=@40000091540SEA214F00078000.xml https://egov.ice.gov/sbtsevisbatch/action/batchUpload -k -v -L -o batch91540.xml`

The following is a sample of a cURL command asking for the upload results for J visas: `cURL -E seviscert2.pem:sevistest -F orgid=G-2-10128 -F batchid=12340000091530 -F userid=kander6952 -F xml=@12340000091530G-2-10128.xml https://egov.ice.gov/sbtsevisbatch/action/batchUpload -k -v -o batch91530j.xml`

This section discusses how to:

- Download SEVIS import results.
- View results of the XML upload to SEVIS.
- View results of the SEVIS download.
- View individual student or exchange visitor record results.
- View individual dependent record results.
- View employment or Site of Activity record results.

Pages Used to Download and View SEVIS Results

Page Name	Definition Name	Navigation	Usage
Import Process	RUNCTL_SEV_DOWNLD	Campus Community > SEVIS > SEVIS Import > Import Process	Enter SEVIS Download process parameters to import the acknowledgement file and results file from SEVIS.
File Upload Result	SEV_UPLOAD_RSLT	Campus Community > SEVIS > SEVIS Import > Import Results > File Upload Results	Review the acknowledgement file.
Download Results	SEV_DOWNLD_RSLT	Campus Community > SEVIS > SEVIS Import > Import Results > Download Results	Review the transaction log results file.

Page Name	Definition Name	Navigation	Usage
Student/EV (student/exchange visitor)	SEV_DOWNLD_RSLT2	Campus Community > SEVIS > SEVIS Import > Import Results > Student/EV	Review the individual transaction record results for a student (F and M visa) or exchange visitor (J visa).
Dependents	SEV_DOWNLD_RSLT3	Campus Community > SEVIS > SEVIS Import > Import Results > Dependents	Review the individual transaction record results for a dependent.
Employment/SOA	SEV_DOWNLD_EMP	Campus Community, SEVIS, SEVIS Import, Import Results, Employment/SOA	Review the employment records for a student (F and M visa) or the Site of Activity address for an exchange visitor (J visa).

Downloading SEVIS Import Results

Access the Import Process page (**Campus Community > SEVIS > SEVIS Import > Import Process**).

The SEVIS Import Results process loads file acknowledgement and transaction log results obtained from SEVIS into the PeopleSoft Campus Solutions system.

Field or Control	Description
Single File	Select to load a single transaction log file.
File List Driven	Select to load multiple fields. To load multiple files, you must create a document (for example, .txt) that lists all of the file acknowledgement and transaction log files that you want to load.

This graphic provides a visual example of the file list produces for the File List Driven option.

Example of a file list for the File List Driven option

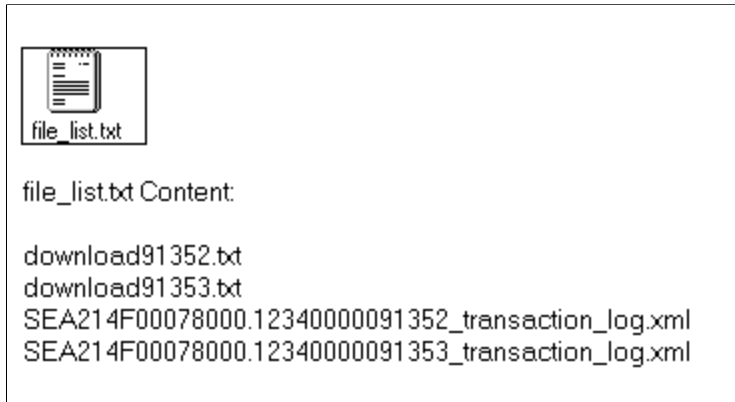

<i>Field or Control</i>	<i>Description</i>
File Name	Enter the file name using the file naming convention approved by SEVIS.
File Path	Enter the path to the file location.

Viewing Results of the XML Upload to SEVIS

Access the File Upload Result page (**Campus Community > SEVIS > SEVIS Import > Import Results > File Upload Results**).

This page reflects the SEVIS upload results status of the overall batch file from the XML document upload. The information is based on results provided in the file acknowledgement returned by SEVIS.

Note: You must run the SEVIS Import Results process for the visa type to load information from the upload results file produced as a result of uploading the XML file to SEVIS.

This example illustrates the fields and controls on the Example of upload results. You can find definitions for the fields and controls later on this page.

```
<?xml version="1.0" encoding="UTF-8" ?>
- <TransactionLog>
  - <BatchHeader>
    <BatchID>12340000091538</BatchID>
    <OrgID>SEA214F00078000</OrgID>
  </BatchHeader>
  - <BatchDetail status="true" system="ALPHA">
    <Upload resultCode="S0000" dateTimeStamp="2005-05-17T16:03:40.421-04:00" />
  </BatchDetail>
</TransactionLog>
```

Field or Control	Description
SEVIS School Code or SEVIS Program Number	The page appears with the SEVIS School Code field displayed for F and M visas, or the SEVIS Program Number field displayed for J visas.
File Processing Status	<p>Displays the status of the file from SEVIS. The possible status values are <i>Exported</i>, <i>Upload Acknowledged</i>, <i>Transaction Log Downloaded</i>, or <i>Processing Complete</i>.</p> <p>Each time the SEVIS export process for a visa type runs, a new row with the extract batch ID and either SEVIS school code for F and M visas or the SEVIS program number for J visas appears with the exported file processing status.</p> <p>After you load the file acknowledgement log from SEVIS, the status changes to <i>Upload Acknowledged</i>.</p> <p>After you load the transaction log from SEVIS, the status changes to <i>Processing Complete</i>.</p>
System	Displays the SEVIS batch system from which the transaction log was requested. Values include <i>PROD</i> , <i>ALPHA</i> , or <i>BATCH</i> .
File Upload Date Time	Displays the date and time that the upload request was processed by SEVIS.
File Upload Result/Error Code	<p>If the file processing is unsuccessful, the file upload error from SEVIS appears. This can be any number of explanations of the error from the File Errors Setup Table. One example is <i>File does not comply with SEVIS XML Schema</i>.</p> <p>You should correct all errors before running the SEVIS Alerts process for that visa type again.</p>
File Accepted	<p>Indicates whether SEVIS accepted the file for processing.</p> <p>This value is not sent with the transaction log, but remains on the page for historical reference.</p>
Download Result/Error Code	<p>If the file download was unsuccessful, the download error from SEVIS appears. The code and description are based on the SEVIS File Errors table.</p> <p>You should correct all errors before running the SEVIS Alerts process for the visa type again.</p>

Viewing Results of the SEVIS Download

Access the Download Results page (**Campus Community > SEVIS > SEVIS Import > Import Results > Download Results**).

This page shows the status of the batch XML document processed by the SEVIS system. The information is based on results provided in the transaction log returned by SEVIS after the file is accepted and processed.

Field or Control	Description
SEVIS School Code or SEVIS Program Number	The page appears with the SEVIS School Code field displayed for F and M visas, or the SEVIS Program Number field displayed for J visas.
File Upload Status	Displays the <i>Successful</i> or <i>Unsuccessful</i> file status returned from the SEVIS system.
File Process Result/Upload Error Code	If the file upload is unsuccessful, the file upload error from SEVIS appears here.
File Validation Status	Displays the <i>Pass</i> or <i>No Pass</i> status of the file schema validation performed by the SEVIS system before transaction records are processed. The value is not included in the transaction log, but remains on the page for historical reference.
Records Requested for Process	Displays the number of unique records included in the XML document to be processed.
Records Successfully Processed	Displays the number of records successfully processed by the SEVIS system.
Records Failed Validation	Displays the number of records unsuccessfully processed by the SEVIS system.

File Validation Errors

Field or Control	Description
File Validation Error	If the file validation fails, the file validation error code from SEVIS appears here. You should correct all errors before running the SEVIS Alerts process for the visa type again.
Remarks	Displays the SEVIS file validation error description.

Viewing Individual Student or Exchange Visitor Record Results

Access the Student/EV page (**Campus Community > SEVIS > SEVIS Import > Import Results > Student/EV**).

This page shows the results of an individual student or exchange visitor transaction record. The information is based on results provided in the transaction log returned by SEVIS.

Field or Control	Description
SEVIS School Code or SEVIS Program Number	The page appears with the SEVIS School Code field displayed for F and M visas, or the SEVIS Program Number field displayed for J visas.

Students/Exchange Visitors

Field or Control	Description
ID	Displays the ID assigned to the individual in the PeopleSoft system.
SEVIS ID	Displays the ID assigned to the individual by the SEVIS system. For new students or exchange visitors submitted to SEVIS using the Create Student or Create EV event, the SEVIS ID is returned only if the record is successfully processed by the SEVIS system.
School Official or Responsible Officer	Displays the PeopleSoft ID and name of the school official the for F and M visas or the responsible officer for J visas that is assigned to the event. If an error is encountered when updating SEVIS Master, this field displays <i>Master Record Error</i> .
SEVIS Process Date Time	Displays the date and time that the XML file was processed by SEVIS.
File Process Result/Upload Error Code	If the file upload is unsuccessful, the file upload error from SEVIS appears here. You should correct all errors before running the Process SEVIS Alerts process for that visa type again.
Remarks	Displays the SEVIS file process error description.

Viewing Individual Dependent Record Results

Access the Dependents page (**Campus Community > SEVIS > SEVIS Import > Import Results > Dependents**).

This page shows the results of an individual dependent transaction record. The information is based on results provided in the transaction log returned by SEVIS.

<i>Field or Control</i>	<i>Description</i>
SEVIS School Code or SEVIS Program Number	The page appears with the SEVIS School Code field displayed for F and M visas, or the SEVIS Program Number field displayed for J visas.

Students/Exchange Visitors

<i>Field or Control</i>	<i>Description</i>
ID	The system displays the PeopleSoft ID for the student or exchange visitor.

Dependents

<i>Field or Control</i>	<i>Description</i>
Dependent ID	Displays the ID assigned to the dependent in the PeopleSoft system.
Dependent SEVIS ID	Displays the ID assigned to the dependent by the SEVIS system. For new dependents submitted to SEVIS using the Create Student event, Create EV event, or Dependent - Add event, the SEVIS ID is returned only if the record is successfully processed by the SEVIS system.
File Upload Status	Indicates whether the record was processed successfully. This value is not used in the transaction log, but remains on the page for historical reference.

Field or Control	Description
File Process Result/Error Code	<p>If the file upload is unsuccessful, the file upload error from SEVIS appears here.</p> <p>You should correct all errors before running the Process SEVIS Alerts - F/M or Process SEVIS Alerts - J process for that visa type again.</p>
Remarks	<p>Displays the SEVIS file process error description.</p> <p>This value is not used in the transaction log, but remains on the page for historical reference.</p>

Viewing Employment or Site of Activity Record Results

Access the Employment/SOA page (**Campus Community > SEVIS > SEVIS Import > Import Results > Employment/SOA**).

This page shows the results of an individual student or exchange visitor transaction record. The information is based on results provided in the transaction log returned by SEVIS.

Field or Control	Description
SEVIS School Code or SEVIS Program Number	The page appears with the SEVIS School Code field displayed for F and M visas, or the SEVIS Program Number field displayed for J visas.

Address Details

Field or Control	Description
Site of Activity and Site ID	Read-only. This appears only for exchange visitors (J visas).
Employer Name and Start Date	Read-only. This appears only for students (F and M visas).

Understanding the 3Cs — Communications, Checklists, and Comments

Understanding Communications, Checklists, and Comments

This section provides an overview of the 3Cs — communications, checklists, and comments and lists common elements.

The 3Cs — communications, checklists, and comments — are a flexible way to track and analyze correspondence, lists of requirements, and notes about the students, staff, constituents, and organizations in your database.

Communication management enables you to fully manage all types of contacts inside and outside your institution. Checklist management enables you to create lists of requirements and monitor their status. Comments creation enables you to attach notable remarks about individuals and organizations.

You can enter communications, checklists, and comments manually throughout your system, or, using the 3C engine, you can define events and triggers to have the system add communications, add comments, and add or update checklists for individuals or organizations automatically from within your business processes. You can also use the Population Selection process to select a specific population for the 3C engine to assign items to.



Each of the 3Cs requires an administrative function and a 3C update/inquiry group.

The administrative function identifies the variable data associated with the specific category of communication, checklist, or comment. For example, the administrative function of ADMA, for Admissions [Application Level] identifies the Academic Career, Student Career Number, Application Number, and Application Program Number.

The 3C update/inquiry group provides user-level security access to categories of communications, checklists, and comments, while providing or restricting the user's ability to edit the data. For example, a security administrator might give a specific user 3C update/inquiry group security access to items in the Notice of Dismissal communication category, with an update only status so that he or she can view the data but cannot modify it.

Buttons appear on many pages in the system to enable you to transfer directly from that page to another page within the same administrative function, to generate or review a communication, checklist, or comment for the individual or organization whose information you are currently viewing.

Common Elements Used in The 3Cs Documentation

<i>Field or Control</i>	<i>Description</i>
 (communications)	Transfers you to the appropriate Communications Management page, where you can review or create communications for the individual or organization. Communications include letters, phone calls, meetings, emails, and faxes.
 (checklists)	Transfers you to the appropriate Checklists Management page, where you can review or create checklists for the individual or organization. Checklists may be lists of steps that must be performed, or documents that must be provided, or communications that are planned to occur, and so on.
 (comments)	Transfers you to the appropriate Comments page, where you can review or enter comments about the individual or organization.

Related Links

[Reviewing Communications](#)

[Reviewing Comments](#)

[Reviewing Checklists for Individuals](#)

[Reviewing Administrative Functions](#)

[“Setting Up 3C Group Security” \(Campus Solutions Application Fundamentals\)](#)

[Using the Population Selection Process](#)

[Understanding the 3C Engine](#)

[“Processing Mass Changes” \(Campus Solutions Application Fundamentals\)](#)

Using the Population Selection Process

Understanding the Population Selection Group Box

A standard group box appears on run control pages for processes that use the Population Selection process to select the IDs to process. The Population Selection process may be required for some processes (for example, the Mass Assign Service Indicators process) but optional for others (for example, the 3C Engine process). The Population Selection Context Definition for a process controls whether the Population Selection process is available and if is required or optional.

If your institution defines a context definition that makes the Population Selection process available, the run control page for that process includes a standardized **Population Selection** group box. If the Population Selection process is available but optional, the run control page includes a check box that users can either select or clear to enable or disable the use of the Population Selection process. Depending on the page design, the check box, if it appears, might or might not be within the standard group box.

For the Mass Assign Service Indicators process, which is used in this section as an example of a process configured to use population selection, the group box appears at the top of the run control page. Because population selection is mandatory, the check box does not appear.

This section discusses the fields, links, and buttons that behave the same in the standard population selection group box wherever it appears on run control pages throughout PeopleSoft Campus Solutions. The values and parameters that you enter are specific to the application process. Consult the appropriate PeopleSoft documentation for information about using population selection for a specific application process.

This table lists the application processes that, as of the date of this publication, are configured to use the Population Selection utility.

<i>Application Process</i>	<i>Reference</i>
Audience Criteria	See “Setting Up Audience Criteria” (Contributor Relations).
Advisement Report	See “Producing an Online Academic Advisement Transcript Report” (Academic Advisement).
Application Delete by Batch	See “Selecting a Group of Applications to Delete” (Recruiting and Admissions).
Prospect Delete by Batch	See “Selecting a Group of Prospect Records to Delete” (Recruiting and Admissions).
3C Engine	See Running the 3C Engine Process .

<i>Application Process</i>	<i>Reference</i>
Mass User Security Replacement	See “Replacing User Security for Multiple Individuals” (Campus Solutions Application Fundamentals).
Population Update	See Running the Population Update Process .
Process Student Groups	See Running the Student Group Process .
Service Indicator Person Mass Assign and Service Indicator Organization Mass Assign	See Mass Assigning Service Indicators .
Service Indicator Person Mass Release and Service Indicator Organization Mass Release	See Mass Releasing Service Indicators .
Aid Year Activate	See “Activating an Aid Year for a Student” (Financial Aid).
Mass Packaging Select	See “Performing Mass Packaging Using Application Data” (Financial Aid).
Select Students for Need Summary Validation	See “Selecting Students for Need Summary Validation” (Financial Aid).
Select Students for Repackaging	See “Selecting Students for Repackaging” (Financial Aid).
Process Satisfactory Academic Progress (SAP)	See “Running the SAP Batch Process” (Financial Aid).
SF External Award Feed	See “Receiving Student Financials Payments as External Awards” (Financial Aid).
Mass Contract Select	See “Processing Mass Contract Assignments” (Student Financials).
Process Transcripts and Batch Transcript Request	See “Processing Batch Transcripts (Application Engine)” (Student Records).
Process User Edit Messages	See “Assigning User Edit Messages in Batch” (Financial Aid).
Ability to Benefit	See “Managing Ability to Benefit” (Financial Aid).
NSLDS Request	See “Generating Financial Aid History or Transfer Student Monitoring Inform File Requests” (Financial Aid).
NSLDS Data Push	See “Using the NSLDS Data Push Process” (Financial Aid).

<i>Application Process</i>	<i>Reference</i>
Mass Select Transactions	See Understanding the Population Selection Group Box .
Mass Assign Student Waivers	See “Assigning Waivers for Multiple Students” (Student Financials).
Create Project Records	See “Creating Student Academic Projects in Batch” (Student Records).
Create and Maintain Evaluations	See Processing Evaluations in Batch .
CR Workset Build	See “Working with Worksets” (Contributor Relations).
Process Loan Dates	See “Updating Loan Dates” (Financial Aid).
Pell Payment Origination	See “Creating Pell Origination Records” (Financial Aid).
Loan Origination	See “Originating Direct Loans and Viewing Loan Status Summary Information” (Financial Aid).

Using the Population Selection Process

This section lists the pages used for implementing the population selection process and provides an example.

Pages Used for the Population Selection Process

Note: You access the pages listed here from the standard **Population Selection** group box, wherever it exists in the database. You will use other pages depending on the values and parameters that you enter for a specific process. Those pages are documented where the specific run control page for that business process is documented.

Page Name	Definition Name	Navigation	Usage
Equation Editor	EQUATION_EDITOR	Click the Create Equation or Edit Equation link in the Population Selection group box on a run control page when the selection tool is <i>Equation Engine</i> . The Create Equation and Edit Equation links only appear if the user has appropriate security for creating or editing equations and the selection tool is Equation Engine.	Create a new equation or edit the selected equation to use for a process.
Equation Parameters	SCC_EQTN_POP_PARM	Click the Edit Prompts link in the Population Selection group box on a run control page when the selection tool is <i>Equation Engine</i> . The Edit Prompts link appears only if the equation is set to use prompts.	View or enter prompts for an equation. See “Preparing to Write Equations” (Campus Solutions Application Fundamentals).
Query Manager	QRY_SELECT	Click the Launch Query Manager link in the Population Selection group box on a run control page when the tool is PS Query. Reporting Tools > Query Manager	If you have security access to Query Manager, create a new query or edit the selected query to use for a process.
Preview Selection Results	SCCPS_RESULTS	Click the Preview Selection Results link in the Population Selection group box on a run control page. The Preview Selection Results link appears only if preview functionality is enabled on the Selection Tool page for the tool selected.	Preview the results that will be returned by the tool.
Population Selection File Mapping	SCCFP_PS_FILE	Set Up SACR > System Administration > Utilities > File Parser > Population Selection File Map Click the Create File Mapping link or Edit File Mapping link in the Population Selection group box on a run control page when the tool is external file.	Create or edit a mapping for an external file for use by the Population Selection process.

Example: Using Population Selection

Access the run control page for the specific process, for example, the Mass Assign service indicators process (**Campus Community > Service Indicators > Person > Mass Assign**).

This example illustrates the fields and controls on the Example of the standard Population Selection group box on a Campus Solutions page. You can find definitions for the fields and controls later on this page.

Mass Assign

Run Control ID: PS [Report Manager](#) [Process Monitor](#) Run

Population Selection

Selection Tool
Query Name

Service Indicator Data

***Institution**
***Service Indicator Code**
Reason

Effective Period

Start Term **End Term**
Start Date **End Date**

Assignment Details

***Department:**
Reference:
Amount **Currency Code:** Dollar

Contact Information

Contact ID: **Contact Person:**
Placed Person ID: **Placed By:**

Comments

Population Selection

<i>Field or Control</i>	<i>Description</i>
Selection Tool	<p>Select the tool to use to identify the population for the process.</p> <p>Only tools set to <i>Active</i> on the Selection Tool setup page and the applicable selection tools defined in the context definition for the process are available in this drop-down list box.</p> <p>The PeopleSoft system delivers the following tools with a default status of <i>Active</i>: <i>Equation Engine</i>, <i>External File</i>, and <i>PS Query</i>. If your institution creates other tools, sets them to active status, and lists them in the context definition for a specific process, then they also will be available in this drop-down list box.</p> <p>Fields and links appear on the subpage based on the tool that you select.</p>

Equation Engine Tool

This section describes the fields and links that appear when you select the *Equation Engine* tool in the **Population Selection** group box on a page.

This example illustrates the fields and controls on the Example of the Population Selection group box with the Equation Engine tool selected. You can find definitions for the fields and controls later on this page.

Mass Assign

Run Control ID: PS [Report Manager](#) [Process Monitor](#)

Population Selection

Selection Tool	<input type="text" value="Equation Engine"/>	<input type="button" value="Edit Prompts"/>
Equation Name	<input type="text" value="CCSIPSEMO02"/>	<input type="button" value="Edit Equation"/> <input type="button" value="Preview Selection Results"/>

When you select the *Equation Engine* tool, if you have the appropriate security for creating equations a **Create Equation** link appears next to the **Equation Name** field. If you must create an equation, you can click this link to launch Equation Editor in a separate window, where you can create the equation, save it, and then enter the equation name in the **Equation Name** field without exiting the page that contains the **Population Selection** group box.

If you have the appropriate security to create and edit equations, when you enter an equation name the **Create Equation** link will change to the **Edit Equation** link. You can click the **Edit Equation** link to open the Equation Editor page for that equation and edit it.

Note: If you save the page with an equation name entered in the **Population Selection** group box and you subsequently edit and save that equation in Equation Editor, then you do not have to save the page that contains the group box again to benefit from changes to the equation.

Field or Control	Description
Selection Tool	Displays the type of tool that you selected. In this example, <i>Equation Engine</i> was selected.
Equation Name	<p>Select the equation to use.</p> <p>Only equations valid for the specific process are available. Limiting the prompt list to valid equations ensures that users select IDs with the appropriate data needed for running the process. Valid equations include the application prompt name that is set on the Equation To Context Mapping page.</p> <p>The PeopleSoft system delivers predefined equations for specific processes. A list of equations delivered as of the date of this publication is provided as an appendix to this documentation.</p> <p>See Equations for Population Selection.</p>
Create Equation	<p>This link appears only if you have security access to create new equations and if no equation name is entered.</p> <p>Click this link to launch Equation Editor in a new window, where you can create a new equation.</p> <hr/> <p>Warning! Never modify and save a delivered equation using the original equation name. The PeopleSoft system delivers predefined equations upon which specific processes depend. If you want to create a different version of a delivered equation, save it using a different name and then modify it.</p> <hr/>
Edit Prompts	<p>This link appears after you enter the equation name and only if the equation that you selected is set to use prompts.</p> <p>Click this link to access the Equation Parameters page, where you can view or enter prompts for the equation.</p>
Edit Equation	<p>This link appears only if you have appropriate security for editing existing equations.</p> <p>Click this link to launch Equation Editor in a new window, where you can view and edit the specified equation.</p>

Field or Control	Description
Preview Selection Results	<p>This link appears only if the Enable Preview Results check box is selected on the Selection Tool page for the Equation Engine.</p> <p>Click this link to preview results based on the parameters that you selected before you run the process.</p>

PS Query Tool

This section describes the fields and links that appear when you select the *PS Query* tool in the **Population Selection** group box on a page.

This example illustrates the fields and controls on the Example of the Population Selection group box with the PS Query tool selected. You can find definitions for the fields and controls later on this page.

Field or Control	Description
Selection Tool	Displays the type of tool you selected. In this example, the <i>PS Query</i> tool was selected.
Query Name	<p>Select the query to use.</p> <p>Only queries valid for the specific process are available. Limiting the prompt list to valid queries ensures that users select IDs with the appropriate data needed for running the process. Valid queries use a data source record listed in the context definition.</p> <p>The PeopleSoft system delivers predefined equations for specific processes. A list of equations delivered as of the date of this publication is provided as an appendix in this documentation.</p>

Field or Control	Description
Edit Prompts	<p>This link appears after you enter the query name and only if the query that you selected is set to use prompts.</p> <p>Click this link to access the Query Prompts page, where you can view or enter prompts for the specified query.</p> <p>See Creating Valid PeopleSoft Queries and Application Classes.</p>
Launch Query Manager	<p>This link appears only if you have the appropriate security for accessing the Query Manager component.</p> <p>Click this link to launch Query Manager in a separate window, where you can create or update a query without exiting the Population Selection subpage.</p> <hr/> <p>Warning! Never modify and save a delivered query using the original query name. The PeopleSoft system delivers predefined queries upon which specific processes depend. If you want to create a different version of a delivered query, save it using a different name and then modify it.</p> <hr/> <p>See <i>PeopleTools: Query</i></p>
Preview Selection Results	<p>This link appears only if the Enable Preview Results check box is selected on the Selection Tool page for the PS Query tool.</p> <p>Click this link to preview results based on the parameters that you selected before you run the process.</p>

External File Tool

This section describes the fields and links that appear when you select the *External File* tool in the **Population Selection** group box on a page.

This example illustrates the fields and controls on the Example of the Population Selection group box with the External File tool selected. You can find definitions for the fields and controls later on this page.

Mass Assign

Run Control ID: PS [Report Manager](#) [Process Monitor](#) Run

Population Selection

Selection Tool External File Upload File Delete File View File

Attached File SCC_POP_SI_ACADRECRUIT.csv

File Mapping TEST_SI [Create File Mapping](#)

Depending on how your institution sets up the external file tool for population selection, you will be required to upload a file as an attachment or you will be required to provide a path to a file. If you upload a file as an attachment, your system will be set up to locate the attachment where the application server and Process Scheduler can access it. If you provide a path, you must be sure to provide a path that the server and Process Scheduler can access.

The example used in this section requires an uploaded file to attach.

Field or Control	Description
Selection Tool	Displays the type of tool selected. In this example, <i>External File</i> was selected.
Upload File	<p>This button appears only after you select the <i>External File</i> tool.</p> <p>Click to browse to an existing file to upload. The file can be stored anywhere; however, it must be either a delimited file or a flat (fixed length) file that is compatible with PeopleSoft File Parser.</p> <hr/> <p>Note: Proprietary file formats such as Microsoft Excel, Microsoft Word, and Lotus Software's Lotus 1-2-3 are not supported by File Parser. An Excel spreadsheet, for example, would need to be saved as a comma separated value (.csv) file format.</p> <hr/> <p>When you upload a file, the system places the file in a path accessible to the applications server and Process Scheduler, and attaches the file to the process.</p> <p>See Understanding the File Parser Process.</p>
Attached File	Displays the name of the uploaded and attached file.

Field or Control	Description
Delete File and View File	<p>These buttons appear only after you upload a file.</p> <p>Click View File to view the uploaded file and verify that its contents are mapped correctly for parsing.</p> <p>Click Delete File to delete the uploaded file from the attachment path.</p>
Create File Mapping	<p>Click to access the Population Selection File Mapping page, where you can map the uploaded file for use with the Population Selection process.</p>
Edit File Mapping	<p>This link appears only after you upload a file and create or select the file mapping.</p> <p>Click to access the Population Selection File Mapping page, where you can view or edit the mapping created for the uploaded file.</p>
Preview Selection Results	<p>This link appears only if the Enable Preview Results check box is selected on the Selection Tool page for the External File tool.</p> <p>Click this link to preview results based on the parameters that you selected before you run the process.</p> <hr/> <p>Warning! When using an external file selection tool, always preview the results to verify that the contents of your file are mapped correctly for parsing. If you don't verify the mapping, you could have misplaced columns—for example, the column labelled Institution could contain values for the names of the IDs.</p> <hr/>

External File Mapping

This section shows a completed Population Selection File Map page.

This example illustrates the fields and controls on the Example of the Population Selection File Map page. You can find definitions for the fields and controls later on this page.

Population Selection File Map

File Mapping Definition

*File Mapping: Public [Created/Updated History](#)

*Required Flds:

*File Type: Field Delimiter: Field Qualifier:

Header Row Header Row Number:

Field Mapping Customize | Find | First 1-5 of 5 Last

Mapping

Field Name	Required	Field Number
1 ACAD_CAREER	No	<input type="text"/>
2 NAME	No	<input type="text"/>
3 EMPLID	Yes	<input type="text" value="1"/>
4 INSTITUTION	Yes	<input type="text" value="2"/>
5 AID_YEAR	Yes	<input type="text" value="3"/>

Running the Population Update Process

This section provides an overview of the Population Update process and discusses how to set parameters for running the process.

Understanding the Population Update Process

Population Update is a process that uses the Population Selection utility to update values in selected fields. Your institution or department must choose the records and fields to make available for update and set user security to identify which users can update the records. The user selects the records and fields to update on the Population Selection Update run control page.

Each record that can be updated by the process has a query to use for population selection. This query is joined with other records to determine the population that you want to update when you use the PS Query selection tool.

The application records that are configured to use the Population Update process are:

Record/Table	Description	Additional Information
ADM_APPL_DATA	Admission Application Data	Optional Batch Enterprise Integration Point (EIP) for this record.
ADM_APPL_RCR_CA	Admission Application Recruitment Category	Optional Batch Enterprise Integration Point (EIP) for this record.
ADM_PRSPCT_CAR	Admission Prospect Career	Optional Batch Enterprise Integration Point (EIP) for this record.

Record/Table	Description	Additional Information
INAS_CALC_RECS	Records needing INAS Calculations	Hardcoded value "P" for Protection Reason.
INAS_FED_EXT	Federal Overrides for INAS	See the "Using Population Selection Results to Populate Population Update Fields" section in this topic.
INAS_PROF_EXT	Profile Overrides for INAS	See the "Using Population Selection Results to Populate Population Update Fields" section in this topic.
ISIR_CONTROL	ISIR Internals/Control Data	For this record, you can update the existing effective dated row or insert a new effective dated row.
ITEM_TYPE_FISCL	Fiscal Item Type Table	SetID, Item Type, and Aid Year are required fields. If any of the Budgeted fields are populated by Population Update, then "Audit Process Type" will reflect "Population Update". Population Update does not perform any inserts into the Fiscal Item Type table, only updates, to existing Item Types. See the "Using Population Selection Results to Populate Population Update Fields" section in this topic.
ITEM_TYPE_FNOTE	Fiscal Item Type Notes Table	SetID, Item Type, and Aid Year are required fields. Population Update does not perform any inserts into the Fiscal Item Type Comments table; only updates to existing Item Types.
LOAN_DISBMNT	Loan Disbursement	See the "Using Population Selection Results to Populate Population Update Fields" section in this topic.
LOAN_ORIGNATN	Loan Origination	Logic to update Borrower Citizenship Status for Grad PLUS, Subsidized, and Unsubsidized Loans. Override Academic Year Start and Override Academic Year End = Y/N Loan Refund Indicator = Student, Borrower
LOAN_ORIG_DTL	Loan Origination Detail	Hold/UnHold logic, custom translates. Logic to update Borrower Citizenship Status for Grad PLUS, Subsidized, and Unsubsidized Loans.
PELL_DISBMNT	Pell Disbursement	
PELL_ORIGINATN	Pell Origination	

Record/Table	Description	Additional Information
PELL_ORIG_DTL	Pell Origination Detail	The date fields associated with Pell Origination Status and Pell Trans Status are also updated with the system date. Corresponding update to Student Aid Attribute.
PERS_INST_REL	Person Relationships with Institution	
RESIDENCY_OFF	Official Residency Data	EMPLID, Academic Career, Institution, Effective Term are required fields. Population Update does not perform any inserts, only updates, to existing entries.
SCC_PERSON_AUS	TFN Verified	Populate the TFN Verified check box for selected students.
SFA_ASG_ORG_DTL	ACG/SMART Origination Detail	
SFA_EASTAGE_DTL	External Award Staging detail record	Custom translate for processing status.
SFA_LN_CNLS_TBL	Loan Counseling Information	Counseling Requirement: Required Annually, Required Once. Status: Completed, Incomplete, Pending. Comment: limited to 25 characters. Population Update does not perform any inserts into the Loan Counseling table, only updates, to existing Loan Counseling rows.
SFA_SAP_STDNT2	SAP Student Career Exceptions	Operator ID of the person running update and date/time stamp of the process. Validation of EMPLIDs selected for Population Update process.
SFA_SAP_STDNT3	SAP Student Term Exceptions	Operator ID of the person running update and date/time stamp of the process. Validation of EMPLIDs selected for Population Update process.
SFA_SAP_STDNT4	SAP Student Aid Year Exception	Operator ID of the person running update and date/time stamp of the process. Validation of EMPLIDs selected for Population Update process.
SFA_SLC_STUDENT	SLC Student Data Table	

Record/Table	Description	Additional Information
SSR_STDNT_DATA	Student Data AUS	CHESSN Data - Student Consent values
STDNT_AGGR_LIFE	Student Lifetime Aggregate Awards	<p>When the NSLDS Total (amount) field is updated, Population Update sets the Override check box, the Operator ID displays SCC_POP_UPD, and date/time stamp of the process is captured.</p> <p>Similarly, you have the option of only selecting (or de-selecting) the Override check box itself through Population Update without populating the NSLDS Total (amount) field. When you select the Override check box, the Operator ID displays SCC_POP_UPD along with the corresponding date/timestamp. When you de-select the Override check box, the Population Update routine removes the SCC_POP_UPD Operator ID.</p> <p>EMPLID and AGGREGATE_AREA are required fields</p>
STDNT_AID_ATRBT	Packaging Status Summary	
STDNT_AWARDS	Student Awards	
STDNT_AWRD_PER	Student Award Period Table	<p>FAN Ltr Status: Hold, Initial, Printed, Revised</p> <p>EMPLID, Institution, and Aid Year are required fields</p>
STDNT_CAREER	Student Career	The date field associated with the Synchronize Advisement Report is also updated with the system date.
STDNT_CAR_TERM	Student Career Term	
STDNT_EQUTN_VAR	Student Equation Variables	
STDNT_FA_TERM	Student FA Term	<p>Update of Override fields related to update of FA Load, NSLDS Loan Year, and Direct Lending Year.</p> <p>Validation of entered FA load value.</p> <p>For this record, you can update the existing effective dated row or insert a new effective dated row.</p> <p>See the “Using Population Selection Results to Populate Population Update Fields” section in this topic.</p>
STDNT_PKG_VAR	Student Packaging Variables	See the “Using Population Selection Results to Populate Population Update Fields” section in this topic.

Using Population Selection Results to Populate Population Update Fields

The following subset of records/tables can have their fields updated from Population Selection results. The relevant bind record for use with PS Query is also listed:

Record/Table	Bind Record for PS Query
INAS_FED_EXT	SFA_PU_INSF_BND
INAS_PROF_EXT	SFA_PU_INSP_BND
ITEM_TYPE_FISCL	SSF_PU_IFSC_BND
LOAN_DISBMNT	SFA_PU_LDSB_BND
PELL_DISBMNT	SFA_PU_PDSB_BND
STDNT_FA_TERM	SFA_PU_FTRM_BND
STDNT_PKG_VAR	SFA_PU_SPKG_BND

To do this, fields being included in the Population Selection must have field names that match the field names on the target record in order to update the fields. For example, if you want to update the 'CIP_CODE' field on LOAN_DISBMNT, the selection should include field name 'CIP_CODE'. If you had the field name as 'CIPCODE' in a PS Query, the Population Update process would not pick up the values in that field from Population Selection as values to update the target record.

You can use data from Population Selection alone, enter **Field Names** and **Field Values** on the **Select Fields to Update** grid of the Population Update run control page alone, or use a combination of both options. However, if you include the same field in Population Selection and in the **Select Fields to Update** grid, the **Field Value** entered in the grid overrides the values included in Population Selection. For example, if the Population Selection includes the SFA_SULA_LOAD field in an External File with one or various values and then the **Select Fields to Update** grid includes SFA_SULA_Load field with a set value, all of the records included in the Population Selection will have SFA_SULA_LOAD updated with the set **Field Value** from the **Select Fields to Update** grid.

Note: When this process adds a new row, any data that was previously saved for the student is overridden.

Related Links

“Securing and Setting Up the Population Update Process” (Campus Solutions Application Fundamentals)
[Using the Population Selection Process](#)

Page Used to Run the Population Update Process

Page Name	Definition Name	Navigation	Usage
Population Selection Update	SCC_RUNCTL_POP_UPD	Set Up SACR > System Administration > Utilities > Population Update > Population Update Process > Population Selection Update	Set parameters for running the Population Update process.

Selecting the Update Parameters

Access the Population Selection Update page (**Set Up SACR > System Administration > Utilities > Population Update > Population Update Process > Population Selection Update**).

This example illustrates the fields and controls on the Population Selection Update page. You can find definitions for the fields and controls later on this page.

Population Selection Update

Run Control ID: PU1 Report Manager Process Monitor [Run](#)

Select Record fields for update Find | View All First 1 of 1 Last

*Record (Table) Name + -

Institution PeopleSoft University

Error Reporting Selection

Report Error Messages Do Not Report Messages Report All Messages

Population Selection

Selection Tool + -

Query Name Launch Query Manager Preview Selection Results

Select Fields to Update Personalize | Find | View All | 1-2 of 2 | Last

Field Name	Field Value	Date	
Completed Date			+ -
Application Complete	Y		+ -

Select Attributes to Update Personalize | Find | View All | 1-5 of 8 | Last

Attribute Sequence	*Common Attribute	Description	Text - 20	LOV	Description	
1	SCC_TEST_DATE	Test Date Attribute				+ -
2	SCC_TEST_LOV	Test LOV Attribute	GLAKE			+ -
3	SCC_TEST_LTXT	Test Long Text Attribute				+ -
4	SCC_TEST_NUM	Test Number Attribute				+ -
5	SCC_TEST_STXT	Test Short Text Attribute	New short text			+ -

Select Record/Field for Update

<i>Field or Control</i>	<i>Description</i>
Record (Table) Name	<p>Select the name of the record to update.</p> <p>Only the records to which you have security access and that your institution or department has made available for updating are available values.</p> <p>Multiple tables can be updated on one run control. A table can be referenced only once per run control because the table is a key field for the process.</p> <p>When you enter the Record (Table) Name, the fields that are available for update become available for selection.</p>
Institution and Aid Year	<p>Enter the Institution and Aid Year. When you enter the record name, the system displays the key fields for that record so that you can specify the exact rows to update in the table.</p> <p>For example, for Financial Aid records, the Institution and Aid Year fields appear.</p>

Error Reporting Selection

You can choose to have the process display error messages only or all of the messages that it encounters during the update, or you can choose not to display any of the messages. Displaying at least the error messages gives you an opportunity to decide whether to investigate and resolve the problems.

Population Selection

Fields and links in this group box behave as in the standard Population Selection group box throughout Campus Solutions.

See [Understanding the Population Selection Group Box](#).

<i>Field or Control</i>	<i>Description</i>
Selection Tool	<p>Select the Selection Tool that your institution uses to select the population to update: <i>PS Query</i>, <i>Equation Engine</i>, or <i>External File</i>.</p>
Query Name, Equation Name, or File Name	<p>Enter the name of the query, equation, or file that you use to select the population that you want to update.</p> <p>For PS Query, the list of available queries is determined by Record (Table) Name selected for update.</p>

Select Fields to Update

When you enter the **Record (Table) Name**, the fields that are available for update become available for selection.

<i>Field or Control</i>	<i>Description</i>
Field Name and Field Value	<p>Select each field that you want to update and the value to use.</p> <p>When you run the Population Update process, the system finds the record and updates the field values with the values that you specify for the records that you have identified using the Population Selection utility.</p> <p>If you are running Population Update on the <code>ADM_APPL_DATA</code> record, and in setting up an update for the Completed Date field, you do not specify any date and leave it blank, the system date is used as the field value.</p>

Select Attributes to Update

Use this region to add the attributes you want to update for the record.

<i>Field or Control</i>	<i>Description</i>
Common Attributes	The attribute you can select in this field is based on the attributes you defined on the Population Update Setup page.

Related Links

“Securing and Setting Up the Population Update Process” (Campus Solutions Application Fundamentals)

Using the 3C Engine

Understanding the 3C Engine

Important! Mass Change is a deprecated product. It is strongly recommended that you use Application Engine instead. For more information on PeopleSoft Application Engine, see *PeopleTools: Application Engine*.

The 3C engine is a rules-based PeopleSoft application engine that you can integrate with functional transactions to automatically insert or update communications, comments, and checklists records as you interact with students, suppliers, and employees. For example, you can eliminate steps required to manually enter 3C information by setting the 3C engine to automatically insert defined checklists, communications, and comments for prospects as you enter new admissions prospects to the system. You can use online business transactions to invoke 3C engine processing or you can use background integration with certain delivered programs.

Note: The PeopleSoft system delivers two background programs predefined and integrated with the 3C engine. PeopleSoft Contributor Relations Gift Acknowledgement process invokes the 3C engine to record results in the 3C engine trigger results table for background processing, and PeopleSoft user profiles management process invokes the 3C engine to record the real-time system communication inserts.

To use the 3C engine, you use administrative functions and detail data to define the rules (called engine events) to identify the sets of communication, checklists, and comments records that you want the engine to enter or update for you. Then, you can either set your own conditions (called triggers) to invoke the action of entering or updating the 3C records or you can use the predefined triggers delivered with your system. You can also use Population Selection, Triggers, Mass Change or any combination thereof to identify the IDs to process for an event.

If your institution licenses and uses PeopleSoft Campus Self Service, you can configure your system to record in real time, the checklists that you want self-service users to be able to view in the To Do's list self-service transaction. For example, when a prospective student logs onto your self-service site to request application information about your school, after saving the request, the system can record the checklist information that you specify in the engine event definition. When the prospective student logs in the next time, he or she can see the specific tasks that they must accomplish to complete your school's application process.

Related Links

“Using Self-Service Checklists Data” (Campus Self Service)

Defining 3C Engine Events

This section discusses how to define 3C engine events and discusses how to:

- Define 3C engine events.
- Select joint rules compare fields.
- View communication keys.
- View comments.
- View checklists.

Understanding 3C Engine Events

Define 3C engine events to set rules by which the system identifies the sets of communications, checklists, and comments records for the 3C engine to enter or update.

Prerequisites

Before using the 3C engine, you must set up communications, checklists, and comments. If you are going to use communication speed keys (Comm Keys), set those up first, too.

Related Links

[Understanding Communications Setup](#)

[Understanding Checklist Setup](#)

[Understanding Comment Setup](#)

[Defining Communication Speed Keys](#)

Pages Used to Define 3C Engine Events

<i>Page Name</i>	<i>Definition Name</i>	<i>Navigation</i>	<i>Usage</i>
Event Definition	EVNT_3CS_SETUP	Campus Community > 3C Engine > Set Up 3C Engine > Event Definition	Define 3C engine events to identify or review the communications, comments, or checklists for the 3C engine to assign or update.
Joint Rules Compare Fields	EVNT_JRULES_AF	Click the Variable Data Joint Rules link on the Engine Event Definition page.	Select joint rules compare fields to identify variable data for the 3C engine to compare in determining and assigning joint communications.
Comm Key Detail (communication key detail)	EVNT_3CS_COMM_SEC	Click the Details link in the Communications area of the Engine Event Definition page.	View Communication Keys to determine or modify data for the communication to assign.
Comments Detail	EVNT_3CS_CMNT_SEC	Click the Details link in the Comments area of the Engine Event Definition page.	View or modify the text of the comment to assign.

Page Name	Definition Name	Navigation	Usage
Checklist Detail	EVNT_3CS_CHK_SEC	Click the Details link in the Checklists area of the Engine Event Definition page.	View or modify the parameters of the checklist to assign.

Defining the 3C Engine Events

Access the Engine Event Definition page (**Campus Community > 3C Engine > Set Up 3C Engine > Event Definition**).

This example illustrates the fields and controls on the Engine Event Definition page. You can find definitions for the fields and controls later on this page.

Event Definition

Academic Institution: PeopleSoft University
Event ID: NEWAPPUGRD

Event Detail Find | View All | First 1 of 1 Last

***Effective Date:** 01/01/1900 ***Status:** Inactive

***Description:** New Applicant - Undergraduate

***Short Description:** NewAppUgrd **User Selection**

***Function:** ADMA Admissions Application [Variable Data Joint Rules](#)

Communications

***Comm Key:** UFAPPACK Application Acknowledgment [Detail](#)

Comments

***Comment Category:** UADO Undergraduate Admission - Open [Detail](#)

Checklists

***Checklist Code:** UGALL UG Appl Requirements - All [Detail](#) **Update Status**

*Seq	*Item Code	Description	Responsible ID	*Item Status	Due Date	Due Days	Comm Key
100	ACTSAT	ACT/SAT I	KU0007	Initiated	08/31/2001		
200	PERSTA	Pers State	KU0007	Initiated	08/31/2001		
300	TRANS	Transcpts	KU0007	Initiated	08/31/2001		

Event Detail

Field or Control	Description
Function	Enter the functional area for this 3C engine event.

<i>Field or Control</i>	<i>Description</i>
User Selection	<p>Select this check box to enable users to select the communication, comment, and checklist to assign to transactions for this 3C engine event definition. When selected, the engine assigns only the communication, comment, and checklist specified by the user.</p> <p>For example, if you license and use the Request Information self-service transaction in PeopleSoft Campus Self Service, you would select the User Selection option when defining a 3C engine event for the web prospects. That way, the prospects can select the communications that they want to receive.</p> <p>See “Setting Up Self-Service Request Information” (Campus Self Service).</p> <p>When not selected, the engine assigns all communications, checklists, and comments identified in this 3C engine event.</p>
Variable Data Joint Rules	<p>Click this link to access the Joint Rules Compare Fields page, where you can select the variable data fields that you want the system to compare to determine and assign joint communications.</p>

Communications

<i>Field or Control</i>	<i>Description</i>
Comm Key	<p>Enter the Comm Key to specify the communication to assign as part of this 3C engine event.</p>
Detail	<p>Click this link to access the Event Communication Detail page, where you can view or edit the details of the specified Comm Key.</p>

Comments

<i>Field or Control</i>	<i>Description</i>
Comment Category	<p>Enter the comment category for the comment to assign as part of this 3C engine event.</p>

Field or Control	Description
Detail	Click this link to access the Event Comment Detail page, where you can view or edit the details of the specific comment category.

Checklists

Field or Control	Description
Checklist Code	Enter the checklist code for the checklist to assign as part of this 3C engine event.
Update Status	<p>Select this check box for the 3C engine to update each checklist item to the specified status.</p> <p>For example, you might include an item on the prospects checklist to require the assignment of a recruiter to each new prospect. You can create a 3C engine event definition to have the system automatically update that checklist item when you enter the new prospect into the database and assign the recruiter.</p>
Sequence	The system automatically enters the next sequential number for each checklist item that you add. You can override the number manually to reorder the list of checklist items to be assigned as part of this 3C engine event.
Item Code	<p>Enter the checklist item code for the checklist item to assign as part of this 3C engine event.</p> <p>Available item codes are from the Checklist Item Functions page.</p>
Responsible ID	Enter the ID of the individual at your institution who is responsible for this checklist item.
Item Status	Select the status of the checklist items to assign as part of this 3C engine event.
Due Days	Enter the number of due days associated with the checklist items to assign as part of this 3C engine event.

Field or Control	Description
Due Date	Enter the due date associated with the checklist item to assign as part of this 3C engine event.
Comm Key	<p>The Comm Key of the checklist to be assigned as part of this 3C engine event.</p> <p>If the checklist to assign is of the default type that is set on the Installation_CC page (<i>Communications List</i> is the delivered default value), the system displays the Comm Key field. You can override this to select a different Comm Key.</p>

Selecting Joint Rules Compare Fields

Access the Joint Rules Compare Fields page (click the **Variable Data Joint Rules** link on the Engine Event Definition page).

Field or Control	Description
Compare Field	If you use joint communications, select the data fields to compare for any two related IDs that are set on the Relationships page to enable joint communications. When the compare finds the same variable data in these fields for both IDs, the condition triggers the assignment of a joint communication for the primary ID.

Related Links

[Understanding Joint Communications](#)

Viewing Communication Keys

Access the Comm Key Detail page (click the **Details** link in the Communications area of the Engine Event Definition page).

Data on this page comes from the Communication Speed Key page. You can accept the default data or you can change it. Changing the data here modifies what the 3C engine assigns to individuals or organizations for the Comm Key that you specify. It does not change the data on the Communication Speed Key page.

For example, you might use a particular Comm Key to manually assign communications. You can also use that Comm Key on the 3C event definition, and if you want to make changes that affect only the individuals or organizations to whom the 3C engine assigns communications, you can. Perhaps you have a special condition that occurs and you want to include a special comment on the communication record for those recipients. When you add that comment here, only the communications assigned by this event definition will have that comment. The original Comm Key data remains unchanged.

Viewing Comments

Access the Comments Detail page (click the **Details** link in the Comments area of the Engine Event Definition page).

You can enter a comment for the 3C engine to assign to all of the IDs processed by the engine event. Entering a comment here does not change any comments entered on the Comment Entry page for those IDs.

Viewing Checklists

Access the Checklist Detail page (click the **Details** link in the Checklists area of the Engine Event Definition page).

You can use the default data or modify it. You can enter a comment for the 3C engine to assign to all of the IDs that will be assigned to this checklist by the engine event. Changing data and entering a comment here does not change data or any comments entered on the Checklist Management page for those IDs.

Defining 3C Engine Triggers

This section provides an overview of 3C engine triggers and discusses how to:

- Map trigger prompts.
- Identify trigger conditions.

Understanding 3C Engine Triggers

Online triggers are conditions that you define to indicate when to invoke 3C engine processing. You can define triggers to occur in real time or to store in a trigger table for background processing later. Triggers are table specific. They identify record or field level conditions and associate the 3C engine event definition to use when the trigger conditions are met by creating, changing, or deleting data in the system.

The 3C engine online triggers are integrated with the system by using a PeopleCode function. The function evaluates certain key variable information provided in the PeopleCode placed in the transactional locations. You must define certain variable assignment values when you place this PeopleCode in other records or components. The following PeopleCode example identifies and describes these variables.

For example, the Trigger3CEngine function call placed on the ADM_APPL_DATA record in your system has these variable assignments.

```
Declare Function Trigger3CEngine PeopleCode FUNCLIB_CS.EVENT_3CS_ID FieldFormula;
PanelGroup string &ID, &RECNAME, &ACTION, &OVERRIDE, &VAR_DATA, &INSTITUTION;

&ID = "EMPLID";
&RECNAME = "ADM_APPL_DATA";
&ACTION = "N";
&OVERRIDE = "N";
&VAR_DATA = ?Y?;
&INSTITUTION = ADM_APPL_DATA.INSTITUTION;
```

```
Trigger3CEngine ();
```

The PeopleSoft system delivers some predefined 3C engine PeopleCode function calls. You can use the **EmplID (SavePostChange)** field on these records:

- ADM_APPL_DATA
- ADM_APPL_PROG
- ADM_PRSPCT_CAR
- ADM_PRSPCT_PROG
- ADM_WEB_PRS_CAR

You can configure your system to provide 3C engine integration in other areas by placing the PeopleCode function call in the appropriate records or components in these ways:

- Place the Trigger3CEngine function call in any record or component-record location.
- Place the Trigger3CEngine function call only in the SavePostChange PeopleCode event.
- Place the Trigger3CEngine function call only in locations where a person ID (**EMPLID** or similar field) or organization ID (**EXT_ORG_ID** or similar field) is included in the component.

After you identify and place the appropriate Trigger3CEngine function, you must define the online triggers.

You can view 3C engine triggers in the Trigger Result table before running the 3C engine trigger background process. You can also add individuals or organizations to the trigger table before initiating the background assignments.

Trigger definitions set to process assignments in background add rows to the Trigger Result page as users perform the business transactions that meet the trigger conditions. For example, you can define a trigger to invoke the 3C engine when a new applicant is added. If you set the process mode to *batch* for the trigger, each time a new applicant is added to the database, the 3C engine inserts a row on the Trigger Result page for the new applicant.

Note: Trigger definitions set to *system* mode do not add rows to the Trigger Result table as business transactions are performed.

Pages Used to Define 3C Engine Triggers

<i>Page Name</i>	<i>Definition Name</i>	<i>Navigation</i>	<i>Usage</i>
Trigger Prompt Table	TRGR_PROMPT_TBL	Campus Community > 3C Engine > Set Up 3C Engine > Trigger Prompt Table	Map trigger prompts identifying the edit table to use with the trigger fields.

<i>Page Name</i>	<i>Definition Name</i>	<i>Navigation</i>	<i>Usage</i>
Trigger Definition	TRGR_3CS_ON_SETUP	Campus Community > 3C Engine > Set Up 3C Engine > Trigger Definition	Identify trigger conditions to invoke the 3C Engine.

Mapping Trigger Prompts

Access the Trigger Prompt Table page (**Campus Community > 3C Engine > Set Up 3C Engine > Trigger Prompt Table**).

This example illustrates the fields and controls on the Trigger Prompt Table page. You can find definitions for the fields and controls later on this page.

<i>Field or Control</i>	<i>Description</i>
Edit Table	<p>Enter the source record that contains the field conditions to use on the Engine Trigger Definition page. Mapping to an edit table is optional. For example, to make academic career (ACAD_CAREER) values available from the Engine Trigger Definition page, map to the Academic Career Table (ACAD_CAR_TBL).</p> <p>You can delete the Trigger Prompt definition from the Trigger Prompt Table by using the Delete button on the page.</p>

Identifying Trigger Conditions

Access the Trigger Definition page (**Campus Community > 3C Engine > Set Up 3C Engine > Trigger Definition**).

This example illustrates the fields and controls on the Trigger Definition page (1 of 2). You can find definitions for the fields and controls later on this page.

Trigger Definition

Academic Institution: PeopleSoft University
Record (Table) Name: ADM_APPL_DATA **Trigger Action:** New

***Trigger Level:** ***Status:**

***Function:** Admissions Application

Trigger Assignment	Override Parameters
<input type="radio"/> System <input checked="" type="radio"/> Batch Process	<input type="checkbox"/> Override Override Event ID: <input type="text"/>

▼ Duplicate Communication Check

Check Duplicate Communication [Explain](#)

Additional Conditions to Prevent Duplicate Communication

Variable Data: [Explain](#)
 Communication Status: [Explain](#)

☰ Duplicate Checklist Check

Check Duplicate Checklist [Explain](#)

Additional Conditions to Prevent Duplicate Checklist

Variable Data: [Explain](#)
 Checklist Status: [Explain](#)

This example illustrates the fields and controls on the Trigger Definition page (2 of 2). You can find definitions for the fields and controls later on this page.

Record Level	
Event ID:	<input type="text"/>

Field Level		
Field Combination: 1	*Event ID: <input type="text" value="NEWAPPUGR"/>	
Field Conditions		
Field Name	*Operator	Field Value
<input type="text" value="ACAD_CAREER"/>	<input type="text" value="="/>	<input type="text" value="UGRD"/>

Field or Control	Description
Trigger Action	<p>The system displays the action (<i>New (add)</i>, <i>Change</i>, or <i>Delete</i>) that you selected. The action must occur as described on this page to invoke the 3C engine.</p> <hr/> <p>Note: The SavePostChange PeopleCode must use the same add, change, or delete action that you define here.</p> <hr/>
Trigger Level	<p>Select the level at which this action must occur to invoke the 3C engine.</p> <p><i>Record:</i> The specified trigger action on the row invokes the 3C engine process, regardless of field. You must specify the 3C engine Event ID to process for a record level trigger.</p> <p><i>Field:</i> The specified trigger action on the field invokes the 3C engine process. You must specify the Event ID to process and the fields on which the specified action occurs, to invoke the 3C engine.</p>
Function	Enter the functional area (administrative function) for this event trigger.

Trigger Assignment

Field or Control	Description
System	Select this check box to insert or update in real time, the communications, comments, and checklists specified in the 3C engine event ID.
Batch Process	Select this check box to indicate that when the specified action occurs to the record or field, the system should insert a row on the Engine Trigger Results page for use by 3C engine background processing later.

Override Parameters

<i>Field or Control</i>	<i>Description</i>
Override	<p>Select this check box to prevent the 3C engine from using the field or record conditions identified on this page, and, instead, use the logic configured around the Function Trigger3CEngine PeopleCode on the record or component location.</p> <p>If you select the Override option, you must specify the overriding 3C engine event ID to use.</p>
Override Event ID	Enter the 3C engine event to process when the Override option is selected.

Duplication Communication Check

<i>Field or Control</i>	<i>Description</i>
Check Duplicate Communication	<p>Enter the 3C engine event to use to determine if a communication is a duplicate and to assign or prevent assignment according to the defined conditions.</p> <p>See Managing Duplicate Communication Assignments.</p>

Duplicate Checklist Check

<i>Field or Control</i>	<i>Description</i>
Check Duplicate Checklist	<p>The 3C engine event that determines if a checklist is a duplicate and assigns or prevents assignment according to defined conditions.</p> <p>See Managing Duplicate Communication Assignments.</p>

Record Level

<i>Field or Control</i>	<i>Description</i>
Event ID	Enter the 3C engine event to process when the trigger level is <i>Record</i> .

Field Level

Field or Control	Description
Field Combination	The system displays the next sequential field combination for each field level event ID that you add.
Event ID	Enter the 3C engine event to process when the trigger level is <i>Field</i> and the specified field conditions are met.

Field Conditions

You can define multiple field combination conditions. When the specified trigger action meets any of the conditions, the 3C engine processes the specified field level 3C engine event.

Field or Control	Description
Field Name	Enter the name of the field on the specified record that, when this trigger action is performed, must meet the specified condition to invoke the 3C engine.
Operator	<p>Enter the conditional operator for this field condition and the value that it modifies—for example, the admission term field (<i>ADMIT_TERM</i>) must be greater than or equal to 0390 (March 1990).</p> <p>Values for this field are delivered with the system as translate values. You can modify these translate values:</p> <p>< Less than.</p> <p><= Less than or equal to.</p> <p><> Not equal.</p> <p>= Equal to.</p> <p>> Greater than.</p> <p>>= Greater than or equal to.</p> <p><i>IN</i>: In.</p>

Setting 3C Engine Security

This section provides an overview of 3C engine security and discusses how to assign engine event 3C groups.

Understanding 3C Engine Security

You use 3C groups to set security for 3C engine events just as you do to set security for communications, checklists, and comments outside of the scope of the 3C engine. A user can then trigger only the events within the 3C group to which he or she is assigned. When the trigger is invoked online, the PeopleCode function assigns only those engine events for which that user has inquiry or update access. If the user does not have security access for the engine event, the system ignores the assignment.

Related Links

“Setting Up 3C Group Security” (Campus Solutions Application Fundamentals)

Page Used to Set 3C Engine Security

<i>Page Name</i>	<i>Definition Name</i>	<i>Navigation</i>	<i>Usage</i>
Event 3C Groups	EVNT_GRP_3C_TABLE	Campus Community > 3C Engine > Set Up 3C Engine > Event 3C Groups	Assign engine event 3C groups to assign security to 3C engine event definitions.

Assigning Engine Event 3C Groups

Access the Event 3C Groups page (**Campus Community** > **3C Engine** > **Set Up 3C Engine** > **Event 3C Groups**).

This example illustrates the fields and controls on the Event 3C Groups page. You can find definitions for the fields and controls later on this page.

Event 3C Groups

Academic Institution: PSUNV PeopleSoft University

Event ID: NEWAPPGRAD

Function: Admissions Application

Update/Inquiry Group			
*Group	Description		
GADC	Grad Admissions Counselors	+	-
GADO	Grad Admissions Operations	+	-
GADS	Grad Adm Student Staff	+	-
GRAD	Graduate Admissions	+	-

Add the groups that should have security access to this event ID.

See “Setting Up 3C Group Security” (Campus Solutions Application Fundamentals).

Viewing 3C Engine Trigger Results

Important! Letter Generation (Letter Gen) is a deprecated product. It is strongly recommended that you use Communication Generation (Comm Gen) instead. For more information on Comm Gen, see [Understanding the Communication Generation Process](#)

This section provides an overview of trigger results and discusses how to:

- View 3C trigger results.
- View additional trigger result details.

Understanding Trigger Results

You can review the 3C engine triggers on the 3C Engine Trigger Results page before running the 3C engine trigger background process to assign the communications, checklists, and comments in batch. You can also add individuals or organizations to the trigger table before initiating the batch assignments.

Trigger definitions that are set to process assignments in batch add rows to the 3C Engine Trigger Results page as users perform the business transactions that meet the trigger conditions. For example, you can define a trigger to invoke the 3C engine when a new applicant is added. If you set the process mode to batch for this trigger, each time a new applicant is added to the database, the 3C engine inserts a row for the applicant on the Trigger Result page.

Pages Used to View 3C Engine Trigger Results

<i>Page Name</i>	<i>Definition Name</i>	<i>Navigation</i>	<i>Usage</i>
3C Engine Trigger Results	TRGR_3CS_TABLE	<ul style="list-style-type: none"> • Campus Community > Checklists > 3C Engine Trigger Results • Campus Community > Communications > 3C Engine Trigger Results • Campus Community > Comments > 3C Engine Trigger Results • Campus Community > 3C Engine > 3C Engine Trigger Results 	View trigger results to determine the individuals or organizations to which the 3C engine background process assigns the communications, comments, or checklists.
Variable Data	TRGR_PROS_SEC	Click the Variable Data link on the Trigger Result page, Trigger Detail 1 tab.	View or change the variable data for the targeted individual or organization.

Viewing Trigger Results

Access the 3C Engine Trigger Results page (**Campus Community > [Checklists > Communications > Comments > or 3C Engine] 3C Engine Trigger Results**).

Trigger Detail 1 tab

<i>Field or Control</i>	<i>Description</i>
ID Type	Specify the type of ID, either <i>Person</i> or <i>Organization</i> .
ID	The system displays the ID of the person or organization for the 3C engine to process.
Trigger Status	<p>Select the status of the trigger process to use for the specified individual or organization.</p> <p>By default, when the 3C engine adds a row in the trigger table, it sets the trigger status to <i>Processed</i>. You can override this value.</p> <p>Rows set with the status of <i>Processed</i> are the only rows processed by the 3C engine. To temporarily disable a row from being processed, perhaps to do some investigation, you must set the trigger status to something other than <i>Processed</i>. The other values are: <i>Cancelled</i>, <i>Error</i>, <i>In Process</i>, <i>Suspense</i>, or <i>Unprocessed</i>. These values are delivered with the system as translate values. You should not modify the delivered values, but you can add others.</p> <p>You can reset the trigger status to <i>Processed</i> to include it in the next run of the process. When you run the 3C engine process, the rows set to <i>Processed</i> are deleted, leaving only the rows manually set to a different trigger status.</p>
Function	The system displays the administrative functional area of this 3C engine event.
Variable Data	Click this link to access the Variable Data page, where you can view or change the variable data associated with this individual or organization.
Date Added	Enter the date when this ID is added to the trigger. The default date is the current system date. You can override this value.

Viewing Additional Trigger Result Details

Access the 3C Engine Trigger Results page, Trigger Detail 2 tab (click the **Variable Data** link on the Trigger Result page, Trigger Detail 2 tab).

Trigger Detail 2

<i>Field or Control</i>	<i>Description</i>
Trigger Source	<p>Select the source to use to determine the individuals or organizations to include in this process.</p> <p><i>Batch:</i> The system automatically sets the trigger source to this value when the 3C engine background process processes this ID.</p> <p><i>Online:</i> The system automatically sets the trigger source to this value when a business transaction within the system triggers the 3C engine to process this individual.</p> <p><i>User:</i> The system automatically sets the trigger source to this value when you click Add to add a row and enter an additional ID on the Trigger Detail 1 tab page.</p>
User ID	Enter the ID of the user performing the business transaction that invoked the 3C engine trigger or the ID of the user who initiated the run of the process that resulted in the addition of this row.
Assign ID	Enter the ID of the individual responsible for assigning this trigger.
Print Comment	Select this check box to include the comments in the Letter Generation data extract process.
Comments	The system displays the comments from the Event Definition detail page. You can change the comments and add enter additional comments.
Process Name	The 3C Engine does not use this field. You can use this field to process the ID using a different process, for example <i>Manual</i> or <i>Legacy</i> process.

Running the 3C Engine Process

This section provides an overview of the 3C engine process and discusses how to:

- Specify 3C engine process parameters.
- Manage duplicate communication assignments.

Understanding the 3C Engine Process

Important! Mass Change is a deprecated product. It is strongly recommended that you use Application Engine instead. For more information on PeopleSoft Application Engine, see *PeopleTools: Application Engine*.

Use PeopleSoft Process Scheduler to run the 3C engine background process and process 3C events in the background at a future time. You can run the process by selecting the IDs stored in the trigger table results, or by selecting the IDs using mass change definitions or Population Selection, or a combination of the three.

When you run the background process on a selected population, the communications, comments, and checklists identified by the 3C engine event are added or updated for the individuals or organizations identified by the population selection tool that you identify.

When you run the background process on trigger table results, the communications, comments, and checklists identified by the 3C engine event are added or updated for the individuals or organizations that the trigger added to the Trigger Result page.

When you run the background process on mass change groups or definitions, the 3C engine uses the selection criteria definition and certain other mass change definitions to identify the individuals or organizations for which to add or update communications, checklists, and comments.

You can also specify conditions for the 3C engine to prevent assignment of duplicate communications.

Pages Used to Run the 3C Engine Process

Page Name	Definition Name	Navigation	Usage
3C Engine Parameters page	RUN_CNTL_3CENGINE	Campus Community > 3C Engine > Run 3C Engine > 3C Engine Parameters page	Select how, what, and for whom the 3C engine background process is process.
Event Definition page	EVNT_3CS_SETUP	Click the Detail link next to the Event ID field on the 3C Engine Parameters page.	View details of the event specified for the 3C engine background process to use.
Equation Editor page	EQUATION_EDITOR	Click the Create Equation link, which appears beside the Equation Name field on the 3C Engine Parameters page when Process 3C's is set to <i>Population Selection</i> and the selection tool is <i>Equation Engine</i> .	Select an equation for the 3C engine background process to use for population selection.

Page Name	Definition Name	Navigation	Usage
Population Selection File Mapping page	SCCFP_PS_FILE	<p>Click the Create File Mapping link, which appears beside the empty File Mapping field on the 3C Engine Parameters page when Process 3Cs is set to <i>Population Selection</i> and the selection tool is <i>External File</i>.</p> <p>Click the Edit File Mapping link, which appears beside the populated File Mapping field on the 3C Engine Parameters page when Process 3Cs is set to <i>Population Selection</i> and selection tool is <i>External File</i>.</p>	Create or edit a mapping so that the 3C engine background process can use the uploaded file to identify the desired population.
Query Manager page	QRY_SELECT	Click the Launch Query Manager link, which appears beside the Query Name field on the 3C Engine Parameters page when Process 3Cs is set to <i>Population Selection</i> and the selection tool is <i>PS Query</i> .	View or create a query for the Population Selection process to use.
Student Administration page	MC_DEFN_SA	Click the Edit link, which appears beside a Mass Change definition on the 3C Engine Parameters page when Process 3Cs is <i>Mass Change</i> .	View or edit a mass change definition.
Manage Duplicate Assignment	MANAGE_DUP_ASSIGN	Campus Community > 3C Engine > Run 3C Engine > Manage Duplicate Assignment	Specify conditions for preventing duplicate communication and checklist assignment.

Related Links

[Using the Population Selection Process](#)

Specifying 3C Engine Process Parameters

Important! Mass Change is a deprecated product. It is strongly recommended that you use Application Engine instead. For more information on PeopleSoft Application Engine, see *PeopleTools: Application Engine*.

Access the 3C Engine Parameters page (**Campus Community > 3C Engine > Run 3C Engine > 3C Engine Parameters page**).

This example illustrates the fields and controls on the 3C Engine Parameters page (1 of 2). You can find definitions for the fields and controls later on this page.

3C Engine Parameters
Manage Duplicate Assignment

Run Control ID: PSTEST

[Report Manager](#)
[Process Monitor](#)
Run

Process 3Cs

Population Selection

Trigger Table

Mass Change

Process Joint Records

No

Yes, all Joint IDs

Yes, if match exists

Event Selection

Academic Institution: PeopleSoft University

Administrative Function: Admissions Application

Event ID: Admissions ADMA [Detail](#)

Communication Key

UFAPPACK Application Acknowledgment

Checklist Code

UGALL UG Appl Requirements - All

Checklist Item

100	ACTSAT	ACT or SAT I Test Scores
200	PERSTA	Personal Statement
300	TRANS	Academic Transcripts

Comment Category

UADO Undergraduate Admission - Open

Population Selection

Selection Tool [Edit Prompts](#)

Query Name [Launch Query Manager](#) [Preview Selection Results](#)

This example illustrates the fields and controls on the 3C Engine Parameters page (2 of 2). You can find definitions for the fields and controls later on this page.

Mass Change Selection

Mass Change Group ID [Search](#)

Mass Change Definition

Checklist - Delete Temp	Edit
Primary - ADMA/ADMP Check Base	Edit
Checklist - Admin Function	Edit

Process 3Cs

Group boxes and fields appear on this run control page based on the process that you select: *Population Selection*, *Trigger Table*, *Mass Change*, or any combination thereof.

Field or Control	Description
Population Selection	<p>Select to use the Population Selection process to identify the IDs for the 3C engine to process for the event that you specify.</p> <p>When selected, the Event Selection and Population Selection group boxes become available.</p> <hr/> <p>Note: The Population Selection check box is not visible if the population selection context for the 3C Engine does not allow this menu navigation to use Population Selection to select the IDs to process.</p> <hr/>
Trigger	<p>Select to have the 3C engine process the rows on the 3C Engine Trigger Results page for the event that you specify.</p> <p>When selected, the Event Selection group box becomes available.</p>
Mass Change	<p>Select to have the 3C engine process the mass change group ID data for the event that you specify.</p> <p>When selected, the Mass Change Selection group box becomes available.</p>

Event Selection

This group box appears when you select *Population Selection* or *Trigger Table*, or both.

Field or Control	Description
Academic Institution	Enter the institution whose data this program should process.
Administrative Function	<p>Enter the functional area of the data to process.</p> <p>The field values that appear or become available on the rest of the page are based on the administrative function that you enter.</p>
Event ID	Enter the 3C engine event ID to process.
Detail	Click to access the Event Definition page for the specified event ID where you can view or update the event definition and determine which communications, checklists, and comments the definition includes.

Joint Processing

This group box appears for all selections.

Field or Control	Description
No	Select this option if you do not want to apply joint communication rules to this process.
Yes, All Joint IDs	Select this option to apply joint communication rules and include all communications set to enable joint communications.
Yes, if match exists	Select this option to apply joint communication rules and include joint communications only when dates in the variable data fields match.

Communication Key, Checklist Code, and Comment Category

These group boxes appear when you select *Population Selection* or *Trigger Table*, or both. They do not appear for *Mass Change* because the communication key is selected from inside the mass change definition.

The system displays the Comm Key for the checklist code and checklist item and the comment category associated with the event ID that you entered. The 3C engine adds or updates these items for the IDs identified by the processes you selected .

Population Selection

This group box appears when the *Population Selection* process is selected.

Population selection is a method for selecting the IDs to process for a specific transaction. The Population Selection group box is a standard group box that appears on run control pages when the Population Selection process is available or required for the transaction. Selection tools are available based on the selection tools that your institution selected in the setup of the Population Selection process for the application process and on your user security. Fields in the group box appear based on the selection tool that you select. The fields behave the same way from within the group box on all run control pages and application processes.

If your institution uses a specific delivered selection tool (PS Query, Equation Engine equation, or external file) to identify IDs for a 3C engine transaction, you must use it.

Mass Change Selection

This group box appears when you select *Mass Change*.

<i>Field or Control</i>	<i>Description</i>
Mass Change Group ID	Enter the group ID to process.
Mass Change Definition	Displays the mass change definitions that are assigned to the specified Mass Change Group ID .
Edit	Click to access the Student Administration page of the Mass Change component where you can view and edit the specific mass change definition.

See “Processing Mass Changes” (Campus Solutions Application Fundamentals).

Managing Duplicate Communication Assignments

Access the Manage Duplicate Assignment page (**Campus Community > 3C Engine > Run 3C Engine > Manage Duplicate Assignment**).

Click the **Explain** link beside any item to display a message explaining the options and function of that item.

Duplicate Communication Check

<i>Field or Control</i>	<i>Description</i>
Check Duplicate Communication	<p>Select this check box to require the 3C engine to determine if a communication is a duplicate before assigning it.</p> <p>When this option is selected and no additional conditions are specified, the engine does not assign the duplicate if it finds that a communication of that letter code is already assigned.</p> <p>When this check box is not selected, the engine assigns the communication, whether or not it is a duplicate.</p>

To evaluate if two communications are the same, the 3C engine compares these fields:

<i>Label Name</i>	<i>Record Name</i>
ID Type	SA_ID_TYPE
ID	COMMON_ID
Institution	INSTITUTION

Label Name	Record Name
Administrative Function	ADMIN_FUNCTION
Communication Category	COMM_CATEGORY
Communication Context	COMM_CONTEXT
Communication Direction	COMM_DIRECTION
Letter Code	LETTER_CD
ID Related	EMPLID_RELATED
Joint Communication	JOINT_COMM
Include Inclosure	INCLUDE_INCL

Additional Conditions to Prevent Duplicate Communication

Enter values in this area to specify whether the engine should compare variable data and status to further identify duplicates and prevent assignment.

Field or Control	Description
Variable Data	<p>Specify the variable data conditions under which duplicates should not be assigned.</p> <p><i>Match:</i> If a communication matches a previously assigned communication and they have matching variable data, do not assign the communication.</p> <p><i>Do Not Match:</i> If a communication matches a previously assigned communication and their variable data do not match, do not assign the communication.</p> <p><i>(Blank):</i> Do not consider variable data.</p>

Field or Control	Description
Communication Status	<p>Specify the communication status under which duplicates should not be assigned.</p> <p><i>Completed:</i> If a communication matches a previously assigned communication for which the status is completed, do not assign the communication.</p> <p><i>Not Completed:</i> If a communication matches a previously assigned communication for which the status is not completed, do not assign the communication.</p> <p><i>(Blank):</i> Do not consider communication status.</p>

Note: If a variable data and a communication status condition are both specified, then *both* conditions must be met to prevent assignment of the duplicate communication.

Duplicate Checklist Check

Field or Control	Description
Check Duplicate Checklist	<p>Select this check box to require the 3C engine to determine if a checklist is a duplicate before assigning it. When this option is selected and no additional conditions are specified, the engine does not assign the duplicate if it finds that a similar checklist code is already assigned.</p> <p>When this check box is not selected, the engine assigns the checklist, whether or not it is a duplicate.</p>

To evaluate if two checklists are the same, the 3C engine compares these fields:

Label Name	Record Name
ID Type	SA_ID_TYPE
ID	COMMON_ID
Checklist Code	CHECKLIST_CD
Institution	INSTITUTION
Administrative Function	ADMIN_FUNCTION

Managing Communications

Understanding Communication Management

Important! Letter Generation (Letter Gen) is a deprecated product. It is strongly recommended that you use Communication Generation (Comm Gen) instead. For more information on Comm Gen, see [Understanding the Communication Generation Process](#)

Communication management enables you to track and analyze all of your institution's contacts with students, staff, constituents, and organizations inside and outside the institution. You can track:

- All incoming and outgoing communications.
- All types of communication—letters, email, phone calls, personal contact, facsimiles, and so on.
- Communications generated by other offices that affect your office.
- All staff involved with a communication.

You can also assign communications to individuals, organizations, and groups of people.

To assign a communication, you must select the method, category, context, direction, and letter code for that communication to identify basic information about the communication, such as the who, what, when, and how of each communication, which correlate in this way:

- Method = How
- Context = What
- Category = Why
- Direction = Where
- Date = When
- ID = Who

Use the communication management pages to manually assign communications to individuals or organizations. You can access the communication management pages as described here, or you can access them by clicking the **Communication** button on pages throughout the system.

You can assign communications to individuals and organizations manually, or you can use the 3C engine to automatically assign communications to individuals or organizations based on rules and conditions that you define.

See [Defining 3C Engine Triggers](#).

You can indicate whether the communication is a phone conversation, a letter, or an in-person meeting with the individual. If the communication is an outgoing softcopy document, you can, with either Letter Generation or Communication Generation, manage the variable data and enclosures to include, and enter comments that you can choose to print or not print in the output. With Communication Generation, you can also manage variable data, attachments to include, and comments to include or exclude in an outgoing email. With Communication Generation, you can also send an outgoing communication based on the student's preferred method of either letter or email, and send it in any language supported by your institution that is set at the student's preferred language.

In addition to creating communications for individuals, you can create communications for organizations. For example, you can send letters to schools announcing that an admissions counselor from your institution will be in their area on a certain date, or you can send bills to companies with which your institution does business.

When you assign a communication, you must identify the data to extract about the recipients and select the code from the Standard Letters table to identify the template to use. For Letter Generation, you use your institution's word processing software to merge the data into a template created with that software and associated with the letter code, or into one of the sample Microsoft Word templates that the PeopleSoft application delivers. For Communication Generation, you identify the data source from which to extract data, associate it with the XML report definition, and associate the report with the standard letter code.

Use the inquiry pages to review communication information for an individual or an organization. You can enter criteria and search for a summary of communications or view details of the communication assignments. You can search for a summary of communications to determine if a specific communication was sent, if it included enclosures, or if it was a joint communication.

Note: You are able to view only those communications that are associated with the communication 3C groups to which you have security access. With 3C group inquiry access, you can view communication assignments, but you cannot change them. With 3C group update access, you can view and change the communications. Use the Operator 3C Groups Summary page to determine or change an individual's 3C group security status.

See “Selecting the Type of 3C Group Access” (Campus Solutions Application Fundamentals).

This procedure provides a high-level overview of the managing communications processes and the order in which they must be performed. Steps 1 through 5 are described in Setting Up Communications.

To generate and manage communications:

1. Set up codes for the standard letters that your institution wants to use.

Each letter requires an administrative function.

2. Set up communication contexts.

Contexts include methods, directions, and letter codes.

3. Set up communication categories.

Categories are sets of communication contexts.

4. Set up communication 3C groups.

3C groups are required for assigning security access for communications.

5. (Optional) Set up communication speed keys (Comm Keys).

Comm Keys enable you to associate communication elements together and access them as a set, using the assigned shortcut code.

6. Assign communications to individuals or organizations.

You can assign communications manually or you can use the 3C engine to assign communications automatically in real time or in the background.

7. Review communications assigned to individuals or organizations.

You can review the details of each communication. You can view a list of all communications assigned to them. You can also review the security access that users have for viewing or updating the communications.

8. Generate the communications.

You can use either the Letter Generation process to generate letters or the Communication Generation process to generate letters and emails. The Letter Generation process extracts data that you can then, using your word processing software, merge into letter templates. The Communication Generation process extracts only the data specified in the source file and merges it immediately into the associated Oracle BI Publisher templates for letters or emails. For emails, the process also sends the generated outputs to the extracted email addresses.

9. Review the data that was extracted for each of the IDs processed.

Understanding Joint Communications

Important! Letter Generation (Letter Gen) is a deprecated product. It is strongly recommended that you use Communication Generation (Comm Gen) instead. For more information on Comm Gen, see [Understanding the Communication Generation Process](#)

PeopleSoft Campus Solutions enables you to communicate jointly with individuals at a common address rather than producing separate communications for each individual. For example, you can invite a married couple or two roommates to an event by sending a single invitation to their joint address.

Functions on the relationships and communications pages enable you to create joint communications for two individuals when at least one of the individuals exists in your database.

Detailed information about each page where you select an option or enter data to manage joint communications is included in the appropriate places throughout the documentation. The following procedure provides a high-level overview of the process and indicates where the relevant pages are documented.

To set up joint communications functionality:

1. Design how the two names appear in the greeting and in the address portion of the letter by setting up the joint salutation on the Joint Salutation Type Table page.

See [Establishing Salutations](#).

2. Set the **Default Salutation Type** on the Installation Defaults - CC page.

If no default salutation type is defined, the letter generation data extract process fails.

See [Reviewing or Defining Campus Community Installation Settings](#).

3. Create joint usages on the Name Usage page.

Always include the default salutation type (from step 2) in usage orders for joint communications so that the process does not fail due to the lack of a salutation.

See [Establishing Name Usages](#).

To generate a joint communication:

1. Set the letter code on the Standard Letters page to **Allow Joint Communication**.

See [Defining Letter Codes](#).

2. Create the relationship on the Relationship page for the individual in your database.

Click the **Manage Joint Communication** button to access the Joint Communication Management page, where you set the relationship to **Create Joint Communication**, and define the joint salutation.

See [Managing Relationships Data](#).

3. Identify the address to use for the joint communication and select the **Joint Address** check box on the Relationship Address page.

See [Managing Relationships Data](#).

4. Assign the communication to the individual in your database; if both individuals are in your database, assign the communication to only one.

You can use the 3C engine to detect the related records and automatically assign the joint communication, or you can assign the communication manually on the Person Communication page, where you assign communications to individuals.

Select the **Create Joint Communications** check box on the Person Communication page. This check box is available for selection based on steps 1 and 2 and when the ID has a relationship set to enable joint communications and the letter code is set to enable joint communications.

See:

- [Understanding the 3C Engine](#)
- [Assigning Communications](#)

5. Run the Letter Generation or the Communication Generation process to create an extract file containing data for the joint IDs, including the specified joint salutation and joint address.

The Communication Generation process extracts the joint email address specified in the Relationships component.

See [Managing Relationships Data](#).

- (Optional) Review communications and verify when they were sent, to whom they were sent, and if they were joint.

You can review all communications in the system or review a summary of communications assigned to the primary individual or the related ID, if it exists. The joint communication is listed in the summary for both IDs even though the joint communication can be assigned to only one ID.

See [Reviewing Communications](#).

Prerequisites for Managing Communications

Before assigning and managing communications, you must set up communications in the system.

Related Links

[Understanding Communications Setup](#)

Common Elements Used to Manage Communications

See [Common Elements Used in The 3Cs Documentation](#)

<i>Field or Control</i>	<i>Description</i>
View or Edit	<p>Click to transfer to where you can view or edit the communication assignment.</p> <hr/> <p>Note: The View link is available when the user has 3C group <i>inquiry</i> access for the communication category. The Edit link is available only when the user has 3C group <i>update</i> access for the communication category.</p> <hr/>

Assigning Communications

Important! Letter Generation (Letter Gen) is a deprecated product. It is strongly recommended that you use Communication Generation (Comm Gen) instead. For more information on Comm Gen, see [Understanding the Communication Generation Process](#)

This section discusses how to:

- Assign a communication.
- Review or update variable data.
- Add or delete enclosures.

- View the communication generated by the Communication Generation process.
- Identify recipients for an organization.

Pages Used to Assign Communications

Page Name	Definition Name	Navigation	Usage
Person Communication	COMM_MGMT1	<ul style="list-style-type: none"> • Campus Community > Communications > Person Communications > Communication Management • Contributor Relations > Constituent Information > People > Communications > Communication Management • Contributor Relations > Communications > Communications > Person > Communication Management 	Assign communications to individuals.
Organization Communication	ORG_COMM_MGMT1	<ul style="list-style-type: none"> • Campus Community > Communications > Organization Communications > Communication Organization • Contributor Relations > Constituent Information > Organizations > Communications > Organization Communication • Contributor Relations > Communications > Communications - Organization > Organization Communication 	Assign communications to organizations.

<i>Page Name</i>	<i>Definition Name</i>	<i>Navigation</i>	<i>Usage</i>
Variable Data	VAR_XXXX_SEC (where XXXX is the administrative code)	<ul style="list-style-type: none"> Click the Variable Data button on the Person Communication page. Click the Variable Data button on the Organization Communication page. 	Review or edit variable data for an individual or organization.
Communication Enclosure	ENCL_TBL_SEC	<ul style="list-style-type: none"> Click the Enclosures button on the Person Communication page. Click the Enclosures button on the Organization Communication page. 	Review, add, or delete enclosures when assigning a communication.
View Communication	SCC_CG_ATTREL	Click the View Generated Communication link that appears on the Person Communication or Communication Recipient Data pages or on the Organization Comm Recipients page when a communication is generated by the Communication Generation process.	Launch a new window displaying the final outputs, including softcopy enclosures, generated by the Communication Generation process.

<i>Page Name</i>	<i>Definition Name</i>	<i>Navigation</i>	<i>Usage</i>
Organization Comm Recipients	ORG_COMM_MGMT2	<ul style="list-style-type: none"> • Campus Community > Communications > Organization Communications > Organization - Organization > Organization Comm Recipients • Contributor Relation > Constituent Information > Organizations > Communications > Organization Communication > Organization Comm Recipients • Contributor Relations > Communications > Communications - Organization > Organization Communication > Organization Comm Recipients 	Identify the contacts, departments or locations at the organization who should receive the communication.

Assigning a Communication

Access the Person Communication page (**Campus Community > Communications > Person Communications > Communication Management**) or the Organization Communication page (**Campus Community > Communications > Organization Communications > Communication Organization**).

This example illustrates the fields and controls on the Person Communication page (1 of 2). You can find definitions for the fields and controls later on this page.

Person Communication		Communication Recipient Data	
Jane Brisebois		ID: CCCG0001	
Communication Assignment			
Assign DateTime:	04/11/2006 2:37:54PM		
'Function:	ADMA <input type="text"/>	Admissions Application	Variable Data
'Institution:	PeopleSoft University <input type="text"/>		
Comm Key:	<input type="text"/>		
'Category:	CG <input type="text"/>	Communication Generation Test	
'Context:	CG <input type="text"/>	Communication Generation Test	
'Method:	L <input type="text"/>	Letter	
'Direction:	Outgoing Communication <input type="text"/>		
Letter Code:	CG <input type="text"/>	Communication Generation Test	<input type="checkbox"/> Include Enclosures <input type="button" value="Enclosures"/>
Communication Process Details			Checklist Association
Communication Date:	04/11/2006 <input type="text"/>	Begin Time: <input type="text"/>	End Time: <input type="text"/>
Comments:	Bonjour! Ceci est un test pour CCCG0001.		<input type="checkbox"/> Print Comment
Communication ID:	KU0007 <input type="text"/>	Locherty,Betty	Sequence:
Department:	<input type="text"/>		Item Sequence:
<input type="checkbox"/> Create Joint Communications			

This example illustrates the fields and controls on the Person Communication page (2 of 2). You can find definitions for the fields and controls later on this page.

Communication Process Details			Checklist Association
Communication Date:	04/11/2006 <input type="text"/>	Begin Time: <input type="text"/>	End Time: <input type="text"/>
Comments:	Bonjour! Ceci est un test pour CCCG0001.		<input type="checkbox"/> Print Comment
Communication ID:	KU0007 <input type="text"/>	Locherty,Betty	Sequence:
Department:	<input type="text"/>		Item Sequence:
<input type="checkbox"/> Create Joint Communications			
Communication Outcome			
Communication Generation Date:	11/06/2009		
<input checked="" type="checkbox"/> Communication Completed	Date Activity Completed:	11/06/2009 <input type="text"/>	
<input type="checkbox"/> Unsuccessful Outcome	Reason:	<input type="text"/>	
Language Used	English <input type="text"/>		
Method Used	Letter <input type="text"/>		
Process Used	CommGen <input type="text"/>	View Generated Communication	
Process Instance	830 <input type="text"/>		

Note: If you transferred to this page by clicking the **Communication** button on another page, the administrative function of the functional area of the first page, along with the academic institution and all the variable data associated with the administrative function, transfers here. If you did not transfer here from a functional area, you must enter the function, institution, and variable data.

Communication Assignment

<i>Field or Control</i>	<i>Description</i>
Function	<p>Enter the code for the functional area that includes this communication.</p> <p>Available function codes are from the Administrative Functions page.</p>
Variable Data	<p>Click this button to access the Variable Data page, where you can view or enter the required variable data associated with the specified function.</p>
Institution	<p>Specify the institution responsible for this communication.</p>
Comm Key (communication speed key)	<p>Enter the name of the communication speed key that contains the communication category, communication context, method, direction, and letter code for this communication.</p> <p>When you select a communication speed key that is valid in your user preferences, the system displays all the values for you. If you do not use a valid communication speed key, you must enter the category, context, method, direction, and letter code values manually.</p>
Category	<p>Enter the category code for this communication.</p> <p>Available category codes are from the Communication Categories page.</p>
Context	<p>Enter the context code for this communication.</p> <p>Available context codes are from the Communication Contexts page.</p>

Field or Control	Description
Method	<p>Enter the method for this communication.</p> <p>Only the methods associated with the specific context on the Communication Contexts page are available.</p> <hr/> <p>Note: The method selected on the Communication Generation process run control component overrides the method that you enter on the assignment component.</p> <hr/>
Direction	<p>Select the direction for this communication.</p> <p>Only the directions associated with the specific context on the Communication Contexts page are available from the prompt list.</p>
Letter Code	<p>The code, from the Standard Letter Table CS component, for this communication. The letter codes available are those associated with the context and function selected for this communication.</p>
Include Enclosures	<p>If the selected letter code represents a letter that is set up to include enclosures, the system automatically selects this check box for you. You can then click the Enclosures button to review, add, or delete the set enclosures.</p> <p>If the letter is not set up to include enclosures, you can manually select this check box to include enclosures and click the Enclosures button to add the desired enclosures.</p>
Enclosures	<p>This button is available when the Include Enclosures check box is selected. Click to access the Communication Enclosure page, where you can review, add, or delete enclosures.</p>

Communication Process Details

Field or Control	Description
Communication Date	<p>The default communication date is the system's current date. You can override this date.</p> <p>Enter the date on which the communication should be processed. For example, you might assign a communication today, but want the communication to be processed two weeks from today. Override the default date and enter the date two weeks from now. The extract processes for both Letter Generation and Communication Generation look at this date to know when to generate the communication.</p>
Begin Time and End Time	<p>Enter the times when the communication begins and ends. These times are helpful for telephone or in person communications.</p>
Comments	<p>Enter comments to further identify or describe the communication for this individual.</p> <p>If comments are associated with the communication speed key, the system automatically displays them here. You can change these comments or delete them.</p>
Print Comment	<p>Select this check box to print comments on the communication.</p>
Communication ID	<p>Enter the ID of the staff person who communicated with or is initiating this communication with the individual.</p>
Department	<p>(Optional) Enter the department within your institution that is responsible for assigning this communication.</p> <p>Available departments are from the Department Profile page.</p>

<i>Field or Control</i>	<i>Description</i>
Create Joint Communications	<p>This check box is available only if the individual to whom you are assigning the communication has a joint relationship on the Relationships component and if the letter code on the Standard Letters page is set to allow joint communications.</p> <p>When available, select this check box to address the communication jointly to this individual and the related individual identified on the Relationships page.</p> <p>See Understanding Joint Communications.</p> <p>See Managing Relationships Data.</p>

Checklist Association

The system automatically populates the fields in this group box only when the communication is created as part of a checklist.

<i>Field or Control</i>	<i>Description</i>
Sequence	The checklist sequence, from the Checklists page.
Item Sequence	The checklist item sequence number, from the Checklists page, that created this communication.

See [Setting Up Checklist Templates](#).

Communication Outcome

When you run either the Letter Generation process or the Communication Generation process, the system automatically completes the fields in this group box to indicate the outcome of the communication, at which point the fields become uneditable.

If you do not use either of the processes and you want to track the communication outcome, you must manually enter the appropriate values in the fields.

Field or Control	Description
Communication Generated Date	<p>The system displays the date and time when the process generated the communication.</p> <p>For the Letter Generation process this is the Update Communication Letter Printed Date With from the run control page.</p> <p>For the Communication Generation process this is the Update Communication Generation Date With from the run control page.</p>
Communication Completed	<p>Select the check box to indicate that the communication was generated. For example, the communication is complete if the phone call was made or if the letter was generated.</p> <p>The Letter Generation and Communication Generation processes automatically mark the communication complete so that the process will not select the ID again for the same communication.</p> <p>On the run control pages for both processes, you can set the process to not mark the communication complete if the ID is missing critical data. Administrative users can add the missing critical data (for example, a missing address) and the process will select the ID again for processing.</p> <p>See Using the Letter Generation Process.</p> <p>See Using the Communication Generation Process.</p> <p>If you are using a communication speed key, the system might select this check box for you, depending on information associated with that Comm Key.</p> <p>See Defining Communication Speed Keys.</p>
Date Activity Completed	<p>Enter the date when completing the communication. Letter Generation and Communication generation processes populates this date with the Update Communication Completed Date With date from their respective run control page. You can manually override this date.</p> <hr/> <p>Note: When you update the status of a communication that is related to a checklist item, the system displays a message reminding you to also update the status of the checklist item.</p> <hr/>

Field or Control	Description
Unsuccessful Outcome	<p>Select this check box to indicate that the communication was unsuccessful. For example, if no one answered the phone or the letter was returned as undeliverable.</p> <p>If the Letter Generation or Communication Generation process was used, the process selects this check box to indicate that the process was unable to successfully extract data for this communication. The Communication Generation process also selects this check box if the ID was set to receive an email but no email address was found, and if no organization recipient was found when generating an organization communication.</p> <p>If you are using a communication speed key, the system might select this check box for you, depending on information associated with that Comm Key.</p>
Reason	<p>Available when the Unsuccessful Outcome check box is selected.</p> <p>Indicates the reason that the communication was unsuccessful. For example, if a letter that you sent was returned, you might select <i>Returned Mail</i> as the reason that the communication was unsuccessful.</p> <p>The Letter Generation or the Communication Generation processes select <i>Missing Critical Data</i> to indicate that the absence of critical data prevented the extract process from completing for this communication.</p> <p>Values for this field are delivered with the system as translate values. Do not modify the values of <i>Missing Critical Data</i>, <i>Invalid Email Address</i>, and <i>No Org Recipients Found</i>.</p>

Field or Control	Description
Language Used and Method Used	<p>Displays the values used by the generating process.</p> <p>The Letter Generation process uses the base language that was set for your institution at installation and the method of <i>Letter</i>, which is the only method that the process supports.</p> <p>The Communication Generation process uses the language and method specified on the Communication Generation run control component.</p> <p>Also, for communications with individuals, if your institution supports preferences and the Communication Generation process is set to use them, the preferences takes priority over your institution's base language and the method selected during communication assignment.</p> <p>For example, assume that your institution's base language is English and the assigned method is <i>Letter</i>, but an ID's preferred language is French and her preferred method is email. The Communication Generation process is set to use the preferences and upon completion of the process, the outcome Language Used would be <i>French</i>, and the Method Used would be <i>Email</i>.</p> <p>For communications with organizations, the Language Used is your institution's base language, and the Method Used is determined by your selection on the Communication Generation Run Control parameters page.</p> <hr/> <p>Note: Communication preferences are not supported for organization recipients.</p> <hr/>
Process Used	<p>Displays the name of the process used to generate the communication: <i>Letter Gen</i>, <i>Comm Gen</i>, or <i>Manual</i> if you manually completed the communication.</p>

Field or Control	Description
Process Instance	<p>Appears only when the communication for the ID is marked <i>Completed</i> by the Letter Generation, Communication Generation, or Envelope and Label Generation process. You cannot change the number. The process instance number is a reference to the communication data used by the process to generate and complete the communication.</p> <p>The process instance number from the Communication Generation process retrieves the data extracted for the letter to ensure data consistency when envelopes and labels are generated by the Envelope and Label process. The process uses the Communication Generation process instance number (on the Envelope and Label Generation Selection Parameters page) to capture the same data.</p>
View Generated Communication	<p>This link appears only when a communication is generated by the Communication Generation process and the Letter Printed Data field in the Standard Letter Table CS component for the letter code used, is set to <i>All</i> or <i>Name/Address Only</i>.</p> <p>If recipients are set for the ID on the Relationships component, this link appears on the Communication Recipient Data page for each recipient for whom the communication was generated. The process uses the language and method assigned to the main ID for the ID's recipients.</p> <p>For organization communications, the link appears on the Organization Comm Recipients page for each recipient for whom the communication was generated.</p> <p>Click to access the View Communication page where you can view the final outputs of the generated communications, including softcopy enclosures. This is useful for history purposes and for reprinting a letter or re-sending an email.</p> <hr/> <p>Note: The View Generated Communication link appears only for the Communication Generation process. The Letter Generation process saves extracted data inside the Communication Letter Data page for each ID.</p> <hr/> <p>See Defining Letter Codes.</p> <p>See Setting Up Individual Relationships.</p>

Reviewing or Updating Variable Data

Access the Variable Data page. (For individuals, click the **Variable Data** button on the Person Communication page. For organizations, click the **Variable Data** button on the Organization Communication page.)

Different fields and data appear on this page based on the administrative function selected on the Person Communication page.

Related Links

[Understanding Administrative Functions](#)

Adding or Deleting Enclosures

Access the Communication Enclosure page. (For individuals, click the **Enclosures** button on the Person Communication page. For organizations, click the **Enclosures** button on the Organization Communication page.)

Note: When an enclosure is set as required for a letter on the Standard Letters page, information for that enclosure is visible but not available on the Communication Enclosure page. Thus, users are prevented from deleting an enclosure that your institution has decided is required.

Field or Control	Description
Seq. No (sequence number)	<p>The system automatically enters the next sequential number, up to 10, for each enclosure that you add. You can override the numbers manually to reorder the list of enclosures for this communication.</p> <p>When you run the letter generation data extract process, the process lists, in the order identified here, up to 10 maximum enclosures on the main letter.</p>
Enclosure Code	<p>Enter the code for the letter that is to be included as an enclosure for this communication.</p> <p>The letter codes available are those associated with the same function that you select for the main letter code. For example, if you select the function <i>ADMA</i> for the main letter code, the Enclosure Code field prompt list displays the letter codes that exist and are associated with the function <i>ADMA</i> on the Standard Letters page.</p>
Enclosure Type	<p>The system automatically displays the type of output (<i>Hardcopy</i> or <i>Softcopy</i>) associated with the selected enclosure letter code.</p>
Required	<p>Select this check box to indicate that the specific enclosure must accompany this communication at all times.</p>

Viewing the Communication Generated by the Communication Generation Process

Access the View Communication page (click the **View Generated Communication** link that appears on the Person Communication or Communication Recipient Data pages or on the Organization Comm Recipients page when a communication is generated by the Communication Generation process).

Field or Control	Description
View	<p>Click to open a new window displaying the .pdf or .rtf file containing the generated letter or email output.</p> <hr/> <p>Note: The first letter code in the View Generated Communication list is the main letter code of the generated communication. The other letter codes, if any, are the enclosures letter codes.</p> <hr/>
View Envelope	<p>Appears only when the <i>Create Envelopes</i> output option is selected on the Process Parameters page in the Communication Generation component.</p> <p>Click the link to open a new window displaying the .pdf file containing the generated output for the envelope. Viewing the envelope data can help you gather all information necessary to resend a communication.</p> <hr/> <p>Note: You can view only the generated envelope, not the label. However you can use the envelope data to recreate the label if necessary.</p> <hr/>

This is an example view of a generated letter output.

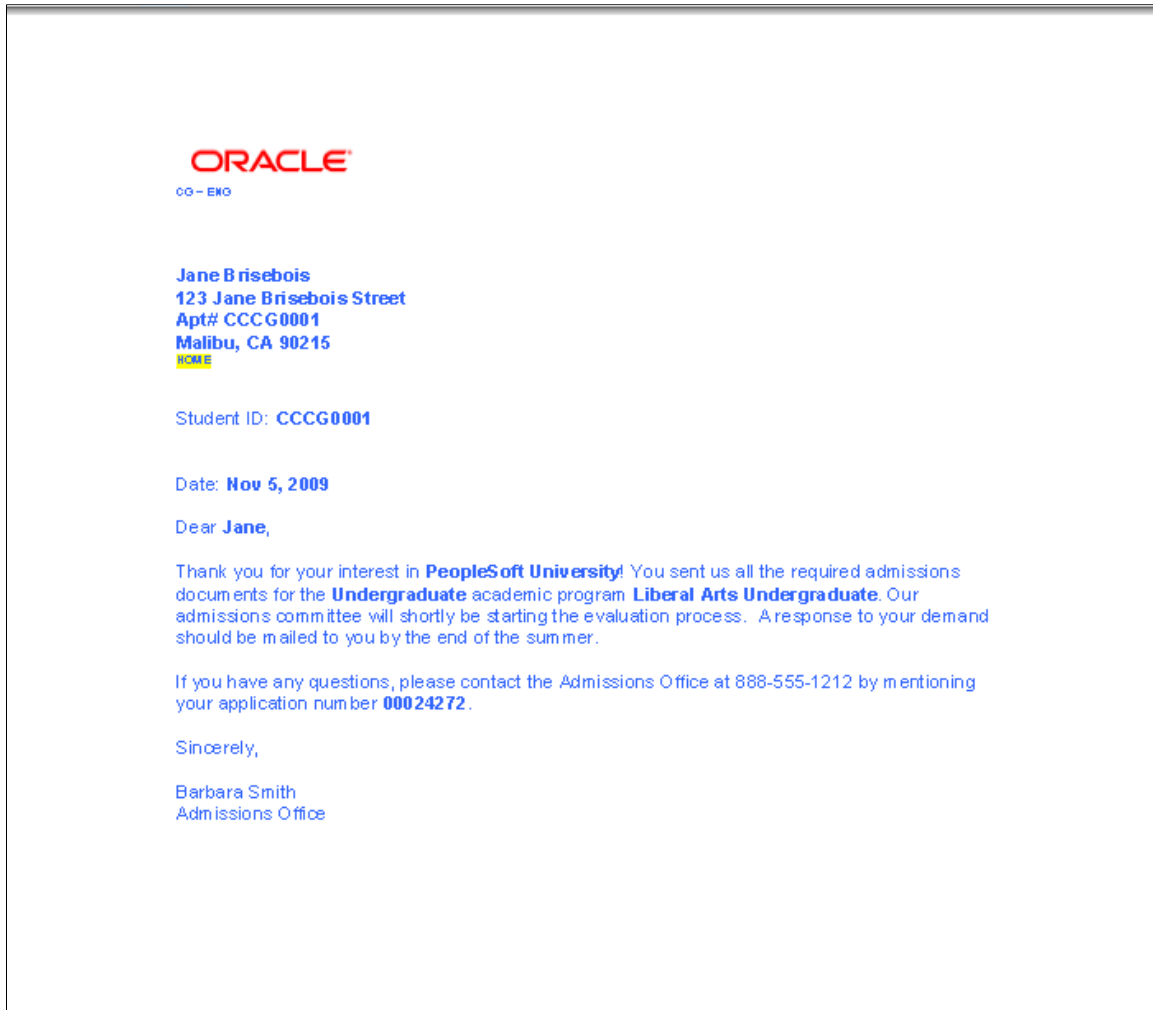

This is an example view of a generated envelope output.



Identifying Recipients for an Organization

Access the Organization Comm Recipients page (**Campus Community > Communications > Organization Communications > Communication - Organization > Organization Comm Recipients**).

If the letter code used to assign the communication has Communication Generation parameters defined on the Standard Letters Table page, then both the **Recipients - Comm Gen Process** and **Recipients - Letter Gen Process** group boxes appear. If, when you assign the communication, you do not know which process will be used to generate the communication, you can either define recipients for both processes, or you can leave the fields blank in which case, the process evaluates default usages to select the recipients.

Recipients - Comm Gen Process

The Communication Generation process will extract data for multiple recipients including contacts, departments, locations or any combination of those.

The system displays values in the **Contact**, **Department**, and **Recipient** group boxes based on the *Contact Recipient*, *Department Recipient*, and **Location Recipient** values that you enter.

The fields are enterable only when *Custom List* is selected. If you do not know who should receive the communication for an organization, do not select any recipients. The Communication Generation process will evaluate the value entered in the **Org Communication Usage** group box in the run control component. If the process does not find recipients based on the usage, it selects the **Unsuccessful Outcome** check box and displays the reason *No Org Recip Found* (no organization recipient found).

After the Communication Generation process runs, each group box becomes unavailable and lists who in that group was set to receive the communication. The system displays a *View generated communication* link next to each recipient for whom the output was generated. Click to access the Communication View page where you can launch a window displaying the final output as it was addressed to that recipient.

If you select *All Departments*, the system displays all the departments for the organization in the **Recipients - Comm Gen Process** group box as of that date. For example, if you run the process 2 weeks later and 3 more departments were added, the process extracts data for all departments including those 3 and the group box lists 3 more department names than before.

Field or Control	Description
Contact Recipient	Enter the type of contact that should receive this communication. The available values are: <i>(Blank)</i> , <i>All Contacts</i> , <i>Custom List</i> , <i>Org Preferred Contact</i> , and <i>Org Primary Contact</i> . These are translate values and should not be modified.
View Organization Contacts	Click to access the Organization Contacts Summary page, where you can view all the contacts for this organization by contact type to determine which contacts should receive this communication.

Field or Control	Description
Contact Number and Preferred	<p>Enter the number of the specific recipient contact. The system displays the contact's name, type, location, and department.</p> <p>If the contact is set as the preferred contact on the Contact Summary page for the organization, the system selects the Preferred check box.</p> <p>See Creating Organization Records, “Active Contacts.”</p>
Department Recipient	<p>Enter the departments whose contacts should receive this communication. The available values are: <i>(Blank)</i>, <i>All Departments</i>, <i>Custom List</i>, and <i>Org Primary Department</i>. These are translate values and should not be modified.</p>
View Organization Departments	<p>Click to access the Organization Department Summary page, where you can view all the departments and their contacts for this organization to determine which contacts should receive this communication.</p>
Department Number	<p>Enter the number of the specific recipient department. The system displays the department and location names from the Organization Departments page</p> <p>See Creating Organization Records, “Active Departments.”</p>
Location Recipient	<p>Enter the location whose contacts should receive this communication. The available values are: <i>(Blank)</i>, <i>All Locations</i>, <i>Custom List</i>, and <i>Org Primary Location</i>. These are translate values and should not be modified.</p>
View Organization Locations	<p>Click to access the Organization Location Summary page, where you can view locations for this organization to determine which contacts to select as recipients for this communication.</p>
Location Number	<p>Enter the number of the specific recipient location.</p> <p>The location information comes from the Location Summary page for the organization.</p> <p>See Creating Organization Records, “Active Locations.”</p>

Recipients - Letter Gen Process

For the Letter Generation process, you can identify the recipient for the organization if you know it, or you can leave the fields blank, in which case the process evaluates default usages to select the recipient for you.

Field or Control	Description
Contact Number	Enter the contact number of the person at the organization who should receive this communication. Available IDs are from the Organization Contacts page.
Department Number	Enter the number of the department at the organization whose contact should receive this communication. Available departments are from the Organization Departments page.
Location Number	Enter the number of the location to use for this organization. Available locations are from the Organization Locations page.

Using the Letter Generation Process

Important! Letter Generation (Letter Gen) and Financial Aid Notification (FAN) letter are deprecated products. It is strongly recommended that you use Communication Generation (Comm Gen) instead. For more information on Comm Gen, see [Understanding the Communication Generation Process](#)

This section provides overviews of the Letter Gen process and the sample templates, lists prerequisites, and discusses how to:

- Specify general parameters.
- Specify date/merger parameters.
- Specify checklist parameters.
- Run the letter generation data extract process.

Understanding the Letter Generation Process

Important! Mass Change is a deprecated product. It is strongly recommended that you use Application Engine instead. For more information on PeopleSoft Application Engine, see *PeopleTools: Application Engine*.

You can extract data from your PeopleSoft Campus Solutions system and use it to generate letters, labels, lists, envelopes, and so on. You can extract data from one individual ID, all individual IDs, or all organization IDs in your database. You specify the type of data to extract and then run the extract process. The system places the extracted data into a comma delimited (.csv) file, which is a standard format readable by most word processing programs. Then, using your institution's word processing software, you

can merge the data into any of the templates that you have for the letter codes defined on the Standard Letters page, including the sample Microsoft Word templates delivered with the system, and print the outcome.

For information about using your institution's word processing software to merge data and print letters, consult the manufacturer's documentation.

Before you can extract letter data, a communication record for the desired letter must be assigned to the intended recipients. For joint communications, you should assign the communication to only one of the individuals. If you assign it to both, the letter generation process extracts the data for both IDs and will print two joint communications for the same two people. The record must include the appropriate administrative function, communication category, and communication context, and specify a method of *Letter* and the direction of *Outgoing*. You can assign communications to individuals or organizations manually or using the 3C engine or mass change functionality.

When the communication records exist, follow this procedure to use the Letter Generation process to extract data and generate a letter:

To generate a letter:

1. Specify the data to extract for the letter, including the ID, address usage, address name, salutation, and letter code.
2. Specify the date to print on the letter, the date to use as the letter completed date, and the communication date selection range.
3. Specify any checklist items to include in the letter.
4. Run the Letters Data Extract process to extract the specified data.
5. Use your word processing program to merge the extracted data into the letter template.
6. Save the softcopy template with merged data or use it to print the letter.

Specifying the parameters for extracting data for the letter includes selecting the letter to use, identifying the individuals or organizations whose data you want to extract, and specifying the types of data to extract. Use the run control pages, described in the following sections, to specify extract data parameters.

After defining all of the parameters for extracting data, run the data extract process. Unless you specify a different file path, the process places the data files in the temporary directory for the server. You can specify a shared folder on your local machine or on any valid network drive path.

When the process finishes, files with the appropriate file names are placed at the specified extract file path destination. If you select the .csv output, three files are created at the destination:

- CCLTR<LETTERCODE>.CSV for letters.
- CCLBL<LETTERCODE>.CSV for labels.
- CCLTRGEN.DAT file, which is coded to work with the Microsoft Word templates delivered with the system.

For example, if you use the TRN letter code and you select the .csv output, the file for letters at the destination is CCLTRTRN.CSV.

Note: If you use a letter code for which you specified a unique Structured Query Compiler (SQC), you must place the SQC in the same directory as the CCLTRGEN.sqr and the CCLTRUNQ.sqc. You must also modify CCLTRNAM.SQC to look for the specific SQC.

You can review extracted data online for individuals and organizations on the Communication Letter Data pages.

When you run the letter generation data extract process, the data specified under Letter Printed Data for that letter code on the Standard Letter Table page is listed on the Communication Letter Data page for individuals or on the Organization Communication Letter Data page for organizations. You can use these pages to review and confirm the data extracted for an individual or organization. For example, using the Communication Letter Data page, you can confirm the address to which the letter for a specific individual was addressed.

The letter generation data extract process automatically formats extracted addresses to meet U.S. postal regulations for domestic and international mail. The format is reflected in the address listed on the appropriate Letter Data page.

If you set a relationship to generate a copy of communications for a separate recipient on the Communication Recipient page in the Relationships component, you can view the data extracted for that separate recipient on the Communication Recipient Data page described in this section.

Understanding the Letter Generation Sample Templates

The letter generation data extract process creates a .dat file for merging data from your system into Microsoft Word templates. The PeopleSoft Campus Solutions system delivers sample Microsoft Word templates. You can use the sample templates as delivered, modify them (unless otherwise indicated in the warning below), or create your own Microsoft Word templates.

This table lists the CS letter codes with corresponding delivered sample templates.

<i>Letter Code</i>	<i>Description</i>	<i>Microsoft Word Template Name</i>
APP	Appointment Mailer	CCLTRAPP.DOC
AV1	Gift Acknowledgement	CCLTRAV1.DOC
AV2	Gift Receipt	CCLTRAV2.DOC
CST*	Inquiry Acknowledge – Viewbook	CCLTRCST.DOC
F02	Frosh Missing Requirements	CCLTRF02.DOC
F03	Frosh Admit Regular	CCLTRF03.DOC
FAN*	Financial Aid Notification	FANLTR.DOC
IHC	International Health Coverage	CCLTRIHC.DOC

Letter Code	Description	Microsoft Word Template Name
IN1	Initiative Appeal	CCLTRIN1.DOC
JNT	Summer party - Joint Invitation	CCLTRJNT.DOC
MAD	Mid-Term Academic Deficiency	CCLTRMAD.DOC
MB1	Membership Card	CCLTRMB1.DOC
OFR	Early Offer Letter	CCLTROFR.DOC
OPR	Web Operator Notification	CCLTROPR.DOC
P01	Inquiry Acknowledgment	CCLTRP01.DOC
REC	Admit Recipient Letter	CCLTRREC.DOC

Warning! Do not modify the PeopleSoft Financial Aid FAN letter code or template. Modifications to this value could cause processes that depend on it to fail, requiring substantial reprogramming effort.

Prerequisites

Before identifying data to extract and merge into letters or other communications output, design your Campus Community structure, including names and address usages. Before specifying checklist items data to extract, set up checklists and tracking groups.

Related Links

[Designing Campus Community](#)

[Understanding Checklist Setup](#)

Pages Used for the Letter Generation Process

Page Name	Definition Name	Navigation	Usage
General Parameters	RUNCTL_LTRGEN1	Campus Community > Communications > Letter Generation > General Parameters	Specify general parameters for extracting letter data, including the IDs for which data is to be extracted, the letter code into which the data should be merged, the name and address usages to use, and the joint salutation (if appropriate).

Page Name	Definition Name	Navigation	Usage
Date/Merge Parameters	RUNCTL_LTRGEN2	Campus Community > Communications > Letter Generation > Date/Merge Parameters	Specify the necessary file locations, dates, and sort option for extracting data.
Checklist Parameters	RUNCTL_LTRGEN3	Campus Community > Communications > Letter Generation > Checklist Parameters	Specify any checklist items to extract and use in a letter.

Specifying General Parameters

Access the General Parameters page (**Campus Community > Communications > Letter Generation > Checklist Parameters**).

This example illustrates the fields and controls on the General Parameters page. You can find definitions for the fields and controls later on this page.

General Parameters
Date/Merge Parameters
Checklist Parameters

Run Control ID: 1
[Report Manager](#)
[Process Monitor](#)
Run

ID Selection

All IDs
 One Person ID
 All Person IDs
 One Org ID
 All Org IDs

Person ID:

Organization ID:

Letter Code Selection

Letter Code: 🔍
College Fair Invitation

Missing Critical Data

Produce Communication

 Complete Communication

Name and Address Usage

Address:

Addr Name:

Salutation:

Joint Salutation Usage

Joint Name:

ID Extract Name Usage

ID Extract Name Usage:

Copyright © 1988, 2024, Oracle and/or its affiliates.

1883

ID Selection

<i>Field or Control</i>	<i>Description</i>
All IDs	Select to extract the data from all IDs (person IDs and organization IDs) that are assigned a communication with the letter code indicated and that are not marked complete.
One ID	Select to extract the data from the one individual ID indicated. The communication with the indicated letter code must be assigned to this individual. If you select the One ID option, specify the individual's ID in the Person ID field.
All Person IDs	Select to extract the data from all the individuals' IDs that are assigned a communication with the letter code indicated.
One Org ID (one organization ID)	Select to extract the data from the one organization ID indicated. The communication with the indicated letter code must be assigned to this organization. If you select the One Org ID option, specify the organization's ID in the Organization ID field.
All Org IDs (all organization IDs)	Select to extract the data from all the organization IDs that are assigned a communication with the letter code indicated and that are not marked complete.

Letter Code Selection

<i>Field or Control</i>	<i>Description</i>
Letter Code	Enter the letter code that identifies the template into which to merge the extracted data. Only those letter codes to which you have 3C group security access are available from the list.

Missing Critical Data

Field or Control	Description
Produce Communication	Select this check box for the process to produce the extract file even if critical data is missing (for example, address information or name of the recipient).
Complete Communication	Select this check box for the process to set the status to <i>Complete</i> even if critical data is missing.

Name and Address Usage

Name and address usages apply to letters addressed to individuals. They do not apply to letters for organizations.

Field or Control	Description
Address	<p>Enter the type of address, from the Address Usage page, to extract for this letter.</p> <p>You can list address types in a preferred search-and-use order. For example, if you list an address usage that contains <i>Mailing</i>, <i>Billing</i>, and <i>Home</i> the system searches for the mailing address first; if none exists, then the billing address; if none exists, the home address last.</p>
Addr Name (address name)	<p>Enter the type of name, from the Name Usage page, to extract for the address section of this letter.</p> <p>As with addresses, you can list address name types in a preferred search-and-use order.</p>
Salutation	<p>Enter the type of name, from the Name Usage Table page, that the system should extract for use in the opening or salutation of this letter.</p> <p>For example, you might want to use the individual's primary full name in the address section of the letter, but use his preferred first name in the salutation (Dear Dave).</p> <p>As with addresses, you can list salutation name types in a preferred search-and-use order.</p>

Joint Salutation Usage

<i>Field or Control</i>	<i>Description</i>
Joint Name	<p>The Joint Name field is available when the selected letter code is set on the Standard Letters page to allow joint communications. The joint names available in the list are those with the Joint Usage check box selected on the Name Usage page.</p> <p>The process extracts this salutation name usage for IDs set up for joint communications.</p>

ID Extract Name Usage

<i>Field or Control</i>	<i>Description</i>
ID Extract Name Usage	<p>Enter the ID name usage to use. The ID Extract Name Usage is an additional way to extract name data using the name usage.</p> <p>For example, you might want to use the individual's primary full name in the address section of the letter (Mr. Juan M. Dominguez), his preferred first name in the salutation (Dear Juan), and his last name in the text to say <i>We are sure the Dominguez family will enjoy participating in this event.</i></p> <p>As with addresses, you can list ID name types in a preferred search-and-use order.</p>

Specifying Date/Merge Parameters

Access the Date/Merge Parameters page (**Campus Community > Communications > Letter Generation > Date/Merge Parameters**).

Extract File Path/Options

The server temporary directory is the default location for the .cvs and .dat extract files. If you want the system to place the files elsewhere, specify the correct path here.

The path must be a valid network path, containing the path delimiter (forward slash or back slash), and be in the appropriate letter case (upper or lower) for your platform. For example, on Windows NT where the target machine is Machine01 and the target folder is LtrData, the valid path is \\Machine01\temp\LtrData\.

<i>Field or Control</i>	<i>Description</i>
File Type	<p>Select the file type (<i>CSV</i> or <i>Other</i>) to create an extract file compatible with your word processing program. Comma delimited (.csv) files are compatible with most word processing programs.</p> <p>The process also creates a .dat file specifically for Microsoft Word and the Word templates delivered with the system.</p>

Update Communication Letter Printed Date With

Select the date to appear on the letter.

<i>Field or Control</i>	<i>Description</i>
Communication Date	Select to use the communication assignment date from the Person Communication page for individuals or the Organization Communication page for organizations as the date on the letter.
System Date	Select to extract the current system date for the date of the letter.
User Supplied Date	Select to use the specified date as the date of the letter. You must supply the desired date.

Update Communication Completed Date With

Select the date for the system to use as the communication completed date on the communication record.

<i>Field or Control</i>	<i>Description</i>
Communication Date	Select to use the date when the communication was assigned as the communication completed date.
System Date	Select to use the current system date as the communication completed date.
User Supplied Date	Select to use the specified date as the communication completed date. You must supply the desired date.

Communication Date Range Selection

Enter the date range of the communication records from which to extract data. For example, you might want to extract data only from those IDs to which you assigned a specific letter code and set the communication date between January 1 and March 1 of the current year.

Use the date range to schedule and manage letter communications. For example, you might schedule daily or weekly runs of the letter generation data extract process for prospect inquiry letters, or missing information letters for applicants.

The from and to date range is inclusive of the dates that you enter.

Word Merge Parameters

If you are using the sample Word templates delivered with the system or if you are using other templates created in Microsoft Word, specify parameters here. A macro (CCLTRGEN.DOT) built into the delivered Word template process uses these parameters when performing a letter merge.

If you are not using Microsoft Word, you can skip these fields.

Note: Setting these parameters on the Letter Generation run control page affects the data included in the CCLTRGEN.DAT file, but does not invoke the Word merge process. To perform a letter merge, you must launch Word and perform the merge process.

<i>Field or Control</i>	<i>Description</i>
Template Path	Enter the file path to the template into which the process should merge the data.
Sort Option	Enter the order in which the process should sort the merged letters. Values for this field are delivered with the system as translate values. Do not modify these values in any way. Any modifications to these values could require substantial programming effort.
Send to Printer	Select for the Word letter merge process to automatically send the letter with merged data to the printer.

Specifying Checklist Parameters

Access the Checklist Parameters page (**Campus Community > Communications > Letter Generation > Checklist Parameters**).

<i>Field or Control</i>	<i>Description</i>
Checklist Type	Enter the type of checklist from which the process should extract data for this letter.
Tracking Group	Enter the tracking group whose checklist data the process should extract for this letter.
Checklist Code	Enter the specific checklist code whose checklist item data the process should extract for this letter.

Tracking Group Status

If you specified a tracking group, you must also select a tracking group status. You can select more than one status option.

<i>Field or Control</i>	<i>Description</i>
Initiated	Select to extract tracking group data with the status of <i>Initiated</i> for this letter.
Completed	Select to extract tracking group data with the status of <i>Completed</i> for this letter.

Checklist Status

<i>Field or Control</i>	<i>Description</i>
Initiated	Select to extract data from checklists with the status of <i>Initiated</i> for this letter.
Completed	Select to extract data from checklists with the status of <i>Completed</i> for this letter.

Item Status

If you specified a checklist code, you must select a checklist item status. You can select more than one status option.

<i>Field or Control</i>	<i>Description</i>
Initiated	Select to extract data from checklist items with the status of <i>Initiated</i> for this letter.

Field or Control	Description
Completed	Select to extract data from checklist items with the status of <i>Completed</i> for this letter.
Waived	Select to extract data from checklist items with the status of <i>Waived</i> for this letter.
Notified	Select to extract data from checklist items with the status of <i>Notified</i> for this letter.
Second Notification	Select to extract data from checklist items with the status of <i>Second Notification</i> for this letter.

Running the Letter Generation Data Extract Process

After you specify the extract parameters, you can run the CCLTRGEN data extract process by clicking the **Run** button from the General Parameters page, the Date/Merge Parameters page, or the Checklist Parameters page.

Note: Setting parameters on these run control pages affects the data included in the CCLTRGEN.DAT file; however, it does not invoke the merge process. To perform a merge, you must launch the merge process provided from within your institution's word processing software. If you want to merge the extract data into any of the sample templates (or other Word templates), you must launch Word and perform Word's Mail Merge process.

Note: The default output for CCLTRGEN is .csv. This setting is defined within the CCLTRGEN program. Selecting **Type** and **Format** field values on the Process Scheduler Request page does not change this output.

Related Links

[Reviewing Extract Data for a Communication](#)

Using the Communication Generation Process

Important! Letter Generation (Letter Gen) and Financial Aid Notification (FAN) letter are deprecated products. It is strongly recommended that you use Communication Generation (Comm Gen) instead. For more information on Comm Gen, see [Understanding the Communication Generation Process](#)

This section provides overviews of the Communication Generation (Comm Gen) process and the sample templates, lists prerequisites, and discusses how to:

- Enter selection parameters.

- Enter process parameters.
- Enter email parameters.
- Enter checklist parameters.

Understanding the Communication Generation Process

Important! Mass Change is a deprecated product. It is strongly recommended that you use Application Engine instead. For more information on PeopleSoft Application Engine, see *PeopleTools: Application Engine*.

The Communication Generation process (SCC_COMMGEN) is an application engine process that enables you to select specific fields from which to extract critical data for a letter code assigned to individual and organization IDs for whom you want to generate the communication. If your institution sets up and supports multiple languages and multiple methods for communications, you can generate communications for individuals in the language and method preferred by each recipient ID.

For communicating with organizations, the Communication Generation process enables you to select multiple contacts of multiple types as recipients of the communication for an organization. You can use contact names or organization departments and locations or any combination thereof.

Note: The preferred communication language and method features apply only to person communications. You cannot set preferences for recipients of organization communications.

The Communication Generation process supports enclosures, joint communications, communication recipients, checklist extract and status update, usages (names, address and salutation), print communication comment, and so on. Oracle BI Publisher is a PeopleTools feature that enables you to manage and merge communication templates and data source files for the Communication Generation process to generate letters or emails. The process uses standard letter codes from the Standard Letter Table page in PeopleSoft Campus Community.

Note: Both the Letter Generation and the Communication Generation processes use the letter codes set in the Standard Letter Table CS component. The only difference is that you must set up some additional aspects of a letter code specifically for the Communication Generation process. The Letter Generation uses the same letter codes, but ignores the Communication Generation-specific settings.

To use the Communication Generation process, you must first assign a communication record for the desired letter code to the intended recipients. For joint communications, you should assign the communication to only one of the individuals. If you assign it to both, the Communication Generation process extracts the data for both IDs and generates two joint communications for the same two people. The record must include the appropriate administrative function, communication category, and communication context and the direction of *Outgoing*.

You can assign communications to individuals or organizations manually, or you can use the 3C engine to assign them using the Population Selection process, the Trigger Event process, or the Mass Change process.

Related Links

[Setting Up the Communication Generation Process](#)

[Understanding Joint Communications](#)

Assigning Communications
Adding or Deleting Enclosures

Understanding the Communication Generation Sample Templates

The Communication Generation extract process uses an Oracle BI Publisher data source for merging data from your system into templates. The PeopleSoft system provides samples of Oracle BI Publisher templates for the Communication Generation process. Templates are objects stored in the PeopleSoft database that are associated with report definitions starting with *QA_CS* and have a data source type of *XMLDoc Object*. You can use the sample templates as delivered, modify them unless otherwise indicated, or create your own templates. The sample report definition and template names begin with *QA_CS*, but you can rename them.

See *PeopleTools: BI Publisher for PeopleSoft*.

This table lists the letter codes and corresponding report definitions.

Letter Code	Description	Report Definitions
CG	Communication Generation Test	QA_CSCGREPO QA_CSXTRADMA
CG1	Comm Generation Org Test 1	QA_CSCG1REPO QA_CSXTRAVIN
CG2	Comm Generation Org Test 2	QA_CSCG2REPO QA_CSXTRAVIN
CGO	Comm Generation Org Test	QA_CSCGOREPO QA_CSXTRAVIN
F01	Frosh Application Acknlgment	QA_CSF01REPO QA_CSXTRADMA
F02	Frosh Missing Requirements	QA_CSF02REPO QA_CSXTRADMA
REC	Admit Recipient	QA_CSRECREPO QA_CSXTRADMA
RM1*	Reminder Letter - 1st Request	QA_CS_SF_RMD
RM2*	Reminder Letter - 2nd Request	QA_CS_SF_RMD

Letter Code	Description	Report Definitions
RM3*	Reminder Letter - 3rd Request	QA_CS_SF_RMD
XT1	Extract Enclosure 1	QA_CSXTRGEN
XTR	Extract Data testing - CommGen	QA_CSXTRGEN

*Before modifying these letter codes, consult your student financials department or system administrator. Modifications to these could cause failure of processes that depend on them.

Prerequisites for the Communication Generation Process

Before identifying data to extract into a template, design your Campus Community structure, including names and address usages. Before specifying checklist items data to extract, set up checklists and tracking groups. Before running the Communication Generation process to generate and print letters, configure your printer for printing PDF format, and before running the process to generate and send emails, set your Process Scheduler SMTP settings.

See:

- *PeopleTools: Process Scheduler*, "Managing PeopleSoft Process Scheduler, Using PSADMIN with PeopleSoft Process Scheduler."
- *PeopleTools: BI Publisher for PeopleSoft*

Related Links

[Designing Campus Community](#)

[Understanding Checklist Setup](#)

Pages Used for the Communication Generation Process

<i>Page Name</i>	<i>Definition Name</i>	<i>Navigation</i>	<i>Usage</i>
Selection Parameters	SCC_CG_RUNCTL1	<ul style="list-style-type: none"> • Campus Community > Communications > Communication Generation > Selection Parameters • Contributor Relations > Session Management > Acknowledgements > Generate Acknowledgements > Communication Generation > Selection Parameters • Contributor Relations > Communications > Process Communications > Communication Generation > Selection Parameters 	Specify general parameters for extracting letter data, including the recipient IDs for which data is to be extracted, the letter code, and report name. Also define the language and the method for the Communication Generation process to use to generate a specific letter or email.
Process Parameters	SCC_CG_RUNCTL2	<ul style="list-style-type: none"> • Campus Community > Communications > Communication Generation > Process Parameters • Contributor Relations > Session Management > Acknowledgements > Generate Acknowledgements > Communication Generation > Process Parameters • Contributor Relations > Communications > Process Communications > Communication Generation > Process Parameters 	Specify usages and dates for the Communication Generation process to use, identify how the process is to handle missing critical data, and specify where the process is to place and sort the output when generating a specific letter or email.

Page Name	Definition Name	Navigation	Usage
Email Parameters	SCC_CG_RUNCTL_EMAL	<ul style="list-style-type: none"> • Campus Community > Communications > Communication Generation > Process Parameters • Contributor Relations > Session Management > Acknowledgements > Generate Acknowledgements > Communication Generation > Process Parameters • Contributor Relations > Communications > Process Communications > Communication Generation > Process Parameters 	Enter email data for the Communication Generation process to use when generating an email.
Checklist Parameters	SCC_COMM_CHKLST	<ul style="list-style-type: none"> • Campus Community > Communications > Communication Generation > Email Parameters • Contributor Relations > Session Management > Acknowledgements > Generate Acknowledgements > Communication Generation > Email Parameters • Contributor Relations > Communications > Process Communications > Communication Generation > Email Parameters 	Specify any checklist items to extract and use in a letter or an email.

Entering Selection Parameters

Access the Selection Parameters page (**Campus Community > Communications > Communication Generation > Selection Parameters**).

This example illustrates the fields and controls on the Selection Parameters page (1 of 2). You can find definitions for the fields and controls later on this page.

Selection Parameters
Process Parameters
Email Parameters
Checklist Parameters

Run Control ID: CG_LABEL_ENV [Report Manager](#) [Process Monitor](#) Run

ID Selection

ID Selection: Population Selection

Population Selection

Selection Tool: Equation Engine

Equation Name: CCCGPSORGS [Edit Equation](#) [Preview Selection Results](#)

Letter Code Selection

'Letter Code: CGO Comm Generation Org Test **Administrative Function:** AVIN Advancement Initiatives

Template Selection

[Report Name](#) QA_CSXTRAVIN AVIN Extract Report Definition [View Report Definition](#)

Data Source ID: QA_CS_XTR_AVIN_DS

Template ID	Description	Language	Method	Default
QA_CSXTR_AVIN_ENG	AVIN Extract Template ENG	English	Letter	<input checked="" type="checkbox"/>
QA_CSXTR_AVIN_ENG_EMAIL	AVIN Extract Template ENG Email	English	E-Mail	<input type="checkbox"/>
QA_CSXTR_AVIN_FRA	AVIN Extract Template FRA	French	Letter	<input type="checkbox"/>
QA_CSXTR_AVIN_FRA_EMAIL	AVIN Extract Template FRA Email	French	E-Mail	<input type="checkbox"/>

This example illustrates the fields and controls on the Selection Parameters page (2 of 2). You can find definitions for the fields and controls later on this page.

Enclosures Assigned (Softcopy) [View All](#) First 1 of 4 Last

Enclosure Code: CG1 Comm Generation Org Test 1

Template Selection

[Report Name](#) QA_CSCG1REPO CG1 Report [View Report Definition](#)

Data Source ID: QA_CS_CGO_DATASOURCE

Template ID	Description	Language	Method
QA_CSCG1_TEMPLATE_ENG	CG1 Template English	English	Letter
QA_CSCG1_TEMPLATE_ENG_EMAIL	CG1 Template English Email	English	E-Mail
QA_CSCG1_TEMPLATE_FRA	CG1 Template French	French	Letter
QA_CSCG1_TEMPLATE_FRA_EMAIL	CG1 Template French Email	French	E-Mail

No Matching Template Found

Use Default Template Do Not Produce Communication Refresh Enclosure List

Communication Language Usage

Specified Language: English

Preferred

Communication Method Usage

Specified Method: Letter

Preferred

ID Selection

Field or Control	Description
ID Selection	<p>Select the type of IDs to process: <i>All IDs</i>, <i>All Person IDs</i>, <i>One Person ID</i>, <i>All Org IDs</i>, <i>One Org ID</i> or <i>Population Selection</i>. These are translate values and should not be modified.</p> <hr/> <p>Note: When the <i>Population Selection</i> value is selected, the IDs selected will be processed only if they have a communication assigned to them using the specified letter code, are within the communication date range, and are not yet completed. To assure that selected IDs have the desired letter code assigned, consider using the same population selection tool (same PS Query name, Equation Engine equation, or external file) inside the 3C Engine process to assign the desired letter code communication to the IDs.</p> <hr/>
Person ID	Available only when the ID Selection is <i>One Person ID</i> . You must enter the specific person ID to process here.
Organization ID	Available only when the ID Selection is <i>One Org ID</i> . You must enter the specific organization ID to process here.

Population Selection

This group box appears only when the **ID Selection** of *Population Selection* is selected.

Population selection is a method for selecting the IDs to process for a specific transaction. The Population Selection group box is a standard group box that appears on run control pages when the Population Selection process is available or required for the transaction. Selection tools are available based on the selection tools that your institution selected in the setup of the Population Selection process for the application process and on your user security. Fields in the group box appear based on the selection tool that you select. The fields behave the same way from within the group box on all run control pages and application processes

If your institution uses a specific selection tool (PS Query, Equation Engine equation, or external file) to identify IDs for a Communication Generation transaction, you must use it.

The PeopleSoft system delivers predefined sample queries to enable you to select person IDs, organization IDs, or both. The predefined queries are:

- QA_CS_CC_PS_COMMGEN - Population Selection and CommGen for PER.
- QA_CS_CC_PS_COMGEN_ORG - Population Selection and CommGen for ORG.
- QA_CS_CC_PS_COMMGEN_BOTH - Population Selection and CommGen for P+O.

The PeopleSoft system also delivers predefined sample equations to enable you to select person IDs, organization IDs, or both. The predefined equations are:

- CCCBSPERS - Person only.
- CCCBPSORGS - Organizations only.
- CCCGPSBOTH - Person and organizations.

See [Using the Population Selection Process](#).

Letter Code Selection

Field or Control	Description
Letter Code	<p>Enter the letter code to use.</p> <p>Only letter codes set up for the Communication Generation process and that are currently assigned to the specified IDs are available. For example, if you select <i>All Person IDs</i> and the FAN letter code is not assigned to any ID, the FAN letter code is not available.</p> <hr/> <p>Note: If you select the ID Selection of Population Selection or All IDs, all letter codes enabled for the Communication Generation process are available. This is because the IDs to select are still unknown at this point</p> <hr/> <p>See Defining Letter Codes.</p>
Administrative Function	<p>Displays the administrative function associated with the letter code.</p>

Field or Control	Description
<p>Report Name, Data Source ID, and Template List</p>	<p>Only the reports to which the report definition gives you security access, are available.</p> <p>If the letter code is associated with only one report, the system displays the report name, the data source file, and a list of the templates associated with that report.</p> <p>If the letter code is associated with more than one report, click Report Name to select the additional reports to use. When you select a report, the system displays the list of templates associated with that report along with the language and method for which the template is created. The Template List group box shows which template the system will use as a default template if there is no specified template.</p> <hr/> <p>Note: An error message appears if two or more template IDs have the same combination of language and method inside one report definition. The combination of method and language must be unique for the Communication Generation process to know which template to use for each ID generated.</p> <hr/> <p>See Creating a Template.</p> <p>See <i>PeopleTools: BI Publisher for PeopleSoft</i>.</p>
<p>View Report Definition</p>	<p>Click to open a new browser window displaying the Report Definition search page. In the new browser window, enter the report name or other information about the definition that you want to view and click Search to access the Report Definition component for the report. View the definition to confirm that it is the definition that you want to make available and to preview the templates.</p> <p>You can make changes to the report definition if you have security access to the page.</p>

Enclosures Assigned (Softcopy)

Field or Control	Description
Enclosure Code,Data Source ID, and Template List	<p>If the letter code includes softcopy enclosures for the IDs, the system displays each enclosure code and its relevant information. Enter the report name to use for each enclosure.</p> <p>If no softcopy enclosures are included, the system collapses the group box.</p> <hr/> <p>Note: If you select the ID Selection of <i>Population Selection</i>, you must select a report definition for all the enclosure codes that were included in the Person/Org Communication Management component when the letter code was assigned. This is because the IDs to select are still unknown at this point.</p> <hr/>
Refresh Enclosure List	<p>Click to cause the Enclosures Assigned (Softcopy) section to include all available softcopy enclosures including enclosures that were added to the system since the last refresh of the process run control ID.</p> <p>Refresh the list of enclosures periodically to make sure you are processing the communications appropriately in scheduled runs of the process. Failure to refresh the list could result in producing missing enclosures for some IDs.</p> <p>For example, assume that you schedule a run control ID of <i>AAA</i> to run every night to generate a communication for all IDs that have the letter code <i>ABC</i> assigned. The next day, an administrator assigns letter code <i>ABC</i> to John Smith and includes enclosure <i>XYZ</i>. <i>XYZ</i> is not already included in the Enclosures Assigned (Softcopy) group box for run control <i>AAA</i>. If you don't refresh the list to cause <i>XYZ</i> to be included before the next run, the process will not generate the <i>XYZ</i> letter for John Smith.</p>
Report Name, Data Source, and Template List	<p>These fields behave the same in the Enclosures Assigned (Softcopy) group box as in the Letter Code Selection group box</p>

No Matching Template Found

Field or Control	Description
<p>Use Default Template or Do Not Produce Communication</p>	<p>Select an option to specify what to do if the language and method combination to use for an ID is not listed in the template list for the report name selected.</p> <p>Select Use Default Template to use the template set as the default inside the report ID, or select Do Not Produce Communication to not produce the communication for an ID where no template is found.</p> <p>For example, if in the Communication Language Usage section the language to use is <i>Preferred</i> and the preferred language of the ID is <i>Italian</i> but no Italian template is associated with the specified report, do you want the system to use the default template, which in this case is the <i>English Letter</i> template, or do you want the system to skip the communication for that ID?</p> <hr/> <p>Note: The option that you select applies to the main letter code, not to the enclosures. The process assumes that the report definition contains an enclosure code with at least one language and method combination that is the same as the one set for the main letter code. If the system does not find at least one that is the same, a message appears when you try to save the run control component or when the process runs and encounters the problem.</p> <hr/>

Communication Language Usage

Select options in this group box and in the Communication Method Usage box, to identify the template for the Communication Generation process to use.

Field or Control	Description
Specified and Language, or Preferred	<p>The system selects the Specified option by default and sets the Language field to the base language that was set at installation. You can change the language to use, however, the Template List group box for the main letter code must include a template that uses the language that you specify.</p> <p>If your institution supports language preferences, you can select Preferred to cause the system to evaluate and use the preferred language of each ID if any. When Preferred is selected, the Language field becomes unavailable.</p> <p>If your institution did not set communication preferences to <i>Support multiple languages</i> on the Installation CC page, then the system automatically selects the Specified option and makes both the Specified and Preferred options unavailable. You must specify the language to use.</p>

Communication Method Usage

Select options in this group box and in the Communication Language Usage group box, to identify the template for the Communication Generation process to use.

Field or Control	Description
Specified and Method, or Preferred	<p>The system selects the Specified option by default and sets the Method field to <i>Letter</i>. You can change the specified method, however the Template List group box for the main letter code must include a template that uses the method that you specify.</p> <p>If your institution supports method preferences, you can select Preferred to cause the system to evaluate and use the preferred method of each ID. When Preferred is selected, the Method field is unavailable.</p> <p>If your institution did not set communication preferences to <i>Support multiple methods</i> on the Installation CC page, then the system automatically selects the Specified option and makes both the Specified and Preferred options unavailable. You must specify the method to use.</p>

Entering Process Parameters

Access the Process Parameters page (**Campus Community > Communications > Communication Generation > Process Parameters**).

This example illustrates the fields and controls on the Process Parameters page. You can find definitions for the fields and controls later on this page.

Selection Parameters	Process Parameters	Email Parameters	Checklist Parameters
Run Control ID: 1		Report Manager	Process Monitor
<input type="button" value="Run"/>			
Usage Tables		Communication Processing Dates	
Person Communication Usage		Communication Date Range Selection	
Address: <input type="text" value="Land Address and Email Address"/>		*From Date: <input type="text" value="26/03/2013"/>	
Address Name: <input type="text" value="Oth, Ftr, Deg, Pri, Mdn, Mtr"/>		*To Date: <input type="text" value="26/03/2013"/>	
Salutation: <input type="text" value="Pref First, Prim First"/>		Update Communication Generation Date With	
Extra Name: <input type="text" value="Primary Full"/>		<input type="radio"/> Communication Date	
<input checked="" type="checkbox"/> Use Preferred Email Address		<input checked="" type="radio"/> System Date	
Joint Salutation Usage		<input type="radio"/> User Supplied Date	
Joint Name: <input type="text" value="Preferred, Formal, Primary"/>		Update Communication Completed Date With	
Org Communication Usage		<input type="radio"/> Communication Date	
Org Recipient: <input type="text"/>		<input checked="" type="radio"/> System Date	
Contact Name: <input type="text"/>		<input type="radio"/> User Supplied Date	
Output Settings			
*Sort Option: <input type="text" value="Country, Postal"/>			
<input type="checkbox"/> Online Preview			
<input type="checkbox"/> Send to Printer			
<input type="checkbox"/> Send to File			
<input type="checkbox"/> Create Envelopes			
<input type="checkbox"/> Create Labels			
Missing Critical Data			
<input checked="" type="checkbox"/> Produce Communication		<input checked="" type="checkbox"/> Complete Communication	

Person Communication Usage

Fields in this group box are available for input only if the **ID Selection** field on the Selection Parameters page is set to *All IDs*, *All Person IDs*, *One Person ID*, or *Population Selection*.

If the field is available, you must enter the usage to use for searching for data for that field.

Field or Control	Description
Address	<p>Enter the type of address, from the Address Usage page, to extract for this communication. You can list address types in a preferred search-and-use order. For example, if you list an address usage that contains mailing, billing, and home address types, the system searches for the mailing address first; if none exists, then for the billing address; if none exists, for the home address last.</p> <hr/> <p>Warning! If the Communication Generation process encounters IDs that are set to receive an email but the address usage does not include email types, the process cannot send the email and therefore will not generate the communication for those IDs. When the method selected on the Selection Parameters page is <i>Email</i> or <i>Preferred</i>, then the address usage must include email types or a combination of address types and email types; at least one template for the main letter code must be for emails.</p>
Address Name	<p>Enter the type of name, from the Name Usage page, to extract for the address section of this letter. As with addresses, you can list address name types in a preferred search-and-use order.</p>
Salutation	<p>Enter the type of name, from the Name Usage Table page, that the system should extract for use in the opening or salutation of this communication. For example, you might want to use the individual's primary full name in the address section of the letter, but use his preferred first name in the salutation (Dear Dave). As with addresses, you can list salutation name types in a preferred search-and-use order.</p>
Extra Name	<p>The extra name is an additional way to extract name data using the name usage. For example, you might want to use the individual's primary full name in the address section of the letter (Mr. Juan M. Dominguez), his preferred first name in the salutation (Dear Juan), and his last name in the text to say "We are sure the Dominguez family will enjoy participating in this event." As with addresses, you can list ID name types in a preferred search-and-use order.</p>
Use Preferred Email Address	<p>Select this check box to use the preferred email address (as indicated on the Electronic Addresses page) for this communication.</p>

Joint Salutation Usage

The **Joint Name** field is available for input only if the **ID Selection** field on the Selection Parameters page is set to *All IDs*, *All Person IDs*, *One Person ID*, or *Population Selection*, and only if the letter code is set to permit joint communications. The available **Joint Name** values are applicable values from the Name Usage Table.

If the field is available, you must enter the name type to use in the salutation for joint communications.

Org Communication Usage

Fields in this group box are available for input only if the **ID Selection** field on the Selection Parameters page is set to *All IDs*, *All Org IDs*, *One Org ID*, or *Population Selection*.

If the field is available, you must enter the usage to use for searching for data for that field.

Field or Control	Description
Org Recipient	Enter the usage for the process to evaluate. The process evaluates this usage to find and retrieve the recipients to use for the organization communication.
Contact Name	Enter the usage for the process to evaluate. The process evaluates this usage to find and the name type to use in the output for each organization recipient contact.

See [Defining Organization Communication Recipient Usages](#).

Communication Date Range Selection

Enter the date range of the communication records from which to extract data. For example, you might want to extract data only from IDs to which you assigned a specific letter code and set the communication date to between January 1 and March 1 of the current year.

The **From** and **To** date ranges are inclusive of the dates that you enter.

Update Communication Generation Date With

Select the date to use as the date when the communication is generated. When the Communication Generation process finishes, it enters this date in the **Communication Generation Date** field in the Communication Management component for persons or organizations as appropriate.

Field or Control	Description
Communication Date	Select to use the communication assignment date from the Person Communication page for individuals or the Organization Communication page for organizations, to use as the date of generation.

Field or Control	Description
System Date	Select to extract the current system date to use as the date of generation.
User Supplied Date	Select to use the specified date as the date of generation. You must supply the desired date.

Update Communication Completed Date With

Select the date for the system to use as the communication completed date on the communication record.

Field or Control	Description
Communication Date	Select to use the date when the communication was assigned as the communication completed date.
System Date	Select to use the current system date as the communication completed date.
User Supplied Date	Select to use the specified date as the communication completed date. You must supply the desired date.

Output Settings

Specify how to sort the generated outputs. You can choose to preview a sample of the outputs before running the process, or if the communication is a letter, you can choose to send the output directly to the printer for printing.

Warning! If you do not select either **Preview Online** or **Send to Printer**, when the process runs it generates the communication. If, in the Standard Letter Table CS component, **Letter Printed Data** is set to either *Name/Address Only* or *All* for the letter code, then the process saves the data indicated and inserts the **View Generated Communication** link in the Person or Organization Communication Management components. You must manually navigate to the Communication Management component for each of the processed IDs to view or print the final outputs individually. If the **Letter Printed Data** is set to *None* for the letter code, the process generates the communications, but does not save data or make the output retrievable. If the communication is an email, the process sends the email to the specified IDs.

Field or Control	Description
<p>Sort Option</p>	<p>Enter how to sort the generated outputs.</p> <p>Available options are:</p> <p><i>All Alphabetically by ID Type</i> to sort first, organization communications sorted alphabetically by the first letter of each recipient's name, contact, department, or location name depending on how the output is addressed, and then individual communications alphabetically by each recipient's last name/ first name.</p> <p><i>Country, Postal</i> (default value) to sort by each recipient's postal or zip code. Use this sort option to streamline mass mailings sent through the postal service.</p> <p><i>Country, Postal by ID Type</i> to sort first, organization communications by each recipient's country and postal address, and then individual communications by each recipient's country and postal address.</p>
<p>Online Preview</p>	<p>Select to preview the output online in PeopleSoft Report Manager.</p> <p>When selected, the system sends a sample of all related outputs to PeopleSoft Report Manager with corresponding links for you to click to preview each output. For example, if an ID has two enclosures and three communication recipients, Report Manager displays a total of 12 document links labeled with the report definition name for each letter code and the name of each recipient. One document link is for the main letter code output and two links are for the enclosures associated with the main ID. The same links appear for each of the three recipients.</p> <hr/> <p>Note: Previews do not cause communications to be marked <i>Completed</i> and no information is entered in the Person or Organization Communication Management components for the communication.</p> <p>When generating communications for multiple IDs, the online preview functionality extracts data for previews of only the first 10 IDs and their enclosures and recipients.</p> <hr/>

Field or Control	Description
<p>Email Address</p>	<p>If the communication method usage is either <i>Email</i> or <i>Preferred</i> on the Selection Parameters page and the <i>Online Preview</i> check box is selected, then the Email Address field appears.</p> <p>Enter an email address whose inbox you can access to see how the emails will be sent. When you provide an email address for online previewing, the generated outputs do not appear in the PeopleSoft Report Manager.</p> <p>Continuing with the example from the Online Preview field, the email address that you enter will receive four different emails: one for the main ID and one for each of the three recipients. The enclosures will be attachments to the emails. If an email is missing for a specific recipient, it is probably because no email address exists in the Related ID (or Name) field in the Relationships component.</p> <hr/> <p>Note: The Communication Generation process uses the main letter code template as the body of the email text. To do so, the process automatically converts the format of the main letter template to HTM format. Enclosures, if assigned, are not converted. The process includes them as attachments using the default output format set in the report definition.</p> <hr/> <p>See Entering Relationship Addresses.</p> <p>See <i>PeopleTools: Process Scheduler</i>, "Using Report Manager."</p>

Field or Control	Description
Send to Printer and Destination Printer	<p>If the communication method usage is either <i>Letter</i> or <i>Preferred</i> on the Selection Parameters page, then the <i>Send to Printer</i> option is available.</p> <p>Select the check box to send letter communications directly to the printer. When selected, the Destination Printer field appears. You must enter the path to the printer.</p> <p>When you are generating letters, you can retrieve the output at the specified printer or by clicking the View Generated Communication link in each processed ID's Person or Organization Communication component (if the letter code is set to save the data to the communication record), or both.</p> <hr/> <p>Note: If, on the Selection Parameters page, the communication method usage is <i>Email</i> or the Online Preview check box is selected, then the Send to Printer option is unavailable. You cannot send an email to the printer, nor can you send communications set to Online Preview to the printer.</p> <hr/> <p>See Setting Up a Letter Code.</p> <p>See <i>PeopleTools: BI Publisher for PeopleSoft</i></p>

Field or Control	Description
<p>Send to File and File Path</p>	<p>If the communication method usage is either <i>Letter</i> or <i>Preferred</i> on the Selection Parameters page, then the <i>Send to File</i> option is available.</p> <p>Select the check box to save the generated letter communications as a single file. When selected, the File Path field appears. You must specify the file path to use.</p> <p>When the process runs, it sorts and merges all the final letters into one file and saves it to the file path that you entered. The filename is <i>CommGen_<process instance nbr>.pdf</i>, where <i><process instance nbr></i> is the unique process instance number assigned by the Communication Generation process for that run.</p> <p>You can use the file to make last-minute changes to the communications or send to a third-party vendor such as a mailing company.</p> <hr/> <p>Note: If, on the Selection Parameters page, the communication method usage is <i>Email</i> or the <i>Online Preview</i> check box is selected, then the <i>Send to File</i> option is unavailable. You cannot save an email to a file, nor can you save communications set to <i>Online Preview</i> to a file.</p> <hr/> <p>When you are generating letters, you can retrieve the output from the file at the destination you specify or by clicking the View Generated Communication link in each processed ID's Person or Organization Communication component (if the letter code is set to save the data to the communication record), or both.</p> <hr/> <p>Note: The file created is a .pdf file regardless of the format type defined in the report definition associated with the letter code.</p> <hr/> <p>See Setting Up a Letter Code.</p> <p>See <i>PeopleTools: BI Publisher for PeopleSoft</i>.</p>

Field or Control	Description
<p>Create Envelopes, Create Labels and Report Name</p>	<p>If the communication method usage is either <i>Letter</i> or <i>Preferred</i> on the Selection Parameters page, then the <i>Create Envelopes</i> and <i>Create Labels</i> options are available.</p> <p>Select the appropriate check box to generate envelopes or address labels for the letter communications.</p> <p>When selected, the Report Name link appears. You must select the report definition for the Communication Generation process to use. The report definition enables the process to retrieve address information from the associated data source to merge into the appropriate envelope or label template.</p> <p>Only the report definitions that are created with a data source configured with the same administrative function used in the main letter code are available. For example, if the main letter code has a data source configured for the ADMA administrative function, then only the report definitions created with a data source set up for administrative function ADMA are available for envelopes and labels.</p> <hr/> <p>Warning! The Communication Generation process does not re-extract data for envelopes and labels. It reuses the data extracted for the main letter code report definition to merge inside the envelope or label template. This ensures consistency between the address, the salutation information printed on the letter, and the name and address on the envelopes and labels. If you need to extract additional data to include on the envelopes or labels (for example, you might want to print the name of the admissions recruiting center for the ID on the envelope or label), then you must include the data inside the data source of the report definition for the main letter code. If the data is not in the data source for that report definition, it will not be extracted.</p> <hr/> <p>When the <i>Send to File</i> option is selected and you select <i>Create Envelopes</i> or <i>Create Labels</i>, the process sorts and merges all the address data into one file and saves it to the file path that you entered. The process applies the salutation, address, and sort order specified for the main letter to the corresponding envelopes and labels.</p> <p>The filename for envelopes is <i>CommGenENV_<process instance nbr>.pdf</i> and the filename for labels data is <i>CommGenLBL_<process instance nbr>.pdf</i>, where <i><process instance nbr></i> is the unique process instance number assigned by the Communication Generation process for that run.</p>

Field or Control	Description
	<p>Note: When <i>Send to File</i> is selected, the file format is always .pdf regardless of the format type defined in the Report Definition used for generating the labels or envelopes</p> <hr/> <p>When the letter code is set to save data to the communication record and the <i>Create Envelopes</i> option is selected, the Communication Generation process saves the respective envelope inside each processed ID's Person or Organization Communication Management component. Click the View Generated Communication link, and then the View Envelope link to view and reprint the envelope if needed.</p> <p>See Setting Up a Letter Code.</p> <p>See Assigning Communications.</p> <hr/> <p>Note: The <i>Create Labels</i> option does not make the generated label available inside the Person or Organization Communication Management component for the IDs processed. Use the <i>Create Envelopes</i> option to recreate the label if needed.</p>
Envelope Printer and Label Printer	<p>If the <i>Send to Printer</i> check box is selected and you select the <i>Create Envelopes</i> or <i>Create Labels</i> options, the Envelope Printer or Label Printer field appears. Enter the path to the printer that is set up to print envelopes or to the printer that is set up to print labels.</p>

Report Definitions for labels and envelopes must use the same administrative function as the administrative function associated with the main letter code. Consider creating report definitions and data sources for each administrative function that you use. The following table provides an example of delivered elements for labels and envelopes for three sample administrative functions.

Admin Function	Data Source	Label Template	Envelope Template	Label Report Definition	Envelope Report Definition
ADMA	QA_CS_LBLENV_ADMA	QA_CS_CC_LABEL.rtf	QA_CS_CC_ENVELOPE.rtf	QA_CSLBLADMA	QA_CSENVADMA
AVIN	QA_CS_LBLENV_AVIN	QA_CS_CC_LABEL.rtf	QA_CS_CC_ENVELOPE.rtf	QA_CSLBLAVIN	QA_CSENVAVIN
GEN	QA_CS_LBLENV_GEN	QA_CS_CC_LABEL.rtf	QA_CS_CC_ENVELOPE.rtf	QA_CSLBLGEN	QA_CSENVGEN

See [Creating a Data Source File](#).

See *PeopleTools: BI Publisher for PeopleSoft*, "Creating Report Templates."

Warning! When generating letters, you must select either *Send to File* or *Send to Printer* to ensure the ability to retrieve and view the letter outputs. If you do not select either *Send to File* or *Send to Printer*, you must manually navigate to each processed ID's communication component to retrieve and view the output. However, the output is in the communication record only if the assigned letter code is set to save it there.

For emails, the process automatically sends the generated communication to each processed ID. You cannot retrieve and view an email output before sending. You can however, select *Send to File* or *Send to Printer* to retrieve and view the email that was sent.

See [Setting Up a Letter Code](#).

Missing Critical Data

<i>Field or Control</i>	<i>Description</i>
Produce Communication	Select this check box for the process to produce the communication even if critical data is missing, for example, even if address information or name of the recipient is missing.
Complete Communication	<p>Select this check box for the process to set the status to <i>Complete</i> on the communication record, even if critical data is missing.</p> <p>Critical data is set in the Communication Data Source component.</p> <hr/> <p>Note: If Email Address for Person for individuals or Organization Recipient Email and URL information for organizations, is not marked as critical data, the process considers the email address to be critical data for generating an email.</p> <hr/> <p>See Creating a Data Source File.</p>

Entering Email Parameters

Access the Email Parameters page (**Campus Community > Communications > Communication Generation > Process Parameters**).

Field or Control	Description
From	<p>Enter the email address of the person or entity that is sending the email.</p> <p>This email address will replace any default email address that your institution's server might use to indicate from whom an email was sent. You can use this for cosmetic appearance. For example, if the Registrar Office sends the email, you might enter <i>Registrar_Office@university.com</i>. The email address may be valid or not. If it is not, your template should include text similar to: <i>This email was sent by an automated system. Do not reply to this email address.</i></p> <p>This field is required if the communication method usage is <i>Specific Email</i> or <i>Preferred</i>.</p>
Subject	<p>You can enter email subjects for each email template language encountered on the Template Selection group box on the Selection Parameters page.</p> <p>If the Communication Language Usage option is set to <i>Preferred</i> on the Selection Parameters page then the system generates subject fields for each email template language encountered in the Template Selection group box. If zero or one email template is found, or if the Communication Language Usage option is set to <i>Specific</i>, then a single Subject field appears on this page.</p> <p>All Subject fields require a value when the Communication Language Usage option is set to <i>Preferred</i> and the Communication Method Usage option is set to either <i>Preferred</i> or <i>Email Specific</i>.</p> <p>When you click the Run button, the Communication Generation process (SCC_COMMGEN) retrieves the appropriate subject field from the SCC_CG_EML_RCTL table based on the email template language used to generate the communication.</p>
Reply to, Sender, and Bounce to	<p>(Optional) Enter values if your institution's email service uses these fields when sending emails.</p> <p>The Reply to email address must be valid. This is the email address that will appear when the recipient replies to the sender. It overrides the From email address.</p> <p>The Bounce To address is a valid email address set to receive all emails that do not send successfully.</p>

Importance and Sensitivity

Options that you select in these group boxes appear in the email transmission for the recipient to see.

Entering Checklist Parameters

Access the Checklist Parameters page (**Campus Community > Communications > Communication Generation > Email Parameters**).

This example illustrates the fields and controls on the Checklist Parameters page. You can find definitions for the fields and controls later on this page.

Selection Parameters
Process Parameters
Email Parameters
Checklist Parameters

Run Control ID: CG4
[Report Manager](#) [Process Monitor](#)
Run

Checklist Item Selection
Find | View All
First ◀ 1 of 1 ▶ Last

***Administrative Function:**

ADMP

🔍
Admissions Program
+ -

Checklist Context

Checklist Type
 Tracking Group
 Checklist Code

Checklist Type
Find | View All
First ◀ 1 of 1 ▶ Last

***Checklist Type**

Requirements List

+ -

Checklist Code
Find | View All
First ◀ 1 of 1 ▶ Last

*Checklist Code	Description	Institution
UGRALL	UG Appl Requirements - All	PSUNV

+ -

Checklist Code Status
Find | View All
First ◀ 1 of 1 ▶ Last

***Checklist Status**

Initiated

+ -

Checklist Item Status
Find | View All
First ◀ 1 of 1 ▶ Last

***Item Status**

Initiated

+ -

Checklist Item Selection

<i>Field or Control</i>	<i>Description</i>
Administrative Function	<p>Enter the administrative function associated with the checklists to use.</p> <p>If the checklists that you want to use are associated with different administrative functions, use the add button to enter each administrative function and select the checklists and items associated with that function.</p>

Checklist Context

<i>Field or Control</i>	<i>Description</i>
Checklist Type, Tracking Group, or Checklist Code	<p>Select the context by which to select the checklists to extract.</p> <p>The fields on the page change based on the checklist context that you select.</p>

Checklist Type

This group box appears regardless of which context you select.

<i>Field or Control</i>	<i>Description</i>
Checklist Type	<p>Enter the types of checklists from which the process should extract data for this letter or email.</p> <p>You can select more than one checklist type for an administrative function. For example if you select <i>Requirement List</i>, the process extracts checklist information for checklist codes set up with that checklist type.</p>

Checklist Code and Checklist Code Status

This group box appears only if you select a **Checklist Context** of *Checklist Code*.

If you select *Checklist Code*, then you must select a checklist status to use. The process will include only checklist codes with the status that you specify. You can select more than one checklist code for an administrative function and more than one checklist status for each checklist code.

Field or Control	Description
Institution	Enter the institution related to the desired checklist. Often the same checklist codes are shared by more than one institution, and the system needs to use the correct one.
Checklist Code	Enter the specific checklist codes whose checklist item data should be extracted for this letter or email. You can specify more than one checklist code.
Checklist Status	Select the status of the checklists from which to extract data for this letter or email. You can select either the status of <i>Completed</i> or <i>Initiated</i> , or you can add a row to list both.

Tracking Group and Tracking Group Status

This group box appears only if you select a **Checklist Context** of *Tracking Group*.

If you select *Tracking Group*, then you must select a group status to use. The process will include checklist items assigned to the tracking group and tracking group status that you specify. You can select more than one tracking group for an administrative function and more than one group status for each tracking group.

Field or Control	Description
Tracking Group	Enter the tracking group codes whose checklist item data should be extracted for this letter or email. You can enter more than one tracking group for an administrative function.
Group Status	Select the group status from which to extract checklist data for this letter or email. You can select <i>Completed</i> or <i>Initiated</i> , or you can add a row to select both.

Checklist Item Status

Regardless of the context that you select, you must specify the checklist item status to use. You can select more than one checklist item status for an administrative function.

Available checklist item status values include: *Completed*, *Waived*, *Notified*, *Second Notification*, and so on.

See [Understanding Checklist Setup](#).

Resetting Generated Communications

Important! Letter Generation (Letter Gen) is a deprecated product. It is strongly recommended that you use Communication Generation (Comm Gen) instead. For more information on Comm Gen, see [Understanding the Communication Generation Process](#)

A successful run of the Communication Generation or Letter Generation process updates the following items on the communication record for each processed ID:

- **Communication Generation Datefield.**
- **Communication Completed** option.
- **Date Activity Completed** field.
- **Unsuccessful Outcome** option with its **Reason** field.
- **Language, Method, and Process Used** fields.
- **View Generated Communication** link (only for Communication Generation process and if setup allows it).

When the items are updated, the process sets the communication to *Communication Completed*, and neither the Communication Generation process nor the Letter Generation process will process that ID again for that communication.

If you need to generate the communication again or reset the fields (for example, if you mistakenly used the wrong template or selected the wrong IDs to process), then you must either manually navigate to each processed ID's Person or Organization Communication Management component and clear the **Communication Completed** check box, or use the Reset Communications page to reset the communication.

You can specify which of the processed IDs to reset: *All IDs*, *All Person IDs*, *All Org IDs*, *One Person ID*, or *One Org ID*.

Resetting clears the information from the communication record, refreshes the processing tables, and deletes from the XML storage tables. The Letter Generation process does not use processing tables that need to be refreshed.

Note: You must run reset the communication to refresh the processing tables if the Communication Generation process ends abnormally.

Page Used to Reset Generated Communications

<i>Page Name</i>	<i>Definition Name</i>	<i>Navigation</i>	<i>Usage</i>
Reset Communication	SCC_CG_RESET	<ul style="list-style-type: none"> • Campus Community > Communications > Reset Communication • Contributor Relations > Communications > Process Communications > Reset Communication • Contributor Relations > Session Management > Acknowledgements > Generate Acknowledgements > Reset Communication 	<p>Reset the communications generated by the Communication Generation process or the Letter Generation process by clearing the Communication Completed check box and resetting the other values populated by the processes.</p> <p>Also reset the Communication Generation process tables if the process ended abnormally.</p>

Resetting a Communication

Access the Reset Communication page (**Campus Community > Communications > Reset Communication**).

<i>Field or Control</i>	<i>Description</i>
Process instance, Run Date/Time, and Run Status	<p>Select the process instance number for which you want to reset a generated communication.</p> <p>Process instance numbers are available only for a process run status of <i>Success</i>, <i>No Success</i>, <i>Warning</i>, <i>Delete</i>, <i>Error</i>, or <i>Cancelled</i>.</p> <p>When the process instance number has a run status of <i>Success</i>, the Reset Communication process clears all process information that the Communication Generation process or the Letter Generation process added to the communication record for each processed ID.</p> <p>When the process instance number has a run status of <i>No Success</i>, <i>Warning</i>, <i>Delete</i>, <i>Error</i>, or <i>Cancelled</i>, the Reset Communication process clears all of the processing tables, so that you can run the process to generate the communication again.</p>

Field or Control	Description
ID Selection, Person ID, and Org ID	<p>Specify which IDs within the process instance to reset. Only the IDs generated in the specified process instance are available.</p> <ul style="list-style-type: none"> • Enter <i>All IDs</i> to reset all of the processed IDs. • Enter <i>All Person IDs</i> or <i>All Org IDs</i> to reset all of the person IDs or all of the organization IDs that were processed. • If you enter <i>One Person ID</i> or <i>One Org ID</i>, the Person ID or the Org ID field appears. You must enter the ID.

Click the **Run** button to invoke the SCC_CG_RESET Application Engine process. The system does the following:

1. Clears rows in the process tables that were used for the specific Communication Generation run.

The process tables are: SCC_COMMGEN_AET, SCC_CG_PRCS_AET, SCC_CG_MERG_TBL, SCC_CG_PRCS_TBL and SCC_CG_TRGT.

2. Identifies the communications to reset based on the ID Selection drop-down list box on the run control page.
3. For each communication identified in step 2, deletes from the XML storage tables (SCC_CG_ATTDET, SCC_CGR_ATTREL, SCC_ORG_CTC_ATT, SCC_ORG_DPT_ATT and SCC_ORG_LOC_ATT).
4. For each communication identified in step 2, updates the process-related fields on the PS_COMMUNICATION table:
 - COMPLETED_COMM='N'
 - COMPLETED_ID=' '
 - COMPLETED_DT =%DateNull
 - UNSUCCESSFUL='N'
 - OUTCOME_REASON=' '
 - LETTER_PRINTED_DT=%DateNull
 - PROCESS_INSTANCE=0
 - SCC_COMM_MTHD=' '
 - SCC_COMM_LANG=' '
 - SCC_COMM_PROC=' '

Reviewing Communications

Important! Letter Generation (Letter Gen) is a deprecated product. It is strongly recommended that you use Communication Generation (Comm Gen) instead. For more information on Comm Gen, see [Understanding the Communication Generation Process](#)

This section discusses how to:

- Review extract data for a communication.
- Review extract data for an additional individual recipient.
- Review a summary of communications.
- Review 3C Group access to a communication.
- Review details of a communication.

Pages Used to Review Communications

<i>Page Name</i>	<i>Definition Name</i>	<i>Navigation</i>	<i>Usage</i>
Communication Letter Data	COMM_LTR_DATA	Campus Community > Communications > Person Communications > Communication Letter Data	Review extract data for a communication assigned to an individual. This page can only be updated by Letter Generation extract process.
Organization Communication Letter Data	ORGCOMM_LTR_DATA	Campus Community > Communications > Organization Communications > Org Communication Letter Data > Communication Letter Data	Review extract data for a communication assigned to an organization. This page can only be updated by Letter Generation extract process.

Page Name	Definition Name	Navigation	Usage
<p>Communication Recipient Data</p>	<p>COMM_RECPT_DATA</p>	<ul style="list-style-type: none"> • Campus Community > Communications > Person Communications > Communication Letter Data > Communication Recipient Data • Campus Community > Communications > Person Communications > Communication Management > Communication Recipient Data • Contributor Relations > Communications > Communications - Person > Communication Letter Data > Communication Recipient Data • Contributor Relations > Constituent Information > People > Communications > Communication Letter Data > Communication Recipient Data • Contributor Relations > Constituent Information > People > Communications > Communication Management > Communication Recipient Data • Contributor Relations > Communications > Communications - Person > Communication Management > 	<p>View data for an additional individual recipient.</p>

Page Name	Definition Name	Navigation	Usage
		<p>Communication Recipient Data</p>	
<p>Communication Summary</p>	<p>COMM_SUMMARY</p>	<ul style="list-style-type: none"> • Campus Community > Communications > Person Communications > Communication Summary • Student Admissions > 3 C's and Event Summaries > Communication Summary • Student Recruiting > 3 C's and Events Summaries > Communication Summary • Contributor Relations > Communications > Communications - Person > Communication Summary • Contributor Relations > Constituent Information > People > Communications > Communication Summary • Self Service > Outreach > View person information > Constituent Information > Communication Summary • Records and Enrollment > 3 C's Summaries > Communication Summary • Student Recruiting > Student Recruiters > Summaries > Communication Summary 	<p>Search for and review a summary of communications to or from an individual.</p>

Page Name	Definition Name	Navigation	Usage
Org Communication Summary	ORG_COMM_SUMMARY	<ul style="list-style-type: none"> • Campus Community > Communications > Organization Communications > Org Communication Summary • Contributor Relations > Communications > Communications - Organization > Communication Summary - Org > Org Communication Summary • Contributor Relations > Constituent Information > Organizations > Communications > Org Communication Summary • Self Service > Outreach > View Organization Information > Constituent Information - Org > Communication Summary 	Review communications with an organization.
Operator 3C Groups Summary	OPR_GRP_3C_SUM	<ul style="list-style-type: none"> • Campus Community > Communications > Person Communications > Communication Summary > Operator 3C Groups Summary • Campus Community > Communications > Organization Communications > Org Communication Summary > Operator 3C Groups Summary 	View 3C group inquiry and update access to communications with individuals or organizations.

Page Name	Definition Name	Navigation	Usage
Person Communication Management	COMM_MGMT1	Campus Community > Communications > Person Communications > Communication Detail > Communication Detail	View details of a communication assigned to an individual.
Org Communication Detail	ORG_COMM_MGMT1	Campus Community > Communications > Organization Communications > Org Communication Detail	View the details of a communication assigned to an organization.
Organization Comm Recipients	ORG_COMM_MGMT2	<ul style="list-style-type: none"> • Campus Community > Communications > Organization Communications > Org Communication Detail > Organization Comm Recipients • Contributor Relations, Constituent Information, Organizations, Communications, Organization Communication • Contributor Relation > Communications > Communications - Organization > Organization Communication 	View the details of the recipients set to receive a communication that is assigned to an organization.

Reviewing Extract Data for a Communication

Access the Communication Letter Data page (**Campus Community > Communications > Person Communications > Communication Letter Data**) or the Organization Communication Letter Data page (**Campus Community > Communications > Organization Communications > Org Communication Letter Data > Communication Letter Data**).

The Communication Letter Data page and the Organization Communication Letter Data page are for viewing purposes only; you cannot enter or modify data. Information on this page is controlled from the Letter Printed Data value set in the Standard Letter Table CS component. Use this page to review the data extracted for an ID as the result of the Letter Generation process.

Note: The Communication Generation process does not update the page. Instead it makes the final outputs accessible from **View Generated Communication** link in the Person and Organization Communication components.

Reviewing Extract Data for an Additional Individual Recipient

Access the Communication Recipient Data page (**Campus Community > Communications > Person Communications > Communication Letter Data > Communication Recipient Data**).

The Communication Recipient Data page is view-only; you cannot enter or modify data. Information appears on this page only if you have set up a separate recipient on the Communication Recipient page in the Relationships component for the specified letter code. The page is updated by both Letter Generation and Communication Generation process.

Reviewing a Summary of Communications

Access the Communication Summary page (**Student Admissions > 3C's and Event Summaries > Communication Summary**) or the Org Communication Summary page (**Campus Community > Communications > Organization Communications > Org Communication Summary**).

Note: Multiple views of the page are available by clicking the tabs in the group box. We document fields that are common to all views first.

Common Page Information: Selection Criteria Region

If you click the **Search** button without entering any values, the system searches for all communications for the individual or organization and displays the results at the bottom of the page. You can enter values or any combination of values to limit the search.

<i>Field or Control</i>	<i>Description</i>
Function	Enter the administrative area on which to search.
Variable Data	Click to access the Variable Data page, where you can add values to search on for specific variable data related to the administrative function that you selected. If no variable data is required or allowed for the administrative function selected, the Variable Data link is unavailable.
Category	Enter the category from the Communication Categories page, for which to search.
Method	Enter the method from the Communication Contexts page, for which to search.
Direction	Enter the direction from the Communication Contexts page, for which to search.
Letter Code	Enter the letter code from the Standard Letters Table page, for which to search.

Field or Control	Description
Status	<p>Enter the status of the communications for which to search.</p> <p>Available values are:</p> <p><i>All</i>: The system searches for all communications regardless of status.</p> <p><i>Complete</i>: The system searches only for completed communications.</p> <p><i>Incomplete</i>: The system searches only for incomplete communications.</p>
Search	Click to launch the search based on the criteria you selected.

General Info Tab

For the Organization Summary page, the **Process Used** field indicates if the recipient's information is in the **Recipients - Letter Gen Process** or the **Recipients - Comm Gen Process** tab.

Click the trash can icon to delete any communication from the recipient's record. The icon appears under these conditions:

- The system is configured, on the Installation Default - CC page, to allow individual communication deletion.
- 3C Group Security allows the user to access the particular records.

See [Deleting Individual Communications](#).

Letter Details Tab

Use the Letter Details tab to determine if supplemental information is provided about the communication, such as enclosure letter codes and descriptions if enclosures were included, the related ID if the communication was joint, and the category and context for the communication.

Note: A joint communication can be assigned to only one of the two individual IDs. However, when a joint communication is assigned, the communication is listed in the summary for both IDs. For example, if you assign a joint communication to primary ID 12345 with the related ID 13578 and you view the summary for ID 12345, the joint communication check box is selected and no related ID value appears. When you view the summary for (related) ID 13578, however, the joint communication check box is selected and the related ID of 12345 appears.

Reviewing 3C Group Access to a Communication

Access the Operator 3C Groups Summary page (**Campus Community > Communications > Person Communications > Communication Summary > Operator 3C Groups Summary** or **Campus**

Community > Communications > Person Communications > Communication Summary > Operator 3C Groups Summary).

You can review the inquiry and update access of the 3C groups that have access to the communication, and you can change the inquiry access for a group on this page. You cannot change the update access.

Reviewing Details of a Communication

The Communication Detail and Org Communication Detail pages are view-only versions of the Person Communication Management and Organization Communication pages where you assign the communications. You can view the details of an assigned communication on these pages, but you cannot enter or edit the data.

Related Links

[Assigning Communications](#)

Using the Envelope and Label Generation Process

Important! Letter Generation (Letter Gen) is a deprecated product. It is strongly recommended that you use Communication Generation (Comm Gen) instead. For more information on Comm Gen, see [Understanding the Communication Generation Process](#)

This section provides an overview of the Envelope and Label Generation (SCC_CGLABELS) process, and discusses how to:

- Enter selection parameters.
- Enter process parameters.

Understanding the Envelope and Label Generation Process

Use the Envelope and Label Generation process (SCC_CGLABELS) to generate envelopes and labels for a communication previously generated by the Communication Generation process (SCC_COMMGEN) (or for envelopes and labels previously generated by the Envelope and Label Generation process if you are rerunning them) or for a hardcopy communication that does not have a template in your PeopleSoft system, such as a brochure, flyer, post card, and so on.

For communications previously generated by the Communication Generation process, you can use the process to rerun the envelopes without having to reset and regenerate the full communication. Use the Communication Generation process instance number to ensure consistency in the name, address, and salutation data between the letter and the envelope or label.

For hardcopy communications, use the process to generate envelopes or labels for a specific set of IDs without extracting more data than required for an envelope or label (usually name and address data).

Note: You can use the Letter Generation process to generate labels and envelopes for hardcopy communications, but the process extracts all of the data that it would extract for a letter.

Warning! IDs that have a communication set to *Completed* either manually or by the Letter Generation process are not recognized by the Envelope and Label Generation process. The process recognizes and processes only communications completed by the Communication Generation process or the Envelope and Label Generation process.

Pages Used for the Envelope and Label Generation Process

Page Name	Definition Name	Navigation	Usage
Selection Parameters	SCC_CG_RUN_ENVLBL1	<ul style="list-style-type: none"> • Campus Community > Communications > Set Up Communications > Envelope and Label Generation > Selection Parameters • Contributor Relations > Session Management > Acknowledgements > Generate Acknowledgements > Selection Parameters • Contributor Relations > Communications > Process Communications > Selection Parameters 	Specify general parameters for extracting name and address data for envelopes and labels.
Process Parameters	SCC_CG_RUNCTL2	<ul style="list-style-type: none"> • Campus Community > Communications > Set Up Communications > Envelope and Label Generation > Process Parameters • Contributor Relations > Session Management > Acknowledgements > Generate Acknowledgements > Process Parameters • Contributor Relations > Communications > Process Communications > Process Parameters 	Specify usages and dates for the Envelope and Label Generation process to use, identify how the process is to handle missing critical data, and specify where the process is to place and sort the outputs.

Entering Selection Parameters

Access the Selection Parameters page (**Campus Community > Communications > Set Up Communications > Envelope and Label Generation > Process Parameters**).

This example illustrates the fields and controls on the Selection Parameters page. You can find definitions for the fields and controls later on this page.

The screenshot shows the 'Selection Parameters' page with the following sections:

- Run Control ID:** AD. Includes links for [Report Manager](#), [Process Monitor](#), and a **Run** button.
- Communication Selection:**
 - Process Instance:** A search field.
 - 'Letter Code':** APP Appointment Mailer.
 - Communication Date Range Selection:** From Date: 12/11/2009, To Date: 12/11/2009.
- ID Selection:** ID Type: Population Selection.
- Population Selection:**
 - Selection Tool:** PS Query. Includes [Edit Prompts](#).
 - Query Name:** QA_CS_CC_PS_COMMGEN. Includes [Launch Query Manager](#) and [Preview Selection Results](#).
- Output Selection:**
 - Create Envelopes** [Report Name](#)
 - Create Labels** [Report Name](#)

Communication Selection

<i>Field or Control</i>	<i>Description</i>
Process Instance	<p>If the communication was previously generated, select the process instance for which you want to generate envelopes or labels.</p> <p>Only the process instances created by either the Communication Generation or the Envelope and Label Generation process are available to ensure that the data extracted by those processes is the same data that will be used to generate the envelopes and labels.</p> <hr/> <p>Note: The process instance number appears in the Process Instance field on the processed ID's Person Communication Management or Organization Communication Management page.</p>

Field or Control	Description
Letter Code	<p>Enter the letter code of the item for which you want to generate envelopes and labels.</p> <p>If you entered a process instance number, the letter code of the generated communication appears in the Letter Code field, and the field is unavailable.</p> <p>If the communication has not been completed, enter the letter code for which you want to generate the envelopes and labels. For example, it could be a letter code for a hardcopy item (brochure, flyer, post card, or other) for which you want to generate envelopes and labels.</p> <hr/> <p>Note: All letter codes are available, whether or not they are set up for the Communication Generation process.</p> <hr/>

Communication Date Range Selection

This group box appears only when the letter code is entered manually.

Field or Control	Description
From Date and To Date	<p>Enter the date range of the communication records from which to extract data.</p> <p>For example, you might want to extract data only from IDs to which you assigned a specific letter code and set the communication date to between January 1 and March 1 of the current year.</p>

ID Selection

Field or Control	Description
ID Type, Person ID, and Org ID	<p>Specify the types of IDs for which you want to generate envelopes and labels. The choices are: <i>All IDs</i>, <i>All Org IDs</i>, <i>All Person IDs</i>, <i>One Org ID</i>, <i>One Person ID</i>, or <i>Population Selection</i>.</p> <p>When a process instance number is entered, only the IDs processed within the process instance are available.</p> <p>When a letter code is manually entered, the only IDs available for processing are the person IDs and organization IDs with that letter code assigned within the specified date range and where the communication is not completed.</p> <p>If you enter <i>One Person ID</i> or <i>One Org ID</i>, the Person ID or the Org ID field appears. Enter the specific ID for which to generate the envelope or label.</p>

Population Selection

This group box appears only when the ID type is *Population Selection*.

Field or Control	Description
Selection Tool	<p>Select the tool to use to identify the population for the process.</p> <p>Only tools set to <i>Active</i> on the Selection Tool setup page and the applicable selection tools defined in the context definition for the process are available.</p> <p>The PeopleSoft system delivers the following tools with a default status of <i>Active</i>: <i>Equation Engine</i>, <i>External File</i>, and <i>PS Query</i>.</p>
Query Name, Equation Name, or Attached File	<p>The field appears based on the selection tool specified.</p> <p>Enter the name of the query or equation to use or upload the external file to use to select the desired population.</p>

See [Using the Population Selection Process](#).

Output Selection

<i>Field or Control</i>	<i>Description</i>
<p>Create Envelopes, Create Labels, and Report Name</p>	<p>Select the appropriate check box to generate envelopes or labels or both.</p> <p>When selected, the Report Name link appears. You must select the report definition to use. The report definition must contain the envelope or label template to use and enables the process to retrieve name address information from the associated data source to merge into the template.</p> <p>Only the report names to which you have security access are available.</p> <hr/> <p>Note: When generating envelopes and labels from within the Communication Generation process, only the report definitions that are created with a data source configured with the same administrative function used in the main letter code are available. However, when generating envelopes and labels with the Envelope and Label Generation process, the data source associated with the report definitions does not need to match the administrative function of the letter code. For example, with the Envelope and Label Generation process you can generate envelopes and labels for a letter code with the ADMA administrative function, and use a report definition with the GEN administrative function. This enables you to use a generic report definition to create envelopes and labels.</p> <hr/> <p>Warning! When a Process Instance number is entered the Envelope and Label Generation process does not re-extract data for envelopes and labels. It reuses the data extracted for the main letter code report definition to merge inside the envelope or label template. This ensures consistency between the address, the salutation information printed on the letter, and the name and address on the envelopes and labels. If you need to extract additional data to include on the envelopes or labels (for example, you might want to print the name of the admissions recruiting center for the ID on the envelope or label), then you must include the data inside the data source of the report definition for the main letter code. If the data is not in the data source for that report definition, it will not be extracted.</p>

This table lists the predefined report definitions provided for generating envelopes and labels. You can use these as is or use them as samples from which to create your own templates:

<i>Admin Function</i>	<i>Report Name</i>	<i>Report Description</i>
GEN	QA_CSENVGEN	CommGen Envelope - GEN
GEN	QA_CSLBLGEN	CommGen Label - GEN
AVIN	QA_CSENVAVIN	CommGen Envelope - AVIN
AVIN	QA_CSLBLAVIN	CommGen Label - AVIN
ADMA	QA_CSENVADMA	CommGen Envelope - ADMA
ADMA	QA_CSLBLADMA	CommGen Label - ADMA

Entering Process Parameters

Access the Process Parameters page (**Campus Community > Communications > Set Up Communications > Envelope and Label Generation > Process Parameters**).

This example illustrates the fields and controls on the Process Parameters page. You can find definitions for the fields and controls later on this page.

Selection Parameters		Process Parameters	
Run Control ID: AD		Report Manager	Process Monitor
		<input type="button" value="Run"/>	
Output Settings			
Sort Option	Country, Postal	<input checked="" type="checkbox"/> Complete Communication	
<input type="checkbox"/> Online Preview			
<input checked="" type="checkbox"/> Send to File	File Path	c:\mailingstappstmailing121109	
<input type="checkbox"/> Send to Printer			
Missing Critical Data			
<input checked="" type="checkbox"/> Produce Communication		<input checked="" type="checkbox"/> Complete Communication	
Person Communication Usage		Communication Processing Dates	
Address:	Home, Mailing, Permanent, Work	Update Communication Generation Date With	
Address Name:	Pref Full, Prim Full	<input type="radio"/> Communication Date	
Salutation Name:	Pref First, Prim Full	<input checked="" type="radio"/> System Date	
Extra Name:	Primary Full	<input type="radio"/> User Supplied Date	
Joint Salutation Usage		Update Communication Completed Date With	
Joint Name:		<input type="radio"/> Communication Date	
Org Communication Usage		<input checked="" type="radio"/> System Date	
Org Recipient:	Primary Cntc, Pri Dpt, Pri Loc	<input type="radio"/> User Supplied Date	
Contact Name:	Primary Full		

Output Settings

Field or Control	Description
<p>Sort Option</p>	<p>Enter how to sort the generated outputs. Available options are:</p> <p><i>All Alphabetically by ID Type</i> to sort organization envelopes and labels first, alphabetically by the organization description and then by the first letter of each recipient's name, contact, department, or location name depending on how the output is addressed, and then sort individual envelopes and labels alphabetically by each recipient's last name/first name.</p> <p><i>Country, Postal</i> to sort by each recipient's postal or zip code. Use this sort option to streamline mass mailings sent through the postal service. This is the default value.</p> <p><i>Country, Postal by ID Type</i> to sort organization envelopes and labels first, by each recipient's country and postal address, and then sort individual envelopes and labels by each recipient's country and postal address.</p> <p>If a process instance number is entered, this field is unavailable. The process uses the sort option from the generated communication.</p>
<p>Complete Communication</p>	<p>Select to have the Envelope and Label Generation process mark the communication <i>Completed</i> for each processed ID.</p> <p>When selected, the Envelope and Label Generation process updates the ID's communication record (Person Communication or Organization Communication page) by marking the communication Completed and displaying the View Generated Communication link. Use the link to retrieve and view the envelope output (the label output is the same as the envelope output).</p> <p>Selecting this check box is especially useful for hardcopy letter codes that you want to consider completed after the envelopes or the labels are generated.</p> <p>If a process instance is entered, the check box is cleared and unavailable for change.</p> <hr/> <p>Note: If you need to reset communications that have been marked <i>Completed</i> by the Communication Generation process or the Envelope and Label Generation process, use the Reset Communication process.</p> <hr/> <p>See Resetting Generated Communications.</p>

Field or Control	Description
<p>Online Preview</p>	<p>Select to preview the data, in envelope and label format based on the template in the specified report, online in PeopleSoft Report Manager.</p> <p>When selected, the system sends a sample of all related outputs to PeopleSoft Report Manager with corresponding links for you to click to preview each output.</p> <p>For example if you used the QA_CSXTRENV_GEN report to generate the envelopes, the system displays a QA_CSXTRENV GEN Extract Envelopes link in Report Manager. Click the link to open the .pdf file that contains the data in envelope format, for all of the processed IDs.</p> <p>If you used the QA_CSXTRLBL_GEN report to generate the labels, the system displays a QA_CSXTRLBL GEN Extract Label Definition link in Report Manager. Click the link to open the .pdf file that contains the data in label format, for all of the processed IDs.</p> <hr/> <p>Note: Previews do not cause communications to be marked Complete and no information is entered in the Person or Organization Communication Management components for the communication.</p> <p>When generating envelopes and labels for multiple IDs, the online preview functionality extracts data for previews of only the first 10 IDs and their enclosures and recipients.</p> <hr/>
<p>Send to File and File Path</p>	<p>Select to send the data, in envelope and label format based on the template in the specified report, to the destination file that you specify.</p> <p>Use the file to review the data before printing or use the file to send to a third-party such as a mailing service.</p> <hr/> <p>Note: When <i>Send to File</i> is selected, the file format is always .pdf regardless of the format type defined in the Report Definition used for generating the labels or envelopes.</p> <hr/>
<p>Send to Printer, Envelope Printer, and Label Printer</p>	<p>Select to send the data, in envelope and label format, directly to the printer that you specify.</p>

Missing Critical Data, Person Communication Usage, Joint Salutation Usage, Org Communication Usage and Communication Processing Dates

If a process instance number is entered, fields in these group boxes are unavailable. The process uses the settings from the generated communication. Otherwise fields in these group boxes are the same as described for the Process Parameters page in the Communication Generation component.

Note: While the **Salutation Name** field is most useful for generating a letter or email communication, you can also use the field to extract the name of an ID to create nametag labels. Your template might say: *Hello my name is <salutation name>* and your label printer might be set to print pages of name tags. As with addresses, you can list salutation name types in a preferred search-and-use order.

See [Using the Communication Generation Process](#).

Deleting Communications

This section provides an overview of communication deletion and discusses how to:

- Delete individual communications.
- Delete communications in batch.

Understanding Communication Deletion

The Delete Communications batch component enables you to define high-level parameters for removing communications from the system. For example, the institution might want to purge old communication records that are no longer required, or might need to correct a communications assignment made in error. You can delete entire categories, or further define the parameters by letter code or specific date ranges. Population Selection functionality enables you to target specific subsets of IDs within your deletion parameters. Security is enforced at the category level based on the user's 3C Group security. To delete communications individually, use the Communication Summary component for people or the Org Communication Summary component for organizations.

Pages Used to Delete Communications

<i>Page Name</i>	<i>Definition Name</i>	<i>Navigation</i>	<i>Usage</i>
Communication Summary	COMM_SUMMARY	<ul style="list-style-type: none"> • Campus Community > Communications > Person Communications > Communication Summary • Student Admissions > 3 C's and Event Summaries > Communication Summary • Student Recruiting > 3 C's and Events Summaries > Communication Summary • Contributor Relations > Communications > Communications - Person > Communication Summary • Contributor Relations > Constituent Information > People > Communications > Communication Summary • Self Service > Outreach > View person information > Constituent Information > Communication Summary • Records and Enrollment > 3 C's Summaries > Communication Summary • Student Recruiting > Student Recruiters > Summaries > Communication Summary 	Search for and review a summary of communications to or from an individual.

Page Name	Definition Name	Navigation	Usage
Delete Communications	SCC_DEL_COMMUNICTN	Campus Community > Communications > Delete Communications	Define processing parameters to run the Delete Communications process.

Deleting Individual Communications

Access the Communication Summary page (**Campus Community > Communications > Person Communications > Communication Summary**).

The system displays all communications accessible through individual 3C Group setup. To delete a communication, click the trash can button beside the row. Warning and confirmation messages appear. The system deletes the record when you save the page.

When you delete a communication, any enclosures associated with the communication are also removed. These enclosures share the same sequence number; since they considered subordinate, they do not have a trash can icon beside them and cannot be separately deleted here.

Note: Deleting a communication from a person does not remove it from any related recipients; to delete a communication from a related recipient, search for their record and remove it manually. Also, when you delete a communication, all related comments and checklist items remain.

Related Links

[Reviewing Communications](#)

Deleting Communications in Batch

Access the Delete Communications page (**Campus Community > Communications > Delete Communications**).

This example illustrates the fields and controls on the Delete Communications page. You can find definitions for the fields and controls later on this page.

The screenshot shows the 'Delete Communications' page interface. At the top, it displays 'Run Control ID: GRE' and navigation links for 'Report Manager', 'Process Monitor', and a 'Run' button. Below this is the 'Communication Preferences' section, which includes several search criteria:

- *Academic Institution: PSUNV (PeopleSoft University)
- *Administrative Function: ADMA (Admissions Application)
- *Category: GAPP (Grad Application Processing)
- Context: GMIREQ (Grad Missing Requirements)
- Letter Code: G02 (Grad Missing Appl Requirements)

 A 'Date Range' pop-up is visible, showing 'From Date: 01/01/2004' and 'To Date: 12/31/2004'. At the bottom is the 'Population Selection' section, featuring a 'Selection Tool' dropdown set to 'PS Query' and a 'Query Name' input field with a search icon. A 'Launch Query Manager' link is also present.

Select one or more parameters to narrow the set of communication records to be deleted. The **Academic Institution**, **Administrative Function**, and **Category** fields are required; all other parameter selections are optional. To define a subset of specific IDs for which you want to delete communications, use the Population Selection group box.

This page allows for up to three rows of communication preferences. This limit has been applied to constrain the complexity of, and processing time needed for, the resulting SQL statement executed by the deletion process. Only the communication preferences are subject to this requirement. Note that the Population Selection parameter of the run control is only set once and is applied to all communication preference rows.

Field or Control	Description
Administrative Function	Select an administrative function. The values available here are defined on the Administrative Function Table.
Category	Select a category of communications. The values available here are defined by 3C group security.
Context	Select a communications context. The values here are those valid under the Category selected.
Letter Code	Select a specific communication letter code. The values here are those valid under the Category and Context selected.
From Date and To Date	These fields are optional; however if used, both date fields must be completed and the From Date value must precede the To Date value.

Use the **Population Selection** group box to define a set of IDs, select a PS Query or define an external file. Queries available for selection have the 3C Delete Bind Record "SCC_3CDEL_BND" included in the query. IDs returned by the Population Selection process apply to all Communication Preference rows in the component.

After you specify the parameters, you can run the SCC_3CDELETE Application Engine process by clicking the **Run** button. When you click the **Run** button, the system searches for all communications matching the parameters specified on this page and deletes them. Only the target communications are deleted and any related checklists and comments remain, while maintaining the relationships between the relevant 3C tables.

Note: A user's 3C group must have the **Inquiry Indicator** selected to be able to see anything associated with it and so delete it.

Managing Comments

Understanding Comments

You can enter and track comments about individuals and organizations. You can review all comments about an individual or organization or all comments entered by a specific individual. Because personal comments are subjective and often confidential, carefully analyze your institution's needs and requirements for entering and tracking comments. You should also be familiar with administrative functions and 3C group security before setting up or creating comments in your system.

With the appropriate security access, you can click the **Create Comments** button while on a page in a functional area about that individual or organization to attach or review comments to an individual's or an organization's record.

You can also navigate through the menus to access the comments pages described in this documentation.

Prerequisites for Managing Comments

Set up comments, including comment categories and 3C comment groups, before entering comments for individuals or organizations.

Related Links

[Setting Up Comment Categories](#)



Entering Comments

This section lists common elements and discusses how to:

- Enter comments about an individual.
- Enter comments about an organization.
- Review or change variable data.

Common Elements Used in This Section

<i>Field or Control</i>	<i>Description</i>
Administrative Function	The code for the administrative area with which this comment is associated.

Field or Control	Description
3C Group	The group of comment types to which a user has security access.
Variable Data	Click to access the Variable Data page, where you can view or enter the variable data (for the individual or organization) that is associated with the administrative function. If you transfer to this page directly from a functional area, the variable data transfers from there. If no variable data is required or allowed for the administrative function, the Variable Data button is unavailable and no data transfers from the functional area.
 (communications)	Click to transfer to the Person Communication page or the Organization Communication page, where you can add a new communication for the individual or organization.
 (checklists)	Click to transfer to the Checklists Management 1 page or the Organization Checklist Management 1 page, where you can add a new checklist for the individual or organization.
 (comments)	Click to transfer to the Personal Comment Entry page or the Organizational Comments page, where you can enter a new comment for the individual or organization.

Pages Used to Enter Comments

Page Name	Definition Name	Navigation	Usage
Person Comment Entry	CMNT_ENTRY1	Campus Community > Comments > Comments - Person > Person Comment Entry	Enter comments about an individual.
Organization Comment Entry	ORG_CMNT_ENTRY1	Campus Community > Comments > Comments - Organization > Organization Comment Entry	Enter comments about an organization.
Variable Data	VAR_XXXX_SEC (where XXXX is the administrative code)	Click the Variable Data button on the Person Comment Entry page or on the Organization Comment Entry page.	Review or change variable data for an individual or organization.

Entering Comments About an Individual

Access the Person Comment Entry page (**Campus Community > Comments > Comments - Person > Person Comment Entry**).

<i>Field or Control</i>	<i>Description</i>
Administrative Function	The code for the administrative area with which this comment is associated.
Academic Institution	The academic institution with which this comment is associated.
Comment Category	The business need with which this comment is associated.
Variable Data	<p>Click to access the Variable Data page, where you can view or enter the variable data associated with the specified administrative function.</p> <p>If you transferred to this page directly from a functional area, the variable data transferred from there.</p> <p>If no variable data is required or allowed for the administrative function, the Variable Data button is unavailable and no data was transferred from the functional area.</p>

Comment Data

<i>Field or Control</i>	<i>Description</i>
Comment ID	The system displays the ID of the person entering the comment. If someone else is responsible for this comment, you can override the default ID and type the responsible person's ID.
Department	The department responsible for the comment.
Comment Date	The date when the comment is entered. The default date is the system's current date. You can override this date.
Comments	The system displays the default comment, if any, from the Comment Categories page. If the default comment is set to <i>Allow Changes</i> , this field is editable.
Append Comments	If the default comment is set to <i>Append</i> , this field is available. When the page is saved, comments entered in this field are appended to the end of the default comments.

Entering Comments About an Organization

Access the Organization Comment Entry page (**Campus Community > Comments > Comments - Organization > Organization Comment Entry**).

<i>Field or Control</i>	<i>Description</i>
Administrative Function	The administrative area with which this comment is most closely associated.
Academic Institution	The academic institution with which this comment is most closely associated.
Comment Category	The business need with which this comment is associated.
Variable Data	<p>Click to access the Variable Data page, where you can view or enter the variable data associated with the specified administrative function.</p> <p>If you transferred to this page directly from a functional area, the variable data transferred from there.</p> <p>If no variable data is required or allowed for the administrative function, the Variable Data button is unavailable and no data was transferred from the functional area.</p>

Comment Data

<i>Field or Control</i>	<i>Description</i>
Comment ID	The system displays the ID of the person entering the comment. If someone else is responsible for the comment, you can override the ID and enter the responsible person's ID.
Department	The department responsible for the comment.
Comment Date	The date when the comment is entered. The default date is the system's current date. You can override this date.
Comments	The system displays the default comment, if any, from the Comment Categories page. If the default comment is set to <i>Allow Changes</i> , this field is editable.
Append Comments	If the default comment is set to <i>Append</i> , this field is available. When the page is saved, comments entered in this field are appended to the end of the default comments.

Reviewing or Changing Variable Data

Access the Variable Data page (click the **Variable Data** button on the Person Comment Entry page or on the Organization Comment Entry page).

Different fields and data appear on this page, based on the administrative function selected in the individual Person Comment Entry page or on the Organization Comment Entry page.

Related Links

[Understanding Administrative Functions](#)

Reviewing Comments

This section lists common elements and discusses how to:

- Review a summary of comments about an individual.
- Review a summary of comments about an organization.

Note: Users can access only those comments to which they have been granted 3C group security. With 3C group inquiry access, users can view the comments but cannot change them. With 3C group update access, users can view and change the comments.

Related Links

[“Selecting the Type of 3C Group Access” \(Campus Solutions Application Fundamentals\)](#)

Common Elements Used in This Section

<i>Field or Control</i>	<i>Description</i>
Edit or View	<p>Click to access the Personal Comment Entry page or Organizational Comments page where, depending on your 3C group security level for the category, you can view or edit the comment about the individual or organization.</p> <p>Edit is available for 3C group <i>update</i> access.</p> <p>View is available for 3C group <i>inquiry</i> access.</p>
Category	The code for the category with which the comment is associated.
Description	The description of the category with which the comment is associated.
Function	The code for the administrative area with which the comment is associated.

Field or Control	Description
DateTime	The date and time when the comment was entered.
Sequence	The number of the comment in the list of comments for the individual or organization.
Selection Criteria (area)	If you click Search without entering any values, the system searches for all comments for the person ID or the organization ID and displays the results at the bottom of the page. Enter values or any combination of values (<i>Function</i> , <i>Category</i> , or <i>Comment ID</i>) to limit the search.
Comment ID (tab)	Click to determine the ID and name of the person who is responsible for the comments.

Pages Used to View Comments

Page Name	Definition Name	Navigation	Usage
Comment Summary	CMNT_SUMMARY	Campus Community > Comments > Comments - Person > Person Comment Summary	View a summary of comments about an individual and delete comments.
Organization Comment Summary	ORG_CMNT_SUMMARY	Campus Community > Comments > Comments - Organization > Organization Comment Summary	View a summary of comments about an organization and delete comments.
Operator 3C Groups Summary	OPR_GRP_3C_SUM	<ul style="list-style-type: none"> • Campus Community > Comments > Comments - Person > Person Comment Summary > Operator 3C Groups Summary • Campus Community > Comments > Comments - Organization > Organization Comment Summary > Operator 3C Groups Summary 	View or change an individual's 3C group inquiry or update access.

<i>Page Name</i>	<i>Definition Name</i>	<i>Navigation</i>	<i>Usage</i>
Person Comment Detail	CMNT_ENTRY1	Campus Community > Comments > Comments - Person > Person Comment Detail	View the details of a comment about an individual. (This is a view-only version of the Personal Comment Entry page.)
Organization Comment Detail	ORG_CMNT_ENTRY1	Campus Community > Comments > Comments - Organization > Organization Comment Detail	View the details of a comment about an organization. (This is a view-only version of the Organization Comment Entry page.)

Reviewing a Summary of Comments About an Individual

Access the Comment Summary page (**Campus Community > Comments > Comments - Person > Person Comment Summary**).

To delete a comment, click the trash can icon beside the row. Activate this icon using the **Allow Deletes from 3C Pages** group box on the Campus Community Installation page.

Reviewing a Summary of Comments About an Organization

Access the Organization Comment Summary page (**Campus Community > Comments > Comments - Organization > Organization Comment Summary**).

To delete a comment, click the trash can icon beside the row. Activate this icon using the **Allow Deletes from 3C Pages** group box on the Campus Community Installation page.

Deleting Comments

This section discusses how to delete comments in batch.

Related Links

[Reviewing a Summary of Comments About an Individual](#)

Page Used to Delete Comments

<i>Page Name</i>	<i>Definition Name</i>	<i>Navigation</i>	<i>Usage</i>
Delete Comments	SCC_DEL_CMNT	Campus Community > Comments > Delete Comments	Define processing parameters to run the Delete Comments process.

Deleting Comments in Batch

Access the Delete Comments page (**Campus Community > Comments > Delete Comments**).

Select one or more parameters to narrow the set of comments to be deleted. The **Academic Institution**, **Administrative Function**, and **Comment Category** fields are required; all other parameter selections are optional. To define a subset of specific IDs for which you want to delete communications, use the Population Selection group box. If you specify a Date Range, the comment deletion process compares the value of the **Comment Date** field of each comment against this range.

<i>Field or Control</i>	<i>Description</i>
Administrative Function	Select an administrative function. The values available here are defined on the Administrative Function Table.
Comment Category	Select a category of comments. The values available here are restricted by 3C group security.
From Date and To Date	These fields are optional; however if used, both date fields must be completed and the From Date value must precede the To Date value.

Use the Population Selection group box to define a set of IDs, select a PS Query or define an external file. Queries available for selection have the 3C Delete Bind Record "SCC_3CDELCT_BND" included in the query. IDs returned by the Population Selection process apply to all Checklist Preference rows in the component.

After you specify the parameters, click the **Run** button to run the SCC_3CD_CMNT Application Engine process. When you click the **Run** button, the system searches for all checklists matching the parameters specified on this page and deletes them. Only the target checklist items are deleted and any related communications and comments remain, while maintaining the relationships between the relevant 3C tables.

Note: A user's 3C group must have the **Inquiry Indicator** selected to be able to see anything associated with it and so delete it.

Managing Checklists

Understanding Checklists

Use checklists to assign lists of requirements to individuals, organizations, events, or groups of individuals and to monitor progress toward completing those requirements. You can use checklists to track applications, organize recruitment mailings, assign tasks to staff members, generate a series of communication items, and so on.

You can assign checklists to an organization. For example, you might want to assign a checklist of recruitment items required from a specific high school, including a roster of the top 10 percent of the current graduating class, a list of athletic award winners, and scholarship applicants.

You can assign checklists to events. For example, if you are presenting a conference, you might want to create a checklist of things to do, including sending out invitations, booking a keynote speaker, setting food menus, and so on.

For each checklist item that you assign, you can specify the individual who is responsible for that item and the due date. If the item is also associated with an organization, you can specify the name of the organization responsible for the item. You can also specify an ultimate due date for the overall checklist.

You can assign checklists to individuals, organizations, and events manually, or you can use the 3C engine to automatically assign checklists to individuals or organizations based on rules and conditions that you define.

See [Understanding the 3C Engine](#).

After a checklist is set up, you can, with appropriate security access, click the **Create Checklists** button on a page in a functional area about that individual or organization to view or update their checklists.

You can also navigate through the menus, as described in this section, to access the checklist management pages.

You can update the status of checklist items manually on the same checklist management pages where you assign the items, or you can view a summary of all checklist items assigned to an individual, organization, or event and manually update each checklist item status there.

You can update a specific checklist item for the IDs that you indicate. For example, when a recruiter makes phone calls to several prospects, he or she could select the Recruiter Phone Call checklist item to update and enter the ID of each individual who was called. When the page is saved, the system updates the status of the Recruiter Phone Call checklist item for each of the specified individuals.

You can use automated processes to update checklists, too. You can specify criteria to run either the Update - Automated process or the Update Checklists - by Item process to update checklists in the background.

Run the Item Update - Automated is a background process that updates the status of either a specific checklist item or all checklist items in three general areas (transcripts, general materials, and test scores)

across the IDs that you specify. The process updates the checklists in the background and, once set up, does not require manual intervention. It automatically checks the status indicator for all items in each area that you select and, upon encountering a status of *Complete* for an item, updates the status of the relevant checklist.

You can use the 3C engine to automatically update checklist items either in the background or in real time, based on rules and events that you define.

Note: The 3C engine cannot update items that include organization and name IDs. You must update checklists for transcripts, test scores, and general material items either manually or by using the Item Update - Automated process.

You can review checklist information several ways. You can review checklist information for an individual, organization, or event; or you can review checklist information by tracking group for an individual or for an organization. You can review detailed checklist data for an organization, or you can search for a summary of the checklist data that you want to review for an organization. You can also review organization checklists by the tracking groups to which their checklist items are assigned.

Note: PeopleSoft Campus Self Service, which is licensed separately, offers self-service checklist functionality.

See “Using Self-Service Checklists Data” (Campus Self Service).

Related Links

“Processing Mass Changes” (Campus Solutions Application Fundamentals)

Prerequisites for Managing Checklists

Before you can assign and monitor checklists, you must set up checklist item codes and checklist templates. To use the full functionality of checklist management, you should also be familiar with administrative functions and 3C group security, and ensure that they are properly set up.

Related Links

[Setting Up Checklist Items](#)

[Understanding Administrative Functions](#)

“Setting Up 3C Group Security” (Campus Solutions Application Fundamentals)

Common Elements Used to Manage Checklists

See [Common Elements Used in The 3Cs Documentation](#)

<i>Field or Control</i>	<i>Description</i>
View or Edit	<p>Click to transfer to where you can view or edit the communication assignment.</p> <hr/> <p>Note: The View link is available when the user has 3C group <i>inquiry</i> access for the communication category. The Edit link is available only when the user has 3C group <i>update</i> access for the communication category.</p> <hr/>

Assigning Checklists to Individuals

This section discusses how to:

- Assign a checklist to an individual.
- Review or update variable data for an individual.
- Assign checklist items to an individual's checklist.

Pages Used to Assign Checklists to Individuals

<i>Page Name</i>	<i>Definition Name</i>	<i>Navigation</i>	<i>Usage</i>
Checklist Management 1	PERS_CHKLIST_MGMT1	Campus Community > Checklists > Person Checklists > Checklist Management - Person > Checklist Management 1	Assign a checklist to an individual.
Variable Data	VAR_XXXX_SEC (where XXXX is the administrative code)	Click the Variable Data button on the Checklist Management 1 page.	Review or edit variable data for an individual.
Checklist Management 2	PERS_CHKLIST_MGMT2	Campus Community > Checklists > Person Checklists > Checklist Management - Person > Checklist Management 2	Place checklist items on an individual's checklist and identify who is responsible for each item.

Assigning a Checklist to an Individual

Access the Checklist Management 1 page (**Campus Community > Checklists > Person Checklists > Checklist Management - Person > Checklist Management 1**).

Field or Control	Description
Administrative Function	<p>The code for the functional area with which this individual is associated.</p> <p>The available administrative function codes are from the Administrative Functions page.</p> <p>If you accessed this page from another page, the system automatically displays the administrative function from that page.</p>
Checklist Code	<p>The code that describes the checklist assigned to this individual.</p> <p>The only checklist codes available are those associated with administrative function on the Checklist Item Functions page.</p>
Status and Stat Dt (status date)	<p>The system displays the status and the date when the status was updated. Valid status values are <i>Initiated</i> or <i>Completed</i>.</p>
Due Date	<p>The date by which the entire checklist must be completed for this individual.</p>
Due Amount	<p>The monetary amount, if any, that is due as part of this checklist and the currency in which it is expressed.</p>
Comments	<p>Enter comments to further identify or describe the checklist for this individual.</p>
Variable Data	<p>If no variable data is required or allowed for the administrative function, the Variable Data button is unavailable and no data was available to transfer.</p> <p>If variable data is required, the Variable Data button is available. Select the variable data (for example, Aid Year) for which the checklist is applicable.</p>

Reviewing or Updating Variable Data for an Individual

Access the Variable Data page (click the **Variable Data** button on the Checklist Management 1 page).

Different fields and data appear on this page based on the individual and the administrative function selected on the Checklist Management 1 page.

Related Links

“Setting Up 3C Group Security” (Campus Solutions Application Fundamentals)

Assigning Checklist Items to an Individual's Checklist

Access the Checklist Management 2 page (**Campus Community > Checklists > Person Checklists > Checklist Management - Person > Checklist Management 2**).

This example illustrates the fields and controls on the Checklist Management 2 page (1 of 2). You can find definitions for the fields and controls later on this page.

Checklist Management 1		Checklist Management 2	
Craig Howe		ID: AD5205	
Checklist Date Time:	08/26/2004 3:37:08PM		
Administrative Function:	Admissions Application	Status:	Initiated
Academic Institution:	PeopleSoft University	Status Date:	08/26/2004
Checklist Code:	New Applicant	Due Date:	09/25/2004
Checklist Item Table			
*Sequence	*Item	*Status	*Status Date *Due Date
100	TOEFL TOEFL	Initiated	08/26/2004 09/25/2004
Responsible ID: KU0007		Name: Locherty,Betty	
*Sequence	*Item	*Status	*Status Date *Due Date
200	DEAN Dean's Rpt	Initiated	08/26/2004 09/25/2004
Responsible ID: KU0007		Name: Locherty,Betty	

This example illustrates the fields and controls on the Checklist Management 2 page (2 of 2). You can find definitions for the fields and controls later on this page.

*Sequence	*Item	*Status	*Status Date	*Due Date	
300	MEDIC Medic App	Initiated	08/26/2004	09/25/2004	
Responsible ID: KU0007		Name: Locherty,Betty			
Association ID:		Name: Simpson,Clara			
*Sequence	*Item	*Status	*Status Date	*Due Date	
400	TRANS Transcpts	Initiated	08/26/2004	09/25/2004	
Responsible ID: KU0007		Name: Locherty,Betty			
Org ID: 000000001		Description: Cottonwood High School			

Note: The checklist items associated with the specified checklist code on the Checklist Management 1 page become available when you select the checklist code. You can enter any of those items directly, or you can click the **Lookup** button to go to the search page, where all checklist items associated with the specified administrative function are available.

Checklist Items

Field or Control	Description
Sequence	<p>The number of this checklist item in the list of checklist items for this individual.</p> <p>The system automatically enters the next sequential number for each checklist item that you add. You can override the number manually to reorder the list of items for this checklist.</p>
Item	<p>The code for this checklist item. The available item codes are from the Checklist Item Functions page for the administrative function selected.</p>
Status and Status Date	<p>The status and status date of the checklist item: <i>Initiated, Completed, Active, Ordered, Paid Off, Received, Notified, 2nd Notification, Returned, Waived, or Cancelled.</i></p> <p>Values for this field are delivered with the system as translate values. Do not modify these values in any way. Any modifications to these values could require substantial programming effort.</p>
Due Date	<p>The system displays the overall checklist due date as the default due date for each checklist item. You can override this date, but it must be with an <i>earlier</i> date so that the item due date does not exceed the overall due date of the checklist.</p>
Responsible ID and Name	<p>The default ID is that of the user who created the checklist on the Checklists page. You can manually override the ID to reassign responsibility to someone else in your database. The system displays the name of the individual with that ID.</p>
Association ID and Name	<p>If the checklist item was created with an item association of <i>Name</i> on the Checklist Items page, the Association ID field appears for you to identify the associated person. For example, the checklist item might be a medical appointment, and that appointment might be with Dr. Clara Simpson. Dr. Simpson is the associated person.</p> <p>If the associated person has an ID in your database, enter it here. When you exit the field, the system displays the name of that individual.</p> <p>If the individual does not have an ID in your database, enter his or her name manually.</p>

Field or Control	Description
Org ID (organization ID) and Description	<p>If the checklist item was created with an item association of <i>Organization</i> on the Checklist Items page, the Org ID field appears for you to identify the associated organization. For example, the checklist item might be a transcript, and a transcript is required from Cottonwood High School. Cottonwood High is the associated organization.</p> <p>If the associated organization has an ID in your database, enter it here. When you exit the field, the system displays the name of that organization.</p> <p>If the organization does not have an ID in your database, enter the name manually.</p>

Assigning Checklists to Organizations

This section discusses how to:

- Assign a checklist to an organization.
- Review or update variable data for an organization.
- Assign checklist items to an organization's checklist.

Pages Used to Assign Checklists to Organizations

Page Name	Definition Name	Navigation	Usage
Org Checklist Mgmt 1	ORG_CHKLIST_MGMT1	Campus Community > Checklists > Organization Checklists > Checklist Management - Org > Org Checklist Mgmt 1	Assign a checklist to an organization.
Variable Data	VAR_XXXX_SEC (where XXXX is the administrative code)	Click the Variable Data button on the Organization Checklist Management 1 page.	Enter or review variable data for an organization.
Org Checklist Mgmt 2	ORG_CHKLIST_MGMT2	Campus Community > Checklists > Organization Checklists > Checklist Management - Org > Org Checklist Mgmt 2	Place checklist items on an organization's checklist and identify who is responsible for each item.

Assigning a Checklist to an Organization

Access the Org Checklist Mgmt 1 page (**Campus Community > Checklists > Organization Checklists > Checklist Management - Org > Org Checklist Mgmt 1**).

<i>Field or Control</i>	<i>Description</i>
Administrative Function	<p>The code for the functional area with which this organization is associated.</p> <p>The available administrative function codes are from the Administrative Functions page.</p> <p>If you accessed this page from another page, the system automatically displays the administrative function from that page.</p>
Checklist Code	<p>The code that describes the checklist assigned to this organization.</p> <p>The only checklist codes available are those associated with administrative function on the Checklist Item Functions page.</p>
Status and Status Date	<p>The status and status date of the checklist item. Valid status values are <i>Initiated</i> or <i>Completed</i>.</p> <p>Values for this field are delivered with the system as translate values. Do not modify these values in any way. Any modifications to these values could require substantial programming effort.</p>
Due Date	<p>The date by which the entire checklist must be completed for this organization.</p>
Due Amount and Currency Code	<p>The monetary amount, if any, that is due as part of this checklist, and the currency in which it is expressed.</p>
Comments	<p>Enter comments to further identify or describe the checklist for this organization.</p>
Variable Data	<p>If no variable data is required or allowed for the administrative function, the Variable Data button is unavailable and no data was available to transfer.</p>

Reviewing or Updating Variable Data for an Organization

Access the Variable Data page (click the **Variable Data** button on the Organization Checklist Management 1 page).

Different fields and data appear on this page, based on the individual and the administrative function selected on the Organization Checklist Management 1 page.

Related Links

[Understanding Administrative Functions](#)

Assigning a Checklist Item to an Organization's Checklist

Access the Org Checklist Mgmt 2 page (**Campus Community > Checklists > Organization Checklists > Checklist Management - Org > Org Checklist Mgmt 2**).

Note: The checklist items associated with the specified checklist code on the Org Checklist Mgmt 1 page become available when you select the checklist code. You can enter any of those items directly, or you can click the **Lookup** button to go to the search page, where all checklist items associated with the specified administrative function are available.

Checklist Items

<i>Field or Control</i>	<i>Description</i>
Sequence	<p>The number of this checklist item in the list of checklist items for this organization.</p> <p>The system automatically enters the next sequential number for each checklist item that you add. You can override the number manually to reorder the list of items for this checklist.</p>
Item Code	<p>The code for this checklist item. The available item codes are from the Checklist Item Functions page for the administrative function selected.</p>
Status and Status Date	<p>The status and status date of the checklist item: <i>Initiated</i>, <i>In Progress</i>, or <i>Completed</i>.</p> <p>Values for this field are delivered with the system as translate values. Do not modify these values in any way. Any modifications to these values could require substantial programming effort.</p>
Due Date	<p>The system displays the overall checklist due date as the default due date for each checklist item. You can override this date, but it must be with an <i>earlier</i> date so that the item due date does not exceed the overall due date of the checklist.</p>
Responsible ID	<p>The default ID is that of the user who created the checklist on the Checklists page. You can manually override the ID to reassign responsibility to someone else in your database.</p>

Field or Control	Description
Association ID and Name	<p>If the checklist item was created with an item association of <i>Name</i> on the Checklist Items page, the Association ID field appears for you to identify the associated person. For example, the checklist item might be a medical appointment, and that appointment might be with Dr. Clara Simpson. Dr. Simpson is the associated person.</p> <p>If the associated person has an ID in your database, enter it here. When you exit the field, the system displays the name of that individual.</p> <p>If the individual does not have an ID in your database, enter his or her name manually.</p>
Org ID (organization ID) and Description	<p>If the checklist item was created with an item association of <i>Organization</i> on the Checklist Items page, the Org ID field appears for you to identify the associated organization. For example, the checklist item might be a transcript, and a transcript is required from Cottonwood High School. Cottonwood High is the associated organization.</p> <p>If the associated organization has an ID in your database, enter it here. When you exit the field, the system displays the name of that organization.</p> <p>If the organization does not have an ID in your database, enter the name manually.</p>

Assigning Checklists to Events

This section discusses how to:

- Assign checklist items to an event's checklist.
- Assign a checklist to an event.

Pages Used to Assign Checklists to Events

Page Name	Definition Name	Navigation	Usage
Event Checklist Mgmt 1	EVENT_CHKLIST_MGMT1	Campus Community > Checklists > Event Checklists > Checklist Management - Event > Event Checklist Mgmt 1	Specify checklist items for an event by selecting the meetings that make up the event.

Page Name	Definition Name	Navigation	Usage
Event Checklist Mgmt 2	EVENT_CHKLIST_MGMT2	Campus Community > Checklists > Event Checklists > Checklist Management - Event > Event Checklist Mgmt 2	Assign a checklist to an event.

Assigning a Checklist Item to an Event's Checklist

Access the Event Checklist Mgmt 1 page (**Campus Community > Checklists > Event Checklists > Checklist Management - Event > Event Checklist Mgmt 1**).

Field or Control	Description
Academic Institution	The academic institution with which this event is associated. The available academic institutions are from the Institution Table page.
Checklist Code	The code that describes the checklist assigned to this organization. The only checklist codes available are those associated with the EVNT (Event) administrative function on the Checklist Item Functions page.
Status and Status Date	The status and status date of the checklist item: <i>Initiated</i> , or <i>Completed</i> . Values for this field are delivered with the system as translate values. Do not modify these values in any way. Any modifications to these values could require substantial programming effort.
Due Date	The system displays the overall checklist due date as the default due date for each checklist item. You can override this date, but it must be with an <i>earlier</i> date so that the item due date does not exceed the overall due date of the checklist.
Comment	Enter comments to further identify or describe the checklist for this organization.

Event Meeting

Enter event variable data in this section. This data is similar to variable data for individuals and organizations; however, the EVNT (Event) administrative function is the only applicable function for events.

Field or Control	Description
Campus Meeting	When selected, indicates that this checklist is for a specific meeting assigned to this event.
Event Meeting Number	The number of the specific meeting to which this checklist is assigned. The available numbers are from the Meetings Details page for this event.

Assigning a Checklist to an Event

Access the Event Checklist Mgmt 2 page (**Campus Community > Checklists > Event Checklists > Checklist Management - Event > Event Checklist Mgmt 2**).

Note: The checklist items associated with the specified checklist code on the Event Checklist Management 1 page become available when you select the checklist code. You can enter any of those items directly, or you can click the **Lookup** button to go to the search page, where all checklist items associated with the specified administrative function are available.

Item List

Field or Control	Description
Sequence	<p>The number of this checklist item in the list of checklist items for this organization.</p> <p>The system automatically enters the next sequential number for each checklist item that you add. You can override the number manually to reorder the list of items for this checklist.</p>
Item Code	The code for this checklist item. The item codes available are from the Checklist Item Functions page for the administrative function selected.
Item Status and Status Date	<p>The status and status date of the checklist item: <i>2nd Nfctn, Active, Cancelled, Completed, Initiated, Notified, Ordered, Paid Off, Received, Returned, or Waived.</i></p> <p>Values for this field are delivered with the system as translate values. Do not modify these values in any way. Any modifications to these values could require substantial programming effort.</p>

Field or Control	Description
Due Date	The system displays the overall checklist due date as the default due date for each checklist item. You can override this date, but it must be with an <i>earlier</i> date so that the item due date does not exceed the overall due date of the checklist.
Resp ID (responsible ID) and Name	The system displays the ID and name of the user who created the checklist on the Checklists page.

Reviewing 3C Group Access to Checklists

You can access the 3C Group Summary page to view or change an individual's 3C group security access to checklists.

Note: Users can access only those checklists to which they are granted 3C group security. With 3C group inquiry access, users can view the checklists, but cannot change them. With 3C group update access, users can view and change the checklists.

See “Selecting the Type of 3C Group Access” (Campus Solutions Application Fundamentals).

Updating Checklist Item Status

You can change the status of a checklist item for an individual or organization in the respective Checklist Management component.

To minimize security access concerns or to accelerate data entry, you can update the status of a checklist item for individual IDs (not for organization IDs) manually inside a component that shows only checklist items, or you can change the same item across all IDs automatically using the Update Checklist Item - by Item (CCCHKLER.SQR) process.

To update a checklist item manually by ID, access the checklist assigned to that ID and change the status of each item to the appropriate status in that checklist.

To use the Update Checklist Item - by Item process, select the item whose status you want to change and add all the IDs for which you want the process to update the status. For example, if you have several recruiter phone calls to make, as you call you could insert all the individual IDs under the checklist item Call Prospect. When you run the process, the system updates the checklist item status to *Complete* for all the IDs that you listed.

Using the automated process (CCITMUPD SQR), you can also update checklist items automatically across checklists using test scores, transcripts, or general materials.

This section discusses how to:

- Manually update checklist items by ID.

- Update all or a specific checklist item by automated process.
- Update test score, transcript, and general material checklist items.

Pages Used to Update Checklist Item Status

Page Name	Definition Name	Navigation	Usage
Item Update - by Person	PERS_CHKLIST_UPDATE	Campus Community > Checklists > Person Checklists > Item Update - by Person	Manually update the status of each relevant checklist item on a summary of checklist items for a specific ID (individual IDs only).
Item Update - by Item	CHKLIST_ITEM_UPDATE	Campus Community > Checklists > Person Checklists > Item Update - by Item	List all the individual IDs for whom you want to change the status of a specific checklist item to <i>Complete</i> when the update process (CCCHKLER SQR) runs in the background.
Update Checklist Item - by Item	RUNCTL_CCCHKLER	Campus Community > Checklists > Process Checklists > Update Checklist Item Update - by Item	Run the automated Update Checklist Item - by Item process (CCCHKLER SQR) to update one or all checklist items for IDs to which the items are assigned.
Checklist Item Update Parm	RUNCTL_ITMUPD	Campus Community > Checklists > Process Checklists > Item Update - Automated > Checklist Item Update Parm	Specify the test scores, transcripts, or general materials checklist items and IDs to update when running the Checklist Item Update process for test scores, transcripts, or general materials.
Data Selection Parm	RUNCTL_ITMUPD_DATA	Campus Community > Checklists > Process Checklists > Item Update - Automated > Data Selection Parm	Specify the IDs and materials to update when running the Checklist Item Update process for test scores, transcripts, or general materials.

Manually Updating Checklist Items by ID

Access the Item Update - by Person page (**Campus Community > Checklists > Person Checklists > Item Update - by Person**).

Field or Control	Description
Item, Sequence, Function, Checklist Type and Checklist Code Descr (checklist code description)	The system displays this information for each of the checklist items assigned to the individual on the Checklist Management 1 page.
Item Status	<p>Enter the updated status of the checklist item: <i>Initiated, In Progress, Completed</i>, and so on.</p> <p>Values for this field are delivered with your system as translate values. Do not modify these values in any way. Any modifications to these values could require substantial programming effort.</p>
Status Date	When you update the status of a checklist item, the system automatically changes the status date to the system's current date. You can override this date.

Updating All or a Specific Checklist Item by Automated Process

Access the Update Checklist Item - by Item page (**Campus Community > Checklists > Process Checklists > Update Checklist Item Update - by Item**).

Item Selection

Field or Control	Description
All Items	Select this to update all of the checklist items specified on the Item Update - by Item table to a status of <i>Complete</i> .
One Item and Checklist Item Code	<p>Select this to update the checklist item that you specify, to a status of <i>Complete</i>. You must specify the checklist item to update.</p> <p>After you run the process, you can view the CCCHKLER report, which lists the IDs and the checklist item codes that were updated.</p>

Updating Test Score, Transcript, or General Material Checklist Items

Access the Checklist Item Update Parms page (**Campus Community > Checklists > Process Checklists > Item Update - Automated > Checklist Item Update Parms**).

ID Selection

<i>Field or Control</i>	<i>Description</i>
Process All IDs or ID	Select Process All IDs to update all eligible checklist items for all IDs in your system, or specify the ID of the specific individual whose checklist item the process should update.

Data Type Selection

Data type selection relates to logic in the process that provides a linkage to admissions records where the applicable data resides. When the Test Scores button is clicked, the process evaluates data in the test score table as it updates checklist items.

<i>Field or Control</i>	<i>Description</i>
Test Scores	Select to evaluate test score data in PeopleSoft Recruiting and Admissions to update checklist items.
Transcripts	Select to evaluate transcript data in PeopleSoft Recruiting and Admissions to update checklist items.
General Materials	Select to evaluate general materials data in PeopleSoft Recruiting and Admissions to update checklist items.

Checklist Item Selection

<i>Field or Control</i>	<i>Description</i>
Checklist Item Code	Enter the code of the checklist item to update.

Specifying the Data to Update

Access the Data Selection Parameters page (**Campus Community > Checklists > Process Checklists > Item Update - Automated > Data Selection Parm**s).

Only the data selection parameters associated with the data types selected on the Update Parameters page are available.

Data Selection Parameters

<i>Field or Control</i>	<i>Description</i>
Process All Test IDs or Test ID	<p>Select Process All Test IDs for the process to update the checklist item for all test IDs, or specify the test from the Test Scores page (for example, <i>GRE</i> test) for which the system should update this checklist item.</p> <p>If you select the Test Scores option in the Data Selection group box, you must either select Process All Test IDs or specify one test ID.</p>
Process All Organizations or Org ID	<p>Select Process All Organizations to evaluate all transcript data from all organizations to update the checklist item, or, specify the organization from the Education page (for example <i>000010008</i> Apache Junction High School), for which the system should update the checklist item.</p> <p>Transcripts received are recorded by Organization in the PeopleSoft Recruiting and Admissions Education page.</p> <p>If you select the Transcripts option in the Data Selection group box, you must either select Process All Organizations or specify one organization ID.</p>
Process All General Materials or Material Group or Material Type	<p>Select Process All General Materials to evaluate all general materials data to update this checklist item, or specify the material group from the General Materials page (for example, <i>UGRECOMM</i>, Undergraduate Recommendations) or the specific material type from the General Materials page (for example <i>REC</i>, Recommendation), for which the system should update this checklist item.</p> <p>If you select the General Materials option in the Data selection group box, you must either select Process All General Materials to process all general materials or specify one material group or a material type.</p>

Data Type Selection

<i>Field or Control</i>	<i>Description</i>
Test Scores	<p>When selected, indicates the process should evaluate the test IDs specified in the ID Selection group box to update checklist items.</p>

Field or Control	Description
Transcripts	When selected, indicates the process should evaluate the transcripts for the organizations specified in the ID Selection group box to update checklist items.
General Materials	When selected, indicates the process should evaluate the materials specified in the ID Selection group box to update checklist items.

Reviewing Checklists for Individuals

This section discusses how to:

- View detailed checklist data for an individual.
- View a summary of checklist item status for an individual.
- View a summary of tracking groups for an individual.
- View a summary of checklists in a tracking group for an individual.
- View tracking group data.

Pages Used to Review Checklists for Individuals

Page Name	Definition Name	Navigation	Usage
Checklist Detail 1 and Checklist Detail 2	PERS_CHKLIST_MGMT1 PERS_CHKLIST_MGMT2	Campus Community > Checklists > Person Checklists > Person Checklist Detail > Checklist Detail 1 or Checklist Detail 2	View detailed checklist data for an individual. (The Checklist Detail 1 and 2 pages are view only versions of the Checklist Management 1 and 2 pages.)
Checklist Summary	PERS_CHKLIST_SUMM	<ul style="list-style-type: none"> • Campus Community > Checklists > Person Checklists > Person Checklist Summary • Records and Registration > 3 C's Summaries > Personal Checklist Summary 	<p>Note: If you license PeopleSoft Campus Self Service, you can also access the Checklist Summary page by selecting Self Service > Outreach > View Person Information > Constituent Information > Checklist Summary.</p> <p>View a summary of checklist item status for an individual and delete individual checklist items.</p>

<i>Page Name</i>	<i>Definition Name</i>	<i>Navigation</i>	<i>Usage</i>
Person Tracking Summary	TRACKING_SUMMARY	Campus Community > Checklists > Person Checklists > Person Tracking Summary	View a summary of tracking groups for an individual to determine the groups with which an individual's checklists are associated and view the overall status of those tracking groups.
Tracking Group Detail	CHECKLIST_SEC	Click the View link on the Person Tracking Summary page.	View a summary of checklists in a tracking group for an individual.
Person Tracking Inquiry	TRACKING_INQUIRY	Campus Community > Checklists > Person Checklists > Person Tracking Inquiry	View the variable data with which specific tracking groups are related.

Viewing Detailed Checklist Data for an Individual

The Checklist Detail 1 and 2 pages are view-only versions of the Checklist Management 1 and 2 pages where you assign checklist items to the individual.

Related Links

[Assigning Checklists to Individuals](#)

Viewing a Summary of Checklist Item Status for an Individual

Access the Checklist Summary page (**Campus Community > Checklists > Person Checklists > Person Checklist Summary**).

Note: Multiple views of this page are available by clicking the tabs in the scroll area. We document fields that are common to all views first.

Common Page Information

If you click the **Search** button without entering any values, the system searches for all checklists for the individual and displays the results at the bottom of the page. You can enter values or any combination of values to limit the search.

<i>Field or Control</i>	<i>Description</i>
Function	The administrative area on which you want to search.

Field or Control	Description
Variable Data	<p>The Variable Data link becomes available when a function is selected. Click the link to access the Variable Data page where you can enter the variable data associated with this administrative function for this individual.</p> <p>Variable data provides a powerful searching tool for reviewing checklists. By entering variable data as search criteria, you can limit the search to the results relevant to the specified function.</p>
Checklist Type	The type of checklist (for example, <i>Condition List</i> , <i>Communication List</i> , or <i>Requirements List</i>) for which you want to search.
Checklist	Enter the code of the checklist for which you want to search. The available checklists are from the Checklists page.
Responsible ID	<p>The ID of the individual who is associated with or responsible for the checklist items for which you want to search.</p> <p>The system displays the logged-in user ID. You can remove or change this default ID for your search.</p>
Status	<p>The status of the checklists for which to search.</p> <p><i>All:</i> The system searches for all checklist items regardless of status.</p> <p><i>Completed:</i> The system searches for only completed checklist items.</p> <p><i>Initiated:</i> The system searches for only checklist items that have been initiated but not yet completed.</p>
Search	Click to launch the search based on the selected criteria.

To delete a checklist item, click the trash can button beside the row. When you delete a checklist, all subordinate checklist items are also deleted. Activate this icon using the **Allow Deletes from 3C Pages** group box on the Campus Community Installation page.

Institution and Function Tab

Use the Institution and Function tab to determine the institution, administrative function, and checklist type associated with the checklist item. Also use it to determine the name of the person who assigned or is responsible for the checklist item.

Related Links

[Deleting Checklists](#)

Viewing a Summary of Tracking Groups for an Individual

Access the Person Tracking Summary page (**Campus Community > Checklists > Person Checklists > Person Tracking Summary**).

Selection Criteria

If you click the **Search** button without entering any values, the system will search for all tracking groups that include this individual and display the results at the bottom of the page. You can enter a value or any combination of values to limit your search.

Field or Control	Description
Function	The administrative area on which you want to search.
Variable Data	<p>The Variable Data link becomes available when a function is selected. Click the link to access the Variable Data page where you can enter the variable data associated with this administrative function for this individual.</p> <p>Variable data provides a powerful searching tool for reviewing checklists. By entering variable data as search criteria, you can limit the search to the results relevant to the specified function.</p>
Tracking Group	The tracking group on which you want to search.
Status	<p>The status of the checklists for which you want to search.</p> <p><i>All:</i> The system searches for all checklist items regardless of status.</p> <p><i>Completed:</i> The system searches for only completed checklist items.</p> <p><i>Initiated:</i> The system searches for only checklist items that have been initiated but not yet completed.</p>
Search	Click to launch the search based on the selected criteria.

Track Group Detail

<i>Field or Control</i>	<i>Description</i>
View	<p>If the user has 3C group inquiry access to view this checklist code and the administrative function is not <i>General</i>, this link is available. Click to access the Tracking Group page where you can view the checklist.</p> <hr/> <p>Note: If the function is <i>General</i>, the link might appear, but it will not transfer you.</p>

Viewing a Summary of Checklists in a Tracking Group for an Individual

Access the Tracking Group Detail page (Click the **View** link on the Person Tracking Summary page).

This example illustrates the fields and controls on the Tracking Group Detail page. You can find definitions for the fields and controls later on this page.

Person Tracking Summary

Tracking Group Detail

Nancy Smith ID: AD5033

Tracking Group

Tracking Group:	Academic Institution:	Tracking Sequence:	Status Date:	Group Status:
UGAPPL	PSUNV	1	03/23/2001	Initiated

Function / Variable Data:

ADMA	Variable Data	Value
	Academic Career	UGRD
	Student Career Nbr	0
	Application Nbr	00022781

Checklist Item Table Find First 1-2 of 2 Last

Checklist Code:
UGALL UG Appl Requirements - All

[View](#)

Checklist Item Code	Description	Item Status
ACTSAT	ACT or SAT I Test Scores	Completed
PERSTA	Personal Statement	Completed
TRANS	Academic Transcripts	Completed

Checklist Code:
UGFRSH UG Appl Requirement - First-Yr

[View](#)

Checklist Item Code	Description	Item Status
SECRPT	Secondary School Report	Initiated

This page is for viewing purposes only. You cannot enter or modify data here.

Click the **View** link to access the Checklist Detail pages for the checklist code.

Viewing Tracking Group Data

Access the Person Tracking Inquiry page (**Campus Community > Checklists > Person Checklists > Person Tracking Inquiry**).

This page is for viewing purposes only. You cannot enter or modify data here. Click the **Variable Data** button to access the Variable Data page where you can review the variable data associated with this tracking group.

Reviewing Checklists for Organizations

This section discusses how to:

- View detailed checklist data for an organization.
- View a summary of checklist item status for an organization.
- View a summary of tracking groups for an organization.
- View a summary of checklists in a tracking group for an organization.
- View tracking group data.

Pages Used to Review Checklists for Organizations

<i>Page Name</i>	<i>Definition Name</i>	<i>Navigation</i>	<i>Usage</i>
Org Checklist Detail 1 and Org Checklist Detail 2	ORG_CHKLIST_MGMT1 ORG_CHKLIST_MGMT2	Campus Community > Checklists > Organization Checklists > Org Checklist Detail	View detailed checklist data for an organization.
Org Checklist Summary	ORG_CHKLIST_SUMMARY	Campus Community > Checklists > Organization Checklists > Org Checklist Summary	View a summary of checklist items for an organization. Note: If you licensed PeopleSoft Campus Self Service, you can also access the Org Checklist Summary page by selecting Self Service > Outreach > View Organization Information > Constituent Information - Org > Checklist Summary.

Page Name	Definition Name	Navigation	Usage
Organization Tracking Summary	ORG_TRACK_SUMMARY	Campus Community > Checklist > Organization Checklists > Org Tracking Summary	Review the tracking groups with which an organization's checklists are associated and the overall status of those tracking groups.
Organization Tracking Group Detail	CHECKLIST_SEC	Click the View link on the Organization Tracking Summary page.	Review information about a tracking group checklist for an organization.
Organization Tracking Inquiry	ORG_TRACK_INQUIRY	Campus Community > Checklists > Organization Checklists > Org Tracking Inquiry	View the variable data with which specific tracking groups are related.

Viewing Detailed Checklist Data for an Organization

The Organization Checklist Detail 1 and 2 pages are view-only versions of the Organization Checklist Management 1 and 2 pages where you assign checklist items to the organization. You cannot enter or edit data here.

Related Links

[Assigning Checklists to Organizations](#)

Viewing a Summary of Checklist Item Status for an Organization

Access the Org Checklist Summary page (**Campus Community > Checklists > Organization Checklists > Org Checklist Summary**).

Note: Multiple views of this page are available by clicking the tabs in the scroll area. We document fields that are common to all views first.

Common Page Information

If you click the **Search** button without entering any values, the system searches for all checklists for this organization and displays the results at the bottom of the page. You can enter a value or any combination of values to limit the search.

Field or Control	Description
Function	The administrative area on which you want to search.

Field or Control	Description
Variable Data	<p>The Variable Data link becomes available when a function is selected. Click the link to access the Variable Data page where you can enter the variable data associated with this administrative function for this organization</p> <p>Variable data provides a powerful searching tool for reviewing checklists. By entering variable data as search criteria, you can limit the search to the results relevant to the specified function.</p>

See [Assigning a Checklist to an Organization](#).

Field or Control	Description
Checklist Code	The checklist on which you want to search. The available checklists are from the Checklists page.
Checklist Type	The type of checklist (<i>Condition List</i> , <i>Communication List</i> , <i>Requirements List</i> , and so on) for which you want to search.
Responsible ID	<p>The ID of the individual who is associated with, or responsible for, the checklists items for which you want to search.</p> <p>The system displays the logged-in user ID. You can remove or change this default ID for your search.</p>
Status	<p>The status of the checklists for which you want to search.</p> <p><i>All</i>: The system searches for all checklist items regardless of status.</p> <p><i>Completed</i>: The system searches for only completed checklist items.</p> <p><i>Initiated</i>: The system searches for only checklist items that have been initiated but not yet completed.</p>
Search	Click this button to launch the search based on the selected criteria.

Click the Communication button to transfer to the Organization Communication page, where you can add a new communication for this organization.

Click the Checklist button to transfer to the Assigning a Checklist to an Organization, where you can add a new checklist for this organization.

Click the Comment button to transfer to the Organizational Comment Entry page, where you can enter a new comment for this organization.

To delete a checklist item, click the trash can button beside the row. When you delete a checklist, all subordinate checklist items are also deleted. Activate this icon using the **Allow Deletes from 3C Pages** group box on the Campus Community Installation page.

Code Item Status Tab

<i>Field or Control</i>	<i>Description</i>
Edit	<p>Click this link to access the Org Checklist Management 1 page, where you can edit the checklist.</p> <p>The Edit link is available only if the user has 3C group update access for this checklist code.</p>
View	<p>Click this link to access the Org Checklist Management 1 page, where you can view the checklist.</p> <p>The View link is available only if the user has 3C group inquiry access for this checklist code.</p>

Function and Contact Tab

Use the Function and Contact tab to determine the institution, administrative function, and checklist type associated with the checklist item. Also use it to determine the name of the contact person for the checklist item.

Viewing a Summary of Tracking Groups for an Organization

Access the Organization Tracking Summary page (**Campus Community > Checklist > Organization Checklists > Org Tracking Summary**).

Selection Criteria

If you click the **Search** button without entering any values, the system will search for all tracking groups that include this individual and display the results at the bottom of the page. You can enter a value or any combination of values to limit your search.

<i>Field or Control</i>	<i>Description</i>
Function	The administrative area on which to search.

Field or Control	Description
Variable Data	<p>The Variable Data link becomes available when a function is selected. Click the link to access the Variable Data page where you can enter the variable data associated with this administrative function for this individual.</p> <p>Variable data provides a powerful searching tool for reviewing checklists. By entering variable data as search criteria, you can limit the search to the results relevant to the specified function.</p>
Tracking Group	The tracking group on which to search.
Status	<p>The status of the checklists for which you want to search.</p> <p><i>All:</i> The system searches for all checklist items regardless of status.</p> <p><i>Completed:</i> The system searches for only completed checklist items.</p> <p><i>Initiated:</i> The system searches for only checklist items that have been initiated but not yet completed.</p>

Track Group Detail

Field or Control	Description
View	<p>If the user has 3C group inquiry access for this checklist code and the administrative function is not <i>General</i>, this link is available.</p> <p>Click this link to access the Tracking Group Detail page where you can view the checklist.</p> <hr/> <p>Note: If the function is <i>General</i>, the link might appear on the page, but it will not transfer you.</p> <hr/>

Viewing a Summary of Checklists in a Tracking Group for an Organization

Access the Tracking Group Detail page (click the **View** link on the Organization Tracking Summary page).

This page is for viewing purposes only. You cannot enter or modify data here.

Click the **View** link to access the Org Checklist Detail 1 page for the checklist code.

Viewing Tracking Group Data

Access the Organization Tracking Inquiry page (**Campus Community > Checklists > Organization Checklists > Org Tracking Inquiry**).

This page is for viewing purposes only. You cannot enter or modify data here. Click the **Variable Data** button to access the Variable Data page where you can review the variable data associated with this tracking group.

Reviewing Checklists for Events

This section discusses how to view all checklist items assigned to an event.

Page Used to Review Checklists for Events

<i>Page Name</i>	<i>Definition Name</i>	<i>Navigation</i>	<i>Usage</i>
Event Checklist Summary	EVENT_CHKLST_SUMM	Campus Community > Checklists > Event Checklists > Event Checklist Summary	Review all of the checklist items assigned to an event.

Viewing All Checklist Items Assigned to an Event

Access the Event Checklist Summary page (**Campus Community > Checklists > Event Checklists > Event Checklist Summary**).

Note: Multiple views of this page are available by clicking the tabs in the scroll area. We document fields that are common to all views first.

Common Page Information

If you click the **Search** button without entering any values, the system will search for all checklists for this organization and display the results at the bottom of the page. You can enter a value or any combination of values to limit the search.

<i>Field or Control</i>	<i>Description</i>
Checklist	The checklist on which to search. The available checklists are from the Checklists page.
Checklist Type	The type of checklist (for example, <i>Condition List</i> , <i>Communication List</i> , or <i>Requirements List</i>) for which you want to search.

Field or Control	Description
Responsible ID	<p>The ID of the individual who is associated with, or responsible for, the checklists items for which you want to search.</p> <p>The system displays the logged-in user ID. You can remove or change this default ID for your search.</p>
Status	<p>The status of the checklists for which you want to search.</p> <p><i>All:</i> The system searches for all checklist items regardless of status.</p> <p><i>Completed:</i> The system searches for only completed checklist items.</p> <p><i>Initiated:</i> The system searches for only checklist items that have been initiated but not yet completed.</p>
Search	<p>Click this button to launch the search based on the selected criteria.</p>

Code Item Status Tab

Field or Control	Description
View	<p>Click to access the Event Checklist Management 1 page where you can view the checklist.</p> <p>The View link is available only if the user has 3C group inquiry access for this checklist code.</p>

Meeting and Contact Tab

Use the Meeting and Contact tab to determine the institution, administrative function, and checklist type associated with the checklist item. Also use it to determine the name of the contact person for the checklist item.

Deleting Checklists

This section discusses how to delete checklists in batch.

Related Links

[Viewing a Summary of Checklist Item Status for an Individual](#)

Page Used to Delete Checklists

<i>Page Name</i>	<i>Definition Name</i>	<i>Navigation</i>	<i>Usage</i>
Delete Checklists	SCC_DEL_CHKLIST	Campus Community > Checklists > Delete Checklists	Define processing parameters to run the Delete Checklists process.

Deleting Checklists in Batch

Access the Delete Checklists page (**Campus Community** > **Checklists** > **Delete Checklists**).

Select one or more parameters to narrow the set of checklists to be deleted. The **Academic Institution**, **Administrative Function**, and **Checklist Code** fields are required; all other parameter selections are optional. To define a subset of specific IDs for which you want to delete communications, use the Population Selection group box.

<i>Field or Control</i>	<i>Description</i>
Administrative Function	Select an administrative function. The values available here are defined on the Administrative Function Table.
Checklist Code	Select the code that identifies individual checklists, which are comprised of one or more checklist items. Checklist codes are defined on the Checklist Table page. The codes available are restricted by the user's 3C Group Security.
From Date and To Date	These fields are optional; however if used, both date fields must be completed and the From Date value must precede the To Date value.

Use the Population Selection group box to define a set of IDs, select a PS Query or define an external file. Queries available for selection have the 3C Delete Bind Record "SCC_3CDEL_BND" included in the query. IDs returned by the Population Selection process apply to all Checklist Preference rows in the component.

After you specify the parameters, you can run the SCC_3CD_CHK Application Engine process by clicking the **Run** button. When you click the **Run** button, the system searches for all checklists matching the parameters specified on this page and deletes them. Only the target checklist items are deleted and any related communications and comments remain, while maintaining the relationships between the relevant 3C tables.

Note: A user's 3C group must have the **Inquiry Indicator** selected to be able to see anything associated with it and so delete it.

Using the Student Services Center Component

Setting Up the Student Services Center Component

Use the Student Services Center Setup page to control the order in which the tabbed pages appear in the Student Services Center component and to define the labels used on the tabs. Also, select the information that you want to make available to administrative users on each page of the Student Services Center component. The available information appears or does not appear for a user based on the user's security.

This section discusses how to set up the Student Services Center component.

Page Used to Set Up the Student Services Center Component

<i>Page Name</i>	<i>Definition Name</i>	<i>Navigation</i>	<i>Usage</i>
Student Services Center Setup	SCC_SUM_CFG	Set Up SACR > Common Definitions > Student Services Center Setup	Select the information to display in the Student Services Center component.

Setting Up the Student Services Center Component

Access the Student Services Center Setup page (**Set Up SACR > Common Definitions > Student Services Center Setup**).

This example illustrates the fields and controls on the Student Services Center Setup page (1 of 2). You can find definitions for the fields and controls later on this page.

Student Services Center Setup

	Tab Label	Tab Position
Student Center	Student Center	1
General Information	<input type="text" value="General Info"/>	<input type="text" value="2"/>
Admissions	<input type="text" value="Admissions"/>	<input type="text" value="3"/>
Academics	<input type="text" value="Academics"/>	<input type="text" value="5"/>
Finances	<input type="text" value="Finances"/>	<input type="text" value="6"/>
Financial Aid	<input type="text" value="Financial Aid"/>	<input type="text" value="7"/>
Transfer Credit	<input type="text" value="Transfer Credit"/>	<input type="text" value="4"/>

General Information

<input checked="" type="checkbox"/> Service Indicators	<input checked="" type="checkbox"/> Initiated Checklists
<input checked="" type="checkbox"/> Student Groups	<input checked="" type="checkbox"/> Personal Data
<input checked="" type="checkbox"/> National ID	<input checked="" type="checkbox"/> Names
<input checked="" type="checkbox"/> Addresses	<input checked="" type="checkbox"/> Phones
<input checked="" type="checkbox"/> Email Addresses	

Admissions

- Application Data
- Application Recruiters
- Applicant Progression
- External Education
- Test Summary

Academic Records

- Student Program Data
- Term Summary
- Classes
- Statistics

Transfer Credit

- Course Credits
- Test Credits
- Other Credits

This example illustrates the fields and controls on the Student Services Center Setup page (2 of 2). You can find definitions for the fields and controls later on this page.

Student Financial	
<input checked="" type="checkbox"/> Tuition Calculation	<input checked="" type="checkbox"/> Bills
<input checked="" type="checkbox"/> Due Charges	<input checked="" type="checkbox"/> Payment Plans
<input checked="" type="checkbox"/> Refunds	<input checked="" type="checkbox"/> Credit History and Collection
<input checked="" type="checkbox"/> Override Student Waiver	

Financial Aid	
<input checked="" type="checkbox"/> Financial Aid Status	
<input checked="" type="checkbox"/> Award Summary	
<input checked="" type="checkbox"/> Term Summary	

Enter tab labels and tab positions (2-7), as you want them to appear in the Student Services Center component. If you try to save duplicate tab positions, an error message occurs.

Tab labels and positions are listed as delivered. You can modify all but the Student Center tab label and position. The Student Center tab is hard coded to be the first tab, which provides the administrative user quick access to the same view as the individual has on the Student Center page in PeopleSoft Campus Self Service.

Note: Each tab of the Student Services Center component acts as a separate component. This enables you to use standard PeopleTools security to set individual security access to the tabs. If you do not want a tab to appear, do not give anyone access to it in PeopleTools security and the page will not appear. Users must have access to the Student Center tab to have access to any of the other tabs.

Select the information that you want to make available on the General Information, Admissions, Academics, Transfer Credit, Student Financials (Finances), and Financial Aid pages.

The available information will then appear or not appear for a specific administrative user depending on the security set for that user on the Academic Institution Security, Institution/Career Security, Academic Program Security, Academic Plan Security, Application Center Security, Test ID Security, 3C Groups, and Service Indicators components. The user's Demographic Data Access (DDA) security also applies to either mask or display the student's national ID and date of birth.

If a user has multiple security levels upon redirection to core components from the Student Services Center, the highest level of access security is used. For example, if a user has corrections-access to a component from one menu and read-only access to the same component from another menu, the corrections access is granted when the user is redirected to the component.

Note: Information that appears on the Student Center tab is controlled on the Student Center Options page (**Set Up SACR > Common Definitions > Self Service > Student Center**). The setup on this page does not override Campus Solutions security setup.

Viewing and Editing an Individual's Information

Use the Student Services Center component to view and access detailed information about a student or other individual.

Note: Only current and future-dated information appears in the Student Services Center component.

This section discusses how to:

- View an individual's Student Center information.
- View an individual's general information.
- View a student's admissions information.
- View a student's transfer credit information.
- View a student's academics information.
- View a student's self-service finances information.
- View a student's self-service financial aid information.

Related Links

[Setting Up the Student Services Center Component](#)

Pages Used to View and Edit an Individual's Information

<i>Page Name</i>	<i>Definition Name</i>	<i>Navigation</i>	<i>Usage</i>
Student Center	SSS_STUDENT_CENTER	Campus Community > Student Services Center > Student Center	Provides administrator ability to see what a specific individual, such as a student, sees on the Student Center self-service page.
General Information	SCC_SUM_PERSONAL	Campus Community > Student Services Center > General Information	Provides administrator at-a-glance overview of the individual's personal information with access to further detail such as initiated checklist items, service indicators and student groups.
Admissions	SCC_SUM_ADMISSIONS	Campus Community > Student Services Center > Admissions	Provides administrator access to the student's self-service Admissions View with access to further detail.

Page Name	Definition Name	Navigation	Usage
Transfer Credit	SCC_SUM_TRNSFRCDT	Campus Community > Student Services Center > Transfer Credit	Provides administrator overview of a specific student's transfer credit information with easy access to transfer credit transactions.
Academics	SCC_SUM_ACADEMICS	Campus Community > Student Services Center > Academics	Provides administrator overview of a specific student's academic information with easy access to academics transactions.
Finances	SCC_SUM_FINANCES	Campus Community > Student Services Center > Finances	Provides administrator overview of a specific student's financial information with easy access to finances transactions.
Financial Aid	SCC_SUM_FA	Campus Community > Student Services Center > Financial Aid	Provides administrator overview of a specific student's financial aid information with easy access to financial aid transactions.

Viewing an Individual's Student Center Information

Access the Student Center page (**Campus Community > Student Services Center > Student Center**).

This example illustrates the fields and controls on the Student Center page. You can find definitions for the fields and controls later on this page.

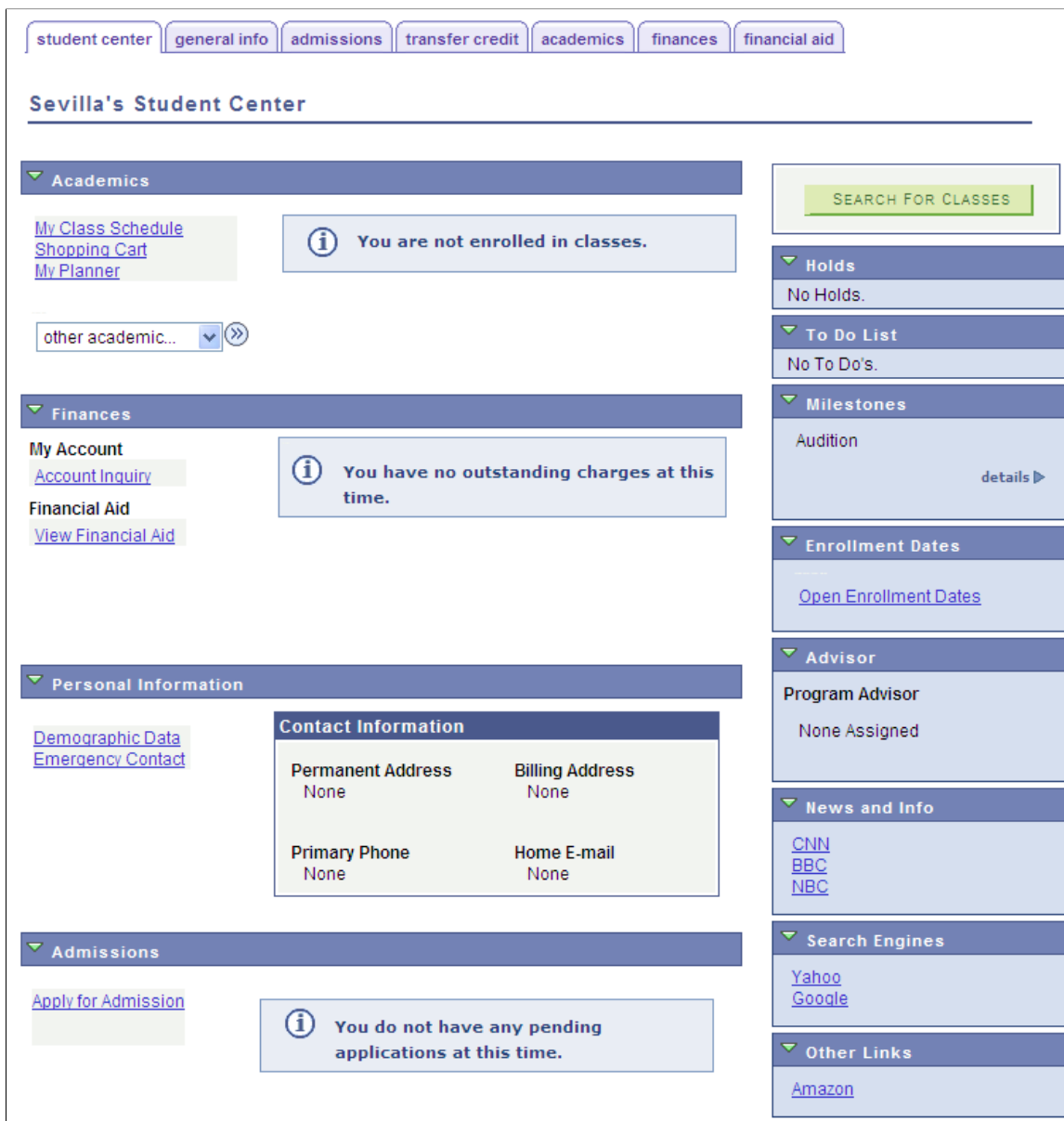

This page provides the same view of the self-service Student Center page as the self-service user sees. Clicking any of the buttons or links on this page takes the administrator to the same self-service destinations.

Enroll in Direct Deposit is available in the **other financial** field only if the **Direct Deposit Enrollment** check box is selected on the SF Institution Set - General Options page.

See “Setting Up Installation Parameters and Keywords” (Student Financials).

Note: When you click the **Demographic Data** link in the Personal Information section of the General Information page, DDA security (masking of the national ID or date of birth) is enforced. This way the administrative user will not see sensitive information that he or she is allowed to see from other pages or search records. The masking configuration applies for administrative users viewing the Student Center page from the Student Services Center.

See “Applying Demographic Data Access Security” (Campus Solutions Application Fundamentals).

Viewing an Individual's General Information

Access the General Information page (**Campus Community > Student Services Center > General Information**).

This example illustrates the fields and controls on the General Information page (1 of 4). You can find definitions for the fields and controls later on this page.

Albert Gerhling
ID: CC0006
🚫 ★ 📧

student center
general information
admissions
academics
finances
financial aid
transfer credit

Service Indicators

Student Groups

National ID

Addresses

Email Addresses

Initiated Checklists

Personal Data

Names

Phones

COLLAPSE ALL
EXPAND ALL

▼ Service Indicators
edit service indicators

★ Positive
 🚫 Negative

Service Indicators		Customize View All		First	1-3 of 3	Last
Type	Details	Active Term	Active Date	Department		
🚫	Library Fines	Begin Term - Srvc Indicatr Use	07/20/2004	Human Resources		
★	President	Begin Term - Srvc Indicatr Use	07/20/2004	Human Resources		
🚫	tst	Begin Term - Srvc Indicatr Use	09/22/2005	Human Resources		

📄 Go to top

This example illustrates the fields and controls on the General Information page (2 of 4). You can find definitions for the fields and controls later on this page.

▼ **Initiated Checklists**
review checklist summary

Filter data by	Operator	Value
<input type="text"/>	<input type="text"/>	<input type="text"/>
<input type="text"/>	<input type="text"/>	<input type="text"/>

filter
show all

Checklists			
Function	Checklist	Institution	Variable Data
ADMA	UGALL - UG Appl Requirements - All	PSUNV	Academic Career: UGRD Student Career Nbr: 0 Application Nbr: 00024205
▶ Checklist Items			
ADMA	MF - MF	PSUNV	Academic Career: UGRD Student Career Nbr: 0 Application Nbr: 00024205
▶ Checklist Items			
GEN	BUSAPP - Grad Business Appl Requirement	PSUNV	
▶ Checklist Items			
GEN	WSURV - Web survey	PSUNV	
▶ Checklist Items			

Go to top

This example illustrates the fields and controls on the General Information page (3 of 4). You can find definitions for the fields and controls later on this page.

▼ **Student Groups**
edit student groups

Student Group	Description	Institution	Status
360	360	PeopleSoft University	Active as of 2005-09-22
361		PeopleSoft University	Active as of 2005-09-22
362	362	PeopleSoft University	Inactive as of 2005-09-22

[Go to top](#)

▼ **Personal Data**
edit personal data

Campus ID:

Date of Birth: **/**/****

Gender: Male

Marital Status: Married

[Go to top](#)

▼ **National ID**
edit national ids

Country	National ID Type	National ID	Primary NID
USA	Social Security Number	*****	<input checked="" type="checkbox"/>

[Go to top](#)

▼ **Names**
edit names

Name Type	Display Name	Status
Preferred	Albert Gerhling	Active as of 1989-02-02
Primary	Albert bijgenaamd Gerhling	Active as of 2005-10-05

[Go to top](#)

This example illustrates the fields and controls on the General Information page (4 of 4). You can find definitions for the fields and controls later on this page.

▼ **Addresses**
edit addresses

Address Type	Address	Status
Business	987 Business Street Fresno, CA 91367	Active as of 2004-09-27
Campus	123 Campus Street Los Angeles, CA 94588	Active as of 2004-09-27
Dormitory	123 Dorm Street Sacramento, CA 94588	Active as of 2004-09-27
Home	5607 Gerhaustrasse Dehliz Stuggart	Active as of 1989-02-02

▲ [Go to top](#)

▼ **Phones**
edit phones

No phones found.

▲ [Go to top](#)

▼ **Email Addresses**
edit email addresses

No email addresses found.

▲ [Go to top](#)

This page provides an overview of the individual's general information from components in the Campus Community menu and the Student Groups component available from Admissions, Student Records, and other menus.

Individuals can see some of the same information from the self-service Campus Personal Information menu.

Note: If an administrative user does not have security access to a feature on the General Information page, the action button related to that information is not available so that the user cannot see or update the information in the core component. For example, if an administrative user does not have access to the core Service Indicator Data page, the **Edit Service Indicators** button is not displayed.

This table lists the actions available on the General Information page and the core component to which the user is redirected for more detail:

<i>Action Button</i>	<i>Destination Component and 1st Page</i>	<i>Core Navigation</i>	<i>Self-Service Navigation</i>
Edit Service Indicators	SERVICE_IND_PERS SRVC_IND_DATA1	Campus Community > Service Indicators > Person > Manage Service Indicators	Self Service > Campus Personal Information > Holds

Action Button	Destination Component and 1st Page	Core Navigation	Self-Service Navigation
Review Checklist Summary	CHKLST_SUMM_PERS PERS_CHKLST_SUMM	Campus Community > Checklists > Person Checklists > Person Checklist Summary	Self Service > Campus Personal Information > To Do List
Edit Student Groups	STDNT_GROUPS_PERS STDNT_GROUPS	Records and Enrollment > Career and Program Information > Student Groups	None
Edit Personal Data	SCC_BIO_DEMO SCC_BIO_DEMO_PERS	Campus Community > Personal Information > Add/Update a Person > Biographical Details	Self Service > Campus Personal Information > Demographic Information
Edit National IDs	SCC_BIO_DEMO SCC_BIO_DEMO_PERS	Campus Community > Personal Information > Add/Update a Person > Biographical Details	Self Service > Campus Personal Information > Demographic Information
Edit Names	NAMES_PERS SCC_NAMES_89	Campus Community > Personal Information > Biographical > Names	Self Service > Campus Personal Information > Names
Edit Addresses	ADDRESS_MAINT ADDRESSES_89	Campus Community > Personal Information > Biographical > Addresses/Phones > Addresses	Self Service > Campus Personal Information > Addresses
Edit Phones	PHONE_PERS PHONE_PERS	Campus Community > Personal Information > Biographical > Addresses/Phones > Phones	Self Service > Campus Personal Information > Phone Numbers
Edit Email Addresses	E_MAIL_ADDR_PERS E_ADDR_PERS	Campus Community > Personal Information > Biographical > Addresses/Phones > Electronic Addresses	Self Service > Campus Personal Information > Email Addresses

Viewing a Student's Admissions Information

Access the Admissions page (**Campus Community > Student Services Center > Admissions**).

This example illustrates the fields and controls on the Admissions page (1 of 3). You can find definitions for the fields and controls later on this page.

Patricia Cassidy		ID: AD2002	
student center	general info	admissions	transfer credit
academics	finances	financial aid	
Institution / Career / Application Nbr / Program		edit application data	
<ul style="list-style-type: none"> └─ GLAKE - Great Lakes University <ul style="list-style-type: none"> └─ UGRD - Undergraduate <ul style="list-style-type: none"> └─ 00024184 <ul style="list-style-type: none"> └─ A&S - Arts & Sciences └─ PSUNV - PeopleSoft University <ul style="list-style-type: none"> └─ GRAD - Graduate <ul style="list-style-type: none"> └─ 00024187 <ul style="list-style-type: none"> └─ GLAU - Graduate Liberal Arts Programs └─ UGRD - Undergraduate <ul style="list-style-type: none"> └─ 00024186 <ul style="list-style-type: none"> └─ FAU - Fine Arts Undergraduate └─ 00024185 <ul style="list-style-type: none"> └─ LAU - Liberal Arts Undergraduate └─ AS - Associate of Science 	Application Nbr: 00024185 Program Nbr: 1 Program Status: Applicant as of 09/12/2005 Program: AS Associate of Science Plan: LANAS Local Area Network and Adm Ser		
	Last School Attended: Mesa Community College City: 1Mesa State: AZ Graduation Date: 05/15/2005		
	Financial Aid Interest: <input checked="" type="checkbox"/> Housing Interest: On Campus Housing		

This example illustrates the fields and controls on the Admissions page (2 of 3). You can find definitions for the fields and controls later on this page.

Application Recruiters					
Recruitment Group	Recruitment Category	Recruitment Sub-Category	Recruiter	Recruiter Type	Primary
Academic	Honors Stu		Irving Sullivan	Staff	<input type="checkbox"/>
Geographic Region	Region		John Chavez	Staff	<input checked="" type="checkbox"/>

Applicant Progression					
Prospect		Applicant		Student	
Institution	PeopleSoft University	Institution	PeopleSoft University	Institution	
Admit Type	First-Year	Admit Type	First-Year	Requirement Term	
Admit Term	2006 Fall	Admit Term	2006 Fall	Admit Term	
Recruiting Status	Inquiry	Program Status	Applicant	Program Status	
Status Date	09/08/2005	Program Action	Application	Program Action	
Referral Source	School Visit	Action Reason		Action Reason	
Source Date	09/08/2005	Action Date	09/12/2005	Action Date	

External Education edit education data

▼ 00000001 - Cottonwood High School

Transcript Information					
External Career	Data Nbr	Transcript Type	Transcript Status	Action	Date Received
High Schl	1	Official	Final	Received	09/08/2005

Education Summary						
External Career	Data Nbr	Acad Level	Summary Type	Attempted	Completed	GPA
High Schl	1	Postsecondary Senior	High School Overall	122.00	120.00	85.000

[External Courses](#) [External Degrees](#)

This example illustrates the fields and controls on the Admissions page (3 of 3). You can find definitions for the fields and controls later on this page.

000010032 - Mesa Community College

Transcript Information						
External Career	Data Nbr	Transcript Type	Transcript Status	Action	Date Received	
Undergrad	1	Official	Final	Desired		

Education Summary						
External Career	Data Nbr	Acad Level	Summary Type	Attempted	Completed	GPA
Undergrad	1	Postsecondary Sophomore	Undergraduate Second Year	15.00	15.00	3.500
Undergrad	1	Postsecondary Sophomore	Undergraduate Overall	62.00	60.00	3.650

[External Courses](#) [External Degrees](#)

Test Summary [edit student tests](#)

Filter data by: Operator: Value:

Test Results								
Test ID	Test Component	Test Score	Letter Score	Percentile	Test Date	Acad Level	Data Source	Date Loaded
ACT	COMP	28.00			05/15/2005	Freshman	ACT	09/08/2005
ACT	ENGL	28.00			05/15/2005	Freshman	ACT	09/08/2005
ACT	MATH	29.00			05/15/2005	Freshman	ACT	09/08/2005
ACT	READ	28.00			05/15/2005	Freshman	ACT	09/08/2005
ACT	SCIRE	29.00			05/15/2005	Freshman	ACT	09/08/2005

This page provides an overview of information from components in the Student Admissions menu. Students can see some of the same information from the self-service Student Admission Application status menu.

This table lists the actions available on the Admissions page and the core component to which the user is redirected for more detail:

Action Button	Destination Component and 1st Page	Core Navigation	Self-Service Navigation
Edit Application Data	ACAD_HISTORY_PERS ADM_APPL_PROG_MNT	Student Admissions > Application Maintenance > Maintain Applications	Self Service > Student Admission > Application Status
Edit Education Data	ACAD_HISTORY_PERS EXT_ACAD_DATA	Student Admissions > Application Entry > Academic Information > Education or Records and Registration > Transfer Credit Evaluation > External Education	None

Action Button	Destination Component and 1st Page	Core Navigation	Self-Service Navigation
Edit Student Tests	ACAD_TST_RSLT_PERS STDNT_TEST_SCORE	Student Admissions > Application Entry > Academic Information > Test Results	None

Viewing a Student's Transfer Credit Information

Access the Transfer Credit page (**Campus Community > Student Services Center > Transfer Credit**).

This page provides an overview of information from components in the Records and Enrollment menu. Students can also see some of the same information from the self-service View Transfer Credit Report menu.

Viewing a Student's Academics Information

Access the Academics page (**Campus Community > Student Services Center > Academics**).

This page provides an overview of information from components in the Records and Enrollment menu. Students cannot see this information from PeopleSoft Campus Self Service.

This table lists the actions available on the Academics page and the core component to which the user is redirected for more detail:

Action Button	Destination Component and 1st Page	Core Navigation	Self-Service Navigation
Edit Student Program Data	ACAD_PLAN STDNT_PROG	Records and Enrollment > Career and Program Information > Student Program/Plan	None
Edit Student Term Data	STDNT_ACTIVATION STDNT_ACTIVATION	Records and Enrollment > Student Term Information > Term Activate a Student > Term Activation	None

Viewing a Student's Self-Service Finances Information

Access the Finances page (**Campus Community > Student Services Center > Finances**).

This example illustrates the fields and controls on the finances page (1 of 2). You can find definitions for the fields and controls later on this page.

Karen Target
ID: SFWV0025

student center
general info
admissions
transfer credit
academics
finances
financial aid

Tuition Calculation Summary

- ↳ GLAKE - Great Lakes University
 - ↳ UGRD - Undergraduate
 - ↳ 0680 - 2012 Spring
- ↳ PSUNV - PeopleSoft University
 - ↳ GRAD - Graduate
 - ↳ 0685 - 2012 Summer
 - ↳ 0680 - 2012 Spring
 - ↳ UGRD - Undergraduate
 - ↳ 0680 - 2012 Spring

2012 Summer

Tuition Calc Required: Yes

Last Calculated on: 24/09/2012 16:01

Primary Program: GLAU Graduate Liberal Arts Programs

Tuition Group: WV_TERM Calc by Term

Total Tuition and Fees: 1,200.00 USD

Total Waiver: 130.00

Currency used is US Dollar.

▼ **Student Waiver Override**

Waiver	Attributes		
Waiver	Description	Type	Status
<u>TMOVGR</u>	Student Override	None	Active
<u>TMOVNT</u>	Net, Enable Student Override	Criteria	Active

Go to: [Student Waiver Override](#)

Account Summary

- ↳ GLAKE - Great Lakes University
 - ↳ GLAKE - Glake Bursar
- ↳ PSUNV - PeopleSoft University
 - ↳ PSUNV - PeopleSoft University Bursar

PeopleSoft University Bursar

Account Total Balance: 1,070.00 USD

Deposit Due: 0.00

Anticipated Aid: 0.00

Student Permissions: Not Granted

Go to: [Student Post](#)

1098-T- Student does not have 1098-T data

Currency used is US Dollar.

This example illustrates the fields and controls on the finances page (2 of 2). You can find definitions for the fields and controls later on this page.

▼ Due Charges

Due Date	Term	Item Description	Due Amount
25/09/2012	2012 Sum	Tuition	1,070.00

[Adjust Due Date](#)

▼ Refunds

Refundable Credits: 0.00 USD

Go to: [Refund Student](#)
[Manage Student Direct Deposit](#)

Last Refunded: 25/09/2012

Last Refund: 60.00 USD

Through: Accounts Payable

Refund Status: AP Interface Created

Country: United States

Address: 878 Main St
Encino, CA 91316

[View Student Refunds](#)

▼ Bills

Invoice Number: 1098TAXPSUNV0000000638

Invoice Date: 27/09/2012

Due Date: 04/10/2012

Total Billed: 1,070.00

Country: United States

Address: 878 Main St
Encino, CA 91316

[View Student Invoice Summary](#)

▼ Payment Plans

No Active Payment Plans were found.

Go to: [Assign to Payment Plan](#)

▼ Credit History and Collection

No Credit History was found.

Note: If you use a future date in the Assign Student Waiver page, the waiver does not appear in the Student Waiver Override region and the following message is displayed: *This student has future-dated waiver overrides.*

See “Assigning Student Waivers” (Student Financials).

Using the Finances Page

This page provides an overview of information from components in the Student Financials menu. Students cannot see this information from PeopleSoft Campus Self Service.

This table lists the actions available on the Finances page and the core component to which the user is redirected for more detail:

Action Button	Destination Component and 1st Page	Core Navigation	Self-Service Navigation
Calculate Tuition	TUITION_CALC STDNT_TUITION_CALC	Student Financials > Tuition and Fees > Tuition Calculation	None
View Student Account	ACCOUNT_VW ACCOUNT_SF	Student Financials > View Customer Accounts	None

1098–T

The **1098–T** link appears only for US institutions—the institution that appears in the Account Summary section of the finances page must have a value of *USA* in the **Country** field on the Academic Institution 1 page.

For US institutions, the link appears:

- Only if the **Use Electronic Statements** check box on the 1098–T TIN Detail setup page is selected.
- Only for students for whom 1098–T data has been generated.

If the **Use Electronic Statements** check box is not selected on the setup page, a message appears instead of the **1098–T** link on the finances page: *1098-T- TIN is not set to Use Electronic Statement.*

If 1098–T data is not available for a student, a message appears instead of the **1098–T** link on the finances page: *1098-T- Student does not have 1098-T data.*

Click the **1098–T** link to access the (Review 1098–T Data) 1098–T Data page. The page displays the most recent 1098–T data for the student in context—that is, the maximum sequence number in the **1098–T Status** group box.

On the 1098–T Data page, click the **View 1098–T** link to retrieve a 1098–T .pdf of the most recent 1098–T data.

The link is sensitive to the context in the 1098-T Status scroll area—that is, the .pdf is generated using the data in context.

See “Producing and Filing 1098-T Tax Forms” (Student Financials).

Manage Student Direct Deposit

Click the **Manage Student Direct Deposit** link to access the Manage Student Direct Deposit page with the context of student.

Note: The Search page does not appear.

Use the Manage Student Direct Deposit page to set up and edit direct deposit distributions for AP refunding for a student.

The **Manage Student Direct Deposit** link appears only if the **Refund Method** value on the Refund Setup page is *A/P* and the **Use Single Payment Voucher** option is selected in the **AP Refunding Option** group box on the SF Installation page.

Unlike the **Enroll in Direct Deposit** link in Student Center, this link is *not* dependent on SF Institution Set setup.

See:

- “Setting Up Installation Parameters and Keywords” (Student Financials)
- “Understanding Refunding Setup” (Student Financials)

Viewing a Student's Self-Service Financial Aid Information

Access the Financial Aid page (**Campus Community** > **Student Services Center** > **Financial Aid**).

This example illustrates the fields and controls on the Financial Aid page (1 of 2). You can find definitions for the fields and controls later on this page.

Jessica Lai **ID: FAD0125**

[student center](#)
[general info](#)
[admissions](#)
[transfer credit](#)
[academics](#)
[finances](#)
[financial aid](#)

Institution / Aid Year [view packaging status summary](#)

PSUNV - PeopleSoft University

2007 - Financial Aid Year 2006 - 2007

[2007](#)

- [2006 - Financial Aid Year 2005-2006](#)
- [2005 - Financial Aid Year 2004-2005](#)
- [2004 - Financial Aid Year 2003-2004](#)
- [2003 - Financial Aid Year 2002-2003](#)
- [2002 - Financial Aid Year 2001-2002](#)
- [2001 - Financial Aid Year 2000-2001](#)
- [2000 - Financial Aid Year 1999-2000](#)
- [1999 - Financial Aid Year 1998-1999](#)

Financial Aid Year 2006 - 2007

Dependency Status: Dependent w/Primary EFC

EFC Status: Official

Date Application Received: 11/12/2005

Correction Status:

Correction Status Date: n/a

Aid Application Status: Active

Package Status: Packaging Completed

Packaging Plan ID: DL_SEM_PKG DL_SEM_FL/SP

Review Status: Incomplete

INST Verification Status: Non Select

Verification Flag: Not Required

Verification Status: Not Selected

Fan Ltr Status: Initial

SAP: Undetrmine

Fed Year COA: 22,700.00

Prorated EFC: 56,411

Currency used is US Dollar.

This example illustrates the fields and controls on the Financial Aid page (2 of 2). You can find definitions for the fields and controls later on this page.

Award Summary For Aid Year 2007 [assign awards to a student](#)

Item Type	Description	Career	Offered	Accepted	Authorized	Disbursed
900000000312	Direct UnSub Stafford	UGRD	5,500.00	5,500.00	0.00	0.00
TOTAL			5,500.00	5,500.00	0.00	0.00

[Student Award Inquiry](#) **Currency used is US Dollar.**

Term Summary For Aid Year 2007 [maintain student fa term](#)

Term	Description	Term Source	Academic Level	FA Load	NSLDS Loan Year
0570	2006 Fall	Term	Junior	Full-Time	3rd Year
0580	2007 Spring	Term	Junior	Full-Time	3rd Year

[Student Budget](#)

This page provides an overview of information from components in the Financial Aid menu. Students cannot see this information from PeopleSoft Campus Self Service.

This table lists the actions available on the Financial Aid page and the core component to which the user is redirected for more detail:

Action Button	Destination Component and 1st Page	Core Navigation	Self-Service Navigation
View Packaging Status Summary	STDNT_AID_PACKAGE STDNT_AID_PACKAGE	Financial Aid > View Packaging Status Summary > Financial Aid Status	None
Assign Awards to a Student	AWARD_ENTRY_MC STDNT_AWARD_ENTRY3	Financial Aid > Awards > Awards Processing > Assign Awards to a Student > Student Aid Package	None
Maintain Student FA Term	STDNT_FA_TERM STDNT_FA_TERM	Financial Aid > Financial Aid Term > Maintain Student FA Term > FA Term	None

Adding Organizations to Your Database

Understanding Organizations

Organizations can include high schools, colleges or universities, community or civic groups, government entities, test and transcript data companies, office supply vendors, and so on. You can create a record for each organization and enter the location of the organization with telephone numbers and electronic addresses. You can enter persons at the organization with whom your institution maintains contact and specify the primary location, department, and contact person that your institution should use.

For schools, you can identify the subjects and courses that they offer, the types of transcripts they generate, and their term, grading, and credit structure. Maintaining this information helps to convert their information into an equivalent at your institution so you can evaluate it according to your requirements.

After you set up group types, contact types, and external subjects, terms, and courses, you can add organizations to your database and select from those items to help describe or identify each organization.

To add an organization to your system, create an organization record on the Organization Table page. When you enter data and save the record, the system assigns the next available sequential organization ID to that organization and adds the record to your database. That ID remains associated with the organization unless you change or delete it. You can use the organization name or its unique ID to access the record and update the organization information and specify primary contacts, locations, departments and so on.

Important! When you save the new organization record, the system does not notify you if a duplicate organization already exists. The system assigns the ID and adds the organization. To avoid creating duplicate records, configure the system to notify you of duplicates by using Search/Match to determine if an organization with the same data already exists in your database before adding the new one.

See [Using Search/Match](#).

When an organization is a supplier, you can identify it as a vendor and make note of the taxpayer identification number (TIN).

When an organization is also a school or other institution that offers courses, you can identify and track the subject areas that the organization offers and the specific courses that it offers within that subject area. Maintaining subject and course data is especially valuable when evaluating transcripts from other institutions.

You can identify items that are important to your institution's academic affiliations with organizations, including their grading structure and the types of transcripts that they generate. Maintaining this information helps you convert their information into an equivalent at your institution so that you can evaluate.

Warning! Before adding organizations or entering and updating data about them, you must be familiar with PeopleSoft applications, including the *Add*, *Update/Display*, *Include History*, and *Correct History* modes and the PeopleSoft system's method of applying effective dates with active or inactive status.

See *PeopleTools: Applications User's Guide*, "Understanding Effective Dates"

To create an organization record:

1. Select **Campus Community > Organization > Create/Maintain Organizations > Organization Table**.
2. Click the **Add a New Value** link at the bottom of the Organization Table - Find an Existing Value search page.

The Organization Table - Add a New Value search page appears with *NEW* in the **External Org ID** field.

3. Click the **Add** button.

The Organization Table page appears with ID of *NEW*.

Warning! If you overwrite the word *NEW* in the **External Org ID** field on the Organization Table - Add a New Value and manually enter an ID for the organization that you are adding, you disrupt the system's autonumbering sequence. A system administrator might need to intervene to correct the situation.

This example illustrates the fields and controls on the Example of the Organization Table - Add a New Value search page. You can find definitions for the fields and controls later on this page.



Organization Table

[Find an Existing Value](#) [Add a New Value](#)

External Org ID:

[Add](#)

This example shows the Organization Table page when you are adding a new record for a school:

This example illustrates the fields and controls on the Example of adding a new record on the Organization Table page (1 of 2). You can find definitions for the fields and controls later on this page.

Organization Table
Regional

External Org ID: NEW 📄 📅 💬

Organization Details
Find | View All | First 1 of 1 Last

***Effective Date:** 10/22/2012 📅 ***Status:** Active ▼ + -

***Description:**

Long Description:

Short Description: [Formal Description](#)

***Organization Type:** SCHL 🔍 🔄 School

***Proprietorship:** Public ▼

Active Locations
Personalize | Find | View All | 📄 📅 First 1 of 1 Last

Location	Description	Address	Effective Date	Primary
				<input type="checkbox"/>

Primary Location: 🔍 Locations

Active Contacts
Personalize | Find | View All | 📄 📅 First 1 of 1 Last

Contact	Name	Type	Job Title	Effective Date	Primary
					<input type="checkbox"/>

Primary Contact: 🔍 Contact Type Preferred Contacts

Active Departments
Personalize | Find | View All | 📄 📅 First 1 of 1 Last

Department	Description	Type	Effective Date	Primary
				<input type="checkbox"/>

This example illustrates the fields and controls on the Example of adding a new record on the Organization Table (2 of 2). You can find definitions for the fields and controls later on this page.

Primary Department: 🔍 Departments

Vendor Information

SetID:

Vendor ID:

Taxpayer ID:

Organization Type Related Information

[Organization School Data](#)

[School Subject Maintenance](#)

[School Course Classification](#)

Last Update Date/Time: by:

Note: The links displayed in the **Organization Type Related Information** group box are determined by the Organization Type you enter. If links are not defined as part of the organization type setup, such as *Student Financials*, *Third Party*, or *Other*, the **Organization Type Related** group box will not appear on the Organization Table page.

1. Enter at least the required data (**Effective Date, Status, Description, Organization Type, and Proprietorship**) in the **Organization Details** group box on the Organization Table page to add the new record.

Warning! If you select **Save** before completing the required data, you must use the Correct History mode to continue entering or modifying the effective-dated data.

2. Select **Save**.

The system assigns the next available unique organization ID to the record and adds it to your database.

Related Links

[Reviewing Organization Data](#)

[Defining Organization Groups and Contacts](#)

[Understanding External Data Load](#)

Creating Organization Records

This section lists prerequisites and discusses how to:

- Identify the organization.
- Identify the organization as a school.
- Identify the organization as a nonprofit, business, or foundation.

Prerequisites

Before adding an organization to the database, set up organization groups and types. If the organization is a school, also make sure that external subjects and terms are set up.

Pages Used to Create Organization Records

<i>Page Name</i>	<i>Definition Name</i>	<i>Navigation</i>	<i>Usage</i>
Organization Table	EXT_ORG_TABLE	<ul style="list-style-type: none"> • Campus Community > Organization > Create/Maintain Organizations > Organization Table • Contributor Relations > Constituent Information > Organizations > Organization Information > Organization Table • Student Admissions > Internship Contracts NLD > Organizations 	Identify the organization.
School Data	SCC_EXT_ORG_ADM	Campus Community > Organization > Create/Maintain Organizations > Organization School Data	Enter data that applies to an organization that offers courses.
Foundation	AV_ORG_FND_INFO	<ul style="list-style-type: none"> • Click the Foundation Information link on the Organization Table page. • Contributor Relations > Constituent Information > Organizations > Organization Information > Organization Foundation Info > Foundation 	Enter data that applies to an organization that is a foundation that issues grants.

Page Name	Definition Name	Navigation	Usage
Support Areas	AV_ORG_FND_SUPP	<ul style="list-style-type: none"> Click the Foundation Areas of Support link on the Organization Table page. Contributor Relations > Constituent Information > Organizations > Organization Information > Organization Foundation Info > Support Areas 	Enter data regarding a foundation's areas of interest and support.
Proposal Info	AV_ORG_FND_PROP	<ul style="list-style-type: none"> Click the Foundation Proposal Info link on the Organization Table page. Contributor Relations > Constituent Information > Organizations > Organization Information > Organization Foundation Info > Proposal Info 	Enter data regarding submitting proposals to the foundation.
Organizational Financial Info	AV_ORG_FIN_INFO	<ul style="list-style-type: none"> Click the Org Fin Info/ Constituent Type link on the Organization Table page. Contributor Relations > Constituent Information > Organizations > Organization Information > Organization Financial Info 	Enter financial data regarding a business, foundation, or nonprofit organization.

Identifying the Organization

Access the Organization Table page (**Campus Community > Organization > Create/Maintain Organizations > Organization Table**).

Note: When you create the record for the first time and you enter a description in the **Description** field and exit the field, the system automatically enters *Long Description*, *Short Description*, *Organization Type*, and *Proprietorship* field values. You can override these values.

Organization Details

<i>Field or Control</i>	<i>Description</i>
Formal Description	Click the link to enter a formal long name for the organization.
Organization Type	<p>Enter the type of organization (for example <i>BUSN</i> (Business), <i>FNDN</i> (Foundation), <i>SFTP</i> (Student Financials Third Party), <i>NONP</i> (Non-Profit), or <i>SCHL</i> (<i>School</i>) that describes this organization.</p> <p>Values for this field are set up when you define the organization type.</p>
Proprietorship	<p>Enter the type of primary owner or funding source (<i>Other</i>, <i>Private</i>, <i>Public</i>, or <i>Religious</i>) of this organization.</p> <p>Values for this field are delivered with the system as translate values. You can modify these translate values.</p>

See [Setting Up Organization Types](#).

Note: If you change the organization type, you must refresh the Organization Table page so that the links associated with the organization type appear in the **Organization Type Related Information** group box.

Active Locations

If you are creating this organization record for the first time, primary locations are unavailable. You can assign a primary location after you have set up locations on the Location Detail page, then from the Organization Table page for the locations entered you can select the primary location.

<i>Field or Control</i>	<i>Description</i>
Primary Location	<p>Click to access the Primary Location Look Up page where you can enter the primary location for the organization.</p> <p>When selected, the information associated with the primary location appears first in the list with the Primary check box selected.</p>
Locations	<p>Click to access the Location Detail pages where you can enter the organization's locations.</p> <p>All active locations appear in the Active Locations group box.</p>

See [Entering Organization Location Data](#).

Active Contacts

If you are creating this organization record for the first time, primary contact persons are not available. You must assign contacts to the organization on the Contact Detail page, then from the Organization Table page for the contacts entered you can select the primary contact and enter the preferred contact type. For each Contact Type such as Academic Advisor, Guidance Counselor, Proposal Coordinator, there may be multiple contacts. The user can indicate the Preferred Contact for each Contact Type of the organization. This is different then the Primary Contact which is the single, main contact for the organization. However, a Preferred Contact and a Primary Contact could be the same person. For example: Jane Smith is selected as the Preferred Contact for all Contact Type — Academic Advisors for Cottonwood High School Joe Franklin is selected as the Preferred Contact for all Contact Type — Guidance Counselors for Cottonwood High School. Jane Smith is also the Primary Contact for the Cottonwood High School.

<i>Field or Control</i>	<i>Description</i>
Primary Contact	Select a primary contact. When selected, the information associated with the primary contact appears first in the list with the Primary check box selected.
Contact Type Preferred	Click the Contact Type Preferred button to access the Contact Type Preferred page and enter the contact type.
Contacts	Click the Contacts button to access the Contact Detail pages where you can enter the contacts for the organization. All active contacts are listed in the Active Contacts group box.

See [Entering Organization Contact Data](#).

Active Departments

If you are creating this organization record for the first time, primary departments are not available. You must assign department to the organization on the Department Detail page, then from the Organization Table page for the departments entered you can select the primary department.

<i>Field or Control</i>	<i>Description</i>
Primary Department	Enter the primary location for the organization. When selected, the information associated with the primary department appears first in the list with the Primary check box selected.

Field or Control	Description
Departments	<p>Click the Departments button to access the Department pages where you can view or enter the departments for the organization.</p> <p>All active departments are listed with the Active Departments group box.</p>

See [Entering Organization Department Data](#).

Vendor Information

Field or Control	Description
SetID	Enter the setID of the department at your institution that does business with or is responsible for paying the bills from this vendor.
Vendor ID	Enter the vendor ID, the number or other descriptor that your institution uses for this vendor.
Taxpayer ID	Enter the taxpayer ID, this vendor's taxpayer identification number.

Organization Type Related Information

This table lists the organization type related information that displays for each organization type. Clicking the link enables you to access the pages where you can enter data about the type of organization. If you change the organization type from the school to another organization type, you must refresh the organization Table page so that the links associated with the organization type appear in the Organization Type Related Information group box.

Organization Type	Links
<i>SCHL (School)</i>	<p>Organization School Data</p> <p>School Subject Maintenance</p> <p>School Course Classification</p>
<i>SFTP (Student Financials Third Party)</i>	(None)
<i>KNCT (Knowledge Center)</i>	Organization School Data

Organization Type	Links
<i>NONP (Non-Profit)</i>	Organization Financial Info
<i>OTHR (Other)</i>	(None)
<i>BUSN (Business)</i>	Organization Financial Info
<i>FNDN (Foundation)</i>	Foundation Information Foundation Areas of Support Foundation Proposal Info Org Fin Info/Constituent Type

Identifying the Organization as a School

Access the School Data page (**Campus Community > Organization > Create/Maintain Organizations > Organization School Data**).

This example illustrates the fields and controls on the School Data page. You can find definitions for the fields and controls later on this page.

School Data

Org ID: 0053 Cottonwood High School 📄 📅 💬

Primary Location:

Organization Details Find | View All First ◀ 1 of 1 ▶ Last

***Effective Date:** 01/08/2006 ST ***Status:** Active ▼ + -

Offers Courses

School Characteristics	School Codes	System Default Values
<input checked="" type="checkbox"/> Accredited <input type="checkbox"/> Transcript Translation School Type Secondary ▼	ATP: FICE: ACT: IPEDS: NCES: 	Career: High Schl ▼ Term Type: Semester ▼ Unit Type: Carnegie ▼

Catalog Information

School District: SALT LAKE CITY SCHOOL DISTRICT

Shared Catalog

Catalog Org: SR1000 🔍 Community College 1

School Code: KCS011 🔍 Red River College

Organization Details

<i>Field or Control</i>	<i>Description</i>
Offer Courses	Select to indicate that this organization offers courses, whether or not the course offerings are central to the organization's mission.

School Characteristics

<i>Field or Control</i>	<i>Description</i>
Accredited	Select to indicate that this school is accredited.
Transcript Translation	Select to indicate that transcripts from this school are in a foreign language and must be translated.
School Type	Enter the type that describes this school. See “Setting Up School Types” (Recruiting and Admissions).

Warning! You must use the School Type Table setup page in the *LS_SCHL_TYPE_TABLE* component (**Set Up SACR > Common Definitions > External Education > School Type Table**) to set up or modify school type values for Campus Solutions pages.

HCM also uses school types, but these are defined inside the inside the SCHOOL_TYPE_TBL record in the SCHOOL_TYPE_TBL page of the SCHOOL_TYPE_TABLE component.

Note: If you implement Campus Solutions *and* a separate instance of PeopleSoft Human Capital Management, read the relevant documentation about CS-HCM Integration to understand the setup, functional, and technical implementation considerations. See:

“Integrating Person Data” (Campus Solutions Application Fundamentals)

“Integrating Setup Data” (Campus Solutions Application Fundamentals)

“Monitoring Integrations Using the Integrity Utility” (Campus Solutions Application Fundamentals)

See *Information Center: CS-HCM Integration for PeopleSoft Enterprise Campus Solutions* in My Oracle Support (ID 2091799.2).

School Codes

Enter the appropriate codes for this school.

System Default Values

Field or Control	Description
Career	<p>Displays the career level that is associated with this organization.</p> <p>Values for this field are delivered with the system as translate values. You can modify these translate values.</p>
Term Type	<p>Displays the term type that is associated with this organization.</p> <p>Values for this field are delivered with the system as translate values. You can modify these translate values.</p>
Unit Type	<p>Displays the credit or term type that further describes the term type associated with this organization.</p> <p>PeopleSoft Recruiting and Admissions uses this field for information only. For example, your admissions office might describe the external term as having a <i>Quarter</i> term unit type with a <i>No Credit</i> unit type value.</p> <p>Values for this field are delivered with the system as translate values. You can modify these translate values.</p>

Catalog Information

Field or Control	Description
School District	Enter the district in which this organization is located.
Shared Catalog	Select to indicate that this organization participates in a shared catalog with another school.
Catalog Org (catalog organization)	Enter the secondary school with which this organization shares a catalog.
School Code	Enter the code for the higher education institution with which this organization shares a catalog.

Identifying the Organization as a Non-Profit, Business, or Foundation

If your institution has licensed and implemented PeopleSoft Campus Solutions Contributor Relations, you can access the Foundation, Support Areas, and Proposal pages to set up an organization as a foundation.

You can also access the Financial Information page to enter financial information about a foundation, business, or nonprofit organization.

See “Defining an Organization's Foundation Information” (Contributor Relations).

Entering Regional Data

An organization's regional information includes the North American Industry Classification System (NAICS) codes for North America and OUAC data for Canada.

This section discusses how to enter regional data.

Page Used to Enter Regional Data

<i>Page Name</i>	<i>Definition Name</i>	<i>Navigation</i>	<i>Usage</i>
Regional	EXT_ORG_TBL_REG	<ul style="list-style-type: none"> • Campus Community > Organization > Create/Maintain Organizations > Organization Table • Contributor Relations > Constituent Information > Organizations > Organization Information > Organization Table 	Enter the organization's regional data.

Entering Regional Data

Access the Regional page (**Campus Community > Organization > Create/Maintain Organizations > Organization Table**).

North American Industry Classification System

The NAICS code is a six-digit classification code that identifies the industrial classification of the organization's primary economic activity. This information appears on the VETS-100 report. The government no longer uses the VETS-100 Unit Number for VETS-100 reporting. Use this field to enter the company number provided by the Department of Labor. Enter the agricultural, land, or energy-related classification that indicates the industry with which the organization is associated.

(CAN) OUAC Organization Data

Universities in Ontario, Canada use the Ontario Universities Application Center (OUAC) throughout their undergraduate admissions process. The OUAC collects much of the undergraduate admissions data

from various sources and electronically transmits the data to institutions in Ontario. You can enter OUAC organization data here.

See “Understanding External Applications from OUAC” (Recruiting and Admissions).

(NLD) Netherlands

<i>Field or Control</i>	<i>Description</i>
Academic Organization	Enter the academic organization that is available for Netherlands Internship Contracts.

Entering School-Related Data

This section discusses how to:

- Enter subjects offered by the organization.
- Enter the courses offered within a subject area.
- Set defaults for TS130 electronic transcripts.

Pages Used to Enter School-Related Data

<i>Page Name</i>	<i>Definition Name</i>	<i>Navigation</i>	<i>Usage</i>
School Subject Maintenance	SCHOOL_SUBJECTS	Campus Community > Organization > Create/Maintain Organizations > School Subject Maintenance	Enter subject areas offered by the school and relate them to subject areas that your institution offers.
School Course Classification	SCHOOL_COURSES	Campus Community > Organization > Create/Maintain Organizations > School Course Classification	Enter the courses offered for each of the organization's subject areas.
Organization TS130 Setup	ORG_E_ADDR_TS	Campus Community > Organization > Create/Maintain Organizations > Organization TS130 Setup	Enter defaults for sending TS130 electronic transcripts to a school.

Entering Subjects Offered by the Organization

Access the School Subject Maintenance page (**Campus Community > Organization > Create/Maintain Organizations > School Subject Maintenance**).

School Subject

<i>Field or Control</i>	<i>Description</i>
School Subject	Enter the subject offered by your institution for which you want to track the equivalent subject at an external school.

School Subject Details

<i>Field or Control</i>	<i>Description</i>
External Subject Area	Enter the broad external subject area, from the External Subject Table page, that encompasses this subject at your institution.

Entering the Courses Offered within a Subject Area

Access the School Course Classification page (**Campus Community > Organization > Create/Maintain Organizations > School Course Classification**).

School Course Number

<i>Field or Control</i>	<i>Description</i>
School Course Number	Enter the number of the external course, usually the catalog number.

School Course Details

<i>Field or Control</i>	<i>Description</i>
External Subject Area	Enter the code, from the External Subjects Table page, that describes the subject area of this external course. When courses have different names but are similar in subject—for example, Chemistry and Biology—you can represent both by the single subject that you select here, such as LABS (for Laboratory Science).
Career	Enter the career level (for example, <i>Undergraduate</i> , <i>Graduate</i> , or <i>PostDoc</i>) of this external course. Values for this field are delivered with the system as translate values. You can modify these translate values.

Field or Control	Description
Course Level	Enter the level (for example, <i>Freshman</i> , <i>Graduate</i> , or <i>Honors</i>) at which this course is offered. Values for this field are delivered with the system as translate values. You can modify these translate values.
External Course Type	Enter the external course type. Values for this field are delivered with the system as translate values. You can modify these translate values.

Setting Defaults for TS130 Electronic Transcripts

Access the Organization TS130 Setup page (**Campus Community** > **Organization** > **Create/Maintain Organizations** > **Organization TS130 Setup**).

Enter defaults for sending electronic transcripts to the school. You can specify a directory in which to save the files and send them regularly in a group as FTP or any way that you choose. Or, you can send the transcripts by email, in which case you must enter the destination email address.

When creating a TS130 request, you can override the default values.

Related Links

“Setting Up Electronic Transcript Processing” (Student Records)

Entering Affiliations with Organizations

This section lists prerequisites and discusses how to enter organization affiliation details.

Prerequisites

Before entering affiliation information, set up GPA types, grading schemes, grading bases, and transcript details.

Related Links

“Processing Transcripts for Individuals or Small Groups of Students” (Student Records)

Page Used to Enter Affiliations with Organizations

Page Name	Definition Name	Navigation	Usage
Organization Affiliation	EXT_ORG_AFFLTN	Campus Community > Organization > Create/Maintain Organizations > Organization Affiliation	Enter organization affiliations details.

Entering Organization Affiliation Details

Access the Organization Affiliation page (**Campus Community > Organization > Create/Maintain Organizations > Organization Affiliation**).

This example illustrates the fields and controls on the Organization Affiliation page. You can find definitions for the fields and controls later on this page.

Organization Affiliation

Org ID: 000000001 Cottonwood High School 📄 📅 💬

Affiliation Details Find | View All First ◀ 1 of 1 ▶ Last

Affiliation with Institution + -

*Academic Institution:

*GPA Type: 🔍 100 Point Scale A

*Grading Scheme: 🔍 External - Korean

*Grading Basis: 🔍 Graded

Transfer Credit Transcript Print

*Level of Detail: Include Transfer Credit in GPA

Details to Print:

Organization Groups Customize | Find | 📄 First ◀ 1-3 of 3 ▶ Last

*Group Type	*Group Code	
<input type="text" value="Acad Qual"/>	<input type="text" value="Average"/>	-
<input type="text" value="Feeder"/>	<input type="text" value="30+ Applicants"/>	-
<input type="text" value="Magnet"/>	<input type="text" value="Fine and Performing Arts"/>	-

Affiliation with Institution

Field or Control	Description
Academic Institution	Enter the institution with which this organization is affiliated.

Field or Control	Description
GPA Type	Enter the type of grade point average used by this organization.
Grading Scheme	Enter the type of grading scheme used by this organization.
Grading Basis	Enter the grading basis used by this organization.

Transfer Credit Transcript Print

Field or Control	Description
Level of Detail	<p>Enter the level of detail of the transfer credit to print on the transcript.</p> <p><i>Summary:</i> Indicates that the system prints the total transferred units and GPA on the student's transcript.</p> <p><i>Detail:</i> Indicates that the system prints the information that you specify in the Details to Print field.</p> <p>Values for this field are delivered with the system as translate values. You can modify these translate values.</p>
Include Transfer Credit in GPA	Select to include the transfer credit from this organization in the student's GPA.
Details to Print	<p>This is available only when you select <i>Detail</i> in the Level of Detail field. Select the details that you want the system to print on the transcript: <i>None</i>, <i>External Courses</i>, <i>External and Internal</i>, or <i>Internal Equivalent Course</i>.</p> <p>You should not modify these values.</p>

Organization Groups

Field or Control	Description
Group Type	Enter the type of group, from the Organization Group Table page, to which this organization belongs.
Group Code	Enter the code associated with the specified group type, which describes the group to which this organization belongs.

Chapter 64

Managing Organization Data

Understanding Organization Data

After adding an organization to your database, you can enter information about an organization's various locations, including its addresses and phone numbers. You can enter as many locations for an organization as you need. You can enter locations from the menu item Organization Locations or through the Organization Table page. After you enter this information, you can specify the primary location for the organization on the Organization Table page.

You can enter information about an organization's various department names, locations, and email addresses. You can enter as many departments for an organization as you need. You can enter information about the department directly from the menu item Organization Departments or from the Organization Table page. After you enter this information, you can specify the primary department for this organization.

You can enter information about the people that your institution should contact at an organization, including the person's name, job title, and telephone numbers. You can enter as many contacts for an organization as you need. You can enter information about the contact directly from the menu item Organization Contacts or from the Organization Table page. After you enter this information, you can specify the primary contact for this organization.

You can review lists of all the locations, departments, and contacts for an organization.

You need to assign codes to the external organization and define priority control records to prevent the deletion of organization IDs.

Related Links

[Creating Organization Records](#)

[Deleting Organization IDs](#)

[Changing an External Organization ID](#)

“Setting Up OUAC Organizations” (Recruiting and Admissions)

Common Element Used to Manage Organization Data

<i>Field or Control</i>	<i>Description</i>
View Primary Location	Click to access the Organization Primary Location page where you can view the primary location for the organization.

Entering Organization Location Data

This section lists prerequisites and discusses how to:

- View the location summary data.
- Identify the organization location data.

Prerequisites

Before entering or updating organization location data, you must create an organization record.

Related Links

[Defining Organization Groups and Contacts](#)

Pages Used to Enter Organization Location Data

<i>Page Name</i>	<i>Definition Name</i>	<i>Navigation</i>	<i>Usage</i>
Location Summary	ORG_LOC_EFFSUM	Campus Community > Organization > Create/Maintain Organization > Organization Locations. Click the Locations button on the Organization Table page.	View a summary of the location data.
Location Detail	ORG_LOCATIONS	Click the Location Details link on the Location Summary page.	Enter the physical or mailing address of the organization, the electronic addresses and the phone numbers for each location of an organization.
Edit Address	EO_ADDR_USA_SEC	Click the Edit Address link on the Location Detail page.	Enter address data for the organization's location.

Viewing the Location Summary Data

Access the Location Summary page (**Campus Community > Organization > Create/Maintain Organization > Organization Locations**).

This page list the locations for the organization and is used to access the Location Detail page where you enter location data.

Identifying the Organization Location Data

Access the Location Detail page (click the **Location Details** link on the Location Summary page).

Location

<i>Field or Control</i>	<i>Description</i>
Location	<p>Displays the number of this location in the list of locations for this organization.</p> <p>The system automatically assigns the next sequential number to each location that you add. You can manually override these numbers on the Organization Table page to rearrange the order of the locations.</p>

Location History

<i>Field or Control</i>	<i>Description</i>
Country	<p>Enter the country of the location. Labels in the address format for the specified country display so you can add or review the address of this location.</p> <hr/> <p>Note: You must enter a country in this field to enable access to the Edit Address page.</p> <hr/>
Edit Address	<p>Click to access the Edit Address page to add or modify the location address for the organization.</p> <p>Enter the address. Click the OK button to return to the Location Detail page where the address is displayed. Additional addresses for this organization are added from the Location Summary page.</p>

Electronic Address

<i>Field or Control</i>	<i>Description</i>
Email ID	Enter the email address for this location of the organization.
URL Address	Enter the URL address of the World Wide Web page for this location of the organization.
EDI Address	Enter the Electronic Data Interchange (EDI) address for this location of the organization.

Location Phones

<i>Field or Control</i>	<i>Description</i>
Phone Type	<p>Enter the type of phone number for this location (for example <i>Main, Campus, or Business</i>).</p> <p>Values for this field are delivered with the system as translate values. You can modify these translate values.</p>
Preferred	Select to indicate that this is the preferred phone number for the location.

Entering Organization Department Data

This section lists prerequisites and discusses how to:

- View the organization's department summary data.
- Identify the organization departments.

Prerequisites

Before entering or updating organization department data, you must enter the organization location data on the Organization Table page.

Related Links

[Entering Organization Location Data](#)

Pages Used to Enter Organization Department Data

<i>Page Name</i>	<i>Definition Name</i>	<i>Navigation</i>	<i>Usage</i>
Department Summary	ORG_DEPT_EFFSUM	<p>Campus Community > Organization > Create/Maintain Organization > Organization Departments</p> <p>Click the Departments button on the Organization Table page.</p>	View a summary of the department data.
Department Detail	ORG_DEPARTMENTS	Click the Department Details link on the Department Summary page.	Enter the department of the organization.

Viewing the Organization's Departments Summary Data

Access the Department Summary page (click the **Departments** button on the Organization Table page).

This page lists the departments for the organization and is used to access the Department Detail page where you enter department data.

Identifying the Organization Departments

Access the Department Detail page (click the **Department Details** link on the Department Summary page).

Department

<i>Field or Control</i>	<i>Description</i>
Department	<p>Displays the number of this department in the list of departments for this organization.</p> <p>The system automatically assigns the next sequential number to each department that you add. You can manually override these numbers on the Organization Table page to rearrange the order of the departments.</p>

See [Defining Organization Groups and Contacts](#).

Department History

<i>Field or Control</i>	<i>Description</i>
Department Type	<p>Enter the type, either <i>Academic</i> or <i>Administrative</i>, that describes this department.</p> <p>Values for this field are delivered with the system as translate values. You can modify these translate values.</p>
Contact	<p>Enter the main contact, from the Contact Details page, for this department.</p> <hr/> <p>Note: You cannot enter a contact for this department unless the contact is entered on the Contact Detail page.</p> <hr/>
Location	<p>Enter the location of the main contact, from the Location Detail page, for this department.</p>

Field or Control	Description
Add Contact	<p>Click to access the Contact Detail page to add a new contact for this department.</p> <p>When you have entered and saved the contact information, the contact appears on the Department Detail page.</p> <hr/> <p>Warning! You must enter the department data before entering a contact.</p> <hr/>
Add Location	<p>Click to access the Location Detail page to add a new location for this department.</p> <p>When you have entered the location, the contact appears on the Location Detail page.</p>

See [Creating Organization Records](#).

Electronic Addresses

Field or Control	Description
Email ID	Enter the email address for this department of the organization.
URL Address	Enter the URL address for the World Wide Web page for this department of the organization.

Department Phones

Field or Control	Description
Phone Type	<p>Enter the type of phone for this department.</p> <p>Values for this field are delivered with the system as translate values. You can modify these translate values</p>
Preferred	Select to indicate that this phone number is the preferred phone number to contact this department.

Entering Organization Contact Data

This section lists prerequisites and discusses how to:

- View the organization's contact summary data.
- Identify the organization's contacts data.
- Identify the preferred contact.

Prerequisites

Before entering or updating organization contact data, you must enter the organization department data.

Related Links

[Entering Organization Department Data](#)

Pages Used to Enter Organization Contact Data

<i>Page Name</i>	<i>Definition Name</i>	<i>Navigation</i>	<i>Usage</i>
Contact Summary	ORG_CNTC_EFFSUM	<p>Campus Community > Organization > Create/Maintain Organizations > Organization Contacts</p> <p>Click the Contacts button on the Organization Table page.</p>	View a summary of the contact data.
Contact Detail	ORG_CONTACTS	Click the Contact Details link on the Contact Summary page.	Specify the contact for the organization.
Addresses	ADDRESSES_89	Click the Addresses link on the Contact Detail page.	View or modify the list of addresses for the contact.
Contact Type Preferred	SCC_ORGCNTC_PRI	<p>Click the Contact Type Preferred button on the Organization Table page.</p> <p>Campus Community > Organization > Create/Maintain Organizations > Contact Type Preferred</p>	Enter the organization's preferred contact.

Viewing the Organization's Contact Summary Data

Access the Contact Summary page (click the **Contacts** button on the Organization Table page).

This page lists the contacts for the organization and is used to access the Contacts Detail page where you enter contact data.

Identifying the Organization's Contacts Data

Access the Contact Detail page (click the **Contact Details** link on the Contact Summary page).

Contact

<i>Field or Control</i>	<i>Description</i>
Contact	<p>Displays the number of this contact in the list of contacts for this organization.</p> <p>The system automatically assigns the next sequential number to each contact that you add.</p>

Contact History

<i>Field or Control</i>	<i>Description</i>
ID	Enter the ID of this contact person, if the person exists in your database.
Contact Name	<p>Enter the name of this contact person.</p> <p>If the person is in your database, the system automatically displays the person's name when you select the ID. If the person is not in your database, you must enter the name manually.</p>
Contact Type	<p>Enter the type of contact (for example, <i>Teacher</i>, <i>Principal</i>, <i>Guidance Counselor</i>, or <i>Primary Contact</i>) from the Contact Type Table page.</p> <p>Values for this field are delivered with the system as translate values. You can modify these translate values.</p>
Add Department	Click to access the Department Detail page to add the department for this contact.

Contact Address

<i>Field or Control</i>	<i>Description</i>
Department	Select to indicate that a department address should be used as the address for the contact.

<i>Field or Control</i>	<i>Description</i>
Location	Select to indicate that a location should be used as the address for this contact and enter the location.
Address Type	If the contact is one that has an ID in the system and this ID has one or many addresses, the user can then select an available address type (Business, Home, and so on) for this ID and it should be used as the address for this contact.
None	Select to indicate that no address is specified for this contact.
Add Location	Click to access the Location Detail page to add a location for this contact.

If you select the **Location** or **Address Type** option you must also specify which location or address type to use.

Click the **Refresh** icon to display the address data associated with the option that you select.

If the contact has an ID in the system, the **Addresses** link displays. Click to access the Addresses page where you can add a new address for this ID which is used as the contact address.

Electronic Addresses

<i>Field or Control</i>	<i>Description</i>
Email ID	Enter the email address for this contact in the organization.

Contact Phones

<i>Field or Control</i>	<i>Description</i>
Phone Type	Enter the type of phone for this contact. Values for this field are delivered with the system as translate values. You can modify these translate values.
Prefix	Enter the country code that precedes the phone number.
Phone	Enter the phone number for this contact.

Field or Control	Description
Extension	Enter the phone extension at which the contact can be contacted.
Preferred	Select to indicate that this phone number is the preferred phone number for this contact.

Identifying the Preferred Contact

Access the Contact Type Preferred page (click the **Contact Type Preferred** button on the Organization Table page).

If the individual is the preferred contact for this contact type, enter the individual's specific contact number in the **Contact** field. Contact numbers are assigned by the system on the Contact Summary page. Active contacts must be available for the specified contact type to identify it as a preferred contact.

Reviewing Organization Data

This section discusses how to:

- View location data.
- View primary location data.
- View school data.
- View phone data.
- View department data.
- View organization department details.
- View contact data.
- View organization contact details.
- View organizations by group types.

Pages Used to Review Organization Data

<i>Page Name</i>	<i>Definition Name</i>	<i>Navigation</i>	<i>Usage</i>
Organization Location Summary	EXT_ORG_LOC_SUM	<ul style="list-style-type: none"> • Campus Community > Organization > Review Organizations > Organization Location Summary • Contributor Relations > Constituent Information > Organizations > Organization Information > Location Summary 	Review all the locations for an organization.
Organization Primary Location	EXT_ORG_PRIM_LOC	Click the View Primary Location link on the Organization Location Summary page.	View data for the primary location for an organization.
Organization School Information	SCHOOL_INFO	Click the School Information link on the Organization Primary Location page.	View the school characteristics of an organization location.
Location Summary	ORG_DEPT_EFFSUM	Click the Pencil icon to display the Location Summary page.	View a summary of the location data.
Organization Phone Information	EXT_ORG_LOC_PHN	Click the Details link on the Organization Location Summary page.	View the phone and electronic address information for an organization location.
Organization Department Summary	EXT_ORG_DEPT_SUM	<ul style="list-style-type: none"> • Campus Community > Organization > Review Organizations > Organization Dept. Summary • Contributor Relations > Constituent Information > Organizations > Organization Information > Department Summary 	Review the departments for a specific organization.

Page Name	Definition Name	Navigation	Usage
Department Summary	ORG_DEPT_EFFSUM	Click the Pencil icon on the Organization Department Summary page.	View a summary of the department data.
Org Department Detail (organization department detail)	EXT_ORG_DEPT_DTL	Click the Details link on the Organization Department Summary page.	View the mailing and electronic addresses and phone information for this department.
Organization Contacts Summary	EXT_ORG_CNTCT_SUMM	<ul style="list-style-type: none"> • Campus Community > Organization > Review Organizations > Organization Contacts Summary • Contributor Relations > Constituent Information > Organizations > Organization Information > Contact Summary 	Review the contacts for a specific organization.
Contact Summary	ORG_CNTC_EFFSUM	Click the Pencil icon to display the Contact Summary page.	View a summary of the contact data.
Organization Contact Detail	EXT_ORG_CNTCT_DTL	Click the Details button on the Organization Contact Summary page.	View the mailing and electronic addresses and phone information for this contact.
Organization Groups Summary	ORG_GROUP_SUMM	Campus Community > Organization > Review Organizations > Organization Groups Summary	Review all organizations by group.

Viewing Location Data

Access the Organization Location Summary page (**Campus Community > Organization > Review Organizations > Organization Location Summary**).

The Organization Location Summary page is for viewing only. You cannot enter or modify data on this page. Information displayed here is from the Location Summary and Location Detail pages.

Organization Locations

Click the icon to the left of the Location field to access the Location Summary or Detail page where you can view or modify the contacts data.

<i>Field or Control</i>	<i>Description</i>
Details	Click to access the Organization Phone Information page where you can view the electronic address and phone numbers for this location of the organization.

Viewing Primary Location Data

Access the Organization Primary Location page (click the **View Primary Location** link on the Organization Location Summary page).

The Organization Primary Location page is for viewing purposes only. You cannot enter or modify data on this page. Information here is from the Organization Locations page.

Primary Location

<i>Field or Control</i>	<i>Description</i>
School Information	Click to access the Organization School Information page, where you can view the school characteristics for this organization location.

Viewing School Data

Access the Organization School Information page (click the **School Information** link on the Organization Primary Location page).

The Organization School Information page is for viewing purposes only. You cannot enter or modify data on this page. Information displayed here is from the School Data page.

Viewing Phone Data

Access the Organization Phone Information page (click the **Details** link on the Organization Location Summary page).

The Organization Phone Information page is for viewing purposes only. You cannot enter or modify data on this page. Information displayed here is from the Location Details page.

Viewing Department Data

Access the Organization Department Summary page (**Campus Community > Organization > Review Organizations > Organization Dept. Summary**).

Information displayed on this page is from the Department Summary page.

Select

<i>Field or Control</i>	<i>Description</i>
Department Type	Select <i>Acad Dept</i> or <i>Adm Dept</i> if you want to only display one department.

Organization Departments

Click the icon to the left of the Department field to access the Department Summary and Detail pages where you can view the department data.

<i>Field or Control</i>	<i>Description</i>
Details	Click to access the Org Department Detail (organization department detail) page where you view the physical or mailing address, the electronic address and the phone numbers for this department.

Viewing Organization Department Details

Access the Org Department Detail (organization department detail) page (click the **Details** link on the Organization Department Summary page).

The Org Department Detail (organization department detail) page is for viewing purposes only. You cannot enter or modify data on this page. Information displayed here is from the Department Detail page.

Viewing Contacts Data

Access the Organization Contacts Summary page (**Campus Community > Organization > Review Organizations > Organization Contacts Summary**).

Information displayed on this page is from the Contact Summary page.

Select

<i>Field or Control</i>	<i>Description</i>
Contact Type	Enter the contact type if you want to indicate a primary contact.

Organization Contacts

Click the icon to the left of the Contact Name field to access the Contact Summary page where you can view contact data.

<i>Field or Control</i>	<i>Description</i>
Details	Click the to access the Organization Contact Details page to view the mailing and electronic addresses, and phone information for this contact.

View Organization Contact Details

Access the Organization Contact Detail page (click the **Details** button on the Organization Contact Summary page).

The Organization Contact Detail page is for viewing purposes only. You cannot enter or modify data on this page. Information displayed here is from the Contact Detail page.

Viewing Organizations by Group Types

Access the Organization Groups Summary page (**Campus Community > Organization > Review Organizations > Organization Groups Summary**).

Selection Criteria

<i>Field or Control</i>	<i>Description</i>
Institution	The institution associated with the organizations to review.
Group Type	The type of group (<i>Academic Quality, Feeder, or Magnet</i>), from the Organization Affiliation page, to review. Note: Because the purpose of this page is to enable you to review a summary of organizations by group, you <i>must</i> specify a group type value.
Group Code	The group code, from within the group type, to review.

Sort By

<i>Field or Control</i>	<i>Description</i>
Search	Click to launch the search based on the selected criteria.

Managing Organization IDs

You can define priority control records to prevent the deletion of organization IDs. You can also change an organization's ID from the system-generated ID to another ID.

Related Links

[Controlling the Deletion of Individual IDs](#)

[Understanding ID Management](#)

Entering Codes for External Organizations

This section provides an overview of external organization codes, lists prerequisites, and discusses how to assign codes to external organizations.

Understanding External Organization Codes

You can enter and track external codes for organizations. You can load third-party external codes into your system, for example EPS or ATP codes, and view the results of the automated assignment process on the Organization External Codes page.

Related Links

[“Understanding EPS Market Codes” \(Recruiting and Admissions\)](#)

[Understanding External Data Load](#)

Prerequisites

Before assigning codes to external organizations, set up the code types from which to select.

Related Links

[Loading or Defining External Codes for Organization Types](#)

Page Used to Enter Codes for External Organizations

<i>Page Name</i>	<i>Definition Name</i>	<i>Navigation</i>	<i>Usage</i>
External Organization Codes	EXT_ORG_CODES	Campus Community > Organization > Create/Maintain Organizations > External Organization Codes	Assign or review codes for external organizations.

Assigning Codes to External Organizations

Access the External Organization Codes page (**Campus Community** > **Organization** > **Create/Maintain Organizations** > **External Organization Codes**).

Organization Code Types

<i>Field or Control</i>	<i>Description</i>
Ext Org Code Type (external organization code type)	The code, from the External Organization Code Table page, that applies to this organization.

EPS Information

<i>Field or Control</i>	<i>Description</i>
EPS Postal Code	<p>If the code type is set as an EPS code on the External Organization Code Table page, the EPS Postal Code field is available.</p> <p>If EPS codes are loaded into your system, you can select from the EPS postal codes for this organization.</p>
EPS Market Code	The system displays the EPS market code based on the EPS postal code.
EPS Market Name	The system displays the EPS market name based on the EPS postal code.

Loading External Organization Data

Understanding External Data Load

When you load data from an external source, you load it into a suspense table. You can then review the data in the suspense table and modify it. To load data into the suspense table, position the source file or tape, specify the location of the source, and run the appropriate load external data process.

PeopleSoft Process Scheduler runs the process and stores the data in the suspense tables. When it is finished, the PeopleSoft Process Scheduler displays a process instance number in the lower left corner of the screen. Use this number to review the data on the appropriate Suspense Process Options page.

Loading External ATP Data

This section provides an overview of loading ATP data and discusses how to:

- Specify the data source.
- Review suspense process options data.
- Review school address data.
- Review other school data.
- Review ATP data suspense messages.
- Review all ATP messages.
- Specify search parameters.
- Search for duplicate records and post the data.
- Purge ATP data from the suspense file.

Understanding ATP Data Load

When you schedule the process, PeopleSoft Process Scheduler runs the CCATPLOD.SQR process and stores the ATP data in the ATP suspense tables. When the process is finished, the PeopleSoft Process Scheduler displays a process instance number in the lower left corner of the screen. You can review the loaded data on the ATP Suspense Process Options page.

The ATP suspense tables hold records not yet posted to the organization tables. School data from these tables migrates to your database during the posting process based on the options that you select on the ATP Search Parameters and ATP Post Parameters pages.

You can review data in the ATP suspense table at any time during the ATP external data load process. You might want to look at the data immediately after loading it, after performing a search/match on it, or after posting it. You can determine if a record is yet to be processed, if a record was added to your database, and if any errors were encountered during the search/match or loading processes.

Note: If you have not yet posted the data, you can edit it on the ATP Suspense Table page. When editing data in the suspense tables, you must be careful not to create duplicate records that are added to the database during posting.

You may choose to correct errors on the appropriate pages before running the post process. When you make changes to fields in this component, click **Save**; the other fields are updated according to the revisions you made. For example, if the **Edit** field displayed *Error*, when you fix the errors in the file and save it, the program updates the **Edit** field to *Complete*.

You should always click **Save** before changing any of the processing options so that you can review the results of any data changes you made.

After loading the ATP data into a suspense table, run the ATP Search/Match process to check for duplicate matching records before posting the data. Each record in the ATP load contains a change code value — *Add*, *Change*, or *Delete* — that instructs the system to add the record as new or to change or delete the existing one. The Search/Match process investigates the database to identify conflicts between existing data and the data loaded for posting, and between existing data and the action required by the change code. You must decide what you want the system to do in the case of conflicts.

For example, if the change code is *Add*, and the system finds an existing record that matches the load data, the system does not update the existing data and add it for posting; you must decide whether the system should update the existing data, place that load data in suspense until you can investigate it further, or ignore and skip over it. You must also decide what the system should do if the change code is *Change* or *Delete* and it finds no matching record to change or delete.

After loading the ATP external data into the suspense table and selecting the parameters for the Search/Match process, run the CCATPPST.SQR process to post the data. You can process and post a single record or all records in the suspense table.

You can remove records from a ATP suspense table by running the ATP Purge Suspense File process.

The PeopleSoft Process Scheduler runs the CCATPPRG.SQR process and purges the designated records from the ATP suspense file. When it is finished, the organizations whose data was loaded are added to the database and organization IDs are assigned to them.

Before you load the external ATP data, you must set up ATP country names and school types. For information, see [Setting Up ATP Country Names and School Types](#).

Pages Used to Load External ATP Data

<i>Page Name</i>	<i>Definition Name</i>	<i>Navigation</i>	<i>Usage</i>
ATP Load External Data	ATP_LOAD_PARMS	Campus Community > Organization > Organizations Data Load > ATP Load External Data	Specify the source from which the load process should get the ATP data.

Page Name	Definition Name	Navigation	Usage
ATP Suspense Process Options	ATP_SUSP_PROC_OPTN	Campus Community > Organization > Organizations Data Load > ATP Suspense > ATP Suspense Process Options	Review and edit the status of data in the ATP Suspense Table.
ATP Suspense Address Data	ATP_SUSP_ADDRESS	Campus Community > Organization > Organizations Data Load > ATP Suspense > ATP Suspense Address Data	Review address information loaded for a specific school.
ATP Suspense Data	ATP_SUSP_DATA	Campus Community > Organization > Organizations Data Load > ATP Suspense > ATP Suspense Data	Review data other than address data for the school record loaded.
ATP Messages	ATP_SUSP_MESSAGE	Campus Community > Organization > Organizations Data Load > ATP Suspense > ATP Messages	Review and resolve ATP suspense messages.
ATP Messages	ATP_MESSAG_TABLE	Campus Community > Organization > Organizations Data Load > ATP Messages	Review any of the ATP data messages in your system.
ATP Search Parameters	ATP_SEARCH_PARMS	Campus Community > Organization > Organizations Data Load > ATP Search/Match/Post > ATP Search Parameters	Select search parameters to identify duplicate matching records before posting the data.
ATP Post Parameters	ATP_POST_PARMS	Campus Community > Organization > Organizations Data Load > ATP Search/Match/Post > ATP Post Parameters	Select parameters for posting the data.
ATP Purge Suspense File	ATP_PURGE_PARMS	Campus Community > Organization > Organizations Data Load > ATP Purge Suspense File	Purge data from the ATP Suspense Table.

Specifying the Data Source

Access the ATP Load External Data (**Campus Community > Organization > Organizations Data Load > ATP Load External Data**).

<i>Field or Control</i>	<i>Description</i>
College Data	If the ATP data is college data, specify the correct path to the input file here.
Secondary School Data	If the ATP data is secondary school data, specify the correct path to the input file here.

Reviewing Suspense Process Options Data

Access the ATP Suspense Process Options page (**Campus Community > Organization > Organizations Data Load > ATP Suspense > ATP Suspense Process Options**).

The top portion of this page displays information about the ATP record: the ATP record number, date loaded, input source, ATP code, and ATP name. You can override the ATP code and ATP name if necessary.

Processing Options

Values for the **Edit**, **Search**, and **Post** fields are delivered preset with the system.

Warning! You can manually edit the values in the **Edit**, **Search**, and **Post** fields; however, if any of these fields shows a status of *Error* and you manually change the status without correcting the error, you might have problems when posting the data.

<i>Field or Control</i>	<i>Description</i>
Edit	<p>The status of the record as the result of the load external data process.</p> <p><i>Complete:</i> The program was able to process this record without a problem.</p> <p><i>Error:</i> The program encountered problems when processing this record.</p> <p><i>Perform:</i> This value is only set manually and is for informational purposes.</p>

<i>Field or Control</i>	<i>Description</i>
Search	<p>The status of the record as the result of the Search/Match process:</p> <p><i>Complete:</i> The Search/Match process ran without errors.</p> <p><i>Error:</i> The Search/Match process ran and errors were detected in this record.</p> <p><i>Perform:</i> The Search/Match process was not yet run for this record or the Search/Match process is set so that the record will be re-selected.</p>

Field or Control	Description
Post	<p>The status of the record as the result of the post process. These values can be entered manually; however, some are entered by the system after processes are run, as described below:</p> <p><i>Delete ID:</i> The system encountered an indication that the organization was deleted from the tape.</p> <p>Set by the system during the Search/Match process if it is unable to add data to a deleted organization. Can also be set manually.</p> <p><i>Error:</i> The Post process encountered a problem.</p> <p>Set by the system during the Post process.</p> <p><i>New ID Add:</i> The system was unable to find a match in the database and will add a record with a new ID when the Post process is run, provided that the system finds no matches and an ATP change code of <i>Add</i>.</p> <p>Set by the system during the Search/Match process if no match is found and a new one is added.</p> <p><i>No Action:</i> This value is only added manually. It is not automatically entered by the system. If this value is entered, the Post and Purge processes ignore the record. Set manually.</p> <p><i>Purge:</i> This value indicates that this suspense record is removed from the system during the Purge process.</p> <p>Set by the system during the Post process if the record is successfully processed.</p> <p><i>Update ID:</i> The system found a matching ID in the database. This existing ID record is updated with the data from this ATP record during the Post process.</p> <p>Set by the system during the Search/Match process if a match is found in the database.</p> <p><i>Wait Search:</i> This record is in the Suspense Table and is waiting to be processed by the Search/Match process.</p> <p>Set by the system during the ATP Load External Data process.</p>

Error Indicators

When the *Error* indicator appears in the **Edit** field in the **Processing Options** group box, the **Error Indicators** group box identifies the type of error.

Note: Correct errors on the appropriate page before running the Post process. When you make and save the correction, the system updates the **Processing Options** group box fields accordingly. For example, if the **Edit** field value is *Error* and you fix the errors in the file so that the system now recognizes the data, when you save the change, the system changes the **Edit** field to *Complete*. You should always save before changing any of the processing options so that you can review the results of any data changes.

Field or Control	Description
Name Error	When selected, indicates that the system could not recognize the name data.
Foreign Address Error	When selected, indicates that the system could not recognize the address data or that the country of the address is not in the database.

Change Code Options

Field or Control	Description
Change Date	The system automatically displays the date when the ATP Load External Data process ran. You can change this date if necessary.
Change Code	<p>Instructs the system what to do with the record loaded by the ATP Load External Data process. The system automatically displays the value of <i>Add</i> for each record loaded by the process.</p> <p>Values for this field are delivered with the system. Do not modify these values in any way. Any modifications to these values could require substantial programming effort.</p> <p><i>Add:</i> Add the record loaded by the ATP Load process to the database as a new record.</p> <p><i>Change:</i> Change the existing record to reflect the record loaded by the ATP Load process.</p> <p><i>Delete:</i> Delete the record loaded by the ATP Load process.</p> <p>See Loading External ATP Data.</p>

Search/Match Results

<i>Field or Control</i>	<i>Description</i>
Matches	The number of matches that the Search/Match process found for this organization.

Note: You can view additional information about errors and other processing actions on the ATP Messages page.

Reviewing School Address Data

Access the ATP Suspense Address Data page (**Campus Community > Organization > Organizations Data Load > ATP Suspense > ATP Suspense Address Data**).

The external data load provides the information on this page. You can change the address information if necessary.

Reviewing Other School Data

Access the ATP Suspense Data page (**Campus Community > Organization > Organizations Data Load > ATP Suspense > ATP Suspense Data**).

<i>Field or Control</i>	<i>Description</i>
External Organization ID	The system displays the existing ID of the organization or, if none exists, assigns the next available new ID when you save.
Location Number	The address location number of this organization. The default location number when adding a new organization is one.
New Location Number	When selected, indicates that the system found that the organization exists in your database, but the location address was changed or added by the data load. You can overwrite the new location number by specifying a location number or clearing the New Location Number check box.
School Type	For the College data file, the system displays the school type if a value exists in the source file. For the Secondary School data file, the system displays the mapped LS School Type for the corresponding school type in the source file. You map the LS school types to ATP school types in the ATP School Type Table page.
Program In Years	For the College data file, the system displays the program in years if a value exists in the source file.

Field or Control	Description
Proprietorship	For the College data file, the system displays the proprietorship if a value exists in the source file. If the College data file does not contain a value, the system sets the proprietorship value to <i>Other</i> . Values for this field are delivered with the system. Do not modify these values in any way. Any modifications to these values could require substantial programming effort.
Status of Institution	For the College data file, the system displays the status of institution if a value exists in the source file.
Transcript Translation Required	When selected, indicates that the transcript from this organization needs to be translated.

For the Secondary School data file, the system does not display the Program in Years, Proprietorship, and Status of Institution values because these values do not exist in the source file.

Reviewing ATP Data Suspense Messages

Access the ATP Messages (Suspense) page (**Campus Community > Organization > Organizations Data Load > ATP Suspense > ATP Messages**).

The ATP Messages (Suspense) page is for viewing purposes only. You cannot enter or modify data here.

Reviewing All ATP Messages

Access the ATP Messages page (**Campus Community > Organization > Organizations Data Load > ATP Messages**).

Enter any combination of record number, process instance (generated by the process scheduler), date loaded, and ATP code. Click the **Search** button to launch the search for all ATP messages based on the criteria you selected.

Specifying Search Parameters

Access the ATP Search Parameters page (**Campus Community > Organization > Organizations Data Load > ATP Search/Match/Post > ATP Search Parameters**).

These values are common to each group box on this page:

Field or Control	Description
Add	Select for the system to automatically add the load data.
Update	Select for the system to automatically overwrite the existing data with the new load data.

<i>Field or Control</i>	<i>Description</i>
Suspend	Select for the system to set the load data aside and post a message about it to the ATP Messages page until you can investigate further.
Ignore	Select for the system to do nothing with the load data or to your database, but to continue with the ATP Search/Match process.

Add

<i>Field or Control</i>	<i>Description</i>
One Match	Select what you want the system to do (update, suspend, or ignore) when the change code is <i>Add</i> and the Search/Match process finds one match.

Change

<i>Field or Control</i>	<i>Description</i>
No Match	Select what you want the system to do (update, suspend, or ignore) when the change code is <i>Change</i> and the Search/Match process finds no match.

Delete

<i>Field or Control</i>	<i>Description</i>
No Match	Select what you want the system to do (update, suspend, or ignore) when the change code is <i>Delete</i> and the Search/Match process finds no match.

Add/Change/Delete

<i>Field or Control</i>	<i>Description</i>
Multiple Matches	<p>Select what you want the system to do (update, suspend, or ignore) when the change code is <i>Add</i>, <i>Change</i>, or <i>Delete</i> and the Search/Match process finds multiple matches.</p> <hr/> <p>Note: The Search/Match process used inside the ATP Search/Match/Post process is independent from Search/Match for organizations.</p> <hr/>

Searching for Duplicate Records and Posting the Data

Access the ATP Post Parameters page (**Campus Community > Organization > Organizations Data Load > ATP Search/Match/Post > ATP Post Parameters**).

Search/Match/Post Execution Option

Select the processes to run: *Search*, *Match and Post*, *Post Only*, or *Search and Match Only*.

Note: If you choose to run either *Search*, *Match and Post*, or *Search and Match Only*, you should indicate the conflict parameters on the ATP Search Parameters page.

ATP Post Processing Parameters

<i>Field or Control</i>	<i>Description</i>
Process Single Record	<p>Select to set the specified process to run only on one record. You must specify the ATP record number for the school the system posts.</p>

When you click **Run** and schedule the process, the PeopleSoft Process Scheduler runs the CCATPPST.SQR process and posts the ATP data.

Note: If you selected *Search*, *Match and Post*, or *Search and Match Only*, you should review messages on the ATP Messages page to investigate and resolve conflicts for which you set the search parameters to *Suspend*.

Purging ATP Data from the Suspense File

Access the ATP Purge Suspense File page (**Campus Community > Organization > Organizations Data Load > ATP Purge Suspense File**).

ATP Purge Processing Parameters

<i>Field or Control</i>	<i>Description</i>
All Suspense Rows	Select to set the process to purge all records in the suspense tables.
Marked Suspense Rows	Select to set the process to purge only those records marked <i>Purge</i> in the suspense file, as indicated in the ATP Suspense Process Options page.

ATP Message Purge Processing Parameters

<i>Field or Control</i>	<i>Description</i>
Remove Associated Messages	Select to set the process to purge messages associated with the row of data selected by the Marked Suspense Rows option.
Retain Associated Messages	Select to set the process not to purge any messages associated with the row of data selected by the Marked Suspense Rows option.
All Messages	Select to set the process to purge all messages from the suspense files. You should select this option if you selected the All Suspense Rows option.

Loading External EPS Data

Use the EPS data load pages to load EPS market codes into the system similar to the way you load external ATP data. Some admissions offices use EPS market codes to focus their recruiting efforts in the geographic areas where they believe they will be the most successful.

Related Links

“Loading EPS Market Codes” (Recruiting and Admissions)

Managing Committee Data

Prerequisites for Managing Committee Data

Before creating a committee, create a committee template and then use the template to create similar committees or committees for similar events.

Related Links

[Setting Up Committee Types and Roles](#)

Creating Committees

This section discusses how to create a committee.

Page Used to Create Committees

<i>Page Name</i>	<i>Definition Name</i>	<i>Navigation</i>	<i>Usage</i>
Committee	COMMITTEE	Campus Community > Committees > Manage Committees > Committee	Create or review a committee.

Creating a Committee

Access the Committee page (**Campus Community > Committees > Manage Committees > Committee**).

Committee Details

<i>Field or Control</i>	<i>Description</i>
Committee Name	Enter a name for the committee.
Committee Type	Select the type of committee, from the Committee Type/Roles page, that describes this committee.

Assigning Committee Members

This section discusses how to assign members to a committee.

Page Used to Assign Committee Members

<i>Page Name</i>	<i>Definition Name</i>	<i>Navigation</i>	<i>Usage</i>
Committee Members	COMMITTEE_MEMBERS	Campus Community > Committees > Manage Committees > Committee Members	Assign individual members to a committee.

Assigning Members to a Committee

Access the Committee Members page (**Campus Community > Committees > Manage Committees > Committee Members**).

Committee Members

<i>Field or Control</i>	<i>Description</i>
Member Number	The number of this member in the list of members for this committee. The system automatically enters the next sequential number for each member that you add. You can override the number manually to reorder the list of committee members.
ID	The ID of the individual assigned to this committee. The system displays the individual's name after you select the ID.
Role	The role assigned to this individual for this committee.
Start Date	The date when the member's participation in this committee is scheduled to begin.
End Date	The date when the member's participation in this committee is scheduled to end.

Using Evaluation Management

Managing Evaluations

This section discusses how to:

- Review an evaluation.
- Add evaluation attachments.
- Calculate an evaluation rating scheme
- Enter results for an evaluator in an individual evaluator scheme.
- Enter results for an evaluator in a committee evaluation scheme.

Pages Used to Manage Evaluations

<i>Page Name</i>	<i>Definition Name</i>	<i>Navigation</i>	<i>Usage</i>
Evaluation Overview	SCC_GE_STDNT_EVAL1	Campus Community > Evaluation Management System > Manage Evaluation > Evaluation Overview	Add and manually maintain and manage evaluations in this component. Also add evaluations using the batch process and perform some maintenance activities in batch.
Evaluation Attachments	SCC_GE_ATTACH	Click the Attachments link on the Evaluation Overview page.	Attach files to an evaluation record.
Calculated Scheme	SCC_GE_STDNT_EVAL2	Campus Community > Evaluation Management System > Manage Evaluation > Calculated Scheme	Calculate overall ratings for an evaluation.
Individual Evaluator Scheme	SCC_GE_STDNT_EVAL3	Campus Community > Evaluation Management System > Manage Evaluation > Individual Evaluator Scheme	Manually enter individual evaluator evaluations and ratings.

Page Name	Definition Name	Navigation	Usage
Committee Scheme	SCC_GE_STDNT_EVAL4	Campus Community > Evaluation Management System > Manage Evaluation > Committee Scheme	Enter committee evaluations and ratings.

Reviewing an Evaluation

Access the Evaluation Overview page (**Campus Community > Evaluation Management System > Manage Evaluation > Evaluation Overview**).

This example illustrates the fields and controls on the Evaluation Overview page. You can find definitions for the fields and controls later on this page.

Evaluation Overview
Calculated Scheme
Individual Evaluator Scheme
Committee Scheme

ID:	AD6021	Daniel Cloud	
Academic Institution:	PSUNV	PeopleSoft University	Evaluation Instance: 24
Evaluation Category:	ADMISSIONS	Admissions Application	Process Instance:
Evaluation Code:	UGEVAL	Undergraduate Admissions evaluation	Eval Code Seq: 1

Application Data Keys Find First 1 of 1 Last

*Academic Career:	<input type="text" value="UGRD"/>	Career Nbr:	<input type="text" value="0"/>	*Application Number:	<input type="text" value="00023621"/>	Program Number:	<input type="text" value="0"/>	
-------------------	-----------------------------------	-------------	--------------------------------	----------------------	---------------------------------------	-----------------	--------------------------------	--

Evaluation Status Details

Administrator:	CCEM0014	Lyle Poindexter	
*Evaluation Status:	<input type="text" value="ASSIGN"/>	Status Date:	<input type="text" value="03/19/2013"/>
Completed Date:	Attachments (0)		

Final Recommendation/Comments

Recommendation:	<input type="text"/>
Recommend Prize:	<input type="text"/>
Comments:	<div style="border: 1px solid #ccc; height: 40px; width: 100%;"></div>

Calculated Scheme

Rating Scheme:	UGADMICALC	Calculated Scheme for UG Admissions
Overall Rating:		

Committee Schemes Personalize Find First 1 of 1 Last

Committee Scheme	Order	Rating Scheme	Evaluation Status	Status Date	Recommendation	Overall Rating
UGDNSCMTE	2	UGDEANREV				

Individual Evaluator Schemes Personalize Find First 1 of 1 Last

Scheme Name	Order	Rating Scheme	Evaluation Status	Status Date	Recommendation	Overall Rating
UGFIRSTREV	1	UGFIRSTREV	FINAL	03/19/2013	DENY	3.000

This administrative component stores the evaluation data for a student. This page is a high-level overview of other elements in the evaluation which are detailed in the other pages of the component. The system populates several fields on this page by default, depending on the setup values entered for the **Evaluation Category** and **Evaluation Code**.

The system populates several fields on this page by default, depending on the setup values entered for the **Evaluation Category** and **Evaluation Code**.

Note: Standard audit fields SCC_ROW_ADD_OPRID, SCC_ROW_ADD_DTTM, SCC_ROW_UPD_OPRID, and SCC_ROW_UPD_DTTM reside on the SCC_GE_STU_EVAL record.

<i>Field or Control</i>	<i>Description</i>
Evaluation Instance	The system displays a unique evaluation number for that ID.
Process Instance	If the evaluation was created by the batch process, a value appears in this field.
Eval Code Seq (evaluation code sequence)	The system displays a sequence number that provides more granularity in the event the same code is reassigned to the same ID over time. This value is assigned and incremented by the system.
Data Keys	The system displays different fields in this group box based on the evaluation category and cross-reference record used in the category setup. In this example, the evaluation category is Admissions, so the corresponding data keys are associated with the cross-reference record designated on the evaluation category setup. If the evaluation was created manually, then you must populate these fields. If the evaluation was created by the batch process, these values must be passed in through the Population Selection tool as part of the batch run control.

Evaluation Status Details

<i>Field or Control</i>	<i>Description</i>
Administrator	The system displays the administrator defined on the Evaluation Info page.
Evaluation Status	This field displays a point in time overall status of the evaluation. This value can differ from the status of any schemes that are part of the evaluation. At evaluation creation, the value is set to the default status value designated on the Evaluation Code setup. This value must be manually updated as the evaluation progresses.
Status Date	Populates as the current date.

Field or Control	Description
Completed Date	Display-only field. The system sets the value of this field. Indicates the date the evaluation was set to <i>final</i> . Used by workflow to prevent errors in the processing.
Attachments	Click this link to access the Evaluation Attachments page, where you can add attachments associated with the evaluation.

Final Recommendation/Comments

The fields in this group box represent the final, high-level result for this evaluation.

Field or Control	Description
Recommendation	Select a recommendation; Recommendation Code values are defined on the Evaluation Statuses page. On this page this value represents the recommendation for the entire evaluation.
Recommend Prize	Select a recommendation; field values are determined by the setup of the Recommended Prize prompt for the evaluation code.

Calculated Scheme

This group box displays the Calculated Scheme selected on the Evaluation Info page. The overall rating appears from the field value on the Calculated Scheme page.

Committee Schemes

This group box displays the committee schemes that are part of this evaluation as well as the high-level details of each scheme. You can enter additional details about the committee members and schemes on the Committee Scheme page of this component.

Individual Evaluator Schemes

This group box displays the individual evaluator schemes that are part of this evaluation as well as the high-level details of each scheme. You can enter additional details about the individual evaluators and schemes on the Individual Evaluator Scheme page of this component.



Adding Evaluation Attachments

Click the **Add Attachment** button to browse and select and upload a file to be attached.

Calculating an Evaluation Rating Scheme

Access the Calculated Scheme page (**Campus Community > Evaluation Management System > Manage Evaluation > Calculated Scheme**).

This example illustrates the fields and controls on the Calculated Scheme page.

Evaluation Overview	Calculated Scheme	Individual Evaluator Scheme	Committee Scheme
ID:	AD6029	Mary Cortez	  
Academic Institution:	PSUNV	PeopleSoft University	Evaluation Instance: 42
Evaluation Category:	ADMISSIONS	Admissions Application	Process Instance:
Evaluation Code:	CALCEVAL	Calculated Evaluation	Eval Code Seq: 1
Calculated Scheme:	UGADMICALC	Calculated Scheme for UG Admissions	Overall Rating: 26.667

Rating Component Information							Personalize	Find	First	1-7 of 7	Last
Rating Component	Order	Description	Rating Value	Rating Required	Successfully Evaluated						
TESTS	1	General Test Scores	25	<input checked="" type="checkbox"/>	<input checked="" type="checkbox"/>						<input type="button" value="+"/> <input type="button" value="-"/>
ACADEMIC	2	Academic Qualification	30	<input checked="" type="checkbox"/>	<input checked="" type="checkbox"/>						<input type="button" value="+"/> <input type="button" value="-"/>
SCNDRYREQ	3	Secondary School Course Requirement	25	<input checked="" type="checkbox"/>	<input checked="" type="checkbox"/>						<input type="button" value="+"/> <input type="button" value="-"/>
ENGLISH	4	English course	<input type="text"/>	<input type="checkbox"/>	<input type="checkbox"/>		<input type="text"/>				<input type="button" value="+"/> <input type="button" value="-"/>
MATH	5	Math courses	<input type="text"/>	<input type="checkbox"/>	<input type="checkbox"/>		<input type="text"/>				<input type="button" value="+"/> <input type="button" value="-"/>
SCIENCE	6	Science Courses	<input type="text"/>	<input type="checkbox"/>	<input type="checkbox"/>		<input type="text"/>				<input type="button" value="+"/> <input type="button" value="-"/>
FNLANG	7	Foreign Language Courses	<input type="text"/>	<input type="checkbox"/>	<input type="checkbox"/>		<input type="text"/>				<input type="button" value="+"/> <input type="button" value="-"/>

With the Rules Engine integration, you can associate the calculated scheme's rating components with a rule to automatically calculate a rating value based on data in the system. In that case, the Rating Value field on this page will become unavailable for edit because it is expected that the rule will calculate the value. If rating components in the scheme setup are not associated with a rule, then you can enter the rating values for those components manually on this page.

If a rule is identified for the rating scheme in the rating scheme setup, then that rule can calculate an Overall Rating as an alternate to the PeopleCode calculation of the Overall Rating as an average of the rating component values. For example, a rule calculation can give varying weights to some of the rating component values in determining the Overall Rating. If rating components in the scheme setup are not associated with a rule, then you can enter the rating values for those components manually on this page.

The rules to calculate the ratings can be triggered by a save in the Manage Evaluation component or by running the batch calculation process (SCC_GE_CALC). In either case, if the data needed to do the calculation is present in the system, then a rating value is returned to the component. If data is not present, then the batch calculation process can be run to scan for the data and update the component.























For more information on using rules in a calculated scheme, refer to the following topics in the Evaluation Management Setup documentation:

- [Defining Rating Schemes](#)
- [Setting Up Evaluation Codes](#)
- [Setting Up and Using Rules for the Evaluation Management System](#)

Entering Results for an Evaluator in an Individual Evaluator Scheme

Access the Individual Evaluator Scheme page (**Campus Community > Evaluation Management System > Manage Evaluation > Individual Evaluator Scheme**).

This example illustrates the fields and controls on the Individual Evaluator Scheme page. You can find definitions for the fields and controls later on this page.

Evaluation Overview	Calculated Scheme	Individual Evaluator Scheme	Committee Scheme			
ID:	SR0420	Ruth Isenberg	  			
Academic Institution:	PSUNV	PeopleSoft University	Evaluation Instance: 999999999999999			
Evaluation Category:	ADMISSIONS	Admissions Application	Process Instance:			
Evaluation Code:	GRADBUN	Graduate Business	Eval Code Seq: 1			
Scheme Details Find View All First 1 of 2 Last						
Scheme Name:	GRADBUN	Graduate Business First Review	Scheme Order: 1			
Rating Scheme:	GRDBSINESS	Graduate Business				
Administrator:	<input type="text" value="CCEM0012"/> 	Liam Hackensack				
Evaluation Status:	<input type="text" value="ASSIGN"/> 	Status Date: <input type="text" value="03/04/2013"/> 	Attachments (0)			
Completed Date:						
Recommendation:	<input type="text"/>					
Overall Rating:	30.000					
Comments:	<div style="border: 1px solid #ccc; height: 40px;"></div>					
Evaluator Details Find View All First 1 of 1 Last						
Evaluator ID:	<input type="text" value="CCEM0009"/> 	Trainer,Walter	Processing Order: <input type="text"/>  			
Evaluation Status:	<input type="text" value="ASSIGN"/> 	Status Date: <input type="text" value="03/04/2013"/> 	Attachments (0)			
Completed Date:						
Recommendation:	<input type="text" value="ADMIT"/> 	ADMIT				
Overall Rating:	30.000		Reassign Evaluator			
Comments:	<div style="border: 1px solid #ccc; height: 40px;"></div>					
Rating Components Comments 						
*Rating Component	Order	Description	Rating Value	Rating Required		
ACADEMIC		Academic Qualification	<input type="text" value="20"/> 	<input checked="" type="checkbox"/>	Add Comments	 
EXAM		Official Exam	<input type="text" value="30"/> 	<input checked="" type="checkbox"/>	Add Comments	 
WORKEXP		Work Experience	<input type="text" value="40"/> 	<input checked="" type="checkbox"/>	Add Comments	 

Content on this page is populated by default from the setup on the Define Individual Evaluator Scheme page. Evaluators that were defined for the scheme on the Define Individual Evaluator Scheme page will populate in this page. However, you can make some changes to the scheme depending on settings for the scheme and the status of the evaluation.

Scheme Details

Field or Control	Description
Scheme Name	Display only, populated by default from the Evaluation Code setup
Rating Scheme	Display only, populated by default from the Evaluation Code setup
Administrator	Enter the EmplID of the administrator who is responsible for entering the final evaluation status and recommendation. The system populates this field by default from the Evaluation Code setup. You can change this default value.
Evaluation Status	Select a status for the state of this Scheme. Available field values are set up on the Evaluation Statuses and are defined on the Evaluation Code setup.
Completed Date	Display-only field. The system sets the value of this field. Indicates the date the evaluation was set to <i>final</i> . Used by workflow to prevent errors in the processing.
Recommendation	Select a recommendation that represents the outcome for the Scheme. Optional but can be used in conjunction with the Overall Rating.
Overall Rating	The system displays the calculated average of all evaluators' overall rating values. A setting on the Evaluation Code setup can control this behavior, whether the rating should calculate as each evaluator completes or hold the calculation until all evaluator results are entered.
Scheme Order	Display only, populated by default from the Evaluation Code setup. Represents the place in order of this scheme in the overall Evaluation
Comment	Enter any text relevant to the evaluation.
Attachments	Click this link to access the Evaluation Attachments page, where you can add attachments associated with the evaluation.

Evaluator Details

This group box contains individual evaluator evaluation results. If evaluators were previously defined, their IDs appear here. However, you can add or remove additional evaluator IDs, ratings, and recommendations on this page, if the scheme is not final.

Field or Control	Description
Evaluation Status	Select a status for the evaluator's action. Available field values reflect the current state of the evaluation, and are set up on the Evaluation Statuses page.
Completed Date	Display-only field. The system sets the value of this field. Indicates the date the evaluation was set to final. Used by workflow to prevent errors in the processing.
Recommendation	In addition to providing rating results, enter the recommendation of the evaluator. Recommendation Values are defined on the Evaluation Statuses page.
Overall Rating	The system displays the calculated average of the evaluators' rating components. This value also appears becomes part of the overall rating for the scheme.
Attachments	Click this link to access the Evaluation Attachments page, where you can add attachments associated with the evaluation.

Rating Components

Rating Components are populated by default from the rating scheme associated with the Individual Evaluator Scheme. If designated on the rating scheme setup, you can add or delete a component from the grid if the scheme is not in Final status. Enter your rating value for each component in the scheme. Rating values prompt against the rating scheme setup. All required rating components must have a value before setting the status to the final status value (as designated on the Evaluation Code setup). If a required component lacks a value, the system will prompt you to enter a value at save time when updating the status.

See [Adding Evaluation Attachments](#)

Entering Results for an Evaluator in a Committee Evaluation Scheme

Access the Committee Scheme page (**Campus Community > Evaluation Management System > Manage Evaluation > Committee Scheme**).

This example illustrates the fields and controls on the Committee Scheme page (1 of 2). You can find definitions for the fields and controls later on this page.

Evaluation Overview
Calculated Scheme
Individual Evaluator Scheme
Committee Scheme

ID: SR0420 Ruth Isenberg

Academic Institution: PSUNV PeopleSoft University

Evaluation Category: ADMISSIONS Admissions Application

Evaluation Code: GRADBUSN Graduate Business

Evaluation Instance: 999999999999999

Process Instance:

Eval Code Seq: 1

Committee Schemes Used
Additional Details

Committee Scheme	Order	Evaluation Status	Status Date	Completed Date	Recommendation	Overall Rating
GRADBUSN	3	<input type="text"/>	<input type="text"/>		<input type="text"/>	26.667
GRBUSDEAN	4	<input type="text"/>	<input type="text"/>		<input type="text"/>	

Committee Details
Find | View All
First 1 of 2 Last

Committee Scheme: GRADBUSN Graduate Business

Committee Code: GRBUSN Graduate Business

Committee Type: TEST REV Test Review Committee

Administrator: Sophie Rollins

Evaluation Status: Status Date:

Completed Date:

Recommendation:

Overall Rating: 26.667

Comments:

Scheme Order: 3

Committee Order: 1

[Attachments \(0\)](#)

[Reassign Evaluator](#)

This example illustrates the fields and controls on the Committee Scheme page (2 of 2). You can find definitions for the fields and controls later on this page.

Evaluator Details
Find | View All
First 1 of 3 Last

Evaluator ID: Fife, Raymond

Committee Role: Chair of Committee

Evaluation Status: Status Date:

Completed Date:

Recommendation: ADMIT

Overall Rating: 26.667

Comments:

[Attachments \(0\)](#)

[Reassign Evaluator](#)

Rating Components
Comments
Add

*Rating Component	Order	Description	Rating Value	Rating Required		
ACADEMIC		Academic Qualification	<input type="text" value="10"/>	<input checked="" type="checkbox"/>	Add Comments	<input type="button" value="+"/> <input type="button" value="-"/>
EXAM		Official Exam	<input type="text" value="30"/>	<input checked="" type="checkbox"/>	Add Comments	<input type="button" value="+"/> <input type="button" value="-"/>
WORKEXP		Work Experience	<input type="text" value="40"/>	<input checked="" type="checkbox"/>	Add Comments	<input type="button" value="+"/> <input type="button" value="-"/>

If committee schemes were previously defined on the Define Committee Scheme page, those committees appear here.

Committee Schemes Used

Field or Control	Description
Evaluation Status	Available field values are set up on the Evaluation Statuses and are defined on the Evaluation Code page.
Completed Date	Display-only field. The system sets the value of this field. Indicates the date the evaluation was set to final. Used by workflow to prevent errors in the processing.
Recommendation	Enter a recommendation that represents all recommendations from the underlying evaluators. Recommendation Values are defined on the Evaluation Statuses page.
Overall Rating	The system displays the calculated average of each evaluator's final rating. This value also becomes part of the overall rating for the scheme.

Additional Details

Click the Additional Details tab to enter administrator's EmplID, comments and attachments at the scheme level.

Field or Control	Description
Administrator	Enter the EmplID of the administrator who is responsible for entering final recommendation and status for the committee scheme. The system populates this field by default from the Evaluation Code setup. You can change this default value.

Committee Details

Field or Control	Description
Committee Scheme	Display only, populated by default from the Evaluation Code setup.
Committee Code	Display only, populated by default from the Committee Scheme setup.
Committee Type	Display only populated by default from the Committee Scheme setup.

Field or Control	Description
Administrator	Enter the EmplID of the administrator who is responsible for entering the final evaluation status and recommendation for the committee. The system populates this field by default from the Define Committee Scheme page. You can change this default value.
Evaluation Status	Select a status for the state of this Scheme. Available field values are set up on the Evaluation Statuses and are defined on the Evaluation Code page.
Completed Date	Display-only field. The system sets the value of this field. Indicates the date the evaluation was set to final. Used by workflow to prevent errors in the processing.
Recommendation	Select a recommendation that represents the outcome for the Scheme. Optional but can be used in conjunction with the Overall Rating.
Overall Rating	The system displays the calculated average of all evaluators' overall rating values. A setting on the Evaluation Code setup can control this behavior, whether the rating should calculate as each evaluator completes or hold the calculation until all evaluator results are entered.
Scheme Order	Display only, populated by default from the Evaluation Code setup. Represents the place in order of this scheme in the overall Evaluation
Committee Order	Display only, populated by default from the Committee Scheme setup.
Comment	Enter any text relevant to the evaluation.
Attachments	Click this link to access the Evaluation Attachments page, where you can add attachments associated with the evaluation.

Evaluator Details

The fields in this group box are the same as those on the Individual Evaluator Scheme page. These are the committee member evaluation results.

Rating Components

The fields in this grid are the same as those on the Individual Evaluator Scheme page.

See [Adding Evaluation Attachments](#)

Processing Evaluations in Batch

This section discusses how to select and process groups of evaluations.

Page Used to Process Evaluations in Batch

<i>Page Name</i>	<i>Definition Name</i>	<i>Navigation</i>	<i>Usage</i>
Create and Maintain Evaluations	SCC_GE_RC_MAINT	Campus Community > Evaluation Management System > Create/Maintain Evaluations	Create, update or delete evaluations for a group of IDs.

Processing Evaluations

Access the Create and Maintain Evaluations page (**Campus Community > Evaluation Management System > Create/Maintain Evaluations**).

This example illustrates the fields and controls on the Create and Maintain Evaluations page. You can find definitions for the fields and controls later on this page.

The fields on this page change, depending on the Selected Process option you select.

Field or Control	Description
Selected Process	<p>Select one of three processing options:</p> <p><i>Create Evaluations:</i> To create a new evaluation for the selected IDs.</p> <p><i>Delete Evaluations:</i> To delete the evaluation data for the selected IDs.</p> <p><i>Update Evaluations:</i> To make updates and changes, within certain conditions, to existing evaluations.</p> <p><i>Start Workflow:</i> To initiate workflow processing for the selected IDs.</p>
Evaluation Category	Enter an evaluation category; categories are defined on the Define Evaluation Category page.
Evaluation Code	Enter an evaluation code; codes are defined in the Define Evaluation Code component.

Create Evaluations

Enter an **Evaluation Category** and **Evaluation Code**, then use Population Selection to select IDs for which you want to create new evaluations.

Delete Evaluations

Use Population Selection to select IDs for which you want to delete evaluations. The system deletes evaluations based on evaluation instance number.

Update Evaluations

You have multiple maintenance options to take against a selected population of evaluations.

Field or Control	Description
Update Action	<p>Specify updates to these fields on the Evaluation Overview in the Manage Evaluation component: <i>Administrator</i>, <i>Evaluation Status</i>, <i>Status Date</i>, <i>Recommendation</i>, and <i>Recommend Prize</i>.</p> <p>Administrator: prompts against all IDs in the system.</p> <p>Evaluation Status: prompts against valid statuses set up on the Evaluation Code setup page.</p> <p>Status Date: specify the date the process should use in the update.</p> <p>Recommendation: prompts against valid recommendation values set up on the Evaluation Code setup page.</p> <p>Recommend Prize: prompts against Evaluation Codes set up for a recommended prize.</p> <p>You also have the option to: <i>Add Component</i>, <i>Add Evaluator</i>, <i>Assign Committee Administrator</i>, <i>Assign Scheme Administrator</i>, <i>Reassign Evaluator</i>, <i>Remove Component</i>, and <i>Remove Evaluator</i>.</p> <p>The remaining fields in this group box become available for entry.</p>
Scheme Type	Select either <i>Committee</i> or <i>Individual Evaluator</i> . The remaining fields in this group box change depending on your selection.
Scheme Name	Available values in this field depend on the Scheme Type you select.
Eval Committee	This field is only available if the Scheme Type is <i>Committee</i> .
Evaluator ID	This field prompts against all IDs in the system.
Committee Role	This field is only available if the Scheme Type is <i>Committee</i> .

Start Workflow

Use Population Selection to select IDs for which you want to start workflow. The system starts workflow based upon the evaluation instance number.

Population Selection

Population selection is a method for selecting the person IDs to process for a specific transaction. The Population Selection group box is a standard group box that appears on run control pages when the Population Selection process is available or required for the transaction. Selection tools are available based on the selection tools that your institution selected in the setup of the Population Selection process for the application process, and on your user security. Fields in the group box appear based on the selection tool that you select. The fields behave the same way from within the group box on all run control pages and application processes.

The PeopleSoft system delivers predefined sample queries to enable you to select person IDs, organization IDs, or both. The predefined queries are:

- QA_CS_CC_EMS_APPL – for identifying applicants for evaluation creation.
- QA_CS_CC_EMS_THESIS – for identifying thesis candidates for evaluation creation.
- QA_CS_CC_EMS_UPD_DEL – for identifying IDs based upon evaluation instance ID to update or delete an evaluation and also for the Start Workflow process.

The PeopleSoft system also delivers predefined sample equations to enable you to select person IDs, organization IDs, or both. The predefined equations are:

- CCEMPSCRTADM - for identifying applicants for evaluation creation.
- CCEMPSCRTTHS - for identifying thesis candidates for evaluation creation.
- CCEMPSUPDDEL - for identifying IDs based upon evaluation instance ID to update or delete an evaluation.

If your institution uses a specific delivered selection tool (PS Query, Equation Engine equation, or external file) to identify IDs for a specific transaction, you must use it.

When you click the Run button, the SCC_GE_MAINT App Engine process launches and processes the selected IDs for the action selected on the run control. View the message log for information about the process results and actions taken and any exceptions that may have occurred during the processing.

Related Links

[Using the Population Selection Process](#)

Sending Timeout and Reminder Notifications to Evaluators

Reminder and timeout notifications may be sent to evaluators if desired. Use the Notification Framework's Worklist Batch process (SCC_NTFWKLTO) to send the reminder and timeout notifications.

Reminder and timeout notifications are configured when you set up evaluation codes. For more information, refer to the following topic in the Evaluation Management setup documentation:

[Setting Up Evaluation Codes](#)

For information on the Worklist Batch process, refer to [Understanding the Notifications Framework](#).

Chapter 68

Using Evaluation WorkCenter

Understanding Evaluation WorkCenter

The Evaluation WorkCenter is a configurable page that an evaluator or evaluation administrator can use to:

- View open evaluations that the evaluator or administrator needs to complete.
- Enter and submit evaluations.
- Access pagelets that contain navigation links to components, which the evaluator or administrator frequently uses as part of their business needs.

This example illustrates the fields and controls on the Evaluation WorkCenter.

The screenshot shows the Evaluation WorkCenter interface. On the left is a task pane with various navigation options. The main area displays a 'Filter By' section with search fields for Evaluation Description, ID, Your Role, Date From, and Date To. Below the filters is a table titled 'Your assigned evaluations' with columns for Select, ID, Name, Description, Date, and Role.

Select	ID	Name	Description	Date	Role
1	AD6008	Opal Bergen	PS Test - simple use case	06/24/2013	Committee Evaluator
2	AD6008	Opal Bergen	PS Test - simple use case	06/24/2013	Individual Evaluator

To access the delivered Evaluation WorkCenter, select Campus Community, Evaluation Management System, Evaluation WorkCenter.

The delivered Evaluation WorkCenter contains a landing page with the worklist in the work area of the workcenter and a set of sample pagelets in the task pane. The work area is on the right side of the workcenter and the task pane is on left side of the workcenter.

- Landing page: is a PIA delivered object with the worklist embedded on the page. While you can modify the text that appears on the page via the Message Catalog, this page should not otherwise be modified.

- **Worklist (SCC_SS_GE_WORKLIST):** This is a component that is embedded in the landing page and provides a list of open evaluations that the signed in evaluator or administrator needs to complete. The evaluator or administrator clicks an assigned evaluation to access the Evaluation Decision Entry page. The evaluator or administrator uses this page to enter and submit the evaluation. Note that this component provides a list of only those evaluations for which the evaluator or administrator has access.

Evaluations appear in the worklist based upon workflow processing. Therefore, an evaluation only appears when it is ready for the evaluator's review. The worklist may be sorted by clicking on the column headers. When the evaluator or administrator has completed the evaluation (that is, submitted), the item will no longer appear in the list.

Because the worklist is a component object, it is also delivered under the menu navigation – *Campus Community, Evaluation Management System, Evaluation WorkList* – as an alternative access point, if the Evaluation WorkCenter is not used at your institution.

- An evaluator may use the Show option and Filter By capabilities to sort and organize the items in their worklist.

Show: The available values are *Assigned Evaluations, Completed Evaluations, Upcoming Evaluations*. The default is *Assigned Evaluations*, so the evaluator immediately sees all evaluations that are ready for their review. When changing the value here, code fires and updates worklist items with those that are in the appropriate status. In all cases, the items in the worklist present only if the user has been an active or past evaluator in the evaluation. In other words they will not be able to access evaluations in which they did not participate.

Filter By section: The available values are:

Evaluation Description: values displayed in the drop-down list box result from a security view, limiting the results to those Evaluations to which the user has access.

ID: to select a specific evaluatee for whom the user might want to view the evaluation. Prompts against PEOPLE_SEARCH.

Your Role: Because a person may wear multiple 'evaluator' hats, this option allows the user to narrow the results to a particular role they may have played in an evaluation. As an example, perhaps in one evaluation they were a committee member but also the Committee Administrator in an evaluation. This option allows the user to select the Committee Administrator role.

Date From: Allows for narrowing results to a specific date range. When the Show option of 'Completed Evaluations' is selected, this date is defaulted as a date seven days prior to the current date. This is to limit the results return and avoid a potential performance issue, recognizing that over time an evaluator may have amassed a huge volume of completed evaluations. The user may overwrite these values.

Date To: Allows for narrowing results to a specific date range. When the Show option of 'Completed Evaluations' is selected, this date is defaulted as a the current date.

Apply: After populating the filter by parameters, the user must select the Apply link in order to see the items returned in the worklist.

Reset: The user may clear the Filter By options by selecting the Reset link.

- Pagelets: These are navigation sample pagelets in the task pane to illustrate how the center may be configured. There are many other pagelet types that can be incorporated into the Evaluation WorkCenter such as pagelets based upon a query to display metric or dashboard style data to the end user and URL pagelets which can present to the end user related materials and information.

You should have an understanding in PeopleTools Portal and WorkCenter technology to configure the Evaluation WorkCenter.

See the product documentation for *PeopleTools: Portal Technology*

Modifying the Landing Page Text

You can use PeopleTools Message Catalog to modify the text on the landing page of the workcenter. The message set number, message number for the text on the landing page are: 14750, 10025.

Prerequisites for using Evaluation WorkCenter

Before administrators or evaluators can use Evaluation WorkCenter self-service feature, the administrator or evaluator must have a user ID in the system. The administrator or evaluator should have a role that includes security access to Evaluation WorkCenter and the pages which can be accessed from the Evaluation WorkCenter.

Using Self-Service Worklist

If your institution is not using Evaluation WorkCenter, evaluators and administrators can access the Evaluation WorkList component (SCC_SS_GE_WORKLIST) by selecting Campus Community, Evaluation Management System, Evaluation WorkList. This is the same worklist component that the delivered Evaluator WorkCenter displays.

For more information about the worklist component:

See [Understanding Evaluation WorkCenter](#)

Entering Evaluations

Evaluators and evaluation administrators click an open evaluation in the worklist pagelet to enter and submit evaluations. When they click the evaluation, the Evaluation Decision Entry page appears. The Evaluation Decision Entry page varies according to what type of evaluator or administrator is accessing the page. The following is a list of evaluator types that Evaluation Management System (EMS) supports:

- Evaluation Administrator (Evaluation Code Administrator)
- Individual Evaluator Scheme Administrator
- Individual Evaluator
- Committee Scheme Administrator

- [Committee Administrator](#)
- [Committee Evaluator](#)

The evaluation code determines who the evaluator is based on whether he or she is assigned to the evaluation and then presents the appropriate page to the evaluator for evaluation decision entry. When you use the Manage Evaluation component or batch process to create an evaluation, you assign an evaluation code to the person who is being evaluated (for example, student, applicant, or research candidate). At that time, these evaluators are assigned to the evaluation.

Depending on the order defined in the EMS setup, the EMS workflow adds the open evaluation to a worklist and (if email notification is enabled in the evaluation code setup) sends an email to the evaluator or administrator notifying that the open evaluation has been added to her or his worklist.

See [Setting Up Evaluation Codes](#)

See [Managing Evaluations](#)

See [Processing Evaluations in Batch](#)

See [Sending Timeout and Reminder Notifications to Evaluators](#)

This graphic illustrates an example of evaluation code setup:

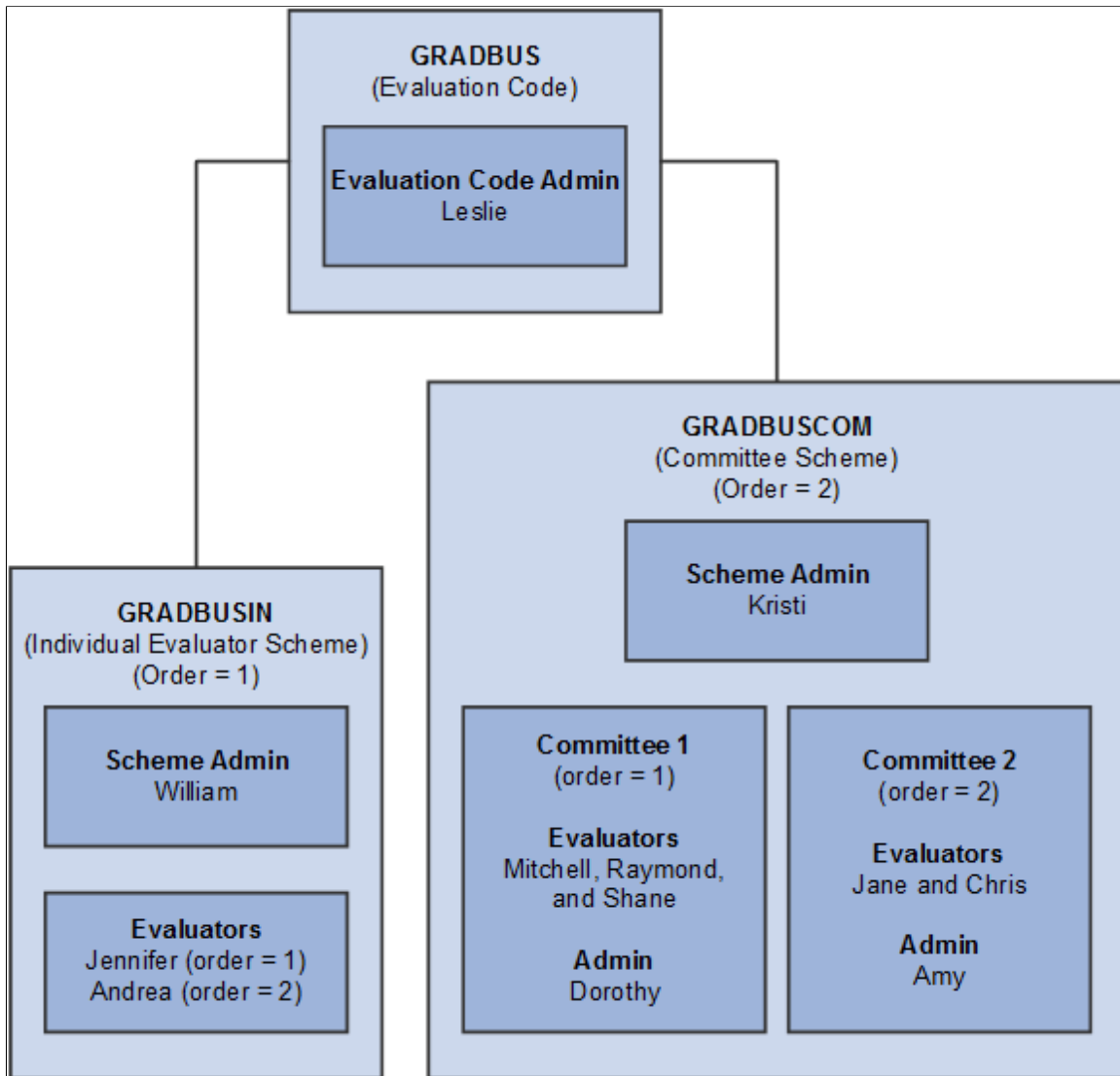

This graphic illustrates the order in which workflow processes the evaluators and administrators based on above example setup:

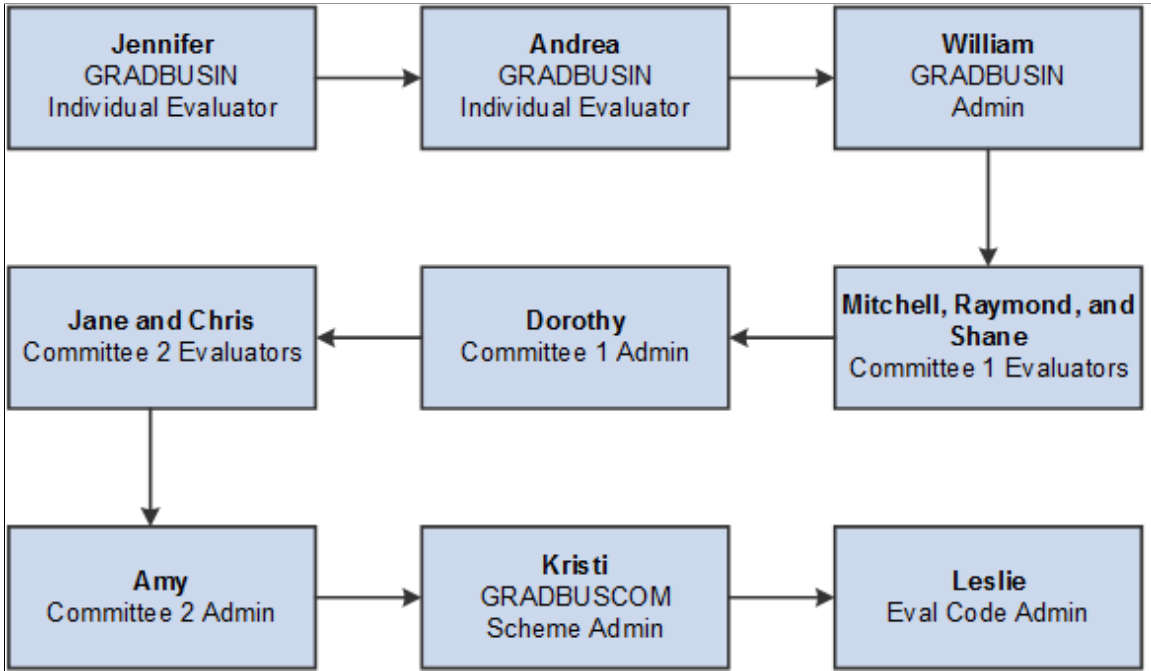

This is an example of Evaluation Decision Entry page for an Individual Evaluator:

Evaluation Decision Entry

This is a Graduate Business evaluation for Ana Beck (ID: SR0400).

You are evaluating as an Individual Evaluator in the Graduate Business First Review Scheme.

This evaluation is past due. The Due Date was 03/01/2013.

Please provide a rating for the components below

Component	Rating Required	Rating	
Academic Qualification	<input checked="" type="checkbox"/>	Excellent	Add Comments
Official Exam	<input checked="" type="checkbox"/>	Good	Add Comments
Work Experience	<input checked="" type="checkbox"/>	Very Good	Add Comments

Please enter a recommendation and any additional comments

Recommendation: ADMIT Overall Rating: 30.000

Evaluation Status: In Progress Status Date: 03/03/2013

Comments: [Add Attachments](#)

SUBMIT EVALUATION SAVE CHANGES RETURN

This is an example of Evaluation Decision Entry page for a Committee Administrator (1 of 2):

Evaluation Decision Entry

This is a Graduate Business evaluation for Blaine Berger (ID: AD6009).

You are evaluating as the Committee Administrator for the Graduate Business Committee.

This evaluation must be completed on or before 10/03/2013.

Committee Member Summary

Name	Evaluation Status	Status Date	Recommendation	Overall Rating	Comments	Attachments
Raymond Fife	Final Status	09/26/2013	ADMIT	10.000		
Rosaria Dunphy	Final Status	09/26/2013	ADMIT	10.000		
Mitchell Froelich	Final Status	09/26/2013	ADMIT	10.000		

Committee Member Component Ratings

[Collapse All](#)

Member / Component	Rating	Rating Required	Comments
Raymond Fife			
• Academic Qualification	Poor	Yes	
• Official Exam	Poor	Yes	
• Work Experience	Poor	Yes	
Rosaria Dunphy			
• Academic Qualification	Poor	Yes	
• Official Exam	Poor	Yes	
• Work Experience	Poor	Yes	
Mitchell Froelich			
• Academic Qualification	Poor	Yes	
• Official Exam	Poor	Yes	
• Work Experience	Poor	Yes	

This is an example of Evaluation Decision Entry page for a Committee Administrator (2 of 2):

Please enter a recommendation and any additional comments

Recommendation <input type="text"/>	Overall Rating 10.000
Evaluation Status <input type="text"/>	Status Date

Comments [Add Attachments](#)

SUBMIT EVALUATION	SAVE CHANGES	RETURN	
-------------------	--------------	--------	--

Note: Evaluators and administrators can also use the Manage Evaluation component to enter evaluations. But the difference between the worklist and this component is that in the component an administrator or evaluator can see and update evaluations of other administrators or evaluators (including himself or herself), while the worklist displays only the evaluations assigned to the signed in administrator or evaluator. Another key difference is that an administrator cannot create an evaluation using the worklist. To create a new evaluation, an administrator should use the Manage Evaluation component or the batch process.

Note: The Evaluation Decision Entry page functionality is similar to the Manage Evaluation component. The *Managing Evaluations* topic describes the Manage Evaluation component. Therefore, refer to the Managing Evaluations topic for more information about the fields on the Evaluation Decision Entry page. There are however few differences between the Evaluation Decision Entry page and Manage Evaluation component. One difference is that on the Evaluation Decision Entry page, the evaluator is only seeing that portion he or she needs to work on. Another difference is the Submit Evaluation, Save Changes, and Return buttons that only appear on the Evaluation Decision Entry page. Clicking the Submit Evaluation button finalizes the evaluation and removes the evaluation from the worklist. The evaluator cannot access that evaluation again. Clicking the Save Changes button will save the work-in-progress and the evaluation will remain in the worklist, allowing the evaluator to re-access and complete the evaluation. Finally, clicking the Return button will return the evaluator to the worklist.

See [Managing Evaluations](#)

Modifying the Decision Entry Page Text

You can use PeopleTools Message Catalog to modify the text on the decision entry page. The message set number, message number for the text on the decision entry pages that specifies the evaluator role and the evaluation (for instance, "You are evaluating as an Individual Evaluator in the First Review scheme") are:

- Individual Evaluator: 14750, 10006
- Individual Evaluator Scheme Administrator and Committee Scheme Administrator: 14750, 10007
- Committee Evaluator: 14750, 10009
- Committee Administrator: 14750, 10008
- Evaluation Administrator: 14750, 10004

For the text that identifies who is being evaluated and in what context (for instance, "This is an Undergraduate Arts evaluation for Dorothy Berry (ID AD5042)": 14750, 10010

Additional Information section, Evaluation Overview page, and Committee Collaboration page

Evaluators can use the Additional Information section on the various evaluator decision entry pages. These pages render this section based on the setup configuration in the Define Evaluation Code, Define Individual Evaluator Scheme and Define Committee Scheme components.

For an evaluator, the Evaluation Overview page provides visibility to the evaluation activity beyond what is available on the decision entry page. Setup in the Define Individual Evaluator Scheme and Define Committee Scheme components determines the display of the View Evaluation Overview link on the decision entry pages.

For committee members, the Committee Collaboration page provides visibility to the evaluation activity within a committee. Access is granted in the Define Committee Scheme component.

This is an example of the decision entry page that shows the Additional Information section, and the View Evaluation Overview and View Committee Collaboration links.

Evaluation Decision Entry

This is a Graduate Business evaluation for Aaron Blau (ID: AD6015).

You are evaluating as a Committee Evaluator in the Graduate Business Committee.

This evaluation is past due. The Due Date was 03/24/2014.

Additional Information

[Applicant Profile](#)
[IPEOS](#)
[Evaluation Manual](#)

[Validation Error Report \(Query\)](#)
[EMS Applicant Data Report \(ConQuery\)](#)
[Test Report\(XML\)](#)

[Evaluation Instructions](#)

Please provide a rating for the components below

Component	Rating Required	Rating	
Academic Qualification	Yes	<input type="text"/>	▼ Add Comments
Official Exam	Yes	<input type="text"/>	▼ Add Comments
Work Experience	Yes	<input type="text"/>	▼ Add Comments

[View Evaluation Overview](#)

[View Committee Collaboration](#)

Please enter a recommendation and any additional comments

Recommendation <input style="width: 90%;" type="text"/>	Overall Rating
Evaluation Status <input style="width: 90%;" type="text"/>	Status Date
Comments Add Attachments	

SUBMIT EVALUATION
SAVE CHANGES
RETURN

This is an example of the Evaluation Overview page.

Evaluation Overview

This is a Graduate Business evaluation for Aaron Blau (ID: AD6015).

Liam Hackensack is the Evaluation Administrator.

Evaluation Summary

[Collapse All](#)

Scheme / Committee / Member	Order	Evaluation Status	Status Date	Recommendation	Overall Rating	Comments	Attachments
▼ Graduate Business First Review	1	Final Status	03/17/2014	ADMIT	30.000		
• Walter Trainer		Final Status	03/17/2014	ADMIT	30.000		
▼ Graduate Business Rev 2	2	Final Status	03/17/2014	Wait List	26.667		
• Samuel Grayson	1	Final Status	03/17/2014	Wait List	20.000		
• Linda Bonnington	2	Final Status	03/17/2014	Wait List	33.333		
▼ Graduate Business	3				36.667		
▼ Graduate Business	1				36.667		
• Rosaria Dunphy		Final Status	03/21/2014	ADMIT	40.000		
• Raymond Fife		Final Status	03/21/2014	ADMIT	33.333		
• Mitchell Froelich							
▼ Graduate Business Faculty	2						
• Evelyn Finck							
• Janina Prosky							
▼ Graduate Business Dean's Committee	4						
▼ Dean							
• Celine Beaulieu							
• Summer Nolan							
• Anthony Sallington							

[RETURN](#)

In the above example, the view is given to all levels of the evaluation: orders which have completed before this evaluator's turn for the evaluation as well as visibility of which order will occur beyond the evaluator's order in the evaluation.

This is an example of the Committee Collaboration page.

Graduate Business Committee Collaboration

Review of a Graduate Business evaluation for Aaron Blau (ID: AD6015).

Sophie Rollins is the Committee Administrator.

Committee Members

[Collapse Members](#) [Expand Members](#) [Refresh](#)

▼ Rosaria Dunphy (Staff member of Committee, 999/666-4444)

Status	Final Status	Date	03/17/14 10:06:53AM
Recommendation	ADMIT	Overall Rating	40.000
Comments	Excellent candidate, recommend for admission.		

▼ Academic Qualification

Rating	Excellent
Comments	Very strong academic record.

▼ Official Exam

Rating	Excellent
Comments	Not impressed with exam scores.

▼ Work Experience

Rating	Excellent
Comments	Impressive work experience.

▼ Raymond Fife (Chair of Committee, 999/888-6666)

Status	Final Status	Date	03/17/14 10:06:14AM
Recommendation	ADMIT	Overall Rating	33.333
Comments	While Exam scores are somewhat weaker than the admit profile, I recommend admit.		

▼ Attachments

Attached File	Description	
A_Test_attachment.docx	A_Test_attachment.docx	View

▼ Academic Qualification

Rating	Excellent
---------------	-----------

▼ Official Exam

Rating	Good
---------------	------

The ratings, recommendations, comments and attachments are made available to all committee members. The Refresh link refreshes the data to capture any recent changes made by other committee members.

Pages Used to Enter Evaluations

Page Name	Definition Name	Navigation	Usage
Evaluation Decision Entry (for Evaluation Administrator)	SCC_SS_GE_EVALUATN	An evaluation administrator clicks an open evaluation in his or her worklist.	An Evaluation Administrator uses this page to review a summary of the evaluations entered by members of individual evaluator and committee schemes. After reviewing the summary, the administrator uses this page to enter and submit his or her final evaluation.
Evaluation Decision Entry (for Individual Evaluator Scheme Administrator)	SCC_SS_GE_IE_SCHEM	An Individual Evaluator Scheme Administrator clicks an open evaluation in his or her worklist.	An Individual Evaluator Scheme Administrator uses this page to review a summary of the evaluations entered by members of individual evaluator scheme. After reviewing the summary, the administrator uses this page to enter and submit his or her evaluation.
Evaluation Decision Entry (for Individual Evaluator)	SCC_SS_GE_IE_EVLTR	An Individual Evaluator clicks an open evaluation in his or her worklist.	An Individual Evaluator uses this page to enter and submit his or her evaluation.
Evaluation Decision Entry (for Committee Scheme Administrator)	SCC_SS_GE_CM_SCHEM	A Committee Scheme Administrator clicks an open evaluation in his or her worklist.	A Committee Scheme Administrator uses this page to review a summary of the evaluations entered by members of committees in the committee scheme. After reviewing the summary, the administrator uses this page to enter and submit his or her evaluation.
Evaluation Decision Entry (for Committee Administrator)	SCC_SS_GE_CM_INFO	A Committee Administrator clicks an open evaluation in his or her worklist.	A Committee Scheme Administrator uses this page to review a summary of the evaluations entered by members of the committee. After reviewing the summary, the administrator uses this page to enter and submit his or her evaluation.
Evaluation Decision Entry (for Committee Evaluator)	SCC_SS_GE_CM_EVLTR	A Committee Evaluator clicks an open evaluation in his or her worklist.	A Committee Evaluator uses this page to enter and submit his or her evaluation.

Managing Campus Event Planning

Understanding Campus Event Planning

You can use your system to help plan and manage campus events. A set of meetings comprises one overall event, and each meeting can have resources and staff assigned to it. For example, you could create an event called Orientation. Your template might include meetings such as a welcome reception, a general session, several workshops, and a tour of the campus. You can identify the required resources for each meeting (tables, chairs, brochures, banners, and so on), and assign and schedule the responsible staff.

Orientation, for example, is a recurring event, and each of the meetings might need the same resources and staff each time. You can create an Orientation event template to make it easier to regularly plan and manage this event. You can also use the template to plan similar events.

Courses are also events. You use event planning to assign classrooms, identify faculty, and schedule equipment for courses.

Note: Be careful not to confuse the events described in this section with 3C engine events. In this section, one attends the events; 3C engine events are data occurrences within the system.

You can use your system to get accurate counts of how many attendees you invited to an event, how many plan to attend, and how many actually attended.

You can identify attendees who are in your database versus those who are not. You can also add guests as attendees and associate them with the host attendee who invited them. Tracking guest information this way is especially useful in social situations. For example, if an attendee invites two coworkers who you know are key figures in the local community, you do not have to remember which attendee works with and invited them, you can check the list of attendees to find out.

Note: Attendees do not have to exist in your database to attend an event. However, if you want to add each attendee to your system, use the Biographical Information pages to create records and add them to your database. Adding attendees to your system enables you to include them in any confirmation, thank you, or other letter that you generate for the event.

Related Links

“Defining Buildings, Rooms, and Classroom Facilities” (Student Records)

Common Elements Used to Manage Campus Event Planning

<i>Field or Control</i>	<i>Description</i>
Event ID	The ID number for an event. When you create a new event on the Events page, the event ID is all zeros until you save the page. After you save the page, the system assigns the next available event ID.
Event Type	Select the type, from the Event Types page prompt list, that describes the event.
Academic Institution	The academic institution responsible for the event.
Event Manager	The individual at your institution who is managing the event.
Event Meeting	The number of each meeting in the list of meetings for an event. The system automatically enters the next sequential number for each meeting that you add. You can override the number to reorder the list of meetings. When you return to the page, the meetings are listed in the specified order.
Primary Meeting	The primary meeting for the event. You can identify a primary meeting from the list of meetings for an event on the Event Template page. When you save the page, the system displays the event meeting number and corresponding meeting location for the primary meeting on the Event page.
Campus Coordinator	The individual at your institution who is responsible for, or should be contacted about, this meeting.
Department Sponsor	The department at your institution that is responsible for this meeting.
Manager	The name of the responsible department's manager. The system displays the manager's name if one is associated with the department sponsor on the Department Profile page.
Attendee	An individual who is invited or scheduled to attend any event meeting.
Guest Relationship	The relationship between the host attendee and the guest attendee. If a guest is identified, the guest relationship is required.

Creating an Event

This section lists prerequisites and discusses how to:

- Name an event.
- Add meetings to an event.
- Enter meeting details.
- Specify meeting sponsors.
- Enter the meeting location.
- Schedule meeting resources.
- Schedule meeting staff.

Prerequisites

Before creating events, define the types of events, staff, and resources. You might also find it helpful to set up general event templates from which to copy when creating specific events.

Set up internal departments and organization departments and contacts before designating event managers, sponsors, and contacts. You must set up facilities before you can designate event locations.

Related Links

[Defining Campus Events](#)

[Creating Organization Records](#)

“Defining Buildings, Rooms, and Classroom Facilities” (Student Records)

Pages Used to Create an Event

<i>Page Name</i>	<i>Definition Name</i>	<i>Navigation</i>	<i>Usage</i>
Event	CAMPUS_EVENT	Campus Community > Campus Event Planning > Event Management > Events > Event	Name an event, including selecting the event type and assigning the event manager.
Event Template	CAMPUS_MEETING	Campus Community > Campus Event Planning > Event Management > Events > Event Template	Specify event meetings.
Meeting Detail	CAMPUS_MEETING1	Campus Community > Campus Event Planning > Event Management > Meetings > Meeting Detail	Enter meeting details, including date, time, and anticipated attendance.
Meeting Sponsor	CAMPUS_MEETING2	Campus Community > Campus Event Planning > Event Management > Meetings > Meeting Sponsor	Enter meeting sponsor and contact information.

Page Name	Definition Name	Navigation	Usage
Meeting Location	CAMPUS_MEETING3	Campus Community > Campus Event Planning > Event Management > Meetings > Meeting Location	Enter meeting location information.
Meeting Resources	CAMPUS_MTG_RSRCES	Campus Community > Campus Event Planning > Event Management > Meetings > Meeting Resources	Schedule meeting resources.
Meeting Staff	CAMPUS_MTG_STAFF	Campus Community > Campus Event Planning > Event Management > Meetings > Meeting Staff	Schedule meeting staff.

Naming an Event

Access the Event page (**Campus Community > Campus Event Planning > Event Management > Events > Event**).

Field or Control	Description
Event ID	When you create a new event, the event ID is all zeros until you save the page. After you save the page, the system assigns the next available event ID.
Event Type	The type, from the Event Types page, that describes this event.
Academic Institution	The academic institution responsible for this event.
Event Manager	The individual at your institution who is managing this event.
Primary Meeting	After you identify a primary meeting for this event on the Event Template page and save that page, the system displays the number of that meeting here. The system displays the location for the meeting in the Location field.
Comment	Comments to further identify or describe this event.
Delete	Click this button to delete this event from your database.

Adding Meetings to an Event

Access the Event Template page (**Campus Community > Campus Event Planning > Event Management > Events > Event Template**).

Note: You can also add meetings to an event on the Meeting Details page.

Copy From Template

If meetings, resources, and staff templates exist for the selected event type (from the meeting Template page, Meeting Resource Templates page, and Meeting Staff Template page), the system displays that data here. You can click either the **Copy** or **Copy All** button to copy the information from those templates to this event. If no template exists, no data appears here and you must add the meetings and assign the resources and staff for this event.

<i>Field or Control</i>	<i>Description</i>
Copy	Click this button to copy each meeting set up for the event type selected with its resources and staff. You can manually change any of the copied information.
Copy All	Click this button to copy all the meetings with their resources and staff. You can manually change any of the copied information.

Note: The **Copy All** button is especially helpful if, for example, if you have the same event each year. Instead of entering the information each time, you can click this button to copy all information from the template and update the information for the current year's event.

To Meetings

<i>Field or Control</i>	<i>Description</i>
Primary Meeting	When selected, indicates that this is the primary meeting for this event.

To Resources

Add the resources and quantity that you need for this meeting. You can also add a brief description.

To Staff

<i>Field or Control</i>	<i>Description</i>
ID	The ID of the individual responsible for this task.

Field or Control	Description
Hours Required	<p>The number of hours that the assigned individual is required to perform or participate in this task.</p> <p>You can also add a brief task description.</p>

Entering Meeting Details

Access the Meeting Detail page (**Campus Community > Campus Event Planning > Event Management > Meetings > Meeting Detail**).

Meeting Detail

Field or Control	Description
Event Meeting	<p>The number of this meeting in the list of meetings for this event.</p> <p>The system automatically enters the next sequential number for each meeting that you add. You can override the number to reorder the list of meetings. When you return to the page, the meetings will be in the specified order.</p>
Primary Meeting	<p>When selected, indicates that this is the primary meeting for this event.</p>
Campus Meeting Type	<p>The meeting type that best describes this meeting.</p> <p>Values for this field are delivered with the system. You can modify these.</p>
Meeting Date	<p>The date when this meeting is scheduled to occur.</p>
Day of the Week	<p>The day of the week when this meeting is scheduled to occur.</p> <p>The system automatically displays the day of the week when you exit the <i>Meeting Date</i> field.</p>
Meeting Start Time	<p>The time when this meeting is scheduled to begin. The system assumes the time is <i>AM</i>. If not, you must enter <i>PM</i>.</p>
End Time	<p>The time when this meeting is scheduled to end. The system assumes the time is <i>AM</i>. If not, you must enter <i>PM</i>.</p>

<i>Field or Control</i>	<i>Description</i>
Contact Minutes	The length or duration of this meeting. The system calculates the contact time based on the meeting start and end times. The system recalculates the contact minutes each time that you change the start or end time. You can override the calculated minutes value.
Expected Attendance	The number of attendees expected at this meeting.
Maximum Attendance	The maximum number of attendees that can be accommodated at this meeting.
Number of Attendees	The number of attendees invited to this meeting. The system displays the number of invited attendees assigned to this meeting on the Event Attendees page.
Comments	Comments to further identify or describe this meeting.

Specifying Meeting Sponsors

Access the Meeting Sponsor page (**Campus Community > Campus Event Planning > Event Management > Meetings > Meeting Sponsor**).

Contact Information

<i>Field or Control</i>	<i>Description</i>
Campus Coordinator	The individual at your institution who is responsible for, or should be contacted, about this meeting.
Department Sponsor	The department at your institution that is responsible for this meeting.
Manager Name	The name of the responsible department's manager. The system displays the Manager field and manager's name only if a manager is associated with this department on the Department Profile page.
Organization ID	The organization that is responsible for or is sponsoring this meeting.

Field or Control	Description
Organization Contact	The individual in the responsible organization who you should contact about this meeting.
Other Coordinator	The additional individual at your institution who is responsible for, or can be contacted about, this meeting.
Name	The name of the additional contact person if the individual does not exist in your database.
Phone	The phone number of the additional contact person if the individual does not exist in your database.

Entering the Meeting Location

Access the Meeting Location page (**Campus Community > Campus Event Planning > Event Management > Meetings > Meeting Location**).

Meeting Location

Field or Control	Description
Campus Facility	<p>When selected, indicates that the location for this meeting is a campus facility.</p> <p>When you select <i>Campus Facility</i>, the system provides the Facility ID field with a prompt list of facility IDs from the Facility Table page.</p>
External Organization Facility	<p>When selected, indicates that the location for this meeting is a facility at or arranged by an external organization.</p> <p>When you select the External Org Facility option, the system displays the organization ID and description from the Meeting Sponsor page and provides the External Org Location field with a prompt list of locations for the organization from the Organization Locations page. When you select a location number, the system displays the address for that location.</p>

<i>Field or Control</i>	<i>Description</i>
Other Facility	<p>When selected, indicates that the location for this meeting is a facility other than at your campus or at an external organization in your database.</p> <p>When you select the Other Facility option, the system displays address fields for you to identify the address or location of the facility.</p>

Scheduling the Meeting Resources

Access the Meeting Resources page (**Campus Community > Campus Event Planning > Event Management > Meetings > Meeting Resources**).

Meeting Resources

<i>Field or Control</i>	<i>Description</i>
Resource Number	<p>The number of this resource in the list of resources for this meeting.</p> <p>The system automatically enters the next sequential number for each resource that you add. You can override the number to reorder the list of resources. When you return to the page, the resources are in the specified order.</p>
Quantity	The number or quantity of the resource required for this meeting.
Resource Code	The type of resource, from the Resource Codes page, required for this meeting.
Description	A brief description to further identify or describe this resource.

Scheduling Meeting Staff

Access the Meeting Staff page (**Campus Community > Campus Event Planning > Event Management > Meetings > Meeting Staff**).

Meeting Staff

Field or Control	Description
Staff Number	<p>The number of this staff person in the list of staff required for this meeting.</p> <p>The system automatically assigns the next sequential number to each staff member that you add. You can override these numbers to rearrange the order of the staff. When you return to the page, the staff members are in the specified order.</p>
ID	The ID of the staff member responsible for this task.
Name	<p>The system automatically displays the individual's name when you select the ID.</p> <p>If the individual does not have an ID in your system, you can enter his or her name in this field.</p>
Staff Code	The type of staff required for this meeting.
Description	The task that the staff member is required to perform or participate in for this meeting.
Hours Required	The number of hours that the responsible individual is required to perform or participate in for this task.

Tracking Event Attendance

This section discusses how to:

- Identify attendees and guests.
- Specify meetings for an attendee and review attendance status.
- (Optional) Enter an attendee's address.

Pages Used to Track Event Attendance

<i>Page Name</i>	<i>Definition Name</i>	<i>Navigation</i>	<i>Usage</i>
Event Attendees	EVENT_ATTENDEE	Campus Community > Campus Event Planning > Event Management > Event Attendance > Event Attendees	Identify individuals invited or scheduled to attend an event, and specify their guest relationships, if any.
Attendee Meetings	EVENT_MEETING1_SEC	Click the Meeting button on the Event Attendees page.	Identify the meetings to which an attendee is invited and the status of his or her attendance.
Event Attendee Address	EVENT_ATND_ADDR	Campus Community > Campus Event Planning > Event Management > Event Attendance > Event Attendee Address	Enter and track attendee addresses for an event.

Identifying Attendees and Guests

Access the Event Attendees page (**Campus Community** > **Campus Event Planning** > **Event Management** > **Event Attendance** > **Event Attendees**).

<i>Field or Control</i>	<i>Description</i>
Attendee	<p>The number of this individual on the list of attendees for this event. For example, attendee 00015 is the 15th attendee on the list of attendees in the system for this event.</p> <hr/> <p>Note: If you are entering an attendee for the first time, the Attendee field is all zeros. Do not override this value. After you enter data and save the page, the system assigns and displays the next sequential attendee number.</p>
Meeting	Click to access the Attendee Meetings page, where you can identify the meetings to which the attendee is invited.
ID	The attendee's ID, if he or she exists in your database.
Name	<p>When you select the attendee's ID, the system automatically displays the individual's name here.</p> <p>If the attendee does not exist in your database, you must enter the attendee's name here.</p>
External Organization ID	The organization's ID, if the attendee is from an organization in your database.

Field or Control	Description
Name	<p>When you select the organization's ID, the system automatically displays the organization's name here.</p> <p>If the organization does not exist in your database, you must enter the organization's name here.</p>
Guest of Attendee	<p>The attendee number of the individual whose guest this individual is. An attendee can have multiple guests.</p> <hr/> <p>Note: You must first create guests as new entries on the list of attendees. You can then select them from that list and associate them as guests of the attendee described on this page.</p>
Guest Relationship	<p>The relationship between the host attendee and the guest attendee. If a guest is identified, the guest relationship is required. If you do not know the relationship, select <i>Unknown</i>.</p> <p>When you save the page, the system lists all guests of the host attendee at the bottom of this page.</p> <p>Values for this field are delivered with the system. You can modify these.</p>
Relationships	<p>Click this link to access the Relationships search box page, where you can create or review a relationship between two individuals in your database.</p> <p>Guest Relationship values are independent of the relationships that you set up on the Relationships page. Guest relationship is a quick method of identifying the association between two attendees specifically for an event.</p>

Specifying Meetings for an Attendee and Reviewing Attendance Status

Access the Attendee Meetings page (click the **Meeting** button on the Event Attendees page).

Meetings

Field or Control	Description
Event Meeting	<p>The number of the meeting to which you want to invite the attendee.</p> <p>When you select the meeting, the system automatically displays the description, date, and start and end times for that meeting from the Meeting pages.</p>

Field or Control	Description
Status	<p>The status of the individual's attendance for this meeting. Status values are <i>Attended</i>, <i>Invited</i>, <i>Not Attend</i>, and <i>Will Attend</i>.</p> <p>Values for this field are delivered with the system. Do not modify these values in any way. Any modifications to these values could require substantial programming effort.</p>

Entering an Attendee's Address (Optional)

Access the Event Attendee Address page (**Campus Community > Campus Event Planning > Event Management > Event Attendance > Event Attendee Address**).

Phone/Address Information

Field or Control	Description
Phone Type	<p>The phone number to use for contacting this attendee.</p> <p>If the attendee has an ID in your database, the system displays the <i>Home</i> phone type and home phone number associated with the home address specified on the Installation Table - SA Options page. You can select a different phone type.</p> <p>If the attendee does not have an ID in your database, enter the phone number manually.</p>
Address Type	<p>The address to use for contacting this attendee.</p> <p>If the attendee has an ID in your database, the system displays the <i>Home</i> address type and home address data specified on the Installation Table - SA Options page. You can select a different address type.</p> <p>If the attendee does not have an ID in your database, enter the address manually.</p>
Attendee's Phones	Click to access the Phone Number page, where you can add or edit the phone numbers for this attendee.
Attendee's Addresses	Click to access the Addresses page, where you can add or edit the address data for this attendee.

Reviewing Events, Meetings, and Attendees

After you enter campus events, you can review the information in several ways. You can review events by facility, review all meetings or all attendees for an event, or review attendees for a meeting. You can even search meetings and events to determine if a specific individual is an attendee.

This section discusses how to:

- Review events by facility and meeting date.
- Review event meetings.
- Review attendees for an event.
- Review attendees by meeting.
- Review event meetings for an attendee.
- Review an attendee's event summary.
- Review an attendee's event meetings summary.
- Review an attendee's guests.

Pages Used to Review Events, Meetings, and Attendance

<i>Page Name</i>	<i>Definition Name</i>	<i>Navigation</i>	<i>Usage</i>
Campus Meeting Details	CAMPUS_MTG_DSPL	Campus Community > Campus Event Planning > View Event Information > Campus Meeting Details	Review events by facility and meeting date.
Event Meeting	CAMPUS_ATT_SUM_INI	Campus Community > Campus Event Planning > View Event Information > Event Summary > Event Meeting	Review all meetings for an event.
Event Attendee	CAMPUS_MTG_ATT_INI	Campus Community > Campus Event Planning > View Event Information > Event Summary > Event Attendee	Review all attendees for an event.
Event Meeting Attendees	ATTENDEE_SUMMARY	Campus Community > Campus Event Planning > View Event Information > Event Summary > Event Meeting Attendees	Review attendees for meetings of an event.

Page Name	Definition Name	Navigation	Usage
Event Attendee Meeting	ATTENDEE_MTG_SUM	Campus Community > Campus Event Planning > View Event Information > Event Summary > Event Attendee Meeting	Review meetings scheduled for specific attendees.
Person Event Summary	PERSON_EVENT_SUMM	Campus Community > Campus Event Planning > View Event Information > Person Event Summary	Review all of the events for which an individual is an attendee. This information is useful for viewing a summary of the individual's meeting schedule.
Attendee Meetings	EVENT_MEETING2_SEC	Click the Meeting button on the Person Event Summary page.	Review the specific meetings that an individual is scheduled to attend at an event.
Attendee Guests	ATTENDEE_GUEST_SEC	Click the Guest button on the Person Event Summary page.	Review all guests assigned to an individual for an event.

Reviewing Events by Facility and Meeting Date

Access the Campus Meeting Details page (**Campus Community** > **Campus Event Planning** > **View Event Information** > **Campus Meeting Details**).

Field or Control	Description
Meeting Date	The calendar date to review to determine if any meetings are scheduled for this facility.
Search	Click this button to launch the search for meetings scheduled for the specified calendar date. If the system finds meetings scheduled for that date, it displays the data in the Campus Meeting Info scroll area at the bottom of the page.

Reviewing Event Meetings

Access the Event Meeting page (**Campus Community** > **Campus Event Planning** > **View Event Information** > **Event Summary** > **Event Meeting**).

This page lists scheduled event meetings and is for viewing purposes only. You cannot enter or modify data here.

Reviewing Attendees for an Event

Access the Event Attendee page (**Campus Community** > **Campus Event Planning** > **View Event Information** > **Event Summary** > **Event Attendee**).

This page lists the attendees for an event and is for viewing purposes only. You cannot enter or modify data here.

Reviewing Attendees by Meeting

Access the Event Meeting Attendees page (**Campus Community > Campus Event Planning > View Event Information > Event Summary > Event Meeting Attendees**).

<i>Field or Control</i>	<i>Description</i>
Event Meeting	The number of the meeting whose attendees you want to review. An event meeting number is required.

Sort By

Select how you want the system to sort the results.

<i>Field or Control</i>	<i>Description</i>
Search	Click this button to launch the search based on the criteria that you selected.

Reviewing Event Meetings for an Attendee

Access the Event Attendee Meeting page (**Campus Community > Campus Event Planning > View Event Information > Event Summary > Event Attendee Meeting**).

<i>Field or Control</i>	<i>Description</i>
Attendee	The attendee number of the attendee whose meetings you want to review. An attendee number is required.

Sort By

Select how you want the system to sort the results.

<i>Field or Control</i>	<i>Description</i>
Search	Click this button to launch the search based on the criteria you selected.

Reviewing an Attendee's Event Summary

Access the Person Event Summary page (**Campus Community** > **Campus Event Planning** > **View Event Information** > **Person Event Summary**).

This page is for viewing purposes only. You cannot enter or modify data here.

<i>Field or Control</i>	<i>Description</i>
Meeting	Click to access the Attendee Meetings page, where you can view the specific meetings that the individual is scheduled to attend at an event.
Guest	Click to access the Attendee Guests page, where you can view all guests assigned to this individual for an event.

Reviewing an Attendee's Event Meetings Summary

Access the Attendee Meetings page (click the **Meeting** button on the Person Event Summary page).

This page lists the meetings scheduled for an attendee in an event. It is for viewing purposes only. You cannot enter or modify data here.

Reviewing an Attendee's Guests

Access the Attendee Guests page (click the **Guest** button on the Person Event Summary page).

This page lists all the guests assigned to this individual for an event and is for viewing purposes only. You cannot enter or modify data here.

Managing External System Data About an Individual or Organization

Understanding External System Data

External system data is data tracked by any system outside of the PeopleSoft database. For example, an external system might track all exchange students or individuals entering the country on a student visa, or it might track all charitable organizations that offer academic achievement scholarships.

You can define codes for the external systems of interest to your institution. You can also enter and track IDs from those systems for individuals and organizations.

Defining External Systems

This section discusses how to define an external system for a person or organization.

Page Used to Define External Systems

<i>Page Name</i>	<i>Definition Name</i>	<i>Navigation</i>	<i>Usage</i>
External System	SCC_EXT_SYS_TBL	Set Up SACR > Product Related > Campus Community > Define Campus Community > Set Up > Define External Systems	Identify the external system and specify if it is associated with an individual, an organization or both.

Defining an External System for a Person or Organization

Access the External System page (**Set Up SACR > Product Related > Campus Community > Define Campus Community > Set Up > Define External Systems**).

External System

<i>Field or Control</i>	<i>Description</i>
Description	Enter the name of the external system.

Person/Organization

<i>Field or Control</i>	<i>Description</i>
Organizations and Persons	<p>Identify the external system as related to organizations, individuals, or to both.</p> <p>When you enter an external ID for an individual on the External System ID page, only the external systems identified here as related to persons are available, and when you enter an external ID for an organization, only the systems identified here as related to organizations are available.</p>

Entering External System IDs

This section discusses how to enter external system IDs for a person or an organization.

Pages Used to Enter External System IDs

<i>Page Name</i>	<i>Definition Name</i>	<i>Navigation</i>	<i>Usage</i>
External System ID	SCC_ORG_EXT_SYS_ID	Campus Community > Personal Information > Identification > External System ID	Enter an external system ID for an organization.
External System ID	SCC_EXT_SYS_ID	Campus Community > Organization > Create/Maintain Organization > External System ID	Enter an external system ID for an individual.

Entering an External System ID for a Person or Organization

Access the External System ID page (**Campus Community > Personal Information > Identification > External System ID**).

External System

<i>Field or Control</i>	<i>Description</i>
External System	Select the external system that contains the ID that you want to enter.

External System Details

<i>Field or Control</i>	<i>Description</i>
External System ID	Enter the external system ID for the individual or organization depending which External System ID page you are using. If the individual or organization has IDs for the external system, you can add them here.

Integrating with Oracle Fusion Cloud Student Aid Eligibility

Understanding Integration with Oracle Fusion Cloud Student Aid Eligibility

As an alternative to Oracle PeopleSoft Campus Solutions (CS) Financial Aid, you can opt to integrate with either Oracle Fusion Cloud Student Financial Aid (SFA) product:

- Student Aid Eligibility (SAE) which is limited to ISIR processing features. The SAE product is for United States use only.
- Student Financial Planning (SFP) which includes ISIR processing, awarding, and disbursement features. SFP supports student financial aid programs in the United States, but can also be used globally.

Neither SFA product supports financial aid localizations for Great Britain or Canada.

This topic describes integration with SAE. For information about integrating with SFP, see [Understanding Integration with Oracle Fusion Cloud Student Financial Planning](#).

The integration between CS and SAE is an exchange of data in the form of receiving specialized messages between the two systems.

CS uses one outbound message to send data *to* SAE:

Student Initiation/Update Event: Initiates a new (or updates existing) student record in SFP with biographical information from CS. These messages are logged with Message Class of STIN.

CS accepts four inbound messages to receive data *from* SAE:

- *Student Notification Event*: SAE sends a message containing critical action notification data that can be used in the CS Notification Framework, for example, a "Complete your FAFSA" message. These messages are logged with Message Class of NTF.
- *Document Request Event*: SAE sends a message containing critical document request data that can be used in the CS Notification Framework. These messages are logged with Message Class of NTF.
- *ISIR Matched Notification Event*: SAE communicates when an ISIR has been matched to a student record in SAE. Can be used to signal request of additional ISIR information. These messages are logged with Message Class of NTF.
- *Valid ISIR Process Status Event*: SAE provides ISIR status and any outstanding actions within the ISIR process. The CS SAE Handlers use this event to determine the updates to several CS FA records, including the STDNT_AID_ATRBT. Each time CS consumes this message, CS FA records

are updated and once this message has a **Valid** status, it indicates the student is ready for award packaging. These messages are logged with Message Class of NTF.

Setting Up Integration with Oracle Fusion Cloud Student Aid Eligibility

This section discusses how to:

- Activate Student Aid Eligibility (SAE) in Campus Solutions (CS)
- Set up SFP Integration Options

Page Used to Set Up Integration with Oracle Fusion Cloud Student Financial Planning

<i>Page Name</i>	<i>Definition Name</i>	<i>Navigation</i>	<i>Usage</i>
Student Financial Planning Installation Setup	SCC_SFP_INSTALL	Campus Community > Student Financial Planning Interface > SFP Installation Setup	Use this page to indicate you want to integrate CS with SAE using PeopleSoft Update Manager Selective Adoption.
Setup SFP Integration Options	SCC_SFP_INT_SETUP	Campus Community > Student Financial Planning Interface > SFP Integration Options	Use this page to select processing options for the Student Leave of Absence, Student Academic and Financial Information (SAFI) messages, ISIR Load Reporting Data.

For descriptions of these pages, see [Setting Up Integration with Oracle Fusion Cloud Student Financial Planning](#).

Exchanging Data with Oracle Fusion Cloud Student Aid Eligibility

This section discusses how to:

- Process SAE Messages
- Review the SFP Message log
- Load SFP Reporting data

Pages Used to Exchange Data with Oracle Fusion Cloud Student Aid Eligibility

<i>Page Name</i>	<i>Definition Name</i>	<i>Navigation</i>	<i>Usage</i>
Process SFP Messages	SCC_RUNCNTL_VOC	Campus Community > Student Fin Planning Interface > Process SFP Messages	Use this page to send messages to and receive messages from SAE.
SFP Message Log	SCC_SFP_MSG_LOG_PG	Campus Community > Student Fin Planning Interface > SFP Message Log	Use this page to view all SAE inbound and outbound messages.
Load SFP Reporting Data	SCC_SFP_LOAD_DATA	Campus Community > Student Fin Planning Interface > Load SFP Reporting Data	Use this page to load SFP Events data into CS Reporting Tables.

Processing SAE Messages

Access the Process SFP Transactions page (**Campus Community > Student Fin Planning Interface > Process SFP Messages**).

<i>Field or Control</i>	<i>Description</i>
Garbage Collection Frequency	<p>Enter a frequency value from 1 to 1,000,000.</p> <p>Long-running batch jobs in the CS/SAE integration may grow in memory usage over time as unreferenced Application Objects accumulate and long files may become very large. The Processing Options assist in reclaiming memory and determine if log files should be created. By setting the frequency to a lower number, the CollectGarbage command is forced to reclaim memory at a higher frequency rate.</p> <hr/> <p>Note: The Processing Options don't impact PS_SCC_SFA_MSG_MAP record.</p> <hr/>
Log Message Detail	Select this check box to override the Integration Broker Log Detail values. If Log Message Detail isn't enabled, the Process Scheduler message log is suppressed.

Field or Control	Description
Message Class	<p>Select one of these Message Classes to push information from CS to SAE:</p> <ul style="list-style-type: none"> • Student Initiation. • Student Update. <p>Leave this field blank to receive information from SAE.</p>
Query Name	<p>For outbound Message Classes, you may select a query using the SCC_SFP_OUT_BND BIND Record to select the students for which you want to process Transactions. The sample delivered queries all start with QA_CS_CC_SFP.</p>

This process uses these Application Engines:

- **SFP Message Pull (SCC_SFP_PULL)**: This pulls the Valid ISIR Process Status Event, ISIR Matched Notification Event, Document Request Events as well as Notification Events from SAE to CS.

The Notification Message Class populates the SCC_SFP_NTF_DAT table.

- **SFP Multipart Message Pull (SCC_SFP_PUL2)**: This allows for a Multipart Message when pulling data from SFP. This process also calls **SFP MIME Validation (SCC_SFP_MV)**. Any processing error or warning conditions can be viewed using the SFP Message log page or the SFP Student Program/Plan Financial Data tab.
- **SCC_VOC_INTF**: This generates and pushes the Student Initiation and Student Update messages from CS to SAE.

The CS Application Engines contain a **Try Catch Block** to identify exceptions and allow the ability to continue processing.

If an Application App Engine is not successful and a 502 error is the reason, update the Integration Broker setup for each message to enable the User Exception flag. See Oracle Fusion Cloud Student Financial Planning: Integration Management (Doc ID 2514682.1), CS/SFP Integration Broker and Postman Setup on [My Oracle Support](#).

Here is the CS/SAE Message Handling Flow:

CS/SAE Message Handling Flow

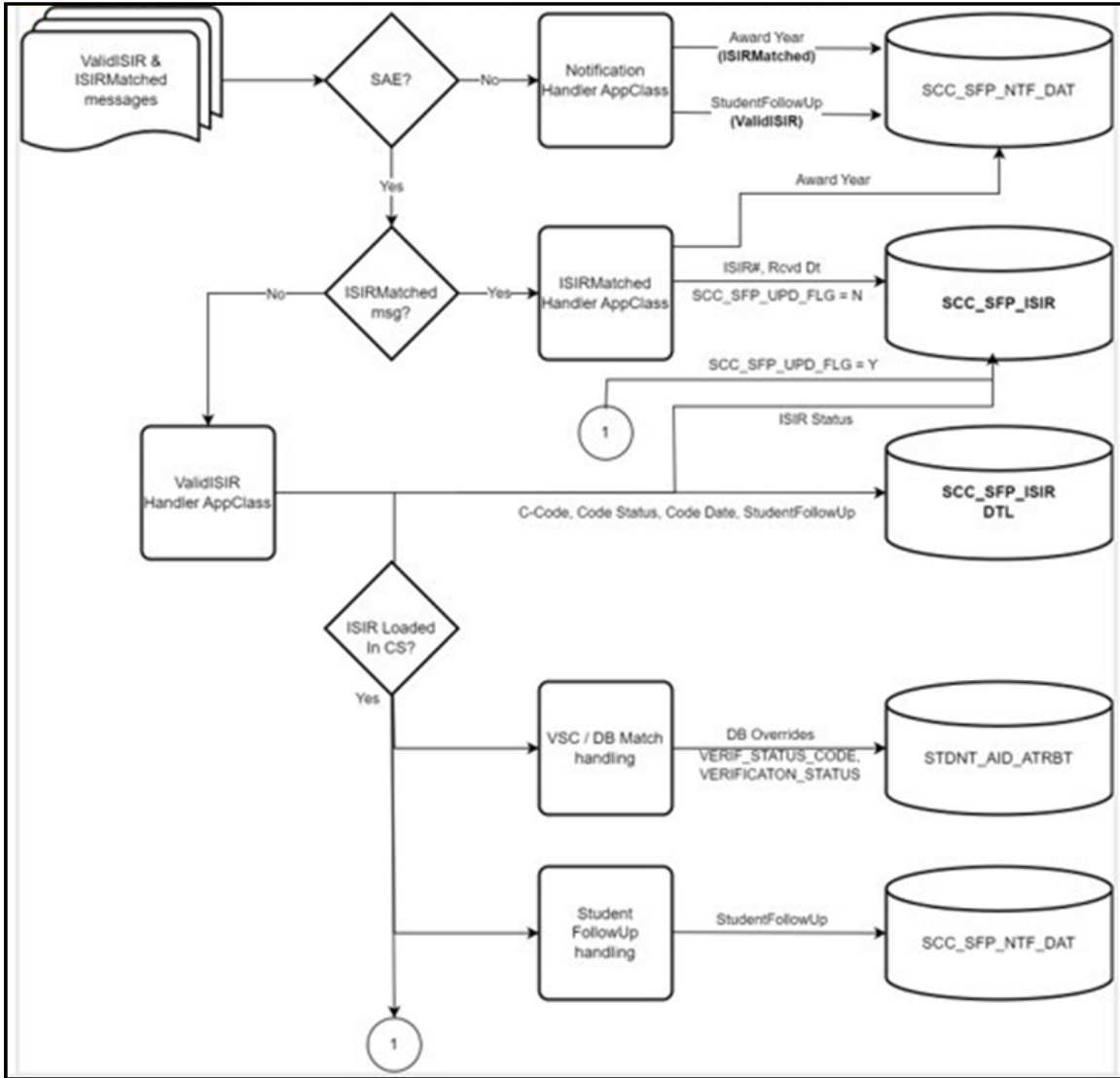

SFP Notifications through the CS Notification Framework

SAE Notification Events are pushed to the CS Notification Framework and CS Batch Notification generates an email, as shown in this diagram.

SFP Notifications through the CS Notification Framework

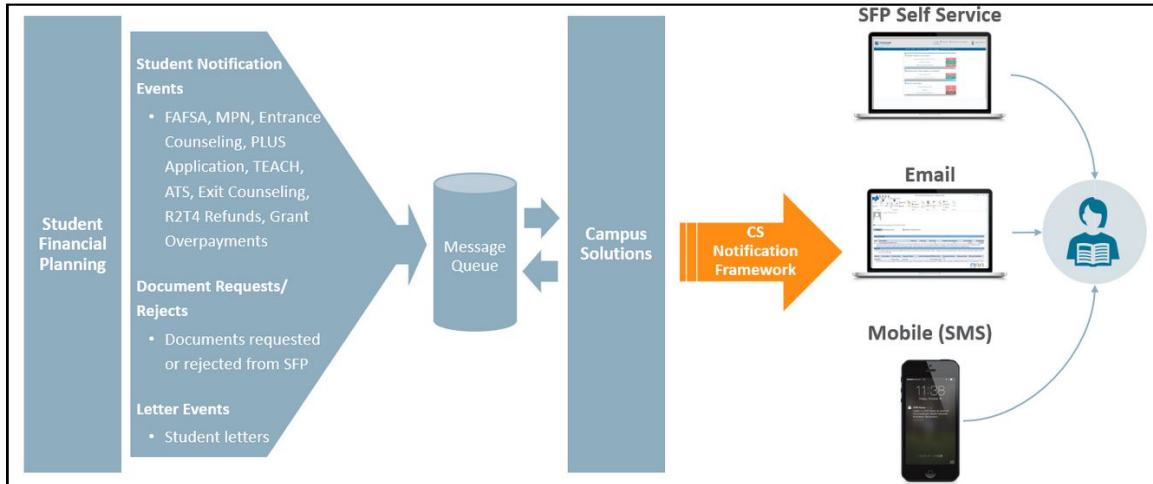

To set up the notifications framework, use these:

- Generic template definition: SFP_NOTIFICATION.
- Notification setup for generic template: SCC_SFP_NOTIFICATION.
- Notification consumer setup: SFP Notifications Consumer.
- Sample Pop select query: QA_CS_CC_SFP_NOTIFICATIONS.

For details, see [Setting Up and Consuming the Notifications Framework](#).

These are the Notification Events currently supported in the SAE Pull Process:

- FasStudentNotificationEvent.
- FasDocumentRequestEvent.
- FasDocumentRejectedEvent.
- FasLetterNotificationEvent.
- FasValidIsirProcessStatusInformationEvent.

ISIR entry saved only if its corresponding StudentFollowUp value is True.

This table explains the notification types.

SAE Notification Type	SAE Notification Trigger	SAE Notification Message Example
FAFSA	SDI is received and no ISIR exists for any open FAFSA award year OR student continues into a new award year and no ISIR exists.	FAFSA for the 24/25 Aid Year is due. Please go to www.fafsa.ed.gov to complete.

SAE Notification Type	SAE Notification Trigger	SAE Notification Message Example
ValidIsirProcessStatusInformationEvent	Populate Generic Message when event message includes an ISIR Code where <StudentFollowUp>true</StudentFollowUp>	One or more FAFSA questions require follow up in order process your financial aid. Please log into your financial aid student portal to review and complete any open action items.

Reviewing the SAE Message Log

Access the Process SAE Message Log page (**Campus Community > Student Fin Planning Interface > SFP Message Log**).

Field or Control	Description
Institution	Select the Institution to filter the results.
Student ID	Enter a Student ID
Message Class	Select an SAE message class to filter the results.
Process Instance	Enter or look up the Process Instance identifier for the SAE message.
Transaction ID	Enter the Universal Unique Identifier (UUID) of the transaction.
Transaction ID Seq (transaction id sequence)	Enter a transaction id sequence number.
SFP Transaction Status	Select a SFP transaction status. The statuses of Error , Success or Warning are assigned by the Message Validation process.
Run Date Range From Date	Enter a from date to return messages processed on or after a certain date.
Run Date Range Through Date	Enter a through date to return messages processed on or before a certain date.

The SFP Message Log provides a view into the table holding all the SFP inbound and outbound messages (PS_SCC_SFA_MSG_MAP). Search criteria allow the user to select specific transactions and display the results.

Use the **Transaction Event** link to view the XML data pertaining to the message.

Use the Transaction Details link to view the error or warning messages for a specific transaction.

If an SFP inbound message fails, use the **Resubmit** option after correcting the error.

Loading SAE Reporting Data

You can use this process to consume incoming SAE Message Events to populate corresponding CS reporting tables.

Access the Process SFP Transactions page (**Campus Community > Student Fin Planning Interface > Load SFP Reporting Data**).

<i>Field or Control</i>	<i>Description</i>
Garbage Collection Frequency	<p>Enter a frequency value from 1 to 1,000,000.</p> <p>Long-running batch jobs in the CS/SFP integration may grow in memory usage over time as unreferenced Application Objects accumulate and long files may become very large. The Processing Options assist in reclaiming memory and determine if log files should be created. By setting the frequency to a lower number, the CollectGarbage command is forced to reclaim memory at a higher frequency rate.</p> <hr/> <p>Note: The Processing Options don't impact PS_SCC_SFA_MSG_MAP record.</p>
Log Message Detail	Select this check box to override the Integration Broker Log Detail values. If Log Message Detail isn't enabled, the Process Scheduler message log is suppressed.
Institution	Select the institution that you need to load reporting data for.
Population Selection	<p>The Population Select target record should only return a list of SCC_VOC_MSQ_SEQ to process.</p> <p>Sample Query: QA_CS_CC_SFP_REPORTING_DATA.</p> <p>Query Prompts: Last Run Date and Time</p> <p>The sample query returns all the Message Sequences under message events Students Awards, Packaging COA, and ISIR that were added since the Last Run Date and Time. You can define a more granular query as long as your query returns a Message Sequence.</p>

Field or Control	Description
Message Event	<p>Select the type of Message Event for the data you want to load:</p> <ul style="list-style-type: none"> • <i>Document Process Status</i> <ul style="list-style-type: none"> • FasDocumentProcessStatusInformationEvent Message • Parses the FasDocumentProcessStatusInformationEvent message event in your population selection and populates the SFP Document Information reporting tables. • <i>ISIR</i> <ul style="list-style-type: none"> • FasIsirMatchedNotificationEvent Message • Populates the SFP ISIR Reporting Tables for unique combinations of AwardYear and IsirTransactionnumber. • <i>NSLDS only</i> <ul style="list-style-type: none"> • FasFinancialAidHistoryInformationRequestReply Message • Populates the NSLDS reporting tables. Only called for new unstored NSLDS Financial Aid History files.

Integrating with Oracle Fusion Cloud Student Financial Planning

Understanding Integration with Oracle Fusion Cloud Student Financial Planning

As an alternative to Oracle PeopleSoft Campus Solutions (CS) Financial Aid, you can opt to integrate with either Oracle Fusion Cloud Student Financial Aid (SFA) product:

- Student Financial Planning (SFP) which includes ISIR processing, awarding, and disbursement features. SFP supports student financial aid programs in the United States, but can also be used globally.
- Student Aid Eligibility (SAE) which is limited to ISIR processing features. The SAE product is for United States use only.

Neither SFA product supports financial aid localizations for Great Britain or Canada.

This topics describes integration with SFP. For information about integrating with SAE, see [Understanding Integration with Oracle Fusion Cloud Student Aid Eligibility](#).

The integration between CS and SFP is an exchange of data in the form of sending and receiving specialized messages between the two systems.

CS uses five outbound messages to send data to SFP:

- *Student Initiation Event*: Initiates new students in SFP with biographic information from CS. These messages are logged with Message Class of STIN.
- *Student Update Event*: Sends updated biographic information from CS for students already established in SFP. If an `emplid` has a biographic or demographic update, CS allows the `PERSON_BASIC_SYNC` message to trigger the SFP's Student Update Event message. These messages are logged with Message Class of STUP.
- *Student Academic and Financial Information (SAFI) Event*: Sends Student Record (Academic Program, Enrolled Classes, Grades, and so on.), Student Financial (Charges, Student Resources), and Projected Course Units (SFP's Packaging) information to SFP. Details of a student's academic program can be taken from either `STNDT_CAR_TERM` table or `ADM_APPL_PROG` table. These messages are logged with Message Class of SAFI.
- *Leaves of Absence and Breaks in Attendance Event*: Sends Student Records Leave of Absence information to SFP. These messages are logged with Message Class of STLA.
- *Student Groups Event*: Communicates the status of the Student Group associated with the student and defines whether a student group was added to or removed from the student. Data included in this message event is meant to provide a comprehensive list of Student Groups information for the

student record and replaces, *not appends to*, any previous versions of this message. These messages are logged with Message Class of SGRP.

CS accepts seven inbound messages to receive data *from* SFP:

- *Disbursement Information Event*: Provides SFP disbursement information to CS by populating SF Group Data Entry for follow on Group Post. To process SFP Plus loans, the FasPlusApplicationInformationRequest web service is invoked to obtain biographic and demographic data of the borrower or parent. The FasPlusApplicationInformationReply service is used to continue processing the Plus loan disbursement. These messages are logged with Message Class of DISB.
- *Return to Lender Event*: Provides information about disbursed payments that have been reduced (triggered from repackaging, R2T4, etc.). The transactions update CS SF Group Data Entry for follow-on Group Post. These messages are logged with Message Class of RTLN.
- *Anticipated Aid Event*: Provides information about students' anticipated financial aid in SFP for possible use in Student Financial processes: Customer Account, Payment Plans, Billing, Aging, and Term/Class Cancellation. These messages are logged with Message Class of AAID.

Note: SFP is the source of the awards and students should use the SFP Student Self Service UI for self service viewing and accepting awards.

- *Disbursement Cancellation Event*: Provides information about Awards that have been cancelled due to student not attending and removes the Awards from PS_ANTICIPATED_AID record. The message is logged with Message Class DCAN.
- *Title 4 Data Needed*: SFP sends a message that a R2T4 calculation is being made and requires data to be sent to use for this calculation. This message is sent if the SAFI is *not* created with the correct Return to Title IV elements. These messages are logged with Message Class of T4DN.
- *Notification Events*: SFP sends a message containing SFP notification data that can be used in the CS Notification Framework. These messages are logged with Message Class of NTF.
- *Unsupported*: SFP sends additional messages that do *not* automatically trigger CS system processes at this time. These messages are logged with Message Class of UNSP.

Setting Up Integration with Oracle Fusion Cloud Student Financial Planning

This section discusses how to:

- Activate Student Financial Planning (SFP) or Student Aid Eligibility (SAE) in Campus Solutions (CS)
- Set up SFP Group Control
- Set up SFP Academic Terms for Projections
- Set up SFP Integration Options

Pages Used to Set Up Integration with Oracle Fusion Cloud Student Financial Planning

<i>Page Name</i>	<i>Definition Name</i>	<i>Navigation</i>	<i>Usage</i>
Student Financial Planning Installation Setup	SCC_SFP_INSTALL	Campus Community > Student Financial Planning Interface > SFP Installation Setup	Use this page to indicate you want to integrate CS with SFP using PeopleSoft Update Manager Selective Adoption.
Student Financial Planning Group Setup	SCC_SFP_GRP_SETUP	Campus Community > Student Financial Planning Interface > SFP Group Setup	Use this page to set up the parameters for inbound messages from SFP for updating CS Student Financials.
SFP Term Setup	SCC_SFP_TERM_SETUP	Campus Community > Student Financial Planning Interface > SFP Terms for Projections	Use this page to define the terms within the Academic Year for projections.
Setup SFP Integration Options	SCC_SFP_INT_SETUP	Campus Community > Student Financial Planning Interface > SFP Integration Options	Use this page to select processing options for the Student Leave of Absence, Student Academic and Financial Information (SAFI) messages, ISIR Load Reporting Data.

Important! In addition to the setups in this topic, complete the SFP-specific Academic Program and Student Financials setups:

“Setting Up SFP Attributes” (Campus Solutions Application Fundamentals).

“Mapping Financial Transactions between CS Student Financials and Student Financial Planning (SFP)” (Student Financials).

The **Disbursement Date Item** setting in **Posting Setup** tab in “Setting Up Business Units” (Student Financials).

Activating Student Financial Planning in Campus Solutions

Access the Student Financial Planning Installation Setup page (**Campus Community > Student Financial Planning Interface > SFP Installation Setup**).

Use this page to indicate that you want to integrate CS with SFP or SAE using PeopleSoft Update Manager Selective Adoption and to define PLUS Loan Options.

Field or Control	Description
Enable SFP Interface	<p>Select this check box if you are integrating CS with SFP using PeopleSoft Update Manager (PUM) Selective Adoption. This check box must be selected to run Process SFP Messages.</p> <p>Selecting this option disables the Enable ISIR Verification check box.</p> <hr/> <p>Note: You must have an instance of Oracle Fusion Cloud Student Financial Planning (SFP) licensed and provisioned to select this option.</p>
Enable ISIR Verification	<p>Select this check if you are integrating CS with SAE using PeopleSoft Update Manager (PUM) Selective Adoption.</p> <p>Selecting this option disables the Enable SFP Interface check box and PLUS Loan Options.</p> <hr/> <p>Note: You must have an instance of Oracle Fusion Cloud Student Aid Eligibility (SAE) licensed and provisioned to select this option.</p>
Next SFP Message Sequence	Displays a counter that is incremented with each SFP message sent or received.
PLUS Loan Phone Type	Select the value to use when creating the biographic and demographic information of the borrower.
Loan Email Address Type	Select the value to use when creating the biographic and demographic information of the borrower.
Borrower US Citizen	Select the appropriate institution-defined Citizenship Definition to this corresponding Common Origination and Disbursement (COD) value.
Borrower Eligible Non-Citizen	Select the appropriate institution-defined Citizenship Definition to this corresponding Common Origination and Disbursement (COD) value.
Borrower Ineligible Non-Citizen	Select the appropriate institution-defined Citizenship Definition to this corresponding Common Origination and Disbursement (COD) value.

Important! Ensure that **Address Usage** is defined in Campus Community installation. Address is required for the STUDENT_INITIATION message when integrating with SFP. See [Reviewing or Defining Default Installation Settings for Events, Relationships, SEVIS, Checklists, National IDs, Communication Preferences, and Fluid](#).

Setting Up SFP Group Control

Access the SFP Group Setup page (**Campus Community > Student Fin Planning Interface > SFP Group Setup**).

If the SFP Disbursement Item Types are using a Charge Priority List where the Use Aid Year flag is enabled, setup these controls:

- Define Federal Aid Year
- Define Financial Aid Year
- Valid Careers for Aid Year
- Valid Terms for Aid Year

<i>Field or Control</i>	<i>Description</i>
Origin ID	Enter an Origin ID to indicate the source of the transactions. Depending on the Origin ID, approval for the transactions might be required. Student Financials Security can be placed on this field to allow individual sources (origins) to access only their groups of transactions.
Group Type	Select the Student Financials Group Type.
Assigned Operator ID	Select the ID of the administrator that the background disbursement process assigns to all group post transactions created in Student Financials. The record and field PS_GROUP_CONT_INFO.ASSN_OPRID is updated in Student Financials. All financial aid funds processed in batch are assigned this ID. You can view this assigned ID in the various Group Post-related components.
Group Line Daily Limit	Enter a number from 1 to 999. The value is used to determine the number of Group Lines for a group in one day. For example, if the Group Line Daily Limit is 100, and 300 disbursements are processed from Student Financial Planning in one day, 3 groups are created.

Defining Academic Terms for SFP Projections

Access the Student Financial Planning Installation Setup page (**Campus Community > Student Fin Planning Interface > SFP Terms for Projections**).

<i>Field or Control</i>	<i>Description</i>
Academic Career	Select the Academic Career to which you want to associate Terms from the Academic Year in context.

Field or Control	Description
NFF Estimated Award Start Date	<p>Enter a date when you want to start having SFP estimated Non-Federal Funds inserted into the CS PS_ANTICIPATED_AID record.</p> <p>For additional information on setting up Estimated Non Federal Funds, see Mapping Financial Transactions between CS Student Financials and Student Financial Planning in “Setting Up Item Types and Item Type Groups” (Student Financials).</p>
Term	Select a term that you want to associate with the Academic Career.

To accurately award students, SFP defines the student's Academic Year and Loan Periods. SFP uses the information received in the Student Academic and Financial Information (SAFI) message to calculate terms, academic years, and loan periods. To create the SAFI with Projected Course Units, Academic Terms must be associated with Academic Careers in the SFP Term Setup page. The calculation uses SFP Total Required Units attribute for the Academic Program and the student's Academic Load. The Academic Load is derived from the level load rule setup based on student's approved academic load. Projected courses and terms are generated by the SAFI handler until total required units for the program has been reached or exceeded.

Note: To identify the final academic year to be considered for proration, SFP uses the last academic year received in the Student Academic and Financial Information (SAFI) message. To ensure correct Direct Loan calculations, **all** academic years up to the end of the student's program must be sent in the SAFI Message.

After generating projections to meet total required units, the SAFI process continues to generate projections up through the specified Expected Graduation Term. If the Expected Graduation Term is not specified, projection processing ends once total required units is reached.

Projected units are generated for a summer term if a student is term activated in a summer term, even if the term is not defined in the SFP term for projections setup.

Course Credits are excluded from completed program when projecting units for an Admissions Application program.

Defining SFP Integration Options

Access the SFP Integration Options page (**Campus Community > Student Fin Planning Interface > SFP Integration Options**).

SFP defines the student's Academic Year and Loan Periods to accurately award students. SFP uses the information received in the Student Academic and Financial Information (SAFI) message to calculate terms, academic years, and loan periods. To create the SAFI with Projected Course Units, Academic Terms must be associated with Academic Careers in the SFP Term Setup page. The calculation uses SFP Total Required Units attribute for the Academic Program and the student's Academic Load. The Academic Load is derived from the level load rule setup based on student's approved academic load.

Projected courses and terms are generated by the SAFI handler until total required units for the program has been reached or exceeded.

After generating projections to meet total required units, the SAFI process continues to generate projections up through the specified Expected Graduation Term. If the Expected Graduation Term is not specified, projection processing ends once total required units is reached.

Projected units are generated for a summer term if a student is term activated in a summer term, even if the term is not defined in the SFP term for projections setup.

Course Credits are excluded from completed program when projecting units for an Admissions Application program.

Student Academic and Financial Information

<i>Field or Control</i>	<i>Description</i>
Send Graduated Status	<p>Select to generate a 'Graduated' SAFI when an Academic Program change causes the Program Type to change within the same Career. This generates a SAFI for the 'change from' Academic Program with an Enrollment Status of Graduated and an Enrollment Status Effective Date equal to the effective date of the Academic Program or Academic Plan change.</p> <p>Also, if the student is term-activated in the new Academic Program and that Term is within the scope of the SAFI run (see Maximum Career Term Record in Process SFP Messages), a new Program Code/Record is generated, and a SAFI is sent for the Academic Program.</p>
Course Attribute	<p>Select a Course Attribute.</p> <p>For information about Course Attributes, see “Creating Course Offerings” (Student Records).</p>
Course Attribute Value	Select a Course Attribute Value .
Common Attribute	<p>Select a Common Attribute that is configured to represent an Fully Enrolled Date.</p> <p>The Common Attribute must have Attribute Type of Date and a Record Context Reference of ACAD_CALTRM_TBL. See Defining a Common Attribute.</p>
Include Prior Academic Year	Select to include term data from the prior academic year in the SAFI. For example, if a student started in Summer 2022 and that term was part of the 2023 academic year, the first academic year sent in the SAFI would be 2022.

Field or Control	Description
Post for initial SAFI	Select to send the Packaging Start Date Message Event for every new SAFI with a new SFP Program Code. This includes the first SAFI sent for a student and every subsequent new SAFI with a new SFP Program Code.

Student Leave of Absence

Select a **Holiday Schedule** to include a list of scheduled breaks in the Leave of Absence Message (FasStudentLoaAndBreaksInAttendanceEvent). If you need to enter separate holiday schedules for each career at the institution, leave **Holiday Schedule** blank and use the table below to enter holiday schedules by career. You can define as many holiday schedules as you need; holiday descriptions can be duplicated within a schedule.

The range of holiday dates included in the message event is limited to those that fall within a student's minimum term begin date and the student's maximum term begin date, or the student's expected graduation term, whichever is later.

Here's an example:

- If a student is term activated only for 2023 Fall (8/29/23 through 12/11/23) when a Leave of Absence message is generated, the message will include only those holidays/breaks that fall within those dates.
- If a new message is generated for the same student after they are term activated for 2024 Spring (1/23/24 through 5/7/24), the message will include all scheduled breaks that fall within the start of 2023 Fall and the end of 2024 Spring (8/29/23 through 5/7/24), including any holidays/breaks that are scheduled between the end of 2023 Fall and the beginning of 2024 Spring.
- If the same student had an expected graduation term of 2024 Fall, the message would include all scheduled breaks that fall within the start of 2023 Fall and the end of 2024 Fall (8/29/23 through 12/11/24), including any holidays/breaks that are scheduled between the end of 2023 Fall and the beginning of 2024 Spring as well as those that scheduled between the end of 2024 Spring and the beginning of 2024 Fall.

Contiguous holiday dates are reported in one entry in the message event using the description for the first holiday. A sequence number is also appended to the description to ensure that the entry is unique in the message payload. For example, two distinct holidays defined in the Holiday Schedule as "Thanksgiving – 11/23/23" and "Day After Thanksgiving – 11/24/23" would be reported in a message as one scheduled break with a description of "Thanksgiving 1," a start date of 11/22/23, and end date of 11/24/23.

For information about Holiday Schedules, see [Setting Up Holiday Schedules](#).

Load SFP Reporting Data

Beginning with the 2024-2025 Aid Year, ISIR data includes Federal Tax Information data which has different security requirements than other ISIR data. You can choose whether to import this data into your ISIR Reporting Table.

Select **Include FTIM Data** if you want to include FTIM (Federal Tax Information Module) data in the ISIR Reporting Table load. This option should only be selected if your institution chooses to persist FTIM Reporting Table and the XML payload in the SFP Message Map table.

Note: When you select **Include FTIM Data**, you must grant query access to the FTIM reporting table (SCC_SFP_R_ISR_F). Navigate to **PeopleTools > Security > Query Security > Query Access Manager**.

Exchanging Data with Oracle Fusion Cloud Student Financial Planning

This section discusses how to:

- Process SFP Messages
- View the student's Academic Year Program and Plan and financial data
- Review the SFP Message log
- Validate SFP Messages
- Load SFP Reporting data

Pages Used to Exchange Data with Oracle Fusion Cloud Student Financial Planning

<i>Page Name</i>	<i>Definition Name</i>	<i>Navigation</i>	<i>Usage</i>
Process SFP Messages	SCC_RUNCNTL_VOC	Campus Community > Student Fin Planning Interface > Process SFP Messages	Use this page to send messages to and receive messages from SFP.
Student Program/Plan	SCC_SFP_PROGRAM SCC_SFP_PROGRAM2	Campus Community > Student Fin Planning Interface > SFP Student Program/Plan	Use the SFP Program tab to view data from the student's Academic Career Program/Plan included in the SFP SAFI message. Use the Financial Data tab to view a cross-reference of SFP Disbursement and Return 2 Lender messages to Student Financials transaction tables.
SFP Message Log	SCC_SFP_MSG_LOG_PG	Campus Community > Student Fin Planning Interface > SFP Message Log	Use this page to view all SFP inbound/outbound messages.

Page Name	Definition Name	Navigation	Usage
SFP Message Validation	SCC_SFP_MV	Campus Community > Student Fin Planning Interface > SFP Message Validation	Use this page to validate SFP messages with these modes: <ul style="list-style-type: none"> • Populate Historical Data • Validations • Corrections
Load SFP Reporting Data	SCC_SFP_LOAD_DATA	Campus Community > Student Fin Planning Interface > Load SFP Reporting Data	Use this page to load SFP Events data into CS Reporting Tables.

Processing SFP Messages

Access the Process SFP Transactions page (**Campus Community > Student Fin Planning Interface > Process SFP Messages**).

Field or Control	Description
Garbage Collection Frequency	<p>Enter a frequency value from 1 to 1,000,000.</p> <p>Long-running batch jobs in the CS/SFP integration may grow in memory usage over time as unreferenced Application Objects accumulate and long files may become very large. The Processing Options assist in reclaiming memory and determine if log files should be created. By setting the frequency to a lower number, the CollectGarbage command is forced to reclaim memory at a higher frequency rate.</p> <hr/> <p>Note: The Processing Options don't impact PS_SCC_SFA_MSG_MAP record.</p>
Log Message Detail	<p>Select this check box to override the Integration Broker Log Detail values. If Log Message Detail isn't enabled, the Process Scheduler message log is suppressed.</p>

Field or Control	Description
Message Class	<ul style="list-style-type: none"> • Select one of these Message Classes to push information from CS to SFP: <ul style="list-style-type: none"> • Student Academic and Fin Info (student academic and financial information, SAFI). • Student Groups. • Student Initiation. • Student Leave of Absence. • Student Update. • Leave this field blank to pull this information from SFP to CS: <ul style="list-style-type: none"> • Anticipated Aid. • Disbursement Information. • Disbursement Cancel (Anticipated Aid). • Return to Lender. • Message Validation Error. • Notifications. • Title IV Data Needed. • Unsupported.
Maximum Career Term Record	<p>Select a term to control the scope of the student term and related program data (STDNT_CAR_TERM) used to generate a SAFI. If a value is entered here, the SAFI won't include any term/program data that is effective after the selected term.</p>
Query Name	<p>For outbound Message Classes (Student Academic and Fin Info, Student Initiation, Student Leave of Absence, Student Update, and Student Group), you may select a query using the SCC_SFP_OUT_BND BIND Record to select the students for which you want to process Transactions. There are five sample delivered queries:</p> <ul style="list-style-type: none"> • QA_CS_CC_SFP_STUDENTINITIATION • QA_CS_CC_SFP_SAFI • QA_CS_CC_SFP_STUDENT_INIT_2 • QA_CS_CC_SFP_STUDENT_UPDATE • QA_CS_CC_SFP_STUDENTGROUPS

This process uses these Application Engines:

- **SFP Message Pull (SCC_SFP_PULL):** This pulls Anticipated Aid, Disbursements, Disbursement Cancellation, and Return to Title IV transactions as well as Notification Events from SFP to CS. This process also calls SFP MIME Validation (SCC_SFP_MV). Any processing error or warning conditions can be viewed using the SFP Message log page or the SFP Student Program/Plan Financial Data tab.

The Anticipated Aid Message Class (FasFinancialPlanOutboundV2Event) populates the ANTICIPATED_AID table.

The Disbursement Cancellation event removes Awards from the ANTICIPATED_AID table.

The Disbursement Information and Return to Lender Message Classes create a Student Financial Group Data Entry. SFP Fund Codes are mapped to SF Item Types. See “Mapping Financial Transactions between CS Student Financials and Student Financial Planning (SFP)” (Student Financials).

Note: Disbursements for a student must be posted prior to processing the return to lender transactions. The return to lender process does not create the Group Control and Group line entries if the disbursement is not found on the PAYMENT_TBL table.

The Notification Message Class populates the SCC_SFP_NTF_DAT table.

- **SFP Multipart Message Pull (SCC_SFP_PUL2):** This allows for a Multipart Message when pulling data from SFP. This process also calls **SFP MIME Validation (SCC_SFP_MV)**. Any processing error or warning conditions can be viewed using the SFP Message log page or the SFP Student Program/Plan Financial Data tab.
- **SCC_VOC_INTF:** This generates and pushes the Student Academic and Fin Info (student academic and financial information, SAFI), Student Groups, Student Initiation, Student Leave of Absence, and Student Update messages from CS to SFP.

The CS Application Engines contain a “Try Catch Block” to identify exceptions and allow the ability to continue processing.

If an Application App Engine is not successful and a 502 error is the reason, update the Integration Broker setup for each message to enable the User Exception flag. See Oracle Fusion Cloud Student Financial Planning: Integration Management (Doc ID 2514682.1), CS/SFP Integration Broker and Postman Setup on My Oracle Support.

General SAFI Processing Rules

CS/SFP SAFI Process

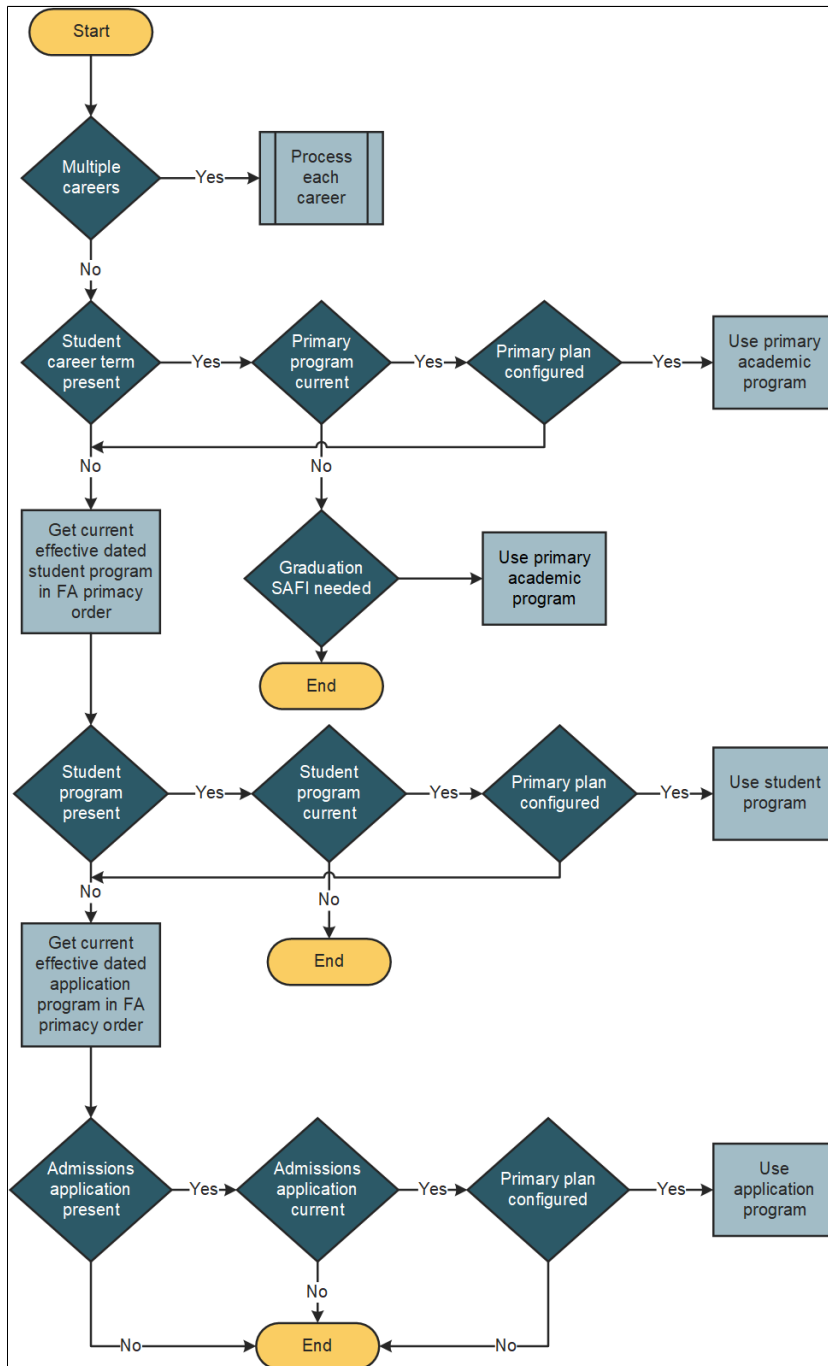

Multiple Academic Careers result in multiple SAFIs generated, one for each career.

- If a student is in multiple Academic Programs within one Academic Career:
 - The Primary Academic Program in Student Career Term is selected.
 - If Student Career Term data is not found, then the Academic Program with the lowest Primacy Number is selected.

- If a student is in concurrent Academic Programs in the same Academic Career and the Programs are effective at the same time, then the Program with the lowest Primacy Number is selected. The SAFI Process assigns a different Academic Program code for successive programs in the each Academic Career (for example, a student is matriculated in a second undergraduate program after completing an initial undergraduate program).
- If a student is in multiple Academic Plans within an Academic Program, the Academic Plan with the lowest sequence number (PLAN_SEQUENCE) takes precedence.
- If a student has an Academic Program with an Expired Program Status such as *Completed*, *Discontinued*, *Deceased*, *Dismissed*, or *Suspended* with Effective Dates prior to the Process Run Date, the system sends a Terminating SAFI, as appropriate.
- If a student has completed a graduate Academic Program and has an open admissions application for a second graduate Academic Program, the SAFI Manager looks in each Academic Career and considers which Academic Program to use in the SAFI in this order:
 1. Primary Academic Program in Student Career Term.
 2. Matriculated Academic Program.
 3. Admissions Application Program.

Note: If you do not want to send a Student Program/Plan to SFP, leave the **SFP Program Type** blank. This is in the Academic Plan setup and intended for non-degree Academic Programs and Plans you may have defined.

Note: When SAFI Student Resources are sent to SFP, CS Third Party Payment Contracts and CS Waivers are sent with no <PaymentId>.

SAFI Program Codes

The SAFI Program Code is a concatenation of Institution and a new SFP Program Code (sequential number):

Program <Code> Scheme	Example
INSTITUTION-ACAD_PROG-ACAD_PLAN-CAMPUS (prior to P119)	<Code>PSUNV-BSHA-BSHA-MAIN</Code>
INSTITUTION-SCC_SFP-PROG-CODE (as of P119)	<Code>PSUNV-001</Code>

Use the SFP Program/Plan component to view the Academic Career Program/Plan that will be used in the creation of the SAFI.

Academic Career is appended to the SAFI <ExternalProgramId>.

<ExternalProgramId> Scheme	Example
INSTITUTION-ACAD_PROG-ACAD_PLAN-CAMPUS (prior to P119)	<ExternalProgramId>PSUNV-BSHA-BSHA-MAIN</ExternalProgramId>
INSTITUTION-ACAD_PROG-ACAD_PLAN-CAMPUS-ACAD_CAREER (as of P119)	<ExternalProgramId>PSUNV-BSHA-BSHA-MAIN-UGRD</ExternalProgramId>

Data Upgrade

Because a quick turnaround on a data scrubbing upgrade script carries outsized risks, the Program Code is referenced in over 100 tables in SFP.

The best approach is to continue sending the legacy Program Code with updated external Program ID, Program Description and other Program/Plan related attributes until a CS Program/Plan change is detected. If the CS Program/Plan change is detected to be material, then a new SAFI is generated with a new Program Code using the new scheme. This approach means that a new enrollment is not created for these students until a CS Program/Plan change is detected to be material.

CS Academic Program/Plan Changes

In general, CS Program/Plan changes in the same Student Career Number are not considered a material change. An undeclared student who is declaring their major would not be considered a material change. The SFP Program Type needs to change for a CS Program or Plan change to be considered material. This typically applies to 0-6 programs that take a student from a 4-year undergraduate phase to a 2-year professional phase in the same Academic Career.

Here are additional CS Program/Plan changes that are considered material, generate a new program code, and result in a new enrollment in SFP:

- Application or matriculation in a new academic career. For example, a student is applying for a graduate program while completing an undergraduate degree.
- A new student career number in the same Academic Career. For example, a student is pursuing a second undergraduate degree after completing at first 2-year undergraduate degree first.
- Students in a dual degree program defined in separate Academic Careers have a separate SAFI for each academic career. For example, a student is in a JD-MBA program.
- A program change within the same career number, where the SFP program type changes, generates a new program number if the SFP integration option for SAFI for **Program Type Changes within Career, Send Graduated Status** is set to **Yes**. See "Define LOA and SAFI Options for SFP" in [Setting Up Integration with Oracle Fusion Cloud Student Financial Planning](#).

Define your Population Selection query to identify students to integrate to SFP. The SAFI process selects the student program/plan information to send to SFP based on the following flow:

PLUS Disbursement Processing

The CS-SFP pull process for the FasDisbursementInformationEvent looks at the refund indicator, and, if a borrower exists, the FasPlusApplicationInformationRequest web service is invoked to retrieve the

biographic and demographic information of the borrower. The FasPlusApplicationInformationReply service provides the information to CS, and the Constituent Transaction Management (CTM) framework is triggered. After the borrower has been found or created, a relationship between the student and borrower is created where the Relationship value is *PL* (PLUS loan borrower).

- SFP supports the packaging of multiple PLUS applications submitted by a single borrower for an academic year. SFP packages and originates a separate PLUS loan per PLUS application.
- For multiple PLUS Loan Application Records, messages include the <ApplicationID> for each borrower.
- If Transaction Setup Matches Found value is *Suspend* (multiple matches), then insert into GROUP_LINE.POST_FLAG = 'D'. This causes the GROUP_CONT_INFO to not be in balance and posting status = incomplete.
- The posting status of *Incomplete* alerts the user there is an issue so they can manually research to find the correct REFUND_EMPLID value and then manually reverse the GROUP_LINE.POST_FLAG = 'N'.
- The process only throws an exception if the required fields to create a Constituent (SSN, First Name, Last Name) are not found. For the other records, if the required fields are missing, it does not throw an exception or create a row.
- Integration messages allow your financial system to use the School Credit Balance and Refund Balance options on the PLUS application to accurately determine the anticipated aid and apply the PLUS loan funds to the student account once disbursed.

Note: Graduate PLUS Disbursement Processing does not invoke the FasPlusApplicationInformationRequest web service but does update the Group Line from the FasDisbursementInformationEvent. Graduate PLUS loans do not update Campus Community bio/demo data for the student.

PLUS Loan Disbursement Process

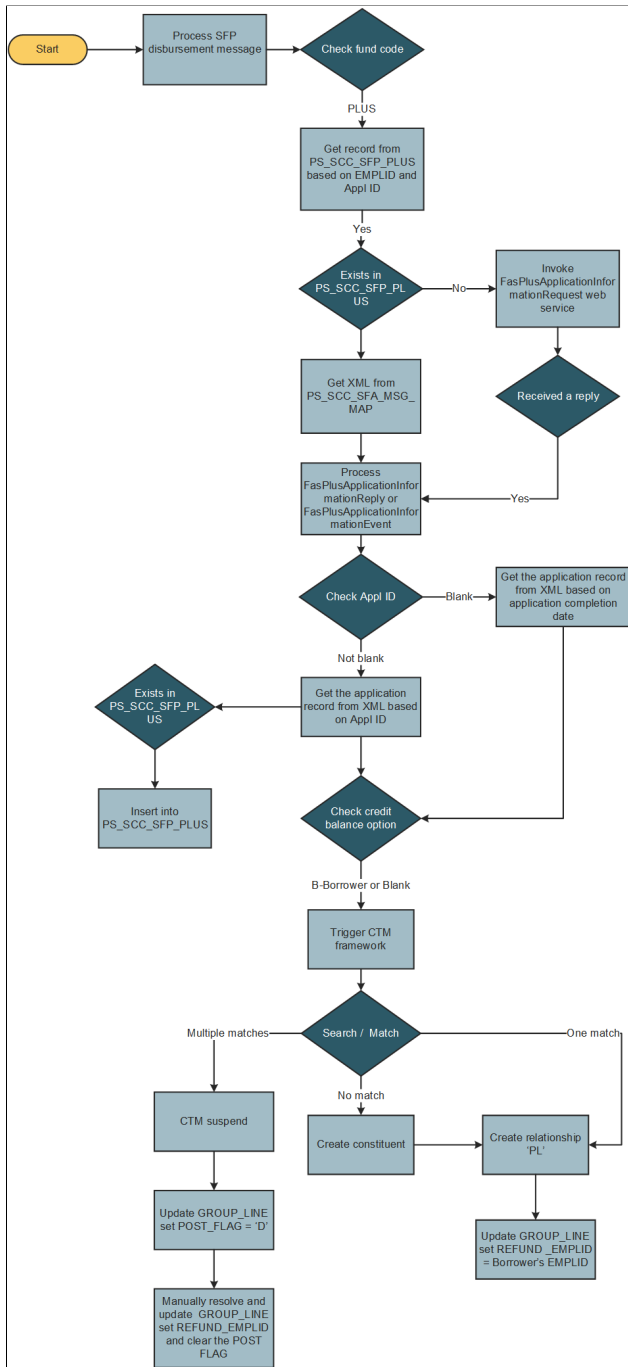

SFP Notifications through the CS Notification Framework

SFP Notification Events are pushed to the CS Notification Framework and CS Batch Notification generates an email, as shown in this diagram.

SFP Notifications through the CS Notification Framework

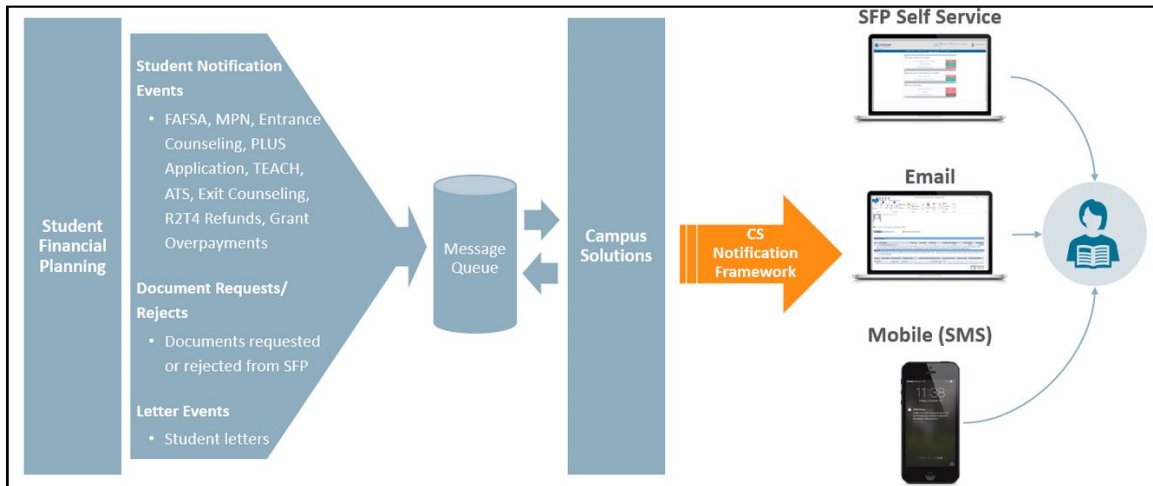

To set up the notifications framework, use these:

- Generic template definition: SFP_NOTIFICATION.
- Notification setup for generic template: SCC_SFP_NOTIFICATION.
- Notification consumer setup: SFP Notifications Consumer.
- Sample Pop select query: QA_CS_CC_SFP_NOTIFICATIONS.

For details, see [Setting Up and Consuming the Notifications Framework](#).

These are the Notification Events currently supported in the SFP Pull Process:

- FasStudentNotificationEvent.
- FasDocumentRequestEvent.
- FasDocumentRejectedEvent.
- FasLetterNotificationEvent.

MessageClass: FasStudentAwardInformationV2Event.

- FasValidIsirProcessStatusInformationEvent.

ISIR entry saved only if its corresponding StudentFollowUp value is True.

This table explains the notification types.

Note: *You can configure the notification trigger criteria.
**You can configure the notification message text.

SFP Notification Type	SFP Notification Trigger	SFP Notification Message
FAFSA	SDI is received and no ISIR exists for any open FAFSA award year OR student continues into a new award year and no ISIR exists.	FAFSA for 18/19 Award Year is due. Please go to www.fafsa.ed.gov to complete.
MPN (per Type: Sub/Unsub, PLUS or Grad PLUS)	Student is Repackaged*	Please complete your Direct Sub/Unsub Loan master promissory note at www.studentloans.gov .
Entrance Counseling (per Type: Sub/Unsub, Grad PLUS)	Student is Repackaged*	Please complete your Direct Sub/Unsub Loan entrance counseling at www.studentloans.gov .
PLUS Application (per Type: PLUS or Grad PLUS)	Student is Repackaged*	Please complete your Graduate PLUS Application at www.studentloans.gov .
TEACH Grant Counseling	Student is Repackaged*	Please complete your TEACH Grant entrance counseling at www.studentloans.gov .
Ability to Service (ATS) Acknowledgement	Student is Repackaged*	Please complete your ATS acknowledgement at www.studentloans.gov .
Exit Counseling (Loans or TEACH for Graduating or Withdrawn Students)	Student withdraws or graduates and has disbursements from the institution of Title IV loans or TEACH grants.*	Please complete your Title IV Loan exit counseling at www.studentloans.gov .
R2T4 Refund	Student withdraws and an R2T4 calculation is triggered that results in a refund of funds.	A refund is due based on the Return to Title IV calculation determined for the student.
Grant Overpayment (per Grant Type: Pell, FSEOG, TEACH or IASG)	Student withdraws and an R2T4 calculation is triggered that results in a grant overpayment amount due from the student.	A grant overpayment was issued and requires repayment. You owe \$ <i><Grant Overpayment Amount></i> .
ValidIsirProcessStatusInformationEvent	Populate Generic Message when event message includes an ISIR Code where <code><StudentFollowUp>true</StudentFollowUp></code>	Example: "One or more FAFSA questions require follow up in order process your financial aid. Please log into your financial aid student portal to review and complete any open action items."

SFP Notification Type	SFP Notification Trigger	SFP Notification Message
Award Letter	A fund is updated to Awarded AND Associated Award Amounts Determined QC Hold is Released	FN1 Award Letter is intended to notify the student that funds have been awarded.

Viewing the SFP Student Program/Plan

View student Academic Program/Plan and financial data.

View SFP Academic Program/Plan

Access the SFP Student Program/Plan page (**Campus Community > Student Fin Planning Interface > SFP Student Program/Plan > SFP Program** tab).

This page displays SFP data from the student's Academic Career Program/Plan.

Note: The Override fields are for future use.

View Financial Data

Access the SFP Student Program/Plan page (**Campus Community > Student Fin Planning Interface > SFP Student Program/Plan > Financial Data** tab).

This page displays a cross-reference of SFP Disbursement and Return 2 Lender messages to Student Financials transaction tables.

Field or Control	Description
Filter	You can filter the results by Academic Institution , Term , Reference Nbr (reference number), Item Type , and Academic Program Disbursement Report Sequence .
Cross Reference Disbursement Reporting to SF Account (cross reference disbursement reporting to student financials account)	Displays Disbursements/Return 2 Lender messages and the Item Amount from the SF Customer Account.
Get Disbursement Data	Pulls current disbursement reporting data to populate Cross Reference Disbursement Reporting to SF Account .
Message Event Group Line	Displays information from the SFP Message Log and the corresponding Group Line transaction for both Disbursement and Return 2 Lender SFP Messages.

Field or Control	Description
Item SF/Item Line (item student financials / item line)	Displays posting information corresponding to the SFP Disbursements and Return 2 Lender messages.
Group Line	Displays information specific to one emplid for the lines created from SFP's Disbursement and Return 2 Lender messages.
SFP Message Event Log (student financial planning message event log)	<p>Displays SFP's disbursement and Return 2 Lender messages with the corresponding SFP Message Sequence.</p> <p>Use the Transaction Event link to view the XML data pertaining to the message.</p> <p>Use the Transaction Details link to view the error or warning messages for a specific transaction.</p> <p>If an SFP inbound message fails, use the Resubmit option after correcting the error.</p>

Reviewing the SFP Message Log

Access the Process SFP Message Log page (**Campus Community > Student Fin Planning Interface > SFP Message Log**).

Field or Control	Description
Institution	Select the Institution to filter the results.
Student ID	Enter a Student ID
Message Class	Select an SFP message class to filter the results.
Process Instance	Enter or look up the Process Instance identifier for the SFP message.
Transaction ID	Enter the Universal Unique Identifier (UUID) of the transaction.
Transaction ID Seq (transaction id sequence)	Enter a transaction id sequence number.
SFP Transaction Status	Select a SFP transaction status. The statuses of Error , Success or Warning are assigned by the Message Validation process.

Field or Control	Description
Run Date Range From Date	Enter a from date to return messages processed on or after a certain date.
Run Date Range Through Date	Enter a through date to return messages processed on or before a certain date.

The SFP Message Log provides a view into the table holding all the SFP inbound and outbound messages (PS_SCC_SFA_MSG_MAP). Search criteria allow the user to select specific transactions and display the results.

Use the **Transaction Event** link to view the XML data pertaining to the message.

Use the Transaction Details link to view the error or warning messages for a specific transaction.

If an SFP inbound message fails, use the **Resubmit** option after correcting the error.

Validating SFP Messages

Access the Process SFP Transactions page (**Campus Community > Student Fin Planning Interface > SFP Message Validation**).

Use this page to search for possible processing errors in CS/SFP integration tables.

Field or Control	Description
Processing Mode	<p>Select a Processing Mode:</p> <ul style="list-style-type: none"> • Correction: There are 3 data scenarios that are detected by this mode: <ul style="list-style-type: none"> • EMPLID field value mismatch between the current value in SFP Message Event Log (SCC_SFA_MSG_MAP) and payload message data. • Blank INSTITUTION field in SFP Message Event Log (SCC_SFA_MSG_MAP). • Blank Application ID in PLUS mapping table. • Populate Historical Data: Typically, this mode is used only once to populate new fields in the SFP Message Event Log (SCC_SFA_MSG_MAP) table and new child reconciliation (SCC_SFP_MSG_GLN) table. • Resubmit: This mode recreates missing Group Line disbursement or return-to-lender transactions identified by the validation process. • Validation: This mode checks for: <ul style="list-style-type: none"> • MIME Validation: Verifies that each Message Event GUID in a MIME payload is accounted for as a separate message event entry. • Message Event Validation: Identifies unprocessed Message Event entries. • Missing Group Line for Disbursement or Return to Lender message events. • Missing SFP notification data for Notification message events. • Missing Anticipated Aid data for Anticipated Aid message events.

Loading SFP Reporting Data

You can use this process to consume incoming SFP Message Events to populate corresponding CS reporting tables.

Access the Process SFP Transactions page (**Campus Community > Student Fin Planning Interface > Load SFP Reporting Data**).

Field or Control	Description
Garbage Collection Frequency	<p>Enter a frequency value from 1 to 1,000,000.</p> <p>Long-running batch jobs in the CS/SFP integration may grow in memory usage over time as unreferenced Application Objects accumulate and long files may become very large. The Processing Options assist in reclaiming memory and determine if log files should be created. By setting the frequency to a lower number, the CollectGarbage command is forced to reclaim memory at a higher frequency rate.</p> <hr/> <p>Note: The Processing Options don't impact PS_SCC_SFA_MSG_MAP record.</p> <hr/>
Log Message Detail	<p>Select this check box to override the Integration Broker Log Detail values. If Log Message Detail isn't enabled, the Process Scheduler message log is suppressed.</p>
Institution	<p>Select the institution that you need to load reporting data for.</p>
Population Selection	<p>The Population Select target record should only return a list of SCC_VOC_MSQ_SEQ to process.</p> <p>Sample Query: QA_CS_CC_SFP_REPORTING_DATA.</p> <p>Query Prompts: Last Run Date and Time</p> <p>The sample query returns all the Message Sequences under message events Students Awards, Packaging COA, and ISIR that were added since the Last Run Date and Time. You can define a more granular query as long as your query returns a Message Sequence.</p>

Field or Control	Description
Message Event	<p>Select the type of Message Event for the data you want to load:</p> <ul style="list-style-type: none"> • <i>Awards, COA, NSLDS & Disb</i> <ul style="list-style-type: none"> • FasFinancialPlanOutboundV2Event Message • Populates the Awards, COA, NSLDS and disbursement reporting tables, excluding data that would be duplicated such as program, course, student resources, and so on. • <i>Awards, Packaging and COA only</i> <ul style="list-style-type: none"> • FasFinancialPlanOutboundV2Event Message • Populates the Awards, Packaging and COA reporting tables. • <i>Disbursement Only</i> <ul style="list-style-type: none"> • FasFinancialPlanOutboundV2Event Message • Populates the disbursement reporting tables. • <i>Document Process Status</i> <ul style="list-style-type: none"> • FasDocumentProcessStatusInformationEvent Message • Parses the FasDocumentProcessStatusInformationEvent message event in your population selection and populates the SFP Document Information reporting tables. • <i>ISIR</i> <ul style="list-style-type: none"> • FasIsirMatchedNotificationEvent Message • Populates the SFP ISIR Reporting Tables for unique combinations of AwardYear and IsirTransactionnumber. • <i>NSLDS only</i> <ul style="list-style-type: none"> • FasFinancialAidHistoryInformationRequestReply Message • Populates the NSLDS reporting tables. Only called for new unstored NSLDS Financial Aid History files. • <i>SAP Information</i> <ul style="list-style-type: none"> • FasSapAcademicInformationEvent Message

<i>Field or Control</i>	<i>Description</i>
	<ul style="list-style-type: none"> Parses the FasSapAcademicInformationEvent message event in your population selection and populates the SFP Satisfactory Academic Progress reporting tables.

Reviewing and Expiring Anticipated Aid

You can review and expire SFP Anticipated Aid.

This section discusses how to:

- Expire SFP Anticipated Aid for a single student.
- Expire SFP Anticipated Aid in batch.

Pages Used to Expire Anticipated Aid

<i>Page Name</i>	<i>Definition Name</i>	<i>Navigation</i>	<i>Usage</i>
Expire SFP Anticipated Aid	SCC_SFP_ANTAID_EDT	Campus Community > Student Fin Planning Interface > Expire SFP Anticipated Aid > Expire SFP Anticipated Aid	Expire anticipated aid for any financial aid item type displayed. Also view the student's anticipated aid for a particular term.
Expire Anticipated Aid in Batch	SCC_SFP_RUN_ANTAID	Campus Community > Student Fin Planning Interface > Batch SFP Anticipated Aid > Expire Anticipated Aid in Batch	In batch, expire all anticipated aid for an aid year and term, expire anticipated aid by financial aid item type, aid year, and term, or reset the expiration date for unexpired anticipated aid by financial aid item type, aid year, and term.

Expiring SFP Anticipated Aid for a Single Student

Access the Expire SFP Anticipated Aid page (**Campus Community > Student Fin Planning Interface > Expire SFP Anticipated Aid > Expire SFP Anticipated Aid**).

To expire Anticipated Aid by student, select the Awards and click **Expire Anticipated Aid** to set the expire date to the current date. Doing so expires the anticipated aid for that financial aid item type. You must exit the page and access it again to see the expired asterisk displayed next to the Net Award amount. Expired awards aren't available as Anticipated Aid in CS Student Financials processes.

Field or Control	Description
Select to Expire	Select the check box for each Item Type you want to expire.
Expire Anticipated Aid	Click this button to set the Disbursement Expire Date to the current date. This expires the anticipated aid for the financial aid item type. You must exit the page and access it again to have the expired asterisk appear in the untitled column next to the Net Award Amount column. After you click the button, exit the page, and then access the page again, this button is no longer available for this financial aid item type.
Disbursement Plan	Displays the default value <i>V/C</i> for Oracle Student Financial Planning (SFP).
Disbursement ID	Displays the SFP <PaymentPeriodNumber> defined in the Financial Planning Outbound Event (FPOv2).
Disbursement Apply Date	Displays a date only used as part of the algorithm to determine if the Award can be inserted into PS_ANTICIPATED_AID. For the CS/SFP integration it doesn't reflect when the Award can be displayed. This date is calculated using the SFP Attributes setup in "Setting Up Item Types and Item Type Groups" (Student Financials).
Disbursement Expire Date	Displays the last date the award can be used in Student Financials processes: Customer Account, Payment Plans, Billing, Aging, and Term/Class Cancellation. This date is calculated using the SFP Attributes setup in "Setting Up Item Types and Item Type Groups" (Student Financials).
Net Award Amount	Displays the net amount to be disbursed to the student for the term for this financial aid item type. If this amount is zero, the award has been disbursed.

Expiring SFP Anticipated Aid in Batch

Access the Expire Anticipated Aid in Batch page (**Campus Community > Student Fin Planning Interface > Batch SFP Anticipated Aid > Expire Anticipated Aid in Batch**).

Field or Control	Description
Expire Options	<p>Select one option:</p> <ul style="list-style-type: none">• Expire all anticipated aid: Select this option to expire all anticipated aid for the selected Aid Year and Term.• Expire by Item Type: Select this option to expire all anticipated aid for a single financial aid Item Type for the selected Aid Year and Term. <p>Multiple Item Types can be selected for expiration.</p> <ul style="list-style-type: none">• Reset Expiration Date: Select this option to reset the Expiration Date for all anticipated aid for a single financial aid Item Type for the selected Aid Year and Term. <p>You can only expire awards where the Expire Dt is greater or equal to the current date.</p>

Population Selection Process Queries and Equations

Queries for Population Selection

The PeopleSoft system delivers some predefined queries and Equation Engine equations for use with the Population Selection process. This document provides a list of those queries and equations that it delivers as of the date of this publication. Check with your department or system administrator to determine if your institution has created other queries or equations that you should use, or if additional queries or equations have been provided since the date of this publication.

The queries and equations listed in this document should be used as examples of how to create your own. They do not necessarily correspond to real business process transactions.

Query Name	Description	Process
QA_CS_AA_PS_AARPTRQST	Population Selection AA Report by Career	Generate Report Requests (SAA_RPT_RQST app engine)
SAA_RPT_ACADLEVEL	AA Report Query by Acad Level	Generate Report Requests (SAA_RPT_RQST app engine)
SAA_RPT_ADVISOR	AA Report Query by Advisor	Generate Report Requests (SAA_RPT_RQST app engine)
SAA_RPT_CAREER	AA Report Query by Career	Generate Report Requests (SAA_RPT_RQST app engine)
SAA_RPT_PROGPLAN	AA Report Query by Plan	Generate Report Requests (SAA_RPT_RQST app engine)
SAA_RPT_PROGRAM	AA Report Query by Program	Generate Report Requests (SAA_RPT_RQST app engine)
SAA_RPT_STUDENT_GROUPS	AA Report Query by Student Grp	Generate Report Requests (SAA_RPT_RQST app engine)
QA_CS_AD_PS_APPDEL_01	Population Selection query for batch Application Delete testing	Application Delete by Batch (SAD_APP_DEL app engine)

Query Name	Description	Process
QA_CS_AD_PS_APPDEL_02	Population Selection query for batch Application Delete testing	Application Delete by Batch (SAD_APP_DEL app engine)
QA_CS_AD_PS_APPDEL_03	Population Selection query for batch Application Delete testing	Application Delete by Batch (SAD_APP_DEL app engine)
QA_CS_AD_PS_PROSDEL_01	Population Selection Query for Batch Prospect Delete Testing	Prospect Delete by Batch (SAD_PRS_DEL app engine)
QA_CS_AD_PS_PROSDEL_02	Population Selection Query for Batch Prospect Delete Testing	Prospect Delete by Batch (SAD_PRS_DEL app engine)
QA_CS_AD_PS_PROSDEL_03	Population Selection Query for Batch Prospect Delete Testing	Prospect Delete by Batch (SAD_PRS_DEL app engine)
QA_CS_AD_PS_PROSDEL_04	Population Selection Query for Batch Prospect Delete Testing	Prospect Delete by Batch (SAD_PRS_DEL app engine)
QA_CS_CC_EMS_APPL	Population Selection Query for EMS Create Appl Eval	Create and Maintain Evaluations (SCC_GE_MAINT app engine)
QA_CS_CC_EMS_THESIS	Population Selection Query for EMS Create Thesis Eval	Create and Maintain Evaluations (SCC_GE_MAINT app engine)
QA_CS_CC_EMS_UPD_DEL	Population Selection Query for EMS Update Delete	Create and Maintain Evaluations (SCC_GE_MAINT app engine)
QA_CS_CC_NSLDS_UPD1	Population Selection Query for NSLDS Data Push	NSLDS Data Push (SFA_NSLDSUPDS app engine)
QA_CS_CC_NSLDS_UPD2	Population Selection Query for NSLDS Data Push	NSLDS Data Push (SFA_NSLDSUPDS app engine)
QA_CS_CC_NSLDS_UPD_DAY_BEFORE	Population Selection Query for NSLDS Data Push	NSLDS Data Push (SFA_NSLDSUPDS app engine)
QA_CS_CC_NSLDS_UPD_WEEK_BEFORE	Population Selection Query for NSLDS Data Push	NSLDS Data Push (SFA_NSLDSUPDS app engine)
QA_CS_CC_POP_ADM_PRSPCT_CAR	Population Update Query for ADM_PRSPCT_CAR	Population Selection Update where record set to ADM_PRSPCT_CAR (SCC_POP_UPD app engine)

Query Name	Description	Process
QA_CS_CC_POP_APPL_RCR_CA	Population Update of Application Recruiter Category	Population Selection Update where record set to ADM_APPL_RCR_CA (SCC_POP_UPD app engine)
QA_CS_CC_POP_ASG_CITIZENSHIP	Population Update Query for SFA_ASG_ORG_DTL	Population Selection Update where record set to SFA_ASG_ORG_DTL (SCC_POP_UPD app engine)
QA_CS_CC_POP_CARTERM	Population Update of Student Career Term	Population Selection Update where record set to STDNT_CAR_TERM (SCC_POP_UPD app engine)
QA_CS_CC_POP_EA_PROC_STATUS	Population Update Query for SFA_EASTAGE_DTL	Population Selection Update where record set to SFA_EASTAGE_DTL (SCC_POP_UPD app engine)
QA_CS_CC_POP_INSTREL	Population Selection Query for Batch Prospect Delete Testing	Population Selection Update where record set to PERS_INST_REL (SCC_POP_UPD app engine)
QA_CS_CC_POP_LOAN_ORIG_DTL	Population Update Query for LOAN_ORIG_DTL	Population Selection Update where record set to LOAN_ORIG_DTL (SCC_POP_UPD app engine)
QA_CS_CC_POPPELL_CITIZENSHIP	Population Update Query for PELL_ORIG_DTL	Population Selection Update where record set to PELL_ORIG_DTL (SCC_POP_UPD app engine)
QA_CS_CC_POPPELL_ORIG_FIELDS	Population Update Query for PELL_ORIGINATN	Population Selection Update where record set to PELL_ORIGINATN (SCC_POP_UPD app engine)
QA_CS_CC_POP_PKGVAR	Population Update Query for STDNT_PKG_VAR	Population Selection Update where record set to STDNT_AID_ATRBT (SCC_POP_UPD app engine) Population Selection Update where record set to STDNT_PKG_VAR (SCC_POP_UPD app engine) Population Selection Update where record set to INAS_PROF_EXT (SCC_POP_UPD app engine) Population Selection Update where record set to INAS_CALC_RECS (SCC_POP_UPD app engine)

Query Name	Description	Process
QA_CS_CC_POP_SLC_STUDENT	Population Update Query for SFA_SLC_STUDENT	Population Selection Update where record set to SFA_SLC_STUDENT (SCC_POP_UPD app engine)
QA_CS_CC_POP_STDCAR	Query for Population Update of STDNT_CAREER	Population Selection Update where record set to STDNT_CAREER (SCC_POP_UPD app engine)
QA_CS_CC_POP_STDEQUTN	Population Update for STDNT_EQUTN_VAR	Population Selection Update where record set to STDNT_EQUTN_VAR (SCC_POP_UPD app engine)
QA_CS_CC_POP_STDNTAID	Population Update Query for STDNT_AID_ATRBT	Population Selection Update where record set to STDNT_AID_ATRBT (SCC_POP_UPD app engine) Population Selection Update where record set to STDNT_PKG_VAR (SCC_POP_UPD app engine) Population Selection Update where record set to INAS_PROF_EXT (SCC_POP_UPD app engine) Population Selection Update where record set to INAS_CALC_RECS (SCC_POP_UPD app engine)
QA_CS_CC_POP_STDNT_FATERM	Population Update Query for STDNT_FA_TERM	Population Selection Update where record set to STDNT_FA_TERM (SCC_POP_UPD app engine)
QA_CS_CC_POP_LOAN_DISBMNT	Population Update for LOAN_DISBMNT	Population Selection Update where record set to LOAN_DISBMNT (SCC_POP_UPD app engine)
QA_CS_CC_POPPELL_DISBMNT	Population Update for PELL_DISBMNT	Population Selection Update where record set to PELL_DISBMNT (SCC_POP_UPD app engine)
QA_CS_CC_PS_3CENGINE_ADMA	Population Selection and 3C Engine - ADMA	3C Engine when Administrative Function is ADMA (3C ENGINE app engine)
QA_CS_CC_PS_3CENGINE_ADMP	Population Selection and 3C Engine - ADMP	3C Engine when Administrative Function is ADMP (3C ENGINE app engine)

Query Name	Description	Process
QA_CS_CC_PS_3CEngine_AVAK	Population Selection and 3C Engine - AVAK	3C Engine when Administrative Function is AVAK (3C ENGINE app engine)
QA_CS_CC_PS_3CEngine_AVIN	Population Selection and 3C Engine - AVIN	3C Engine when Administrative Function is AVIN (3C ENGINE app engine)
QA_CS_CC_PS_3CEngine_AVMS	Population Selection and 3C Engine - AVMS	3C Engine when Administrative Function is AVMS (3C ENGINE app engine)
QA_CS_CC_PS_3CEngine_AWRD	Population Selection and 3C Engine - AWRD	3C Engine when Administrative Function is AWRD (3C ENGINE app engine)
QA_CS_CC_PS_3CEngine_FINA	Population Selection and 3C Engine - FINA	3C Engine when Administrative Function is FINA (3C ENGINE app engine)
QA_CS_CC_PS_3CEngine_GENO	Population Selection and 3C Engine - GENO	3C Engine when Administrative Function is GEN for Organization (3C ENGINE app engine)
QA_CS_CC_PS_3CEngine_GENP	Population Selection and 3C Engine - GENP	3C Engine when Administrative Function is GEN for person (3C ENGINE app engine)
QA_CS_CC_PS_3CEngine_IHC	Population Selection and 3C Engine - IHC	3C Engine when Administrative Function is IHC (3C ENGINE app engine)
QA_CS_CC_PS_3CEngine_ISIR	Population Selection and 3C Engine - ISIR	3C Engine when Administrative Function is ISIR (3C ENGINE app engine)
QA_CS_CC_PS_3CEngine_LOAN	Population Selection and 3C Engine - LOAN	3C Engine when Administrative Function is LOAN (3C ENGINE app engine)
QA_CS_CC_PS_3CEngine_PROP	Population Selection and 3C Engine - PROP	3C Engine when Administrative Function is PROP (3C ENGINE app engine)
QA_CS_CC_PS_3CEngine_PROS	Population Selection and 3C Engine - PROS	3C Engine when Administrative Function is PROS (3C ENGINE app engine)

Query Name	Description	Process
QA_CS_CC_PS_3CEngine_PSSV	Population Selection and 3C Engine - PSSV	3C Engine when Administrative Function is ADMA (3C ENGINE app engine)
QA_CS_CC_PS_3CEngine_RSTR	Population Selection and 3C Engine - RSTR	3C Engine when Administrative Function is PSSV (3C ENGINE app engine)
QA_CS_CC_PS_3CEngine_SFACO	Population Selection and 3C Engine - SFAC Organization based	3C Engine when Administrative Function is SFAC for organization (3C ENGINE app engine)
QA_CS_CC_PS_3CEngine_SFACP	Population Selection and 3C Engine - SFAC Person Based	3C Engine when Administrative Function is SFAC for person (3C ENGINE app engine)
QA_CS_CC_PS_3CEngine_SFBI	Population Selection and 3C Engine - SFBI	3C Engine when Administrative Function is SFBI (3C ENGINE app engine)
QA_CS_CC_PS_3CEngine_SFCO	Population Selection and 3C Engine - SFCO	3C Engine when Administrative Function is SFCO (3C ENGINE app engine)
QA_CS_CC_PS_3CEngine_SFIT	Population Selection and 3C Engine - SFIT	3C Engine when Administrative Function is SFIT (3C ENGINE app engine)
QA_CS_CC_PS_3CEngine_SFPA	Population Selection and 3C Engine - SFPA	3C Engine when Administrative Function is SFPA (3C ENGINE app engine)
QA_CS_CC_PS_3CEngine_SFRC	Population Selection and 3C Engine - SFRC	3C Engine when Administrative Function is SFRC (3C ENGINE app engine)
QA_CS_CC_PS_3CEngine_SFRF	Population Selection and 3C Engine - SFRF	3C Engine when Administrative Function is SFRF (3C ENGINE app engine)
QA_CS_CC_PS_3CEngine_SFTPO	Population Selection and 3C Engine - SFTP Organization Based	3C Engine when Administrative Function is SFTP for organization (3C ENGINE app engine)
QA_CS_CC_PS_3CEngine_SFTPP	Population Selection and 3C Engine - SFTP Person Based	3C Engine when Administrative Function is SFTP for person (3C ENGINE app engine)

Query Name	Description	Process
QA_CS_CC_PS_3CEngine_STRM	Population Selection and 3C Engine - STRM	3C Engine when Administrative Function is STRM (3C ENGINE app engine)
QA_CS_CC_PS_SI_ACADRECRUIT	Population Selection for Service Indicators - Academic Recruits	Mass Assign Service Indicator (SCC_SI_ASSN app engine) Mass Release Service Indicator (SCC_SI_RELS app engine)
QA_CS_CC_PS_SI_ACADRECRUIT_P	Population Selection for Service Indicators - Academic Recruits	Mass Assign Service Indicator (SCC_SI_ASSN app engine) Mass Release Service Indicator (SCC_SI_RELS app engine)
QA_CS_CC_PS_SI_AMOUNTDUE_ORG	Population Selection for Service Indicators - Organization with Amounts Due	Mass Assign Org Service Indicator (SCC_ORG_ASSN app engine) Mass Release Org Service Indicator (SCC_ORG_RELS app engine)
QA_CS_CC_PS_SI_AMOUNTDUE_ORG_P	Population Selection for Service Indicators - Organization with Amounts Due	Mass Assign Org Service Indicator (SCC_ORG_ASSN app engine) Mass Release Org Service Indicator (SCC_ORG_RELS app engine)
QA_CS_CC_PS_SRVCIND_ORGS	Population Selection for Service Indicators - Organizations	Mass Assign Org Service Indicator (SCC_ORG_ASSN app engine) Mass Release Org Service Indicator (SCC_ORG_RELS app engine)
QA_CS_CC_PS_SRVCIND_PERS	Population Selection for Service Indicators - Person	Mass Assign Service Indicator (SCC_SI_ASSN app engine) Mass Release Service Indicator (SCC_SI_RELS app engine)
QA_CS_CC_PS_STDNT_GRP	Population Selection - Student Groups	Mass Contract Select (SSF_PS_TPC app engine)
QA_CS_CC_PS_USER_SCTY_REPLACE	Population Selection and User Security Replacement	Mass User Security Replacement (SCC_SCRT_UPD app engine)
QA_CS_FA_INSTPRESENT	QA_CS_FA_INSTPRESENT	Mass Packaging Select (SFA_BPKGSEL app engine)

Query Name	Description	Process
QA_CS_FA_ISIRPRESENT	QA_CS_FA_ISIRPRESENT	Mass Packaging Select (SFA_BPKGSEL app engine)
QA_CS_FA_NEEDUPDT	Test query for Need Summary Update	Select Students for Need Summary Validation (FAPPKNSD COBOL SQL)
QA_CS_FA_NEEDUPDT_FARPK0001	Test query for Need Summary Update	Select Students for Need Summary Validation (FAPPKNSD COBOL SQL)
QA_CS_FA_NEEDUPDT_FARPK0002	Test query for Need Summary Update	Select Students for Repackaging (SFA_RPKGSEL app engine)
QA_CS_FA_NEEDUPDT_FARPK0003	Test query for Need Summary Update	Select Students for Repackaging (SFA_RPKGSEL app engine)
QA_CS_FA_NEEDUPDT_FARPK0012	Test query for Need Summary Update	Select Students for Repackaging (SFA_RPKGSEL app engine)
QA_CS_FA_SAP	Test Query for SAP Pop Selection	Process SAP (SFA_SAP_BDRV app engine)
QA_CS_FA_SFEA_UGRD	QA_CS_FA_SFEA_UGRD	SF External Award Feed (SSF_EXT_AWDS app engine)
QA_CS_FA_USER_EDIT_MSG	Test query for Population Selection for User Edit Messages	Process User Edit Messages (SFA_EDIT_MSG app engine)
QA_CS_FA_USER_EDIT_MSG	Population Update Query for INAS_FED_EXT and INAS_PROF_EXT	Population Selection Update where record set to INAS_FED_EXT (SCC_POP_UPD app engine) Population Selection Update where record set to INAS_PROF_EXT (SCC_POP_UPD app engine)
QA_CS_SF_1098PRT	Batch 1098-T Print	Batch Print (SSF_1098 app engine)
QA_CS_SF_1098UPD	1098-T TIN Request Update	TIN Request Update (SSF_1098_UPD app engine)
QA_CS_SF_GROUPLINE	Population Selection for Group Post Transactions	Pop Select for Group Line (SSF_GRPS_POP app engine)
QA_CS_SF_PYMTPLANS	Population Selection for Specific Account Number	Mass Contract Select (SSF_PS_TPC app engine)

Query Name	Description	Process
QA_CS_SF_WV_ASSIGN	Population Selection for Mass Assign Student Waivers	Student Waiver Pop Select (SSF_SWVR_PS app engine)
QA_CS_SR_PS_TRAN_BY_PROGRAM	Query for Population Selection testing	Process Transcripts (SSR_TSRPT Oracle BI Publisher)
SSR_CREATE_ACADPROJ	Create Student Academic Project records	Create Project Records (SSR_BAT_PRJ app engine)
SSR_MLSTN_PROGPLAN	Process Milestones query by plan	Process Milestones (SSR_MLSTN_PR app engine)
SSR_MLSTN_PROGRAM	Process Milestones query by program	Process Milestones (SSR_MLSTN_PR app engine)
SSR_PERC_ACTION_LETTERS	Population Selection and 3C Engine – SENR	3C Engine when the Administrative Function is SENR (3C app engine)
SSR_PERC_DROP_LETTERS	Population Selection and 3C Engine – SENR	3C Engine when the Administrative Function is SENR (3C app engine)
SSR_PERC_DROP_PG_LETTERS	Population Selection and 3C Engine – SENR	3C Engine when the Administrative Function is SENR (3C app engine)
SSR_PERC_DROP_WL_LETTERS	Population Selection and 3C Engine – SENR	3C Engine when the Administrative Function is SENR (3C app engine)
SSR_PERC_WARN_LETTERS	Population Selection and 3C Engine – SENR	3C Engine when the Administrative Function is SENR (3C app engine)
SSR_PERC_WARN_WL_LETTERS	Population Selection and 3C Engine – SENR	3C Engine when the Administrative Function is SENR (3C app engine)
SSR_REQS_ACAD_GRP	Post Enrollment Requirement query by Group	<p>Process Batch Post Enrollment Requirement Checking (SRRQPERC)</p> <p>Process Batch Drop Requests for Post Enrollment Requirements: Generate and Process Drops (SRRQDROP) or Generate Drop Transactions (SSR_REQS_DRP)</p> <p>Print Enrollment Requirement Rosters (SSR_REQS_RPT)</p> <p>Purge Post Enrollment Requirement Data (SSR_REQS_PRG)</p>

Query Name	Description	Process
SSR_REQS_ACAD_ORG	Post Enrollment Requirement query by Org	Same as for SSR_REQS_ACAD_GRP
SSR_REQS_CAMPUS	Post Enrollment Requirement query by Campus	Same as for SSR_REQS_ACAD_GRP
SSR_REQS_CAREER	Post Enrollment Requirement query by Career	Same as for SSR_REQS_ACAD_GRP
SSR_REQS_SESSION	Post Enrollment Requirement query by Session	Same as for SSR_REQS_ACAD_GRP
SSR_REQS_SUBJECT	Post Enrollment Requirement query by Subject	Same as for SSR_REQS_ACAD_GRP
SSR_REQS_SUBJECT_CATNBR	Post Enrollment Requirement query by Subject Catalog Number	Same as for SSR_REQS_ACAD_GRP
SSR_REQS_TERM	Post Enrollment Requirement query by Term	Same as for SSR_REQS_ACAD_GRP
SSR_TS_ACADLEVEL	Transcript Query by Acad Level	Process Transcripts (SSR_TSRPT Oracle BI Publisher)
SSR_TS_ADVISOR	Transcript Query by Advisor	Process Transcripts (SSR_TSRPT Oracle BI Publisher)
SSR_TS_CAREER	Transcript Query by Career	Process Transcripts (SSR_TSRPT Oracle BI Publisher)
SSR_TS_PROGPLAN	Transcript Query by Prog Plan	Process Transcripts (SSR_TSRPT Oracle BI Publisher)
SSR_TS_PROGRAM	Transcript Query by Program	Process Transcripts (SSR_TSRPT Oracle BI Publisher)
SSR_TS_STUDENT_GRP	Transcript Query by Stdnt Grp	Process Transcripts (SSR_TSRPT Oracle BI Publisher)

Equations for Population Selection

This table lists the equations that, as of the date of this publication, the PeopleSoft system delivers for use by the Population Selection process and the processes where you can use them.

Equation Names	Descriptions	Process
ADADPSDELAPP	Population Selection AD Application Delete	Application Delete by Batch (SAD_APP_DEL app engine)
ADPDPSCARTRM	Population Selection AD Prospect Delete Career Term	Prospect Delete by Batch (SAD_PRS_DEL app engine)
CC3CPSADMA	Population Selection 3C Engine ADMA	3C Engine when Administrative Function is ADMA (3C ENGINE app engine)
CCEMPSCRTADM	Pop Sel EMS Create Appl Eval	Create and Maintain Evaluations (SCC_GE_MAINT app engine)
CCEMPSCRTHS	Pop Sel EMS Create Thesis Eval	Create and Maintain Evaluations (SCC_GE_MAINT app engine)
CCEMPSUPDDEL	Pop Sel EMS Update Delete	Create and Maintain Evaluations (SCC_GE_MAINT app engine)
CCPUPSRELINS	Population Selection Update Related Institution	Population Selection Update where record set to PERS_INST_REL (SCC_POP_UPD app engine)
CCPUPSRCRCAT	Population Selection Update AD Application Recruiter Category	Population Selection Update where record set to ADM_APPL_RCR_CA (SCC_POP_UPD app engine)
CCPUPSSTAID	Population Selection Update Student Aid Attribute EmplID Range	Population Selection Update where record set to STDNT_AID_ATRBT (SCC_POP_UPD app engine)
CCSGPSE RANGE	Student Groups EmplID Range	Process Student Groups (SCC_STD_GRP app engine)
CCSIP SMAORG	Population Selection Service Indicators Org	Mass Assign Org Service Indicator (SCC_ORG_ASSN app engine)
CCSIP SMAPER2	Population Selection Service Indicators Assign Person2	Mass Assign Service Indicator (SCC_SI_ASSN app engine)
CCSIP SMAPERS	Population Selection Service Indicators Assign Person2	Mass Assign Service Indicator (SCC_SI_ASSN app engine)
CCSIP SMRPERS	Population Selection SI Mass Release Person	Mass Release Service Indicator (SCC_SI_RELS app engine)

Equation Names	Descriptions	Process
CCSIPSMRORG	Population Selection SI Mass Release Org	Mass Assign Org Service Indicator (SCC_ORG_ASSN app engine)
CCSIPSORG1	SI Population Selection Demo Org	Mass Assign Org Service Indicator (SCC_ORG_ASSN app engine)
CCUSPSUID	Population Selection User Security Update	Mass User Security Replacement (SCC_SCRT_UPD app engine)
CRINPSDEMO01	Population Selection CR Initiative Demo 1	Audience Criteria
ESTRPSBYPROG	Population Selection Transcripts By Program	Process Transcripts (SSR_TSRPT Oracle BI Publisher)
ESRRPSADV1	Population Selection AA Report Request	Generate Report Requests (SAA_RPT_RQST app engine)
FAAYPSERANGE	Population Selection FA AY Act EmplID Range	Aid Year Activate (SFA_ACTADYR app engine)
FAMPPSCHAR1E	Mass Pkg Choose Char1 = E	Mass Packaging Select (SFA_BPKGSEL app engine)
FAMPPSINST	Check if INST Exists	Mass Packaging Select (SFA_BPKGSEL app engine)
FAMPPSISIR	Select those with ISIRs	Mass Packaging Select (SFA_BPKGSEL app engine)
FAMPPSREADY	Grads and Ugrads Ready to Pkg	Mass Packaging Select (SFA_BPKGSEL app engine)
FARPPSCHAR2E	Grads and Ugrads Ready to Package	Select Students for Repackaging (SFA_RPKGSEL app engine)
FASPPSGPAG24	Grads and Ugrads Ready to Package	Process SAP (SFA_SAP_BDRV app engine)
SFDGROUPLINE	Population Selection for Group Post transactions	Pop Select for Group Line (SSF_GRP_POP app engine)
SFPPSPPL	Population Selection for specific Account Number	Mass Contract Select (SSF_PS_TPC app engine)

<i>Equation Names</i>	<i>Descriptions</i>	<i>Process</i>
SFPPSPPLTPC	Population Selection for Range of EmplIDs	Mass Contract Select (SSF_PS_TPC app engine)
SRPSSACADPROJ	Population Selection create student academic project records	Create Project Records (SSR_BAT_PRJ app engine)

